

# Disks and Tapes

## Configuration Information

ESCALA



REFERENCE  
86 A1 88GX 16



# ESCALA

## Disks and Tapes

### Configuration Information

#### **Hardware**

October 2001

BULL CEDOC

357 AVENUE PATTON

B.P.20845

49008 ANGERS CEDEX 01

FRANCE

REFERENCE

86 A1 88GX 16

The following copyright notice protects this book under Copyright laws which prohibit such actions as, but not limited to, copying, distributing, modifying, and making derivative works.

Copyright © Bull SAS 1992, 2001

Printed in France

Suggestions and criticisms concerning the form, content, and presentation of this book are invited. A form is provided at the end of this book for this purpose.

To order additional copies of this book or other Bull Technical Publications, you are invited to use the Ordering Form also provided at the end of this book.

### **Trademarks and Acknowledgements**

We acknowledge the right of proprietors of trademarks mentioned in this book.

AIX® is a registered trademark of International Business Machines Corporation, and is being used under licence.

UNIX® is a registered trademark in the United States of America and other countries licensed exclusively through the Open Group.

Linux® is the registered trademark of Linus Torvalds in the U.S. and other countries

---

# About This Book

This book applies to disk and tape peripherals that use the Small Computer System Interface (SCSI). It gives the jumper and switch settings to configure these peripherals on computers using the AIX version of the UNIX operating system.

## Who Should Use this Book

This book is dedicated to UNIX customers who have ordered a peripheral separately or as an add-on and then must configure it to run with their system.

## How to Use this Book

This book gives the jumper and switch settings and other information needed to set up disk drives to run on your system. Before using the information in this book, check the installation documentation for your system. On some systems jumper and switch settings are handled by the system without manual intervention.

The procedures to physically install the peripheral in the machine are described in the installation documentation delivered with the system.

## Overview of Contents

This book contains the following chapters:

- **Chapter 1, Overview and General Instructions**
- **Chapter 2, Diskette Drives**
- **Chapter 3, CD-ROM Drives**
- **Chapter 4, Hard Disk Drives**
- **Chapter 5, Tape Drives**
- **Glossary**

## Related Information

These manuals will help you to install the drives in these UNIX machines:

- *ESCALA M Series Installation and Service Guide* – 86 A1 25PN
- *ESCALA D Series Installation and Service Guide* – 86 A1 93PE
- *ESCALA R Series CPU Enclosure Installation and Service Guide* – 86 A1 33AQ
- *ESCALA E Series Upgrading the System* – 86 A1 87PN
- *ESCALA E230 Series Setup Guide* – 86 A1 51PX
- *ESCALA E250 Series Setup Guide* – 86 A1 52PX
- *ESCALA S Series System User's Guide* – 86 A1 89JX
- *ESCALA T Series Upgrading the System* – 86 A1 56PN
- *ESCALA T430 & T450 Series Setup Guide* – 86 A1 45PX
- *CPU Drawer Service Guide* – 86 A1 21PX
- *ESCALA EPC400 Series Using the System* – 86 A1 19PX
- *ESCALA EPC430 & EPC450 Series Setup Guide* – 86 A1 42PX
- *ESCALA EPC440 Series Installation & Service Guide* – 86 A7 84KX
- *ESCALA RL470 & EPC1200 Series Installation & Service Guide* – 86 A1 14HX

- *ESCALA EPC2400 Series Installation & Service Guide – 86 A1 19 KX*
- *AIX 4.3 System Management Guide: Operating System and Devices – 86 A2 99HX*

---

# Table of Contents

<b>About This Book</b> .....	<b>iii</b>
<b>Chapter 1. Overview and General Instructions</b> .....	<b>1-1</b>
Introduction .....	1-1
General Instructions .....	1-1
General SCSI Considerations .....	1-3
Disk Drive Identification Table .....	1-5
CD-ROM Drive Identification Table .....	1-6
Tape Drive Identification Table .....	1-7
<b>Chapter 2. 3.5 Inch Diskette Drives</b> .....	<b>2-1</b>
Introduction .....	2-1
Installing a 3.5 Inch Diskette Drive .....	2-1
Drive Configuration .....	2-1
1.44MB Diskette Drive (YD-702D) .....	2-2
1.44MB Diskette Drive (MPF 920-E) .....	2-3
<b>Chapter 3. CD-ROM Drives</b> .....	<b>3-1</b>
Introduction .....	3-1
Installing a CD-ROM Drive .....	3-1
Emergency Eject Hole .....	3-1
Drive Configuration .....	3-1
600MB Quad Speed (4X) CD-ROM SE (XM-5401B) .....	3-2
600MB Twelve Speed (12X) CD-ROM Drive (XM-5701B) .....	3-3
600MB 14X - 32X Speed CD-ROM Drive (XM6201B) and 600MB 17X - 40X Speed CD-ROM Drive (XM6401B) .....	3-4
600MB 40X/10X CD/DVD-ROM Drive (SD-M1401) .....	3-5
<b>Chapter 4. Hard Disk Drives</b> .....	<b>4-1</b>
Introduction .....	4-1
1GB and 2GB SCSI-2 Disk Drives (ST 31051N and ST 32151N) .....	4-2
1GB (ST 31051WC) and 2.1GB (ST 32151WC) SCSI-2 Disk Drives .....	4-3
2.1GB SCSI-2 Disk Drive (ST 32550N) .....	4-4
2.1GB SCSI-2 Disk Drive (ST 32171W and ST 32272W) .....	4-5
2.1GB SCSI-2 Disk Drive (ST 32171WC and ST 32272WC) .....	4-6
4.2GB SCSI-2 Disk Drive (ST 34371W, ST 34572W and ST 34573W) .....	4-7
4.2GB SCSI-2 Disk Drive (ST 34371WC, ST 34572WC and ST 34573WC) .....	4-8
9.1GB SCSI-2 Disk Drive (ST 39173W) .....	4-9
9.1GB SCSI-2/3 Disk Drive (ST 39175LW, ST 39236LW) .....	4-10
9.1GB SCSI-2 Disk Drive (ST 39173WC) .....	4-11
9.1GB SCSI-2/3 Disk Drive (ST 39175LC, ST 39236LC) .....	4-12
18.2GB SCSI-2/3 Disk Drive (ST 318275LC, ST 318436LC) .....	4-13
9.1GB SCSI-3 LVD Disk Drive (ST 39103LC, ST 39204LC) .....	4-14
18.2GB SCSI-3 LVD Disk Drive (ST 318203LC, ST 318404LC, ST 318406LC) ..	4-15
4.3GB SCSI-2 Disk Drive (ST 15230N) .....	4-16
4.3GB SCSI-2 Disk Drive (ST 15150W) .....	4-17
4.3GB SCSI-2 Disk Drive (ST 15150N) .....	4-18
9.1GB SCSI-2 Disk Drive (ST 19171W) .....	4-19
9.1GB SCSI-2 Disk Drive (ST 19171WC) .....	4-20

<b>Chapter 5. Tape Drives</b> .....	<b>5-1</b>
Introduction .....	5-1
4/8GB 4mm Internal Tape Drive (CTD 8000R) .....	5-2
4/8GB 4mm Internal Tape Drive (HP C1533A or HP C1539A) .....	5-3
12/24 GB 4mm Internal Tape Drive DDS3 (HP C1537A) .....	5-5
20/40 GB 4mm Internal Tape Drive DDS4 (HP C5683A) .....	5-7
7/14GB 8mm Internal Tape Drive (EXB 8505XL) .....	5-9
7/14GB 8mm Internal Tape Drive (EXB 8705) .....	5-11
2.5/5GB 1/4 Inch Internal Tape Drive (TDC 4222) .....	5-13
13/26GB 1/4 Inch Internal Tape Drive or 16/32GB 1/4 Inch Internal Tape Drive (MLR1) .....	5-15
25/50GB 1/4 Inch Internal Tape Drive (MLR3) .....	5-19
<b>Appendix A. Media and Tape Drive Compatibility</b> .....	<b>A-1</b>
DAT 4mm Media Compatibility .....	A-2
VDAT 8mm Media Compatibility .....	A-5
QIC Media Compatibility .....	A-8
DLT Media Compatibility .....	A-13
<b>Glossary</b> .....	<b>G-1</b>
<b>Index</b> .....	<b>X-1</b>



---

# Chapter 1. Overview and General Instructions

---

## Introduction

This manual groups configuration information for the four types of peripheral devices:

- Diskette (floppy) Drives
- CD-ROM Drives
- Hard Disk Drives
- Tape Drives

You need the information in this manual when you order a drive separately or when you upgrade your system with a new drive.

This information has been separated from the installation and configuration instructions for specific machines because of the continuing, rapid evolution of these peripherals.

General information on configuration and SCSI ID address settings is presented below.

The procedures to install the peripheral in the machine are described in the installation documentation delivered with each system.

This chapter identifies the peripheral drives and shows you where they are used on the different UNIX computers.

There are tables showing drives and the pertinent information for each one.

---

## General Instructions

Use ESD

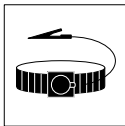

Wrist Strap

If you touch static-sensitive parts of the drive, such as a printed circuit board and discharge static electricity, the components might be damaged. Observe static precautions. Use an antistatic wrist strap when installing disk drives.

## Unpacking and Inspection

Although the drives are inspected and carefully packaged at the factory, damage may occur during shipping. Follow these steps for unpacking the drive.

1. Visually inspect the shipping container; notify your carrier of any damage immediately.
2. Place shipping containers on a flat, clean, stable surface; then, carefully remove and verify the contents against the packing list. If parts are missing or the equipment is damaged, notify your sales representative.
3. Save the containers and packing materials for any future re-shipment.

## Installation

To install the drive, perform the following steps:

1. Configure your drive by setting the drive jumpers as shown in the following pages, if this is necessary.
2. Install the drive into your system (refer to your system documentation).
3. Configure the drive into your system.



### Caution

When you disconnect cables, do not allow them to touch the motherboard.

## SCSI ID

The **SCSI ID number, or address**, identifies the order of the device on the SCSI bus seen by the controller (the location of the device on the SCSI bus).

The SCSI ID is unique for each device.

The SCSI ID is set using switches or jumpers, or determined by the software and the physical positioning of the drive in the computer.

When jumpers are used there is a table specifying the jumper positions for each address:

**off** means the jumper is not in place  
**on** means the jumper is in place

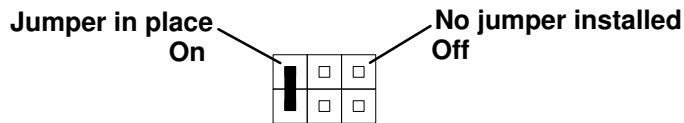

Other jumpers or switches can be present on the device. Do not remove these jumpers or change the switch settings.

---

## General SCSI Considerations

The following sections give general SCSI considerations for the SCSI devices.

OEM SCSI-1 or SCSI-2 single-ended, SCSI-2 differential and SCSI-3 LVD/SE devices may carry one of the following ANSI icons:

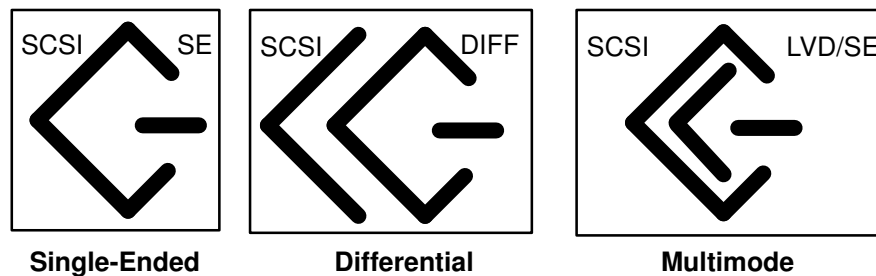

### CAUTION:

There must be two and only two terminators on the SCSI bus, and they must be located at each extreme physical end of the bus.

## SCSI Bus Length General Guidelines

SCSI bus length is defined as the distance between terminators at either end of a SCSI bus.

- For configurations using both internal and external cabling, length restrictions refer to the length from the end of the internal cable (terminator) to the terminator on the last device on the external bus.
- Devices which have two SCSI connectors have internal cabling which must be included when calculating total cable length. When connecting these devices, connect one cable into one connector and the other cable (or terminator, if this is the last device on the bus) to the second connector. Do not “piggy back” the second cable/terminator onto the first as you would on a device with only one connector.

## SCSI Device Addresses or IDs

The SCSI-1 and SCSI-2 single-ended controllers support a maximum of eight SCSI addresses.

- For any single-controller configuration, a maximum of seven additional devices are permitted, providing that the supported configuration specific bus lengths are not exceeded. Other restrictions such as bus length may further limit the number of allowable devices.
- For two-controller configurations (high-availability), up to six devices are permitted, providing that the supported configuration specific bus lengths are not exceeded. Other restrictions such as bus length may further limit the number of allowable devices.
- The SCSI bus address determines priority on the bus. Address priority from the highest to the lowest is as follows:
  - 7, ..0, 15,...8 (address 15 to 8 are only used on SCSI-2 wide buses). Address 7, the highest priority, must always be assigned to the controller. In general, assign the fastest devices the lowest priority. Disk drives should be assigned IDs in the range of 0 to 3; CD-ROMs in the range of 3 to 4, and tapes in the range of 4 to 6 (addresses 15 to 8 can also be used on SCSI-2 wide buses as additional lower-priority addresses)
- The default ID of the SCSI controller in a single controller configuration is 7. All devices on that bus must have a unique ID from 0 to 6 (8 to 15 are also valid if it is SCSI-wide); two different devices **must not** have the same SCSI ID. In the high-availability configurations, the second controller must have its address changed to avoid conflicts.

**Note:** The SCSI address switch or jumpers for each device must be set while power to the system unit is off. The operating system determines the system configuration during

IPL. If a SCSI address is changed after the operating system is loaded, the operating system must be stopped and loaded again to have the correct configuration.

Standalone diagnostics will always default to a SCSI ID of 7 when testing SCSI controllers and devices. Choosing SCSI IDs other than 7 for both controllers will prevent any problems when using standalone diagnostics on systems in HA clusters.

To determine what SCSI addresses are available you must know what SCSI addresses are already in use. The following describe several ways to do this:

- If the system is operational and AIX is loaded and configured, use the **lsdev -C -s scsi** (where the l in lsdev is a lowercase L) command to list all of the devices in the Customized Devices Object Class. The list shows name, status, location (the software location code), and the description.

## Overload Protection and Terminator Power (Term Power)

The SCSI controllers provide term power for the SCSI bus; connect devices to the bus so they do not provide term power. The controller uses either a fuse that must be replaced after failure, or a Positive Temperature Coefficient (PTC) resistor that resets within five minutes after the overload cause is removed. SCSI-2 controllers all use a PTC resistor.

- Do not connect or disconnect any SCSI device while power is on (unless the device is hot unpluggable specified). Such “hot plugging” is forbidden because this practice may blow the controller fuse, trip the PTC resistor, corrupt data or permanently damage SCSI controller chips in controllers or devices.
- The fuse or PTC on a SCSI controller protects the external and internal SCSI bus. The fuse may be blown or the PTC tripped by a defective cable, terminator, or device attached to the controller.

## Controller Access Time

Consider the following to keep controller access time within reasonable limits:

- Have the disk being backed up and the backup device on separate controllers.
- Attach four or fewer disk drives to the same SCSI-1 controller and six or fewer disk drives to a SCSI-2 controller.
- If possible have the high-usage disk drives (such as operating system drives) on the same controller with low-usage devices to improve access time.

## Disk Drive Identification Table

Drive Description	Manufacturer's ID Number	UNIX System	Special Considerations
1.44MB Diskette Drive (3.5 inch)	YD-702D	Escala D, M and R Series	Normally installed at the factory on all machines.
	MPF 920-E	Escala E, EPC400 and T Series	
1GB SCSI-2 SE Disk Drive	ST 31051N	Estrella 200	Rotation: 5400rpm Height: 1 inch
	ST 31051WC	Estrella 300, 700 (nStor Cab)	
2.1GB SCSI-2 SE Disk Drive	ST 32151N	Estrella 200	Rotation: 5400rpm Height: 1 inch
	ST 32151WC	Estrella 300, 700 (nStor Cab)	
	ST 32550N	Escala M and D Series	Rotation: 7200rpm Height: 1 inch
	ST 32171W ST 32272W	Escala M Series Estrella 300, 700	
	ST 32171WC	Escala E, EPC400 and T Series Estrella 300, 700 (nStor Cab)	
	ST 32272WC	Escala E, EPC400 and T Series	
4.2GB SCSI-2 SE Disk Drive	ST 34371W ST 34572W	Escala M, D and R Series Estrella 300, 700	Rotation: 7200rpm Height: 1 inch
	ST 34573W	Escala D, M, R and S Series	
	ST 34371WC ST 34572WC	Escala E, EPC400 and T Series Estrella 300 (nStor Cab)	
	ST 34573WC	Escala E, EPC400 and T Series	
9.1GB SCSI-2 SE Disk Drive	ST 39173W ST 39175LW ST 39236LW	Escala D, M, R, and S Series	Rotation: 7200rpm Height: 1 inch
	ST 39173WC ST 39175LC ST 39236LC	Escala E, EPC400 and T Series	
18.2GB SCSI-2/3 SE Disk Drive	ST 318275LC ST 318436LC	Escala E, EPC400 and T Series	Rotation: 7200rpm Height: 1 inch
9.1GB SCSI-3 LVD Disk Drive	ST 39103LC ST 39204LC	E230, E250, EPC 430, EPC 450, T430 & T450	Rotation: 10Krpm Height: 1 inch
18.2GB SCSI-3 LVD Disk Drive	ST 318203LC ST 318404LC ST 318406LC	E230, E250, EPC 430, EPC 450, T430 & T450	Rotation: 10Krpm Height: 1 inch
4.3GB SCSI-2 SE Disk Drive	ST 15230N	Estrella 200	Rotation: 5400rpm Height: 1.6 inches
	ST 15150W	Estrella 300, 700 Escala M Series	Rotation: 7200rpm Height: 1.6 inches
	ST 15150N	Escala D and R Series	
9.1GB SCSI-2 SE Disk Drive	ST 19171W	Escala M, D and R Series Estrella 300, 700	Rotation: 7200rpm Height: 1.6 inches
	ST 19171WC	Escala E, EPC 400 and T Series	

<b>Legend:</b>	
C	Single Connector Attachment, with SCSI address, power and electronic connections all contained in a single connector
GB	Gigabyte (1,000,000,000 bytes)
MB	Megabyte (1,000,000 bytes)
MPF	Sony designation
N	Narrow operation, 8 bits
SE	Single Ended elec. transmission on bus; signal & mass
ST	Seagate designation
W	Wide operation, 16 bits
WC	Single connector attachment designation
YD	YE Data designation

## CD-ROM Drive Identification Table

Drive Description	Manufacturer's ID Number on Unit	UNIX System	Special Considerations
600MB Quad Speed (4x) CD-ROM Drive	XM 5401B	Estrella 200 Escala D, M and R Series	Normally installed at the factory on all machines.
600MB Twelve Speed (12x) CD-ROM Drive	XM 5701B	Escala D, E, EPC400, M, R and T Series	Normally installed at the factory on all machines.
600MB 14/32x Speed CD-ROM Drive	XM 6201B	Escala D, E, EPC400, M, R and T Series	Normally installed at the factory on all machines.
600MB 17/40x Speed CD-ROM Drive	XM 6401B	Escala D, E, EPC400, M, R and T Series	Normally installed at the factory on all machines.
600MB 40x/10x CD/DVD-ROM Drive	SD M1402	Escala E, T, E230, E250, T430, T450, EPC400, EPC430, EPC450	Normally installed at the factory on all machines.

## Tape Drive Identification Table

Description	Manufacturer's ID Number Located on the Unit	UNIX System
4/8GB 4mm Internal Tape Drive	CTD 8000R	Escala D, M and R Series
	HP C1533A or HP C1539A	Estrella and Escala S Series
12/24GB 4mm DDS3 Tape Drive	HP C1537A	Escala D, E, EPC400, M, R, S and T Series
20/40GB 4mm DDS4 Tape Drive	HP C5683A	E230, E250, EPC400, EPC430, EPC440, EPC450, EPC610, EPC 810, EPC1200A, EPC2400, T430, T450, T610, T, & E
7/14GB 8mm Internal Tape Drive	EXB-8505XL	Estrella Family Escala E, D, M, R and T Series
	EXB-8705	Estrella Family Escala E, EPC400, EPC440, EPC1200, D, M, R, S and T Series
2.5/5GB 1/4" Internal Tape Drive	TDC 4222	Estrella Family Escala D, M, R and S Series
13/26GB QIC 1/4" SE Tape Drive 16/32GB QIC 1/4" SE Tape Drive	MLR1	Escala E, EPC400 M, R, S and T Series
13/26GB QIC 1/4" DE Tape Drive 16/32GB QIC 1/4" DE Tape Drive	MLR1	Escala D Series
25/50GB QIC 1/4" SE Tape Drive	MLR3	Escala E, EPC400, EPC800, R, S120 and T Series

<b>Legend:</b>	
CTD	Cartridge Tape Drive
DDS3	Digital Data Storage
EXB	Exabyte
GB	Gigabyte (1,000,000,000 bytes)
HP	Hewlett Packard designation
MLR	Multi Channel Linear Recording
QIC	Quarter Inch Committee (a standard)
TDC	Tandberg Data designation
XL	Extra Length
SE	Single Ended
DE	Differential Ended
XM	Toshiba Designation





---

## Chapter 2. 3.5 Inch Diskette Drives

---

### Introduction

Normally all machines are fitted with a diskette (floppy) drive at the factory and there is no configuration or installation to perform.

However, it could happen that for some reason you must install a diskette drive. Configuration information is contained in this chapter.

---

### Installing a 3.5 Inch Diskette Drive

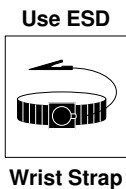

1. Perform an operating system shutdown.
2. Power off the system.
3. Remove the system cover and front bezel.
4. The floppy drive should be addressed as drive one. Check that the jumper is set on the correct pin.
5. Once you have set the address, refer to your system's installation documentation for the detailed installation instructions.

---

### Drive Configuration

Configuration consists of checking that the jumpers are installed as shown in the drawings on the following pages.

## 1.44MB Diskette Drive (YD-702D)

This is the rear of the YD-702D diskette drive showing the different connections and the Address Option Block.

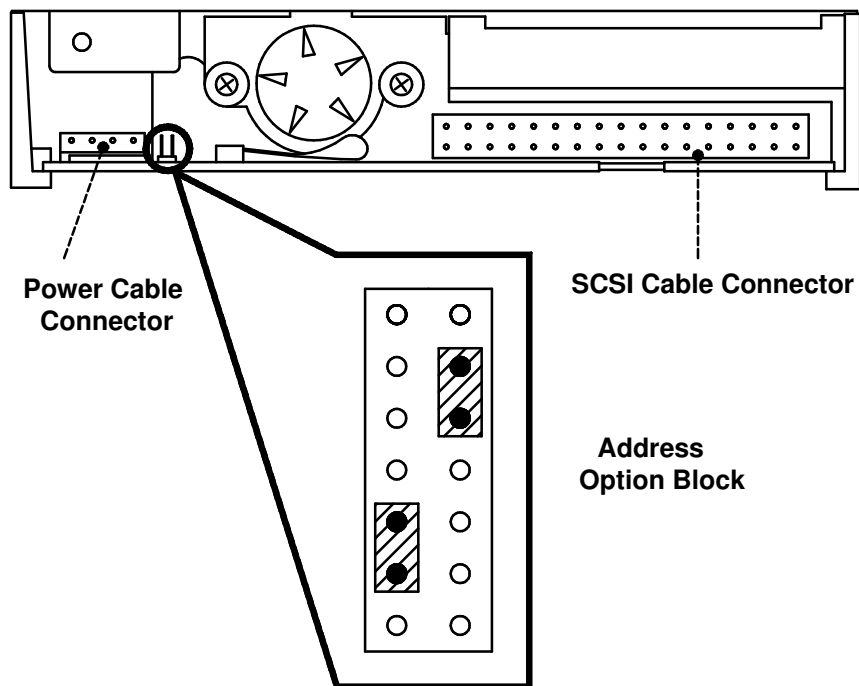

### Check the Address

The address is set by the two jumpers installed on the Address Option Block as shown above. Do not change it. This applies to former drive deliveries.

On newer deliveries, the Address Option Block no longer exists. In this case, the drive address is hard wired, i.e. built-in, and no jumpers are needed.

---

## 1.44MB Diskette Drive (MPF 920-E)

This is the rear of the MPF 920-E diskette drive showing the different connections and the Address Option Block.

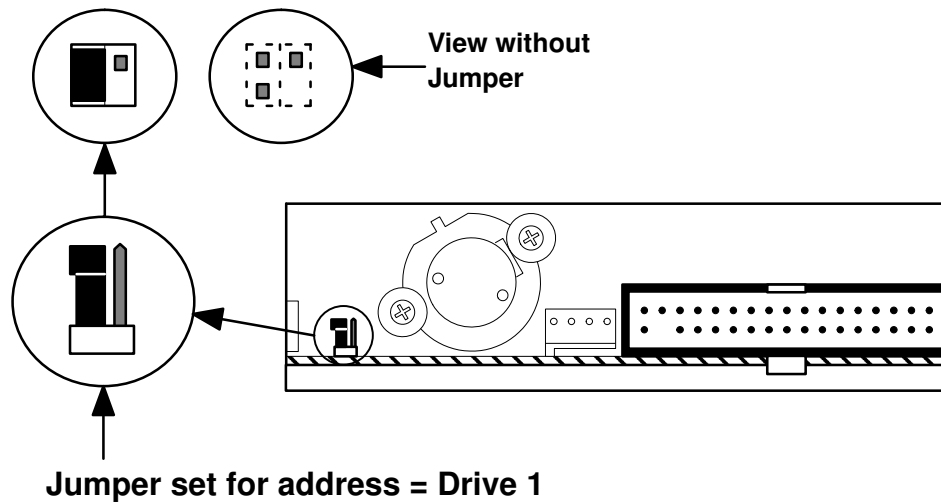

### Check the Address

One jumper is installed on the option block as shown above.  
Do not change the jumper setting.



---

## Chapter 3. CD-ROM Drives

---

### Introduction

Normally all machines are fitted with a CD-ROM drive at the factory and there is no configuration or installation to perform.

However, it could happen that you upgrade your system with a new drive. In this case, the information in this chapter is presented to assist you in configuring and installing the new CD-ROM drive.



CD-ROM drives contain a laser system and are classified as CLASS 1 LASER PRODUCTS. To use these drives properly, thoroughly read the documentation provided by the CD-ROM manufacturer and keep the documentation for future reference. In case of any trouble with a CD-ROM, please contact your nearest service representative. To prevent direct exposure to the laser beam, do not try to open the case.

Use of controls or adjustments or performance of procedures other than those specified in the CD-ROM manufacturer's documentation may result in hazardous radiation exposure.

---

### Installing a CD-ROM Drive

1. Determine the designated bay for your CD-ROM drive.
2. Before installing this CD-ROM drive, check that the parity jumper and the SCSI address jumpers are installed as shown on the following pages.
3. Refer to your operating system documentation for device driver installation instructions.

---

### Emergency Eject Hole

The Emergency Eject Hole operates in the same way for both CD-ROM drives.



Never insert metal of any type into any place on CD-ROM drive except in the Emergency Eject Hole.

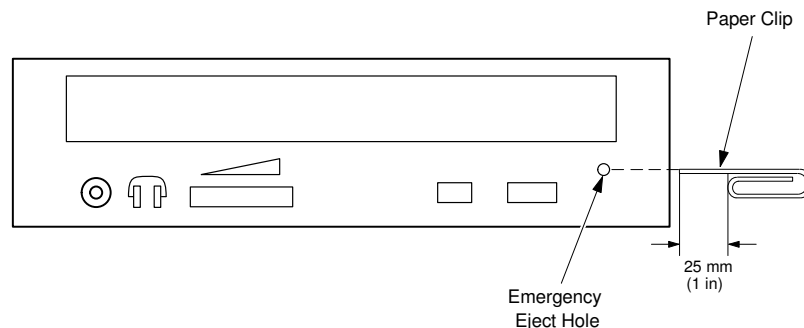

---

### Drive Configuration

Configuration consists of checking that the jumpers setting the SCSI address are as shown in the drawings on the following pages.

# 600MB Quad Speed (4X) CD-ROM SE (XM-5401B)

The address block is located on the left side of the SCSI connector at the back of the device.

A parity jumper is installed. Do not remove it or change its position.

No terminator is to be installed.

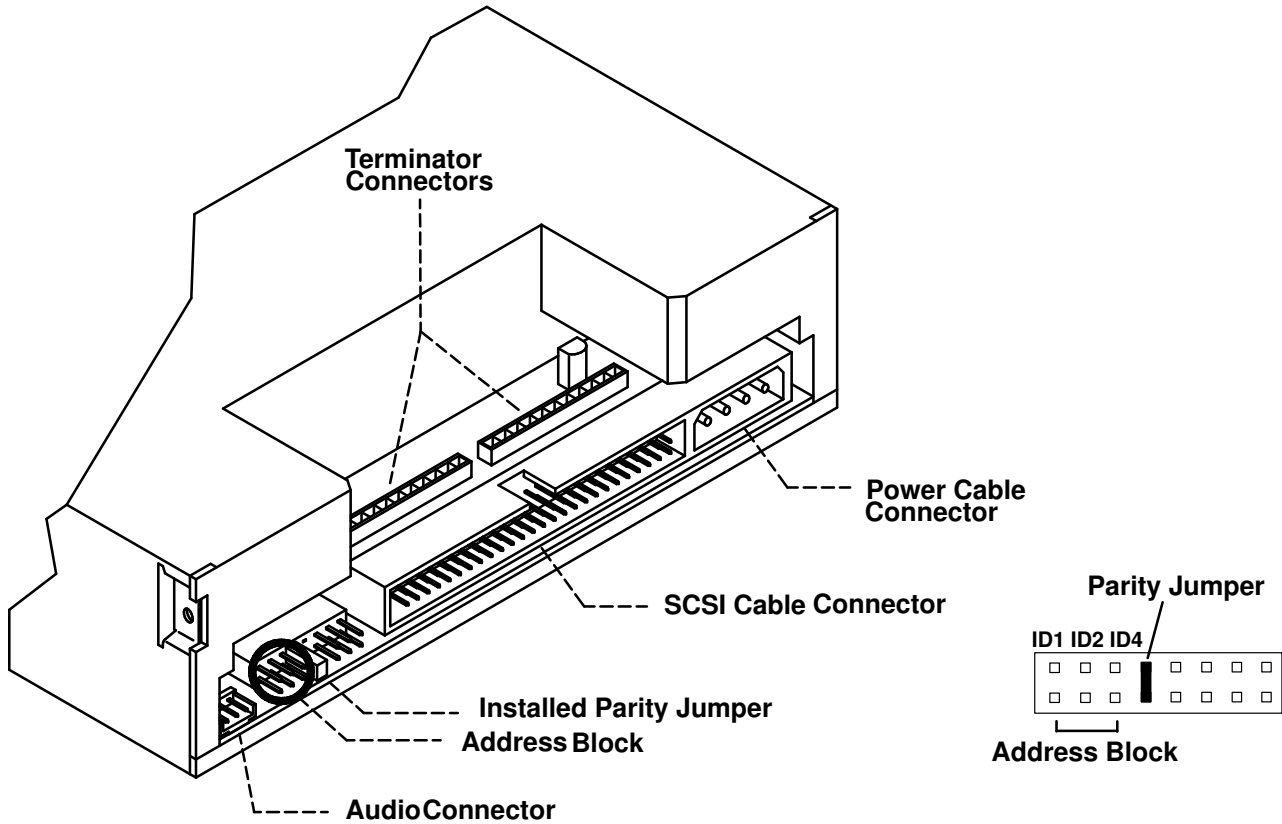

To set the SCSI ID (address), position the jumpers on the address block as shown below.

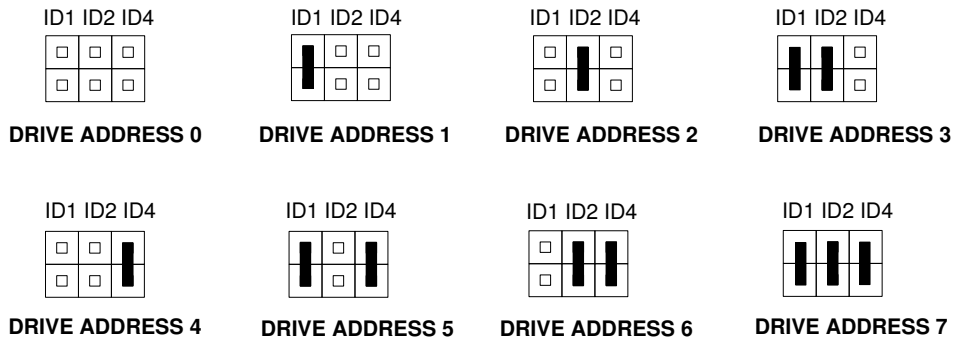

# 600MB Twelve Speed (12X) CD-ROM Drive (XM-5701B)

## Connections at the Rear of the Drive

The address block is located on the left side of the SCSI connector at the back of the device. The following illustration shows the rear panel of the CD-ROM drive.

The Parity Jumper is installed on the pair of pins just to the right of the SCSI address block.

Do not remove it or change its position.

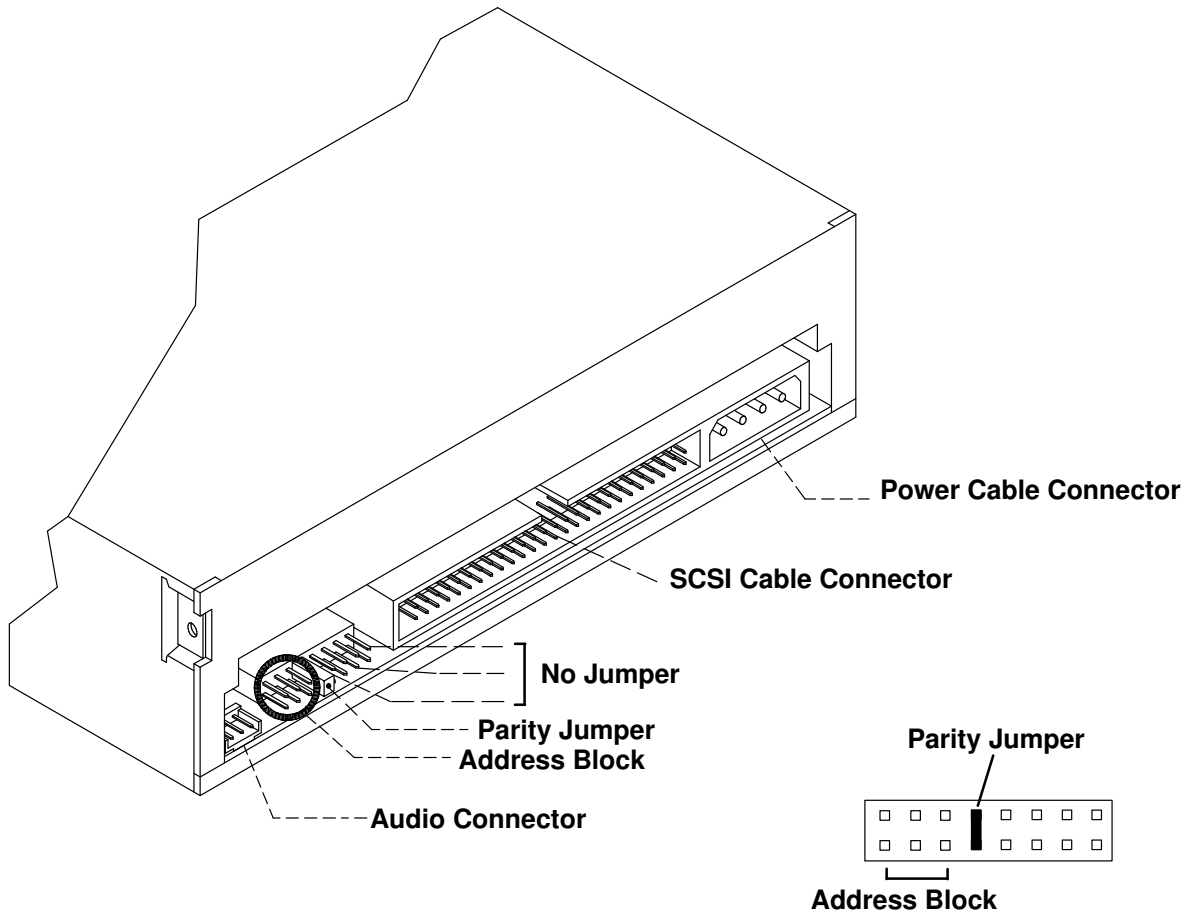

## SCSI ID Jumpers

The SCSI ID jumpers determine the SCSI address. They are set on the 3 pairs of pins which make up the address block, as indicated below. The ID number (Drive Address) you need is found in the configuration instructions for your system.

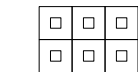

DRIVE ADDRESS 0

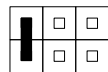

DRIVE ADDRESS 1

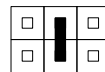

DRIVE ADDRESS 2

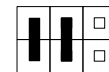

DRIVE ADDRESS 3

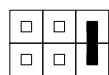

DRIVE ADDRESS 4

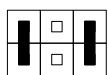

DRIVE ADDRESS 5

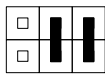

DRIVE ADDRESS 6

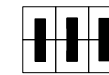

DRIVE ADDRESS 7

# 600MB 14X - 32X Speed CD-ROM Drive (XM6201B) and 600MB 17X - 40X Speed CD-ROM Drive (XM6401B)

## Connections at the Rear of the Drive

The address block is located on the left side of the SCSI connector at the back of the device. The following illustration shows the rear panel of the CD-ROM drive.

The Parity Jumper is installed on the pair of pins just to the right of the SCSI address block.

Do not remove it or change its position.

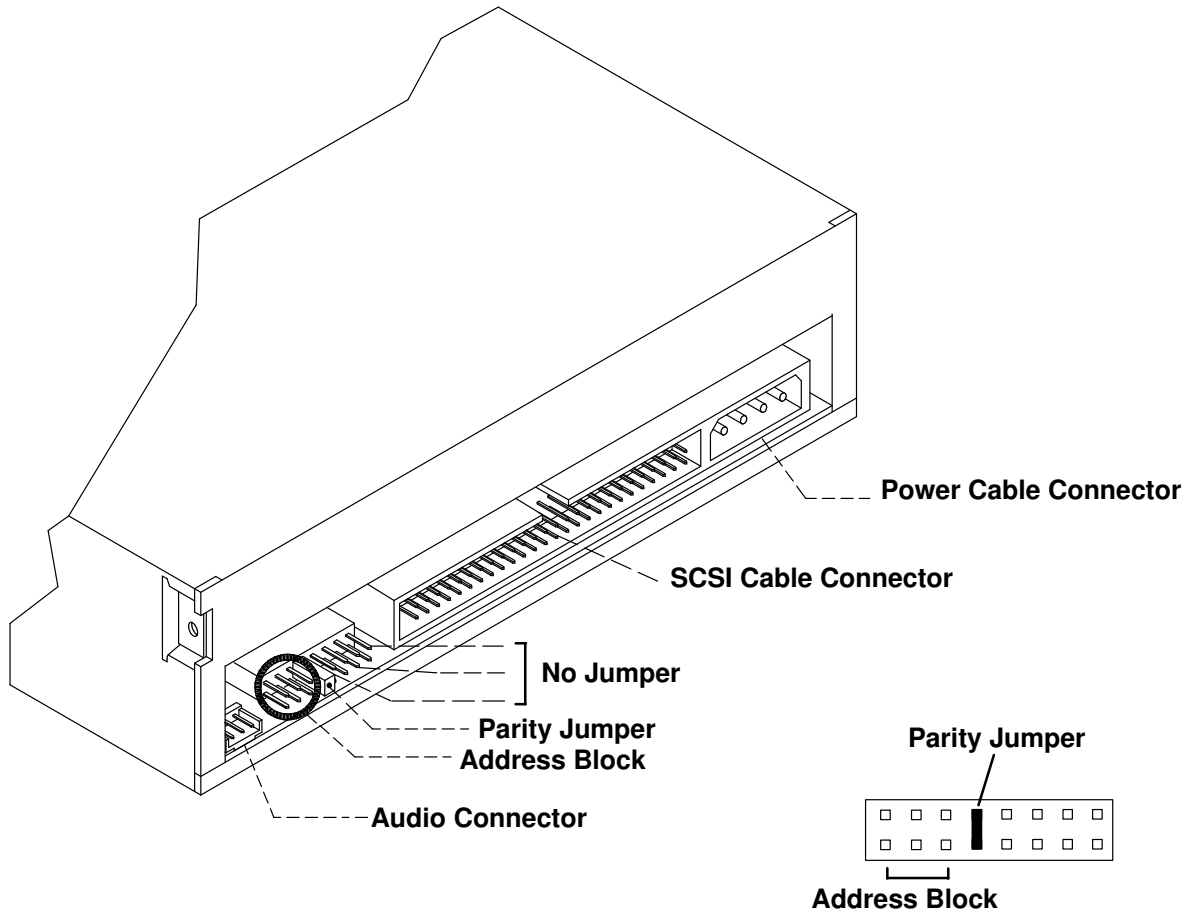

## SCSI ID Jumpers

The SCSI ID jumpers determine the SCSI address. They are set on the 3 pairs of pins which make up the address block, as indicated below. The ID number (Drive Address) you need is found in the configuration instructions for your system.

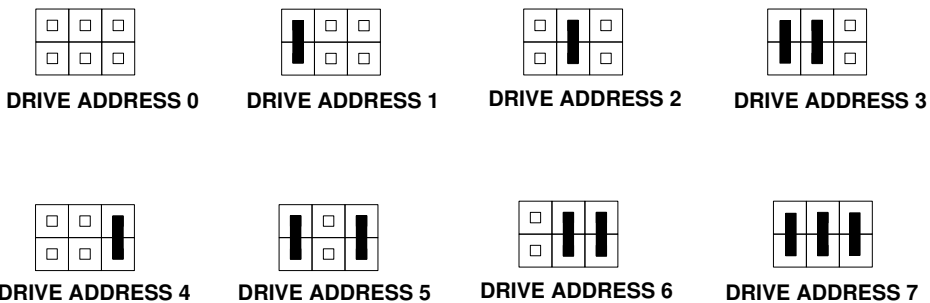



# 600MB 40X/10X CD/DVD-ROM Drive (SD-M1401)

## Connections at the Rear of the Drive

The address block is located on the left side of the SCSI connector at the back of the device. The following illustration shows the rear panel of the CD-ROM drive.

The Parity Jumper is installed on the pair of pins just to the right of the SCSI address block.

Do not remove it or change its position.

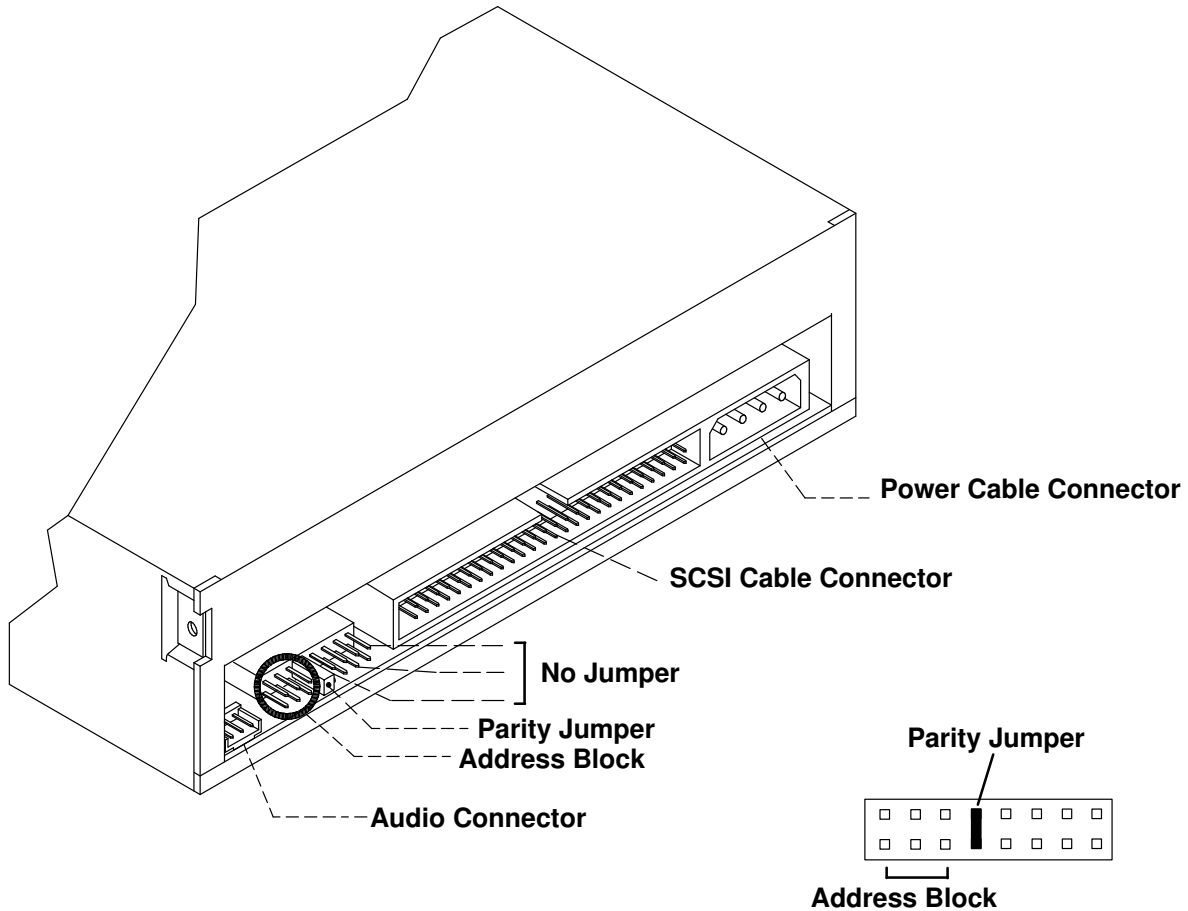

## SCSI ID Jumpers

The SCSI ID jumpers determine the SCSI address. They are set on the 3 pairs of pins which make up the address block, as indicated below. The ID number (Drive Address) you need is found in the configuration instructions for your system.

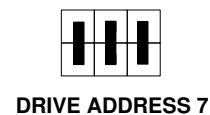
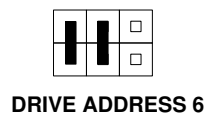
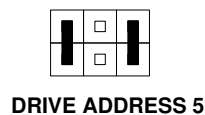
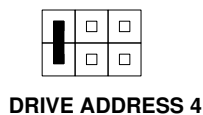
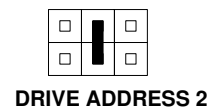
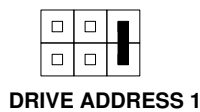
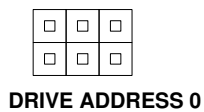



---

# Chapter 4. Hard Disk Drives

---

## Introduction

This chapter groups configuration information for hard disk drives. This information is needed for disk drives that have been ordered separately or for disk drives that have been ordered to upgrade your system.

This information has been separated from the installation and configuration instructions for specific machines because of the continuing, rapid evolution of these peripherals.

The pages that follow contain configuration information for the latest hard disk drives.

See the table in Chapter 1 for an overall view of the different disk drives.

The SCSI ID address settings and any other switches or settings that may be present, are indicated.

The procedures to install the peripheral in the machine are described in the installation documentation delivered with your system.

# 1GB and 2GB SCSI-2 Disk Drives (ST 31051N and ST 32151N)

This figure shows the bottom of the drive.

Connector J6 contains ten pairs of pins, four of which are covered. Do not remove this cover and do not install jumpers on the four positions under the cover. The first three sets of pins make up the Address Block.

Connector J5 is not used and should not contain any jumpers.

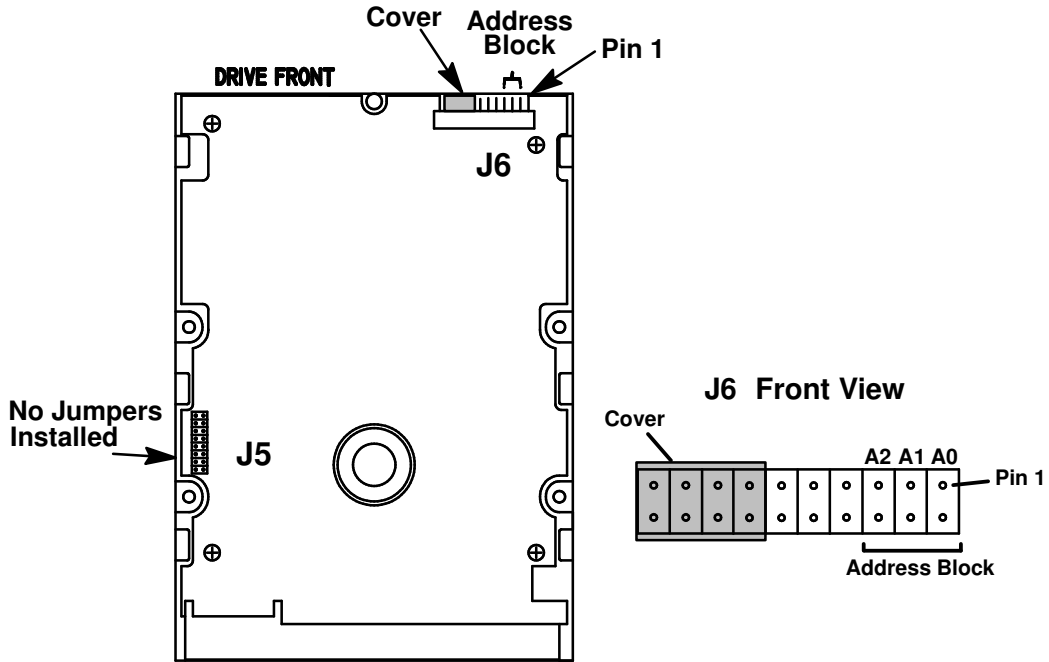

To set the SCSI ID (address), position the jumpers on the address block on J6 as shown below.

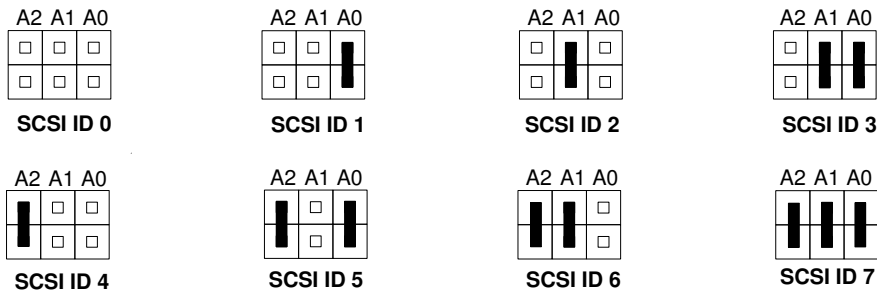

# 1GB (ST 31051WC) and 2.1GB (ST 32151WC) SCSI-2 Disk Drives

The SCSI address is determined by the bay in the cabinet where you insert the unit. There must be no jumper installed, either on J2 or J6.

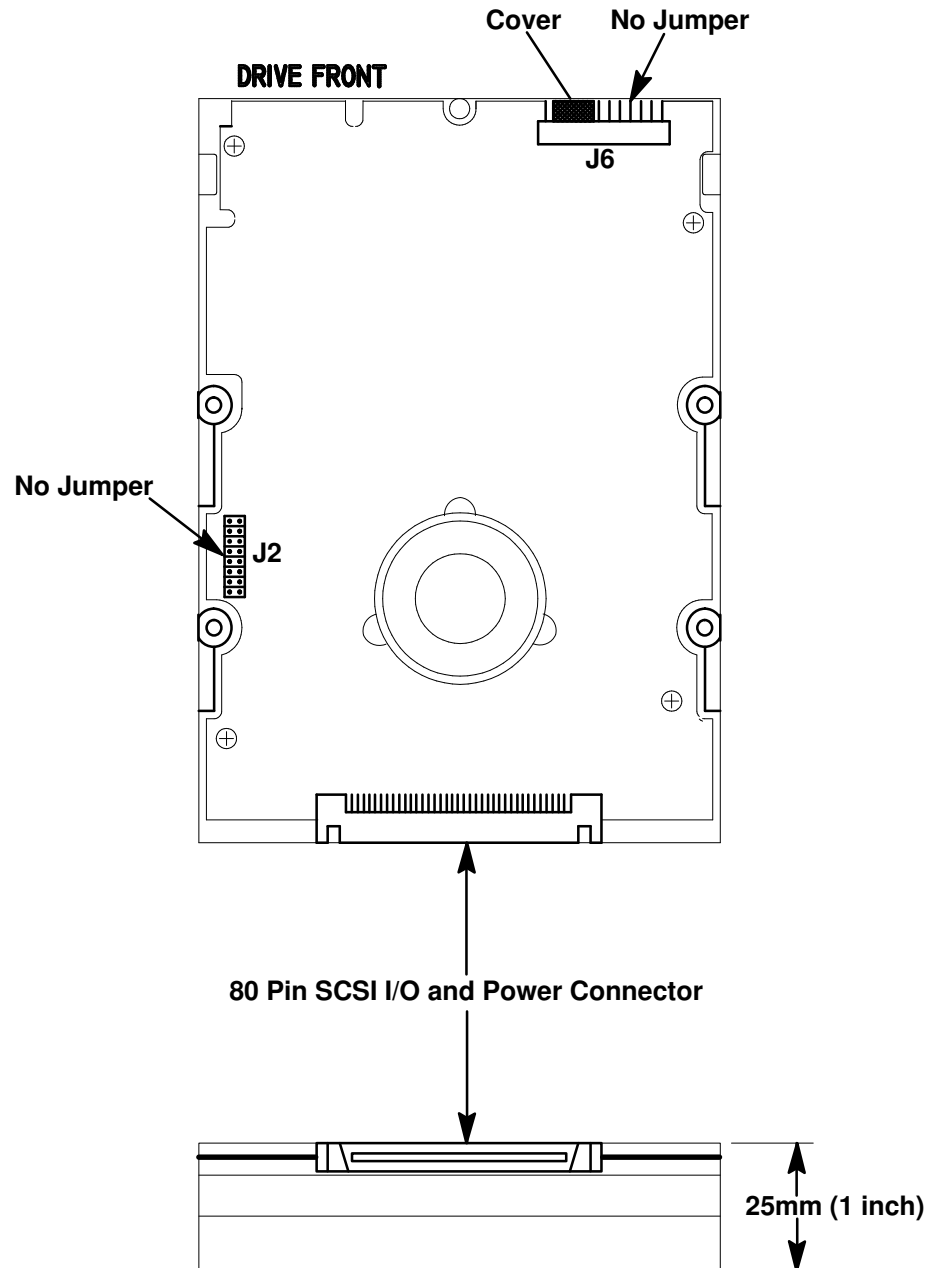

# 2.1GB SCSI-2 Disk Drive (ST 32550N)

The address block is opposite the SCSI connector on the left side at the front of the disk drive. Use block J4 to set the SCSI ID.

Do not remove the jumper installed on J2.

Do not install any jumpers on block J1.

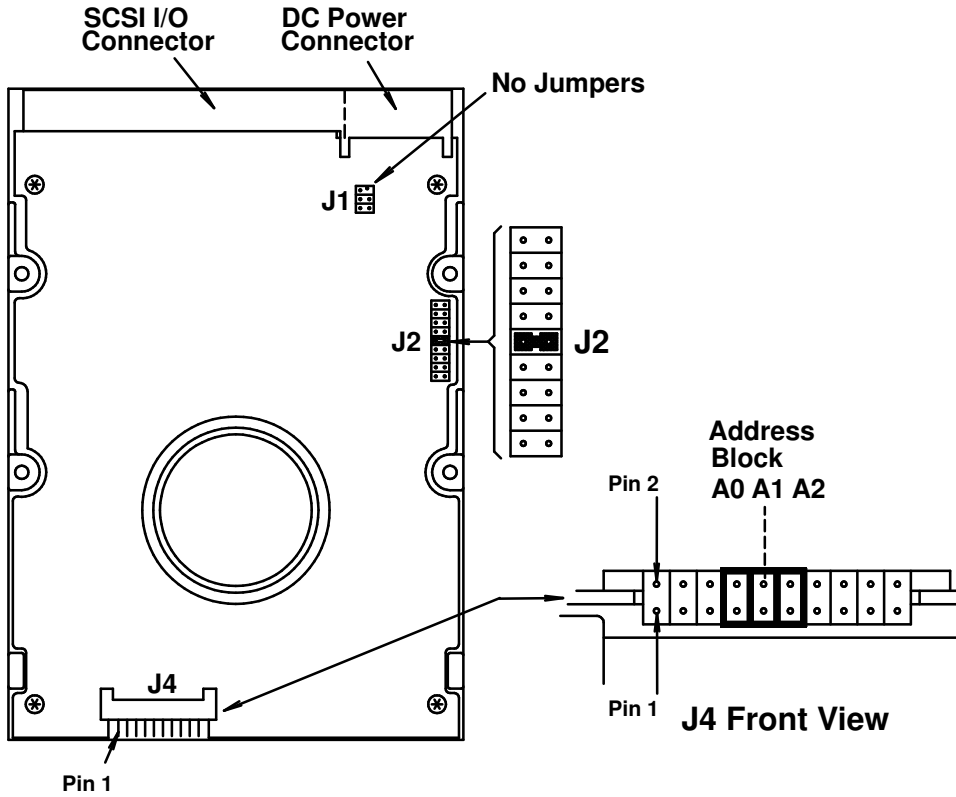

To set the SCSI ID (address), position the jumpers on the address block on J4 as shown below.

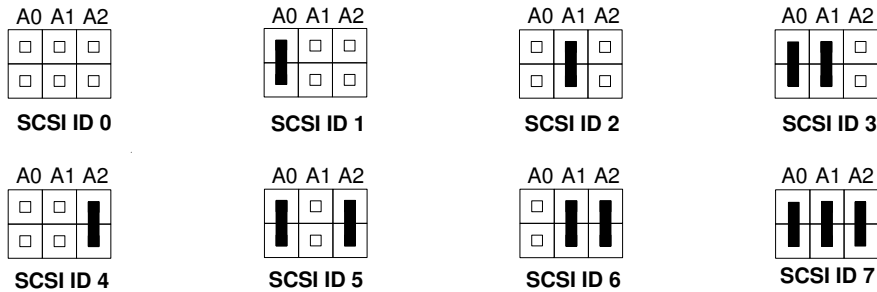

## 2.1GB SCSI-2 Disk Drive (ST 32171W and ST 32272W)

The address block for the SCSI connector is at the front of the drive positioned in J6. Four pairs of pins are covered; do not remove this cover or install jumpers on the pins under it.

Do not remove or change the position of the jumpers installed on J2.

Do not install any jumpers on J1A.

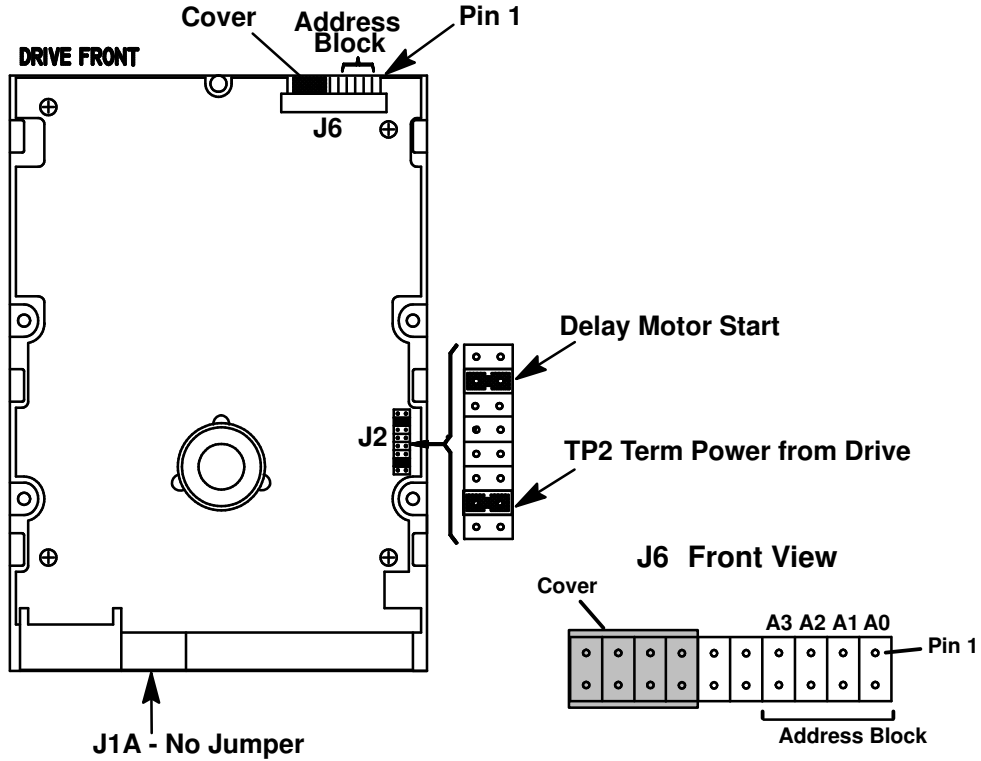

To set the SCSI ID (address), position the jumpers on the address block on J6 as shown below.

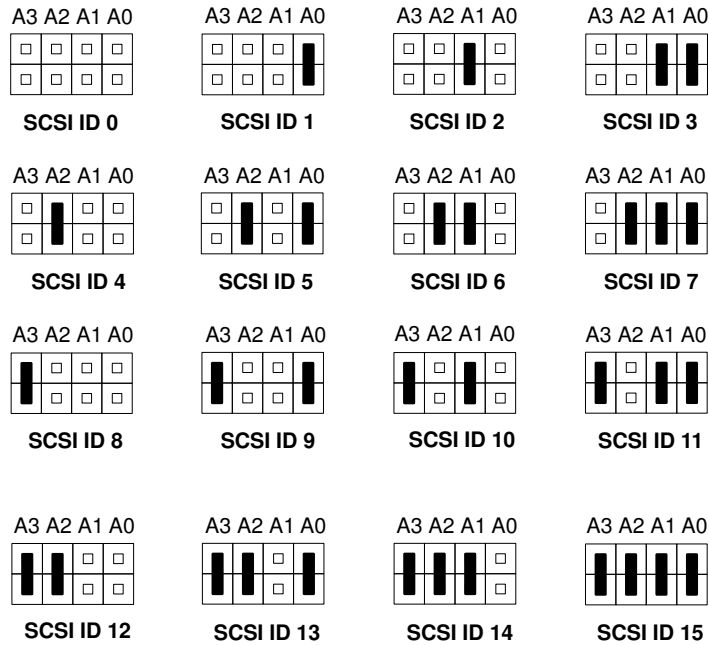

## 2.1GB SCSI-2 Disk Drive (ST 32171WC and ST 32272WC)

The SCSI address is determined by the position where you install the drive. The sequence in which the drives are installed has no effect on the address.

There must be no jumpers installed on J6.

Do not remove or change the position of the jumper installed on J2.

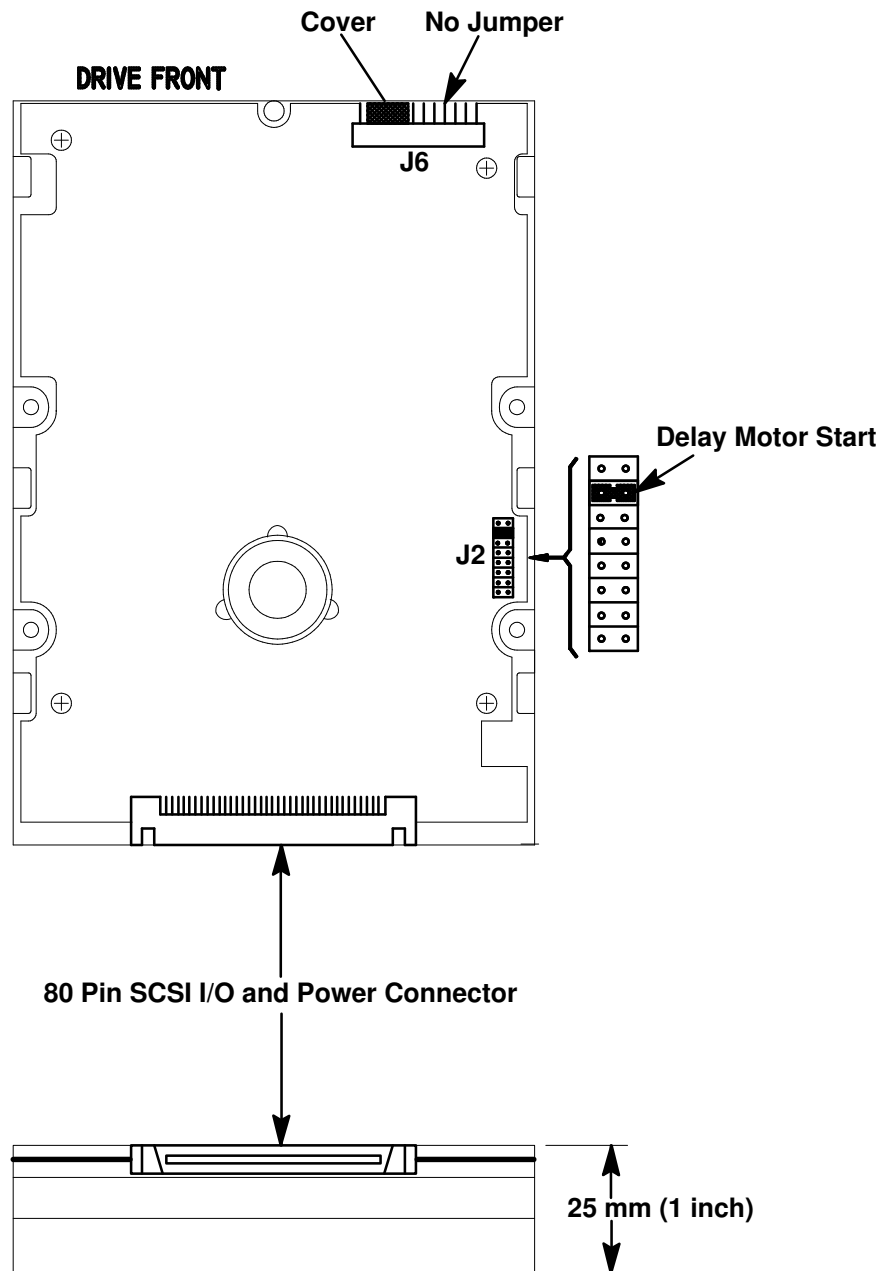



## 4.2GB SCSI-2 Disk Drive (ST 34371W, ST 34572W and ST 34573W)

The address block for the SCSI connector is at the front of the drive in J6. Four pairs of pins are covered; do not remove this cover or install jumpers on the pins under it.

Do not install any jumpers on J1A.

Do not remove or change the position of the jumpers installed on J2.

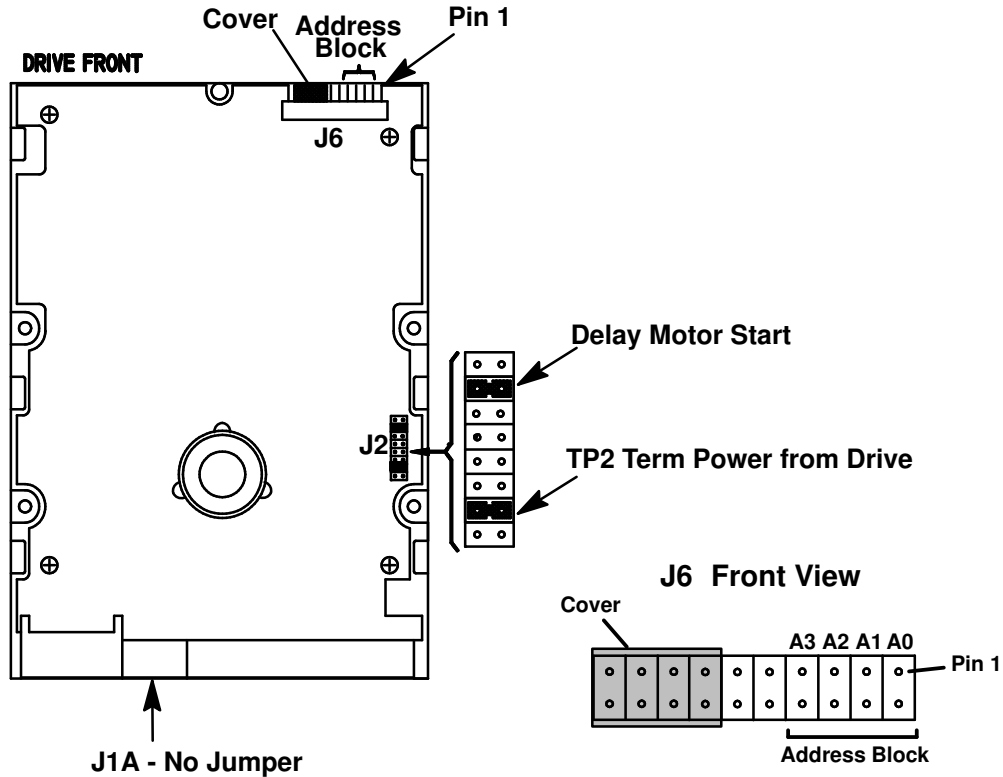

To set the SCSI ID (address), position the jumpers on the address block on J6 as shown below.

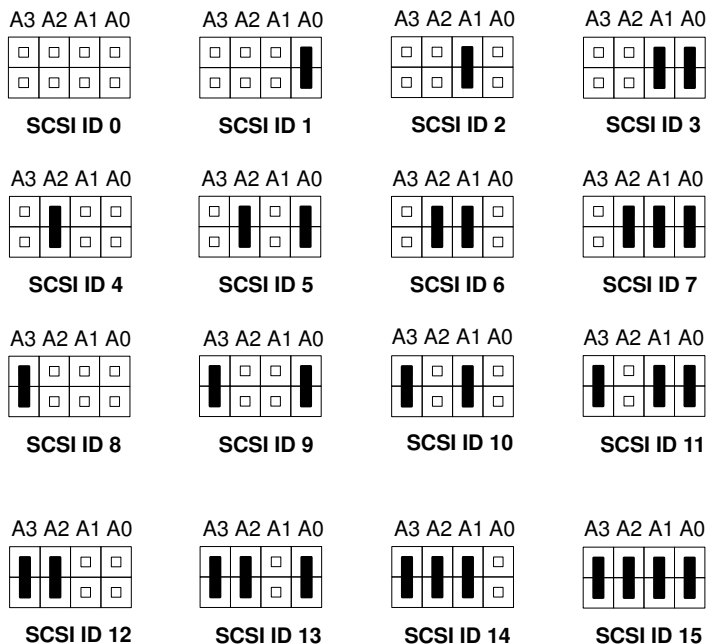

## 4.2GB SCSI-2 Disk Drive (ST 34371WC, ST 34572WC and ST 34573WC)

The SCSI addressing is determined by the position where you install the drive. The sequence in which the drives are installed has no effect on the address.

Do not install any jumpers on J6.

Do not remove or change the position of the jumper installed on J2.

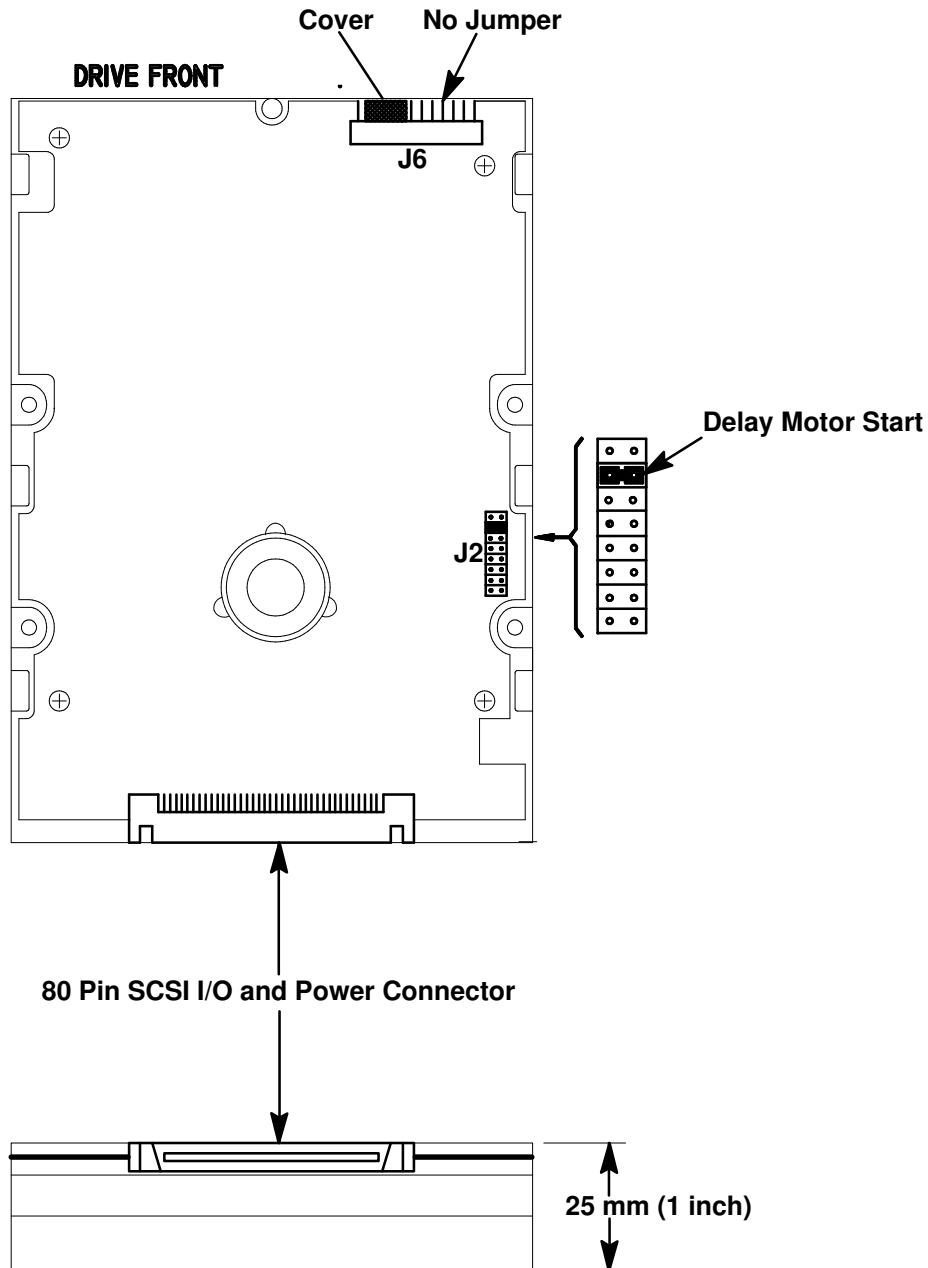

# 9.1GB SCSI-2 Disk Drive (ST 39173W)

The address block for the SCSI connector is at the front of the drive positioned in J6. Four pairs of pins are covered; do not remove this cover or install jumpers on the pins under it.

Do not remove or change the position of the jumpers installed on J2.

Do not install any jumpers on J1A.

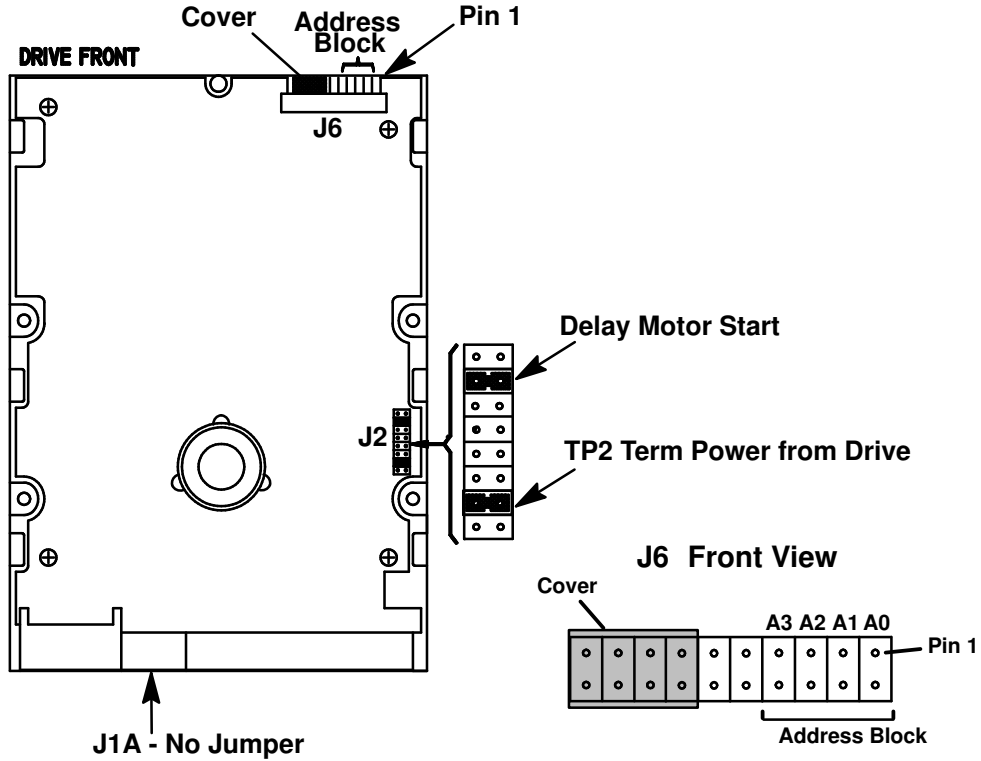

To set the SCSI ID (address), position the jumpers on the address block on J6 as shown below.

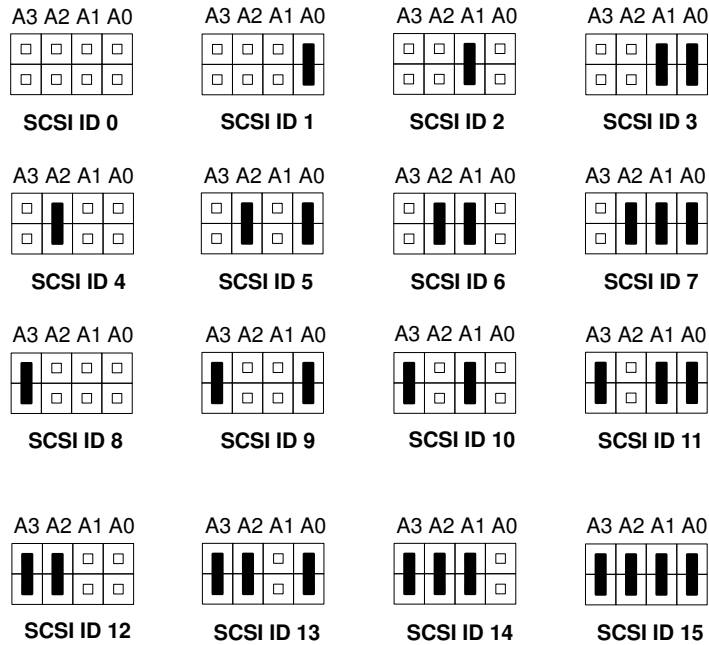

# 9.1GB SCSI-2/3 Disk Drive (ST 39175LW, ST 39236LW)

The address block for the SCSI connector is at the front of the drive positioned in J6. Four pairs of pins are covered; do not remove this cover or install jumpers on the pins under it.

Do not remove or change the position of the jumpers installed on J2.

Do not install any jumpers on J1A.

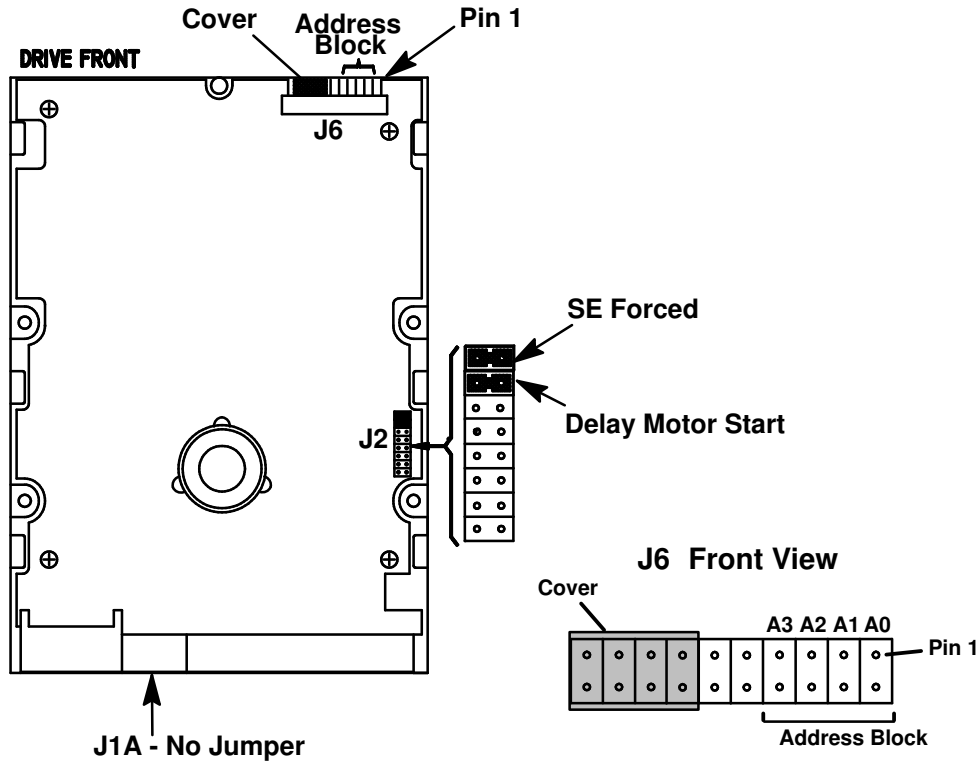

To set the SCSI ID (address), position the jumpers on the address block on J6 as shown below.

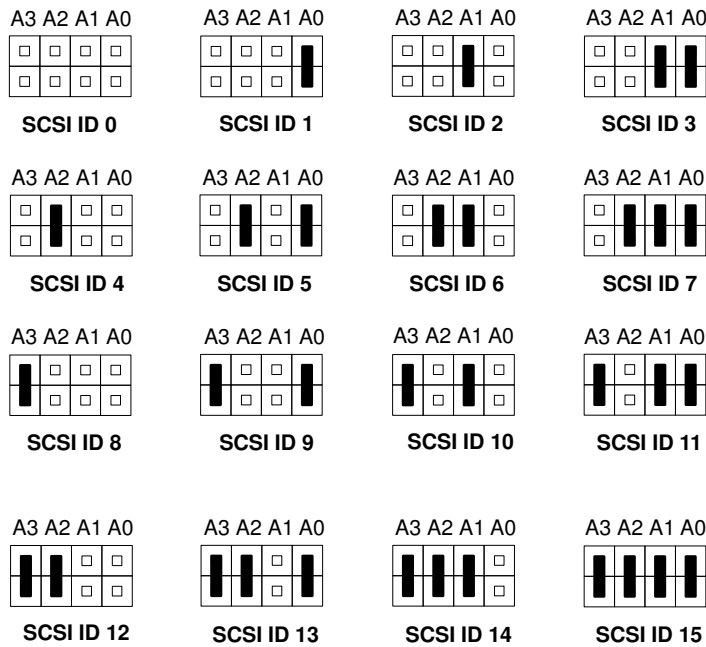

## 9.1GB SCSI-2 Disk Drive (ST 39173WC)

The SCSI addressing is determined by the position where you install the drive. The sequence in which the drives are installed has no effect on the address.

Do not install any jumpers on J6.

Do not remove or change the position of the jumper installed on J2.

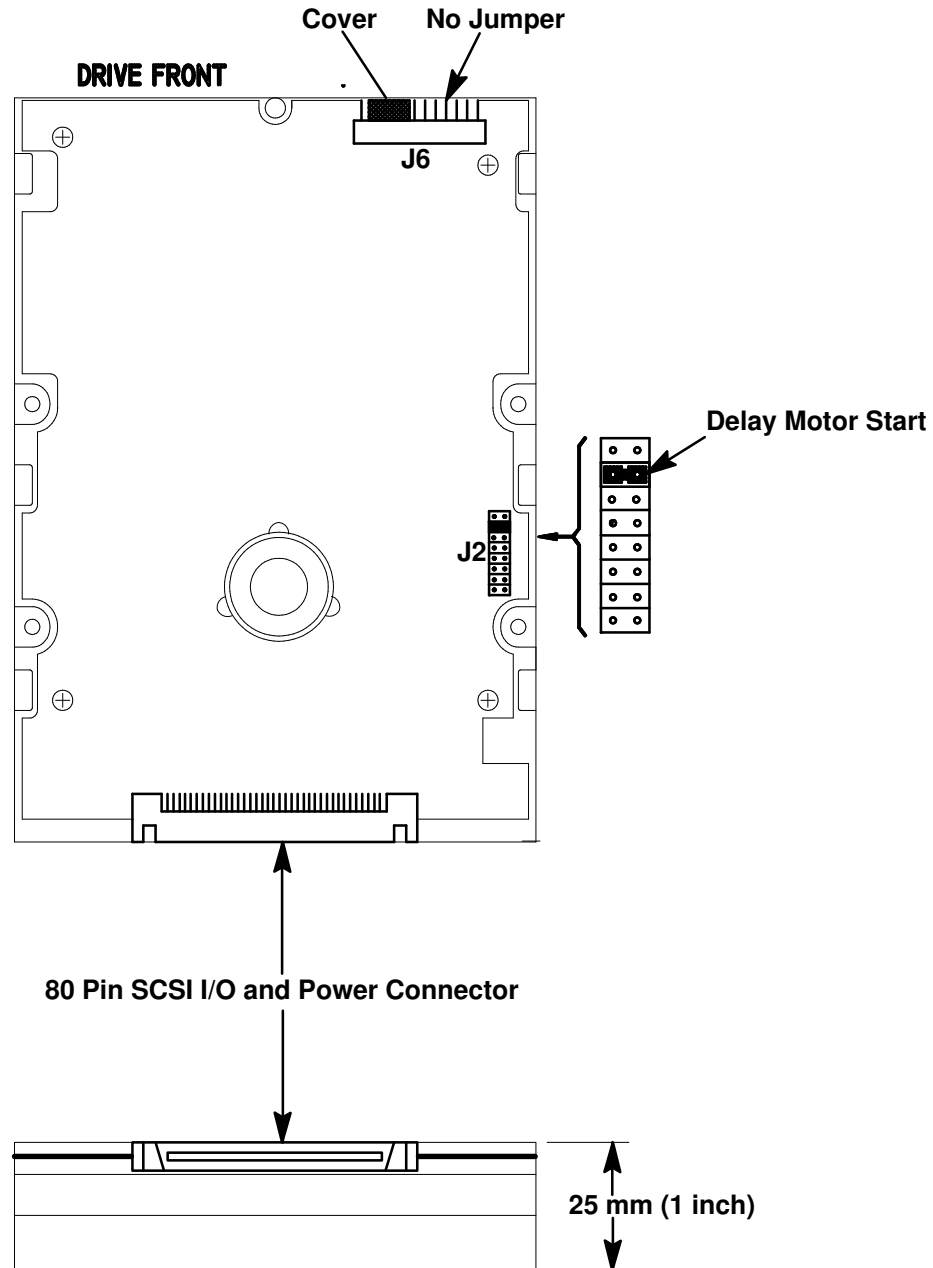

## 9.1GB SCSI-2/3 Disk Drive (ST 39175LC, ST 39236LC)

The SCSI addressing is determined by the position where you install the drive. The sequence in which the drives are installed has no effect on the address.

Do not install any jumpers on J6.

Do not remove or change the position of the jumpers installed on J2.

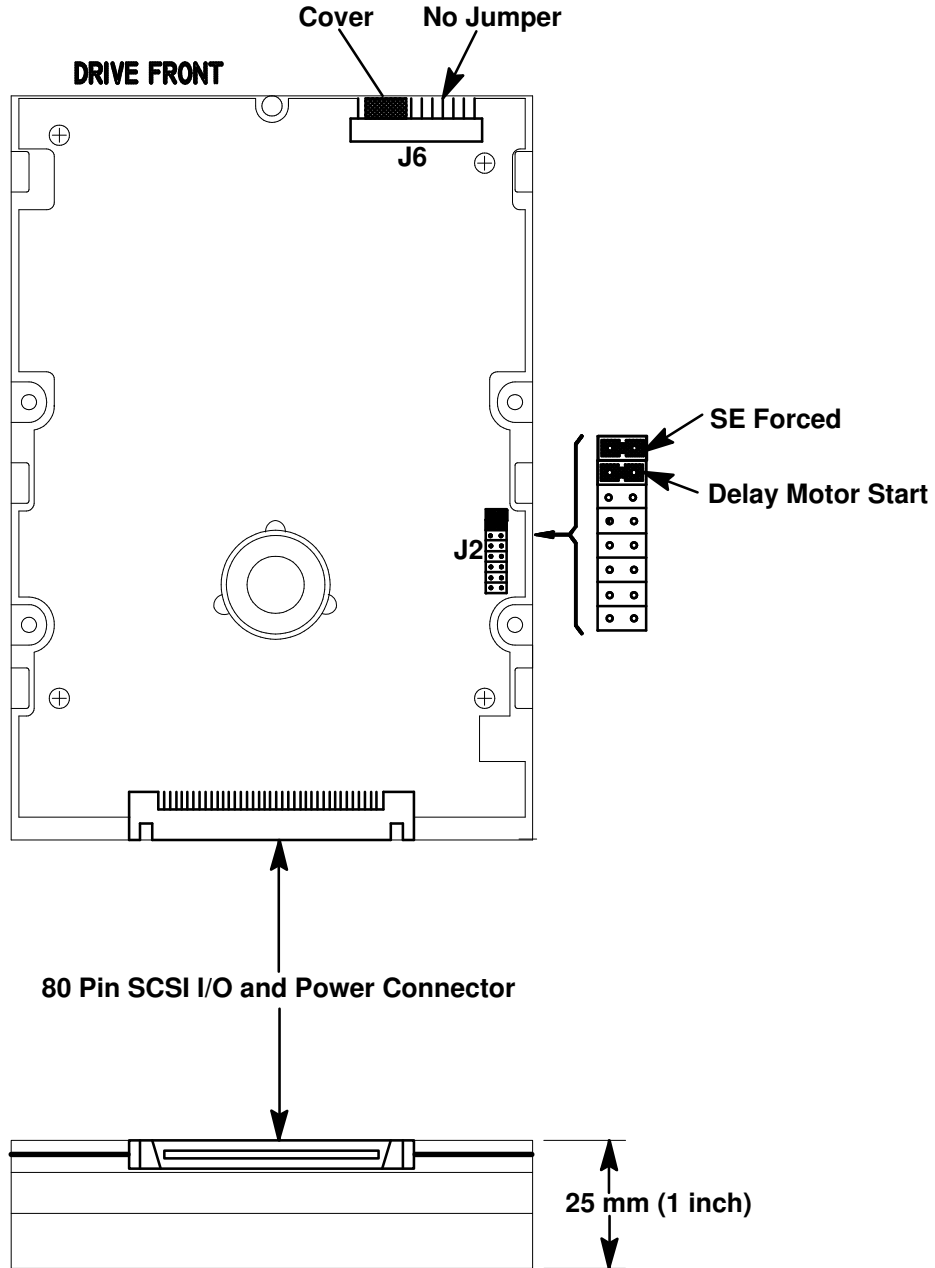

## 18.2GB SCSI-2/3 Disk Drive (ST 318275LC, ST 318436LC)

The SCSI addressing is determined by the position where you install the drive. The sequence in which the drives are installed has no effect on the address.

Do not install any jumpers on J6.

Do not remove or change the position of the jumpers installed on J2.

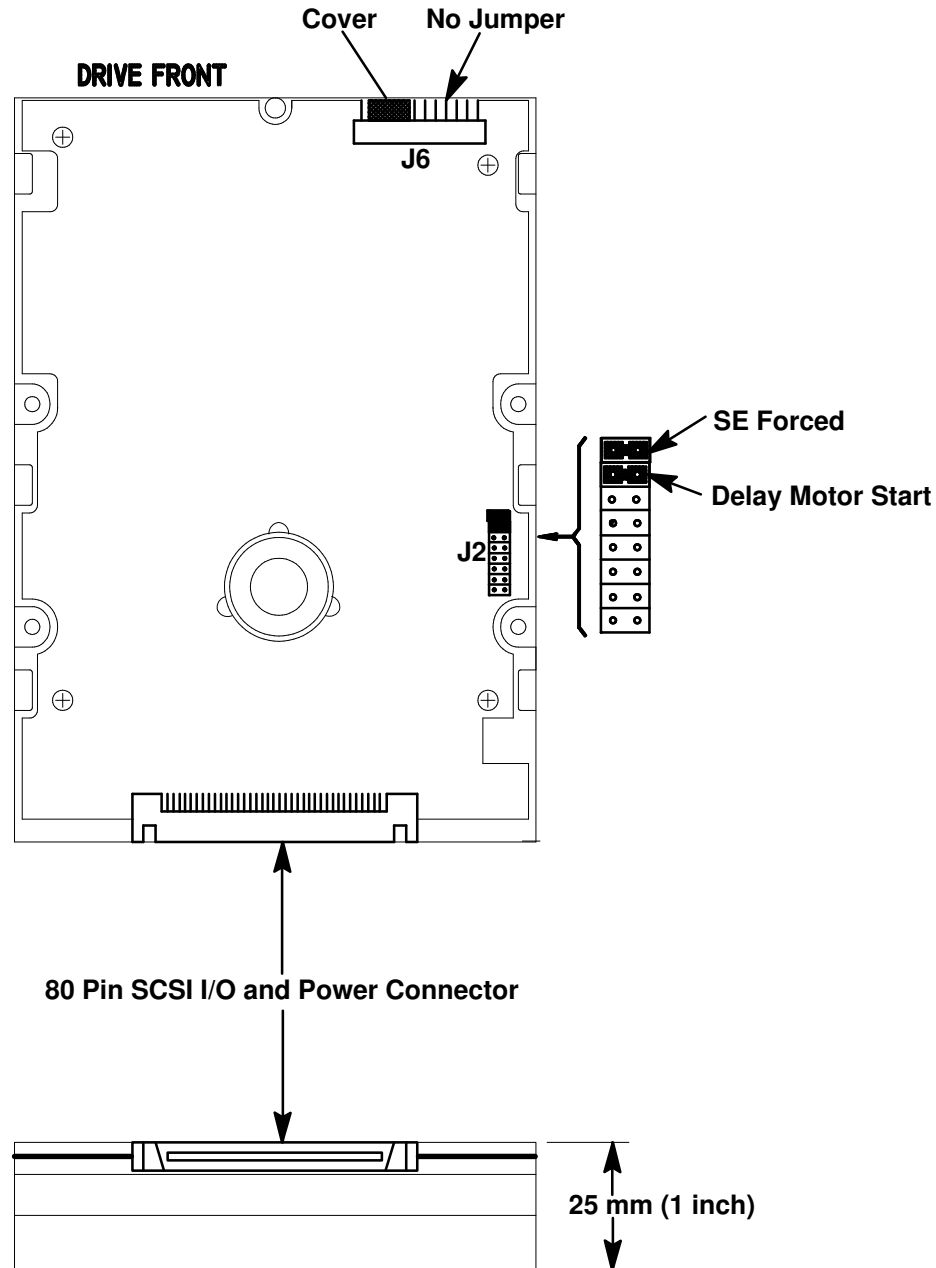

## 9.1GB SCSI-3 LVD Disk Drive (ST 39103LC, ST 39204LC)

The SCSI addressing is determined by the position where you install the drive. The sequence in which the drives are installed has no effect on the address.

Do not install any jumpers on J6.

Do not remove or change the position of the jumper installed on J2.

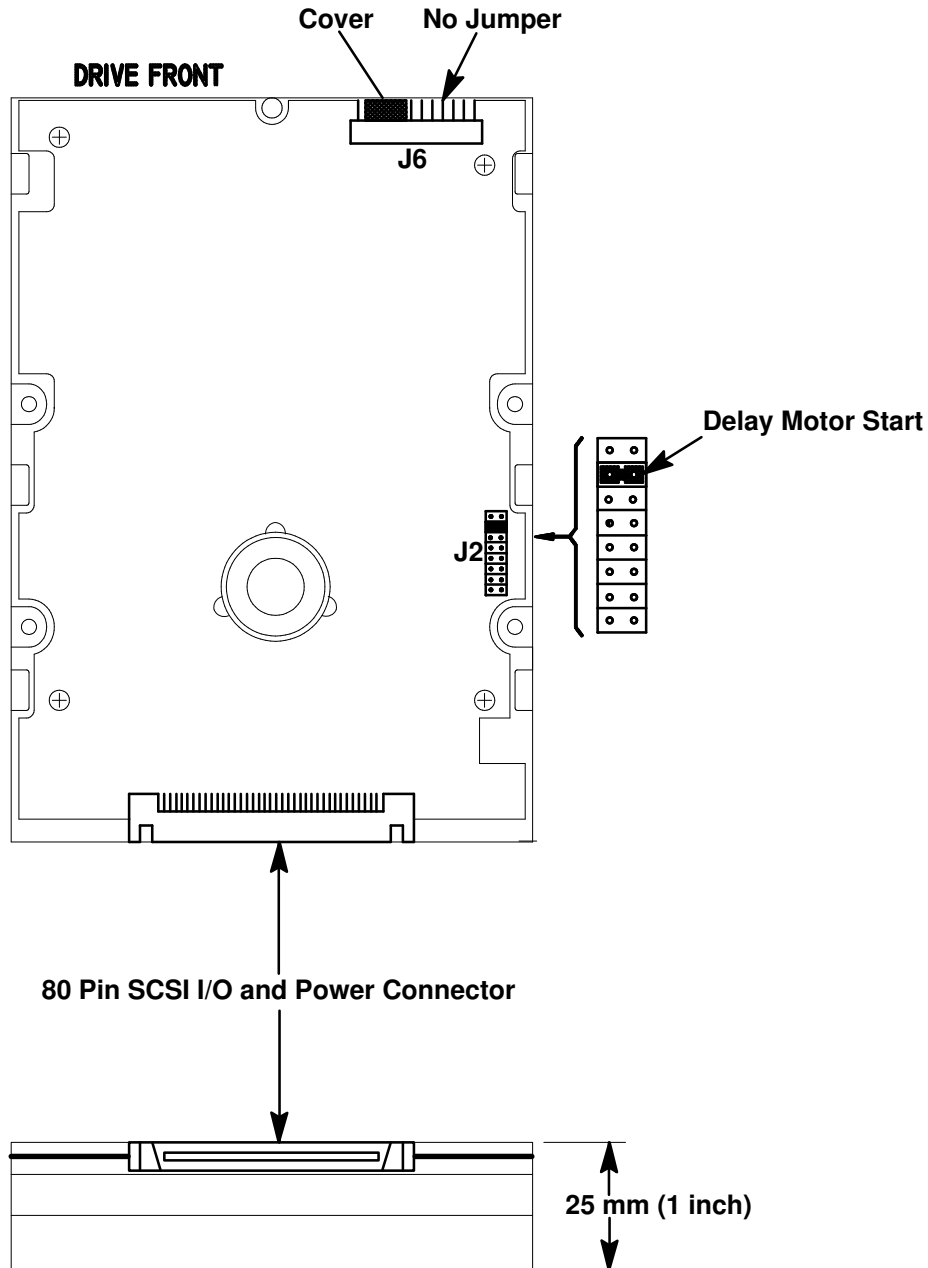



## 18.2GB SCSI-3 LVD Disk Drive (ST 318203LC, ST 318404LC, ST 318406LC)

The SCSI addressing is determined by the position where you install the drive. The sequence in which the drives are installed has no effect on the address.

Do not install any jumpers on J6.

Do not remove or change the position of the jumper installed on J2.

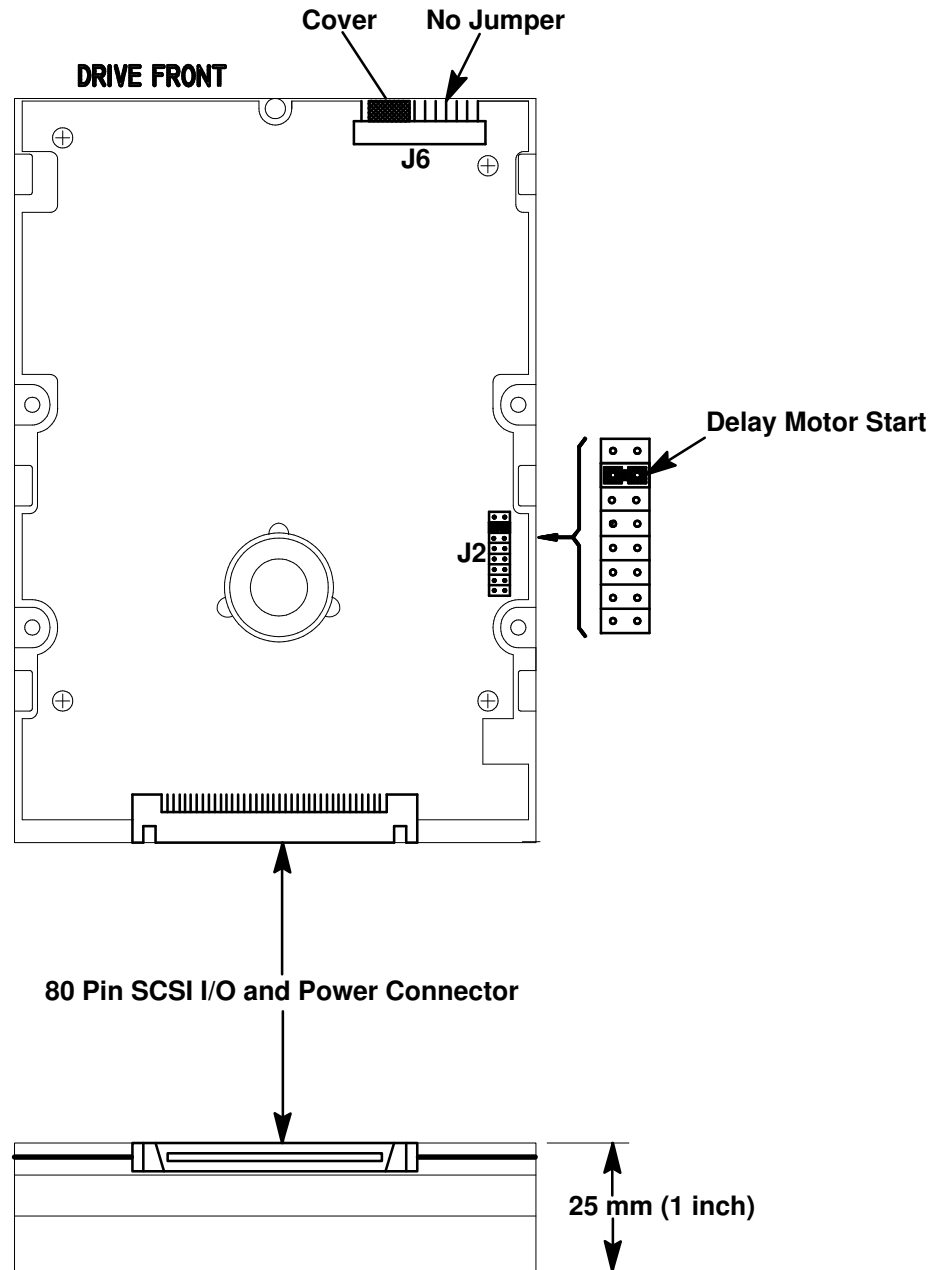

# 4.3GB SCSI-2 Disk Drive (ST 15230N)

This figure shows the bottom of the drive.

Use block J6 to set the SCSI ID. Connector J6 contains ten pairs of pins, four of which are covered. Do not remove this cover and do not install jumpers on the four positions under the cover.

Connector J5 is not used and should not contain any jumpers.

Do not remove the jumpers on J2.

The Address Block is as indicated on the drawing.

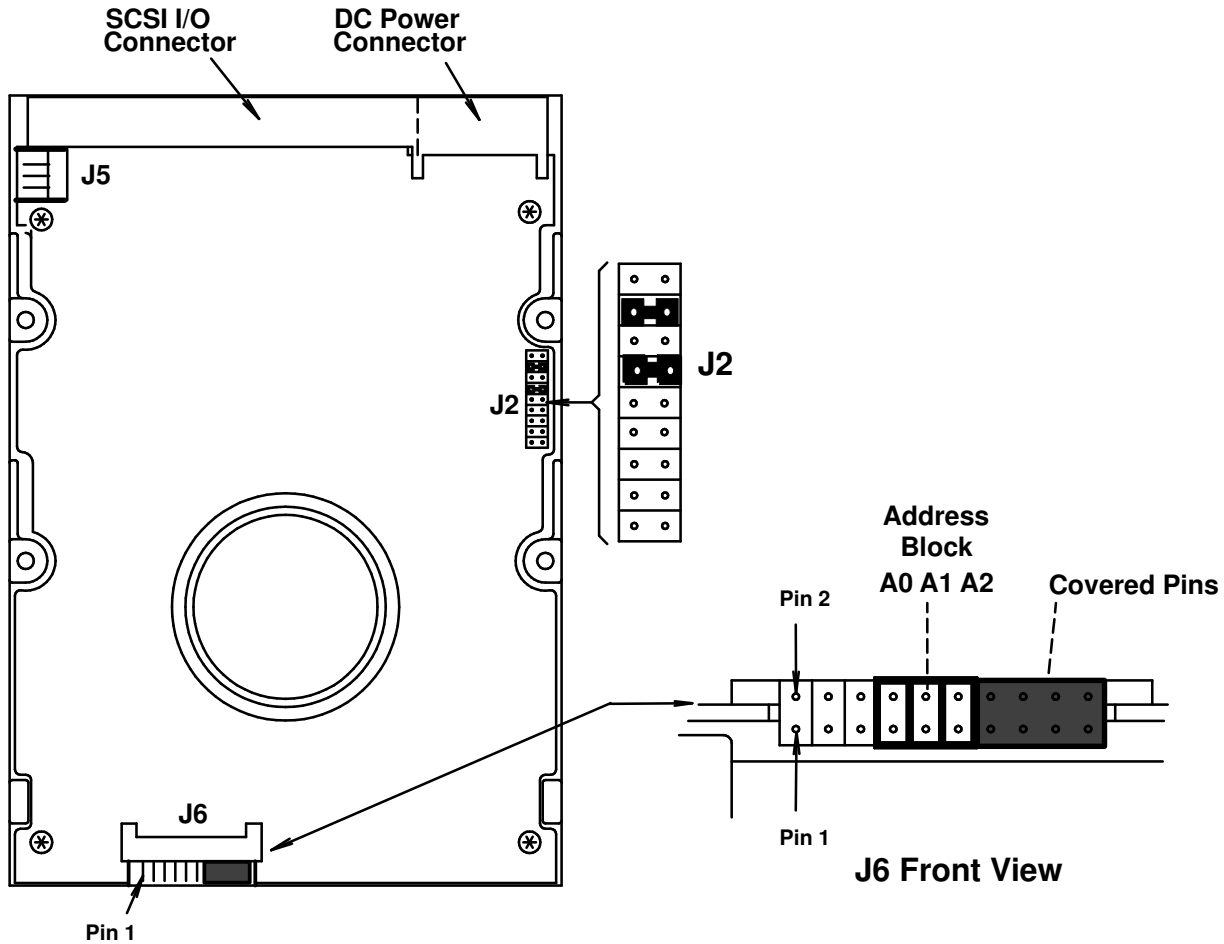

To set the SCSI ID (address), position the jumpers on the address block on J6 as shown below.

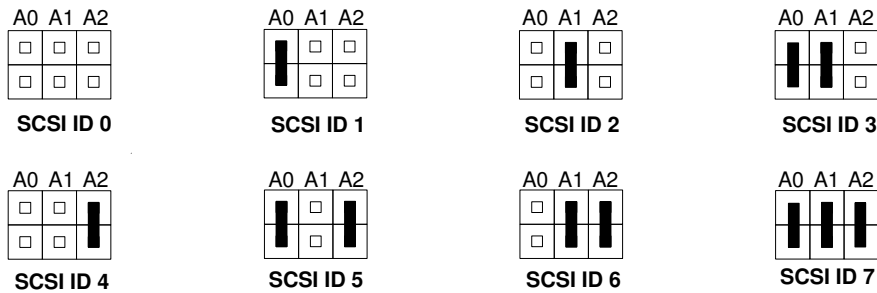

## 4.3GB SCSI-2 Disk Drive (ST 15150W)

The address block is located on the J5 connector which is between the SCSI connector and the power connector at the back of the disk drive.

Do not remove the jumper installed on J4.

No other jumper is to be installed.

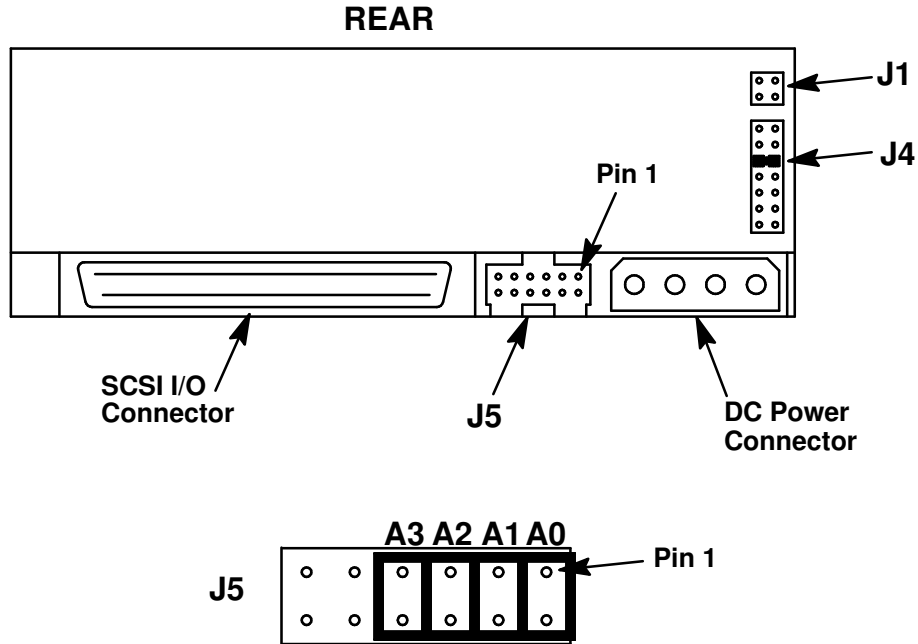

To set the SCSI ID (address), position the jumpers on the address block on J5 as shown below.

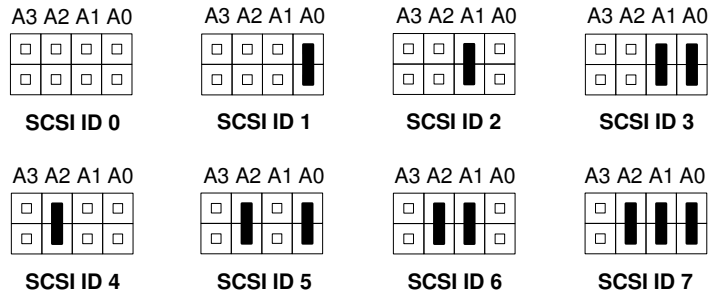

# 4.3GB SCSI-2 Disk Drive (ST 15150N)

The address block is located on the connector J4 which is at the right side above the power connector at the drive rear.

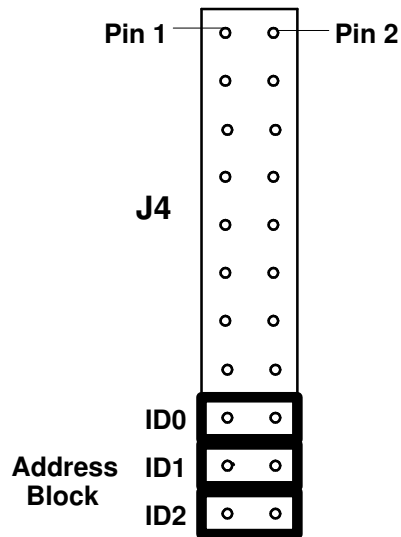
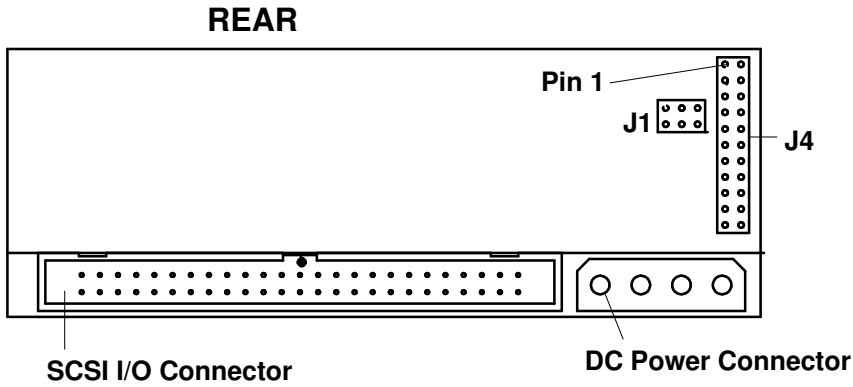

To set the SCSI ID (address), position the jumpers on the address block on J4 as shown below.

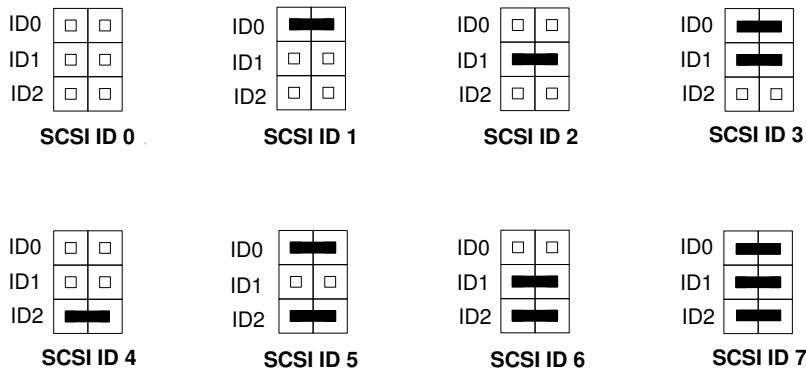

# 9.1GB SCSI-2 Disk Drive (ST 19171W)

The address block for the SCSI connector is at the front of the drive on connector J6. Four pairs of pins are covered; do not remove this cover and do not install jumpers on the pins under the cover.

Do not install any jumpers on J1A.

Do not remove or change the position of the jumper on J2.

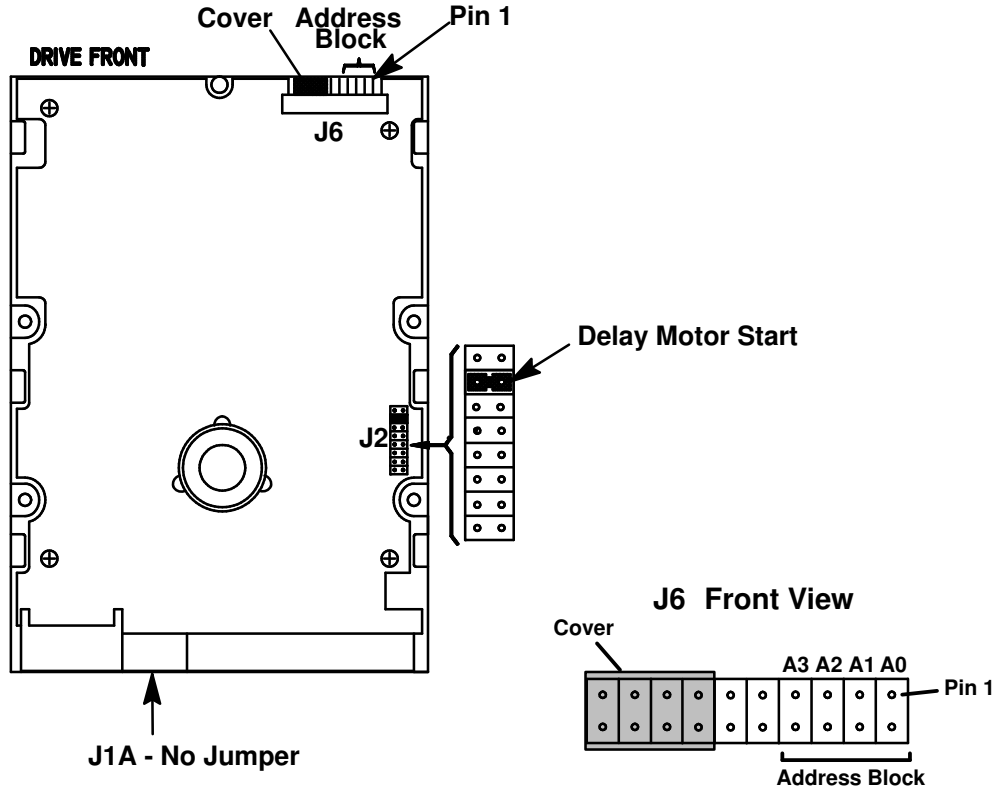

To set the SCSI ID (address), position the jumpers on the address block on J6 as shown below.

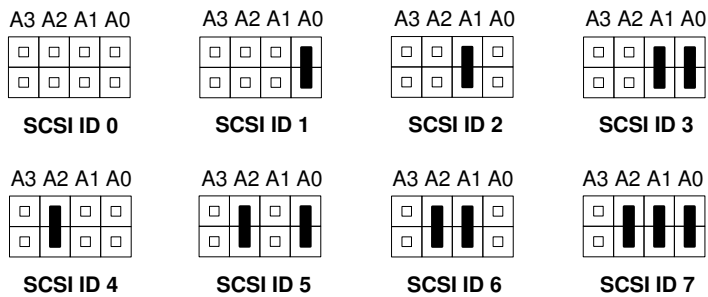

# 9.1GB SCSI-2 Disk Drive (ST 19171WC)

The SCSI address is determined by the position where you install the drive. The sequence in which the drives are installed has no effect on the address.

Do not install any jumpers on J6.

Do not remove or change the position of the jumper on J2.

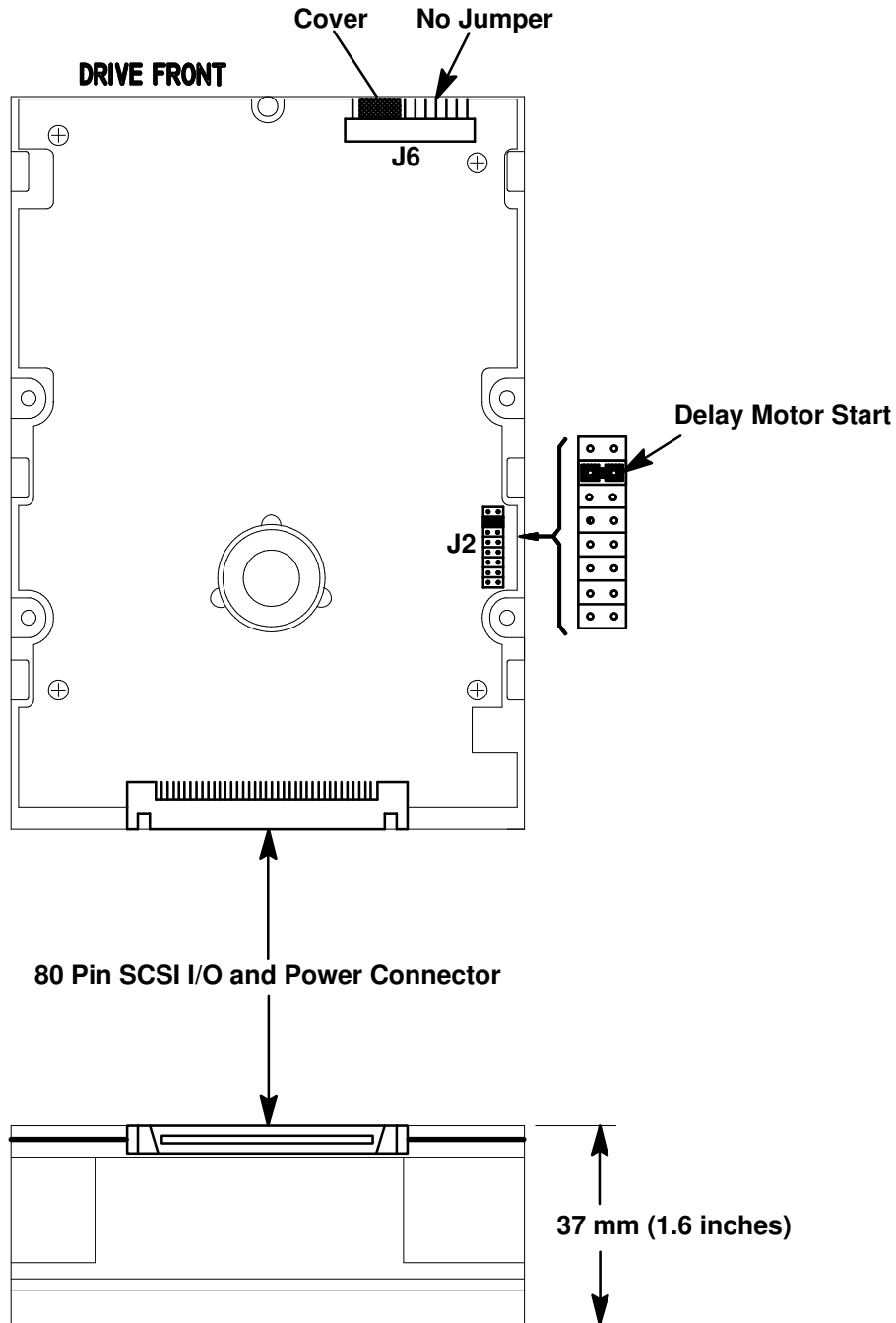

---

# Chapter 5. Tape Drives

---

## Introduction

This chapter groups reference information related to the configuration of tape drives.

It details the configuration of the SCSI IDs or addresses for these tape drives.

The procedures to install the peripheral in the machine are described in the *Installation and Service Guide* delivered with the system.

## Attributes

The tape drive attributes are set by default by the AIX operating system of your computer. However, certain attributes can be modified to meet special needs of your system. These modifications can be entered in two ways:

1. UNIX Commands:
  - **lsattr** to display the attributes
  - **chdev** to change the attributes

2. SMIT Menus of AIX

Detailed information on the tape drive attributes and on using the SMIT menus can be found in the documentation on the tape drive delivered with your system. (Or in paper document, *AIX 4.3 System Management Guide: Operating System and Devices*.)

The attributes to be set are indicated for each tape drive.

## Three Types of Tape Drive

There are three types of internal tape drives:

1. 4mm Tape Drives
2. 8mm Tape Drives
3. 1/4 Inch Tape Drives

# 4/8GB 4mm Internal Tape Drive (CTD 8000R)

## Attributes

This tape drive is recognized as: 4mm4gb.

For this tape drive, refer to the documentation on the tape drive delivered with your system, or the paper document, *AIX 4.3 System Management Guide: Operating System and Devices*.

## SCSI ID

The address block is located on the right side below the SCSI connector at the back of the device.

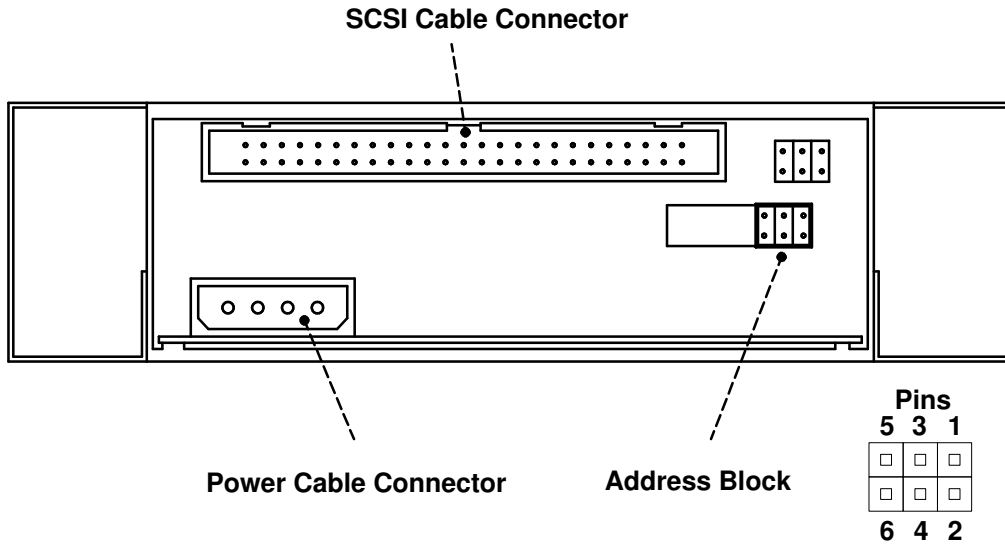

**Warning:** The position of the various components on the back may differ depending on the production model of the device. On the newer (21H5160) models, the SCSI connector is at the bottom, under the address block.

To set the SCSI ID (address), position the jumpers on the address block as shown below.

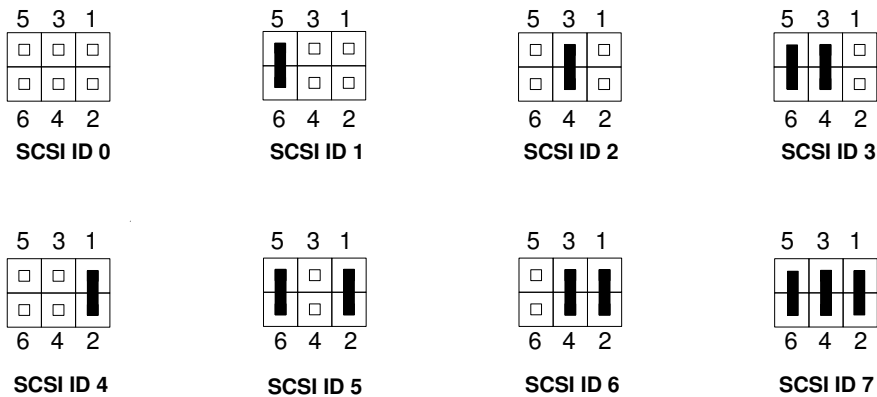

**Note:** You may also refer to a configuration label on the bottom of the drive.



---

# 4/8GB 4mm Internal Tape Drive (HP C1533A or HP C1539A)

## Attributes

AIX and the SMIT menus use this description: Bull 4.0 GB 4mm Tape Drive.

This additional designation is used in the SMIT menus: Bull4mm4gb.

## Block Size

The default block size is 1024.

The value for this entry field must be in the range 0...16777215 (+1).

## Device Buffers

The general information found in the *AIX 4.3 System Management Guide: Operating System and Devices*, applies to this tape drive type.

## Density Setting #1 and Density Setting #2

The user cannot change the density setting of this drive; the device reconfigures itself automatically depending on the Digital Data Storage (DDS) media type installed.

Cartridge Type	Bull Reference	Device Capacity
DDS1 (60m)	Bull 3226	Read in either density, write in 1.3GB mode and in 2.6GB mode with data compression.
DDS1 (90m)	Bull 3227	Read in either density, write in 2GB mode and in 4GB mode with data compression.
DDS2 (120m)	Bull 3228	Read in either density, write in 4GB mode and in 8GB mode with data compression.
DDS3 (125m)	Bull 3230	Not supported, cartridge will be ejected.
non-DDS		Not supported, cartridge will be ejected.

In order to identify computer-grade DDS media easily, look for the DDS logos. These indicate that the media meets the specifications laid down by the ECMA, ISO/IEC and ANSI standards.

DDS Logo	Media Type
DDS	DDS/DDS1 logo.
DDS2	DDS2 logo.
DDS3	DDS3 logo.
DDS	DDS Media Recognition System (MRS) logo. The DDS Media Recognition System cartridges have a series of stripes on the transparent leader at the beginning of the tape which enable drives to identify DDS-grade media.

## Data Compression

The general information found in the *AIX 4.3 System Management Guide: Operating System and Devices* applies to this tape drive type.

## Attributes with Fixed Values

If a tape drive is configured as a Bull 4.0GB 4mm Tape Drive, Reserve Support, Variable Length Block Size, Density Setting #1 and Density Setting #2 attributes have predefined values that cannot be changed.

This tape drive is a high-speed, high capacity tape backup device. Native backup capacity is 4GB and with compression is increased to 8GB.

# SCSI ID

Before installing this drive, check that the jumpers are installed as shown below. Install the tape drive following the instructions in the *ESTRELLA System Installation Guide*.

The address block is located on top of the power connector at the back of the device.

The following drawing also gives the SCSI addresses that you can set.

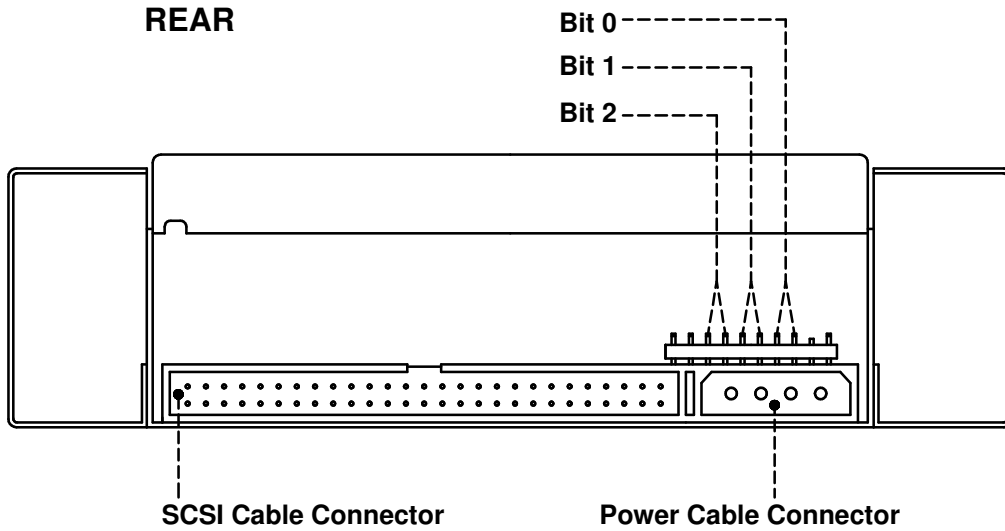

To set the SCSI ID (address), position the jumpers on the address block as shown below.

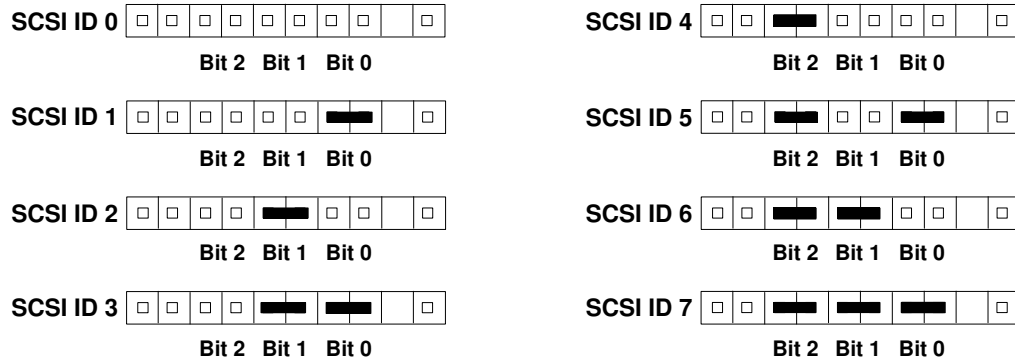

Don't change the setting of the configuration switches at the underside of the unit. These switches **MUST** be positioned as shown below.

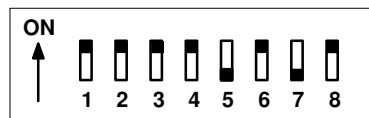

---

## 12/24 GB 4mm Internal Tape Drive DDS3 (HP C1537A)

The 12/24GB internal tape drive is a high-speed, high capacity tape backup device. Before installing this drive, check that the jumpers are installed as explained below. Install the tape drive following the instructions in the *System Installation and Service Guide* for your system.

### Attributes

AIX and the SMIT menus use this description: Bull 12/24 GB 4mm Tape Drive.

This additional designation is used in the SMIT menus: Bull4mm24gb.

### Block Size

The default block size is 1024.

The value for this entry field must be in the range 0...16777215 (+1).

### Device Buffers

The general information found in the *AIX 4.3 System Management Guide: Operating System and Devices*, applies to this tape drive type.

### Density Setting #1 and Density Setting #2

The user cannot change the density setting of this drive; the device reconfigures itself automatically depending on the Digital Data Storage (DDS) media type installed, as follows:

Cartridge Type	Bull Reference	Device Capacity
DDS1 (60m)	Bull 3226	Read in either density; write in 1.3GB mode or in 2.6GB mode with data compression.
DDS1 (90m)	Bull 3227	Read in either density; write in 2.0GB mode or in 4.0GB mode with data compression.
DDS2 (120m)	Bull 3228	Read in either density; write in 4.0GB mode or in 8.0GB mode with data compression.
DDS3 (125m)	Bull 3230	Read in either density; write in 12.0GB mode or in 24.0GB mode with data compression.
non-DDS		Not supported, cartridge will be ejected.

In order to identify computer-grade DDS media easily, look for the DDS logos. These indicate that the media meets the specifications laid down by the ECMA, ISO/IEC and ANSI standards.

DDS Logo	Media Type
DDS	DDS/DDS1 logo.
DDS2	DDS2 logo.
DDS3	DDS3 logo.
DDS	DDS Media Recognition System (MRS) logo. The DDS Media Recognition System cartridges have a series of stripes on the transparent leader at the beginning of the tape which enable drives to identify DDS-grade.

### Data Compression

The general information found in the *AIX 4.3 System Management Guide: Operating System and Devices* applies to this tape drive type.

### Attributes with Fixed Values

If a tape drive is configured as a Bull 12/24 GB 4mm Tape Drive, Reserve Support, Variable Length Block Size, Density Setting #1 and Density Setting #2 attributes have predefined values that cannot be changed.

This tape drive is a high-speed, high capacity tape backup device. Native backup capacity is 12GB and with compression is increased to 24GB.

# SCSI ID

Before installing this drive, check that the jumpers are installed as shown below. The address block is located on top of the power connector at the back of the device. Set the jumpers across the pins indicated as: Bit 0, Bit 1 and Bit 2, in the drawing below.

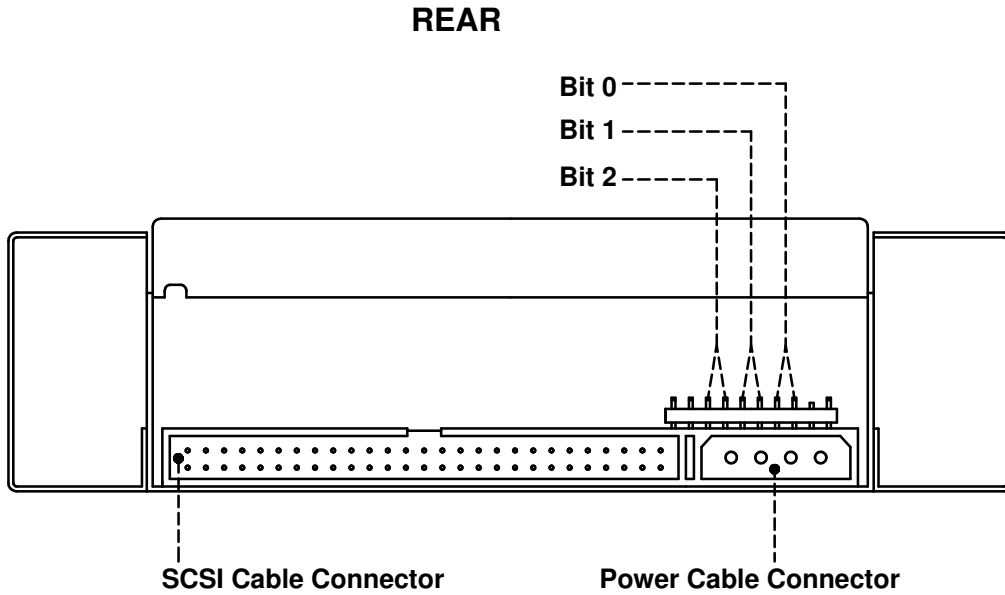

To set the SCSI ID (address), position the jumpers on the address block as shown below.

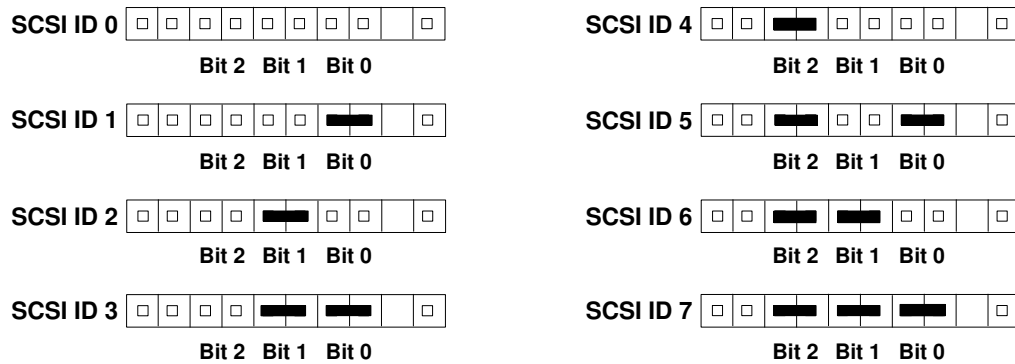

Don't change the setting of the configuration switches at the underside of the unit. These switches **MUST** be positioned as below.

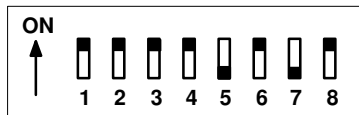

---

## 20/40 GB 4mm Internal Tape Drive DDS4 (HP C5683A)

The 20/40GB internal tape drive is a high-speed, high capacity tape backup device. Before installing this drive, check that the jumpers are installed as explained below. Install the tape drive following the instructions in the *System Installation and Service Guide* for your system.

### Attributes

AIX and the SMIT menus use this description: Bull 20/40 GB 4mm Tape Drive.

This additional designation is used in the SMIT menus: Bull4mm40gb.

### Block Size

The default block size is 1024.

The value for this entry field must be in the range 0...16777215 (+1).

### Device Buffers

The general information found in the *AIX 4.3 System Management Guide: Operating System and Devices*, applies to this tape drive type.

### Density Setting #1 and Density Setting #2

The user cannot change the density setting of this drive; the device reconfigures itself automatically depending on the Digital Data Storage (DDS) media type installed, as follows:

Cartridge Type	Bull Reference	Device Capacity
DDS1 (60m)	Bull 3226	NOT SUPPORTED.
DDS1 (90m)	Bull 3227	READ-ONLY in DOS-1 mode (2GB native or 4GB with data compression).
DDS2 (120m)	Bull 3228	Read in either density; write in 4.0GB mode or in 8.0GB mode with data compression.
DDS3 (125m)	Bull 3230	Read in either density; write in 12.0GB mode or in 24.0GB mode with data compression.
DDS4 (150m)	N/A	Read in either density; write in 20.0GB mode or in 40GB mode with data compression.
non-DDS		Not supported, cartridge will be ejected.

In order to identify computer-grade DDS media easily, look for the DDS logos. These indicate that the media meets the specifications laid down by the ECMA, ISO/IEC and ANSI standards.

DDS Logo	Media Type
DDS	DDS/DDS1 logo.
DDS2	DDS2 logo.
DDS3	DDS3 logo.
DDS4	DDS4 logo
DDS	DDS Media Recognition System (MRS) logo. The DDS Media Recognition System cartridges have a series of stripes on the transparent leader at the beginning of the tape which enable drives to identify DDS-grade.

### Data Compression

The general information found in the *AIX 4.3 System Management Guide: Operating System and Devices* applies to this tape drive type.

## Attributes with Fixed Values

If a tape drive is configured as a Bull 20/40 GB 4mm Tape Drive, Reserve Support, Variable Length Block Size, Density Setting #1 and Density Setting #2 attributes have predefined values that cannot be changed.

This tape drive is a high-speed, high capacity tape backup device. Native backup capacity is 20GB and with compression is increased to 40GB.

## SCSI ID

Before installing this drive, check that the jumpers are installed as shown below.

The address block is located to the left of the power connector at the back of the device.

Set the jumpers across the pins indicated as: 8, 4, 2, 1 in the drawing below.

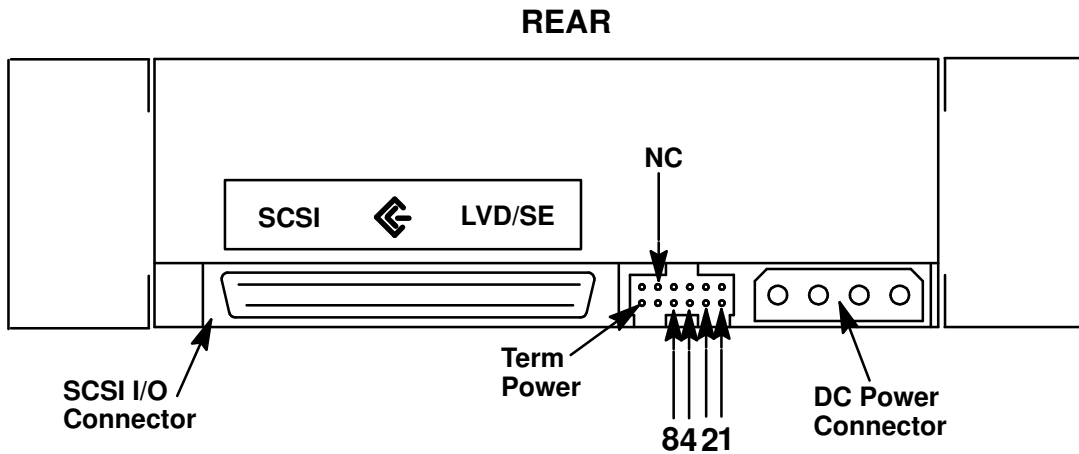

To set the SCSI ID (address), position the jumpers on the address block as shown below.

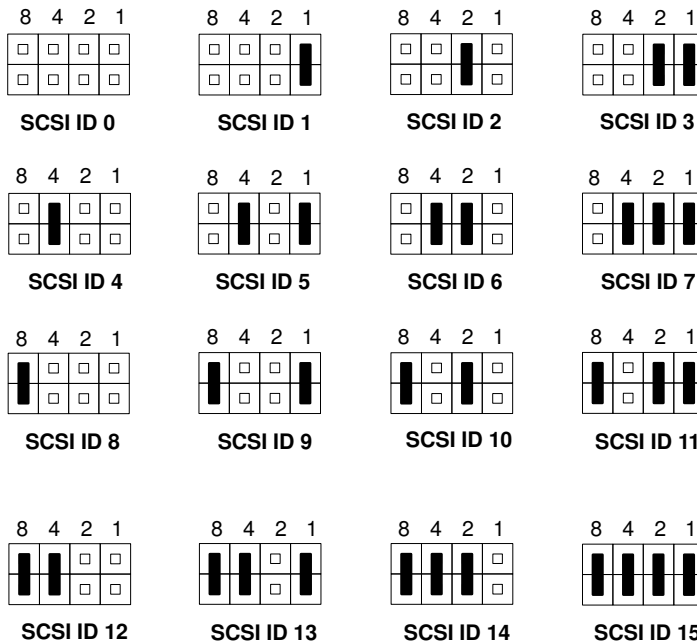

Don't change the setting of the configuration switches at the underside of the unit. These switches **MUST** be positioned as below.

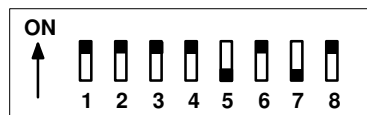

---

## 7/14GB 8mm Internal Tape Drive (EXB 8505XL)

### Attributes

AIX and the SMIT menus use this description: Bull 7/14 GB 8mm Tape Drive.

This additional designation is used in the SMIT menus: Bull8mm5gb.

### Block Size

The default block size is 1024.

The value for this entry field must be in the range 0...245760.

### Device Buffers

The general information found in the *AIX 4.3 System Management Guide: Operating System and Devices*, applies to this tape drive type.

### Extended File Marks

The general information found in the *AIX 4.3 System Management Guide: Operating System and Devices*, applies to this tape drive type.

### Density Setting #1 and Density Setting #2

The following settings apply:

Setting	Meaning
140	7GB mode, compression capable (8500c format).
20	2.3GB mode (8200 format).
21	7GB mode (8500 format).
0	7GB mode, compression capable.

### Data Compression

The general information found in the *AIX 4.3 System Management Guide: Operating System and Devices*, applies to this tape drive type.

# SCSI ID

The address block is located on the right side of the power connector at the back of the device.

No terminator is to be installed.

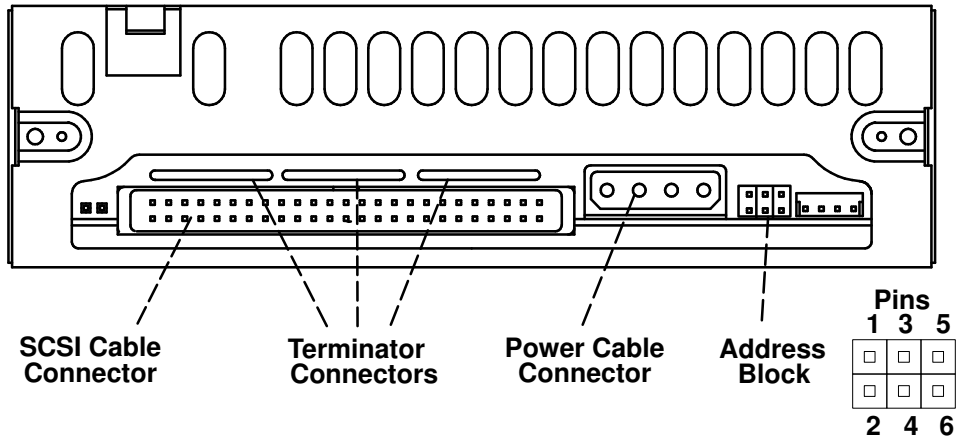

To set the SCSI ID (address), position the jumpers on the address block as shown below.

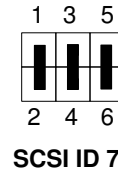
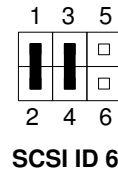
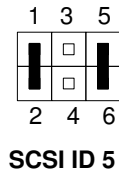
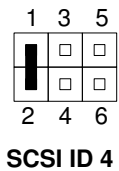
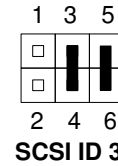
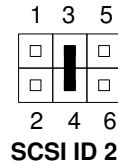
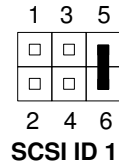
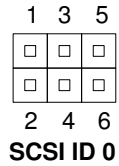

No other jumper is to be installed.



---

# 7/14GB 8mm Internal Tape Drive (EXB 8705)

## Attributes

AIX and the SMIT menus use this description: Bull 7/14 GB 8mm Tape Drive.

This additional designation is used in the SMIT menus: Bull8mm5gb.

## Block Size

The default block size is 1024.

The value for this entry field must be in the range 0...245760.

## Device Buffers

The general information found in the *AIX 4.3 System Management Guide: Operating System and Devices*, applies to this tape drive type.

## Extended File Marks

The general information found in the *AIX 4.3 System Management Guide: Operating System and Devices*, applies to this tape drive type.

## Density Setting #1 and Density Setting #2

The following settings apply:

Setting	Meaning
140	7GB mode, compression capable (8500c format).
20	2.3GB mode (8200 format).



The 8200 format is "**Read Only**". When using this format the cartridge **MUST** be write protected.

21	7GB mode (8500 format).
0	7GB mode, compression capable.

## Data Compression

The general information found in the *AIX 4.3 System Management Guide: Operating System and Devices*, applies to this tape drive type.

# SCSI ID

The address block is located on the right side of the power connector at the back of the device.

No terminator is to be installed.

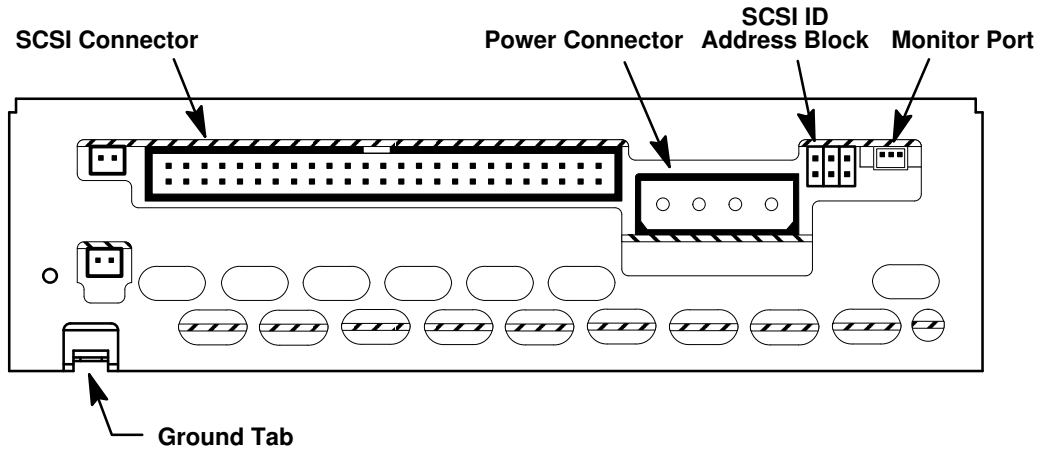

To set the SCSI ID (address), position the jumpers on the address block as shown below.

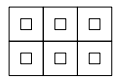

SCSI ID 0

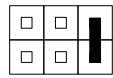

SCSI ID 1

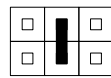

SCSI ID 2

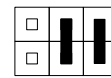

SCSI ID 3

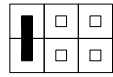

SCSI ID 4

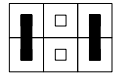

SCSI ID 5

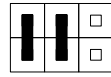

SCSI ID 6

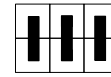

SCSI ID 7

No other jumper is to be installed.

---

## 2.5/5GB 1/4 Inch Internal Tape Drive (TDC 4222)

### Attributes

AIX and the SMIT menus use this description: Bull 2.5 GB 1/4-Inch Tape Drive.

This additional designation is used in the SMIT menus: Bull2500mb-c.

### Block Size

The default block size is 512.

The other valid block sizes are 0 for variable length blocks, and 1024.

### Device Buffers

The general information found in the *AIX 4.3 System Management Guide: Operating System and Devices*, applies to this tape drive type.

### Extended File Marks

Writing to a 1/4-inch tape can only occur at the beginning of the tape (BOT) or after blank tape is detected. If data exists on the tape, you cannot overwrite the data except at BOT. If you wish to add data to a tape that has been written and then rewound, you must space forward until the next file mark is detected, which causes the system to return an error. Only then can you start writing again.

### Retension

The general information found in the *AIX 4.3 System Management Guide: Operating System and Devices*, applies to this tape drive type.

### Density Setting #1 and Density Setting #2

The following settings apply:

Setting	Meaning
34	QIC-2GB – up to 2.5 GB with Error Correction Code (ECC) and data compression
21	QIC-1000 – up to 1.2GB with ECC and data compression
17	QIC-525 – up to 525MB with ECC
16	QIC-150 – up to 250MB
15	QIC-120 – up to 120MB
0	Default (QIC-2GB), or whatever was the last density setting entered by a user.

### Data Compression

The general information found in the *AIX 4.3 System Management Guide: Operating System and Devices*, applies to this tape drive type.

### Attributes with Fixed Values

If a tape drive is configured as a Bull 2.5 GB 1/4-Inch Tape Drive, the Extended File Marks, Reserve Support and Variable Length Block Size have predefined values which cannot be changed.

# SCSI ID

The address block is located between the power and the SCSI connector at the back of the device.

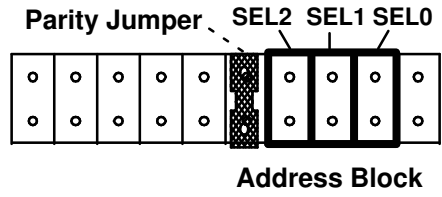
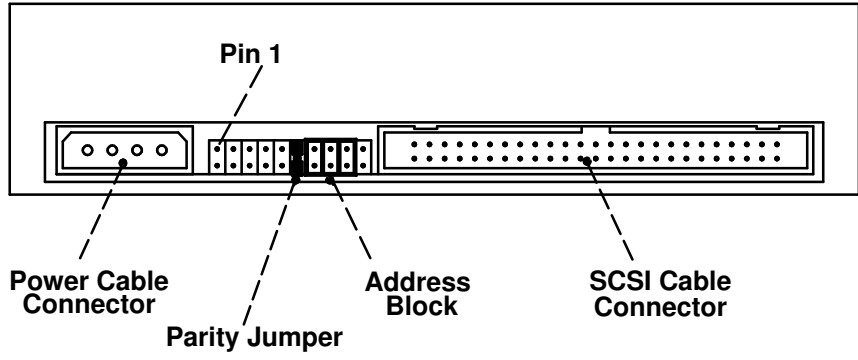

To set the SCSI ID (address), position the jumpers on bits SEL0, SEL1, and SEL2 on the address block as shown below.

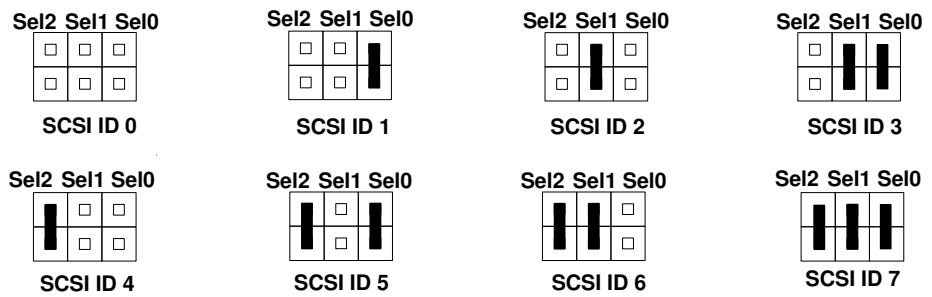

In addition, a parity jumper must always be installed as shown.

No terminator is required.

## 13/26GB 1/4 Inch Internal Tape Drive or 16/32GB 1/4 Inch Internal Tape Drive (MLR1)

The quick evolution of technology in the field of tape drives has led to the delivery of two types of MLR1. The differences between the older delivery and newer deliveries will be pointed out whenever they occur in the following section if no special mention is made than the information given applies to both models. To know whether you have a model of the older deliveries or of the newer deliveries, refer to the figures below.

### Older Model

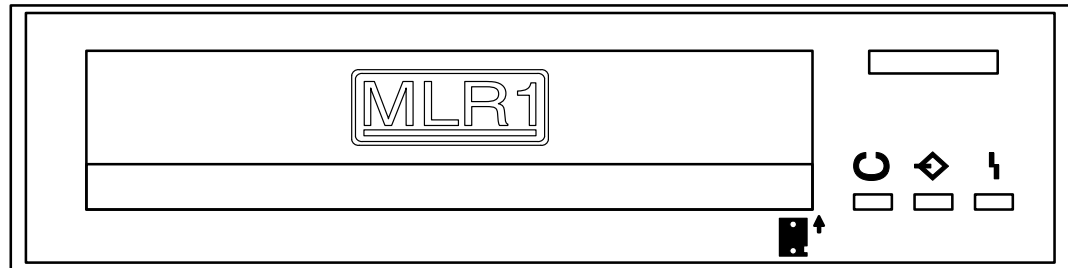

Front bezel of the older model of the MLR1 device

### Newer Model

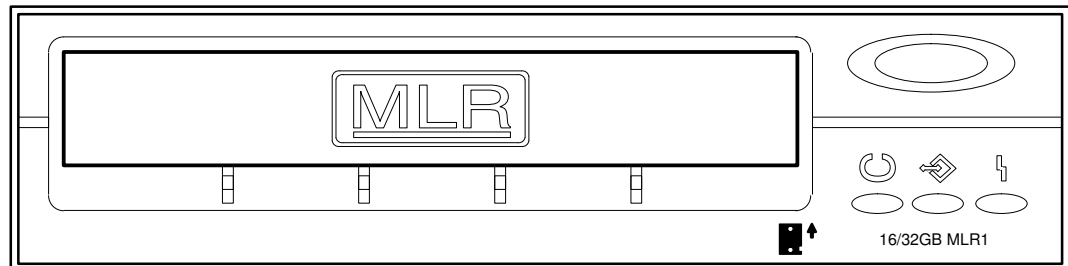

Front bezel of the newer model of the MLR1 device

## Attributes

AIX and the SMIT menus use this description: Bull 16 GB 1/4 Inch Tape Drive.

This additional designation is used in the SMIT menus: Bull13gb-c.

## Block Size

The default block size is 512.

The other valid block sizes are 0 for variable length blocks, and 1024.

## Device Buffers

The general information found in the *AIX 4.3 System Management Guide: Operating System and Devices*, applies to this tape drive type.

## Extended File Marks

Writing to a 1/4-inch tape can only occur at the beginning of the tape (BOT) or after blank tape is detected. If data exists on the tape, you cannot overwrite the data except at BOT. If you wish to add data to a tape that has been written and then rewound, you must space forward until the next file mark is detected, which causes the system to return an error. Only then can you start writing again.

## Retention

The general information found in the *AIX 4.3 System Management Guide: Operating System and Devices*, applies to this tape drive type.

## Density Setting #1 and Density Setting #2

The following settings apply:

Setting	Meaning
33	QIC-5010 – 13GB Format or 16 GB native Format with Error Correction Code (ECC) and data compression
34	QIC-2GB – up to 2.5 GB with ECC and data compression
21	QIC-1000 – up to 1.2 GB with ECC and data compression
17	QIC-525 – up to 525 MB with ECC
16	QIC-150 – up to 250 MB
15	QIC-120 – up to 120 MB
0	<b>(Older Model)</b> Default (QIC-5010), or whatever was the last density setting entered by a user.
0	<b>(Newer Model)</b> Default density: the drive automatically detects the type of cartridge inserted and chooses the maximum density allowed for that cartridge.

## Data Compression

The general information found in the *AIX 4.3 System Management Guide: Operating System and Devices*, applies to this tape drive type.

## Attributes with Fixed Values

If a tape drive is configured as a Bull 16 GB 1/4-Inch Tape Drive, the Extended File Marks, Reserve Support and Variable Length Block Size have predefined values which cannot be changed.

# SCSI ID

The option block is between the data connector and the power connector on the back of the MLR1 tape drive.

The first 9 positions at the left are reserved. Install no jumpers on them. The 10th position determines the parity. A jumper must be installed there.

Stickers on the back of the drive give uses of the different pins on the Power Block and on the Option Block. The Option Block sticker is reproduced below showing the jumper positions necessary to configure the drive in your system.

## Older Model

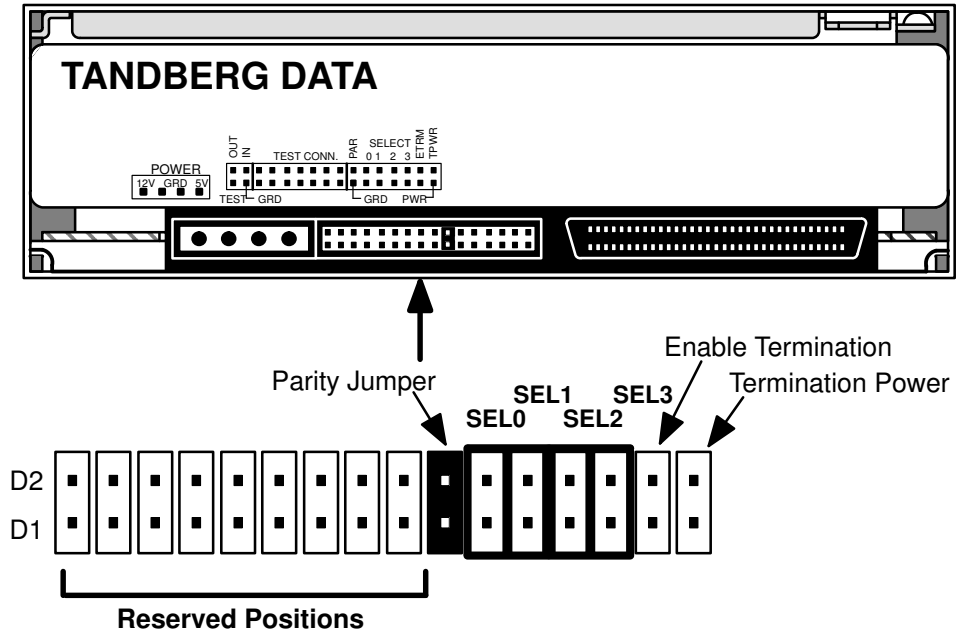

## Newer Model

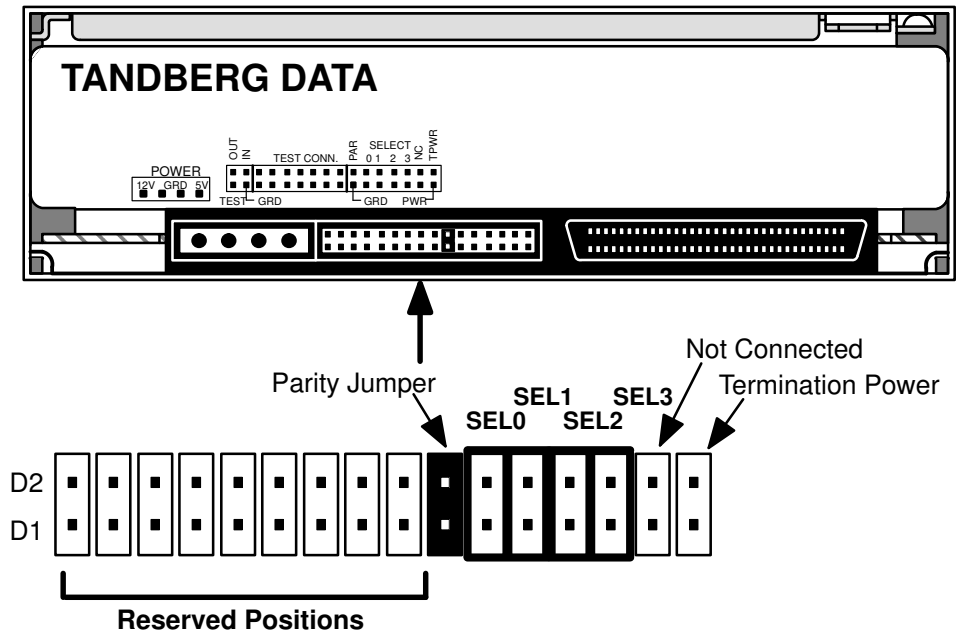

With the newer model of the MLR1 tape driver, it is not possible to enable SCSI termination.

To set the SCSI ID, position jumpers on bits on the address option block as shown below.



**SCSI ID 0**

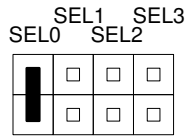

**SCSI ID 1**

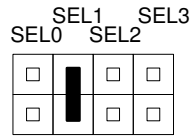

**SCSI ID 2**

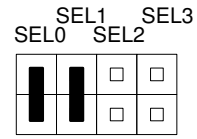

**SCSI ID 3**

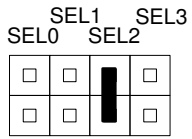

**SCSI ID 4**

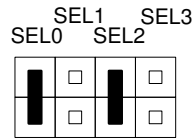

**SCSI ID 5**

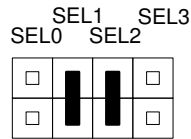

**SCSI ID 6**

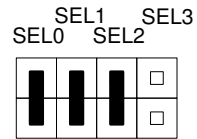

**SCSI ID 7**

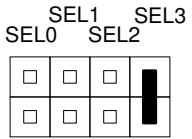

**SCSI ID 8**

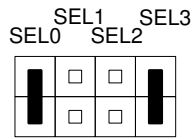

**SCSI ID 9**

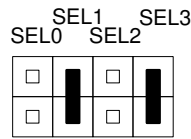

**SCSI ID 10**



**SCSI ID 11**

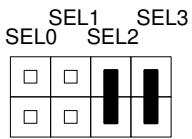

**SCSI ID 12**

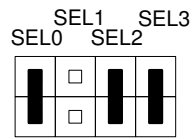

**SCSI ID 13**



**SCSI ID 14**



**SCSI ID 15**



---

## 25/50GB 1/4 Inch Internal Tape Drive (MLR3)

### Attributes

AIX and the SMIT menus use this description: Bull 25/50 GB 1/4 Inch MLR3 Tape.

This additional designation is used in the SMIT menus: Bull25gb-c.

### Block Size

The default block size is 512.

The other valid block sizes are 0 for variable length blocks, and 1024.

### Device Buffers

The general information found in the *AIX 4.3 System Management Guide: Operating System and Devices*, applies to this tape drive type.

### Extended File Marks

Writing to a 1/4-inch tape can only occur at the beginning of the tape (BOT) or after blank tape is detected. If data exists on the tape, you cannot overwrite the data except at BOT. If you wish to add data to a tape that has been written and then rewound, you must space forward until the next file mark is detected, which causes the system to return an error. Only then can you start writing again.

### Retention

The general information found in the *AIX 4.3 System Management Guide: Operating System and Devices*, applies to this tape drive type.

### Density Setting #1 and Density Setting #2

The following settings apply:

Setting	Meaning
48	MLR3-25GB – 25GB Format native with Error Correction Code (ECC) and data compression – Read and Write
33	QIC-5010 – 13GB Format or 16 GB native Format with Error Correction Code (ECC) and data compression – Read and Write
38	QIC-4GB – up to 4 GB with Error Correction Code (ECC) and data compression – Read only
34	QIC-2GB – up to 2.5 GB with Error Correction Code (ECC) and data compression – Read only
0	Default density: the drive automatically detects the type of cartridge inserted and chooses the maximum density allowed for that cartridge.

### Data Compression

The general information found in the *AIX 4.3 System Management Guide: Operating System and Devices*, applies to this tape drive type.

### Attributes with Fixed Values

If a tape drive is configured as a Bull 25/50 GB 1/4 Inch MLR3 Tape, the Extended File Marks, Reserve Support and Variable Length Block Size have predefined values which cannot be changed.

# SCSI ID

The option block is between the data connector and the power connector on the back of the MLR3 tape drive.

The first 9 positions at the left are reserved. Install no jumpers on them. The 10th position determines the parity. A jumper must be installed there.

Stickers on the back of the drive give uses of the different pins on the Power Block and on the Option Block. The Option Block sticker is reproduced below showing the jumper positions necessary to configure the drive in your system.

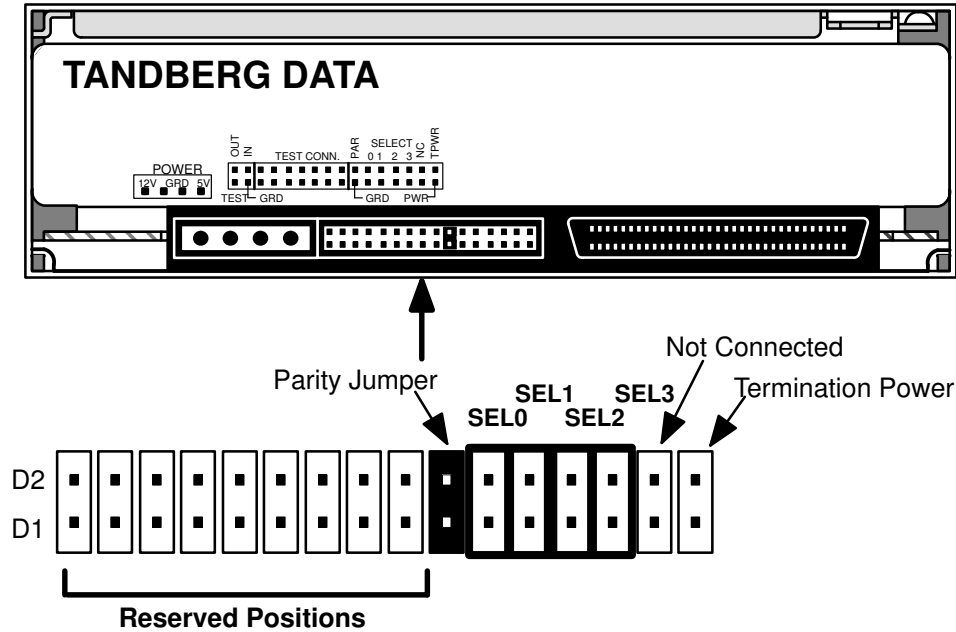

The MLR3 tape drive does not offer the possibility of enabling termination.

To set the SCSI ID, position jumpers on bits on the address option block as shown below.

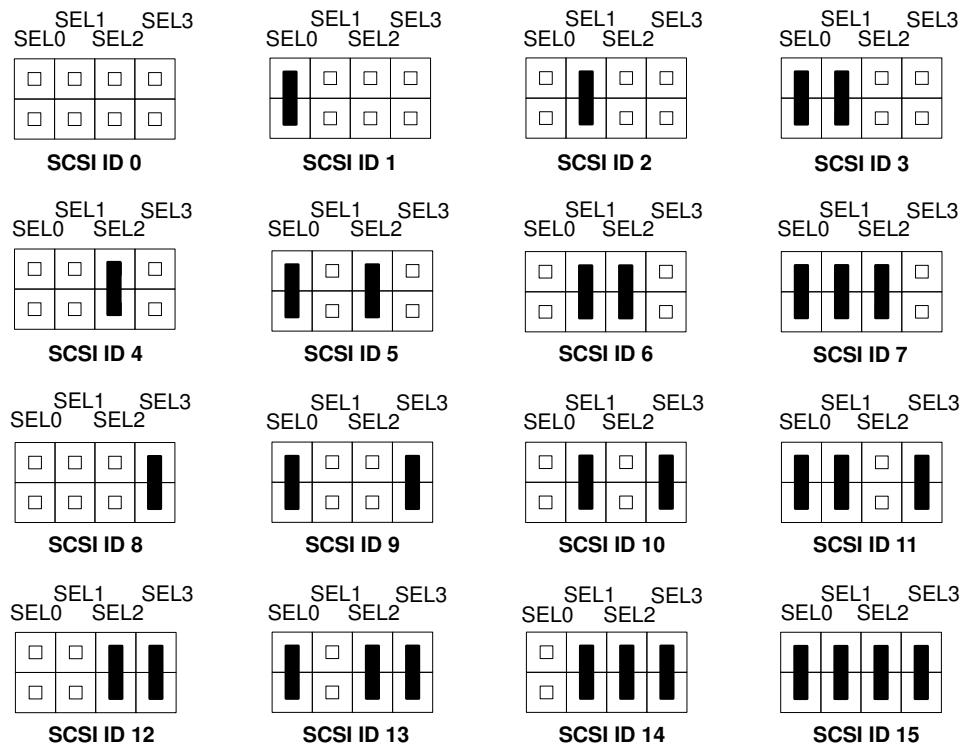

---

# Appendix A. Media and Tape Drive Compatibility

The following tables describe the compatibility between possible media and the tape drives offered on Bull systems. The information gives the read and write capacities as well as the density settings.

The tables are organised according to the tape type:

- DAT 4mm media, on page A-2.
- VDAT 8mm media, on page A-5.
- QIC media, on page A-8.
- DLT media, on page A-13.

## DAT 4mm Media Compatibility

Tapes without DDS (Digital Data Storage) and MRS (Medium Recognition System) are not supported on any drive. Make sure the DDS and MRS logos are visible on the cartridge.

Cleaning cartridge for all tape drives: Bull 6252.

### 4/8 GB CTD8000R Tape Drive

Type of Tape	Storage Parameters
<b>DDS1 60m Tape – Bull 3226</b>	Read in any density Write in 2.0 GB mode Capacity: 1.3 GB (2.6 GB compressed) Automatic Density Setting
<b>DDS1 90m Tape – Bull 3227</b>	Read in any density Write in 2.0 GB mode Capacity: 2 GB (4 GB compressed) Automatic Density Setting
<b>DDS2 120m Tape – Bull 3228</b>	Read in any density Write in 4.0 GB mode Capacity: 4 GB (8 GB compressed) Automatic Density Setting
<b>DDS3 125m Tape – Bull 3230</b>	Not Supported Cartridge is ejected <sup>1</sup> .

1. Many DDS2 4/8 GB tape drives are sent back for repair **only** because the wrong cartridge type (DDS3 125m) is used and is always rejected.

### 4/8GB HP C1533A or 4/16GB HP C1539A Tape Drives

Type of Tape	Storage Parameters
<b>DDS1 60m Tape – Bull 3226</b>	Read in any density Write in 2.0 GB mode Capacity: 1.3 GB (2.6 GB compressed) Automatic Density Setting
<b>DDS1 90m Tape – Bull 3227</b>	Read in any density Write in 2.0 GB mode Capacity: 2 GB (4 GB compressed) Automatic Density Setting
<b>DDS2 120m Tape – Bull 3228</b>	Read in any density Write in 4.0 GB mode Capacity: 4 GB (8 GB compressed) Automatic Density Setting
<b>DDS3 125m Tape – Bull 3230</b>	Not Supported Cartridge is ejected <sup>1</sup> .

1. Many DDS2 4/8 GB tape drives are sent back for repair **only** because the wrong cartridge type (DDS3 125m) is used and is always rejected.

## 4/8GB Archive Tape Drive

Type of Tape	Storage Parameters
<b>DDS1 60m Tape – Bull 3226</b>	Write/Read in 2.0 GB mode Capacity: 1.3 GB (2.6 GB compressed) Automatic Density Setting
<b>DDS1 90m Tape – Bull 3227</b>	Read in any density Write in 2.0 GB mode Capacity: 2 GB (4 GB compressed) Automatic Density Setting
<b>DDS2 120m Tape – Bull 3228</b>	Read in any density Write in 4.0 GB mode Capacity: 4 GB (8 GB compressed) Automatic Density Setting
<b>DDS3 125m Tape – Bull 3230</b>	Not Supported Cartridge is ejected <sup>1</sup> .

1. Many DDS2 4/8 GB tape drives are sent back for repair **only** because the wrong cartridge type (DDS3 125m) is used and is always rejected.

## 12/24GB HP C1537A Tape Drive

Type of Tape	Storage Parameters
<b>DDS1 60m Tape – Bull 3226</b>	Read in any density Write in 2.0 GB mode Capacity: 1.3 GB (2.6 GB compressed) Automatic Density Setting
<b>DDS1 90m Tape – Bull 3227</b>	Read in any density Write in 2.0 GB mode Capacity: 2 GB (4 GB compressed) Automatic Density Setting
<b>DDS2 120m Tape – Bull 3228</b>	Read in any density Write in 4.0 GB mode Capacity: 4 GB (8 GB compressed) Automatic Density Setting
<b>DDS3 125m Tape – Bull 3230</b>	Read in any density Write in 12.0 GB mode Capacity: 12 GB (24 GB compressed) Automatic Density Setting

## 12/24GB IBM Tape Drive

Type of Tape	Storage Parameters
<b>DDS1 60m Tape – Bull 3226</b>	Write/Read in 2.0 GB mode only Capacity: 1.3 GB (2.6 GB compressed) Density Setting = 19
<b>DDS1 90m Tape – Bull 3227</b>	Write/Read in 2.0 GB mode only Capacity: 2 GB (4 GB compressed) Density Setting = 19
<b>DDS2 120m Tape – Bull 3228</b>	Write/Read in 4.0 GB mode Capacity: 4 GB (8 GB compressed) Density Setting = 36
<b>DDS3 125m Tape – Bull 3230</b>	Write/Read in 12.0 GB mode Capacity: 12 GB (24 GB compressed) Density Setting = 37

## 20/40GB HP C5683A Tape Drive

Type of Tape	Storage Parameters
<b>DDS1 60m Tape – Bull 3226</b>	NOT SUPPORTED
<b>DDS1 90m Tape – Bull 3227</b>	READ-ONLY Capacity: 2 GB (4 GB compressed) Automatic Density Setting
<b>DDS2 120m Tape – Bull 3228</b>	Read in any density Write in 4.0 GB mode Capacity: 4 GB (8 GB compressed) Automatic Density Setting
<b>DDS3 125m Tape – Bull 3230</b>	Read in any density Write in 12.0 GB mode Capacity: 12 GB (24 GB compressed) Automatic Density Setting
<b>DDS4 150m Tape</b>	Read in any density Write in 20.0 GB mode Capacity: 20 GB (40 GB compressed) Automatic Density Setting

## V DAT 8mm Media Compatibility

### CAUTION:

- Consumer market tapes (for video cam recorders, etc.) are prohibited.
- Old cloth cleaning cartridges are prohibited.

We strongly recommend the use of SONY or Exabyte's Exatape products.

In this section, AME stands for Advanced Metal Evaporated, and MP for Metal Particle.

The density setting (smit menu or chdev command) is used to write a specific format. The drive automatically adjusts the mode in order to read a tape.

### 7/14 GB EXB8505XL Tape Drive

Type of Tape	Storage Parameters
<b>8mm, 54m (MP) Tape – Bull 3241 (SONY or Exatape)</b>	Write/Read in 8200 format Density Setting 20 Capacity: 1.2 GB native Write/Read in 8500 format Density Setting 140 Capacity: 2.4 GB native
<b>8mm, 112m (MP) Tape – Bull 3240 (SONY or Exatape)</b>	Write/Read in 8200 format Density Setting 20 Capacity: 2.5 GB native Write/Read in 8500 format Density Setting 140 Capacity: 5 GB native
<b>8mm, 160m (MP) Tape – Bull 3239 (SONY or Exatape)</b>	Write/Read in 8200 format Density Setting 20 Capacity: 3.5 GB native Write/Read in 8500 format Density Setting 140 Capacity: 7 GB native
<b>8mm, 22m (AME) Tape – Bull 3244 (SONY or Exatape)</b>	Not Supported Cartridge is ejected.
<b>8mm, 170m (AME) Tape – Bull 3243 (SONY or Exatape)</b>	Not Supported Cartridge is ejected.
<b>Cleaning Cartridge – P/N 309258 (PREMIUM)</b>	Used for only 18 cleaning operations. At the 19th attempt, the cartridge is ejected and no cleaning operation is made.
<b>Cleaning Cartridge – P/N 315205 (Mammoth)</b>	Not Supported Cartridge is ejected immediately.

## 7/14 GB EXB8705 or Eliant 820 Tape Drives

You can determine whether your 7/14 GB tape drive is an EXB8705 model or the newer Eliant 820 model in the following way:

EXB8505XL    Square LEDs and eject button.  
In the 'lscfg' data the '**Device Specific.(EE)**' field is blank.

Eliant 820    Round LEDs and eject button.

Type of Tape	Storage Parameters
<b>8mm, 54m (MP) Tape – Bull 3241 (SONY or Exatape)</b>	Read only in 8200 format and cartridge must be write protected Density Setting 20 Capacity: 1.2 GB, 8200 compressed is not supported Write/Read in 8500 format Density Setting 140 Capacity: 2.4 GB native
<b>8mm, 112m (MP) Tape – Bull 3240 (SONY or Exatape)</b>	Read only in 8200 format and cartridge must be write protected Density Setting 20 Capacity: 2.5 GB, 8200 compressed is not supported Write/Read in 8500 format Density Setting 140 Capacity: 5 GB native
<b>8mm, 160m (MP) Tape – Bull 3239 (SONY or Exatape)</b>	Read only in 8200 format and cartridge must be write protected Density Setting 20 Capacity: 3.5 GB native, 8200 compressed is not supported Write/Read in 8500 format Density Setting 140 Capacity: 7 GB native
<b>8mm, 22m (AME) Tape – Bull 3244 (SONY or Exatape)</b>	Not Supported Cartridge is ejected.
<b>8mm, 170m (AME) Tape – Bull 3243 (SONY or Exatape)</b>	Not Supported Cartridge is ejected.
<b>Cleaning Cartridge – P/N 309258 (PREMIUM)</b>	Used for only 18 cleaning operations. At the 19th attempt, the cartridge is ejected and no cleaning operation is made.
<b>Cleaning Cartridge – P/N 315205 (Mammoth)</b>	Not Supported Cartridge is ejected immediately.



## 20/40GB Mammoth Tape Drive

**Note:** The only media that can be used for write operations are Advanced Metal Evaporated (AME), as compared to old generation products which are Metal Particle (MP).

**CAUTION:**

**After having read an MP cartridge in a Mammoth tape drive, the drive must be cleaned prior to using an AME cartridge.**

Type of Tape	Storage Parameters
<b>8mm, 54m (MP) Tape – Bull 3241 (SONY or Exatape)</b>	Read only in 8200 format Density Setting 20 Capacity: 1.2 GB, 8200 compressed is not supported  Read only in 8500 format Density Setting 140 Capacity: 2.4 GB native
<b>8mm, 112m (MP) Tape – Bull 3240 (SONY or Exatape)</b>	Read only in 8200 format Density Setting 20 Capacity: 2.5 GB, 8200 compressed is not supported  Read only in 8500 format Density Setting 140 Capacity: 5 GB native
<b>8mm, 160m (MP) Tape – Bull 3239 (SONY or Exatape)</b>	Read only in 8200 format Density Setting 20 Capacity: 3.5 GB native, 8200 compressed is not supported  Read only in 8500 format Density Setting 140 Capacity: 7 GB native
<b>8mm, 22m (AME) Tape – Bull 3244 (SONY or Exatape)</b>	Write/Read in 8900 format Density Setting 39 Capacity: 2.5 GB native
<b>8mm, 170m (AME) Tape – Bull 3243 (SONY or Exatape)</b>	Write/Read in 8900 format Density Setting 39 Capacity: 20 GB native
<b>Cleaning Cartridge – P/N 309258 (PREMIUM)</b>	Not Supported Cartridge is ejected immediately.
<b>Cleaning Cartridge – P/N 315205 (Mammoth)</b>	Used for only 18 cleaning operations. At the 19th attempt, the cartridge is ejected and no cleaning operation is made.

---

## QIC Media Compatibility

All capacities are given as native capacities, i.e. without data compression (if data compression exists with the format).

### Cleaning cartridges

- Wet process cleaning kit for QIC 2.5/5 GB with a drive P/N tabulation 001 and 002.  
Bull 6249 – 50 cleaning operations
- Dry process cleaning cartridge for MLR1, MLR3 and QIC 2.5/5 GB with a drive P/N tabulation 1xx  
Bull 05678 – 50 cleaning operations

We strongly recommend the use of 3M/Imation QIC tapes because of their quality and manufacturing process.

**Note:** The media brand name of 3M has changed to Imation.

## 2.5/5 GB TDC 4222 Tape Drive

Type of Tape	Format Information	Storage Parameters
<b>3M DC600A – Bull 3203 600ft</b>	QIC120 format 15 tracks no servo no ECC no data compression	Write/Read Density Setting 15 Capacity: 120 MB
<b>3M DC6150 – Bull 3209 600ft<sup>1</sup></b>	QIC150 format 18 tracks no servo no ECC no data compression	Write/Read Density Setting 16 Capacity: 150 MB
<b>3M DC6525 Bull 3215 1020ft<sup>2</sup></b>	QIC525 format 26 tracks no servo with ECC no data compression	Write/Read Density Setting 17 Capacity: 525 MB
<b>3M Magnus 1.2 – Bull 3217 950ft<sup>3</sup></b>	QIC1000 format 30 tracks no servo with ECC no data compression	Write/Read Density Setting 21 Capacity: 1.2 GB
<b>3M Magnus 2.5 – Bull 3236 1200ft<sup>4</sup></b>	QIC 2GB format 42 tracks no servo with ECC with data compression	Write/Read Density Setting 34 Capacity: 2.5 GB
<b>SLR5 8GB – Bull 43474 1500ft</b>	QIC 4GB format 46 tracks no servo with ECC with data compression	Not supported Impossible to write/read data
<b>MLR 13GB – Bull 47023 1200ft</b>	QIC-5010-DC format 144 tracks 24 servo with ECC with data compression	Not supported Impossible to write/read data
<b>MLR 16GB – Bull 43473 1500ft</b>	QIC-5010-DC format 144 tracks 24 servo with ECC with data compression	Not supported Impossible to write/read data
<b>MLR3 25GB – Bull 43498 1515ft</b>	MLR3 25GB format 144 tracks 24 servo with ECC with data compression	Not supported Impossible to write/read data

1. DC6037 (150ft, 37 MB), and a DC6250 – Bull 3223 (1020ft, 250MB) also exists.
2. The shorter cartridge DC6320 – Bull 3213 (600ft, 320 MB) is no longer available.
3. The shorter cartridge Magnus 1.0 – Bull 3216 (760ft, 1.0 GB) is no longer available.
4. The shorter cartridge Magnus 2.0 (950ft, 2.0 GB) is no longer available.

## MLR1 13/26 GB Tape Drive

Type of Tape	Format Information	Storage Parameters
<b>3M DC600A – Bull 3203 600ft</b>	QIC120 format 15 tracks no servo no ECC no data compression	Write/Read Density Setting 15 Capacity: 120 MB
<b>3M DC6150 – Bull 3209 600ft<sup>1</sup></b>	QIC150 format 18 tracks no servo no ECC no data compression	Write/Read Density Setting 16 Capacity: 150 MB
<b>3M DC6525 Bull 3215 1020ft<sup>2</sup></b>	QIC525 format 26 tracks no servo with ECC no data compression	Write/Read Density Setting 17 Capacity: 525 MB
<b>3M Magnus 1.2 – Bull 3217 950ft<sup>3</sup></b>	QIC1000 format 30 tracks no servo with ECC no data compression	Write/Read Density Setting 21 Capacity: 1.2 GB
<b>3M Magnus 2.5 – Bull 3236 1200ft<sup>4</sup></b>	QIC 2GB format 42 tracks no servo with ECC with data compression	Write/Read Density Setting 34 Capacity: 2.5 GB
<b>SLR5 8GB – Bull 43474 1500ft</b>	QIC 4GB format 46 tracks no servo with ECC with data compression	Not supported Impossible to write/read data
<b>MLR 13GB – Bull 47023 1200ft</b>	QIC-5010-DC format 144 tracks 24 servo with ECC with data compression	Write/Read Density setting 33 Capacity: 13 GB
<b>MLR 16GB – Bull 43473 1500ft</b>	QIC-5010-DC format 144 tracks 24 servo with ECC with data compression	Not supported Impossible to write/read data
<b>MLR3 25GB – Bull 43498 1515ft</b>	MLR3 25GB format 144 tracks 24 servo with ECC with data compression	Not supported Impossible to write/read data

1. DC6037 (150ft, 37 MB), and a DC6250 – Bull 3223 (1020ft, 250MB) also exists.
2. The shorter cartridge DC6320 – Bull 3213 (600ft, 320 MB) is no longer available.
3. The shorter cartridge Magnus 1.0 – Bull 3216 (760ft, 1.0 GB) is no longer available.
4. The shorter cartridge Magnus 2.0 (950ft, 2.0 GB) is no longer available.

## MLR1 16/32 GB Tape Drive

Type of Tape	Format Information	Storage Parameters
<b>3M DC600A – Bull 3203 600ft</b>	QIC120 format 15 tracks no servo no ECC no data compression	Write/Read Density Setting 15 Capacity: 120 MB
<b>3M DC6150 – Bull 3209 600ft<sup>1</sup></b>	QIC150 format 18 tracks no servo no ECC no data compression	Write/Read Density Setting 16 Capacity: 150 MB
<b>3M DC6525 Bull 3215 1020ft<sup>2</sup></b>	QIC525 format 26 tracks no servo with ECC no data compression	Write/Read Density Setting 17 Capacity: 525 MB
<b>3M Magnus 1.2 – Bull 3217 950ft<sup>3</sup></b>	QIC1000 format 30 tracks no servo with ECC no data compression	Write/Read Density Setting 21 Capacity: 1.2 GB
<b>3M Magnus 2.5 – Bull 3236 1200ft<sup>4</sup></b>	QIC 2GB format 42 tracks no servo with ECC with data compression	Write/Read Density Setting 34 Capacity: 2.5 GB
<b>SLR5 8GB – Bull 43474 1500ft</b>	QIC 4GB format 46 tracks no servo with ECC with data compression	Write/Read Density setting 38 Capacity: 4 GB
<b>MLR 13GB – Bull 47023 1200ft</b>	QIC-5010-DC format 144 tracks 24 servo with ECC with data compression	Write/Read two tracks at a time Density setting 33 Capacity: 13 GB
<b>MLR 16GB – Bull 43473 1500ft</b>	QIC-5010-DC format 144 tracks 24 servo with ECC with data compression	Write/Read two tracks at a time Density setting 33 Capacity: 16 GB
<b>MLR3 25GB – Bull 43498 1515ft</b>	MLR3 25GB format 144 tracks 24 servo with ECC with data compression	Not supported Impossible to write/read data

1. DC6037 (150ft, 37 MB), and a DC6250 – Bull 3223 (1020ft, 250MB) also exists.
2. The shorter cartridge DC6320 – Bull 3213 (600ft, 320 MB) is no longer available.
3. The shorter cartridge Magnus 1.0 – Bull 3216 (760ft, 1.0 GB) is no longer available.
4. The shorter cartridge Magnus 2.0 (950ft, 2.0 GB) is no longer available.

## MLR3 25/50 GB Tape Drive

Type of Tape	Format Information	Storage Parameters
<b>3M DC600A – Bull 3203 600ft</b>	QIC120 format 15 tracks no servo no ECC no data compression	Not supported Impossible to write/read data
<b>3M DC6150 – Bull 3209 600ft<sup>1</sup></b>	QIC150 format 18 tracks no servo no ECC no data compression	Not supported Impossible to write/read data
<b>3M DC6525 Bull 3215 1020ft<sup>2</sup></b>	QIC525 format 26 tracks no servo with ECC no data compression	Not supported Impossible to write/read data
<b>3M Magnus 1.2 – Bull 3217 950ft<sup>3</sup></b>	QIC1000 format 30 tracks no servo with ECC no data compression	Not supported Impossible to write/read data
<b>3M Magnus 2.5 – Bull 3236 1200ft<sup>4</sup></b>	QIC 2GB format 42 tracks no servo with ECC with data compression	Read only Density Setting 34 Capacity: 2.5 GB
<b>SLR5 8GB – Bull 43474 1500ft</b>	QIC 4GB format 46 tracks no servo with ECC with data compression	Read only Density setting 38 Capacity: 4 GB
<b>MLR 13GB – Bull 47023 1200ft</b>	QIC-5010-DC format 144 tracks 24 servo with ECC with data compression	Write/Read two tracks at a time Density setting 33 Capacity: 13 GB
<b>MLR 16GB – Bull 43473 1500ft</b>	QIC-5010-DC format 144 tracks 24 servo with ECC with data compression	Write/Read two tracks at a time Density setting 33 Capacity: 16 GB
<b>MLR3 25GB – Bull 43498 1515ft</b>	MLR3 25GB format 144 tracks 24 servo with ECC with data compression	Write/Read two tracks at a time Density setting 48 Capacity: 25 GB

1. DC6037 (150ft, 37 MB), and a DC6250 – Bull 3223 (1020ft, 250MB) also exists.
2. The shorter cartridge DC6320 – Bull 3213 (600ft, 320 MB) is no longer available.
3. The shorter cartridge Magnus 1.0 – Bull 3216 (760ft, 1.0 GB) is no longer available.
4. The shorter cartridge Magnus 2.0 (950ft, 2.0 GB) is no longer available.

## DLT Media Compatibility

The cleaning cartridge for both drives is Bull Express P/N TK85HC for 20 cleaning operations.

### DLT4000 External Tape Drive

Type of Tape	Storage Parameters
<b>Maxell DLT Tape III</b> <b>(Bull Express P/N MXDLT85)</b> & <b>Quantum DLT Tape III</b> <b>(Bull Express P/N THXKC-01)</b>  <b>1200ft</b>	<b>Write/Read:</b> Density Setting 23 Capacity: 2.6 GB (24 track pairs, 42500 bpi) This is an old DEC format. Density Setting 24 Capacity: 6 GB (56 track pairs, 42500 bpi) This is an old DEC format. Density Setting 25 Capacity: 10 GB (64 track pairs, 62500 bpi)
<b>Maxell DLT Tape III XT</b> <b>(Bull Express P/N MXDLT87)</b> & <b>Quantum DLT Tape III XT</b> <b>(Bull Express P/N THXKE-01)</b>  <b>1828ft</b>	<b>Write/Read:</b> Density Setting 25 Capacity: 15 GB (64 track pairs, 62500 bpi)
<b>Maxell DLT Tape IV</b> <b>(Bull Express P/N MXDLT88)</b> & <b>Quantum DLT Tape IV</b> <b>(Bull Express P/N THXKD-01)</b> & <b>Fuji DLT Tape IV</b> <b>(Bull Express P/N DLT4060)</b>  <b>1828ft</b>	<b>Write/Read DLT4000 format:</b> Density Setting 26 Capacity: 20 GB (64 track pairs, 81633 bpi) A cartridge written in DLT7000 format is unreadable. A cartridge written in DLT7000 format can be over- written but in DLT4000 format.

## DLT7000 External Tape Drive

Type of Tape	Storage Parameters
<p>Maxell DLT Tape III (Bull Express P/N MXDLT85) &amp; Quantum DLT Tape III (Bull Express P/N THXKC-01)  1200ft</p>	<p><b>Write/Read:</b> Density Setting 23 Capacity: 2.6 GB (24 track pairs, 42500 bpi) This is an old DEC format. Density Setting 24 Capacity: 6 GB (56 track pairs, 42500 bpi) This is an old DEC format. Density Setting 25 Capacity: 10 GB (64 track pairs, 62500 bpi)</p>
<p>Maxell DLT Tape III XT (Bull Express P/N MXDLT87) &amp; Quantum DLT Tape III XT (Bull Express P/N THXKE-01)  1828ft</p>	<p><b>Write/Read:</b> Density Setting 25 Capacity: 15 GB (64 track pairs, 62500 bpi)</p>
<p>Maxell DLT Tape IV (Bull Express P/N MXDLT88) &amp; Quantum DLT Tape IV (Bull Express P/N THXKD-01) &amp; Fuji DLT Tape IV (Bull Express P/N DLT4060)  1828ft</p>	<p><b>Write/Read DLT7000 format:</b> Density Setting 27 Capacity: 35 GB (52 quad tracks, 85937 bpi) <b>Write/Read DLT4000 format:</b> Density Setting 26 Capacity: 20 GB (64 track pairs, 62500 bpi)</p>



## DLT8000E External Tape Drive

Type of Tape	Storage Parameters		
	Compression*	OFF	ON
<u>Maxell DLT Tape III</u> <b>Bull Express:</b> <b>P/N MXDLT85</b> <b>Plastic Color:</b> <b>Greyish Brown</b> <b>1200 ft</b>	Density Setting 25 <b>Native Capacity (GB)</b> <b>Native Transfer rate (MB/s)</b>	 <b>10</b> <b>1.5</b>	 <b>20</b> <b>3.0</b>
<u>Maxell DLT Tape III XT</u> <b>Bull Express:</b> <b>P/N MXDLT87</b> <b>Plastic Color:</b> <b>White</b> <b>1800 ft</b>	Density Setting 25 <b>Native Capacity (GB)</b> <b>Native Transfer rate (MB/s)</b>	 <b>15</b> <b>1.5</b>	 <b>30</b> <b>3.0</b>
<u>Maxell DLT Tape IV</u> <b>Bull Express:</b> <b>P/N MXDLT88</b> <b>&amp;</b> <u>Fuji DLT Tape IV</u> <b>Bull Express:</b> <b>P/N DLT4060</b>  <b>Plastic Color:</b> <b>Black</b> <b>1800 ft</b>	<b>DLT8000 format:</b> Density Setting 65 <b>Native Capacity (GB)</b> <b>Native Transfer rate (MB/s)</b>  <b>DLT7000 format:</b> Density Setting 27 <b>Native Capacity (GB)</b> <b>Native Transfer rate (MB/s)</b>  <b>DLT4000 format:</b> Density Setting 26 <b>Native Capacity (GB)</b> <b>Native Transfer rate (MB/s)</b>	 <b>40</b> <b>6.0</b>   <b>35</b> <b>5.0</b>   <b>20</b> <b>1.5</b>	 <b>80</b> <b>12.0</b>   <b>70</b> <b>10.0</b>   <b>40</b> <b>3.0</b>

\* With compression ON, the transfer rate noted is maximum value.



---

# Glossary

---

---

## Numbers

### 4X Speed

See also quad speed (CD-ROM).

### 12X Speed

See also twelve speed (CD-ROM).

### 14X–32X Speed

The base CD-ROM speed is for audio recordings. They now turn faster and faster to better handle multimedia. The 14X–32X Speed means that the device can be set to run fourteen times or thirty-two times the old audio speed.

### 80 Pin SCSI I/O and Power Connector

This connector contains all the connections for SCSI addressing and for the power supply to the device.

---

## A

### Address Block (or Address Option Block)

This term is used to designate a group (block) of pins on a connector, where the user can set different combinations of jumpers to set a SCSI address for a peripheral device.

### AIX

A version of the UNIX operating system developed by IBM.

### ANSI

American National Standards Institute.

---

## B

### Block Size

Block Size indicates the block size to use when reading or writing the tape. Larger records are useful when writing to unformatted tape because more data can be written. A value of **0** indicates variable length blocks. The allowable values and default values vary depending on the tape drive.

### BOT

Beginning of Tape.

---

## C

### CD-ROM

This abbreviation stands for Compact Disk-Read

Only Memory. These removable disks use optical storage technology to store up to 600 megabytes of data.

---

## D

### Data Compression

Setting this attribute to **yes** causes the tape drive to write data to the tape in compressed format so that more data fits on a single tape. Setting this attribute to **no** forces the tape drive to write in native mode (non-compressed). The default setting is **yes**.

### Delay Motor Start

Computer systems must be set up so that many disk drive motors are not started at the same instant with the risk of provoking a voltage drop. In some configurations it is necessary to set a jumper on the disk drive to do this. This jumper position is called Delay Motor Start.

### Device Buffers

This tape drive attribute can be set to yes or no. Setting it to **yes** indicates that an application is notified of write completion after the data has been transferred to the data buffer of the tape drive, but not necessarily after the data is actually written to the tape. If you specify the **no** value, an application is notified of write completion only after the data is actually written to the tape. Streaming mode cannot be maintained for reading or writing if this attribute is set to **no**. The default value is **yes**. With the **no** value, the tape drive will be slower but have more complete data in the event of a power outage or system failure and allow better handling of end-of-media conditions.

### Density Setting

Density Setting #1 sets the density value that the tape drive will write when using special files `/dev/rmt*`, `/dev/rmt*.1`, `/dev/rmt*.2`, `/dev/rmt*.3`, and Density Setting #2 is for special files `/dev/rmt*.4`, `/dev/rmt*.5`, `/dev/rmt*.6`, `/dev/rmt*.7`. These settings are decimal numbers **0** to **255**. A zero (**0**) setting selects the default density for the tape drive which is usually the drive's high density setting. It is customary to set Density Setting #1 to the highest density possible and Density Setting #2 to the second highest density possible on the drive.

### Differential Ended (DE)

Differential Ended electrical transmission on the bus.

---

## E

### ECMA

European association for standardizing information and communication systems. It is an international industrial association dedicated to the standardization of information and communication systems.

### Error Correction Code (ECC)

This method is used to deal with corrupted data. Parity bits are added to the data in order to detect errors and reconstruct the data when errors are found.

### Extended File Marks

Setting this attribute to **no** writes regular file marks to the tape. Setting it to **yes** writes an extended file mark. The default value is **no**. Extended file marks on 8mm tape drives use 2.2MB of tape and can take up to 8.5 seconds to write. Regular file marks use 184K and take approximately 1.5 seconds to write. On 8mm tapes, use Extended File marks in append mode to reduce errors.

---

## G

### GB

Gigabyte (1,000,000,000 bytes)

---

## I

### IEC

International Electrotechnical Commission. IEC is dedicated to promoting standardization in the fields of electricity, electronics and related technologies.

### IPL

Initial Program Load. It defines the firmware functional phases during the system initialization.

### ISO

International Organization for Standardization. ISO is a worldwide federation of national standards bodies which aims at promoting international standards agreements published as International Standards.

---

## L

### LVD

Low Voltage Differential. LVD and Ultra2 SCSI are used interchangeably. LVD provides SCSI bus rates of 80 Mbytes/sec.

---

## M

### MB

Megabyte (1,000,000 bytes)

---

## P

### Parity Jumper

This jumper sets the connection that tells the drive to report any data defaults indicated by the parity checking.

### Power Cable Connector

This is the connector for the DC power to the device.

---

## Q

### Quad Speed

The base CD-ROM speed is for audio recordings. They now turn faster and faster to better handle multimedia. Quad Speed is four times the old audio speed. Also referred to as 4X.

### QIC

This abbreviation stands for Quarter Inch Committee, the international committee that sets the standards for this type of tape.

---

## R

### Retension

Setting this attribute to **yes** instructs the tape drive to retension a tape automatically whenever a tape is inserted or the drive is reset. *Retensioning* a tape means to wind to the end of the tape and then rewind to the beginning of the tape to even the tension throughout the tape. Retensioning the tape can reduce errors, but this action can take several minutes. If you specify the **no** value, the tape drive does not automatically retension the tape. The default value is **yes**.

### Reserve Support

Specifying the **yes** value causes the tape drive to be reserved on the SCSI bus while it is open. If more than one SCSI adapter shares the tape device, this ensures access by a single adapter while the device is open.

---

## S

### SCSI

Small Computer Systems Interface is a standard parallel interface designed to communicate with intelligent peripheral devices.

### SCSI-2

An improved SCSI enabling communications between devices from different manufacturers. SCSI-2 can use an 8, 16 or 32 bit data path.

### SCSI-3

Also known as Ultra SCSI, SCSI-3 is an improved SCSI enabling data rates up to 40 Mbytes/sec. Ultra2 is a faster subset of SCSI-3.

### SCSI Address

The SCSI Address, also referred to as the SCSI ID, is unique for each SCSI peripheral and enables the hardware to contact each individual device.

### SCSI Bus

The SCSI bus is the bus where the peripherals using the SCSI interface are connected.

### SCSI Cable Connector

This is the connection for the data cable that connects the drive to the computer.

### SCSI ID

The SCSI ID enables the hardware to contact each individual SCSI peripheral device. See SCSI Address.

### SCSI ID Connector

This is the connector at the rear of a disk or tape unit that contains the SCSI ID Address Option Block.

### Single Ended (SE)

Single Ended electrical transmission on the bus: the signal and the ground.

### SMIT

System Management Interface Tool. Menu-driven, AIX resident command-building system management facility.

---

## T

### Terminator

A terminator is a male or female connector that completes the electrical circuit on the SCSI buses.

### Twelve Speed

This term refers to the speed at which a CD-ROM drive turns the disk. Also referred to as 12X. See "Quad Speed".

---

## U

### Ultra2 SCSI

A subset of SCSI-3, allowing bus data transfer rates of up to 80 Mbytes/sec. See also LVD.

### UNIX

Portable operating system, implemented in "C" language (AT&T). Trademark of X/Open Co.

---

## V

### Variable Length Block Size

This attribute specifies the block size required by the tape drive when writing variable length records. The Block Size attribute is set to **0** to indicate variable length records.



---

# Index

## Numbers

1 GB Disk Drive, 4-2, 4-3  
1.44MB Diskette Drive, 2-2, 2-3  
1/4 Inch Tape Drive, 5-13, 5-15, 5-19  
12/24 GB 4mm Tape Drive, 5-5  
12X CD-ROM Drive, 3-3  
13.8X/32X Speed CD-ROM Drive, 3-4  
13/26 GB 1/4 Inch Tape Drive, 5-15  
13/32 GB 1/4 Inch Tape Drive, 5-15  
17X/40X Speed CD-ROM Drive, 3-4  
18.2GB Disk Drive, 4-13, 4-15  
2 GB Disk Drive, 4-2  
2.1 GB Disk Drive, 4-3, 4-4, 4-5, 4-6  
2.5/5 GB 1/4 Inch Tape Drive, 5-13  
20/40 GB 4mm Tape Drive, 5-7  
25/50 GB 1/4 Inch Tape Drive, 5-19  
3.5 Inch Diskette Drives, 2-1  
32X Speed CD-ROM Drive, 3-4  
4.2 GB Disk Drive, 4-7, 4-8  
4.3 GB Disk Drive, 4-16, 4-17, 4-18  
4/8 GB 4mm Tape Drive, 5-2, 5-3  
40X Speed CD-ROM Drive, 3-4  
40X/10X CD/DVD-ROM Drive, 3-5  
41X-32X Speed CD-ROM, G-1  
4mm Tape Drive, 5-2, 5-3, 5-5, 5-7  
4mm4gb, 5-2  
4X CD-ROM Drive, 3-2  
7/14 GB 8mm Tape Drive, 5-9, 5-11  
80 Pin SCSI I/O & Pwr Connector, G-1  
8mm Tape Drive, 5-9, 5-11  
9.1 GB Disk Drive, 4-9, 4-10, 4-19, 4-20  
9.1GB Disk Drive, 4-11, 4-12, 4-14

## A

Add-On, iii  
Address Block, G-1  
AIX, iii, G-1  
Antistatic Wrist Strap, 1-1  
Attributes, Tape Drives, 5-1

## B

Block Size, 5-3, 5-5, 5-7, 5-9, 5-11, 5-13, 5-15, 5-19, G-1  
BOT (Beginning of Tape), 5-13, 5-16, 5-19  
Bus Length, General Guidelines, 1-3

## C

Cabling, SCSI, General Considerations, 1-3  
Cartridge Tape Drive, 1-7  
CD-ROM, G-1  
CD-ROM Drive  
    Drive Configuration, 3-1  
    Eject Hole, 3-1  
    Emergency Eject Hole, 3-1  
    Installation, 3-1  
CD-ROM Drives, 1-1  
    System Identification Table, 1-6

CD/DVD-ROM, 3-5  
CD-ROM Drives, 3-1  
chdev command, 5-1  
Controller Access Time, 1-4  
CTD 8000R, 1-7, 5-2

## D

Data Compression, 5-3, 5-5, 5-7, 5-9, 5-11, 5-13, 5-16, 5-19, G-1  
DDS, 5-3, 5-5, 5-7  
DDS Logo, 5-3, 5-5, 5-7  
DDS||||, 5-3, 5-5, 5-7  
DDS1, 5-3  
DDS2, 5-3, 5-5, 5-7  
DDS3, 1-7, 5-3, 5-5, 5-7  
DDS4, 5-7  
Delay Motor Start, G-1  
Density Setting, 5-3, 5-5, 5-7, 5-9, 5-11, 5-13, 5-16, 5-19, G-1  
Device Buffers, 5-3, 5-5, 5-7, 5-9, 5-11, 5-13, 5-15, 5-19, G-1  
Differential Ended (DE), 1-7, G-1  
Disk Drive Description, 1-5, 1-6  
Disk Drives, 4-1  
    System Identification Table, 1-5  
Diskette Drives, 1-1, 2-1  
    Configuration, 2-1  
    Installation, 2-1  
Drives, General Installation Instructions, 1-2  
DVD drive, 3-5

## E

ECC, G-2  
ECMA, G-2  
Emergency Eject Hole, 3-1  
Error Correction Code, G-2  
EXB 8505XL, 1-7, 5-9  
EXB 8705, 1-7, 5-11  
Extended File Marks, 5-9, 5-11, 5-13, 5-16, 5-19, G-2

## F

Floppy Drives, 1-1, 2-1  
Forty Speed CD-ROM Drive, 3-4

## G

Gigabyte (GB), 1-6, 1-7, G-2

## H

Hard Disk Drives, 1-1, 4-1  
Height Form Factor, 1-5, 1-6  
HP C1533A, 1-7, 5-3  
HP C1537A, 1-7, 5-5  
HP C1539A, 1-7, 5-3  
HP C5683A, 5-7

**I**  
 IEC, G-2  
 Installation  
   CD-ROM Drives, 3-1  
   Diskette Drives, 2-1  
   General Instructions, 1-2  
 IPL, G-2  
 ISO, G-2

**J**  
 Jumper, iii, 1-2

**L**  
 Isattr command, 5-1  
 LVD, G-2

**M**  
 Manufacturer ID No., 1-5, 1-6, 1-7  
 Megabyte (MB), 1-6, G-2  
 MLR1, 1-7, 5-15  
 MLR3, 1-7, 5-19  
 MPF 920-E, 1-5, 2-3

**N**  
 N (narrow – 8bits), 1-6  
 Non-DDS, 5-3, 5-5, 5-7  
 Nstor Cabinet, 1-5

**O**  
 Overload Protection, 1-4

**P**  
 Parity Jumper, G-2  
 Power Cable Connector, G-2

**Q**  
 QIC (Quarter Inch Committee), 1-7, G-2  
 Quad Speed CD-ROM Drive, 3-2, G-2

**R**  
 Reserve Support, 5-3, 5-5, 5-8, 5-13, 5-16, 5-19,  
   G-2  
 Retension, 5-13, 5-16, 5-19, G-2  
 Rotation Speed, 1-5, 1-6

**S**  
 SCSI, iii, G-3  
   Bus Length, 1-3  
 SCSI Address, 1-2, 1-3  
 SCSI Bus, G-3  
 SCSI Cable Connector, G-3  
 SCSI ID, 1-2, 1-3, G-3  
 SCSI ID Connector, G-3  
 SCSI-2, G-3  
 SCSI-3, G-3  
 SD M1401, 3-5  
 SD M1402, 1-6  
 Single Connector Attachment, 1-6  
 Single Ended (SE), 1-6, G-3  
 SMIT (Systems Management Interface Tool), G-3  
 SMIT Menus, 5-1

ST 15150N, 1-5, 4-18  
 ST 15150W, 1-5, 4-17  
 ST 15230N, 1-5, 4-16  
 ST 19171W, 1-5, 4-19  
 ST 19171WC, 1-5, 4-20  
 ST 31051N, 1-5, 4-2  
 ST 31051WC, 1-5, 4-3  
 ST 318203LC, 1-5  
 ST 318275LC, 1-5  
 ST 32151N, 1-5, 4-2  
 ST 32151WC, 1-5, 4-3  
 ST 32171W, 1-5, 4-5  
 ST 32171WC, 1-5, 4-6  
 ST 32272W, 1-5, 4-5  
 ST 32272WC, 1-5, 4-6  
 ST 32550N, 1-5, 4-4  
 ST 34371W, 1-5, 4-7  
 ST 34371WC, 1-5, 4-8  
 ST 34572W, 1-5, 4-7  
 ST 34572WC, 1-5, 4-8  
 ST 34573W, 1-5, 4-7  
 ST 34573WC, 1-5, 4-8  
 ST 39103LC, 1-5  
 ST 39173W, 1-5, 4-9  
 ST 39173WC, 1-5  
 ST 39175LC, 1-5  
 ST 39175LW, 1-5  
 ST 39175LW, ST 39236LW, 4-10  
 ST 318203LC, ST 318404LC, ST 318406LC, 4-15  
 ST 318275LC, ST 318436LC, 4-13  
 ST 318404LC, ST 318406LC, 1-5  
 ST 318436LC, 1-5  
 ST 39103LC, ST 39204LC, 4-14  
 ST 39173WC, 4-11  
 ST 39175LC, ST 39236LC, 4-12  
 ST 39204LC, 1-5  
 ST 39236LC, 1-5  
 ST 39236LW, 1-5  
 Static Sensitive, 1-1  
 Switch Settings, iii, 1-2, 5-4, 5-6, 5-8

**T**  
 Tape Drive  
   Bull 12.0 GB 4mm Tape Drive, 5-5  
   Bull 16 GB 1/4 Inch Tape Drive, 5-15  
   Bull 2.5 GB 1/4 Inch Tape Drive, 5-13  
   Bull 20.0 GB 4mm Tape Drive, 5-7  
   Bull 25/50 GB 1/4 Inch MLR3 Tape, 5-19  
   Bull 4.0 GB 4mm Tape Drive, 5-3  
   Bull 7/14 GB 8mm Tape Drive, 5-11  
   Bull 7/14 GB Tape Drive, 5-9  
   Bull13gb-c, 5-15  
   Bull2500mb-c, 5-13  
   Bull25gb-c, 5-19  
   Bull4mm24gb, 5-5  
   Bull4mm40gb, 5-7  
   Bull4mm4gb, 5-3  
   Bull8mm5gb, 5-9, 5-11  
   System Identification Table, 1-7  
 Tape Drive Attributes, 5-1  
 Tape Drives, 1-1, 5-1  
 TDC 4222, 1-7, 5-13  
 Terminator, G-3



Terminator Power, 1-4  
Thirty two Speed CD-ROM Drive, 3-4  
Twelve Speed CD-ROM Drive, 3-3, G-3

## **U**

Ultra2 SCSI, G-3  
UNIX, iii, G-3  
Unix System, 1-5, 1-6, 1-7  
Unpacking Instructions, 1-1

## **V**

Variable Length Block Size, 5-3, 5-5, 5-8, 5-13,  
5-16, 5-19, G-3

## **W**

W (wide – 16bits), 1-6  
WC, 1-6

## **X**

XL (extra length – tape), 1-7  
XM 5401B, 1-6, 3-2  
XM 5701B, 1-6, 3-3  
XM 6201B, 1-6, 3-4  
XM 6401B, 1-6, 3-4

## **Y**

YD-702D, 1-5, 2-2



## Technical publication remarks form

<b>Title :</b> ESCALA Disks and Tapes Configuration Information
---

<b>Reference N° :</b> 86 A1 88GX 16
-------------------------------------

<b>Date:</b> October 2001
---------------------------

### ERRORS IN PUBLICATION

--

### SUGGESTIONS FOR IMPROVEMENT TO PUBLICATION

--

Your comments will be promptly investigated by qualified technical personnel and action will be taken as required.  
If you require a written reply, please include your complete mailing address below.

NAME : \_\_\_\_\_ Date : \_\_\_\_\_

COMPANY : \_\_\_\_\_

ADDRESS : \_\_\_\_\_

Please give this technical publication remarks form to your BULL representative or mail to:

Bull - Documentation D<sup>é</sup>pt.  
1 Rue de Provence  
BP 208  
38432 ECHIROLLES CEDEX  
FRANCE  
info@frec.bull.fr

# Technical publications ordering form

To order additional publications, please fill in a copy of this form and send it via mail to:

**BULL CEDOC**  
**357 AVENUE PATTON**  
**B.P.20845**  
**49008 ANGERS CEDEX 01**  
**FRANCE**

**Phone:** +33 (0) 2 41 73 72 66  
**FAX:** +33 (0) 2 41 73 70 66  
**E-Mail:** [srv.Duplicopy@bull.net](mailto:srv.Duplicopy@bull.net)

CEDOC Reference #	Designation	Qty
-- -- [ ]		
-- -- [ ]		
-- -- [ ]		
-- -- [ ]		
-- -- [ ]		
-- -- [ ]		
-- -- [ ]		
-- -- [ ]		
-- -- [ ]		
-- -- [ ]		
-- -- [ ]		
[ ] : The latest revision will be provided if no revision number is given.		

NAME: \_\_\_\_\_ Date: \_\_\_\_\_

COMPANY: \_\_\_\_\_

ADDRESS: \_\_\_\_\_

PHONE: \_\_\_\_\_ FAX: \_\_\_\_\_

E-MAIL: \_\_\_\_\_

**For Bull Subsidiaries:**

Identification: \_\_\_\_\_

**For Bull Affiliated Customers:**

Customer Code: \_\_\_\_\_

**For Bull Internal Customers:**

Budgetary Section: \_\_\_\_\_

**For Others: Please ask your Bull representative.**



**BULL CEDOC**  
**357 AVENUE PATTON**  
**B.P.20845**  
**49008 ANGERS CEDEX 01**  
**FRANCE**

REFERENCE  
**86 A1 88GX 16**

Utiliser les marques de découpe pour obtenir les étiquettes.  
Use the cut marks to get the labels.

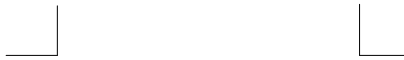

Disks and Tapes  
Configuration  
Information

86 A1 88GX 16

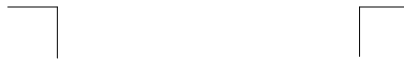

Disks and Tapes  
Configuration  
Information

86 A1 88GX 16



Disks and Tapes  
Configuration  
Information

86 A1 88GX 16



