

NovaScale 5xx5

Installation Guide

NOVASCALE



REFERENCE
86 A1 40EM 06

NOVASCALÉ

NovaScale 5xx5

Installation Guide

Hardware

September 2007

BULL CEDOC
357 AVENUE PATTON
B.P.20845
49008 ANGERS CEDEX 01
FRANCE

REFERENCE
86 A1 40EM 06

The following copyright notice protects this book under Copyright laws which prohibit such actions as, but not limited to, copying, distributing, modifying, and making derivative works.

Copyright © Bull SAS 1992, 2007

Printed in France

Suggestions and criticisms concerning the form, content, and presentation of this book are invited. A form is provided at the end of this book for this purpose.

To order additional copies of this book or other Bull Technical Publications, you are invited to use the Ordering Form also provided at the end of this book.

Trademarks and Acknowledgements

We acknowledge the right of proprietors of trademarks mentioned in this book.

Intel® and Itanium® are registered trademarks of Intel Corporation.

Windows® and Microsoft software® are registered trademarks of Microsoft Corporation.

UNIX® is a registered trademark in the United States of America and other countries licensed exclusively through the Open Group.

Linux® is a registered trademark of Linus Torvalds.

The information in this document is subject to change without notice. Bull will not be liable for errors contained herein, or for incidental or consequential damages in connection with the use of this material.

Preface

Table of Contents

Intended Readers	xi
Highlighting, Abbreviations and Acronyms	xi
Related Publications	xii
Regulatory Specifications and Disclaimers	xiii
Declaration of the Manufacturer or Importer	xiii
Safety Compliance Statement	xiii
European Community (EC) Council Directives	xiii
Federal Communications Commission (FCC) Statement	xiv
FCC Declaration of Conformity	xiv
Canadian Compliance Statement (Industry Canada)	xiv
Laser Compliance Notice	xiv
Definition of Safety Notices	xv
Electrical Safety	xv
Laser Safety Information	xvi
Data Integrity and Verification	xvi
Waste Management	xvi
Environmental Standards	xvii
Climatic and Atmospheric Specifications	xvii
Electrical Specifications	xvii
Electromagnetic Compatibility	xvii
Protection against Electrostatic Discharges	xviii
Shocks and Vibrations	xviii
Pollution Limits	xix
Audio-Noise Limits	xix
Safety Specifications	xix
Installation Flowchart	xxi
Chapter 1. Delivery	1-1
Bull Novascale Server Overview	1-2
Dynamic Partitioning	1-2
Extended Configurations	1-2
Cluster Configurations	1-2
Server Features	1-3
Server Hardware	1-4
Central SubSystem Module (CSS Module)	1-4
Front Unit	1-4
Core Unit	1-4
Rear Unit	1-5
Platform Administration Processor (PAP) Unit	1-5
KVM Switch	1-5
Console	1-5
Disk Subsystem	1-5
Additional Peripherals	1-5

Server Firmware and Software	1-5
Conformance to Standards	1-6
General Recommendations	1-7
Unpacking the Server Cabinet	1-8
Inspecting the Server before Unloading the Cabinet	1-8
Removing CSS Module Brackets and Installing Stoppers	1-9
Removing CSS Module Shipping Brackets	1-9
Installing Stoppers	1-10
Inspecting Internal Components and Cabling	1-11
Getting to Know the Server	1-12
NovaScale 5085 Partitioned Server	1-12
NovaScale 5165 Partitioned Server	1-13
NovaScale 5245 Partitioned Server	1-14
NovaScale 5325 Partitioned Server	1-15
Server Components	1-17
Central Subsystem (CSS) Module	1-18
Integrated Platform Administration Processor (PAP) Unit	1-19
Integrated Console	1-20
Keyboard / Video / Mouse (KVM) Switch	1-21
8-Port KVM Switch	1-21
16-Port KVM Switch	1-21
KVM Extender	1-21
FDA 1x00 FC Disk Rack	1-22
FDA 2x00 FC Disk Rack	1-22
FDA 1x00 FC Extension Disk Rack	1-23
Ethernet Hub	1-24
USB Modem	1-24
NPort Server	1-24
Chapter 2. Setup Procedure	2-1
Accessing Server Components	2-2
Opening the Front Door	2-2
Closing the Front Door	2-2
Opening / Closing the Integrated Console	2-3
Checking PMB Code Wheel Settings	2-4
Checking Server Cabling	2-5
Connecting the Server to the Site Power Supply	2-5
Safety Recommendations	2-5
Powering Up the Server to the Standby Mode	2-5
Checking Server Operation	2-6
Launching PAM Software	2-6
PAM User Interface	2-8
Checking Server Status via PAM	2-9
PAM Status Pane	2-9
PAM Control Pane	2-9
CSS Availability Status Bar	2-10
PAM Tree Pane	2-10
Toggling the Local / Integrated Console Display	2-12
Testing CSS Module Ring Connections	2-13
Powering Up / Down Server Domains	2-16
Powering Up the NovaScale 5xx5 SMP Server Domain	2-16
Shutting Down / Restarting the Server	2-17
Powering Up NovaScale 5xx5 Partitioned Server Domains	2-18
Shutting Down / Restarting the Server	2-21
Changing the iStorage Manager User Name and Password	2-22

Changing the S@N.IT Password	2-23
Completing PAP Unit Configuration	2-24
Changing the Default PAP Unit Name	2-24
Launching the PAP Configuration Setup Wizard	2-24
Configuring Customer Information	2-29
Configuring Autocalls	2-30
Connecting the PAP Unit to the Customer's Enterprise LAN	2-32
Connecting to the PAM Web Site from a Remote Computer/Workstation	2-33
Enabling Remote Access to the PAM Web Site with Internet Explorer	2-33
Enabling Remote Access to the PAM Web Site with Mozilla	2-33
Enabling Remote Access to iSM on the Client Computer	2-34
Completing Operating System Setup	2-35
NovaScale 5xx5 SMP Servers - Operating System Setup	2-36
Microsoft Windows Setup	2-37
Linux RedHat Setup	2-38
Novell SuSe Setup	2-39
NovaScale 5xx5 Partitioned Server - Operating System Setup	2-40
Microsoft Windows Setup	2-41
Linux RedHat Setup	2-42
Novell SuSe Setup	2-43
Connecting the Server to the Enterprise LAN	2-44
Connecting the USB Modem and External Devices	2-45
Connecting the USB Modem	2-45
Connecting External Storage Peripherals	2-45
Testing Network Connections	2-46
Testing Autocalls	2-46
Completing the PAM Installation Intervention Report	2-46
Renaming a Central Subsystem	2-47
Removing / Adding a Central Subsystem	2-47
Setting up PAP Unit Users	2-49
Predefined PAP User Groups	2-49
Initializing the PAP Unit Backup Disk	2-51
Backing Up and Restoring PAM Configuration Files	2-54
Backing Up PAM Configuration Files	2-54
Restoring PAM Configuration Data	2-55
Appendix A. Specifications	A-1
NovaScale 5085 Server Specifications	A-2
NovaScale 5165 Server Specifications	A-4
NovaScale 5245 Server Specifications	A-6
NovaScale 5325 Server Specifications	A-8
Appendix B. Conversion, Keyboard, and Writing Tables	B-1
Imperial to Metric	B-1
Metric to Imperial	B-1
Celsius to Fahrenheit Conversion	B-1
Fahrenheit to Celsius Conversion	B-1
AZERTY/QWERTY Keyboard Lookup Table	B-2
PAM Writing Rules	B-3
Illegal Characters	B-3
String Lengths	B-4
Registry Keys	B-4
Glossary	G-1

Index

X-1

List of Figures

Figure 1.	Bull NovaScale Server cabinets	1-2
Figure 2.	Removing front shipping brackets	1-9
Figure 3.	Removing rear shipping brackets.	1-9
Figure 4.	Installing front stoppers	1-10
Figure 5.	Installing rear stoppers.	1-10
Figure 6.	NovaScale 5085 Partitioned Server components - example	1-12
Figure 7.	NovaScale 5165 Partitioned Server components - example	1-13
Figure 8.	NovaScale 5245 Partitioned Server components - example	1-14
Figure 9.	NovaScale 5325 Partitioned Servers components - example	1-15
Figure 10.	NovaScale 5325 Partitioned Servers components - example	1-16
Figure 11.	CSS module features (full CSS module example)	1-18
Figure 12.	PAP unit	1-19
Figure 13.	Integrated console features	1-20
Figure 14.	8-port KVM switch features	1-21
Figure 15.	16-port KVM switch features	1-21
Figure 16.	KVM extender (local & remote) 300m maxi.	1-21
Figure 17.	FDA 1x00 FC disk rack features	1-22
Figure 18.	FDA 2x00 FC disk rack features	1-22
Figure 19.	FDA 1x00 FC extension disk rack features	1-23
Figure 20.	Ethernet hub features	1-24
Figure 21.	USB modem features	1-24
Figure 22.	NPort Server features	1-24
Figure 23.	Opening the front door	2-2
Figure 24.	Integrated console example	2-3
Figure 25.	PMB code wheel settings	2-4
Figure 26.	PAM user interface	2-8
Figure 27.	Status pane	2-9
Figure 28.	CSS Module availability status bar (bi-module server)	2-10
Figure 29.	PAM Tree toolbar	2-11
Figure 30.	Domain schemes list dialog	2-13
Figure 31.	Default domain loaded	2-14
Figure 32.	Advanced properties dialog	2-14
Figure 33.	Domain Manager Control pane	2-16
Figure 34.	Domain state	2-17
Figure 35.	Domain schemes list dialog	2-19
Figure 36.	Domain Manager Control pane - example with 4 domains	2-20
Figure 37.	Multiple power dialog - example with 4 domains	2-20
Figure 38.	Domain state - example with 4 domains	2-20
Figure 39.	PAP configuration wizard dialog	2-25
Figure 40.	Release type dialog	2-25
Figure 41.	Network configuration dialog	2-26
Figure 42.	Users configuration dialog	2-26
Figure 43.	PAM configuration via Web site dialog	2-27
Figure 44.	SAN software identities configuration dialog	2-27
Figure 45.	Customer Information configuration page	2-29
Figure 46.	Autocalls Channel Settings control pane	2-30

Figure 47. PAP unit free Ethernet port	2-32
Figure 48. 10/100/1000 Mb/s LAN port	2-44
Figure 49. Central Subsystem control pane	2-47
Figure 50. Central Subsystem node	2-48
Figure 51. Launching Adaptec Storage Manager	2-51
Figure 52. Displaying PAP Unit disk configuration	2-52
Figure 53. Rebooting the PAP Unit	2-52
Figure 54. Removing the right disk	2-52
Figure 55. Blank disk building process	2-53
Figure 56. AZERTY keyboard	B-2
Figure 57. QWERTY keyboard	B-2

List of Tables

Table 1.	PAM Tree nodes	2-10
Table 2.	KVM port configuration	2-12
Table 3.	PMB code wheel settings - multiple server configuration example	2-48
Table 4.	User access to PAM features	2-50
Table 5.	NovaScale 5085 Server specifications	A-3
Table 6.	NovaScale 5165 Server specifications	A-5
Table 7.	NovaScale 5245 Server specifications	A-7
Table 8.	NovaScale 5325 Server specifications	A-9
Table 9.	Imperial to metric conversion table	B-1
Table 10.	Metric to imperial conversion table	B-1
Table 11.	PAM illegal characters	B-3
Table 12.	String length rules	B-4

Intended Readers

This guide is intended for use by qualified personnel in charge of setting up and starting NovaScale 5xx5 Servers for the first time.

It will also prove useful to qualified personnel in charge of setting up and starting Bull NovaScale 7000 Series and Bull NovaScale 9000 Series servers for the first time.

Chapter 1. *Delivery*

describes server features and explains delivery unpacking and inspection procedures.

Chapter 2. *Setup Procedure*

explains the procedures required to set up and start the server for the first time.

Appendix A. *Specifications*

Appendix B. *Conversion Tables*

Highlighting, Abbreviations and Acronyms

The following highlighting conventions are used in this guide:

Bold	Identifies predefined commands, subroutines, keywords, files, structures, buttons, labels, and icons.
<i>Italics</i>	Identifies referenced publications, chapters, sections, figures, and tables.
< >	Identifies parameters to be supplied by the user.

Abbreviations, acronyms and concepts are documented in the *Glossary*.

Related Publications

Site Preparation Guide, 86 A1 87EF

explains how to prepare a Data Processing Center for Bull NovaScale Servers, in compliance with the standards in force. This guide is intended for use by all personnel and trade representatives involved in the site preparation process.

User's Guide, 86 A1 41EM

explains how to use NovaScale 5xx5 Servers. This guide is intended for use by Customer Administrators and Operators.

Maintenance and Service Guide, 86 A7 42EM

explains how to maintain, service, and upgrade NovaScale 5xx5 Servers. This guide is intended for use by qualified support personnel.

Troubleshooting Guide, 86 A7 91EF

explains how to diagnose and solve any problems occurring during Bull NovaScale Server operation. This guide is intended for use by qualified support personnel.

PAM Help Message Guide, 86 A7 32ER

provides the complete collection of PAM Help Messages containing valuable troubleshooting information. This guide is intended for use by qualified support personnel.

Praxidiag Diagnostics Guide, 86 A7 33ER

provides the complete collection solutions to known problems extracted from the Praxidiag database. This guide is intended for use by qualified support personnel.

Cabling Guide, 86 A192ER

describes server cabling.

Bull 1300H/L & 1100H/L Cabinets, 86 A1 91EM

explains how to install and fit out rack cabinets for Bull NovaScale Servers and peripheral devices.

Bull NovaScale Series Documentation Overview, 86 A2 27EM

describes the hardware, software and online documentation available for Bull NovaScale Servers, related Operating Systems, and licensed programs.



Note:

According to server configuration and version, certain features and functions described in this guide may not be accessible. Please contact your Bull Sales Representative for sales information.

Regulatory Specifications and Disclaimers

Declaration of the Manufacturer or Importer

We hereby certify that this product is in compliance with European Union EMC Directive 2004/108/CE, using standards EN55022 (Class A) and EN55024 and Low Voltage Directive 2006/95/CE, using standard EN60950. The product has been marked with the CE Mark to illustrate its compliance.

Safety Compliance Statement

- UL 60950 (USA)
- IEC 60950 (International)
- CSA 60950 (Canada)

European Community (EC) Council Directives

This product is in conformity with the protection requirements of the following EC Council Directives:

Electromagnetic Compatibility

- 2004/108/CE

Low Voltage

- 2006/95/CE

EC Conformity

- 93/68/EEC

Telecommunications Terminal Equipment

- 1999/5/EC

Neither the provider nor the manufacturer can accept responsibility for any failure to satisfy the protection requirements resulting from a non-recommended modification of the product.

Compliance with these directives requires:

- an EC declaration of conformity from the manufacturer
- an EC label on the product
- technical documentation

Federal Communications Commission (FCC) Statement

Note:

This equipment has been tested and found to comply with the limits for a Class A digital device, pursuant to Part 15 of the FCC Rules. These limits are designed to provide reasonable protection against harmful interference when the equipment is operated in a commercial environment. This equipment generates, uses, and can radiate radio frequency energy and, if not installed and used in accordance with the instruction manual, may cause harmful interference to radio communications. Operation of this equipment in a residential area is likely to cause harmful interference in which case the user will be required to correct the interference at his own expense.

Properly shielded and grounded cables and connectors must be used in order to meet FCC emission limits. Neither the provider nor the manufacturer are responsible for any radio or television interference caused by using other than recommended cables and connectors or by unauthorized changes or modifications to this equipment. Unauthorized changes or modifications could void the user's authority to operate the equipment.

Any changes or modifications not expressly approved by the grantee of this device could void the user's authority to operate the equipment. The customer is responsible for ensuring compliance of the modified product.

FCC Declaration of Conformity

This device complies with Part 15 of the FCC Rules. Operation is subject to the following two conditions: (1) this device may not cause harmful interference, and (2) this device must accept any interference received, including interference that may cause undesired operation.

Canadian Compliance Statement (Industry Canada)

This Class A digital apparatus meets all requirements of the Canadian Interference Causing Equipment Regulations.

Cet appareil numérique de la classe A est conforme à la norme NMB-003 du Canada.

This product is in conformity with the protection requirements of the following standards:

Electromagnetic Compatibility

- ICES-003
- NMB-003

Laser Compliance Notice

This product that uses laser technology complies with Class 1 laser requirements.

A CLASS 1 LASER PRODUCT label is located on the laser device.

<p>Class 1 Laser Product Luokan 1 Laserlaite Klasse 1 Laser Apparat Laser Klasse 1</p>
--

Definition of Safety Notices



DANGER

A *Danger* notice indicates the presence of a hazard that has the potential of causing death or serious personal injury.



CAUTION:

A *Caution* notice indicates the presence of a hazard that has the potential of causing moderate or minor personal injury.



Warning:

A *Warning* notice indicates an action that could cause damage to a program, device, system, or data.

Electrical Safety

The following safety instructions shall be observed when connecting or disconnecting devices to the system.



DANGER

The Customer is responsible for ensuring that the AC electricity supply is compliant with national and local recommendations, regulations, standards and codes of practice. An incorrectly wired and grounded electrical outlet may place hazardous voltage on metal parts of the system or the devices that attach to the system and result in an electrical shock. It is mandatory to remove power cables from electrical outlets before relocating the system.



CAUTION:

This unit has more than one power supply cable. Follow procedures for removal of power from the system when directed.

Laser Safety Information

The optical drive in this system unit is classified as a Class 1 level Laser product. The optical drive has a label that identifies its classification.

The optical drive in this system unit is certified in the U.S. to conform to the requirements of the Department of Health and Human Services 21 Code of Federal Regulations (DHHS 21 CFR) Subchapter J for Class 1 laser products. Elsewhere, the drive is certified to conform to the requirements of the International Electrotechnical Commission (IEC) 60825-1: 2001 and CENELEC EN 60825-1: 1994 for Class 1 laser products.



CAUTION:

Invisible laser radiation when open. Do not stare into beam or view directly with optical instruments.

Class 1 Laser products are not considered to be hazardous. The optical drive contains internally a Class 3B gallium-arsenide laser that is nominally 30 milliwatts at 830 nanometers. The design incorporates a combination of enclosures, electronics, and redundant interlocks such that there is no exposure to laser radiation above a Class 1 level during normal operation, user maintenance, or servicing conditions.

Data Integrity and Verification



Warning:

Bull NovaScale Servers are designed to reduce the risk of undetected data corruption or loss. However, if unplanned outages or system failures occur, users are strongly advised to check the accuracy of the operations performed and the data saved or transmitted by the system at the time of outage or failure.

Waste Management

This product has been built to comply with the Restriction of Certain Hazardous Substances (RoHS) Directive 2002/95/EC.

This product has been built to comply with the Waste Electrical and Electronic (WEEE) Directive 2002/96/EC.

Environmental Standards

Climatic and Atmospheric Specifications

The servers comply with standards:

- IEC 60068.2.1
IEC 60068.2.2
IEC 60068.2.78
IEC 60529
IEC 60950
ISO 7779

Electrical Specifications

The servers comply with standards:

- IEC 60038
IEC 60059
IEC 60196
IEC 60364
IEC 61689

Mains Source Power

- 207-244 VAC, 49 - 61 Hz (single phase Ph / N + PE or Ph / Ph + PE),
20/32/64A per PDU (see model specifications)

Voltage Sag

- 20 ms (IEC 1000-4-11)

Electromagnetic Compatibility

The servers comply with standards:

Europe:	<p>EMC Directive, 89/336/EEC</p> <ul style="list-style-type: none">• EN55022, Class A Limit, Radiated & Conducted Emissions• EN55024, ITE Specific Immunity Standard• EN61000-4-2, ESD Immunity (Level 2 Contact Discharge, Level 3 Air Discharge)• EN61000-4-3, Radiated Immunity (Level 2)• EN61000-4-4, Electrical Fast Transient (Level 2)• EN61000-4-5, AC Surge• EN61000-4-6, Conducted RF• EN61000-4-8, Power Frequency Magnetic Fields• EN61000-4-11, Voltage Dips and Interrupts• EN61000-3-2, Limit for Harmonic Current Emissions• EN61000-3-3, Voltage Flicker
North America	<ul style="list-style-type: none">• FCC Part 15 Class A• ICES-003 Issue 3 Class A

Bull NovaScale Blade servers also comply with standards:

- Japan: IEC 1000-3-2
- Australia / New Zealand: IEC 60950
- Taiwan: BSMI Approval
- Korea: RRL Approval
- Russia: GOST Approved
- International: CISPR, Class A Limit

Protection against Electrostatic Discharges

CMOS (Complementary Metal Oxide Semiconductor) technology is highly sensitive to electrostatic discharges. The use of conductive antistatic flooring is strongly recommended.

Maintenance personnel must wear wrist-straps before handling electronic equipment. A ground socket is provided in each cabinet.

Shocks and Vibrations

The servers comply with standards:

- IEC 60068-1
- IEC 60068-2-6
- IEC 60068-2-27
- IEC 60068-2-31
- IEC 60068-2-47
- IEC 60068-2-64
- IEC 60050
- ISO 2041
- ISO 5348
- ISO 5344
- ISO 8626

Operating Mode (on levelers)

- Sinusoidal vibrations:
 - Duration: 1 sweep, 1 octave/mn
 - 5 - 16 Hz range: 0.25 mm peak
 - 16 -200 Hz range: 0.25 g peak
- Random excitation:
 - Duration: 15 mn
 - Frequency: 5 - 200 Hz
 - Spectral density: 1.5×10^{-4} g /Hz
 - Root mean square acceleration: 0.17g RMS

Non-operating Mode (on castors)

- Sweep sine:
 - Duration: 1 sweep, 1 octave/mn
 - 5 - 16 Hz range: 0.25 mm peak
 - 16 - 200 Hz range: 0.25 g peak
- Random excitation:
 - Duration: 15 mn
 - Frequency: 5 - 200 Hz
 - Spectral density: 1.5×10^{-3} g /Hz
 - Root mean square acceleration: 0.54g RMS

Shock Tests:

- Duration: 11 ms
- Form: 1/2 sinusoidal
- Amplitude: 15 g

Pollution Limits

The servers comply with standard:

- NFX44-101, Class 4 000 000

Audio-Noise Limits

The servers comply with standards:

- ISO 7779
- ISO 11201
- ISO 7574
- ISO 4871
- ISO 9295
- ISO 9296
- IEC 61260
- IEC 60651 (Bull NovaScale 5xx5 Series & Bull NovaScale 5xx5 Series)
- IEC 61672-1 (Bull NovaScale 4000 Series)
- IEC 61672-2 (Bull NovaScale 4000 Series)

Operating LwAd Acoustical Power

- 7.4 Bel

Operating Lpa Acoustical Pressure

- 60 dBA

Safety Specifications

The servers comply with national and international standards:

- IEC 60950
- EN 60950
- UL 60950
- CAN/CSA C22-2 N° 60950-00

Installation Flowchart

This flowchart summarizes main installation and setup procedures.

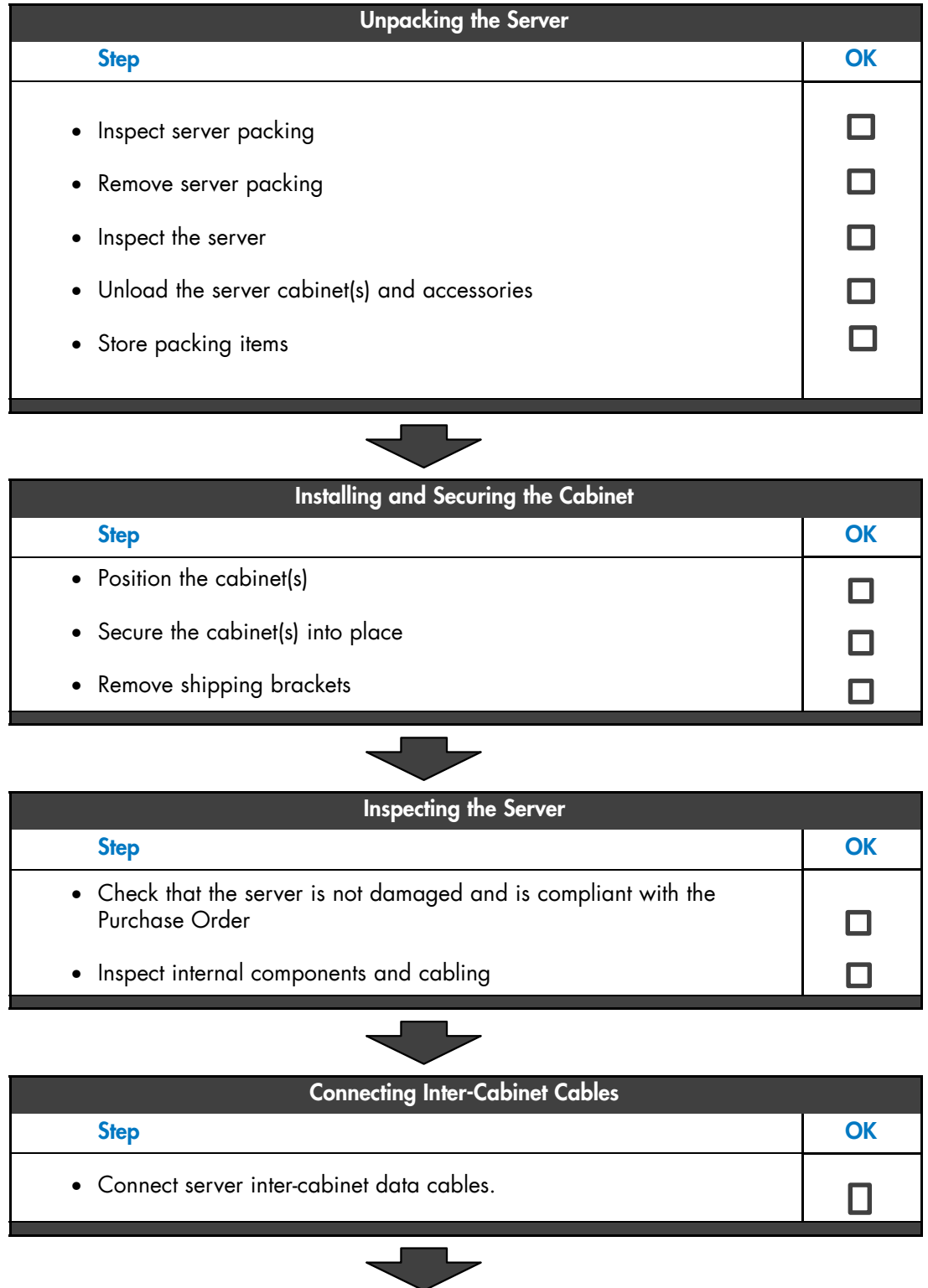

Connecting the Server to the Power Supply	
Step	OK
<ul style="list-style-type: none"> • Mount power supply cable sockets 	<input type="checkbox"/>
<ul style="list-style-type: none"> • Connect the server power cables to the dedicated power supply 	<input type="checkbox"/>



Powering up the Server	
Step	OK
<ul style="list-style-type: none"> • Power on the server to the standby mode 	<input type="checkbox"/>
<ul style="list-style-type: none"> • Launch PAM software 	<input type="checkbox"/>
<ul style="list-style-type: none"> • Check server status 	<input type="checkbox"/>
<ul style="list-style-type: none"> • Test CSS module ring connexions 	<input type="checkbox"/>
<ul style="list-style-type: none"> • Power up / down the server domain(s) 	<input type="checkbox"/>
<ul style="list-style-type: none"> • Shut down / restart the server 	<input type="checkbox"/>



Completing PAP Unit Configuration and Operating System Setup	
Step	OK
<ul style="list-style-type: none"> • Change the PAP unit default name 	<input type="checkbox"/>
<ul style="list-style-type: none"> • Launch the PAP Configuration Setup wizard 	<input type="checkbox"/>
<ul style="list-style-type: none"> • Configure Customer information 	<input type="checkbox"/>
<ul style="list-style-type: none"> • Configure Autocalls 	<input type="checkbox"/>
<ul style="list-style-type: none"> • Connect the PAP unit to the Enterprise LAN 	<input type="checkbox"/>
<ul style="list-style-type: none"> • Complete Operating System setup for the server domain(s) 	<input type="checkbox"/>
<ul style="list-style-type: none"> • Initializing the PAP Unit Backup Disk 	<input type="checkbox"/>



Connecting the Server to the Enterprise LAN and Connecting External Devices	
Step	OK
<ul style="list-style-type: none"> • Connect the server to the Enterprise LAN 	<input type="checkbox"/>
<ul style="list-style-type: none"> • Connect external peripherals (storage, modem, ...) 	<input type="checkbox"/>



Confirming Correct Installation	
Step	OK
<ul style="list-style-type: none"> • Test network connections 	<input type="checkbox"/>
<ul style="list-style-type: none"> • Test Autocalls 	<input type="checkbox"/>
<ul style="list-style-type: none"> • Record site data 	<input type="checkbox"/>
<ul style="list-style-type: none"> • Send the Intervention Report 	<input type="checkbox"/>

Chapter 1. Delivery

This chapter explains delivery unpacking and inspection procedures. It includes the following topics:

- Overview, on page 1-2
- General Recommendations, on page 1-7
- Unpacking the Server Cabinet, on page 1-8
- Inspecting the Server before Unloading the Cabinet, on page 1-8
- Inspecting Internal Components and Cabling, on page 1-11
- Getting to know the Server, on page 1-12

Bull NovaScale Server Overview

Bull NovaScale Servers for business and scientific applications are based upon the FAME architecture (Flexible Architecture for Multiple Environments), leveraging the latest generation of Intel Itanium 2 processors.

Servers are designed to operate as one to eight hardware-independent SMP systems or domains, each running an Operating System instance and a specific set of applications.

According to version, servers are delivered rack-mounted and ready-to-use in high or low cabinets.



Figure 1. Bull NovaScale Server cabinets

Dynamic Partitioning

Bull NovaScale Servers can be dynamically partitioned into physically independent ccNUMA (Cache Coherent Non Uniform Memory Access) SMP systems or domains, each running an Operating System instance and a specific set of applications.

Extended Configurations

Several Bull NovaScale Servers may be administered through a single instance of PAM software.

Cluster Configurations

Several Bull NovaScale Servers may be grouped to act like a single system, enabling high availability, load balancing and parallel processing.

Server Features

The main features of Bull NovaScale Servers are:

Intel Itanium Processor Family architecture:

- Modularity, predictable performance and growth

High availability:

- Component redundancy
- Capacity to isolate or replace a faulty component without service disruption
- Global and unified system visibility
- Round-the-clock operation

Scalability:

- Dynamic partitioning
- Power on demand: capacity to dynamically adapt resources and processor frequency to load requirement

Simultaneous support of multiple environments:

- Microsoft Windows Server
- Linux

High performance computing capabilities:

- Technical and scientific applications:
 - . High Performance Computing (HPC)
- Business Intelligence:
 - . Datawarehousing
 - . Datamining
- Large enterprise applications:
 - . ERP
 - . CRM
 - . SCM ...
- Large database applications for Internet transactions.
- Large business sector applications:
 - . Online billing
 - . Online reservations
 - . Online banking ...

Built-in Platform Administration and Maintenance (PAM) software suite:

- Proactive administration
- Optimization of resources
- Automatic generation of corrective actions and calls to support centers
- Dynamic configuration

Bull NovaScale Master System Management (NSM) software suite:

- Windows, Linux, and Platform management
- Monitoring, Information, Control, and Event Handling
- Client / Server / Agent architecture
- WEB standard OpenSource solutions

Server Hardware



Note:

Abbreviations and acronyms are documented in the *Glossary*.

Main server hardware components are:

Central SubSystem Module (CSS Module)

Main server hardware components are housed in the CSS Module. For easy access and servicing, the CSS Module is composed of three interconnected units:

Front Unit	Core Unit	Rear Unit
1 or 2 QBBs	1 MQB	1 or 2 IOCs
1 or 2 Internal Peripheral Drawers	1 MIO	1 or 2 IOLs
	2 MSXs	1 PMB
	1 MFL	2 or 4 DPS Units
	8 Fanboxes	



Notes:

- The CSS Module can be logically divided into two **Cells**, each with one QBB and one IOC, to allow dynamic partitioning.
- According to version, servers are equipped with one, two, three, or four interconnected CSS modules.

Front Unit

Quad Brick Block (QBB)

The QBB is equipped with 2 to 4 Itanium® 2 processors and 16 DDR DIMMs. The QBB communicates with the rest of the system the high-speed bidirectional link **Scalability Port Switches (SPS)** located on the MSX.

Internal Peripheral Drawer (IPD)

The Internal Peripheral Drawer is equipped with a DVD/CD ROM drive and a USB port. The Internal Peripheral Drawer is connected to the MQB in the Core Unit via a **Device Interface Board (DIB)**.

Optionally:

- the Internal Peripheral Drawer can house 2 SCSI Disks for OS partitions or storage,
- two Internal Peripheral Drawers, in the same CSS module, can be connected together to house 4 SCSI Disks for OS partitions or storage (**Chained DIBs**).

Core Unit

Midplane QBB Board (MQB)

The QBBs and the Internal Peripheral Drawers are connected to the MQB.

Midplane IO Board (MIO)

The IOCs and the PMB are connected to the MIO.

Midplane SPS & XPS Board (MSX)

Each MSX houses 1 high-speed directional link **Scalability Port Switch (SPS)** and is connected to both the MIO and the MQB. Each QBB and IOC communicates with the rest of the system through the SPS.

Midplane Fan & Logistics Board (MFL)

16 Fans and various logistics components are implemented on the MFL. The MFL is connected to both the MIO and the MQB.

Fanboxes

8 Fanboxes, each housing 2 fans, provide redundant cooling.

Rear Unit

IO board Compact (IOC)

The IOC provides 4 x PCI -X and 2 x PCI-Express buses and a PCI Hot Plug Board (HPB). The IOC communicates with the rest of the system through the high-speed bidirectional link **Scalability Port Switches (SPS)** located on the MSX.

IO board Legacy (IOL)

The IOL is an IOC daughter board providing legacy IO connections: 2 USB ports, 1 LAN port, 2 serial ports, and 1 video port.

Platform Maintenance Board (PMB)

The PMB concentrates logistics access and links the platform to the Platform Administration Processor (PAP Unit) running Platform Administration and Maintenance (PAM) software.

Distributed Power Supply (DPS) Unit

Each DPS Unit supplies 48V AC/DC power to the server. The server is equipped with 2 or 4 DPS units for full redundancy.

Platform Administration Processor (PAP) Unit

The PAP Unit hosts all server administration software, in particular Platform Administration and Maintenance (PAM) software.

KVM Switch

The KVM Switch allows the use of a single keyboard, monitor and mouse for the local server domains and the local PAM console.

Console

The Console contains the keyboard, monitor and touch pad / mouse used for local access to the server domains and to the PAP Unit.

Disk Subsystem

If the disk slots in the Internal Peripheral Drawer are not used for OS disk partitions, a SCSI RAID or FC disk subsystem is required.

Additional Peripherals

Additional peripherals such as disk subsystems, storage area networks, communication networks, archiving peripherals etc. can be connected to the server via PCI adapters located in the IOCs. Such peripherals may either be rack-mounted in the server cabinet (if free space is available) or in external cabinets.

Server Firmware and Software

Operating Systems (OS)

The server is certified for the following Operating Systems:

- Windows Server 2003, Enterprise Edition
- Windows Server 2003, Datacenter Edition
- Linux Red Hat Enterprise Linux Advanced Server
- Novell SUSE SLES 9

BIOS

The BIOS controls the server startup process, dynamic resource allocation (Domain reconfiguration, hot-plugging), and error handling. The BIOS also includes:

- The **Extended Firmware Interface (EFI)**, which provides the OS with system services.
- The **EFI Shell**, an autonomous environment used to run Off-line Test & Diagnostic suites.

Platform Administration and Maintenance (PAM) suite

The PAM Web-based software suite is used to operate, monitor, and configure the server. PAM can be accessed locally or remotely through Microsoft Internet Explorer or Mozilla browsers, under the protection of appropriate access rights. PAM provides the administration functions needed to manage and maintain the server:

- Domain configuration and resource allocation
- Alert or maintenance requests to the Customer Service Center
- Error logging ...

Test & Diagnostics suites

The server is delivered with the following T & D suites:

- Online Test & Diagnostic suite
- Offline Test & Diagnostic suite
- Power-On Self-Test suite

NovaScale Master (NSM) Management suite

The NSM software suite allows you to monitor and manage NovaScale Windows and Linux systems.

Conformance to Standards

Intel

Bull NovaScale Servers conform to all Intel platform standards:

- ACPI (Advanced Configuration and Power Interface)
- IPMI (Intelligent Platform Management Interface)
- EFI (Extended Firmware Interface)
- SMBIOS (System Management BIOS)
- DIG64 (Developer Interface Guide for Intel® Itanium® Architecture)

Windows

Bull NovaScale Servers conform to the standards set out in the Windows Hardware Design Guide.

General Recommendations

Bull NovaScale Servers are delivered rack-mounted and pre-cabled in one or more high or low cabinets, according to the version chosen.

Site preparation must be completed by the pre-arranged delivery date. Any delay due to non-completion of the site by the pre-arranged date will be considered as the Customer's responsibility.

The server is delivered 24 hours in advance of the scheduled installation date. On arrival, it must be placed, in its packing, in the Computer Room so that it reaches room temperature before powering up (optimum operating temperature = $22^{\circ}\text{C} \pm 3^{\circ}\text{C}$, hygrometry = $50\% \pm 5\%$).



CAUTION:

It is mandatory for the server to be transported vertically. Servers are extremely heavy and require the use of an elevator. The Data Processing Site manager must allocate enough personnel to ensure safe handling.

Use the Packing Slip to check the number and condition of the shipping boxes prior to unpacking.

The server is delivered with a box labeled *Open Me First* containing all the data and items required for installation.



Warning:

To avoid condensation and incorrect handling, the server must be removed from its packing by authorized Service personnel ONLY, on the scheduled installation date.

Unpacking the Server Cabinet

Instructions on how to unpack cabinets for Bull NovaScale Servers and peripheral devices are set out in document *Bull 1300H/L & 1100H/L Cabinets, 86 A1 91EM*.



Warning:

The server must not be unpacked before it has reached room temperature (24 hours in the Computer Room).



DANGER

Server cabinets are extremely heavy. Authorized Service personnel ONLY may unpack and physically install cabinets. The instructions set out below are to be strictly complied with to avoid serious personal injury.

Inspecting the Server before Unloading the Cabinet

Once the server cabinet has been unpacked, you must perform a preliminary visual inspection before unloading the cabinet.



Note:

Server components and configuration may differ according to the version chosen.



CAUTION:

If the inspection indicates an unacceptable safety condition, the condition must be corrected before powering up the server.

1. Check that the server delivered is compliant with the Purchase Order.
2. Check covers and doors for sharp edges, damage or alterations.
3. Check the correct fit of covers and doors.
4. Open the front and rear doors.



Note:

Unlock the front door with the key, pull the handle forwards and upwards to disengage the lock.

5. Check for internal damage, alterations and obvious safety hazards such as broken wires, sharp edges, or broken insulation.
6. Check internal cables for damage.
7. Check for dirt, water, and any other form of contamination inside the cabinet.
8. Check the voltage label on the back of the cabinet to ensure that it matches the voltage at the power outlet.
9. Check external power cables for damage.
10. Check correct closure of front and rear doors.

Removing CSS Module Brackets and Installing Stoppers

Each Bull NovaScale Server CSS module is equipped with two yellow shipping brackets at the front and two yellow shipping brackets at the rear of the cabinet. Once the server has been installed and correctly secured, you must remove all shipping brackets and install the stoppers supplied in the **Open Me First** box.

Removing CSS Module Shipping Brackets

11. From the front of the cabinet, loosen and remove the 2 shipping brackets on either side of the CSS module / cabinet with the 8 mm hex wrench.



Figure 2. Removing front shipping brackets

12. From the rear of the cabinet, loosen and remove the 2 shipping brackets on either side of the CSS module / cabinet with the 8 mm hex wrench.



Figure 3. Removing rear shipping brackets.

Repeat Steps 11 and 12 for each CSS module in the cabinet.



Important:

Take care to store shipping brackets and fittings with other packing items.

Installing Stoppers

Four stoppers, complete with captive screws, are supplied with each CSS module and must be installed once shipping brackets have been removed.

The two narrow stoppers are installed on the front cabinet frame and the two deep stoppers are installed on the rear cabinet frame.

1. From the front of the cabinet, align the 2 narrow stoppers (A) with the front of the frame and tighten into place.



Figure 4. Installing front stoppers

2. From the rear of the cabinet, align the 2 deep stoppers (B) with the front of the frame and tighten into place.



Figure 5. Installing rear stoppers.

Repeat Steps 1 and 2 for each CSS module in the cabinet.

Inspecting Internal Components and Cabling

A thorough visual inspection of internal components and cabling should now be carried out before powering up the server.



CAUTION:

If the inspection indicates an unacceptable safety condition, the condition must be corrected before powering up the server.

1. Visually check internal cables for damage.
2. Visually check system components for damage.
3. Manually check internal cable connections.
4. Visually check external power cables for damage.



Note:

If you need to check CSS Module components, refer to the *Maintenance and Service Guide*.

For guidance with cabling, see *Cabling Guide*, 86 A192ER.

Getting to Know the Server

NovaScale 5085 Partitioned Server

Note:

Server components and configuration may differ according to the version chosen.

The server is delivered rack-mounted and pre-cabled in a low or high cabinet, typically containing the following components:

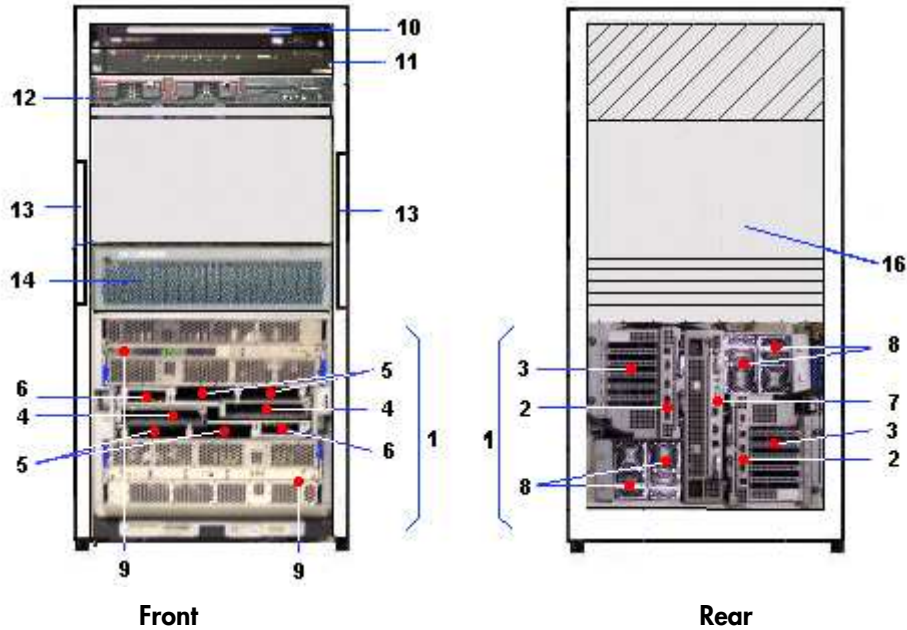

1	CSS module with core unit, power supply and AC power cable, including:		8 U	
	2xIO Boxes (IOC) each with:	2		IOL board - legacy ports
		3		4xPCI-X & 2x PCI-Express slots
	2xInternal Peripheral Drawers each with:	4		DVD-ROM drive
		5		2xInternal SCSI RAID disks
		6		USB port
	PMB board	7		
	2 or 4 DPS units	8		
	2xQBB subsets (1 to 4 CPUs each) *Multicore CPU = Socket	9		
10*	Slideaway console with monitor and keyboard		1 U	
11	8-ports KVM switch		1 U	
12	PAP unit with CD-ROM writer, FDD and 2 disks		1 U	
13*	1 or 2 PDU(s) with AC power cable			
14	1 optional FC disk		3 U	
16	Free space for additional components		4 U	
* Slideaway console. For an external console, use a KVM extender kit (150m max.).				
** Redundant servers are connected to 2 PDUs and have 4 DPS units.				

Figure 6. NovaScale 5085 Partitioned Server components - example

NovaScale 5165 Partitioned Server



Note:

Server components and configuration may differ according to the version chosen.

The server is delivered rack-mounted and pre-cabled in a high cabinet, typically containing the following components:

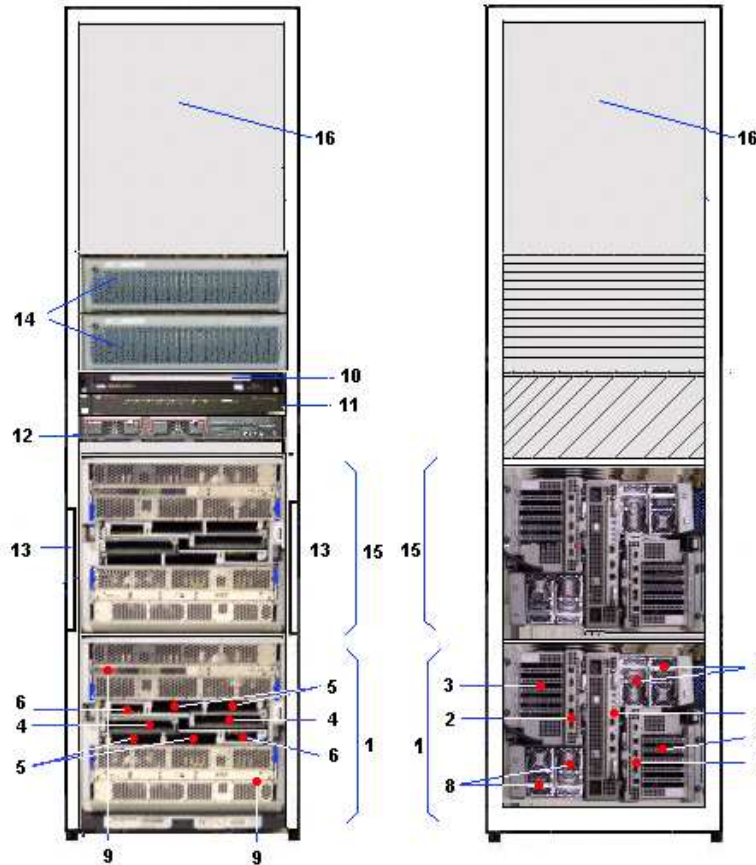

Front

Rear

1, 15	CSS module with core unit, power supply and AC power cable, including:		8 U x 2
	IO Box (IOC) with:	2 IOL board - legacy ports	
		3 4xPCI-X & 2x PCI-Express slots	
	Internal Peripheral Drawer with:	4 DVD-ROM drive	
		5 2xInternal SCSI RAID disks	
		6 USB port	
	PMB board	7	
	2 or 4 DPS units	8	
	2xQBB subsets (1 to 4 CPUs each)	9	
	*Multicore CPU = Socket		
10*	Slideaway console with monitor and keyboard		1 U
11	8-ports KVM switch		1 U
12	PAP unit with CD-ROM writer, FDD and 2 disks		1 U
13**	1 or 2 PDU(s) with AC power cable		
14	2 FC disks (optional)		3 U x 2
16	Free space for additional components (SCSI or FC disks)		14 U
* Slideaway console. For an external console, use a KVM extender kit (150m max.).			
** Redundant servers are connected to 2 PDUs and have 4 DPS units.			

Figure 7. NovaScale 5165 Partitioned Server components - example

NovaScale 5245 Partitioned Server

Note:

Server components and configuration may differ according to the version chosen.

The server is delivered rack-mounted and pre-cabled in a high cabinet, typically containing the following components:

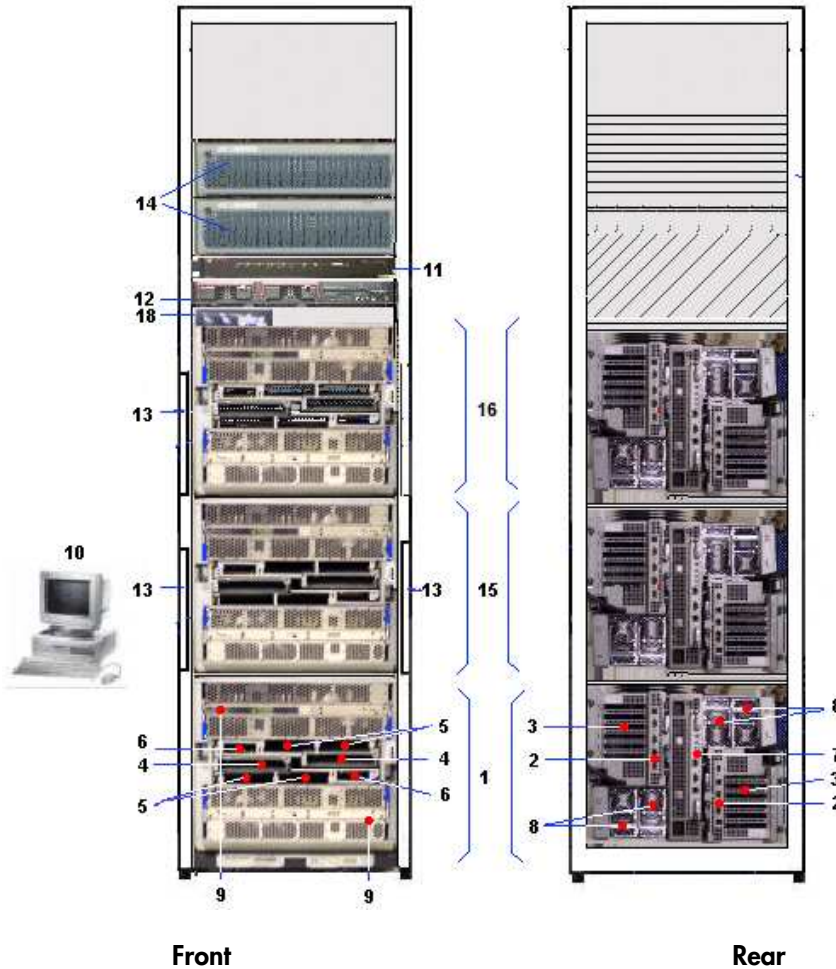

	Front	Rear	
1, 15, 16	CSS module with core unit, power supply and AC power cable, including: IO Box (IOC) with: Internal Peripheral Drawer with: PMB board 2 or 4 DPS units 2xQBB subsets (1 to 4 CPUs each) *Multicore CPU = Socket	2 IOL board - legacy ports 3 4xPCI-X & 2x PCI-Express slots 4 DVD-ROM drive 5 2xInternal SCSI RAID disks 6 USB port 7 8 9	8 U x 3
10*	External console with monitor and keyboard		
11	8-ports KVM switch		1 U
12	PAP unit with CD-ROM writer, FDD and 2 disks		1 U
13**	1 or 2 PDU(s) with AC power cable		
14	2 FC disks		3 U x2
16	Free space for additional components (SCSI or FC disks)		14 U
18	KVM extender		1 U
* External console, use a KVM extender kit (150m max.).			
** Redundant servers are connected to 2 PDUs and have 4 DPS units.			

Figure 8. NovaScale 5245 Partitioned Server components - example

NovaScale 5325 Partitioned Server



Note:

Server components and configuration may differ according to the version chosen.

The server is delivered rack-mounted and pre-cabled in two high cabinets, typically containing the following components:

Main Cabinet

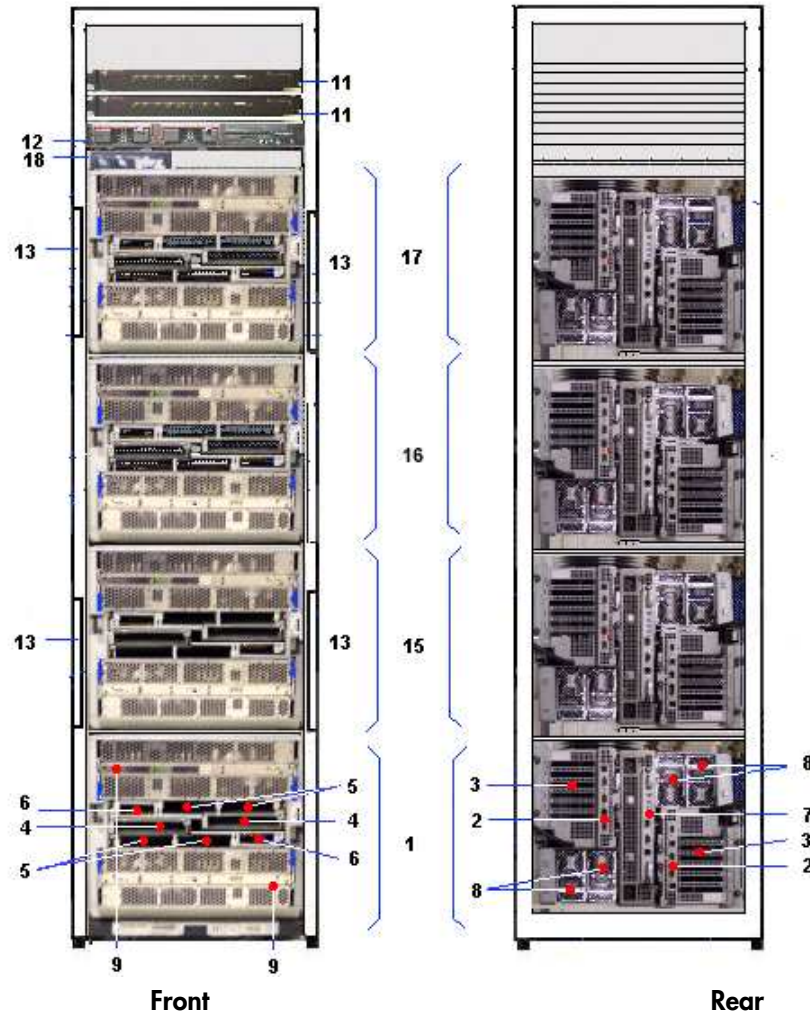

Front		Rear		
1, 15, 16, 17	CSS module with core unit, power supply and AC power cable, including:			8 U x 4
	IO Box (IOC) with:	2	IOL board - legacy ports	
	Internal Peripheral Drawer with:	3	4xPCI-X & 2x PCI-Express slots	
		4	DVD-ROM drive	
		5	2xInternal SCSI RAID disks	
		6	USB port	
	PMB board	7		
2 or 4 DPS units	8			
2xQBB subsets (1 to 4 CPUs each) *Multicore CPU = Socket	9			
11	2 x 8-ports KVM switch			1 U x 2
13*	2 or 4 PDU(s) with AC power cable			
18	KVM extender (local)			1 U
* Redundant servers are connected to 2 PDUs and have 4 DPS units.				

Figure 9. NovaScale 5325 Partitioned Servers components - example

I/O Cabinet

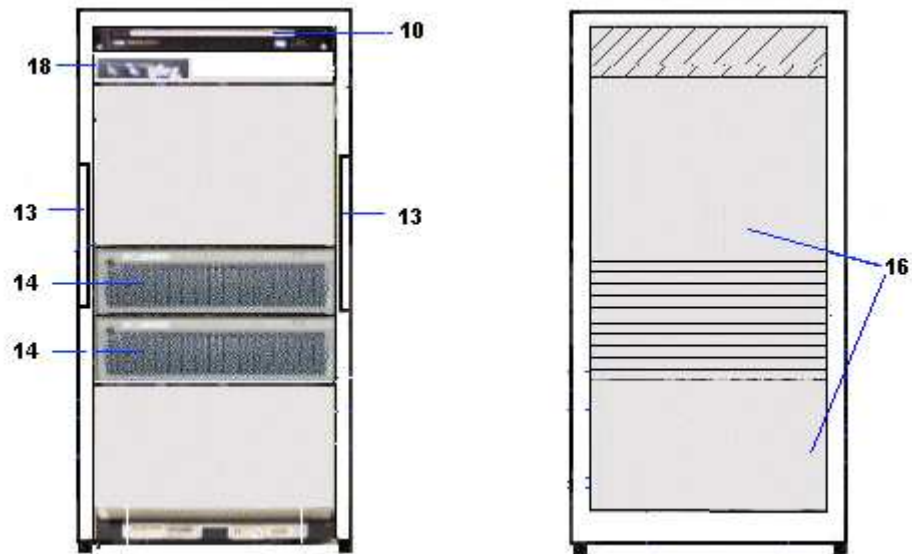

10	PAP unit with CD-ROM writer, FDD and 2 disks	1 U
13	2 PDU(s) with AC power cable	
14	2 FC disks	3x2 U
18	KVM extender (remote)	1 U

Figure 10. NovaScale 5325 Partitioned Servers components - example

Server Components



Note:

Server components and configuration may differ according to the version chosen.

The server includes the following components:

- CSS module, on page 1-18
- Integrated console, on page 1-20
- Integrated Platform Administration Processor (PAP) unit, on page 1-19
- Keyboard / Video / Mouse (KVM) switch, on page 1-21
- Fibre Channel (FC) disks, on page 1-22
- Ethernet hub, on page 1-24
- USB modem, on page 1-24
- NPort server, on page 1-24

Central Subsystem (CSS) Module

The CSS module houses main hardware components:

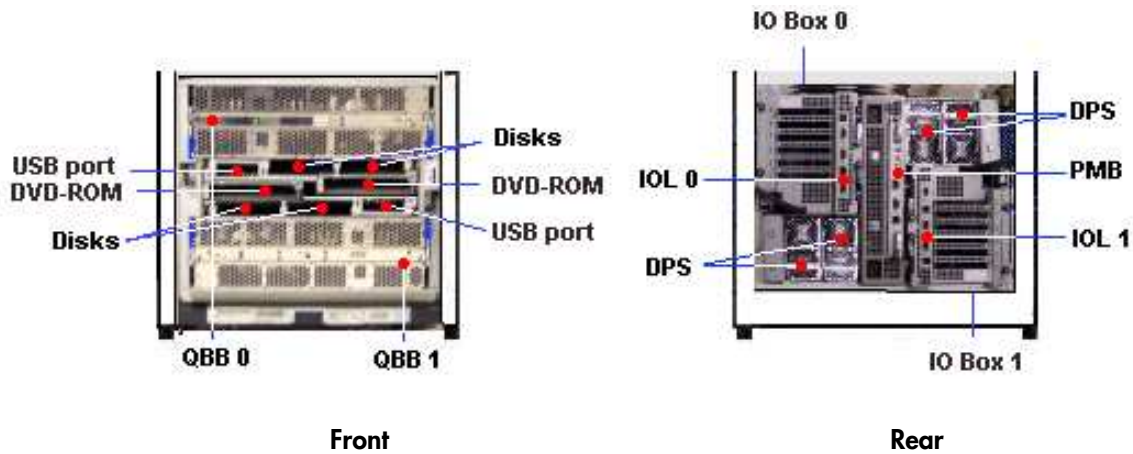

Front	<p>1 or 2 QBB (Quad Brick Board) subset(s): Each QBB subset houses:</p> <ul style="list-style-type: none"> • 1 mother board • 2 memory boards • 1 to 4 processors • 16 DIMMs <p>1 or 2 Internal Peripheral Drawer(s): Each drawer houses:</p> <ul style="list-style-type: none"> • 2 internal SCSI RAID system disks • 1 DVD-ROM drive • 1 USB port <p>Chain of DIBs: Two Internal Peripheral Drawers can be inter-connected to house:</p> <ul style="list-style-type: none"> • 4 SCSI RAID disks, 1 DVD-ROM drive, 1 USB port
Rear	<p>1 or 2 IO Box(es) (Input / Output Board Compact): Each IO Box can house:</p> <ul style="list-style-type: none"> • 1 HPB (PCI Hot Plug Board) • 6 hot-plug 133 MHz PCI-X and PCI Xpress slots (2 long, 4 short) • 1 IOL (Input / Output board Legacy): <ul style="list-style-type: none"> - 2 A-type USB ports - 1 RJ45 10/100/1000 Mbps Ethernet port - 2 DB9-M RS232 serial ports - 1 HD15-F VGA port <p>1 PMB (Platform Management Board): This active board links the server to the Platform Administration Processor (PAP) Unit (via an Ethernet link).</p>
Core	<p>1 Core unit This set of 5 active boards is used to interconnect the QBBs, IOCs, DIBs and the PMB.</p>

Figure 11. CSS module features (full CSS module example)

Integrated Platform Administration Processor (PAP) Unit

The PAP unit is linked to the server via the Platform Management Board (PMB). It hosts Platform Administration Software (PAM). **According to version, the PAP unit is located in the center of a high cabinet or at the top of a low cabinet.**



PAP Unit 1U	
<ul style="list-style-type: none">• 1 P4C / 3 GHz PC<ul style="list-style-type: none">- 1 GB RAM- 2 x 80 GB SATA disks (RAID1)- 1 CD/DVD-ROM drive- 1 1 FDD- 2 serial ports- 1 parallel port- 3 PCI slots- 2 Gigabit Ethernet ports (1 free)- 3 USB 2.0 ports (1 front + 2 rear)- 1 SVGA video port- 2 PS/2 ports	
	<ul style="list-style-type: none">• Microsoft Windows operating system• Internet Explorer software• PAM software• 1 power cable

Figure 12. PAP unit

Integrated Console

According to version, the console is located in the center of a high cabinet or at the top of a low cabinet.

The integrated console contains the keyboard, monitor and touch pad used for local access to the server and to the Platform Administration Processor (PAP) Unit.



or



- 1 monitor
- 1 QWERTY keyboard and touch pad
- 1 power cable

Figure 13. Integrated console features

Keyboard / Video / Mouse (KVM) Switch

The KVM Switch allows the use of the integrated console for the local server and the local Platform Administration and Maintenance console.

8-Port KVM Switch

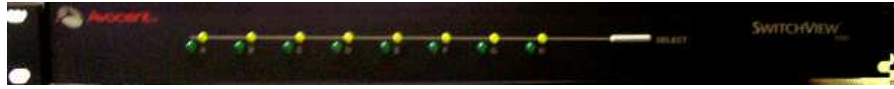

Or



Or



- 8 ports
- 1 power cable

Figure 14. 8-port KVM switch features

16-Port KVM Switch

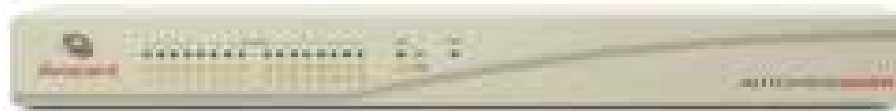

- 16 ports
- 1 power cable

Figure 15. 16-port KVM switch features

KVM Extender



Figure 16. KVM extender (local & remote) 300m maxi.

FDA 1x00 FC Disk Rack

Optionally, the FDA 1x00 FC Disk Rack is delivered with pre-installed system disks (two RAID#1 and one spare disk per domain). Empty slots can be used for data disks. According to version, the Disk Rack is located in the main or I/O cabinet.



- 15 slots
- 2 FC RAID controller cards, 1 FC port per controller
- 3 disks per domain (2 RAID#1 + 1 spare)
- 2 power cables (redundant power supply)

Figure 17. FDA 1x00 FC disk rack features

FDA 2x00 FC Disk Rack

Optionally, the FDA 2x00 FC Disk Rack is delivered with pre-installed system disks (two RAID#1 and one spare disk per domain). Empty slots can be used for data disks. According to version, the Disk Rack is located in the main or I/O cabinet.



- 1 controller unit & 1 disk unit
- 15 slots
- 2 FC RAID controller cards, 2 FC ports per controller
- 3 disks per domain (2 RAID#1 + 1 spare)
- 2 power cables (redundant power supply)

Figure 18. FDA 2x00 FC disk rack features

FDA 1x00 FC Extension Disk Rack

The FDA 1x00 FC Extension Disk Rack offers 15 empty slots for data disks. According to version, the Disk Rack is located in the main or I/O cabinet.



- 15 slots
- 2 power cables (redundant power supply)

Figure 19. FDA 1x00 FC extension disk rack features

Ethernet Hub

The optional Maintenance LAN Ethernet Hub is used to connect PMB, PAP Unit and external FDA FC Disk Rack Ethernet ports.



Ethernet Hub	<ul style="list-style-type: none">- 8 ports- 1 power cable- 1 power bar
--------------	---

Figure 20. Ethernet hub features

USB Modem

The optional USB modem is used to transmit Autocalls to the Remote Maintenance Center, if the Customer's maintenance contract includes the Autocall feature.



USB Modem	<ul style="list-style-type: none">- 1 USB cable- 1 RJ11 cable
-----------	--

Figure 21. USB modem features

NPort Server

The Nport Server is used connect the administration port of the SR-0812 SCSI RAID disk rack to the PAP Unit.

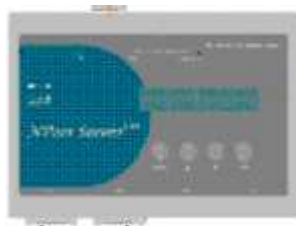

NPort Server	<ul style="list-style-type: none">- 2 DB9 to Jack cable- 1 RJ45 - RJ45 Ethernet cable
--------------	--

Figure 22. NPort Server features

Chapter 2. Setup Procedure



Important:

Certain features described in this chapter are reserved for partitioned servers and extended systems and/or to systems connected to a Storage Area Network (SAN).

This chapter explains the procedures required to set up and start the server for the first time. It includes the following topics:

- Accessing Server Components, on page 2-2
- Checking PMB Code Wheel Settings, on page 2-4
- Checking Server Cabling, on page 2-4
- Connecting the Server to the Site Power Supply, on page 2-5
- Launching PAM Software, on page 2-6
- Checking Server Status via PAM, on page 2-9
- Toggling the Local / Integrated Console Display, on page 2-12
- Testing CSS Module Ring Connections, on page 2-13
- Powering Up / Down Server Domains, on page 2-16
- Changing the iStorage Manager User Name and Password, on page 2-22
- Changing the S@N.IT Password, on page 2-23
- Completing PAP Unit Configuration, on page 2-24
- Configuring Customer Information, on page 2-29
- Configuring Autocalls, on page 2-30
- Connecting the PAP Unit to the Customer's Enterprise LAN, on page 2-32
- Connecting to the PAM Web Site from a Remote Computer/Workstation, on page 2-33
- Enabling Remote Access to iSM on the Client Computer, on page 2-33
- Completing Operating System Setup, on page 2-35
- Connecting the Server to the Enterprise LAN, on page 2-44
- Connecting the USB Modem and External Devices, on page 2-45
- Testing Network Connections, on page 2-46
- Testing Autocalls, on page 2-46
- Completing the PAM Installation Intervention Report, on page 2-46
- Renaming the Central Subsystem, on page 2-47
- Setting up PAP Unit Users, on page 2-49
- Initializing the PAP Unit Backup Disk, on page 2-51
- Backing Up / Restoring PAM Configuration Data, on page 2-54



Notes:For an overall summary of installation and setup procedures, see *Installation Flowchart*, on page xxi.

If a problem arises during the setup procedure, refer to *Troubleshooting Guide*, 86 A7 91EF and *Praxidiag Diagnostics Guide*, 86 A7 33ER.

Accessing Server Components

Opening the Front Door

Tools Required:

- Cabinet key

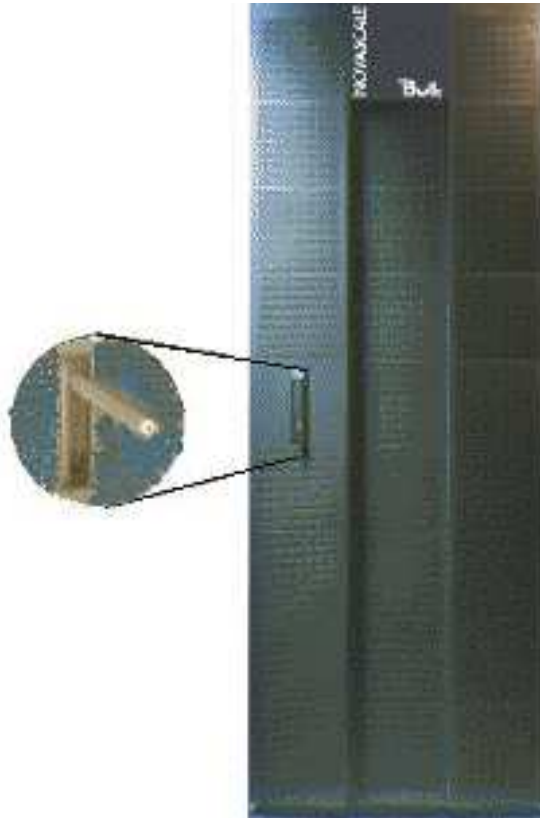

Figure 23. Opening the front door

1. Unlock the front door with the key.
2. Pull out the locking mechanism and turn to open.
3. Open the door as required.

Closing the Front Door

1. Close the door.
2. Turn the locking mechanism to close and push back into place.
3. Lock the front door with the key.

Opening / Closing the Integrated Console

The server is equipped with an integrated console for local administration and maintenance operations.



Figure 24. Integrated console example

To open the integrated console:

1. Slide the console forward until it clicks into place.
2. Use the front bar to lift the screen panel into position.

To close the integrated console:

1. Press the 2 buttons marked PUSH on either side of the keyboard panel to release the console.
2. Lower the front bar to close the screen panel.
3. Slide the console back into the cabinet.

Checking PMB Code Wheel Settings

Up to 16 Central Subsystems can be linked, via Platform Management Boards (PMBs) to a single PAP unit, to provide a single point of administration and maintenance.

Each PMB is equipped with two code wheels used to identify each Central Subsystem and each CSS module in your configuration. These code wheels are set prior to shipping (factory default setting), according to configuration.

Each PMB is equipped with two code wheels used to identify each Central Subsystem and each CSS module in the Customer's configuration. These code wheels are set prior to shipping (factory default setting), according to configuration.

CSS	CSS PMB Code Wheel	PAM CSS HW Identifier	CSS Module PMB Code Wheel	
			CSS Module 0	CSS Module 1
1st	0	00	0	1
2nd	1	01	0	1
3rd	2	02	0	1
4th	3	03	0	1
5th	4	04	0	1
6th	5	05	0	1
7th	6	06	0	1
8th	7	07	0	1
9th	8	08	0	1
10th	9	09	0	1
11th	A	10	0	1
12th	B	11	0	1
13th	C	12	0	1
14th	D	13	0	1
15th	E	14	0	1
16th	F	15	0	1

Figure 25. PMB code wheel settings

Checking Server Cabling



Important:

Cables to external peripherals must NOT be connected before powering up the server for the first time.

These cables must only be connected once server operation has been checked.

All internal cabinet cables are pre-connected before shipping. However, cables may become loose during shipping and you are advised to check for loose cables before powering up the server. Refer to the *Cabling Guide*, 86 A192ER for details.

Connecting the Server to the Site Power Supply

The Customer is responsible for ensuring that the electrical network is compliant with the standards set out in the *Site Preparation Guide*, 86 A1 87EF.



CAUTION:

Only duly certified electricians may connect the server to the power supply, under the Customer's responsibility. The server is NOT equipped with a circuit breaker. The circuit breakers referred to in this section are the SITE circuit breakers supplied by the Customer.

Safety Recommendations



DANGER

An electrical outlet that is not correctly wired could place hazardous voltage on metal parts of the server or the devices that attach to the server. It is the Customer's responsibility to ensure that the outlet is correctly wired and grounded to prevent an electrical shock.

Use one hand, when possible, to connect or disconnect signal cables to prevent a possible shock from touching two surfaces with different electrical potentials.



CAUTION:

The server is equipped with three-wire (phase/phase/ground) power cables for user safety. Use these power cables with properly grounded electrical outlets to avoid electrical shock.

1. The server has more than one power supply cable. Follow procedures for removal of power from the server when directed.
2. Energy hazard, remove all jewelry before servicing.
3. Check that the dedicated power supply circuit breakers are OFF.

Powering Up the Server to the Standby Mode

Once the PDU cables have been connected to the power outlets at the base of the cabinet, request the Customer to turn the site power supply circuit breakers ON.

The Platform Management Board (PMB) in each CSS module automatically powers up to the standby mode (48V) and the Platform Administration Processor (PAP) unit automatically boots Microsoft Windows software. Server operation can now be checked.



Note:

It may take several seconds for something to be displayed on the monitor. If the server does not initialize to standby (48V) or if an incident occurs, refer to *Troubleshooting Guide*, 86 A7 91EF and *Praxidiag Diagnostics Guide*, 86 A7 33ER.

Checking Server Operation

Once the server has been installed and powered up, correct operation must be checked.



Important:

The server must be fully checked with factory default data.

See the *Read Me First* booklet delivered with the system 24 hours before the scheduled installation date for factory default data.

Launching PAM Software

The server is equipped with an integrated Platform Administration and Maintenance software package, otherwise known as PAM software.

One part of PAM software is an embedded application (MAESTRO) running on the Platform Management Boards (PMB) and the other is an external application running on the Platform Administration Processor (PAP) unit under Microsoft Windows.

You will use the secured PAM Web-based interface to operate, monitor, and configure the server.

Once the Microsoft Windows software on the PAP unit has been booted, you will be requested to supply a User Name and Password to open a Windows® session. The session **MUST** be started for the first time with the following factory default User Name and Password:

User Name	Administrator
Password	administrator



Important:

The factory default User Name and Password are used by the authorized Customer Service Engineer during the setup procedure ONLY.

Factory default data must be replaced by Customer data once the system check has been successfully completed. See *Completing PAP Unit Configuration* on page 2-24.

To complete installation, you need to open a Customer Administrator and a Support Administrator PAM session.

To open a **Customer Administrator** PAM session:

1. From the Microsoft Windows desktop, double-click the Internet Explorer icon (<http://localhost/PAM>).
2. When prompted, request the Customer Administrator to enter the default User Name and Password:

Customer Administrator	
User Name	Administrator
Password	administrator

The PAM home page appears.



Note:

The PAM tree building process may take one to two minutes.

To open a **Support Administrator** PAM session:

1. From the Microsoft Windows desktop, double-click the Internet Explorer icon (<http://localhost/PAM>).
2. When prompted, enter the predefined User Name and Password.

The PAM Home Page appears.

PAM User Interface

The PAM user interface is divided into three areas in the browser window: a **Status** pane, a **PAM Tree** pane, and a **Control** pane.

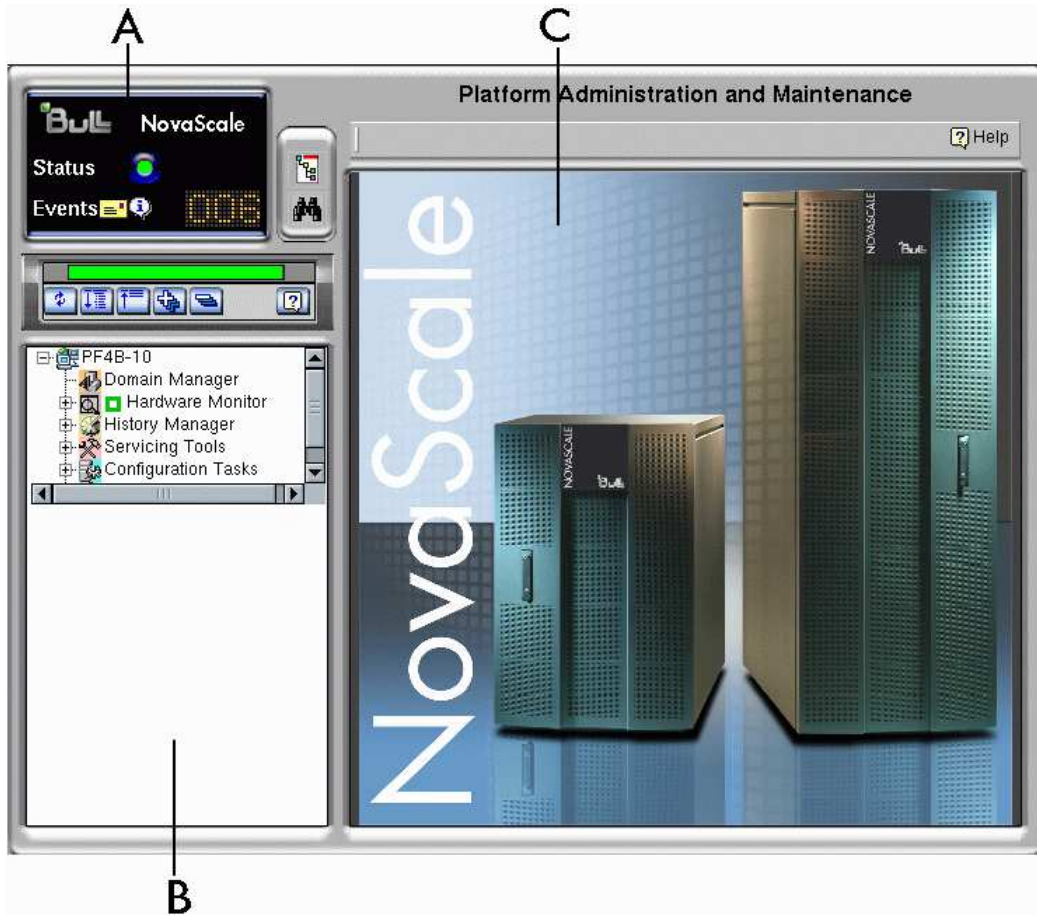

A	Status pane, on page 2-9
B	PAM Tree pane, on page 2-10
C	Control pane, on page 2-9

Figure 26. PAM user interface



Note:

For further details about the PAM user interface, please consult the *User's Guide*.

Checking Server Status via PAM

The PAM user interface allows you to check system status at a glance. If the **Functional Status** icon in the **Status** pane and the **CSS Availability Status** bar are green, the server is ready to be powered up.

PAM Status Pane

The **Status** pane, which is automatically refreshed every few seconds, provides quick access to the following synthetic information:

- **Functional Status:** if the system is operating correctly, the status icon is green,
- **Event Messages:** shows the number and maximum severity of pending event messages,
- **CSS Availability Status:** if the CSS Module PMB is detected as present, is configured correctly, and is ready to operate, the status bar is green.

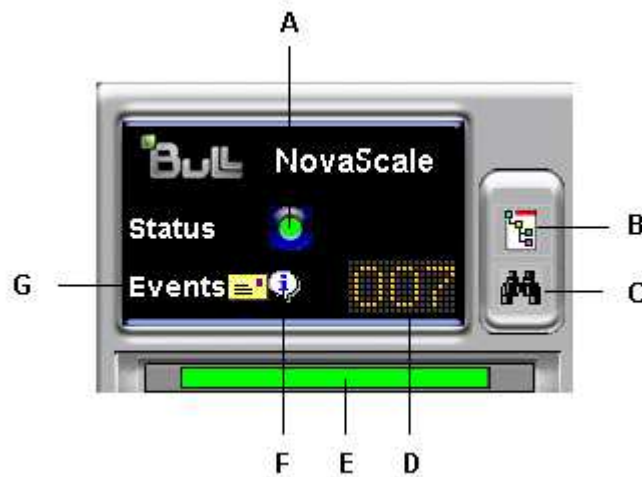

A	System Functional Status icon	E	CSS Availability Status icon
B	Presence/Functional Status toggle button	F	Event Message Severity icon
C	Event Message Viewer	G	New Event Message icon
D	Pending Event Message icon		

Figure 27. Status pane

PAM Control Pane

When an item is selected in the **PAM Tree** pane, details and related commands are displayed in the **Control** pane, which is automatically refreshed at one minute intervals.

CSS Availability Status Bar

The CSS availability status bar reflects the operational status of the data link(s) between the Platform Management Board (PMB) embedded in each CSS Module and the PAP Unit. Each CSS module is represented by a zone in the status bar.

- When a CSS Module PMB is detected as **PRESENT**, the corresponding zone in the status bar is **GREEN**.
- When a CSS Module PMB is detected as **ABSENT**, the corresponding zone in the status bar is **RED**.
- When you hover the mouse over the status bar, an **Infotip** displays the **presence status** of CSS Module PMB - PAP Unit data links.

The following figure represents the status bar for a bi-module server. One CSS Module PMB is detected as PRESENT and the other is detected as ABSENT.



A: Bar red (CSS Module_0 not available)

Figure 28. CSS Module availability status bar (bi-module server)

PAM Tree Pane



Note:

The PAM tree building process may take one to two minutes. The PAM tree pane is refreshed on request.

The **PAM Tree** pane provides access to server administration and maintenance features:

Tree Nodes	Function
Domain Manager	to power on / off and manage domains.
Hardware Monitor	to display the status of hardware components and assemblies.
History Manager	to view logs and manage archives.
Servicing Tools	to install, maintain, and update the server.
Configuration Tasks	to customize server features.

Table 1. PAM Tree nodes

PAM Tree Toolbar

The PAM Tree toolbar, located at the top of the PAM Tree, is used to refresh, expand, or collapse the tree display.









Toolbar Buttons	Explanation
	Refresh /rebuild the PAM Tree to view changes.
	Expand the complete tree.
	Collapse the complete tree.
	Expand selected node.
	Collapse selected node.
	View the related Help topic.

Figure 29. PAM Tree toolbar

toggling the Local / Integrated Console Display

During the powering up / down sequences, you will be requested to toggle the local / integrated console from the PAP unit display to the server domain display, or vice versa, as explained below.



CAUTION:

Access to the local / integrated console should be restricted to Customer / Support Administrators and Operators ONLY to avoid inadvertent damage to software and/or hardware components.

The KVM Switch allows the integrated console to be used as the local server domain and local PAP unit console. KVM ports are configured as shown in Table 2.

NovaScale 5xx5 SMP Server

8-port KVM Switch	Console Display	Domain
Port 1	PAP Unit	N/A
Port 2	Server Domain	N/A

NovaScale 5xx5 Partitioned Server

16-port KVM Switch	Console Display	Domain
Port 1	PAP Unit	N/A
Port 2	CSS0-Mod0-IO0	MyOperations-xx-1
Port 3	CSS0-Mod0-IO1	MyOperations-xx-2
Port 4	CSS0-Mod1-IO0	MyOperations-xx-3
Port 5	CSS0-Mod1-IO1	MyOperations-xx-4
Port 6	CSS0-Mod2-IO0	MyOperations-xx-5
Port 7	CSS0-Mod2-IO1	MyOperations-xx-6
Port 8	CSS0-Mod3-IO0	MyOperations-xx-7
Port 9	CSS0-Mod1-IO1	MyOperations-xx-8

Table 2. KVM port configuration

You can easily toggle from the server domain display to the PAP unit display, or vice versa:

- To display the KVM Switch Command Menu from the keyboard
 - If you have a KVM switch "Avocent SwitchView 1000" installed, press the **"Scroll Lock"** key twice then the **Space** key.
 - If you have another KVM switch installed, press the **Control** key twice.
- Select the required port with the $\uparrow\downarrow$ keys and press **Enter**.
- The selected display appears on the Console monitor.

Testing CSS Module Ring Connections

If the server is equipped with more than one CSS module, you are advised to perform a **Ring Test** to check CSS module ring connections (clocks, XSP links, sidebands) before proceeding to power up server domains.



Important:

- **CSS Module Ring Connection** testing is reserved for Customer Service Engineers. A Customer Administrator and a Support Administrator PAM session must be opened to perform the ring test.
- This test can only be performed on a mono-domain scheme containing **ALL** server resources (e.g. the default factory scheme).
- This test does NOT check XSP data link functional status. XSP data link functional status is checked during the Power-on sequence (Step 19: Global XSP links test).
- This test cannot be performed on mono-module servers.

To perform a ring test:

1. Display hardware functional status by pressing the **Presence / Functional Status**  toggle button in the PAM Status Pane. See Chapter 4. Monitoring the Server, in the User's Guide for details.
2. From the Customer Administrator PAM Tree, click **Domain Manager** to open the **Control** pane. A dialog box invites you to load the server domain.
3. Click **Schemes**. The **Schemes List** dialog opens displaying the pre-configured default scheme.
4. Select the MyOperationScheme scheme and click **Apply**.

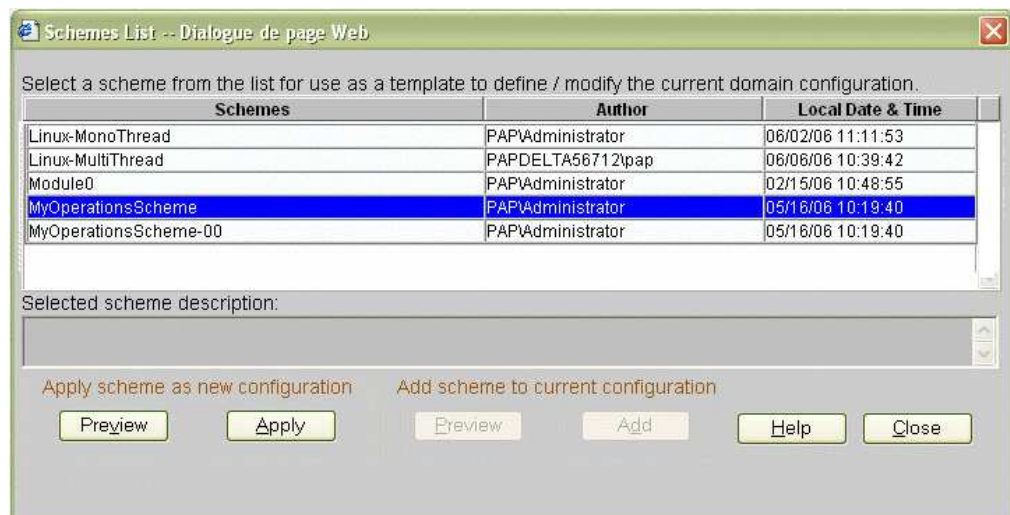

Figure 30. Domain schemes list dialog

- When requested, click **Yes** to confirm. The default domain is loaded in the **Control** pane.

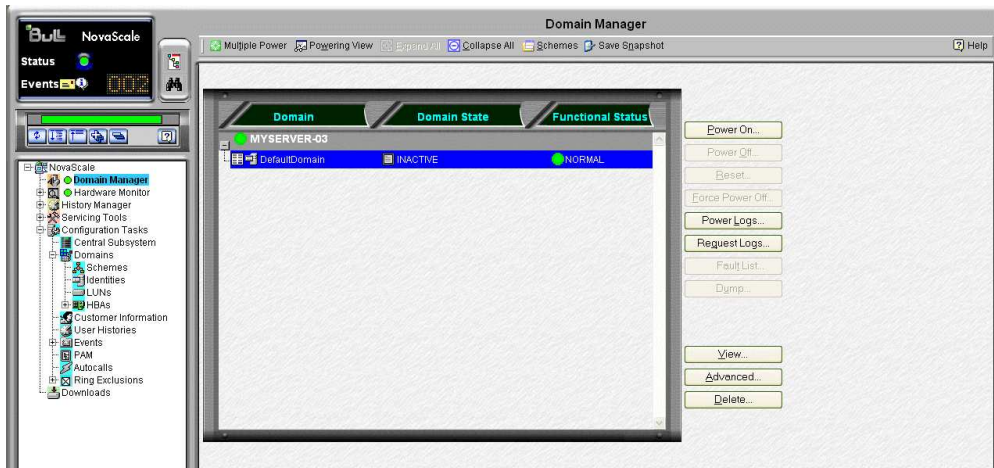

Figure 31. Default domain loaded

- From the Support Administrator PAM Tree, click **Domain Manager** to open the **Control** pane.
- Select the default domain and click **Advanced** to open the **Advanced Properties** dialog.

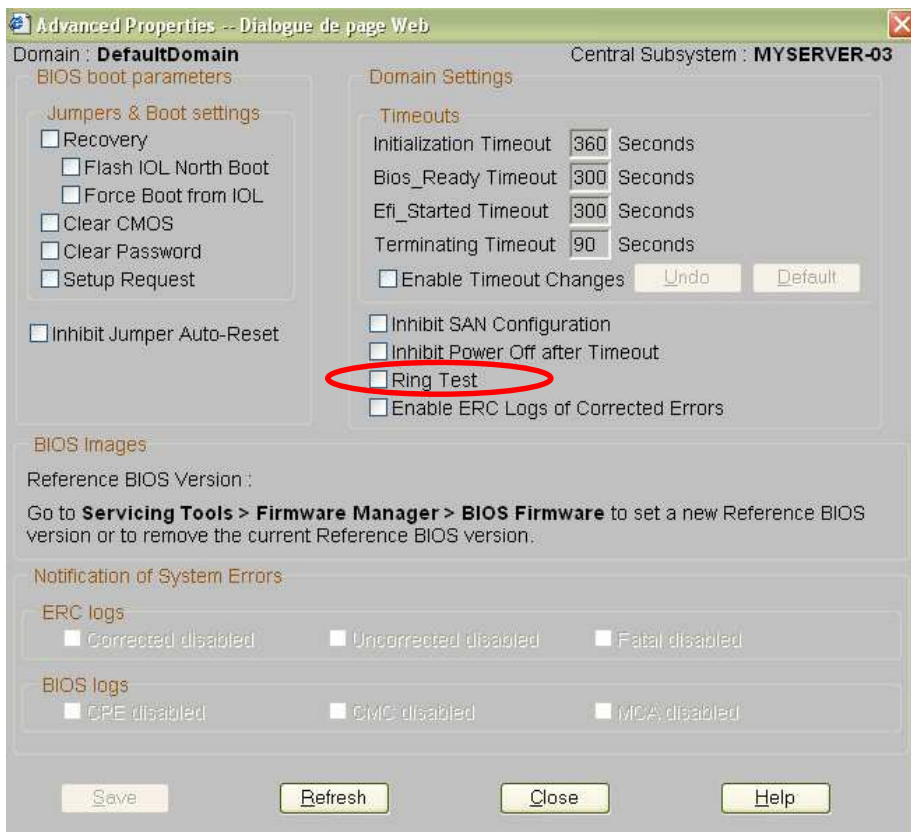



Figure 32. Advanced properties dialog

- Select the **Ring Test** check box and click **Save**. An information message informs you that settings have been saved and will be applied at the next domain power-on.
- From the Customer Administrator **Domain Manager** Control pane, select the default domain. If the domain is ready to be powered up, **INACTIVE** is displayed in the **Domain State** box and the **Power On** button is accessible.

10. Click **Power On** to power up the server domain and associated hardware components. When prompted, select **View Power-On Logs** to monitor test progress. The following message is displayed in the **Domain State** field:

Powering on (test)

The test takes 2 to 3 minutes to complete. The last message (Step 99) in the **Power-On Logs** information box indicates test result status:

- if all tested ring connections are correct, **OK** is displayed,
- if at least one tested ring connection is incorrect, **KO** is displayed. The system functional status icon turns **RED**:
 - open the **Domain Fault List** for details,
 - click the **Refresh Tree**  button in the PAM Tree toolbar to refresh the PAM Tree and update hardware functional status. Open the corresponding **Hardware Fault List** for further details.

 **Note:**

If **Power-On** is refused, a mandatory resource is missing and the ring test cannot be performed. Open the **PAMHistory** file (**History Manager** -> **System** -> **PAMHistory**) for details about the missing resource.

Powering Up / Down Server Domains

When server status has been checked - system functional status icon and CSS availability status bar green in the Status pane - the server can be powered up.

To power up / down the server, see:

- Powering Up / Down the NovaScale 5xx5 Partitioned Server Domains, on page 2-18

Powering Up the NovaScale 5xx5 SMP Server Domain

NovaScale 5xx5 SMP Servers are designed to operate as single SMP systems and are delivered with one pre-configured domain.

When server status has been checked - functional status icon and CSS availability status bar green in the Status pane - the server domain can be powered up.



Note:

If an error dialog box appears during these sequences, see *Managing Domains* in the User's Guide.

To power up / down server domains:

1. From the Customer Administrator / Operator PAM Tree, click **Domain Manager** to open the **Control** pane. A dialog box invites you to load the server domain.
2. Click **OK** to confirm. The domain appears in the Control pane. If the domain is ready to be powered up, **INACTIVE** is displayed in the **Domain State** box and the **Power On** button is accessible.
3. Select the domain and click **Power On** to power up the server domain and associated hardware components.

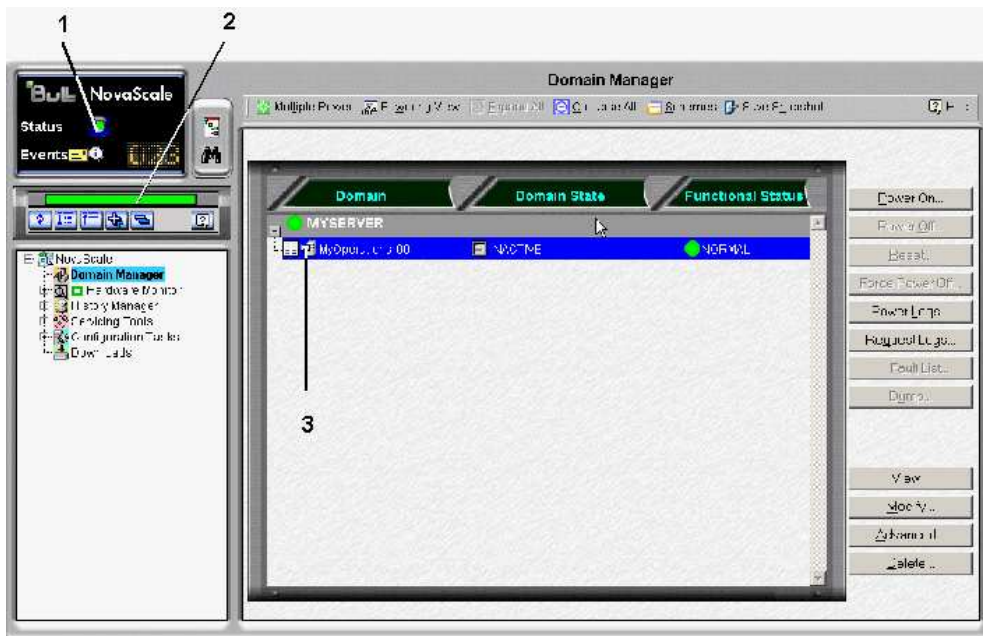

1	Functional status icon
2	CSS availability status indicator (GREEN)
3	Operating system type

Figure 33. Domain Manager Control pane

4. Follow the power-on steps displayed in the **Domain State** box, until **RUNNING** is displayed.

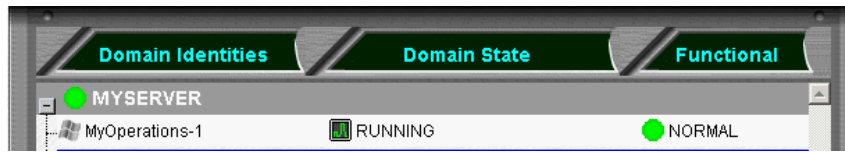

Figure 34. Domain state

5. Toggle the local / integrated console from the PAP unit display to the server display. See **toggling the Local / Integrated Console Display, on page 2-12.**
6. Wait for the Operating System to load completely. The domain is now fully functional.
7. Check the Operating System environment pre-installed on the domain.
8. Shut down the Operating System to power down the domain to the stand-by mode.
9. **Toggle the local / integrated console** to the PAP unit display. **INACTIVE** is displayed in the **Domain State** box and the **Power ON** button is accessible.

Notes:

- If the same PAP unit administers more than one server, all servers can be powered on simultaneously as follows:
 - a. Click **Multiple Power**. The **Multiple Power Domains On/Off** dialog opens.
 - b. Click **Power On All** → **Execute** to power on the servers and associated hardware components.
- For further details about the **Power ON / OFF** sequences, see **Powering ON a Domain** and **Powering OFF a Domain** in the *User's Guide*.

Shutting Down / Restarting the Server

1. From the PAM home page, click **File** → **Close** to return to the Microsoft Windows desktop.
2. Shut down the PAP unit by selecting the **Shut Down** command in the Start Menu.
3. Request the Customer to turn the power supply circuit breakers OFF.
4. Request the Customer to turn the power supply circuit breakers ON.

The Platform Management Board (PMB) in each CSS module automatically powers up to the standby mode (48V) and the Platform Administration Processor (PAP) unit automatically boots Microsoft Windows software. Server operation can now be checked.

Powering Up NovaScale 5xx5 Partitioned Server Domains

According to version, NovaScale 5xx5 Partitioned Servers are designed to operate as up to eight hardware-independent SMP systems, or domains.

For easy configuration and optimum use of the physical and logical resources required for simultaneous operation, domains are defined via the **PAM Domain Scheme** wizard. For further details about domain configuration, see *Configuring Domains*, in the *User's Guide*.



The server is delivered with a default scheme, or configuration file, called **MyOperationsScheme-xx**, containing up to eight domains:

- MyOperations-xx-1
- MyOperations-xx-2
- MyOperations-xx-3
- MyOperations-xx-4
- MyOperations-xx-5
- MyOperations-xx6
- MyOperations-xx7
- MyOperations-xx-8

This default scheme allows you to simultaneously boot all domains.

According to Customer requirements, identical or different Operating System instances may be pre-installed on each domain boot disk (EFI LUN).

Notes:

- **xx** in the default scheme and domain names represents the Central Subsystem HW identifier (from 00 to 15). For further details, refer to For further details, refer to *Checking PMB Code Wheel Settings*, on page 2-4.
- Operating System type is indicated by the Microsoft Windows  or Linux  logo in the **Domain Identities** box.
- A Scheme comprising 4 domains is used to illustrate the following example.

To power up / down server domains:



Note:

If an error dialog box appears during these sequences, see *Managing Domains* in the User's Guide.

1. From the Customer Administrator PAM Tree, click **Domain Manager** to open the **Control** pane. You are invited to load a **Domain Scheme**.
2. Click **Schemes**. The **Schemes List** dialog opens displaying the pre-configured scheme.
3. Select **MyOperationsScheme** and click **Apply**.

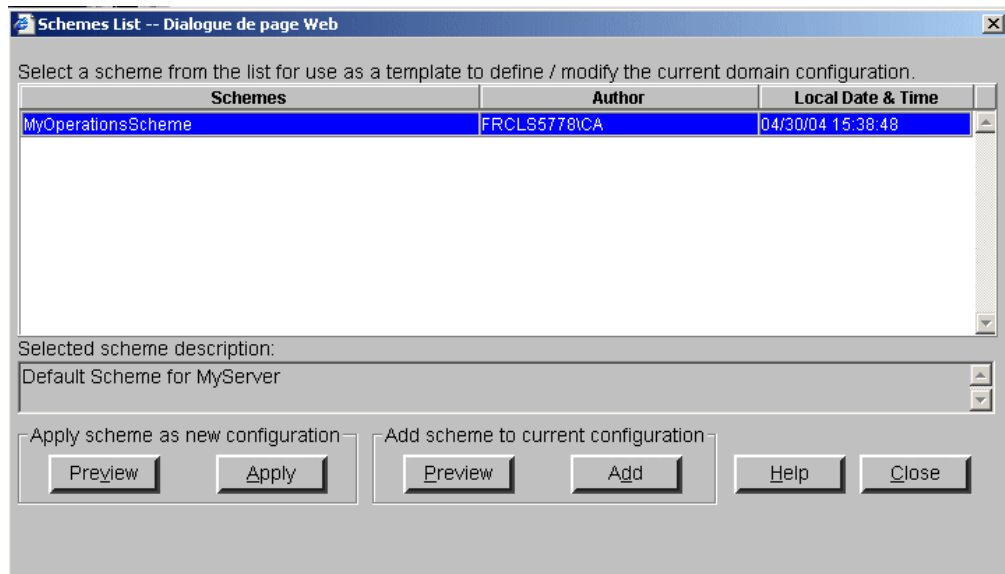
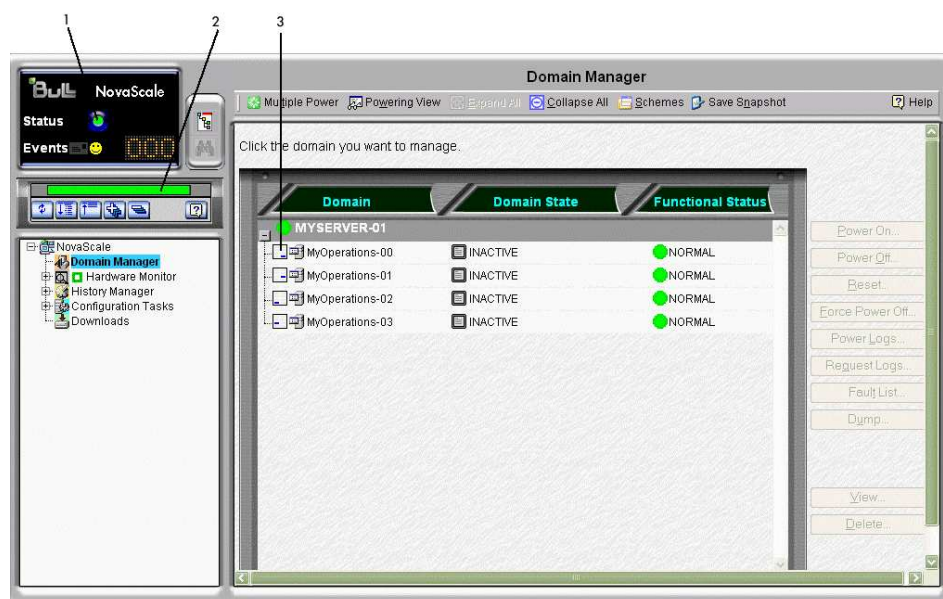

Figure 35. Domain schemes list dialog

4. When requested, click **Yes** to confirm. The default domains are loaded in the **Control** pane. If the domains are ready to be powered up, **INACTIVE** is displayed in the **Domain State** boxes and the **Power On** button is accessible for each domain.



1	Functional status icon
2	CSS availability status indicator (GREEN)
3	Operating system type

Figure 36. Domain Manager Control pane - example with 4 domains

5. Click **Multiple Power**. The **Multiple Power Domains On/Off** dialog opens.
6. Click **Power On All** → **Execute** to simultaneously power on the domains and associated hardware components.

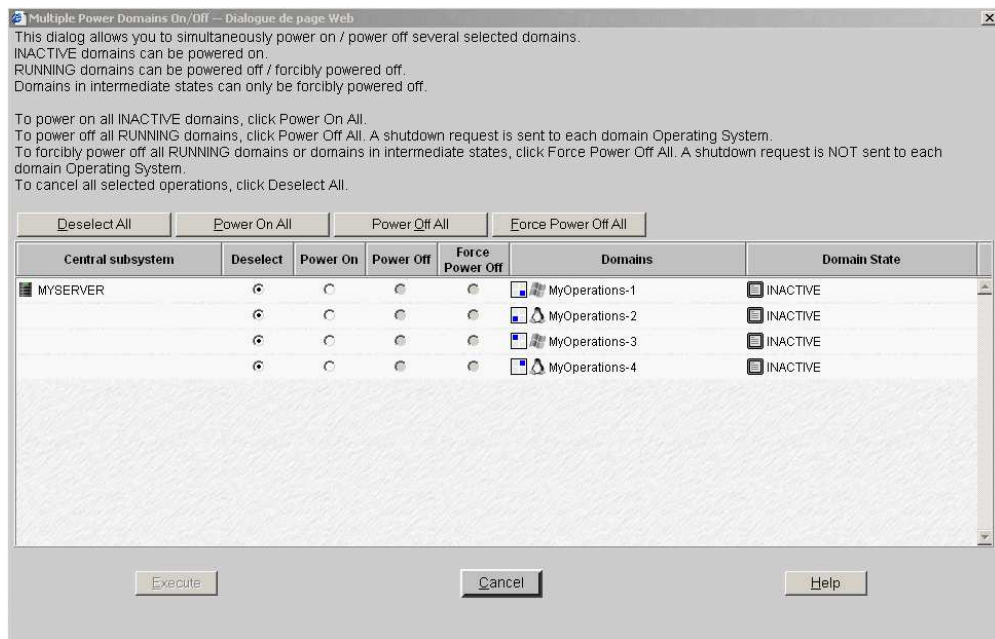

Figure 37. Multiple power dialog - example with 4 domains

Note:

Domains can also be powered on sequentially from the **Control** pane:

- Select a domain in the **Control** pane and click **Power On** to power up the domain and associated hardware components. Repeat this step for each domain in the **Control** pane.
7. Follow the power-on steps displayed in the **Domain State** boxes, until **RUNNING** is displayed in all **Domain State** boxes.

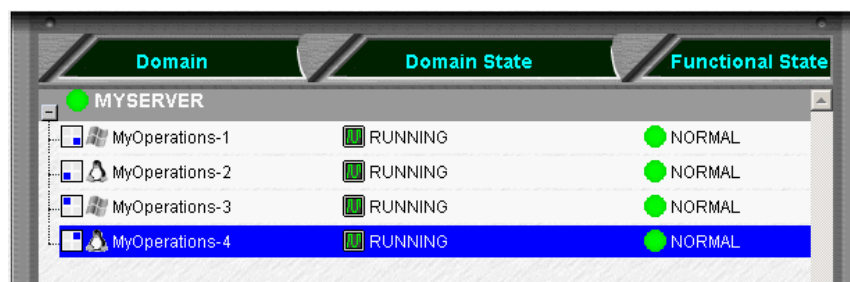

Figure 38. Domain state - example with 4 domains

8. Toggle the local / integrated console from the PAP unit display to the first domain display. See *toggling the Local / Integrated Console Display*, on page 2-12.
9. Wait for the Operating System to load completely. The domain is now fully functional.
10. Toggle the local / integrated console from this domain display to the next domain display.
11. Wait for the Operating System to load completely. The domain is now fully functional.

- 12.Repeat Steps 10 and 11 for each domain.
- 13.Check the Operating System environment pre-installed on each domain.
- 14.Shut down each Operating System to power down the corresponding domain to the stand-by mode.
- 15.Toggle the local / integrated console to the PAP unit display. **INACTIVE** is displayed in the **Domain State** boxes and the **Power ON** button is accessible for each domain.



Note:

For further details about the **Power ON / OFF** sequences, see *Powering ON a Domain* and *Powering OFF a Domain* in the *User's Guide*.

Shutting Down / Restarting the Server

1. From the PAM home page, click **File** → **Close** to return to the Microsoft Windows desktop.
2. Shut down the PAP unit by selecting the **Shut Down** command in the Start Menu.
3. Request the Customer to turn the power supply circuit breakers OFF.
4. Request the Customer to turn the power supply circuit breakers ON.

The Platform Management Board (PMB) in each CSS module automatically powers up to the standby mode (48V) and the Platform Administration Processor (PAP) unit automatically boots Microsoft Windows software.

Changing the iStorage Manager User Name and Password

FDA 1x00 FC and FDA 2x00 FC subsystems are delivered with iStorage Manager (iSM) software for integrated monitoring and centralized management.

The iSM Server / Client utility is installed on the PAP Unit desktop. The Customer can install iSM Client on any standard PC running under Microsoft Windows (2000 or later).

Before using iSM, the Customer is advised to replace the factory default User Name and Password.

To change the iStorage Manager User Name and Password:

1. From the PAP Unit Microsoft Windows desktop, click:
Start → **Programs** → **NEC Storage Manager Server** → **Setting Utility**.
2. Select the **Users** tab. The default User Name and User Level is displayed in the User List.

Default User Name	Administrator
Default User Level	L3
Default Password	administrator

3. Select **Administrator** from the User List and click **Edit** to open the **User - Edit** dialog box.
4. Change the User Name and Password and check that the **L3** radio button is highlighted.
5. Click **OK**.
6. A dialog box requests you to restart iSM to apply changes. Click **Yes**.
7. From the PAP Unit Microsoft Windows desktop, click:
Start → **Programs** → **Administrative Tools** → **Services**.
8. Select **NEC Storage Manager** → **Action** → **Stop** to stop iSM.
9. Click **Action** → **Start** to restart iSM. Changes are applied.



Note:

Please refer to the iSM documentation delivered with the server for further details.

Changing the S@N.IT Password

FDA 1x00 FC and FDA 2x00 FC subsystems are delivered with S@N.IT software for integrated monitoring and centralized management.

The S@N.IT Server / Client utility is installed on the PAP Unit desktop. The Customer can install S@N.IT Client on any standard PC running under Microsoft Windows (2000 or later).

Before using S@N.IT, the Customer is advised to replace the factory default **sanadmin** User Password.



Note:

The default **sanadmin** User Name CANNOT be changed.

To change the S@N.IT **sanadmin** User Password:

1. From the PAP Unit Microsoft Windows desktop, click:
Start → **Programs** → **S@N.IT**.
2. Enter the **Configuration** → **Set Password** menu.
3. Select the **sanadmin** user.
4. Type your new password in the **New Password** field.
5. Confirm your new password by retyping it in the **Confirm Password** field.
6. Click **OK** to save changes.



Note:

Please refer to the S@N.IT documentation delivered with the server for further details.

Completing PAP Unit Configuration



Important:

Before proceeding to complete PAP Unit configuration:

- Refer to the *PAM Writing Rules*, on page B-3
- Check **Regional, Date/Time, and Time Zone settings**

Changing the Default PAP Unit Name

Request the Customer to change the default PAP unit name <PAP> from the Microsoft Windows Network configuration utility.

To change the default PAP unit name:

7. From the Microsoft Windows desktop, select:
MyComputer → **Properties** → **Network Identification** → **Properties**.
8. Complete the fields as required.

Launching the PAP Configuration Setup Wizard

To complete PAP unit configuration:

1. Request the Customer to provide the *Installation Setup Data* listed in the *Read Me First* booklet enclosed in the *Open Me First* kit.
2. Open a new Microsoft Windows session with the predefined User Name and Password.

User Name	Administrator
Password	administrator

3. From the Microsoft Windows desktop, click:
Start → **Program Files** → **Platform Administration and Maintenance** → **PAP Configuration**
to launch the PAP configuration setup wizard which guides you through the PAP Unit configuration procedure (approximately 10 minutes).

The PAP configuration setup wizard dialog opens.

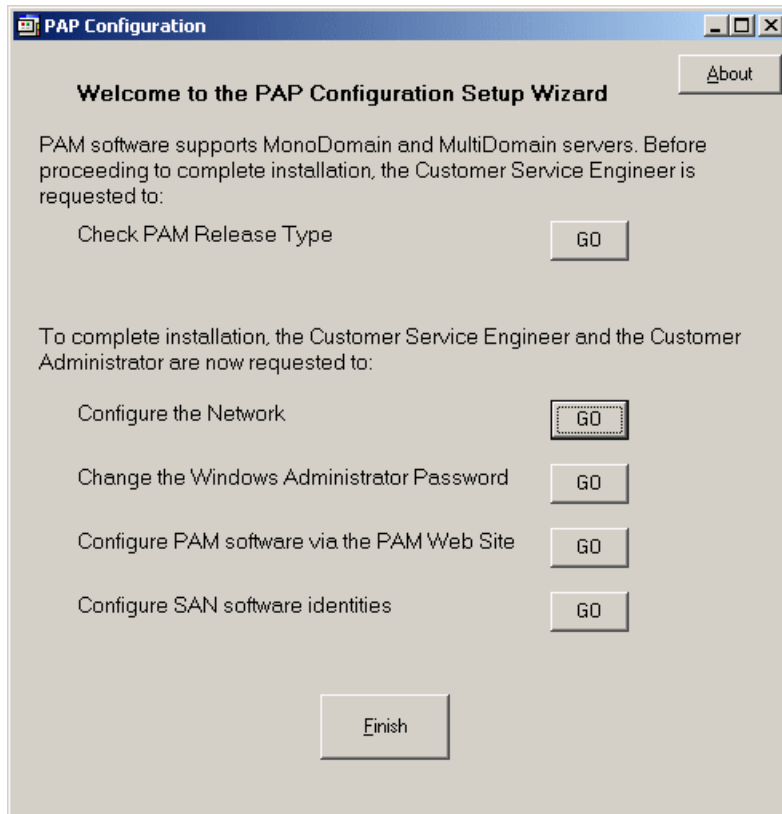

Figure 39. PAP configuration wizard dialog

4. Click the **Check PAM Release Type** button. The **Release Type** dialog opens.

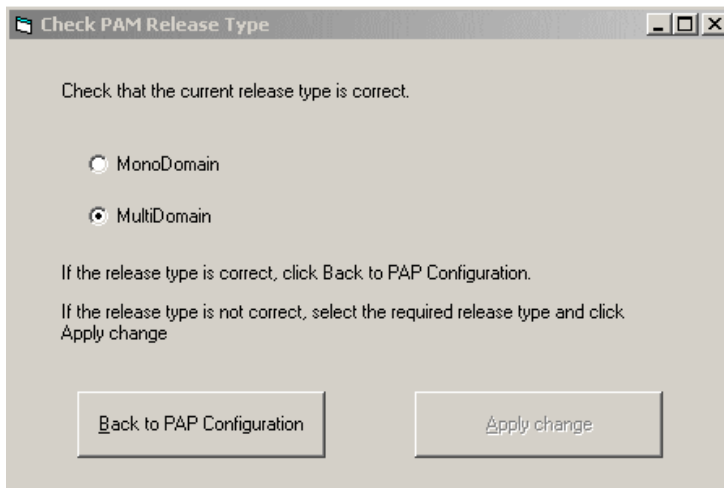

Figure 40. Release type dialog

5. Check that the release type is correct:
NovaScale 5xx5 Servers
The **MonoDomain** radio button must be highlighted.
NovaScale 5xx5 Partitioned Servers
The **MultiDomain** radio button must be highlighted.

 **Note:**

If the release type is not correct, select the required release type and click **Apply change**.

- a. Click the **Configure the Network** button to configure Customer Enterprise LAN settings and to change the default factory PAP unit network setting.

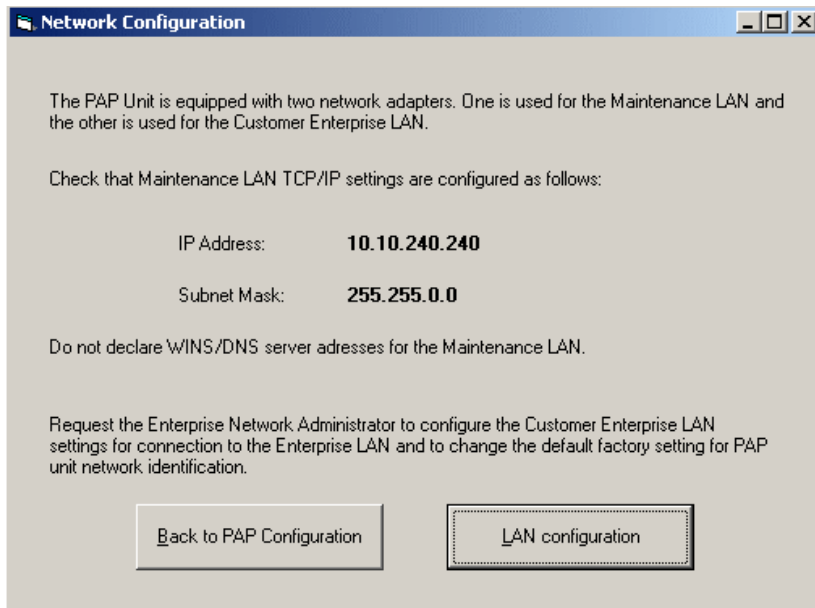

Figure 41. Network configuration dialog

- b. Click the **Change Windows Administrator Password** button to change the PAP unit Customer Administrator password.

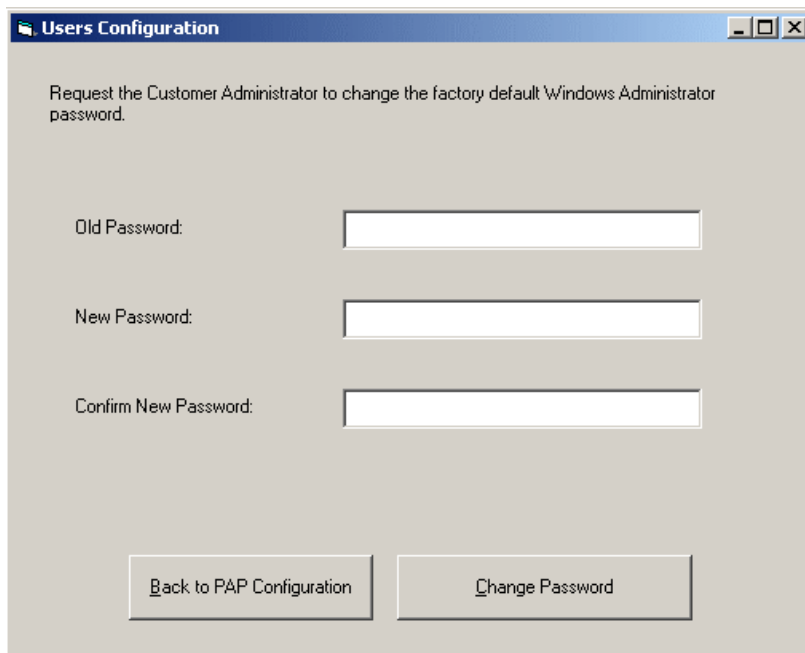

Figure 42. Users configuration dialog

- c. Click the **Configure PAM Software via the PAM Web Site** button to open a Support Administrator PAM session to complete **Customer Information**, **Autocalls** and **Central Subsystem** configuration.

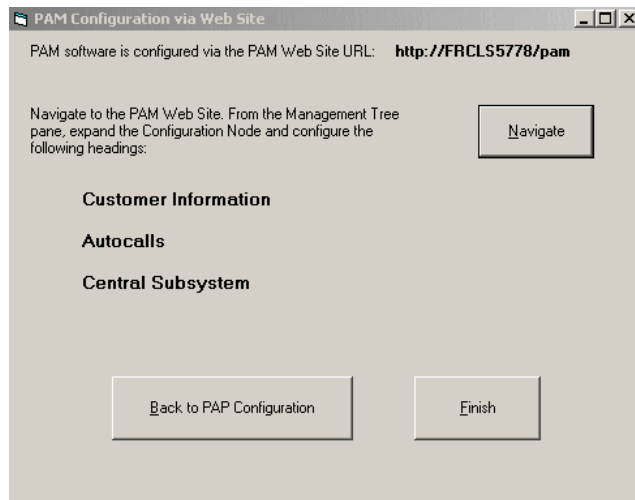

Figure 43. PAM configuration via Web site dialog

- d. Click the **Configure SAN Software Identities** button to change the default **S@N.IT** password and the **ISM** user name and password.

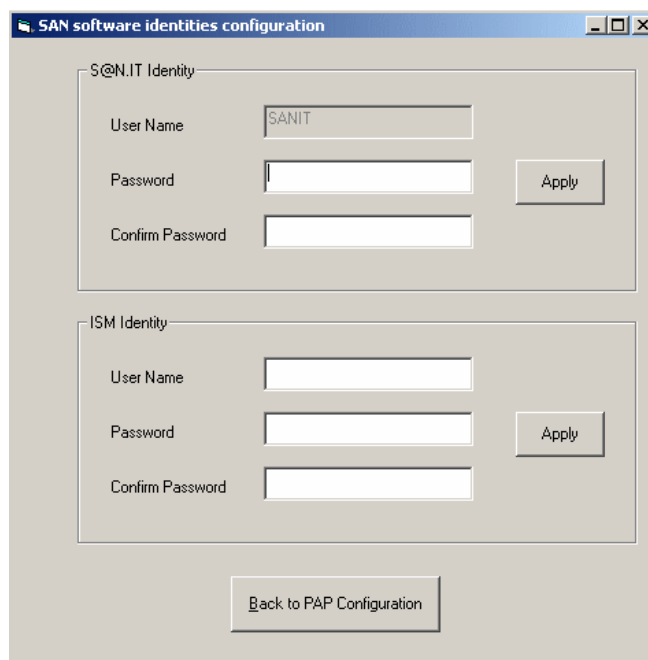

Figure 44. SAN software identities configuration dialog



Important:

You MUST enter the new S@N.IT and iSM user names and/or passwords previously set by the Customer. See:

- Changing the iStorage Manager User Name and Password, on page 2-22
- Changing the S@N.IT Password, on page 2-23



Warning:

Changes to Central Subsystem configuration are hazardous and must not be performed until the server has been fully tested.

If the Customer wants to rename the Central Subsystem, this entails removing the existing Central Subsystem and adding a new Central Subsystem with the required name. See *Configuring the Central Subsystem*, on page 2-47.

Configuring Customer Information

Customer information is used by PAM software:

- for the **PAM Tree** display: the name entered in the **Site name** field will be used for the PAM tree root node - the default name is **NovaScale..**
- to complete Customer Service Engineer Intervention Reports,
- to configure the Email server used to send messages via the e-mail channel. See *Creating an E-mail Server*, in the User's Guide.

To configure Customer information:

1. From the PAM Tree, click **Configuration Tasks** → **Customer Information**. The **Customer Information** configuration page opens.
2. Enter Customer data and click **Save** to confirm changes.

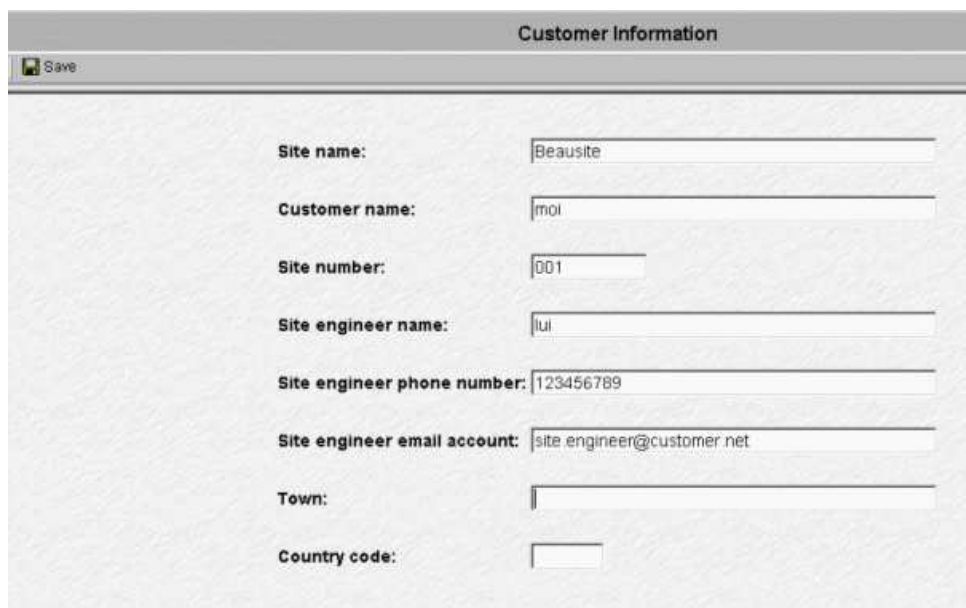

Site name:	<input type="text" value="Beausite"/>
Customer name:	<input type="text" value="moi"/>
Site number:	<input type="text" value="001"/>
Site engineer name:	<input type="text" value="iui"/>
Site engineer phone number:	<input type="text" value="123456789"/>
Site engineer email account:	<input type="text" value="site.engineer@customer.net"/>
Town:	<input type="text"/>
Country code:	<input type="text"/>

Figure 45. Customer Information configuration page

Configuring Autocalls

The **Autocall** feature is part of the BULL Remote Maintenance contract. It is used to automatically route system events to the Remote Maintenance Center. Full details are given in the *BULL Remote Maintenance Guide*.

If the Customer's maintenance contract includes the Autocall feature, configure Autocall parameters as follows:

Figure 46. Autocalls Channel Settings control pane

3. Select the **Enable Autocalls** checkbox.
4. Select the **Send Heartbeat** checkbox and enter a value "in days" for the autocall channel control in the **Period** box. Recommended value = 1.
5. Select the autocall dispatch mode :
 - **Local dispatch mode** (default mode) sends autocalls to the local target directory indicated under **Local Settings**,
 - **FTP dispatch mode** sends autocalls to the server indicated under **FTP Settings**.
6. If **Local dispatch mode** (default mode) is selected, complete the **Local Settings** field with the following information:

Field	Explanation	Value
Local target directory	Default GTS directory used to store autocalls.	c:\gts\session

7. If **FTP dispatch mode** is selected, complete the **FTP Settings** fields with the following information:

Field	Explanation	Value
Server name	Remote Maintenance Center server IP address	127.0.0.1
Server port	Default server port	21
Target directory	Default server directory	/autocall
Login	Declared authorized user name	X
Password	Declared authorized user password	X
Passive mode	FTP connection mode	check box

8. If a modem connection is to be used:
- From the PAP Unit Microsoft Windows desktop, configure the dial-up connection (**Control Panel** → **Phone and Modem Options**).
 - From the PAM **Autocalls Control Pane**, select the **Use modem connection** checkbox.
 - Use the **Connection name** drop-down menu to select the required modem connection.
 - Complete the **User name** and **Password** fields with the declared authorized user name and user password.
9. Return to the PAP Unit Microsoft Windows desktop to complete remote maintenance setup as explained in the BULL *Remote Maintenance Guide*.

 **Note:**

Connection of the USB modem required for the Autocall feature is explained in *Connecting the USB Modem and External Devices*, on page 2-45.

Connecting the PAP Unit to the Customer's Enterprise LAN



CAUTION:

Remote access via the Web is a potential security hazard. Customers are strongly advised to protect their systems with up-to-date protection devices such as virus-prevention programs and firewalls, and to maintain a detailed record of authorized users.

Once PAP unit configuration is complete, it can be connected to the Customer's Enterprise LAN.

The PAP unit provides two RJ45 Ethernet ports. The first is used for the internal server network and the second for connection to the Customer's Enterprise LAN for remote platform administration and maintenance.

1. Open the rear door and remove the left side cover.
2. Guide the Enterprise network cable supplied by the Customer through the cable cut-out at the base of the cabinet and up through the free space on the left side of the cabinet.
3. Access the PAP unit RJ45 Ethernet ports from the rear of the cabinet.



Free Ethernet port

Figure 47. PAP unit free Ethernet port

4. Secure the Enterprise network cable to the left flange of the cabinet with the velcro fasteners supplied in the *Open Me First* kit.
5. Close the rear door and refit the left side cover.



Important:

If the PAP unit is not connected to the Customer's Enterprise LAN, the remote maintenance autocal and certain event messaging options will not be enabled.

Connecting to the PAM Web Site from a Remote Computer/Workstation



Important:

For optimum security, before connecting to PAM from a remote computer, you are advised to disconnect from your local Windows session on the PAP unit by clicking Start → Log Off.

The PAM Software utility can be accessed from any PC running Microsoft Windows with the Internet Explorer (6 or later) browser installed **and/or from any workstation running Linux with the Mozilla (1.6 or later) browser installed.**

Enabling Remote Access to the PAM Web Site with Internet Explorer

1. From the remote computer, configure Internet Explorer to connect directly to the PAM Web site:
 - a. From the Internet Explorer main menu bar, select **Tools** → **Internet Options** → **Home Page**.
 - b. Type the PAM Web site URL defined during the PAP installation procedure in the home page address field: **http://<PAPname>/pam** (where **<PAPname>** is the name allocated to PAP unit during setup).
 - c. Save your changes and close Internet Explorer.
2. Launch Internet Explorer to connect directly to the PAM web site.
3. When prompted, enter the appropriate Administrator or Operator **User Name** and **Password**. The PAM home page appears.

Enabling Remote Access to the PAM Web Site with Mozilla

1. From the remote computer, configure Mozilla to connect directly to the PAM Web site:
 - a. From the Mozilla main menu bar, select **Edit** → **Preferences** → **Navigator**.
 - b. Check the **Home Page** box and enter the PAM Web site URL defined during the PAP installation procedure in the location field: **http://<PAPname>/pam** (where **<PAPname>** is the name allocated to PAP unit during setup).
 - c. Save your changes and close Mozilla.
2. Launch Mozilla to connect directly to the PAM web site.
3. When prompted, enter the appropriate Administrator or Operator **User Name** and **Password**. The PAM home page appears.

Enabling Remote Access to iSM on the Client Computer

FDA 1x00 FC and FDA 2x00 FC subsystems are delivered with iStorage Manager (iSM) for integrated monitoring and centralized management.

The iSM Server / Client utility is installed on the PAP Unit desktop. The Customer can install iSM Client on any standard PC running under Microsoft Windows (2000 or later).

To enable remote access to iSM:

1. Insert the iSM Client setup CD-Rom in the client computer.
2. Run the **CLIENT\2000\ISMCE211.EXE** program to launch the setup wizard which guides you through the iSM Client configuration procedure.
3. When you are requested to select **Setup Type**, click **basic + extended function** → **Next**.
4. Once setup is complete, launch iSM Client to connect to iSM Server. A dialog box appears requesting you to set the environment for iSM Client.
5. From the iSM Client menu, click **File** -> **Environment Settings** to open the **Server Settings** page.
6. In the **IP Address** field, enter the PAP unit IP address allocated during the PAP unit setup process. See *Completing PAP Unit Configuration*, on page 2-24.
7. Click **OK** to establish the connection.
8. When requested enter the User Name and Password and click **OK**. See *Changing the iStorage Manager User Name and Password*, on page 2-22.

Completing Operating System Setup

A list of the Customer data required to complete setup is given in the *Read Me First* booklet delivered with the system 24 hours before the scheduled installation date.



Note:

For further information about the server booting environment, see *Using EFI Utilities* in the *User's Guide*.

To complete Operating System setup, see:

- NovaScale 5xx5 SMP Servers - ***Operating System Setup***, on page 2-36
- NovaScale 5xx5 Partitioned Server - ***Operating System Setup***, on page 2-40



NovaScale 5xx5 SMP Servers - Operating System Setup

An Operating System instance is pre-installed on the domain boot disk:

0LU0 = LUN device located in Module0_DIB0 or connected to Module0_IOCO

Before proceeding to complete setup on the domain:

1. From the Customer Administrator PAM Tree, click **Domain Manager**.
MyOperations-1 domain is displayed in the **Control** pane.
2. Check Operating System type:

Microsoft Windows  or Linux  logo in the **Domain Identities** box.
3. Locate the DVD-Rom drive:
MyOperations-1: Module0, IPD0
4. Note the KVM port for the domain:
MyOperations-1: CSS0-Mod0-IO0
5. Check that the Customer has supplied the System and Networking data required to complete setup and customize the system. See the *Installation Setup Data* tables in the *Read Me First* document supplied on delivery.

To complete Operating System setup, see:

- *Microsoft Windows Setup*, on page 2-37
- *Linux Redhat Setup*, on page 2-38
- *Novell SuSe Setup*, on page 2-39

Microsoft Windows Setup



Warning:

Most of the options selected and validated during the setup sequence can be modified. However, special attention is to be paid when selecting and validating the Licensing Mode (Per Seat / Per Server). If selected and validated, the "Per Server" Licensing Mode option CAN be modified. If selected and validated, the "Per Seat" Licensing Mode CANNOT be modified.

1. Check that the Microsoft Windows CD-Rom labeled "**TO BE COMPLETED**" is ready for use and that the yellow sticker with the 25-character Microsoft Windows Product Key required to complete setup is clearly visible inside the cabinet.
2. Select the Microsoft Windows domain in the **Control** pane and click **Power On** to power up the domain and associated hardware components.
3. Toggle the local / integrated console from the PAP unit display to the domain display. See *Toggling the Local / Integrated Console Display*, on page 2-12.
4. Check Regional, Date/Time, and Time Zone settings under EFI.
5. The setup wizard is launched automatically and guides the Customer and the Customer Service Engineer through the setup completion procedure (approximately 30 minutes).

Once setup is complete, Microsoft Windows shuts down, the system domain is rebooted and the server configuration wizard is launched automatically.



Note:

Server configuration is a Customer-specific task and is not performed by the Customer Service Engineer during installation. Once the system has been fully installed, the Customer Administrator may launch this wizard to configure and manage Server Roles.

6. Close the server configuration wizard.
7. Shut down the domain and associated hardware components by selecting the **Shut Down** command in the **Start Menu**.
8. Toggle the local / integrated console from the domain display to the PAP unit display. See *Toggling the Local / Integrated Console Display*, on page 2-12.

Linux RedHat Setup

1. Select the Linux RedHat domain in the **Control** pane scheme and click **Power On** to power up the domain and associated hardware components.
2. Toggle the local / integrated console from the PAP unit display to the domain display. See *Toggle the Local / Integrated Console Display*, on page 2-12.
3. Check Regional, Date/Time, and Time Zone settings.
4. Place the Linux RedHat CD-Rom in the drive. Setup is completed via the Webmin administration tool:

a. Enter the Webmin URL:

http://<localhost>:10000. The **Login to Webmin** dialog box opens.

b. Enter the default User Name and Password, followed by **Enter**. The Webmin home page opens.

User Name	root
Password	root

- c. Click the **Networking** icon to open the Networking main page.
 - d. Click **Network Configuration** -> **Network Interfaces**. In the **Interfaces Activated at Boot Time** field, click **Add a new interface** to open the **Create Bootup Interface** configuration page. Complete the required fields with the data supplied by the Customer and click **Create**.
 - e. From the **Interfaces Activated at Boot Time** field, select the new interface. The **Edit Bootup Interface** page opens. Check settings and click **Save and Apply** -> **Return to network configuration**.
 - f. Click **Routing and Gateways** to open the **Routing and Gateways** configuration page. Complete the required fields with the data supplied by the Customer and click **Save** -> **Return to network configuration**.
 - g. Click **DNS Client** to open the **DNS Client Options** configuration page. Complete the required fields with the data supplied by the Customer and click **Save** -> **Return to network configuration**.
 - h. Click **Host Addresses** -> **Add a new host address** to open the **Host and Addresses** configuration box. Complete the required fields with the data supplied by the Customer and click **Create** -> **Return to host addresses list** -> **Return to network configuration** -> **Return to index** -> **System** -> **Bootup and Shutdown** to create a new bootup and shutdown action.
 - i. From the action list, select **Network** to display the **Edit Action** page and click **Restart Now** -> **Return to action** -> **Return to bootup and shutdown actions** -> **Return to index** -> **Log Out** to exit Webmin. Once setup is complete, the network is activated.
5. Shut down the domain and associated hardware components by selecting the **Shut Down** command in the **Start Menu**.
 6. Toggle the local / integrated console from the domain display to the PAP unit display. See *Toggle the Local / Integrated Console Display*, on page 2-12.

Novell SuSe Setup

1. Select the Linux SuSe domain in the **Control** pane scheme and click **Power On** to power up the domain and associated hardware components.
2. Toggle the local / integrated console from the PAP unit display to the domain display. See *Toggling the Local / Integrated Console Display*, on page 2-12.
3. Check Regional, Date/Time, and Time Zone settings.
4. Place the Linux SuSe CD-Rom in the drive. Setup is completed via the Yast Control Center administration tool:
 - a. Type the default User Name and Password, followed by **Enter**.

User Name	root
Password	root

- b. Enter **yast2** (graphical mode) or **yast** (non-graphical mode) to open the Yast Control Center main page.

Note:

- Use the **<Tab>** and **<Arrow>** keys to navigate through the menus.
- c. Click **Network/Basic** → **Network Card Configuration**.
 - d. Select the required network card and click **Configure**.
 - e. From the **Network Address Setup** page, select the setup method and complete the required fields with the data supplied by the Customer.
 - f. From the **Details settings** area, click **Host name and name server**. Complete the required fields and click **Next**.
 - g. From the **Details settings** area, click **Routing**. Complete the required fields and click **Next** to return to the **Network Card Configuration** page. Your network card is displayed in the **Already configured devices** area.
 - h. Click **Close** to exit Yast Control Center. Once setup is complete, the network is activated.
5. Shut down the domain and associated hardware components by selecting the **Shut Down** command in the **Start Menu**.
 6. Toggle the local / integrated console from the domain display to the PAP unit display. See *Toggling the Local / Integrated Console Display*, on page 2-12.

NovaScale 5xx5 Partitioned Server - Operating System Setup

An Operating System instance is pre-installed on each domain boot disk (EFI LUN):

- OLU0 = LUN device located in Module0_DIB0 or connected to Module0_IOC0
- OLU1 = LUN device located in Module0_DIB1 or connected to Module0_IOC1
- OLU2 = LUN device located in Module1_DIB0 or connected to Module1_IOC0
- OLU3 = LUN device located in Module1_DIB1 or connected to Module1_IOC1
- OLU4 = LUN device located in Module2_DIB0 or connected to Module2_IOC0
- OLU5 = LUN device located in Module2_DIB1 or connected to Module2_IOC1
- OLU6 = LUN device located in Module3_DIB0 or connected to Module3_IOC0
- OLU7 = LUN device located in Module3_DIB1 or connected to Module3_IOC1

According to Customer requirements, identical or different Operating System instances may be pre-installed on each EFI LUN. Operating System setup must be completed for each Operating System instance.

Before proceeding to complete setup on each domain:

1. From the Customer Administrator PAM Tree, click **Domain Manager**. The pre-installed domains are displayed in the **Control** pane.
2. Check Operating System type for each domain:

Microsoft Windows  or Linux  logo in the **Domain Identities** box.

3. Locate the corresponding CD-Rom drive:

- MyOperations-1:** Module0, DIB0
- MyOperations-2:** Module0, DIB1
- MyOperations-3:** Module1, DIB0
- MyOperations-4:** Module1, DIB1
- MyOperations-5:** Module2, DIB0
- MyOperations-6:** Module2, DIB1
- MyOperations-7:** Module3, DIB0
- MyOperations-8:** Module3, DIB1

4. Note KVM ports for each domain:

- MyOperations-1:** CSS0_Mod0_IO0
- MyOperations-2:** CSS0_Mod0_IO1
- MyOperations-3:** CSS0_Mod1_IO0
- MyOperations-4:** CSS0_Mod1_IO1
- MyOperations-5:** CSS0_Mod2_IO0
- MyOperations-6:** CSS0_Mod2_IO1
- MyOperations-7:** CSS0_Mod3_IO0
- MyOperations-8:** CSS0_Mod3_IO1

5. Check that the Customer has supplied the System and Networking data required to complete setup and customize the system. See the *Installation Setup Data* tables in the *Read Me First* document supplied on delivery.

To complete Operating System setup, see:

- **Microsoft Windows Setup, on page 2-41**
- **Linux Redhat Setup, on page 2-42**
- **Novell SuSe Setup, on page 2-43**

Microsoft Windows Setup



Warning:

Most of the options selected and validated during the setup sequence can be modified. However, special attention is to be paid when selecting and validating the Licensing Mode (Per Seat / Per Server). If selected and validated, the "Per Server" Licensing Mode option CAN be modified. If selected and validated, the "Per Seat" Licensing Mode CANNOT be modified.

1. Check that the Microsoft Windows CD-Rom labeled "**TO BE COMPLETED**" is ready for use and that the yellow sticker with the 25-character Microsoft Windows Product Key required to complete setup is clearly visible inside the cabinet.
2. Select the first Microsoft Windows domain in the **Control** pane and click **Power On** to power up the domain and associated hardware components.
3. Toggle the local / integrated console from the PAP unit display to **MyOperations-1** or **MyOperations-2** or **MyOperations-3** or **MyOperations-4** display, as required. See *Toggling the Local / Integrated Console Display*, on page 2-12.
4. Check Regional, Date/Time, and Time Zone settings under EFI.
5. The setup wizard is launched automatically and guides the Customer and the Customer Service Engineer through the setup completion procedure (approximately 30 minutes).

Once setup is complete, Microsoft Windows shuts down, the system domain is rebooted and the server configuration wizard is launched automatically.



Note:

Server configuration is a Customer-specific task and is not performed by the Customer Service Engineer during installation. Once the system has been fully installed, the Customer Administrator may launch this wizard to configure and manage Server Roles.

6. Close the server configuration wizard.
7. Shut down the domain and associated hardware components by selecting the **Shut Down** command in the **Start Menu**.
8. Toggle the local / integrated console from the domain display to the PAP unit display. See *Toggling the Local / Integrated Console Display*, on page 2-12.
9. Update **Domain Identity Management Parameters**:
 - a. From the Customer Administrator PAM Tree, click **Domains** → **Identities**.
 - b. Select the corresponding **Domain Identity** and click **Edit**. The **Edit Identity** dialog opens.
 - c. Complete the **Network Name**, **IP Address**, and **URL** fields with the data entered during the setup completion procedure.
10. Repeat steps 1 to 9 for each pre-installed Microsoft Windows instance.

Linux RedHat Setup

1. Select the first Linux RedHat domain in the **Control** pane scheme and click **Power On** to power up the domain and associated hardware components.
2. Toggle the local / integrated console from the PAP unit display to **MyOperations-1** or **MyOperations-2** or **MyOperations-3** or **MyOperations-4** display, as required. See *Toggle the Local / Integrated Console Display*, on page 2-12.
3. Check Regional, Date/Time, and Time Zone settings.
4. Place the Linux RedHat CD-Rom in the corresponding drive. Setup is completed via the Webmin administration tool:
 - a. Enter the Webmin URL:
http://<localhost>:10000. The **Login to Webmin** dialog box opens.
 - b. Enter the default User Name and Password, followed by **Enter**. The Webmin home page opens.

User Name	root
Password	root
 - c. Click the **Networking** icon to open the Networking main page.
 - d. Click **Network Configuration** → **Network Interfaces**. In the **Interfaces Activated at Boot Time** field, click **Add a new interface** to open the **Create Bootup Interface** configuration page. Complete the required fields with the data supplied by the Customer and click **Create**.
 - e. From the **Interfaces Activated at Boot Time** field, select the new interface. The **Edit Bootup Interface** page opens. Check settings and click **Save and Apply** → **Return to network configuration**.
 - f. Click **Routing and Gateways** to open the **Routing and Gateways** configuration page. Complete the required fields with the data supplied by the Customer and click **Save** → **Return to network configuration**.
 - g. Click **DNS Client** to open the **DNS Client Options** configuration page. Complete the required fields with the data supplied by the Customer and click **Save** → **Return to network configuration**.
 - h. Click **Host Addresses** → **Add a new host address** to open the **Host and Addresses** configuration box. Complete the required fields with the data supplied by the Customer and click **Create** → **Return to host addresses list** → **Return to network configuration** → **Return to index** → **System** → **Bootup and Shutdown** to create a new bootup and shutdown action.
 - i. From the action list, select **Network** to display the **Edit Action** page and click → **Restart Now** → **Return to action** → **Return to bootup and shutdown actions** → **Return to index** → **Log Out** to exit Webmin. Once setup is complete, the network is activated.
5. Shut down the domain and associated hardware components by selecting the **Shut Down** command in the **Start Menu**.
6. Toggle the local / integrated console from the domain display to the PAP unit display. See *Toggle the Local / Integrated Console Display*, on page 2-12.
7. Update **Domain Identity Management Parameters**:
 - a. From the Customer Administrator PAM Tree, click **Domains** → **Identities**.
 - b. Select the corresponding **Domain Identity** and click **Edit**. The **Edit Identity** dialog opens.
 - c. Complete the **Network Name**, **IP Address**, and **URL** fields with the data entered during the setup completion procedure.
8. Repeat steps 1 to 7 for each pre-installed Linux Redhat instance.

Novell SuSe Setup

1. Select the first Linux SuSe domain in the **Control** pane scheme and click **Power On** to power up the domain and associated hardware components.
2. Toggle the local / integrated console from the PAP unit display to **MyOperations-1** or **MyOperations-2** or **MyOperations-3** or **MyOperations-4** display, as required. See *Toggling the Local / Integrated Console Display*, on page 2-12.
3. Check Regional, Date/Time, and Time Zone settings.
4. Place the Linux SuSe CD-Rom in the corresponding drive. Setup is completed via the Yast Control Center administration tool:
 - a. Type the default User Name and Password, followed by **Enter**.

User Name	root
Password	root

- b. Enter **yast2** (graphical mode) or **yast** (non-graphical mode) to open the Yast Control Center main page.

Note:

- Use the **<Tab>** and **<Arrow>** keys to navigate through the menus.
- c. Click **Network/Basic** → **Network Card Configuration**.
 - d. Select the required network card and click **Configure**.
 - e. From the **Network Address Setup** page, select the setup method and complete the required fields with the data supplied by the Customer.
 - f. From the **Details settings** area, click **Host name and name server**. Complete the required fields and click **Next**.
 - g. From the **Details settings** area, click **Routing**. Complete the required fields and click **Next** to return to the **Network Card Configuration** page. Your network card is displayed in the **Already configured devices** area.
 - h. Click **Close** to exit Yast Control Center. Once setup is complete, the network is activated.
5. Shut down the domain and associated hardware components by selecting the **Shut Down** command in the **Start Menu**.
 6. Toggle the local / integrated console from the domain display to the PAP unit display. See *Toggling the Local / Integrated Console Display*, on page 2-12.
 7. Update **Domain Identity Management Parameters**:
 - a. From the Customer Administrator PAM Tree, click **Domains** → **Identities**.
 - b. Select the corresponding **Domain Identity** and click **Edit**. The **Edit Identity** dialog opens.
 - c. Complete the **Network Name**, **IP Address**, and **URL** fields with the data entered during the setup completion procedure.
 8. Repeat steps 1 to 7 for each pre-installed Linux SuSE instance.

Connecting the Server to the Enterprise LAN



Important:

Extra cable lengths of 1.5 meters are required for maintenance. These extra cable lengths must be absorbed in the plenum space under the cabinet.

At the Customer's request, server domains can be connected to the Enterprise LAN via the IOL board for remote operation.



Figure 48. 10/100/1000 Mb/s LAN port

To connect server domain(s) to the Enterprise LAN:

NovaScale 5xx5 Partitioned Servers

9. Locate the corresponding IOL board:

MyOperations-1: Module0, IOC0, IOL0

MyOperations-2: Module0, IOC1, IOL1

MyOperations-3: Module1, IOC0, IOL0

MyOperations-4: Module1, IOC1, IOL1

MyOperations-5: Module2, IOC0, IOL0

MyOperations-6: Module2, IOC1, IOL1

MyOperations-7: Module3, IOC0, IOL0

MyOperations-8: Module3, IOC1, IOL1

10. Locate the Ethernet 10/100/1000 Mb/s LAN RJ45 ports on each IOL board.

11. Connect the network cables equipped with an RJ45 connector to the IOL board LAN ports. Network connections are detected automatically.

12. Carefully route network cables through the cable inlet at the base of the cabinet.

Connecting the USB Modem and External Devices

Connecting the USB Modem

If the Customer's maintenance contract includes the Autocall feature, connect the USB modem as follows:

1. Connect the modem cable equipped with a USB connector to the USB port on the rear of the PAP unit.
2. Route the line modem cable equipped with an RJ11 connector through the cable cut-out at the base of the cabinet.
3. Connect the modem cable to the line port on the rear of the USB modem.
See the *Cabling Guide*, 86 A192ER.



Note:

Modem cable connectors differ from country to country. Customers are to provide the RJ11 adapter required to comply with national standards.

Connecting External Storage Peripherals

The Customer may now proceed to connect any external storage peripherals (tape libraries, external disk subsystems, ...) required for use with the server.

Testing Network Connections

Network connections to the PAP unit and to server domains can be tested from a remote workstation connected to the same network by launching a PING command.

**Note:**

PAP unit setup is described in *Completing PAP Unit Configuration*, on page 2-24.

Windows® Workstation

1. Click **Start** -> **Run** and enter **cmd**.
2. Enter **ping <IP_address>**, (where <IP_address> is the IP address allocated to the PAP unit or server domain during setup).

Linux® Workstation

1. Open a Shell command window.
2. Enter **ping <IP_address>**, (where <IP_address> is the IP address allocated to the PAP unit or server domain during setup).

**Note:**

If the PAP unit or server domain does not reply to the PING command, check network connections and configuration:

- IP address,
- DHCP,
- Network mask,
- Network card driver.

Testing Autocalls

If the Customer's maintenance contract includes the Autocall feature, check the connection between the PAP unit and the Remote Maintenance Center Server as follows:

1. From the PAM home page, click **Configuration Tasks** → **Autocalls**.
2. Click the **Test Autocall** button in the toolbar. A dialog appears to confirm that the autocall has been sent to the Remote Maintenance Center.

Completing the PAM Installation Intervention Report

Once system operation has been checked, an **Installation Intervention Report** must be completed. If the Customer's maintenance contract includes the Autocall feature, this report will be automatically transferred to the Remote Maintenance Center.

**Note:**

If the Customer's maintenance contract does not include the Autocall feature, manually complete the **Installation Work Order** provided in the **Open Me First** box. The intervention report is sent as an event message and stored in the PAM History directory. See the *User's Guide*.

1. From the PAM home page, click **Servicing Tools** → **Intervention Report**.
2. Complete the Intervention Report.
3. Click **Send**. If the Customer's maintenance contract includes the Autocall feature, the report is automatically transferred to the Remote Maintenance Center. If the Customer's maintenance contract does not include the Autocall feature, the report is sent as an event message and stored in the PAM History directory.

Renaming a Central Subsystem

Note:

Central Subsystem configuration is reserved for Customer Service Engineers.

The Central Subsystem may be renamed to suit Customer requirements. Changes to Central Subsystem configuration entail removing the existing Central Subsystem from the configuration and adding a new Central Subsystem to the configuration with the name chosen by the Customer.

Removing / Adding a Central Subsystem

1. From the Support Administrator PAM Tree, click **Domain Manager** to check that all domains are INACTIVE. If a domain is ACTIVE, request the Customer to power down the domain. See *Powering Up / Down Server Domains*, on page 2-16.
2. Click **Configuration Tasks** → **Central Subsystem**. The Central Subsystem control pane opens.
3. Select the Central Subsystem and click **Remove**. A dialog opens requesting you to confirm removal.
4. Click **OK** to remove the Central Subsystem.
5. Click **New**. The **Add Central Subsystem** dialog appears.

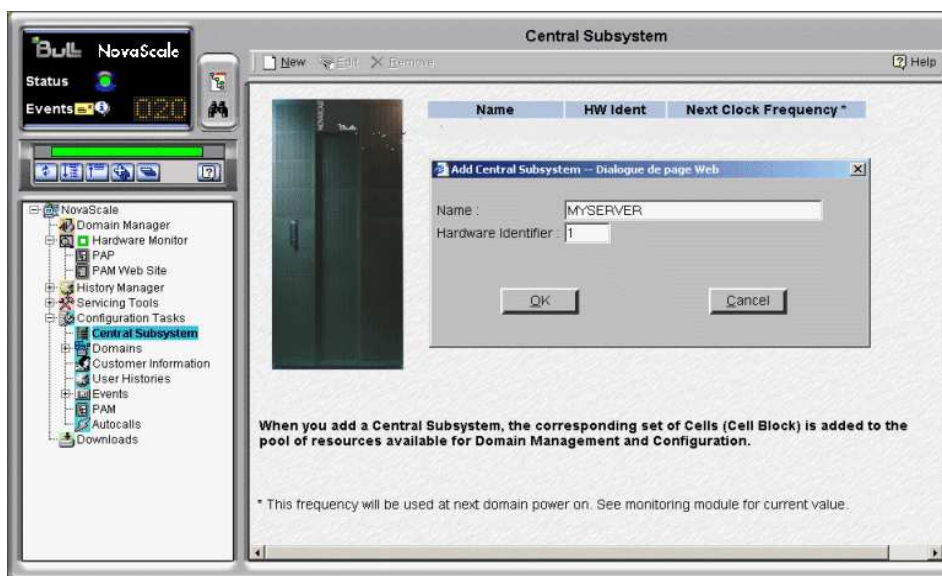

Figure 49. Central Subsystem control pane

6. Enter the Central Subsystem name supplied by the Customer and the hardware hexadecimal identifier (between 0 and F as indicated on the PMB CSS code wheel).

Note:

Up to 16 CSS modules can be linked, via a PMB to the PAP unit. PMB code wheels allow the identification of each cabinet and each CSS module in the Customer's configuration.

Note:

The Central Subsystem name is forced to uppercase characters by the system for compatibility reasons.

Example of PMB code wheel settings for a system with 3 cabinets, each containing 2 modules:

	Cabinet 1	Cabinet 2	Cabinet 3
Cabinet Hexadecimal Code (0 to F)	0	1	2
CSS Module_0 Hexadecimal Code (0 to F)	0	0	0
CSS Module_1 Hexadecimal Code (0 to F)	1	1	1

Table 3. PMB code wheel settings - multiple server configuration example

- Click **OK**. You are requested to update the PAM tree.
- Click the PAM tree  **Refresh** button. The new Central Subsystem is added to the pool of resources available for domain management and configuration and appears in the PAM tree under the **Hardware Monitor** node.

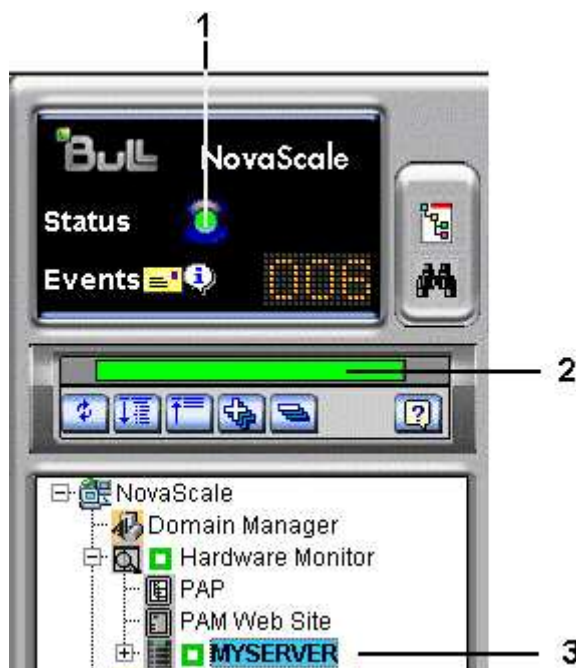

1	Functional status icon
2	CSS availability status bar
3	Central Subsystem

Figure 50. Central Subsystem node

- Check server status - system functional status icon and CSS availability status bar green in the Status pane. See Figure 27. Status pane, on page 2-9.



Note:

PAM software allocates a PUID (PAM Universal / Unique Identifier) to each hardware / software object to guarantee unambiguous identification.

The PUID for a Central Subsystem is:

PAM:/CELLSBLOCK_<NAME>,

where <NAME> is the name allocated by the Customer when the Central Subsystem is declared.

The PUID for the Central Subsystem in the example shown above is:

PAM:/CELLSBLOCK_MYSERVER

This PUID is used for the creation of Domain Schemes.

Setting up PAP Unit Users

The Customer Administrator should now set up at least one Customer Administrator and one Customer Operator user account to ensure controlled access to the PAP unit.

The Microsoft Windows operating system pre-installed on the PAP unit provides standard security features for controlling access to applications and resources. PAM software security is based on Windows® user management and you are advised to give Windows® administrator rights to at least one member of the PAP Customer Administrator user group. For further details about user management, refer to the Microsoft Windows documentation on the Bull NovaScale Server System Resource CD.



Note:

You are advised to change the temporary Administrator password (**administrator**) used for setup purposes and to maintain a detailed record of authorized users.

Predefined PAP User Groups

For optimum security and flexibility, the Microsoft Windows software environment is delivered with two predefined Customer user groups:

Pap_Customer_Administrators Group (CA)

This group is designed for customer representatives responsible for the overall management, configuration, and operation of the system. Members of the Customer Administrator group are allowed to configure and administrate the server and have full access to the PAM **Domain Manager**, **Hardware Monitor**, **History Manager** and **Configuration Tasks** menus, as shown in Table 4.

Pap_Customer_Operators (CO)

This group is designed for customer representatives responsible for the daily operation of the system. Members of the Customer Operator group are allowed to operate the server and have partial access to the **Domain Manager** and **History Manager** menus, as shown in Table 4.



Notes:

- Group membership also conditions which Event Messages a user will receive via the PAM Web interface. See *Setting up Event Subscriptions*, in the User's Guide.
- The predefined Customer user groups have been designed to suit the needs of most Administrator and Operators. Contact your Customer Service Engineer if you require a customized user group.



Warning:

The two predefined Support user groups:

- **Pap_Support_Administrators**
- **Pap_Support_Operators**

are reserved EXCLUSIVELY for authorized Customer Service Engineers in charge of monitoring, servicing, and upgrading the system.

PAM Tools	Associated Actions	CA	CO
Domain Manager	Synchronize domains	X	X
	View/load a domain configuration scheme	X	X
	Add domains to the current domain configuration	X	X
	Replace the current domain configuration	X	X
	Delete domains from the current domain configuration	X	
	Save the current domain configuration snapshot	X	
	Power on/off and reset domains	X	X
	Forcibly power off domains	X	X
	Perform a domain memory dump	X	X
	View domain settings	X	X
	View domain configuration, resources and status	X	X
	View domain BIOS info and version	X	X
	View domain fault lists	X	X
	View domain power and request logs	X	X
View domain powering sequences	X	X	
Hardware Monitor	View hardware functional/presence status	X	
	View detailed hardware status information	X	
	Use the hardware Search engine	X	
	Exclude/include hardware components	X	
	View current PAM Web site user information	X	
	View PAM version information	X	
History Manager	View system history files, messages and fault lists	X	
	Manually archive system history files	X	
	View/delete system history archives	X	
	View user history files	X	X
	Manually archive user history files	X	X
	View/delete user history archives	X	X
Configuration Tasks	View/modify customer information	X	
	Create/modify/delete domain schemes and identities	X	
	Manage Logical Units	X	
	Check/update FC HBA World Wide Names	X	
	Limit access to hardware resources	X	
	Modify the system history automatic archiving policy	X	
	Create/delete user histories	X	
	Modify the user history automatic archiving policy	X	
	Customize the event messaging system	X	
	View/ modify PAM parameters	X	
	Display/modify autocall parameters	X	
	Exclude / include ring connections	X	
Status Pane	View/acknowledge WEB event messages	X	X
	Check system functional status/CSS availability	X	X

CA = Customer Administrator / CO = Customer Operator

Table 4. User access to PAM features

Initializing the PAP Unit Backup Disk

The PAP Unit is delivered with two RAID 1 (hard mirror) disks installed and a third spare disk.

Now that the server has been installed and is operational and the PAP Unit and PAM software have been customized, you should now initialize the backup disk.

In the event of disk failure or logical data corruption, the backup disk can be easily used to repair the disk hard mirror.

The **Adaptec Storage Manager** utility is used to configure and monitor PAP Unit disks.

1. From the PAP Unit desktop, launch **Adaptec Storage Manager**, as shown in the following figure.

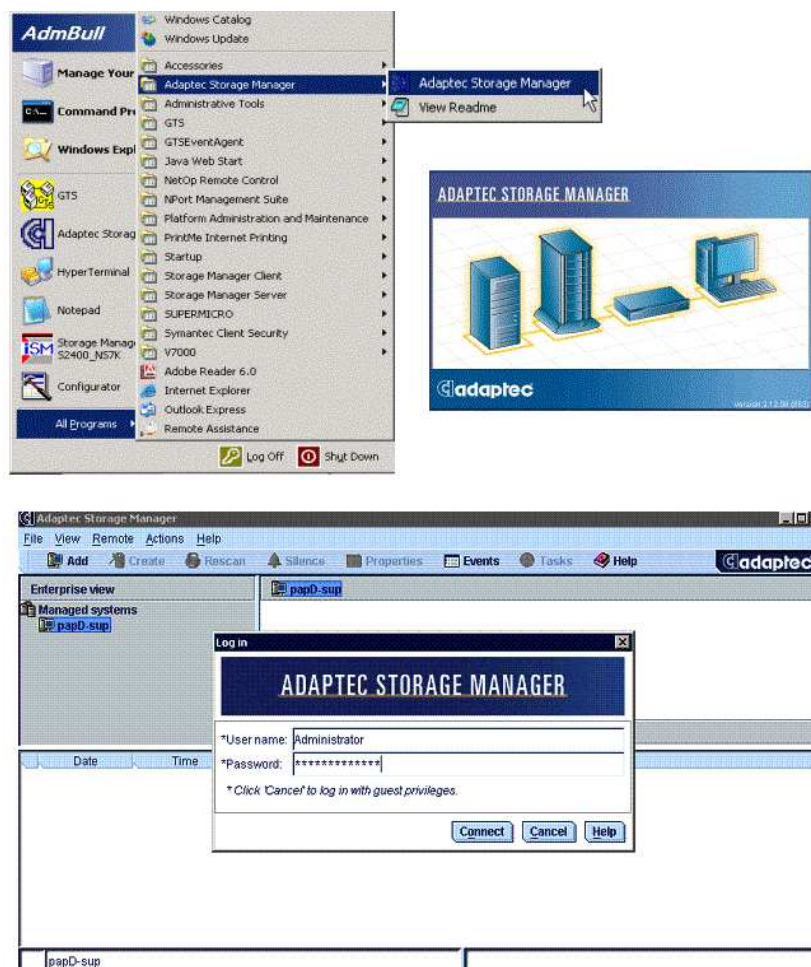

Figure 51. Launching Adaptec Storage Manager

2. Display PAP Unit disk configuration.

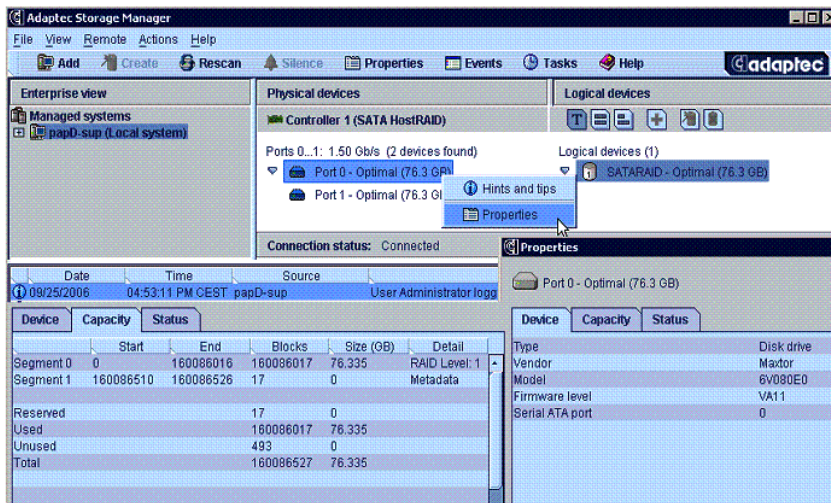

Figure 52. Displaying PAP Unit disk configuration

3. Check that backup disk configuration is the same as that of the two original disks installed in the PAP Unit.
4. Flush caches by powering down the PAP Unit.
5. Complete the **Comment** box with the reason for rebooting the PAP Unit, as shown in the following figure (A).

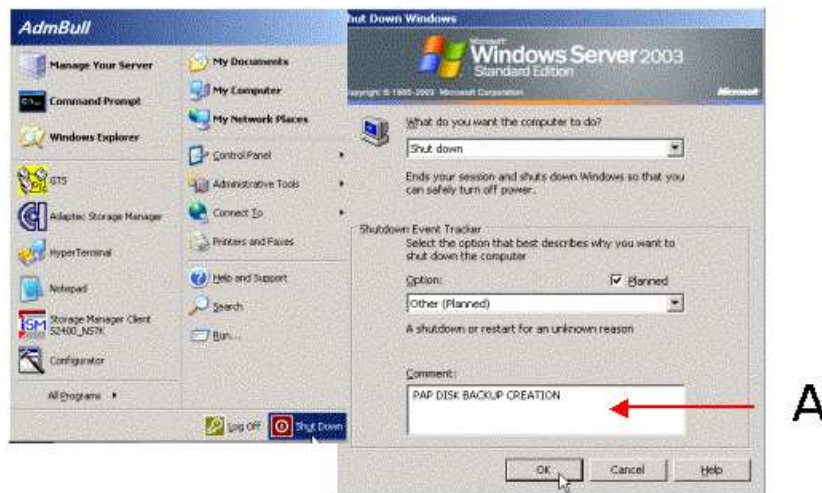

Figure 53. Rebooting the PAP Unit

6. Remove the **right** disk and store in a safe place. This disk is now the backup disk.

Note:

Whenever the backup disk needs to be updated, it is exchanged with the **right** disk which, in turn, becomes the backup disk.



Figure 54. Removing the right disk

7. Reboot the PAP Unit by pressing the Power On switch (A) in the above figure.
8. Wait for **Windows ready** and launch **Adaptec Storage Manager**.
9. Insert the blank (third) disk and monitor the building process.

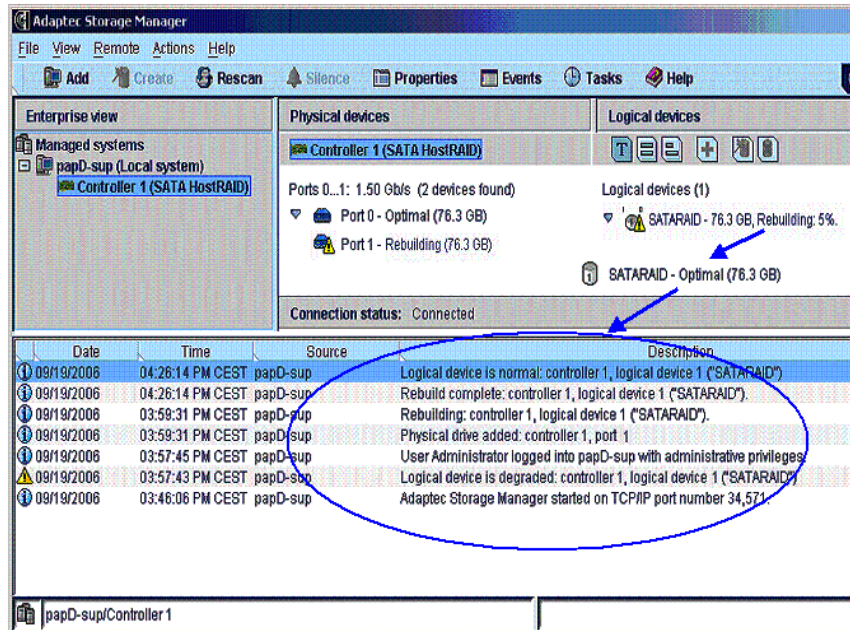

Figure 55. Blank disk building process

Backing Up and Restoring PAM Configuration Files

The Customer Administrator should now set up an automatic backup task via the Microsoft Windows **Task Scheduler** to save PAM configuration data to a removable media or to a network directory for rapid restoration in the event of a PAP unit failure.

To ensure carefree, reliable and regular configuration data backup, the Bull NovaScale Server Resource CD contains two scripts, **PamBackupData.js** and **PamRestoreData.js**, that can be scheduled to run via the Microsoft Windows **Task Scheduler** to save and restore PAM configuration data.

Notes:

- PAM configuration data is automatically saved to the default PAM Site Data directory on the PAP unit:

<WinDrive>:\Program Files\BULL\PAM\PAMSiteData\<DataCompatibilityRelease>

- The **PamBackupData.js** and **PamRestoreData.js** scripts are stored in the PAM Site Data directory on the PAP unit:

<WinDrive>:\Program Files\BULL\PAM\PAMSiteData\ReleaseData\Utilities

Backing Up PAM Configuration Files

To create a Microsoft Windows automatic backup task:

1. Select or create the local or network directory to be used for saving configuration data, e.g. **<MyPamBackupDirectory>**.
2. Create a local directory for the **PamBackupData.js** and **PamRestoreData.js** script files, e.g. **<MyPamBackupTools>**.
3. Copy the **PamBackupData.js** and **PamRestoreData.js** script files into the **<MyPamBackupTools>** directory.
4. Create a Text File and enter the following command line:
Cscript PamBackupData.js <MyPamBackupDirectory>
5. Save the Text File as a batch file with a **.BAT** extension, e.g. **<MyPamBackupCommand>.bat**.
6. Click **Control Panel** → **Scheduled Tasks** → **Add Scheduled Task** to open the **Task Scheduler** wizard and follow the instructions. PAM configuration data will be automatically saved at the interval indicated in the wizard.

Restoring PAM Configuration Data



Warning:

The same PAM software release must be deployed on the PAP unit and on the backup PC to allow data restoration.

See *Deploying a New PAM Release*, on page 0 and *Activating a PAM Version*, on page 0.

PAM releases use the same data directory to ensure configuration consistency.

Before activating / re-activating a PAM Version, ensure that the `<DataCompatibilityRelease>` level of deployed releases is compatible.



Warning:

The script file stops and restarts the PAM application before restoring PAM configuration data.

To restore PAM configuration data:

1. If required, install the same PAM software release on the backup PC as on the PAP unit. See *Deploying a New PAM Release* and *Activating a PAM Version* in the User's Guide.
2. From the Microsoft Windows desktop, open a command window. Browse to the `<MyPamBackupTools>` directory containing the script files and enter the following command line:

```
Cscript PamRestoreBackupData.js <MyPamBackupDirectory>
```

Saved PAM configuration data is restored.

Appendix A. Specifications

- NovaScale 5085 Server Specifications, on page A-2
- NovaScale 5165 Server Specifications, on page A-4
- NovaScale 5245 Server Specifications, on page A-6
- NovaScale 5325 Server Specifications, on page A-8

NovaScale 5085 Server Specifications

NovaScale 5085 Servers are delivered rack-mounted in 40U or 19U cabinets.

The following web site may be consulted for general site preparation information:

<http://www.cs.bull.net/aise>.

Cabinet Dimensions / Weight	
Unpacked	Packed
1300H	
Height: 195.5 cm (77.0 in)	Height: 200.0 cm (78.7 in)
Width: 60.0 cm (23.6 in)	Width: 80.0 cm (31.5 in)
Depth: 129.5 cm (51.0 in)	Depth: 140.0 cm (55.1 in)
Weight (max): 340 kg (725 lb)	Weight (max): 370 kg (790 lb)
1300L	
Height: 103.5 cm (40.7 in)	Height: 108.0 cm (42.5 in)
Width: 60.0 cm (23.6 in)	Width: 80.0 cm (31.5 in)
Depth: 129.5 cm (51.0 in)	Depth: 140.0 cm (55.1 in)
Weight (max.): 290 kg (618 lb)	Weight (max.): 320 kg (682 lb)
Service Clearance	
Front	150 cm
Rear	100 cm
Side (free side)	100 cm
Operating Limits	
Dry bulb temperature range	+15°C to +30°C (+59°F to +86°F) Gradient 5°C/h (41°F/h)
Relative humidity (non-condensing)	35 to 60% (Gradient 5%/h)
Max. wet bulb temperature	+24°C (+75.2°F)
Moisture content	0.019 kg water/kg dry air
Pressure / Elevation	Sea level ≤ 2500 m
Optimum Operational Reliability	
Temperature	+ 22°C (± 3°C) (+ 72°F (± 5°F)
Hygrometry	50% (± 5%)
Non-Operating Limits	
Dry bulb temperature range	+5°C to +50°C (+41°F to +122°F) Gradient 25°C/h (77°F/h)
Relative humidity (non-condensing)	5 to 95% (Gradient 30%)
Max. wet bulb temperature	+28°C (+82.4°F)
Moisture content	0.024 kg water/kg dry air
Shipping Limits	
Dry bulb temperature range	-35°C to +65°C (-31°F to +149°F) Gradient 25°C/h (77°F/h)
Relative humidity (non-condensing)	5 to 95% Gradient 30%/h
Acoustic Power at Room Temperature +20° C (+68° F)	
System Running	System Idle
Lw(A) 6.3 Bels	Lw(A) 6.1 Bels

Power Cables	
PDU-2-4-M-32A	
AC (32A) Cable type Connector type	1 per PDU 3 x AWG10 (3 x 6 mm ² / #10US) IEC60309-32A
It is mandatory for power lines and terminal boxes to be located within the immediate vicinity of the system and to be easily accessible. Each power line must be connected to a separate, independent electrical panel and bipolar circuit breaker. PDUs require an extra cable length of 1.5 meters for connection inside the cabinet.	
Electrical Specifications (power supplies are auto-sensing and auto-ranging)	
Current draw Power consumption Thermal dissipation	11 A max. at 200 VAC input 2400 VA per full CSS module 2400 W / 8190 BTU per full CSS module
Europe	
Nominal voltage Voltage range Frequency	230 VAC (Phase / Neutral) 207 - 244 VAC 50 Hz 1%
United States of America	
Nominal voltage Voltage range Frequency	208 VAC (Phase / Neutral) 182 - 229 VAC 60 Hz 0.3%
Japan	
Nominal voltage Voltage range Frequency	200 VAC (Phase / Neutral) 188 - 212 VAC 60 Hz 0.2%
Brazil	
Nominal voltage Voltage range Frequency	220 VAC (Phase / Neutral) 212 - 231 VAC 60 Hz 2%
Breaker Protection (Mains Power)	
PDU-2-4-M-32A Maximum inrush current	32A Curve C 210A / per quarter period

Table 5. NovaScale 5085 Server specifications

NovaScale 5165 Server Specifications

NovaScale 5165 Servers are delivered rack-mounted in 40U or 19U cabinets.

The following web site may be consulted for general site preparation information:

<http://www.cs.bull.net/aise>.

Cabinet Dimensions / Weight	
Unpacked	Packed
1300H	1300H
Height: 195.5 cm (77.0 in)	Height: 200.0 cm (78.7 in)
Width: 60.0 cm (23.6 in)	Width: 80.0 cm (31.5 in)
Depth: 129.5 cm (51.0 in)	Depth: 140.0 cm (55.1 in)
Weight (max): 450 kg (959 lb)	Weight (max): 480 kg (1022 lb)
1300L	1300L
Height: 103.5 cm (40.7 in)	Height: 108.0 cm (42.5 in)
Width: 60.0 cm (23.6 in)	Width: 80.0 cm (31.5 in)
Depth: 129.5 cm (51.0 in)	Depth: 140.0 cm (55.1 in)
Weight (max.): 400 kg (852 lb)	Weight (max.): 430 kg (915 lb)
Service Clearance	
Front	150 cm
Rear	100 cm
Side (free side)	100 cm
Operating Limits	
Dry bulb temperature range	+15°C to +30°C (+59°F to +86°F) Gradient 5°C/h (41°F/h)
Relative humidity (non-condensing)	35 to 60% (Gradient 5%/h)
Max. wet bulb temperature	+24°C (+75.2°F)
Moisture content	0.019 kg water/kg dry air
Pressure / Elevation	Sea level ≤ 2500 m
Optimum Operational Reliability	
Temperature	+ 22°C (± 3°C) (+ 72°F (± 5°F)
Hygrometry	50% (± 5%)
Non-Operating Limits	
Dry bulb temperature range	+5°C to +50°C (+41°F to +122°F) Gradient 25°C/h (77°F/h)
Relative humidity (non-condensing)	5 to 95% (Gradient 30%)
Max. wet bulb temperature	+28°C (+82.4°F)
Moisture content	0.024 kg water/kg dry air
Shipping Limits	
Dry bulb temperature range	-35°C to +65°C (-31°F to +149°F) Gradient 25°C/h (77°F/h)
Relative humidity (non-condensing)	5 to 95% Gradient 30%/h

Acoustic Power at Room Temperature +20° C (+68° F)	
System Running	System Idle
Lw(A) 6.3 Bels	Lw(A) 6.1 Bels
Power Cables	
PDU-2-4-M-32A	
AC (32A) Cable type Connector type	1 per PDU 3 x AWG10 (3 x 6 mm ² / #10US) IEC60309-32A
It is mandatory for power lines and terminal boxes to be located within the immediate vicinity of the system and to be easily accessible. Each power line must be connected to a separate, independent electrical panel and bipolar circuit breaker. PDUs require an extra cable length of 1.5 meters for connection inside the cabinet.	
Electrical Specifications (power supplies are auto-sensing and auto-ranging)	
Current draw Power consumption Thermal dissipation	11 A max. at 200 VAC input 2400 VA per full CSS module 2400 W / 8190 BTU per full CSS module
Europe	
Nominal voltage Voltage range Frequency	230 VAC (Phase / Neutral) 207 - 244 VAC 50 Hz 1%
United States of America	
Nominal voltage Voltage range Frequency	208 VAC (Phase / Neutral) 182 - 229 VAC 60 Hz 0.3%
Japan	
Nominal voltage Voltage range Frequency	200 VAC (Phase / Neutral) 188 - 212 VAC 60 Hz 0.2%
Brazil	
Nominal voltage Voltage range Frequency	220 VAC (Phase / Neutral) 212 - 231 VAC 60 Hz 2%
Breaker Protection (Mains Power)	
PDU-2-4-M-32A Maximum inrush current	32A Curve C 210A / per quarter period

Table 6. NovaScale 5165 Server specifications

NovaScale 5245 Server Specifications

NovaScale 5245 Servers are delivered rack-mounted in 40U cabinets.

The following web site may be consulted for general site preparation information:

<http://www.cs.bull.net/aise>.

Cabinet Dimensions / Weight	
Unpacked	Packed
1300H	1300H
Height: 195.5 cm (77.0 in)	Height: 200.0 cm (78.7 in)
Width: 60.0 cm (23.6 in)	Width: 80.0 cm (31.5 in)
Depth: 129.5 cm (51.0 in)	Depth: 140.0 cm (55.1 in)
Weight (max): 560 kg (1193 lb)	Weight (max): 590 kg (1257 lb)
Service Clearance	
Front	150 cm
Rear	100 cm
Side (free side)	100 cm
Operating Limits	
Dry bulb temperature range	+15°C to +30°C (+59°F to +86°F) Gradient 5°C/h (41°F/h)
Relative humidity (non-condensing)	35 to 60% (Gradient 5%/h)
Max. wet bulb temperature	+24°C (+75.2°F)
Moisture content	0.019 kg water/kg dry air
Pressure / Elevation	Sea level ≤ 2500 m
Optimum Operational Reliability	
Temperature	+ 22°C (± 3°C) (+ 72°F (± 5°F)
Hygrometry	50% (± 5%)
Non-Operating Limits	
Dry bulb temperature range	+5°C to +50°C (+41°F to +122°F) Gradient 25°C/h (77°F/h)
Relative humidity (non-condensing)	5 to 95% (Gradient 30%)
Max. wet bulb temperature	+28°C (+82.4°F)
Moisture content	0.024 kg water/kg dry air
Shipping Limits	
Dry bulb temperature range	-35°C to +65°C (-31°F to +149°F) Gradient 25°C/h (77°F/h)
Relative humidity (non-condensing)	5 to 95% Gradient 30%/h
Acoustic Power at Room Temperature +20° C (+68° F)	
System Running	System Idle
Lw(A) 6.3 Bels	Lw(A) 6.1 Bels

Power Cables	
PDU-2-4-M-32A	
AC (32A) Cable type Connector type	1 per PDU 3 x AWG10 (3 x 6 mm ² / #10US) IEC60309-32A
It is mandatory for power lines and terminal boxes to be located within the immediate vicinity of the system and to be easily accessible. Each power line must be connected to a separate, independent electrical panel and bipolar circuit breaker. PDUs require an extra cable length of 1.5 meters for connection inside the cabinet.	
Electrical Specifications (power supplies are auto-sensing and auto-ranging)	
Current draw Power consumption Thermal dissipation	11 A max. at 200 VAC input 2400 VA per full CSS module 2400 W / 8190 BTU per full CSS module
Europe	
Nominal voltage Voltage range Frequency	230 VAC (Phase / Neutral) 207 - 244 VAC 50 Hz 1%
United States of America	
Nominal voltage Voltage range Frequency	208 VAC (Phase / Neutral) 182 - 229 VAC 60 Hz 0.3%
Japan	
Nominal voltage Voltage range Frequency	200 VAC (Phase / Neutral) 188 - 212 VAC 60 Hz 0.2%
Brazil	
Nominal voltage Voltage range Frequency	220 VAC (Phase / Neutral) 212 - 231 VAC 60 Hz 2%
Breaker Protection (Mains Power)	
PDU-2-4-M-32A Maximum inrush current	32A Curve C 210A / per quarter period

Table 7. NovaScale 5245 Server specifications

NovaScale 5325 Server Specifications

NovaScale 5325 Servers are delivered rack-mounted in 40U cabinets.

The following web site may be consulted for general site preparation information:

<http://www.cs.bull.net/aise>.

Cabinet Dimensions / Weight	
Unpacked	Packed
1300H	1300H
Height: 195.5 cm (77.0 in)	Height: 200.0 cm (78.7 in)
Width: 60.0 cm (23.6 in)	Width: 80.0 cm (31.5 in)
Depth: 129.5 cm (51.0 in)	Depth: 140.0 cm (55.1 in)
Weight (max): 670 kg (1427 lb)	Weight (max): 700 kg (1491 lb)
Service Clearance	
Front	150 cm
Rear	100 cm
Side (free side)	100 cm
Operating Limits	
Dry bulb temperature range	+15°C to +30°C (+59°F to +86°F) Gradient 5°C/h (41°F/h)
Relative humidity (non-condensing)	35 to 60% (Gradient 5%/h)
Max. wet bulb temperature	+24°C (+75.2°F)
Moisture content	0.019 kg water/kg dry air
Pressure / Elevation	Sea level ≤ 2500 m
Optimum Operational Reliability	
Temperature	+ 22°C (± 3°C) (+ 72°F (± 5°F)
Hygrometry	50% (± 5%)
Non-Operating Limits	
Dry bulb temperature range	+5°C to +50°C (+41°F to +122°F) Gradient 25°C/h (77°F/h)
Relative humidity (non-condensing)	5 to 95% (Gradient 30%)
Max. wet bulb temperature	+28°C (+82.4°F)
Moisture content	0.024 kg water/kg dry air
Shipping Limits	
Dry bulb temperature range	-35°C to +65°C (-31°F to +149°F) Gradient 25°C/h (77°F/h)
Relative humidity (non-condensing)	5 to 95% Gradient 30%/h
Acoustic Power at Room Temperature +20° C (+68° F)	
System Running	System Idle
Lw(A) 6.3 Bels	Lw(A) 6.1 Bels

Power Cables	
PDU-2-4-M-32A	
AC (32A) Cable type Connector type	1 per PDU 3 x AWG10 (3 x 6 mm ² / #10US) IEC60309-32A
It is mandatory for power lines and terminal boxes to be located within the immediate vicinity of the system and to be easily accessible. Each power line must be connected to a separate, independent electrical panel and bipolar circuit breaker. PDUs require an extra cable length of 1.5 meters for connection inside the cabinet.	
Electrical Specifications (power supplies are auto-sensing and auto-ranging)	
Current draw Power consumption Thermal dissipation	11 A max. at 200 VAC input 2400 VA per full CSS module 2400 W / 8190 BTU per full CSS module
Europe	
Nominal voltage Voltage range Frequency	230 VAC (Phase / Neutral) 207 - 244 VAC 50 Hz 1%
United States of America	
Nominal voltage Voltage range Frequency	208 VAC (Phase / Neutral) 182 - 229 VAC 60 Hz 0.3%
Japan	
Nominal voltage Voltage range Frequency	200 VAC (Phase / Neutral) 188 - 212 VAC 60 Hz 0.2%
Brazil	
Nominal voltage Voltage range Frequency	220 VAC (Phase / Neutral) 212 - 231 VAC 60 Hz 2%
Breaker Protection (Mains Power)	
PDU-2-4-M-32A Maximum inrush current	32A Curve C 210A / per quarter period

Table 8. NovaScale 5325 Server specifications

Appendix B. Conversion, Keyboard, and Writing Tables

Imperial to Metric

1 inch (")	2.54 cm (centimeters)
1 foot (') (12 inches)	30.48 cm
1 yards (yd) (3 feet)	0.91 m (meters)
1 mile (mi) (1760 yards)	1.6093 km (kilometers)
1 pound (avdp) (lb)	0.5 kg (kilograms)
1 ounce (avdp) (oz)	28.4 g (grams)
1 square foot (ft ²)	0.093 m ² (square meters)
1 square inch (in ²)	6.5 cm ² (square centimeters)
1 square yard (yd ²)	0.8 m ² (square meters)
1 acre	0.4 ha (hectares)
1 cubic foot (ft ³)	0.03 m ³ (cubic meters)
1 horsepower (hp)	0.7 kw (kilowatts)
1 lb/ft ²	4.88 kg/m ²
1 Btu	0.2929 w hour

Table 9. Imperial to metric conversion table

Metric to Imperial

1 meter (meter)	3.3' (feet) / 1.09 yd (yards)
1 centimeter (cm)	0.3937" (inches)
1 kilometer (km)	0.62 mi (miles)
1 gram (g)	0.04 oz (ounces (avdp))
1 kilogram (kg)	2.2 lbs (pounds (avdp))
1 sq. centimeter (cm ²)	0.15 in ² (square inches)
1 square meter (m ²)	10.76 ft ² (square feet)
1 square meter (m ²)	1.2 yd ² (square yards)
1 hectare (ha)	2.5 acres
1 cubic meters (m ³)	35.3 ft ³ (cubic feet)
1 kilowatts (kW)	1.3 hp (horsepower)
1 kg/m ²	0.205 lb/ft ²
1 kW hour	3412 Btu (British thermal unit)

Table 10. Metric to imperial conversion table

Celsius to Fahrenheit Conversion

Multiply the temperature in Celsius by 9, divide by 5 and add 32:

$$(C \times 9/5) + 32 = F$$

Fahrenheit to Celsius Conversion

Subtract 32 degrees from the temperature in Fahrenheit, multiply by 5 and divide by 9:

$$(F - 32) \times 5/9 = C$$

AZERTY/QWERTY Keyboard Lookup Table

	1	2	3	4	5	6	7	8	9	0	°	+
z	&	é ~	" #	' { ([- è ' _ \ ç ^ à @)] = }								
A	Z	E	R	T	Y	U	I	O	P	^	£	*
Q	S	D	F	G	H	J	K	L	M	%	µ	*
>	W	X	C	V	B	N	?	.	/	\$		
<							,	;	:	!		

Figure 56. AZERTY keyboard

~	!	@	#	\$	%	^	&	*	()	-	+
'	1	2	3	4	5	6	7	8	9	0	-	=
Q	W	E	R	T	Y	U	I	O	P	{	}	
A	S	D	F	G	H	J	K	L	:	;	'	\
	Z	X	C	V	B	N	M	<	>	?		
							,	.	/			

Figure 57. QWERTY keyboard

PAM Writing Rules

Illegal Characters

The following table lists the illegal characters that must not be used in PAM identifiers.

Illegal Characters	
à, é, è, ù, ^, "	Accented letters
/	Slash
\	Backslash
"	Double quote
'	Simple quote
`	Inverted comma
&	Ampersand
+	Plus
*	Asterisk
%	Percent
=	Equal sign
<	Less-than sign
>	Greater-than sign
:	Colon
!	Exclamation mark
?	Question mark
;	Semi-colon
,	Comma
~	Tilde
	Pipe operator
	Space. Use - (dash) or _ (underscore)

Table 11. PAM illegal characters

String Lengths

The following table lists authorized string lengths.

String Type	Length
CellBlock / System Name	16
Scheme Name	32
History Name	64
Archive Name	75 (History Name: + 11 (_JJMMAA_nnn))
LUN Name	32
Switch Name	32
Event Name	32
Description	256 (Scheme: unlimited)
Domain Identity Name	16

Table 12. String length rules

Registry Keys

PAM obtains file paths via 2 registry keys:

- **ReleaseRoot:**
Contains PAP application file paths (DLL, WEB pages, models,...).
Two versions of PAM software can be installed and used indifferently on the same machine: each new version is installed in a new directory.
- **SiteRoot:**
Contains site data file paths.
Site data remains valid when the PAM software version changes.

Registry keys are generally stored under: HKEY_LOCAL_MACHINE\SOFTWARE\BULL\PAM

Glossary

A

AC: Alternating Current generated by the power supply. See DC.

ACPI: Advanced Configuration and Power Interface. An industry specification for the efficient handling of power consumption in desktop and mobile computers. ACPI specifies how a computer's BIOS, operating system, and peripheral devices communicate with each other about power usage.

Address: A label, name or number that identifies a location in a computer memory.

AMI: American Megatrends Incorporated.

ANSI: American National Standards Institute.

API: Application Program Interface. The specific method prescribed by a computer operating system or by an application program by which a programmer writing an application program can make requests of the operating system or another application.

Archive: (Archive file). A file that is a copy of a history file. When a history file is archived, all messages are removed from the history file.

ASCII: American National Standard Code for Information Interchange. A standard number assigned to each of the alphanumeric characters and keyboard control code keys to enable the transfer of information between different types of computers and peripherals.

B

Backup: A copy of data for safe-keeping. The data is copied from computer memory or disk to a floppy disk, magnetic tape or other media.

Backup battery: The battery in a computer that maintains real-time clock and configuration data when power is removed.

Baud rate: The speed at which data is transmitted during serial communication.

BERR: Bus Error signal pin used to signal a global machine check abort condition.

BINIT: Bus Initialization signal pin used to signal a global fatal machine check condition.

BIOS: Basic Input / Output System. A program stored in flash EPROM or ROM that controls the system startup process.

BIST: Built-In Self-Test. See POST.

Bit: Derived from Binary digiT. A bit is the smallest unit of information a computer handles.

BTU: British Thermal Unit.

Byte: A group of eight binary digits (bit) long that represents a letter, number, or typographic symbol.

C

Cache Memory: A very fast, limited portion of RAM set aside for temporary storage of data for direct access by the microprocessor.

CD-ROM: Compact Disk Read-Only Memory. High-capacity read-only memory in the form of an optically readable compact disk.

Cell: The smallest set of hardware components allocated to a single OS. A cell is functionally defined by:

- the number of available processors
- memory capacity
- I/O channel capacity.

CellBlock: A group of interconnected cells within a single domain. See Central Subsystem.

Central Subsystem: A group of interconnected cells gathered within a single domain. See CellBlock.

Chained DIBs: Two DIBs can be inter-connected to house 4 SCSI RAID disks, 1 DVD-ROM drive, 1 USB port. See DIB and IPD.

Chip: Synonym for integrated circuit. See IC.

Clipping: A PAM Event filter criterion. Clipping is defined on a Count / Time basis aimed at routing a pre-defined number of messages only. Identical messages are counted and when the number of messages indicated in the **Count** field is reached within the period of time indicated in the **Time** field, no other messages will be selected for routing.

CMC: Corrected Memory Check condition is signaled when a hardware corrects a machine check error or when a MCA condition is corrected by firmware.

CMCI: Corrected Memory Check Interrupt.

CMCV: Corrected Memory Check Vector.

CMOS: Complementary Metal Oxide Semiconductor. A type of low-power integrated circuits. System startup parameters are stored in CMOS memory. They can be changed via the system setup utility.

COM: Component Object Model. Microsoft technology for component based application development under Windows.

COM +: Component Object Model +. Microsoft technology for component based application development under Windows. The external part of the PAM software package is a COM+ application.

COM1 or COM2: The name assigned to a serial port to set or change its address. See Serial Port.

Command: An instruction that directs the computer to perform a specific operation.

Configuration: The way in which a computer is set up to operate. Configurable options include CPU speed, serial port designation, memory allocation, ...

Configuration Tasks: A PAM feature used to configure and customize the server.

Control Pane: One of the three areas of the PAM web page. When an item is selected in the **PAM Tree** pane, details and related commands are displayed in the **Control** pane. See PAM Tree pane and Status pane.

Core Unit: A main CSS module unit interconnecting the MIO, MQB, MSX and MFL boards. See MIO, MQB, MSX, MFL.

COS: Cluster Operating System.

CPE: Corrected Platform Error.

CPEI: Corrected Platform Error Interrupt.

CPU: Central Processing Unit. See Microprocessor and Socket.

CSE: Customer Service Engineer.

CSS: Central Sub-System. See CellBlock.

CSS Module: A MidPlane with all its connected components (QBBs, IO boards, PMB) and utility devices. See Module.

D

D2D: DC to DC converter.

DC: Direct Current generated by the power supply. See AC.

Default Setting: The factory setting your server uses unless instructed otherwise.

Density: The capacity of information (bytes) that can be packed into a storage device.

Device Driver: A software program used by a computer to recognize and operate hardware.

DIB: Device Interface Board. The DIB provides the necessary electronics for the Internal Peripheral Drawer. See IPD and Chained DIBs.

DIG64: Developer Interface Guide for IA64.

DIM Code: Device Initialization Manager. Initializes different BUSES during the BIOS POST.

DIMM: Dual In-line Memory Module - the smallest system memory component.

Disk Drive: A device that stores data on a hard or floppy disk. A floppy disk drive requires a floppy disk to be inserted. A hard disk drive has a permanently encased hard disk.

DMA: Direct Memory Access. Allows data to be sent directly from a component (e.g. disk drive) to the memory on the motherboard). The microprocessor does not take part in data transfer enhanced system performance.

DMI: Desktop Management Interface. An industry framework for managing and keeping track of hardware and software components in a system of personal computers from a central location.

DNS: Domain Name Server. A server that retains the addresses and routing information for TCP/IP LAN users.

Domain: is the coherent set of resources allocated to run a customer activity, i.e. the association -at boot time- of a Partition, an OS instance (including applications) and associated LUNs and an execution context including execution modes and persistent information (e.g. time, date of the OS instance). Domain definitions and initializations are performed via PAM. A Domain can be modified to run the same OS instance on a different Partition. When a Domain is running, its resources are neither visible nor accessible to other running Domains.

Domain Identity: a PAM Domain management logical resource. This resource contains context information related to the Customer activity running in a domain. The most visible attribute of this resource is the name that the Customer gives to the activity. For each domain created, the Domain management feature allows the operator to define a new activity or choose an activity from the list of existing activities. See Domain.

Domain Manager: A PAM feature used to power on / off and manage server domains. See Domain.

DPS: Distributed Power Supply.

DRAM: Dynamic Random Access Memory is the most common type of random access memory (RAM).

E

ECC: Error Correcting Code.

EEPROM: Electrically Erasable Programmable Read-Only Memory. A type of memory device that stores password and configuration data. See also EPROM.

EFI: Extensible Firmware Interface.

EFIMTA: EFI Modular Test Architecture.

EFI Shell: The EFI (Extensible Firmware Interface) Shell is a simple, interactive user interface that allows EFI device drivers to be loaded, EFI applications to be launched, and operating systems to be booted. In addition, the EFI Shell provides a set of basic commands used to manage files and the system environment variables. See Shell.

EMI: Electro-Magnetic Interference.

EPROM: Erasable Programmable Read-Only Memory. A type of memory device that is used to store the system BIOS code. This code is not lost when the computer is powered off.

ERC: Error and Reset Controller. This controller allows PAM software to control error detection and reset propagation within each pre-defined CSS partition. The ERC is initialized by PAM software to ensure a partition-contained distribution of the reset, error, interrupt and event signals; and to contribute to error signaling and localization at platform level.

ERP: Error Recovery Procedure.

ESD: ElectroStatic Discharge. An undesirable discharge of static electricity that can damage equipment and degrade electrical circuitry.

Event: The generation of a message (event message) by a software component and that is directed to the Event Manager.

Event address: Defines the destination for a message sent over a specified event channel. An address is one of: the name of a history file (for the HISTORY channel), an e-mail address (for the EMAIL channel), the name of a user group (for the WEB channel), the SNMP Manager IP address (for the SNMP channel).

Event channel: Defines how the Event Manager sends an event message. An event channel is one of: HISTORY (the message is logged in a history file), EMAIL (the message is sent to an e-mail address), WEB (the message is stored for analysis from the PAM web user interface), SNMP (the message is sent as an SNMP trap to the selected SNMP application).

Event filter: A list of selected messages among all possible event messages. If an event message is not included in the filter, the Event Manager discards the message.

Event Manager: A PAM feature used to forward event messages over a configured event channel. See Event.

Event message: A message sent by a software component to the Event Manager for routing to a destination that is configured by an administrator.

Event subscription: An object that defines the event channel, address, and filter for sending an event message. If no such object is defined, the event message is discarded.

Exclusion: Logical removal of a redundant faulty hardware element until it has been repaired or replaced. The hardware element remains physically present in the configuration, but is no longer detected by PAM software and can no longer be used by a domain.

External Disk Subsystem: Disk subsystem housed inside the NovaScale cabinet.

F

Fail-over: Failover is a backup operational mode in which the functions of a system component (such as a processor, server, network, or database, for example) are assumed by secondary system components when the primary component becomes unavailable through either failure or scheduled down time.

FAME: Flexible Architecture for Multiple Environments.

FAST WIDE: A standard 16-bit SCSI interface providing synchronous data transfers of up to 10 MHz, with a transfer speed of 20M bytes per second.

FC: Fibre Channel.

FCAL: Fibre Channel Arbitrated Loop.

FCA: Fibre Channel Adapter.

FCBQ: Fan Control Board for QBB.

FCBS: Fan Control Board for SPS.

FDA: Fibre Disk Array.

FDD: Floppy Disk Drive.

Flash EPROM: Flash Erasable Programmable Read-Only Memory. A type of memory device that is used to store the the system firmware code. This code can be replaced by an updated code from a floppy disk, but is not lost when the computer is powered off.

Firewall: A set of related programs, located at a network gateway server, that protects the resources of a private network from users from other networks.

Firmware: an ordered set of instructions and data stored to be functionally independent of main storage.

Format: The process used to organize a hard or floppy disk into sectors so that it can accept data. Formatting destroys all previous data on the disk.

FPB: FAME Power Board (FAME: Flexible Architecture for Multiple Environments).

FPGA: Field Programmable Gate Array. A gate array that can be reprogrammed at run time.

FRB: Fault Resilient Boot. A server management feature. FRB attempts to boot a system using the alternate processor or DIMM.

FRU: Field Replaceable Unit. A component that is replaced or added by Customer Service Engineers as a single entity.

FSS: FAME Scalability Switch. Each CSS Module is equipped with 2 Scalability Port Switches providing high speed bi-directional links between server components. See SPS.

FTP: File Transfer Protocol. A standard Internet protocol: the simplest way of exchanging files between computers on the Internet. FTP is an application protocol that uses Internet TCP/IP protocols. FTP is commonly used to transfer Web page files from their creator to the computer that acts as their server for everyone on the Internet. It is also commonly used to download programs and other files from other servers.

FWH: FirmWare Hub.

Global MCA: Machine Check Abort is visible to all processors, in a multiprocessor system and will force all of them to enter machine check abort.

GUI: Graphical User Interface.

GTS: Global Telecontrol Server.

H

HA: High Availability. Refers to a system or component that is continuously operational for a desirably long length of time.

HAL: Hardware Abstraction Layer.

HA CMP: High Availability Clustered MultiProcessing.

Hard Disk Drive: HDD. See Disk Drive.

Hardware: The physical parts of a system, including the keyboard, monitor, disk drives, cables and circuit cards.

Hardware Monitor: A PAM feature used to supervise server operation.

HBA: Host Bus Adapter.

HDD: Hard Disk Drive. See Disk Drive.

History File: A file in which the History Manager logs informative messages or error messages relating to system activity. Messages are sent from source components to target components.

History Manager: The component running on the PAP Windows operating system that logs messages to history files.

HMMIO Space: High Memory IO Space.

HPB: Hot Plug Board. This board provides an interlock switch on each IO Box PCI slot for hot-swapping PCI boards. See P-HPB.

HPC: High Performance Computing.

Hot plugging: The operation of adding a component without interrupting system activity.

Hot swapping: The operation of removing and replacing a faulty component without interrupting system activity.

HTTP: HyperText Transfer Protocol. In the World Wide Web, a protocol that facilitates the transfer of hypertext-based files between local and remote systems.

HW Identifier: Number (0 - F) used to identify Cellblock components. This number is identical to PMB code-wheel position.

G

GB: GigaByte: 1,073,741,824 bytes. See Byte.

I2C: Intra Integrated Circuit. The I2C (Inter-IC) bus is a bi-directional two-wire serial bus that provides a communication link between integrated circuits (ICs).

The I2C bus supports 7-bit and 10-bit address space devices and devices that operate under different voltages.

IA64: is a 64-bit Intel processor Architecture based on Explicitly Parallel Instruction Computing (EPIC). The Itanium processor is the first in the Intel line of IA-64 processors.

IB: Infini Band.

IC: Integrated Circuit. An electronic device that contains miniaturized circuitry. See Chip.

ICH2: I/O Controller Hub 2, component that contains the fundamental I/O interfaces required by the system. Flash memory, Keyboard, USB and IDE device interface.

ICH4: I/O Controller Hub 4.

ICMB: Intelligent Chassis Management Bus.

ID: A number which uniquely identifies a device on a bus.

IDE: Integrated Drive Electronics. A type of hard disk drive with the control circuitry located inside the disk drive rather than on a drive controller card.

Identity: See Domain Identity.

IIS: Internet Information Server. A group of Internet servers (including a Web or HTTP server and a FTP server) with additional capabilities for Microsoft® Windows® NT and Microsoft Windows (and later) operating systems.

I/O: Input /Output. Describes any operation, program, or device that transfers data to or from a computer.

Interface: A connection between a computer and a peripheral device enabling the exchange of data. See Parallel Port and Serial Port.

Internal Disk Subsystem: Disk subsystem housed inside the NovaScale Internal Peripheral Drawer (IPD).

IOB: Input / Output Board. The IOB connects up to 11 PCI-X boards.

IOC: Input / Output Board Compact. The IOC connects up to 6 PCI-X boards.

IOL: I/O Board Legacy. The IOL provides:

- I/O controller Hub
- USB ports
- 10/100/1000 Ethernet controller
- Video controller
- Serial / debug port

IOR: I/O Board Riser. The IOR provides:

- I/O controller Hub
- USB ports
- 10/100/1000 Ethernet controller
- Video controller
- Serial / debug port

IP: Internet Protocol. The protocol by which data is sent from one computer to another via the Internet. Each computer (known as a host) on the Internet has at least one IP address that uniquely identifies it from all other computers on the Internet.

IPD: Internal Peripheral Drawer. The IPD houses legacy peripherals (DVD-Rom drive, USB port) and SCSI system disks. See DIB and Chained DIBs.

IPF: Itanium Processor Family.

IPL: Initial Program Load. It defines the firmware functional phases during the system initialization.

IPMB: Intelligent Platform Management Bus.

IPMI: Intelligent Platform Management Interface.

ISA: Industry Standard Architecture. An industry standard for computers and circuit cards that transfer 16 bits of data at a time.

J

Jumper: A small electrical connector used for configuration on computer hardware.

K

KVM: Keyboard Video Monitor.

KVM switch: the Keyboard Video Monitor switch allows the use of a single keyboard, monitor and mouse for more than one module.

L

LAN: Local Area Network. A group of computers linked together within a limited area to exchange data.

LD: Logical Disk. A Storeway FDA 1x00/2x00 logical disk (or LUN) is visible to the OS as a Disk. See LUN and PD (Physical Disk).

LED: Light Emitting Diode. A small electronic device that glows when current flows through it.

Legacy Application: An application in which a company or organization has already invested considerable time and money. Typically, legacy applications are database management systems (DBMSs) running on mainframes or minicomputers.

Licensing Number: When you install an application protected by a system serial number, you are requested to supply this serial number. For optimum flexibility, PAM software allows you to replace the physical serial number by a logical licensing number so that you can run the application on any physical partition and, in the case of extended systems, on any of the Central Subsystems within the extended configuration.

LID: Local Interrupt Identifier (CPU).

Local Disk Subsystem: Disk subsystem housed inside the NovaScale cabinet and not connected to a SAN.

Local MCA: Machine Check Abort is detected and handled by a single processor and is invisible to the other processor.

Locking: Means of functionally limiting access to certain hardware elements. Locked hardware elements can no longer be accessed by the current domain, but are still physically available for use by other domains. Previously locked elements can be unlocked so that they can be accessed by the domain.

LPT1 or LPT2: The name assigned to a parallel port to specify its address. See Parallel Port.

LS240: Laser Servo super diskette holding up to 240 Mb.

LUN: Logical Unit Number. Term used to designate Logical Storage Units (logical disks) defined through the configuration of physical disks stored in a mass storage cabinet.

LVDS: Low Voltage Differential SCSI.

M

MAESTRO: Machine Administration Embedded Software Real Time Oriented. Part of the PAM software package embedded on the PMB board.

MCA: Machine Check Abort. See also Local MCA and Global MCA.

Memory: Computer circuitry that stores data and programs. See RAM and ROM.

Memory bank: The minimum quantity of memory used by the system. It physically consists of four memory DIMMs.

MFL: Midplane Fan & Logistics board. The MFL houses the Fan Boxes and is connected to the MIO and MQB. See MIO, MQB.

Microprocessor: An integrated circuit that processes data and controls basic computer functions.

Midplane: Mid-Plane. All system hardware components are connected to the Midplane.

MIMD: Multiple Instruction Multiple Data

MIO: Midplane Input / Output board. The MIO connects one or two IOC boards and the PMB. See Core Unit.

Mirrored volumes: A mirrored volume is a fault-tolerant volume that duplicates your data on two physical disks. If one of the physical disks fails, the data on the failed disk becomes unavailable, but the system continues to operate using the unaffected disk.

Module: a Midplane Board with all its connected components and utility devices. See CSS Module and MP.

MQB: Midplane QBB board. The MQB connects one or two QBBs and one or two IPDs. See QBB and IPD.

MSX: Midplane SPS & XPS board. The MSX houses a B-SPS switch and is connected to the MIO and the MQB. There are two MSX boards in a CSS module. All SP connections between a QBB and an IOC use an MSX. See B-SPS, MIO, MQB.

MTBF: Mean Time Between Failure. An indicator of expected system reliability calculated on a statistical basis from the known failure rates of various components of the system. Note: MTBF is usually expressed in hours.

Multicore: Presence of two or more processors on a single chip.

Multimedia: Information presented through more than one type of media. On computer systems, this media includes sound, graphics, animation and text.

Multitasking: The ability to perform several tasks simultaneously. Multitasking allows you to run multiple applications at the same time and exchange information among them. See Task.

Multithreading: The ability of a processor core to execute more than one independent instruction thread simultaneously. As the core comprises two complete context registers, it is able to switch rapidly from one instruction thread to another.

N

NFS: Network File System. A proprietary distributed file system that is widely used by TCP/IP vendors. Note: NFS allows different computer systems to share files, and uses user datagram protocol (UDP) for data transfer.

NMI: Non-Maskable Interrupt.

NUMA: Non Uniform Memory Access. A method of configuring a cluster of microprocessors in a multiprocessing system so that they can share memory locally, improving performance and the ability of the system to be expanded.

nsh: nsh stands for **n**ew **s**hell. See Shell and EFI Shell.

NVRAM: Non Volatile Random Access Memory. A type of RAM that retains its contents even when the computer is powered off. See RAM and SRAM.

O

OF: Open Firmware. Firmware controlling a computer prior to the Operating System.

Operating System: See OS.

OS: Operating System. The software which manages computer resources and provides the operating environment for application programs.

P

PAL: Processor Abstraction Layer: processor firmware that abstracts processor implementation differences. See also SAL.

PAM: Platform Administration & Maintenance.

PAM software: Platform Administration & Maintenance software. One part (PAP application and the PamSite WEB site) runs on the PAP unit. The other part (MAESTRO) is embedded on the PMB board.

PAM Tree pane: One of the three areas of the PAM web page. Server hardware presence and functional status are displayed in the PAM Tree pane. See Status pane and Control pane.

PAP unit: Platform Administration Processor unit. The PC hosting all server administration software.

PAP application: Platform Administration Processor application. Part of PAM software, PAP application is a Windows COM+ application running on PAP unit.

Parallel Port: Connector allowing the transfer of data between the computer and a parallel device.

PARM request: the PARM application is designed to handle Requests issued by the CSE (Customer Service Engineer)

Partition: Division of storage space on a hard disk into separate areas so that the operating system treats them as separate disk drives.

Password: A security feature that prevents an unauthorized user from operating the system.

PCI: Peripheral Component Interconnect. Bus architecture supporting high-performance peripherals.

PD: Physical Disk. A Storeway FDA 1300/2300 physical disk is not visible to the OS. See LD.

PDU: Power Distribution Unit. Power bus used for the connection of peripheral system components.

Permanence: Property of a history file that determines whether or not the history file can be modified or deleted from the PAM user interface. Permanence is either *Static* (cannot be modified) or *Dynamic* (can be modified).

P-HPB: PCI Hot Plug Board. This board provides an interlock switch on each IO Box PCI slot for hot-swapping PCI boards. See HPB.

PIC: Platform Instrumentation Control.

ping: A basic Internet program that lets you verify that a particular IP address exists and can accept requests. The verb "to ping" means the act of using the ping utility or command.

PIROM: Processor Information ROM. Processor Information ROM (PIROM) contains information about the specific processor in which it resides. This information includes robust addressing headers to allow for flexible programming and forward compatibility, core and L2 cache electrical specifications, processor part and S-spec numbers, and a 64-bit processor number.

PMB: Platform Management Board. Links the server to the PAP unit.

PNP: Plug aNd Play. The ability to plug a device into a computer and have the computer recognize that the device is there.

POST: Power On Self Test. When power is turned on, POST (Power-On Self-Test) is the diagnostic testing sequence (or "starting program") that a computer runs to determine if hardware is working correctly.

PROM: Programmable Read-Only Memory.

PUID: PAM Universal/Unique IDentifier. PAM software allocates a PUID (PAM Universal / Unique Identifier) to each hardware / software object to guarantee unambiguous identification. The PUID for each hardware element can be obtained by hovering the mouse over the corresponding element in the PAM tree, e.g.:
PAM:/CELLSBLOCK_<NAME>/MODULE_x/QBB_y /CPU_y.

Q

QBB: Quad Brick Board. The QBB is the heart of the Bull NovaScale Server, housing 4 Itanium 2 processors and 16 DIMMs. Each QBB communicates with other CSS Module components via 2 high-speed bidirectional Scalability Port Switches.
See SPS or FSS.

R

RAID: Redundant Array of Independent Disks. A method of combining hard disk drives into one logical storage unit for disk-fault tolerance.

RAM: Random Access Memory. A temporary storage area for data and programs. This type of memory must be periodically refreshed to maintain valid data and is lost when the computer is powered off. See NVRAM and SRAM.

RAS: Reliability, Availability, Serviceability.

Real-time clock: The Integrated Circuit in a computer that maintains the time and date.

RFI: Radio Frequency Interference.

Ring: The CSS module interconnection ring comprises the cables used to interconnect two, three or four CSS modules.

RJ45: 8-contact regular jack.

RMC: Remote Maintenance Console.

ROM: Read-Only Memory. A type of memory device that is used to store the system BIOS code. This code cannot be altered and is not lost when the computer is powered off. See BIOS, EPROM and Flash EPROM.

RS-232 Port: An industry standard serial port. See Serial Port.

RSF: Remote Service Facilities.

RTC: Real Time Clock.

S

S@N.IT: SAN Administration Tool.

SAL: System Abstraction Layer. Firmware that abstract system implementation differences in IA-64 platform. See also PAL.

SAN: Storage Area Network. A high-speed special-purpose network that interconnects different kinds of data storage devices with associated data servers on behalf of a larger network of users.

SAPIC: Streamlined Advanced Programmable Interrupt Controller message.

SBE: Single Bit Error.

Scheme: Configuration file ensuring optimum use and compatibility of the physical and logical resources used to simultaneously run multiple domains.

SCI: Scalable Coherent Interface.

SCSI: Small Computer System Interface. An input and output bus that provides a standard interface used to connect peripherals such as disks or tape drives in a daisy chain.

SDR: Sensor Data Record.

SDRAM: Synchronous Dynamic Random Access Memory. A type of DRAM that runs at faster clock speeds than conventional memory. See DRAM.

SEL: System Event Log. A record of system management events. The information stored includes the name of the event, the date and time the event occurred and event data. Event data may include POST error codes that reflect hardware errors or software conflicts within the system.

Serial Communication: Data sent sequentially, one bit at a time.

Serial Port: Connector that allows the transfer of data between the computer and a serial device. See COM1 or COM 2.Shell is a Unix term for the interactive user interface with an operating system.

SIO: Server I/O / Super I/O.

Shell: The Shell is the layer of programming that understands and executes the commands a user enters. As the outer layer of an operating system, the Shell can be contrasted with the kernel, the inmost layer or core of services of an operating system. See EFI Shell.

SIOH: Server I/O Hub. This component provides a connection point between various I/O bridge components and the Intel 870 chipset.

Sideband: This part of the CSS module inter-connection ring comprises logistic cables (errors, commands, resets). See Ring.

SMBIOS: System Management BIOS.

SM-BUS: System Management Bus.

SMIC: Server Management Interface Chip.

SMP: Symmetrical Multi Processor. The processing of programs by multiple processors that share a common operating system and memory.

SNC: Scalable Node Controller. The processor system bus interface and memory controller for the Intel870 chipset. The SNC supports both the Itanium2 processors, DDR SDRAM main memory, a Firmware Hub Interface to support multiple Firmware hubs, and two scalability ports for access to I/O and coherent memory on other nodes, through the FSS.

SNM: System Network Module.

SNMP: Simple Network Management Protocol. The protocol governing network management and the monitoring of network devices and their functions.

Socket: Central Processing Unit multicore interface. Each socket can house 1 or 2 processor cores. See Microprocessor and CPU.

Source: Each message refers to a source (the resource that generated the message) and a target (the component referred to in the message). This feature can be allows messages to be filtered according to one or more **Source** string(s) and is particularly useful for debugging and troubleshooting. See Target.

SPD: Serial Presence Detect. DIMM PROM.

SPS: Scalability Port Switch. Each CSS Module is equipped with 2 Scalability Port Switches providing high speed bi-directional links between system components. See FSS.

SRAM: Static RAM. A temporary storage area for data and programs. This type of memory does not need to be refreshed, but is lost when the system is powered off. See NVRAM and RAM.

SSI: Server System Infrastructure.

Status Pane: One of the three areas of the PAM web page. Provides quick access to CSS Module availability status, server functional status, and pending event message information. See also Control pane and PAM Tree pane.

SVGA: Super Video Graphics Array.

T

Target: Each message refers to a target (the component referred to in the message), identified by its PUID, and a source (the component that generated the message). This feature allows messages to be filtered according to one or more **Target** string(s) and is particularly useful for debugging and troubleshooting. See Source and PUID.

Task: Each message refers to a target (the component referred to in the message), identified by its PUID, and a source (the component that generated the message). This feature allows messages to be filtered according to one or more **Target** string(s) and is particularly useful for debugging and troubleshooting. See Source and PUID.

TCP: Transmission Control Protocol. A set of rules (protocol) used along with the Internet Protocol (IP) to send data in the form of message units between computers over the Internet.

TCP/IP: Transmission Control Protocol / Internet Protocol. The basic communication language or protocol of the Internet.

T&D: Tests and Diagnostics.

Thresholding: A PAM Event filter criterion. Thresholding is defined on a Count / Time basis aimed at routing significant messages only. Identical messages are counted and when the number of messages indicated in the **Count** field is reached within the period of time indicated in the **Time** field, this message is selected for routing.

U

UART: a Universal Asynchronous Receiver Transmitter. The microchip with programming that controls a computer interface to its attached serial devices.

ULTRA SCSI: An enhanced standard 16-bit SCSI interface providing synchronous data transfers of up to 20 MHz, with a transfer speed of 40M bytes per second. It is also called Fast-20 SCSI.

UML: Unified Modeling Language. A standard notation for the modeling of real-world objects as a first step in developing an object-oriented design methodology.

UPS: Uninterruptible Power Supply. A device that allows uninterrupted operation if the primary power source is lost. It also provides protection from power surges.

URL: Uniform / Universal Resource Locator. The address of a file (resource) accessible on the Internet.

USB: Universal Serial Bus. A plug-and-play interface between a computer and add-on devices. The USB interface allows a new device to be added to your computer without having to add an adapter card or even having to turn the computer off.

V

VCC: Voltage Continuous Current.

VGA: Video Graphics Array.

VI: Virtual Interface.

Visibility: A property of a history file. Visibility is either *System* (the history file is predefined by the PAM software and is visible only to an administrator) or *User* (the history file is created by an administrator and is visible to both an administrator and an operator).

VLAN: Virtual Local Area Network. A local area network with a definition that maps workstations on some other basis than geographic location (for example, by department, type of user, or primary application).

VxWORKS: Platform Management Board Operating System.

W

WAN: Wide Area Network. Geographically dispersed telecommunications network. The term distinguishes a broader telecommunication structure from a local area network (LAN).

WBEM: Web Based Enterprise Management.

WMI: Windows Management Interface.

WOL: A feature that provides the ability to remotely power on a system through a network connection.

X

XML: eXtended Markup Language. A flexible way to create common information formats and share both the format and the data on the World Wide Web, intranets, and elsewhere.

XSP: eXtended Scalable Port.

Y

No entries.

Z

No entries.

Index

A

- Access, front door, 2-2
- Autocalls
 - configuring, 2-30
 - FTP parameters, 2-30
 - testing, 2-46

B

- Back Up, PAM software, 2-54

C

- Cabinet, unpacking, 1-8
- Cabling, inter-cabinet, 2-5
- CD-ROM drive, 1-19
- Central Subsystem
 - configuring, 2-47
 - removing, 2-47
- Central subsystem, adding, 2-47
- Checks
 - autocall connection, 2-46
 - network connections, 2-46
 - server operation, 2-6
 - server status, 2-9
- Components, 5085, 1-12
- Connecting, external devices, 2-45
- Connections
 - Enterprise LAN, 2-32, 2-44
 - network, 2-46
 - PAP unit, 2-32
- Console, 1-20
 - opening / closing, 2-3
 - tooggling, 2-12
- CSS Module, PMB, 2-4
- CSS module, 1-18
 - availability status, 2-10
 - shipping brackets, 1-9
 - stoppers, 1-9
 - testing, ring connections, 2-13
- Customer information, configuring, 2-29

D

- Delivery
 - server, 1-7
 - system, 1-2
- Details pane, PAM, 2-9
- Devices, external, 2-45
- DIB, chained, 1-18
- DIMMs, 1-18
- Disks, 1-19
- Domain
 - power down, 2-16
 - power up, 2-16
- DVD/CD-ROM drive, 1-18

E

- Electrical safety, xv
- Electromagnetic compatibility, xvii

- Electrostatic discharges, xviii
- Enterprise LAN
 - connecting PAP unit, 2-32
 - connection, 2-44
- Environmental standards, xvii
- Ethernet hub, 1-24
- Ethernet ports, 1-18, 1-19

F

- FC storage subsystems, password, changing, 2-22
- FDA 1300 disk rack, 1-22
- FDA 2300 FC disk rack, 1-22
- FDD, 1-19
- Front door, opening, 2-2

G

- Getting to know, server, 1-12

I

- Illegal characters, B-3
- Inspecting, server, 1-8
- Inspection
 - cabling, 1-11
 - components, 1-11
- Installation
 - flowchart, xxi
 - intervention report, 2-46
- Intervention report, installation, 2-46
- IOB, 1-18
- IOL, 1-18

K

- Keyboard, 1-20
- Keys, registry, B-4
- KVM switch, 1-21

L

- Laser safety, xvi
- Limits
 - audio-noise, xix
 - pollution, xix

M

- Memory boards, 1-18
- Modem, 1-24
- Monitor, 1-20
- Mother boards, 1-18
- Mouse, 1-20

N

- Network, testing, 2-46
- Notices
 - electrical safety, xv
 - laser safety, xvi
 - safety, xv
- NPort Server, 1-24

O

Operating System, completing setup, 2-35

Operating system, setup
completing, 2-36, 2-40
Microsoft Windows, 2-37, 2-41

P

PAM

details pane, 2-9
status pane, 2-9
toolbar, 2-11
user interface, 2-8
writing rules, B-3

PAM software

back up / restore, 2-54
launching, 2-6

PAM tree pane, 2-10

PAP Unit, backup disk, initializing, 2-51

PAP unit, 1-19

CD-ROM drive, 1-19
configuration, 2-24
disks, 1-19
Ethernet ports, 1-19
FDD, 1-19
serial ports, 1-19

PAP users, setting up, 2-49

Password, changing, FC storage subsystems, 2-22

Peripheral drawer, 1-18

PHPB, 1-18

PMB, 1-18

code wheels, 2-4

Power cables, 1-19, 1-20, 1-21, 1-22, 1-23

Power down, server domain, 2-16

Power supply, connecting, 2-5

Power-up

server, 2-5
server domain, 2-16
system domains, 2-18

Processors, 1-18

Program, post-install, 2-24

PUID, PAM software, 2-6

Q

QBBs, 1-18

R

Remote access

iSM, 2-34
PAM, 2-33

Restarting, server, 2-17, 2-21

Restoring, PAM software, 2-54

Ring, testing connections, 2-13

S

S@NIT, password, changing, 2-23

Safety

notices, xv
recommendations, 2-5
specifications, xix

Serial ports, 1-18, 1-19

Server

configuring, 2-47

domain, 2-16

getting to know, 1-12

inspecting, 1-8

restarting, 2-17, 2-21

shutdown, 2-17, 2-21

Server components

accessing, 2-2

CD-ROM drive, 1-19

console, 1-20

core unit, 1-18

CSS module, 1-18

DIMMs, 1-18

Ethernet hub, 1-24

Ethernet ports, 1-18, 1-19

FDA 1300 FC, 1-22

FDA 2300 FC, 1-22

FDD, 1-19

internal peripheral drawer, 1-18

IOB, 1-18

IOL, 1-18

keyboard, 1-20

KVM switch, 1-21

memory boards, 1-18

modem, 1-24

monitor, 1-20

mother boards, 1-18

mouse, 1-20

NPort Server, 1-24

PAP unit, 1-19

PAP unit disks, 1-19

PHPB, 1-18

PMB, 1-18, 2-4

power cables, 1-19, 1-20, 1-21, 1-22, 1-23

processors, 1-18

QBBs, 1-18

serial ports, 1-18, 1-19

USB ports, 1-18

VGA port, 1-18

Server operation, checking, 2-6

Server status, checking, 2-9

Setting up, PAP users, 2-49

Setup

Microsoft Windows, 2-37, 2-41

operating system, completing, 2-36, 2-40

Shipping brackets, CSS module, 1-9

Shocks and vibrations, xviii

Shutdown, server, 2-17, 2-21

Specifications

atmospheric, xvii

electrical, xvii

NovaScale 5085 Servers, A-2

NovaScale 5165 Server, A-4

NovaScale 5245 Server, A-6

NovaScale 5325 Server, A-8

safety, xix

system, A-1

Status, CSS module, 2-10

Status pane, PAM, 2-9

Stoppers, CSS module, 1-9

Storage area network, S@NIT, password, 2-23

String lengths, B-4

System

dimensions, A-1

domains, 2-18

weight, A-1
System components, DVD/CD-ROM drive, 1-18

T

Toolbar, PAM, 2-11

U

USB modem, connecting, 2-45
USB ports, 1-18
User group, PAP, 2-49

User interface, PAM, 2-8

V

VGA port, 1-18

W

Writing rules
 illegal characters, B-3
 string lengths, B-4

Technical publication remarks form

Title :	NOVASCALE NovaScale 5xx5 Installation Guide
----------------	---

Reference:	86 A1 40EM 06
-------------------	---------------

Date:	September 2007
--------------	----------------

ERRORS IN PUBLICATION

--

SUGGESTIONS FOR IMPROVEMENT TO PUBLICATION

--

Your comments will be promptly investigated by qualified technical personnel and action will be taken as required.
If you require a written reply, please include your complete mailing address below.

NAME : _____ Date : _____

COMPANY : _____

ADDRESS : _____

Please give this technical publication remarks form to your BULL representative or mail to:

Bull - Documentation D^épt.
1 Rue de Provence
BP 208
38432 ECHIROLLES CEDEX
FRANCE
info@frec.bull.fr

Technical publications ordering form

To order additional publications, please fill in a copy of this form and send it via mail to:

BULL CEDOC
357 AVENUE PATTON
B.P.20845
49008 ANGERS CEDEX 01
FRANCE

Phone: +33 (0) 2 41 73 72 66
FAX: +33 (0) 2 41 73 70 66
E-Mail: srv.Duplicopy@bull.net

Reference	Designation	Qty
-- -- -- -- -- [--]		
-- -- -- -- -- [--]		
-- -- -- -- -- [--]		
-- -- -- -- -- [--]		
-- -- -- -- -- [--]		
-- -- -- -- -- [--]		
-- -- -- -- -- [--]		
-- -- -- -- -- [--]		
-- -- -- -- -- [--]		
-- -- -- -- -- [--]		
-- -- -- -- -- [--]		
-- -- -- -- -- [--]		
[--] : The latest revision will be provided if no revision number is given.		

NAME: _____ Date: _____

COMPANY: _____

ADDRESS: _____

PHONE: _____ FAX: _____

E-MAIL: _____

For Bull Subsidiaries:

Identification: _____

For Bull Affiliated Customers:

Customer Code: _____

For Bull Internal Customers:

Budgetary Section: _____

For Others: Please ask your Bull representative.

BULL CEDOC
357 AVENUE PATTON
B.P.20845
49008 ANGERS CEDEX 01
FRANCE

REFERENCE
86 A1 40EM 06

Utiliser les marques de découpe pour obtenir les étiquettes.
Use the cut marks to get the labels.

