

Virtual I/O Server

ESCALA Power7



REFERENCE
86 A1 42FF 05

ESCALA Power7

Virtual I/O Server

The ESCALA Power7 publications concern the following models:

- Bull Escala E5-700 (Power 750 / 8233-E8B)
- Bull Escala M6-700 (Power 770 / 9117-MMB)
- Bull Escala M6-705 (Power 770 / 9117-MMC)
- Bull Escala M7-700 (Power 780 / 9179-MHB)
- Bull Escala M7-705 (Power 780 / 9179-MHC)
- Bull Escala E1-700 (Power 710 / 8231-E2B)
- Bull Escala E1-705 (Power 710 / 8231-E1C)
- Bull Escala E2-700 / E2-700T (Power 720 / 8202-E4B)
- Bull Escala E2-705 / E2-705T (Power 720 / 8202-E4C)
- Bull Escala E3-700 (Power 730 / 8231-E2B)
- Bull Escala E3-705 (Power 730 / 8231-E2C)
- Bull Escala E4-700 / E4-700T (Power 740 / 8205-E6B)
- Bull Escala E4-705 (Power 740 / 8205-E6C)

References to Power 755 / 8236-E8C models are irrelevant.

Hardware

May 2012

BULL CEDOC
357 AVENUE PATTON
B.P.20845
49008 ANGERS CEDEX 01
FRANCE

REFERENCE
86 A1 42FF 05

The following copyright notice protects this book under Copyright laws which prohibit such actions as, but not limited to, copying, distributing, modifying, and making derivative works.

Copyright © Bull SAS 2012

Printed in France

Suggestions and criticisms concerning the form, content, and presentation of this book are invited. A form is provided at the end of this book for this purpose.

To order additional copies of this book or other Bull Technical Publications, you are invited to use the Ordering Form also provided at the end of this book.

Trademarks and Acknowledgements

We acknowledge the right of proprietors of trademarks mentioned in this book.

The information in this document is subject to change without notice. Bull will not be liable for errors contained herein, or for incidental or consequential damages in connection with the use of this material.

Contents

| | |
|--|----------|
| Virtual I/O Server | 1 |
| What's new in Virtual I/O Server | 1 |
| Virtual I/O Server overview | 6 |
| PowerVM Editions overview | 7 |
| PowerVM Express Edition | 9 |
| PowerVM Standard Edition | 10 |
| PowerVM Enterprise Edition | 10 |
| Operating system support for VIOS client logical partitions | 11 |
| Components of the Virtual I/O Server | 13 |
| Virtual Fibre Channel | 15 |
| Virtual Fibre Channel for HMC-managed systems | 16 |
| Virtual Fibre Channel on IVM-managed systems | 18 |
| Virtual SCSI | 20 |
| Virtual I/O Server storage subsystem overview | 22 |
| Physical storage | 23 |
| Physical volumes | 23 |
| Logical volumes | 23 |
| Virtual media repository | 26 |
| Clusters | 26 |
| Storage pools | 27 |
| Optical devices | 28 |
| Tape | 28 |
| Virtual storage | 29 |
| Disk | 29 |
| Optical | 30 |
| Tape | 30 |
| Device compatibility in a Virtual I/O Server environment | 31 |
| Mapping devices | 33 |
| Virtual networking | 33 |
| Host Ethernet Adapter | 33 |
| Internet Protocol version 6 | 35 |
| Link Aggregation or EtherChannel devices | 35 |
| Virtual Ethernet adapters | 36 |
| Virtual local area networks | 36 |
| Shared Ethernet Adapters | 37 |
| Shared memory | 39 |
| Paging VIOS partition | 41 |
| Virtual I/O Server management | 46 |
| Virtual I/O Server command-line interface | 46 |
| Tivoli software and the Virtual I/O Server | 49 |
| Systems Director software | 51 |
| Scenarios: Configuring the Virtual I/O Server | 52 |
| Scenario: Configuring a Virtual I/O Server without VLAN tagging | 52 |
| Scenario: Configuring a Virtual I/O Server using VLAN tagging | 54 |
| Scenario: Configuring Shared Ethernet Adapter failover | 56 |
| Scenario: Configuring Shared Ethernet Adapter failover with load sharing | 59 |
| Scenario: Configuring Network Interface Backup in AIX client logical partitions without VLAN tagging | 60 |
| Scenario: Configuring Multi-Path I/O for AIX client logical partitions | 62 |
| Planning for the Virtual I/O Server | 65 |
| Specifications required to create the Virtual I/O Server | 65 |
| Limitations and restrictions of the Virtual I/O Server configuration | 65 |
| Capacity planning | 68 |
| Planning for virtual SCSI | 68 |
| Virtual SCSI latency | 68 |
| Virtual SCSI bandwidth | 69 |
| Virtual SCSI sizing considerations | 69 |

| | |
|---|-----|
| Planning for Shared Ethernet Adapters | 71 |
| Network requirements. | 72 |
| Adapter selection | 73 |
| Processor allocation. | 75 |
| Memory allocation | 77 |
| Configuration requirements for shared memory | 78 |
| Redundancy considerations | 79 |
| Client logical partitions | 80 |
| Multipath I/O | 80 |
| Mirroring for client logical partitions | 80 |
| PowerHA SystemMirror in the Virtual I/O Server | 81 |
| Link Aggregation or EtherChannel devices | 82 |
| Shared Ethernet Adapter failover | 82 |
| Shared Ethernet Adapters for load sharing | 83 |
| Virtual I/O Server logical partition | 83 |
| Multipathing | 84 |
| RAID | 84 |
| Link Aggregation or EtherChannel devices | 84 |
| Redundancy configuration using virtual Fibre Channel adapters. | 84 |
| Security considerations | 87 |
| Installing the Virtual I/O Server and client logical partitions | 88 |
| Installing the Virtual I/O Server manually by using HMC Version 7, release 7.1, and later | 88 |
| Entering the activation code for PowerVM Editions by using HMC Version 7 | 89 |
| Creating the Virtual I/O Server logical partition on an HMC managed system | 89 |
| Creating the Virtual I/O Server logical partition and partition profile manually by using the HMC | 89 |
| Creating the Virtual I/O Server logical partition and client logical partitions by using the HMC to deploy a system plan. | 91 |
| Installing the Virtual I/O Server from the HMC | 91 |
| Installing the Virtual I/O Server from CD or DVD | 92 |
| Finishing the Virtual I/O Server installation | 94 |
| Viewing and accepting the Virtual I/O Server license | 94 |
| Reinstalling the Virtual I/O Server of a paging VIOS partition | 95 |
| Migrating the Virtual I/O Server | 96 |
| Migrating the Virtual I/O Server from the HMC | 97 |
| Migrating the Virtual I/O Server from a downloaded image | 98 |
| Migrating the Virtual I/O Server from DVD | 100 |
| Configuring the Virtual I/O Server | 102 |
| Configuring virtual SCSI on the Virtual I/O Server. | 102 |
| Creating the virtual target device on the Virtual I/O Server | 103 |
| Creating a virtual target device on a Virtual I/O Server that maps to a physical or logical volume, tape or physical optical device | 103 |
| Creating a virtual target device on a Virtual I/O Server that maps to a file or logical volume | 105 |
| Creating a virtual target device on a Virtual I/O Server that maps to a file-backed virtual optical device | 106 |
| Setting the reserve policy attributes of a device | 108 |
| Creating logical volume storage pools on a Virtual I/O Server | 109 |
| Creating file storage pools on a Virtual I/O Server | 110 |
| Creating the virtual media repository on a Virtual I/O Server | 110 |
| Creating volume groups and logical volumes on a Virtual I/O Server | 111 |
| Configure the Virtual I/O Server to support SCSI-2 reserve functions. | 111 |
| Configure the Virtual I/O Server to support exporting the PPRC secondary disk to client partitions | 113 |
| Identifying exportable disks | 113 |
| Getting started with shared storage pools by using the VIOS command line | 114 |
| Configuring the system to create shared storage pools. | 115 |
| Managing a cluster by using the VIOS command line | 116 |
| Creating a cluster with a single VIOS logical partition | 116 |
| Adding a VIOS logical partition to a cluster | 118 |
| Removing a VIOS logical partition from a cluster | 119 |
| Deleting a cluster | 119 |
| Managing storage pools by using the VIOS command line | 120 |
| Adding storage space to the storage pool | 120 |
| Changing the storage threshold | 123 |

| | |
|---|-----|
| Managing logical units by using the VIOS command line | 124 |
| Provisioning client partitions with logical unit storage | 124 |
| Unmapping a logical unit | 127 |
| Removing logical units | 128 |
| Migrating a cluster configuration | 129 |
| Getting started with shared storage pools by using the VIOS configuration menu | 130 |
| Managing a cluster by using the VIOS configuration menu | 130 |
| Creating a cluster | 130 |
| Listing all clusters | 131 |
| Deleting a cluster | 131 |
| Adding VIOS nodes to a cluster | 132 |
| Deleting VIOS nodes from a cluster | 132 |
| Listing VIOS nodes in a cluster | 133 |
| Managing storage pools by using the VIOS configuration menu | 133 |
| Listing storage pools in a cluster | 133 |
| Listing physical volumes in the storage pool | 133 |
| Adding storage space to the storage pool | 134 |
| Setting and modifying the storage pool threshold alert | 135 |
| Managing logical units by using the VIOS configuration menu | 137 |
| Creating and mapping logical units | 137 |
| Creating logical units | 137 |
| Mapping logical units | 138 |
| Unmapping logical units | 138 |
| Deleting a logical unit | 139 |
| Listing logical units | 140 |
| Listing logical unit maps | 140 |
| Creating a logical unit snapshot | 141 |
| Listing logical unit snapshots | 141 |
| Rolling back to the logical unit snapshot | 142 |
| Deleting a logical unit snapshot | 143 |
| Getting started with Trusted Logging | 143 |
| Virtual log repositories | 145 |
| Virtual logs | 145 |
| Virtual log devices | 147 |
| Configuring the virtual log repository | 147 |
| Creating a virtual log | 148 |
| Listing virtual logs or virtual log devices | 148 |
| Reconfiguring virtual logs or virtual log devices | 149 |
| Removing virtual logs or virtual log devices | 150 |
| Live Partition Mobility of virtual log devices | 150 |
| Virtual log devices with shared storage pools | 150 |
| Benefits of using virtual log devices with shared storage pools | 150 |
| Using virtual log devices with shared storage pools | 152 |
| Getting started with Trusted Firewall | 153 |
| Configuring virtual Ethernet on the Virtual I/O Server | 154 |
| Creating a virtual Ethernet adapter by using HMC Version 7 | 154 |
| Configuring a Shared Ethernet Adapter | 156 |
| Configuring a Link Aggregation or EtherChannel device | 159 |
| Assigning the virtual Fibre Channel adapter to a physical Fibre Channel adapter | 159 |
| Configuring the Tivoli agents and clients on the Virtual I/O Server | 161 |
| Configuring the Tivoli Monitoring agent | 161 |
| Configuring the Tivoli Usage and Accounting Manager agent | 163 |
| Configuring the Tivoli Storage Manager client | 164 |
| Configuring the TotalStorage Productivity Center agents | 165 |
| Configuring the Director agent | 167 |
| Configuring the Virtual I/O Server as an LDAP client | 168 |
| Managing the Virtual I/O Server | 168 |
| Managing storage | 169 |
| Importing and exporting volume groups and logical volume storage pools | 169 |
| Importing volume groups and logical volume storage pools | 169 |
| Exporting volume groups and logical volume storage pools | 170 |

| | |
|--|-----|
| Mapping virtual disks to physical disks | 171 |
| Increasing virtual SCSI device capacity | 172 |
| Changing the virtual SCSI queue depth | 174 |
| Backing up and restoring files and file systems | 175 |
| Managing storage using the TotalStorage Productivity Center | 175 |
| Managing networks | 176 |
| Changing the network configuration of the Virtual I/O Server logical partition | 176 |
| Dynamically adding or removing VLANs on the Virtual I/O Server | 176 |
| Enabling and disabling GVRP | 177 |
| Managing SNMP on the Virtual I/O Server | 178 |
| Upgrading the Virtual I/O Server from IPv4 to IPv6 | 178 |
| Backing up the Virtual I/O Server | 179 |
| Backing up the Virtual I/O Server to tape | 180 |
| Backing up the Virtual I/O Server to one or more DVDs | 181 |
| Backing up the Virtual I/O Server to a remote file system by creating a <code>nim_resources.tar</code> file | 182 |
| Backing up the Virtual I/O Server to a remote file system by creating a <code>mksysb</code> image | 183 |
| Backing up user-defined virtual devices | 183 |
| Backing up user-defined virtual devices by using the <code>backupios</code> command | 184 |
| Backing up user-defined virtual devices by using the <code>viosbr</code> command | 186 |
| Scheduling backups of the Virtual I/O Server and user-defined virtual devices | 187 |
| Scheduling backups of the Virtual I/O Server and user-defined virtual devices by creating a script and <code>crontab</code> file entry | 187 |
| Scheduling backups of user-defined virtual devices by using the <code>viosbr</code> command | 188 |
| Backing up the Virtual I/O Server by using Tivoli Storage Manager | 189 |
| Backing up the Virtual I/O Server by using Tivoli Storage Manager automated backup | 189 |
| Backing up the Virtual I/O Server by using Tivoli Storage Manager incremental backup | 190 |
| Restoring the Virtual I/O Server | 190 |
| Restoring the Virtual I/O Server from tape | 192 |
| Restoring the Virtual I/O Server from one or more DVDs | 192 |
| Restoring the Virtual I/O Server from the HMC by using a <code>nim_resources.tar</code> file | 193 |
| Restoring the Virtual I/O Server from a NIM server by using a <code>mksysb</code> file | 193 |
| Restoring user-defined virtual devices | 195 |
| Restoring user-defined virtual devices manually | 195 |
| Restoring user-defined virtual devices by using the <code>viosbr</code> command | 196 |
| Restoring the Virtual I/O Server by using Tivoli Storage Manager | 197 |
| Installing or replacing a PCI adapter with the system power on in Virtual I/O Server | 199 |
| Getting started | 199 |
| Installing a PCI adapter | 200 |
| Replacing a PCI adapter | 200 |
| Unconfiguring storage adapters | 201 |
| Preparing the client logical partitions | 201 |
| Shutting down logical partitions | 202 |
| Viewing information and statistics about the Virtual I/O Server, the server, and virtual resources | 203 |
| Monitoring the Virtual I/O Server | 204 |
| Security on the Virtual I/O Server | 205 |
| Connecting to the Virtual I/O Server by using OpenSSH | 205 |
| Configuring Virtual I/O Server system security hardening | 208 |
| Setting a security level | 208 |
| Changing the settings in a security level | 209 |
| Viewing the current security setting | 209 |
| Removing security level settings | 209 |
| Configuring Virtual I/O Server firewall settings | 209 |
| Configuring a Kerberos client on the Virtual I/O Server | 210 |
| Using role-based access control with the Virtual I/O Server | 211 |
| Managing users on the Virtual I/O Server | 219 |
| Troubleshooting the Virtual I/O Server | 220 |
| Troubleshooting the Virtual I/O Server logical partition | 220 |
| Troubleshooting virtual SCSI problems | 221 |
| Correcting a failed Shared Ethernet Adapter configuration | 221 |
| Debugging problems with Ethernet connectivity | 222 |
| Enabling noninteractive shells on Virtual I/O Server 1.3 or later | 223 |

| | |
|---|------------|
| Recovering when disks cannot be located | 223 |
| Troubleshooting AIX client logical partitions | 225 |
| Reference information for the Virtual I/O Server | 226 |
| Virtual I/O Server and Integrated Virtualization Manager command descriptions | 227 |
| Configuration attributes for Tivoli agents and clients | 227 |
| GARP VLAN Registration Protocol statistics | 230 |
| Network attributes | 236 |
| Shared Ethernet Adapter failover statistics. | 245 |
| Shared Ethernet Adapter statistics | 252 |
| User types for the Virtual I/O Server | 258 |
| Notices | 261 |
| Programming interface information | 262 |
| Trademarks | 262 |
| Terms and conditions. | 263 |

Virtual I/O Server

You can manage the Virtual I/O Server (VIOS) and client logical partitions by using the Hardware Management Console (HMC) and the Virtual I/O Server command-line interface.

The PowerVM® Editions feature includes the installation media for the VIOS software. The VIOS facilitates the sharing of physical I/O resources between client logical partitions within the server.

When you install the VIOS in a logical partition on a system that is managed by the HMC, you can use the HMC and the Virtual I/O Server command-line interface to manage the Virtual I/O Server and client logical partitions. As an alternative to the HMC, you can also use the Systems Director Management Console (SDMC) to manage the VIOS and client logical partitions.

When you install the VIOS on a managed system and there is no HMC attached to the managed system when you install the VIOS, then the VIOS logical partition becomes the management partition. The management partition provides the Integrated Virtualization Manager web-based system management interface and a command-line interface that you can use to manage the system.

For the most recent information about devices that are supported on the VIOS and to download VIOS fixes and updates, see the Fix Central website.

Related information:

- [PowerVM Information Roadmap](#)
- [Integrated Virtualization Manager](#)
- [Virtual I/O Server and Integrated Virtualization Manager commands](#)
- [Managing the Virtual I/O Server by using the SDMC](#)
- [VIOS release notes](#)

What's new in Virtual I/O Server

Read about new or changed information in Virtual I/O Server (VIOS) since the previous update of this topic collection.

May 2012

The following information is new for the Trusted Firewall feature:

- “Getting started with Trusted Firewall” on page 153

December 2011

The following updates have been made to the content.

With Virtual I/O Server (VIOS) Version 2.2.1.3, or later, you can create a cluster that consists of up to four networked VIOS partitions that are connected to the same shared storage pool. This cluster has access to distributed storage. The following information is new or updated for clusters:

- “Virtual SCSI” on page 20
- “Clusters” on page 26
- “Storage pools” on page 27
- “Getting started with shared storage pools by using the VIOS command line” on page 114

- “Configuring the system to create shared storage pools” on page 115
- “Managing a cluster by using the VIOS command line” on page 116
- “Creating a cluster with a single VIOS logical partition” on page 116
- “Adding a VIOS logical partition to a cluster” on page 118
- “Removing a VIOS logical partition from a cluster” on page 119
- “Adding storage space to the storage pool” on page 120
- “Adding physical volumes to the storage pool” on page 120
- “Replacing physical volumes in the storage pool” on page 122
- “Changing the storage threshold” on page 123
- “Creating logical units” on page 124
- “Enabling the logical unit backed storage” on page 126
- “Removing logical units” on page 128
- “Migrating a cluster configuration” on page 129
- “Getting started with shared storage pools by using the VIOS configuration menu” on page 130
- “Managing a cluster by using the VIOS configuration menu” on page 130
- “Listing all clusters” on page 131
- “Adding VIOS nodes to a cluster” on page 132
- “Deleting VIOS nodes from a cluster” on page 132
- “Listing VIOS nodes in a cluster” on page 133
- “Adding storage space to the storage pool” on page 134
- “Replacing physical volumes in the storage pool” on page 134
- “Creating a logical unit snapshot” on page 141
- “Listing logical unit snapshots” on page 141
- “Listing snapshots for a logical unit” on page 141
- “Listing logical units in a snapshot” on page 142
- “Listing all logical unit snapshots” on page 142
- “Rolling back to the logical unit snapshot” on page 142
- “Deleting a logical unit snapshot” on page 143
- “Virtual log devices” on page 147
- “Live Partition Mobility of virtual log devices” on page 150
- “Virtual log devices with shared storage pools” on page 150
- “Benefits of using virtual log devices with shared storage pools” on page 150
- “Using virtual log devices with shared storage pools” on page 152
- “Using role-based access control with the Virtual I/O Server” on page 211

October 2011

The following updates have been made to the content.

- Added information about the 7/10 (31E/1C), 7/20 (02E/4C), 7/30 (31E/2C), and 7/40 (05E/6C) servers.
 - “Operating system support for VIOS client logical partitions” on page 11
 - “Limitations and restrictions of the Virtual I/O Server configuration” on page 65
- Added information about the 7/70 (17M/MC) and 7/80 (79M/HC) servers.
 - “Operating system support for VIOS client logical partitions” on page 11
 - “Limitations and restrictions of the Virtual I/O Server configuration” on page 65
- Added information about the and servers.

- “Operating system support for VIOS client logical partitions” on page 11
- “Limitations and restrictions of the Virtual I/O Server configuration” on page 65
- With the VIOS Version 2.2.1.0, or later, you can use the Trusted Logging capability. Trusted Logging is a capability that is supported on the PowerSC Standard Edition. By using the Trusted Logging capability, you can configure AIX® logical partitions to write to log files stored on an attached VIOS. The following information is new or updated for partitions that are capable of the Trusted Logging capability:
 - “Getting started with Trusted Logging” on page 143
 - “Virtual log repositories” on page 145
 - “Virtual logs” on page 145
 - “Virtual log devices” on page 147
 - “Configuring the virtual log repository” on page 147
 - “Creating a virtual log” on page 148
 - “Listing virtual logs or virtual log devices” on page 148
 - “Reconfiguring virtual logs or virtual log devices” on page 149
 - “Removing virtual logs or virtual log devices” on page 150
 - “Live Partition Mobility of virtual log devices” on page 150
 - “Virtual log devices with shared storage pools” on page 150
 - “Benefits of using virtual log devices with shared storage pools” on page 150
 - “Using virtual log devices with shared storage pools” on page 152
- With the VIOS Version 2.2.1.0, or later, you can configure primary and backup Shared Ethernet Adapters for load sharing. The following information is new or updated for Shared Ethernet Adapters that are capable of the load sharing capability:
 - “Scenario: Configuring Shared Ethernet Adapter failover with load sharing” on page 59
 - “Shared Ethernet Adapters for load sharing” on page 83

May 2011

The following updates have been made to the content.

- The following information is updated for the BladeCenter® PS/703 and BladeCenter PS/704 servers:
 - “Operating system support for VIOS client logical partitions” on page 11
 - “Limitations and restrictions of the Virtual I/O Server configuration” on page 65
- The SDMC can be used to manage systems servers. The following information is new or updated for SDMC:
 - “Virtual I/O Server” on page 1
 - “Installing the Virtual I/O Server and client logical partitions” on page 88
 - “Installing the Virtual I/O Server manually by using HMC Version 7, release 7.1, and later” on page 88
 - “Entering the activation code for PowerVM Editions by using HMC Version 7” on page 89
 - “Creating the Virtual I/O Server logical partition on an HMC managed system” on page 89
 - “Creating the Virtual I/O Server logical partition and partition profile manually by using the HMC” on page 89
 - “Creating the Virtual I/O Server logical partition and client logical partitions by using the HMC to deploy a system plan” on page 91
 - “Installing the Virtual I/O Server from the HMC” on page 91
 - “Installing the Virtual I/O Server from CD or DVD” on page 92
 - “Finishing the Virtual I/O Server installation” on page 94
 - “Viewing and accepting the Virtual I/O Server license” on page 94

- “Migrating the Virtual I/O Server” on page 96
- “Migrating the Virtual I/O Server from the HMC” on page 97
- “Migrating the Virtual I/O Server from a downloaded image” on page 98
- “Migrating the Virtual I/O Server from DVD” on page 100
- “Setting the reserve policy attributes of a device” on page 108
- “Configuring virtual Ethernet on the Virtual I/O Server” on page 154
- “Creating a virtual Ethernet adapter by using HMC Version 7” on page 154
- “Setting the LHEA to promiscuous mode” on page 155
- “Backing up the Virtual I/O Server” on page 179
- “Backing up the Virtual I/O Server to tape” on page 180
- “Backing up the Virtual I/O Server to one or more DVDs” on page 181
- “Backing up the Virtual I/O Server to a remote file system by creating a nim_resources.tar file” on page 182
- “Backing up the Virtual I/O Server to a remote file system by creating a mksysb image” on page 183
- “Backing up user-defined virtual devices” on page 183
- “Backing up user-defined virtual devices by using the **backupios** command” on page 184
- “Backing up user-defined virtual devices by using the **viosbr** command” on page 186
- “Scheduling backups of the Virtual I/O Server and user-defined virtual devices” on page 187
- “Scheduling backups of the Virtual I/O Server and user-defined virtual devices by creating a script and **crontab** file entry” on page 187
- “Scheduling backups of user-defined virtual devices by using the **viosbr** command” on page 188
- “Backing up the Virtual I/O Server by using Tivoli Storage Manager” on page 189
- “Backing up the Virtual I/O Server by using Tivoli Storage Manager automated backup” on page 189
- “Backing up the Virtual I/O Server by using Tivoli Storage Manager incremental backup” on page 190
- “Restoring the Virtual I/O Server” on page 190
- “Restoring the Virtual I/O Server from tape” on page 192
- “Restoring the Virtual I/O Server from one or more DVDs” on page 192
- “Restoring the Virtual I/O Server from the HMC by using a nim_resources.tar file” on page 193
- “Restoring the Virtual I/O Server from a NIM server by using a mksysb file” on page 193
- “Restoring user-defined virtual devices” on page 195
- “Restoring user-defined virtual devices manually” on page 195
- “Restoring user-defined virtual devices by using the **viosbr** command” on page 196
- “Restoring the Virtual I/O Server by using Tivoli Storage Manager” on page 197
- “Recovering when disks cannot be located” on page 223

December 2010

The following updates have been made to the content.

- With the HMC Version 7.7.2.0, or later, you can suspend an AIX or Linux logical partition with its operating system and applications, and store its virtual server state to persistent storage. At a later time, you can resume the operation of the logical partition. The following information is new or updated for partitions with the Suspend/Resume feature:
 - “Virtual I/O Server overview” on page 6
 - “Configuration requirements for shared memory” on page 78

- “Multipath I/O” on page 80
- “Setting the reserve policy attributes of a device” on page 108
- With the VIOS Version 2.2.0.11, Fix Pack 24, Service Pack 1, you can create a cluster of only one Virtual I/O Server partition connected to the same shared storage pool and having access to distributed storage. The following information is new or updated for clusters:
 - “Virtual SCSI” on page 20
 - “Physical volumes” on page 23
 - “Clusters” on page 26
 - “Storage pools” on page 27
 - “Creating the Virtual I/O Server logical partition and partition profile manually by using the HMC” on page 89
 - “Getting started with shared storage pools by using the VIOS command line” on page 114
 - “Configuring the system to create shared storage pools” on page 115
 - “Managing a cluster by using the VIOS command line” on page 116
 - “Creating a cluster with a single VIOS logical partition” on page 116
 - “Deleting a cluster” on page 119
 - “Managing storage pools by using the VIOS command line” on page 120
 - “Adding storage space to the storage pool” on page 120
 - “Adding physical volumes to the storage pool” on page 120
 - “Changing the storage threshold” on page 123
 - “Managing logical units by using the VIOS command line” on page 124
 - “Provisioning client partitions with logical unit storage” on page 124
 - “Creating logical units” on page 124
 - “Enabling the logical unit backed storage” on page 126
 - “Unmapping a logical unit” on page 127
 - “Removing logical units” on page 128
 - “Getting started with shared storage pools by using the VIOS configuration menu” on page 130
 - “Managing a cluster by using the VIOS configuration menu” on page 130
 - “Creating a cluster” on page 130
 - “Deleting a cluster” on page 131
 - “Managing storage pools by using the VIOS configuration menu” on page 133
 - “Listing storage pools in a cluster” on page 133
 - “Listing physical volumes in the storage pool” on page 133
 - “Adding storage space to the storage pool” on page 134
 - “Adding physical volumes to the storage pool” on page 134
 - “Listing physical volumes in the storage pool” on page 135
 - “Setting and modifying the storage pool threshold alert” on page 135
 - “Listing the storage pool threshold alert value” on page 135
 - “Changing the storage pool threshold alert value” on page 136
 - “Removing the storage pool threshold alert value” on page 136
 - “Managing logical units by using the VIOS configuration menu” on page 137
 - “Creating and mapping logical units” on page 137
 - “Creating logical units” on page 137
 - “Mapping logical units” on page 138
 - “Unmapping logical units” on page 138

- “Unmapping logical units by logical unit name” on page 138
- “Unmapping logical units by virtual server adapter name” on page 138
- “Unmapping logical units by virtual target device name” on page 139
- “Deleting a logical unit” on page 139
- “Listing logical units” on page 140
- “Listing logical unit maps” on page 140
- “Backing up user-defined virtual devices by using the **viosbr** command” on page 186
- “Restoring user-defined virtual devices by using the **viosbr** command” on page 196
- “Using role-based access control with the Virtual I/O Server” on page 211

September 2010

The following updates have been made to the content.

- The following information is updated for the 7/10 (31E/2B), 7/30 (31E/2B), 7/20 (02E/4B), 7/40 (05F/6B), and 7/95 (19F/HB) servers:
 - “Operating system support for VIOS client logical partitions” on page 11
 - “Limitations and restrictions of the Virtual I/O Server configuration” on page 65
- The following information is updated for the Universal Serial Bus (USB) (DAT320)-attached tape device:
 - “Tape” on page 28
- You can change PowerVM Editions while installing the Virtual I/O Server (VIOS). The following information is updated for VIOS installation:
 - “Installing the Virtual I/O Server from CD or DVD” on page 92
- With the VIOS Version 2.2, or later, you can add, remove, or modify the existing set of virtual local area networks (VLAN) for a virtual Ethernet adapter that is assigned to an active partition on a POWER7[®] processor-based server by using the Hardware Management Console (HMC) Version 7.7.2.0, or later. The following information is new or updated for the dynamic addition and removal of VLANs:
 - “Virtual Ethernet adapters” on page 36
 - “Dynamically adding or removing VLANs on the Virtual I/O Server” on page 176
- On the VIOS Version 2.2, or later, a system administrator can define roles based on job functions in an organization by using role-based access control (RBAC). The following information is new or updated for RBAC:
 - “Using role-based access control with the Virtual I/O Server” on page 211
 - “Managing users on the Virtual I/O Server” on page 219

March 2010

Added information for the new systems servers that contain the POWER7 processor.

Virtual I/O Server overview

Learn the concepts of the Virtual I/O Server (VIOS) and its primary components.

The VIOS is part of the PowerVM Editions hardware feature. The VIOS is software that is located in a logical partition. This software facilitates the sharing of physical I/O resources between client logical partitions within the server. The VIOS provides virtual Small Computer Serial Interface (SCSI) target, virtual Fibre Channel, Shared Ethernet Adapter, and PowerVM Active Memory™ Sharing capability to client logical partitions within the system. The VIOS also provides the Suspend/Resume feature to AIX and Linux client logical partitions within the system.

As a result, you can perform the following functions on client logical partitions:

- Share SCSI devices, Fibre Channel adapters, Ethernet adapters
- Expand the amount of memory available to logical partitions and suspend and resume logical partition operations by using paging space devices

A dedicated logical partition is required for the VIOS software solely for its use.

You can use the VIOS to perform the following functions:

- Sharing of physical resources between logical partitions on the system
- Creating logical partitions without requiring additional physical I/O resources
- Creating more logical partitions than there are I/O slots or physical devices available with the ability for logical partitions to have dedicated I/O, virtual I/O, or both
- Maximizing use of physical resources on the system
- Helping to reduce the storage area network (SAN) infrastructure

Related information:

 [Virtual I/O Server and Integrated Virtualization Manager commands](#)

PowerVM Editions overview

Learn about the editions of the PowerVM Editions hardware feature.

The PowerVM Editions hardware feature includes the following editions:

- PowerVM Express Edition
- PowerVM Standard Edition
- PowerVM Enterprise Edition

The following table describes each component of the PowerVM Editions feature and the editions in which each component is included.

Table 1. PowerVM Editions components and editions

| Component | Description | Editions |
|---|--|---|
| Integrated Virtualization Manager (IVM) | You can use the graphical interface of the Virtual I/O Server (VIOS) management partition on some servers that are not managed by a Hardware Management Console (HMC) or an Systems Director Management Console (SDMC). | <ul style="list-style-type: none"> • Express Edition • Standard Edition • Enterprise Edition |
| Live Partition Mobility | You can migrate an active or inactive AIX or Linux logical partition from one system to another by using Live Partition Mobility. | <ul style="list-style-type: none"> • Enterprise Edition • Trial Live Partition Mobility |
| Logical partition suspend and resume | A running AIX, Linux, or logical partition can be suspended along with its operating system and applications. When a logical partition is suspended, the state of the logical partition is saved on persistent storage, and the server resources that were in use by that logical partition are made available for use by other logical partitions. At a later time, the operation of the suspended logical partition and its applications can be resumed. | <ul style="list-style-type: none"> • Express Edition • Standard Edition • Enterprise Edition |

Table 1. PowerVM Editions components and editions (continued)

| Component | Description | Editions |
|--|---|--|
| Management | Management tools like HMC, IVM, SDMC, and VMControl help to aggregate and manage resources by using a consolidated, logical view. | <ul style="list-style-type: none"> • Express Edition (Integrated Virtualization Manager, SDMC, and VMControl) • Standard Edition (HMC, Integrated Virtualization Manager, SDMC, and VMControl) • Enterprise Edition (HMC, Integrated Virtualization Manager, SDMC, and VMControl) |
| Micro-Partitioning [®] technology | You can allocate processors to logical partitions in increments of 0.01 which allows multiple logical partitions to share the processing power of the system. Micropartitions can be defined as small as 0.1 of a processor and can be changed in increments as small as 0.01 of a processor. A maximum of 10 micropartitions can be created per core. | <ul style="list-style-type: none"> • Express Edition • Standard Edition • Enterprise Edition |
| N-Port ID Virtualization (NPIV) | NPIV is a standard technology for Fibre Channel networks. With NPIV you can connect multiple logical partitions to one physical port of a physical Fibre Channel adapter. | <ul style="list-style-type: none"> • Express Edition • Standard Edition • Enterprise Edition |
| PowerSC | <p>With HMC Version 7.7.4, or later, and POWER7 processor-based servers with firmware at level 7.4, or later, you can enable Virtual Trusted Platform Module (VTPM) on an AIX logical partition. You can configure logical partitions on each server by using the HMC or the SDMC, with each logical partition having its own unique VTPM. The VTPM software implementation checks system boot process, and in association with the AIX Trusted Execution technology provides security and assurance of the boot image on the disk, operating system, and application layers.</p> <p>Trusted Firewall is a feature of PowerSC and you can enable Trusted Firewall in PowerVM. Trusted Firewall is supported on VIOS Version 2.2.1.5, or later. With the Trusted Firewall feature, you can perform inter-VLAN routing functions by using the Security Virtual Machine (SVM) kernel extension. By using Trusted Firewall, logical partitions that are present on different VLANs of the same server can communicate by using the Shared Ethernet Adapter (SEA).</p> <p>A logical partition that is enabled for VTPM has the Trusted Boot capability. Trusted Boot is an offering that is supported on the Power Security and Compliance (PowerSC) Standard Edition. Trusted Boot is a feature of PowerSC. You can enable Trusted Boot in PowerVM. Trusted Boot uses the Virtual Trusted Platform Module (VTPM) software implementation on an AIX logical partition.</p> | <ul style="list-style-type: none"> • Standard Edition • Enterprise Edition |

Table 1. PowerVM Editions components and editions (continued)

| Component | Description | Editions |
|-------------------------------|---|--|
| PowerVM Active Memory Sharing | You can share memory among logical partitions in a shared memory pool, by using PowerVM Active Memory Sharing. | Enterprise Edition |
| Shared processor pools | You can assign priorities to partitions, and the hypervisor allocates processing power as needed by the applications. This provides automatic nondisruptive balancing of processing power between logical partitions assigned to shared pools, which results in increased throughput and the potential to reduce processor-based software licensing costs. This feature is supported on POWER6® and POWER7 processor-based servers. | <ul style="list-style-type: none"> • Standard Edition • Enterprise Edition |
| Shared storage pools | Shared storage pools provide distributed storage access to all VIOS logical partitions in the cluster. On VIOS Version 2.2.0.11, Fix Pack 24, Service Pack 1, you can create a cluster of only one VIOS partition connected to the same shared storage pool. On VIOS Version 2.2.1.3, or later, you can create a cluster that consists of up to four VIOS partitions. | <ul style="list-style-type: none"> • Standard Edition • Enterprise Edition |
| Thin provisioning | Thin provisioning helps reduce the amount of unused storage that is allocated to applications or users. Allocation of actual space on the storage subsystem is deferred until the data is written to disk. | <ul style="list-style-type: none"> • Standard Edition • Enterprise Edition |
| Thick provisioning | Thick provisioning helps reserve storage space for virtual disks, thus ensuring that no failures occur because of lack of storage space. | <ul style="list-style-type: none"> • Standard Edition • Enterprise Edition |
| VIOS | You can share physical I/O resources between client logical partitions within the server by using VIOS. | <ul style="list-style-type: none"> • Express® Edition • Standard Edition • Enterprise Edition |

PowerVM Express Edition

PowerVM Express Edition is designed for users looking for an introduction to more advanced virtualization features at a highly affordable price.

The PowerVM Express Edition includes the following components of the PowerVM Editions hardware feature:

- Micro-Partitioning technology
- Virtual I/O Server
- Integrated Virtualization Manager (IVM)
- N-Port ID Virtualization (NPIV)

To use the Express Edition, the system must be managed by the Integrated Virtualization Manager or by an Systems Director Management Console (SDMC).

Using the Express Edition, you can create up to two client logical partitions that use virtual Small Computer System Interface (SCSI), NPIV, and shared processors, also called Micro-Partitioning technology. To create more than two client logical partitions that use shared processors, virtual SCSI, or NPIV, you must purchase either the Standard Edition or the Enterprise Edition and enter the activation code.

An activation code is required to enable the PowerVM Editions hardware feature. When you specify the feature with the initial system order, the firmware is activated to support the components of the feature. If you order the feature separately from the server, you can enter the code by using the SDMC, or the IVM.

PowerVM Standard Edition

PowerVM Standard Edition includes features designed to allow businesses to increase system utilization; while helping to ensure applications continue to get the resources they need.

The PowerVM Standard Edition includes the following components of the PowerVM Editions hardware feature:

- Micro-Partitioning technology
- Virtual I/O Server (VIOS)
- Integrated Virtualization Manager (IVM)
- Partition suspend and resume
- Trusted Boot
- N-Port ID Virtualization (NPIV)
- Shared processor pools
- Shared storage pools
- Thin provisioning

You can use the Standard Edition with POWER7 processor-based servers.

In Hardware Management Console (HMC) or Systems Director Management Console (SDMC) environments, the IVM is disabled because the system is managed by the HMC or SDMC. For servers that are not managed by an HMC or SDMC, the VIOS becomes the management partition and provides the IVM to help you manage the system.

An activation code is required to enable the PowerVM Editions hardware feature. When you specify the feature with the initial system order, the firmware is activated to support the components of the feature. If you order the feature separately from the server, you can enter the code by using the HMC, the SDMC, or the IVM.

PowerVM Enterprise Edition

PowerVM Enterprise Edition includes all the features of PowerVM Standard Edition and two more capabilities called Active Memory Sharing and Live Partition Mobility.

PowerVM Enterprise Edition includes the following components of the PowerVM Editions hardware feature:

- PowerVM Active Memory Sharing
- Micro-Partitioning technology
- Virtual I/O Server (VIOS)
- Integrated Virtualization Manager (IVM)
- Live Partition Mobility

Note:

Note: On POWER7 processor-based servers with firmware at level 7.3, or later, you can evaluate Live Partition Mobility at no charge by using Trial Live Partition Mobility. Trial Live Partition Mobility requires an activation code. You must have a valid license and an active Software Maintenance contract for PowerVM Standard Edition to use Trial Live Partition Mobility.

- Partition Suspend/Resume

- N-Port ID Virtualization (NPIV)
- Shared processor pools
- Shared storage pools
- Thin provisioning
- Trusted Boot

. You can use the Enterprise Edition with POWER7 processor-based servers. Like the Standard Edition, in Hardware Management Console (HMC) or Systems Director Management Console (SDMC) environments, the IVM is disabled because the system is managed by the HMC or SDMC. For servers that are not managed by an HMC or SDMC, the VIOS becomes the management partition and provides the IVM to help you manage the system.

An activation code is required to enable the PowerVM Editions hardware feature. When you specify the feature with the initial system order, the firmware is activated to support the components of the feature. If you order the feature separately from the server, you can enter the code by using the HMC, the SDMC, or the IVM. This code differs from the PowerVM Standard Edition activation code. For example, you might have previously purchased the Standard Edition and enabled the feature on the system. Now you want the ability to move logical partitions from one system to another. To do so, you must purchase the Enterprise Edition and enter the activation code for the Enterprise Edition.

Operating system support for VIOS client logical partitions

The Virtual I/O Server (VIOS) supports client logical partitions that run the following operating systems on the following POWER7 processor-based servers.

Table 2. Minimum operating system versions required for Virtual I/O Server client logical partitions

| POWER7 processor-based servers | Minimum operating system versions |
|--|--|
| All POWER7 processor-based servers | operating system |
| All POWER7 processor-based servers | AIX 6.1 |
| All POWER7 processor-based servers | AIX 5.3 |
| <ul style="list-style-type: none"> • 02E/4B • 02E/4C • 05F/6B • 05E/6C • 31E/2B • 31E/1C • 31E/2C • 33E/8B • 36E/8C • 17M/MB • 17M/MC • 19F/HB • 79M/HB • 79M/HC • BladeCenter PS/700 • BladeCenter PS/701 • BladeCenter PS/702 • BladeCenter PS/703 • BladeCenter PS/704 | SUSE Linux Enterprise Server 11 Service Pack 1 |

Table 2. Minimum operating system versions required for Virtual I/O Server client logical partitions (continued)

| POWER7 processor-based servers | Minimum operating system versions |
|--|--|
| <ul style="list-style-type: none"> • 02E/4C • 05E/6C • 31E/1C • 31E/2C • 17M/MC • 79M/HC • BladeCenter PS/703 • BladeCenter PS/704 | SUSE Linux Enterprise Server 10 Service Pack 4 |
| <ul style="list-style-type: none"> • 02E/4B • 05F/6B • 31E/2B • 33E/8B • 36E/8C • 17M/MB • 19F/HB • 79M/HB • BladeCenter PS/700 • BladeCenter PS/701 • BladeCenter PS/702 | SUSE Linux Enterprise Server 10 Service Pack 3 |
| <ul style="list-style-type: none"> • 02E/4C • 05E/6C • 31E/1C • 31E/2C • 17M/MC • 79M/HC | Red Hat Enterprise Linux Version 6.1 |
| <ul style="list-style-type: none"> • 02E/4B • 05F/6B • 31E/2B • 33E/8B • 36E/8C • 17M/MB • 19F/HB • 79M/HB • BladeCenter PS/700 • BladeCenter PS/701 • BladeCenter PS/702 • BladeCenter PS/703 • BladeCenter PS/704 | Red Hat Enterprise Linux Version 6 |
| <ul style="list-style-type: none"> • 02E/4C • 05E/6C • 31E/1C • 31E/2C • 17M/MC • 79M/HC | Red Hat Enterprise Linux Version 5.7 |

Table 2. Minimum operating system versions required for Virtual I/O Server client logical partitions (continued)

| POWER7 processor-based servers | Minimum operating system versions |
|--|--------------------------------------|
| <ul style="list-style-type: none"> • BladeCenter PS/703 • BladeCenter PS/704 | Red Hat Enterprise Linux Version 5.6 |
| <ul style="list-style-type: none"> • 02E/4B • 05F/6B • 31E/2B • 33E/8B • 36E/8C • 17M/MB • 19F/HB • 79M/HB • BladeCenter PS/700 • BladeCenter PS/701 • BladeCenter PS/702 | Red Hat Enterprise Linux version 5.5 |

Components of the Virtual I/O Server

This topic provides a brief overview of virtual Small Computer Serial Interface (SCSI), virtual networking, and the Integrated Virtualization Manager (IVM).

The Virtual I/O Server comprises the following primary components:

- Virtual SCSI
- Virtual networking
- IVM (Integrated Virtualization Manager)

The following sections provide a brief overview of each of these components.

Virtual SCSI

Physical adapters with attached disks or optical devices on the Virtual I/O Server logical partition can be shared by one or more client logical partitions. The Virtual I/O Server offers a local storage subsystem that provides standard SCSI-compliant logical unit numbers (LUNs). The Virtual I/O Server can export a pool of heterogeneous physical storage as a homogeneous pool of block storage in the form of SCSI disks.

Unlike typical storage subsystems that are physically located in the storage area network (SAN), the SCSI devices exported by the Virtual I/O Server are limited to the domain within the server. Although the SCSI LUNs are SCSI compliant, they might not meet the needs of all applications, particularly those that exist in a distributed environment.

The following SCSI peripheral-device types are supported:

- Disks backed up by logical volumes
- Disks backed up by physical volumes
- Disks backed up by files
- Optical devices (DVD-RAM and DVD-ROM)
- Optical devices backed up by files
- Tape devices

Virtual networking

Virtual I/O Server provides the following virtual networking technologies.

Table 3. Virtual networking technologies on the Virtual I/O Server

| Virtual networking technology | Description |
|------------------------------------|--|
| Shared Ethernet Adapter | <p>A Shared Ethernet Adapter is a layer-2 Ethernet bridge that connects physical and virtual networks together. It allows logical partitions on the virtual local area network (VLAN) to share access to a physical Ethernet adapter and to communicate with systems outside the server. Using a Shared Ethernet Adapter, logical partitions on the internal VLAN can share the VLAN with stand-alone servers.</p> <p>On POWER7 processor-based systems, you can assign a logical host Ethernet port of a logical Host Ethernet Adapter, sometimes referred to as Integrated Virtual Ethernet, as the real adapter of a Shared Ethernet Adapter. A Host Ethernet Adapter is a physical Ethernet adapter that is integrated directly into the GX+ bus on a managed system. Host Ethernet Adapters offer high throughput, low latency, and virtualization support for Ethernet connections.</p> <p>The Shared Ethernet Adapter on the Virtual I/O Server supports IPv6. IPv6 is the next generation of Internet Protocol and is gradually replacing the current Internet standard, Internet Protocol Version 4 (IPv4). The key IPv6 enhancement is the expansion of the IP address space from 32 bits to 128 bits, providing virtually unlimited, unique IP addresses.</p> |
| Shared Ethernet Adapter failover | Shared Ethernet Adapter failover provides redundancy by configuring a backup Shared Ethernet Adapter on a different Virtual I/O Server logical partition that can be used if the primary Shared Ethernet Adapter fails. The network connectivity in the client logical partitions continues without disruption. |
| Link Aggregation (or EtherChannel) | A Link Aggregation (or EtherChannel) device is a network port-aggregation technology that allows several Ethernet adapters to be aggregated. The adapters can then act as a single Ethernet device. Link Aggregation helps provide more throughput over a single IP address than would be possible with a single Ethernet adapter. |
| VLAN | VLAN allows the physical network to be logically segmented. |

IVM

The IVM (Integrated Virtualization Manager) provides a browser-based interface and a command-line interface that you can use to manage some servers that use the Virtual I/O Server. On the managed system, you can create logical partitions, manage the virtual storage and virtual Ethernet, and view service information related to the server. The IVM is packaged with the Virtual I/O Server, but it is activated and usable only on certain platforms and where no Hardware Management Console (HMC) is present.

Virtual Fibre Channel

With N_Port ID Virtualization (NPIV), you can configure the managed system so that multiple logical partitions can access independent physical storage through the same physical Fibre Channel adapter.

To access physical storage in a typical storage area network (SAN) that uses Fibre Channel, the physical storage is mapped to logical units (LUNs) and the LUNs are mapped to the ports of physical Fibre Channel adapters. Each physical port on each physical Fibre Channel adapter is identified using one worldwide port name (WWPN).

NPIV is a standard technology for Fibre Channel networks that enables you to connect multiple logical partitions to one physical port of a physical Fibre Channel adapter. Each logical partition is identified by a unique WWPN, which means that you can connect each logical partition to independent physical storage on a SAN.

To enable NPIV on the managed system, you must create a Virtual I/O Server logical partition (version 2.1, or later) that provides virtual resources to client logical partitions. You assign the physical Fibre Channel adapters (that support NPIV) to the Virtual I/O Server logical partition. Then, you connect virtual Fibre Channel adapters on the client logical partitions to virtual Fibre Channel adapters on the Virtual I/O Server logical partition. A *virtual Fibre Channel adapter* is a virtual adapter that provides client logical partitions with a Fibre Channel connection to a storage area network through the Virtual I/O Server logical partition. The Virtual I/O Server logical partition provides the connection between the virtual Fibre Channel adapters on the Virtual I/O Server logical partition and the physical Fibre Channel adapters on the managed system.

The following figure shows a managed system configured to use NPIV.

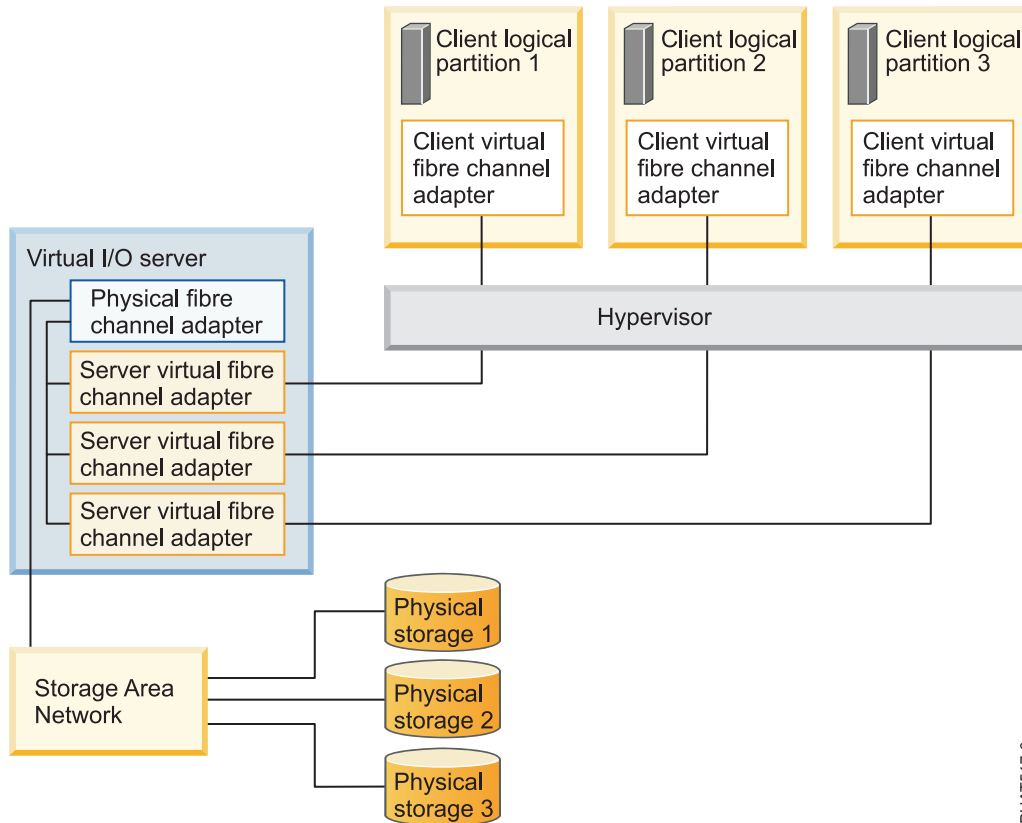

The figure shows the following connections:

IPHAT517-0

- A storage area network (SAN) connects three units of physical storage to a physical Fibre Channel adapter that is located on the managed system. The physical Fibre Channel adapter is assigned to the Virtual I/O Server and supports NPIV.
- The physical Fibre Channel adapter connects to three virtual Fibre Channel adapters on the Virtual I/O Server. All three virtual Fibre Channel adapters on the Virtual I/O Server connect to the same physical port on the physical Fibre Channel adapter.
- Each virtual Fibre Channel adapter on the Virtual I/O Server connects to one virtual Fibre Channel adapter on a client logical partition. Each virtual Fibre Channel adapter on each client logical partition receives a pair of unique WWPNs. The client logical partition uses one WWPN to log into the SAN at any given time. The other WWPN is used when you move the client logical partition to another managed system.

Using their unique WWPNs and the virtual Fibre Channel connections to the physical Fibre Channel adapter, the operating systems that run in the client logical partitions discover, instantiate, and manage their physical storage located on the SAN. In the previous figure, Client logical partition 1 accesses Physical storage 1, Client logical partition 2 accesses Physical storage 2, and Client logical partition 3 accesses Physical storage 3. The Virtual I/O Server cannot access and does not emulate the physical storage to which the client logical partitions have access. The Virtual I/O Server provides the client logical partitions with a connection to the physical Fibre Channel adapters on the managed system.

There is always a one-to-one relationship between virtual Fibre Channel adapters on the client logical partitions and the virtual Fibre Channel adapters on the Virtual I/O Server logical partition. That is, each virtual Fibre Channel adapter on a client logical partition must connect to only one virtual Fibre Channel adapter on the Virtual I/O Server logical partition, and each virtual Fibre Channel on the Virtual I/O Server logical partition must connect to only one virtual Fibre Channel adapter on a client logical partition.

Using SAN tools, you can zone and mask LUNs that include WWPNs that are assigned to virtual Fibre Channel adapters on client logical partitions. The SAN uses WWPNs that are assigned to virtual Fibre Channel adapters on client logical partitions the same way it uses WWPNs that are assigned to physical ports.

You can configure virtual Fibre Channel adapters on client logical partitions that run the following operating systems:

- AIX Version 6.1 Technology Level 2, or later
- AIX Version 5.3 Technology Level 9
- SUSE Linux Enterprise Server Version 11, or later
- SUSE Linux Enterprise Server Version 10, Service Pack 3, or later
- Red Hat Enterprise Server Version 5.4 or later
- Red Hat Enterprise Server Version 6 or later
- SUSE Linux Enterprise Server Version 11, or later
- SUSE Linux Enterprise Server Version 10, Service Pack 3, or later
- Red Hat Enterprise Server Version 5.4 or later
- Red Hat Enterprise Server Version 6 or later

Related concepts:

“Redundancy configuration using virtual Fibre Channel adapters” on page 84

Redundancy configurations help protect your network from physical adapter failures as well as Virtual I/O Server failures.

Virtual Fibre Channel for HMC-managed systems

On systems that are managed by the Hardware Management Console (HMC), you can dynamically add and remove virtual Fibre Channel adapters to and from the Virtual I/O Server logical partition and each

client logical partition. You can also view information about the virtual and physical Fibre Channel adapters and the worldwide port names (WWPNs) by using Virtual I/O Server commands.

To enable N_Port ID Virtualization (NPIV) on the managed system, you create the required virtual Fibre Channel adapters and connections as follows:

- You use the HMC to create virtual Fibre Channel adapters on the Virtual I/O Server logical partition and associate them with virtual Fibre Channel adapters on the client logical partitions.
- You use the HMC to create virtual Fibre Channel adapters on each client logical partition and associate them with virtual Fibre Channel adapters on the Virtual I/O Server logical partition. When you create a virtual Fibre Channel adapter on a client logical partition, the HMC generates a pair of unique WWPNs for the client virtual Fibre Channel adapter.
- You connect the virtual Fibre Channel adapters on the Virtual I/O Server to the physical ports of the physical Fibre Channel adapter by running the **vfcmap** command on the Virtual I/O Server.

The HMC generates WWPNs based on the range of names available for use with the prefix in the vital product data on the managed system. This 6–digit prefix comes with the purchase of the managed system and includes 32 000 pairs of WWPNs. When you remove a virtual Fibre Channel adapter from a client logical partition, the hypervisor deletes the WWPNs that are assigned to the virtual Fibre Channel adapter on the client logical partition. The HMC does not reuse the deleted WWPNs when generating WWPNs for virtual Fibre Channel adapters in the future. If you run out of WWPNs, you must obtain an activation code that includes another prefix with another 32 000 pairs of WWPNs.

To avoid configuring the physical Fibre Channel adapter to be a single point of failure for the connection between the client logical partition and its physical storage on the SAN, do not connect two virtual Fibre Channel adapters from the same client logical partition to the same physical Fibre Channel adapter. Instead, connect each virtual Fibre Channel adapter to a different physical Fibre Channel adapter.

You can dynamically add and remove virtual Fibre Channel adapters to and from the Virtual I/O Server logical partition and to and from client logical partitions.

Table 4. Dynamic logical partitioning tasks and results for virtual Fibre Channel adapters

| Dynamically add or remove virtual Fibre Channel adapter | To or from a client logical partition or a Virtual I/O Server logical partition | Result |
|---|---|---|
| Add a virtual Fibre Channel adapter | To a client logical partition | The HMC generates the a pair of unique WWPNs for the client virtual Fibre Channel adapter. |
| Add a virtual Fibre Channel adapter | To a Virtual I/O Server logical partition | You need to connect the virtual Fibre Channel adapter to a physical port on a physical Fibre Channel adapter. |
| Remove a virtual Fibre Channel adapter | From a client logical partition | <ul style="list-style-type: none"> • The hypervisor deletes the WWPNs and does not reuse them. • You must either remove the associated virtual Fibre Channel adapter from the Virtual I/O Server, or associate it with another virtual Fibre Channel adapter on a client logical partition. |

Table 4. Dynamic logical partitioning tasks and results for virtual Fibre Channel adapters (continued)

| Dynamically add or remove virtual Fibre Channel adapter | To or from a client logical partition or a Virtual I/O Server logical partition | Result |
|---|---|---|
| Remove a virtual Fibre Channel adapter | From a Virtual I/O Server logical partition | <ul style="list-style-type: none"> The Virtual I/O Server removes the connection to the physical port on the physical Fibre Channel adapter. You must either remove the associated virtual Fibre Channel adapter from the client logical partition, or associate it with another virtual Fibre Channel adapter on the Virtual I/O Server logical partition. |

The following table lists the Virtual I/O Server commands that you can run to view information about the Fibre Channel adapters.

Table 5. Virtual I/O Server commands that display information about Fibre Channel adapters

| Virtual I/O Server command | Information displayed by command |
|----------------------------|--|
| lsmap | <ul style="list-style-type: none"> Displays the virtual Fibre Channel adapters on the Virtual I/O Server that are connected to the physical Fibre Channel adapter Displays attributes of the virtual Fibre Channel adapters on the client logical partitions that are associated with the virtual Fibre Channel adapters on the Virtual I/O Server that are connected to the physical Fibre Channel adapter |
| lsnports | <p>Displays information about the physical ports on the physical Fibre Channel adapters that support NPIV, such as:</p> <ul style="list-style-type: none"> The name and location code of the physical port The number of available physical ports The total number of WWPNS that the physical port can support Whether the switches, to which the physical Fibre Channel adapters are cabled, support NPIV |

You can also run the **lshwres** command on the HMC to display the remaining number of WWPNS and to display the prefix that is currently used to generate the WWPNS.

Virtual Fibre Channel on IVM-managed systems

On systems that are managed by the Integrated Virtualization Manager (IVM), you can dynamically add and remove worldwide port names (WWPNs) to and from logical partitions, and you can dynamically change the physical ports to which the WWPNS are assigned. You can also view information about the virtual and physical fibre channel adapters and the WWPNS by using the **lsmap** and **lsnports** commands.

To enable N_Port ID Virtualization (NPIV) on the managed system, you create a pair of WWPNS for a logical partition and assign the pair directly to the physical ports of the physical Fibre Channel adapters. You can assign multiple logical partitions to one physical port by assigning a pair of WWPNS for each logical partition to the same physical port. When you assign a WWPNS pair to a logical partition, the IVM automatically creates the following connections:

- The IVM creates a virtual Fibre Channel adapter on the management partition and associates it with the virtual Fibre Channel adapter on the logical partition.
- The IVM generates a pair of unique WWPNs and creates a virtual Fibre Channel adapter on the client logical partition. The IVM assigns the WWPNs to the virtual Fibre Channel adapter on the client logical partition, and associates the virtual Fibre Channel adapter on the client logical partition with the virtual Fibre Channel adapter on the management partition.

When you assign the WWPNs for a logical partition to a physical port, the IVM connects the virtual Fibre Channel adapter on the management partition to the physical port on the physical Fibre Channel adapter.

The IVM generates WWPNs based on the range of names available for use with the prefix in the vital product data on the managed system. This 6–digit prefix comes with the purchase of the managed system and includes 32 768 pairs of WWPNs. When you remove the connection between a logical partition and a physical port, the hypervisor deletes the WWPNs that are assigned to the virtual Fibre Channel adapter on the logical partition. The IVM does not reuse the deleted WWPNs when generating WWPNs for virtual Fibre Channel adapters in the future. If you run out of WWPNs, you must obtain an activation code that includes another prefix with 32 768 pairs of WWPNs.

To avoid configuring the physical Fibre Channel adapter to be a single point of failure for the connection between the logical partition and its physical storage on the storage area network (SAN), do not assign a logical partition to one physical Fibre Channel adapter twice. For example, do not assign a WWPN pair for a logical partition to a physical port on a physical Fibre Channel adapter, and then assign another WWPN pair for the same logical partition to another physical port on the same physical Fibre Channel adapter. Instead, assign the WWPN pairs for each logical partition to different physical Fibre Channel adapters.

You can add WWPN pairs for a new logical partition without assigning them to a physical port. Being able to generate WWPNs independently of a physical port assignment for a logical partition allows you to communicate these names to the SAN administrator. This ensures that the SAN administrator can configure the SAN connection appropriately such that the logical partition can connect successfully to the SAN without regard for which physical port the partition uses for the connection.

You can dynamically add or remove a WWPN pair to and from a logical partition. You can also dynamically change the physical port that is assigned to a WWPN pair.

Table 6. Dynamic logical partitioning tasks and results

| Action | Result |
|--|---|
| Dynamically add a WWPN pair to a logical partition | <ul style="list-style-type: none"> • The IVM creates a virtual Fibre Channel adapter on the management partition and associates it with the virtual Fibre Channel adapter on the logical partition. • The IVM generates a pair of unique WWPNs and creates a virtual Fibre Channel adapter on the logical partition. The IVM assigns the WWPNs to the virtual Fibre Channel adapter on the logical partition, and associates the virtual Fibre Channel adapter on the logical partition with the virtual Fibre Channel adapter on the management partition. |
| Dynamically assign a WWPN pair to a physical port | The IVM connects the virtual Fibre Channel adapter on the management partition to the physical port on the physical Fibre Channel adapter. |

Table 6. Dynamic logical partitioning tasks and results (continued)

| Action | Result |
|--|---|
| Dynamically remove a WWPN pair from a logical partition | <ul style="list-style-type: none"> • The IVM removes the connection between the virtual Fibre Channel adapter on the management partition and the physical port on the physical Fibre Channel adapter. • The IVM removes the virtual Fibre Channel adapter from the management partition. • The IVM removes the virtual Fibre Channel adapter from the logical partition. The IVM deletes the WWPNs and does not reuse them. |
| Dynamically change the physical port assignment of a WWPN pair | <p>The IVM changes the connection for the virtual Fibre Channel adapter on the management partition to the newly assigned physical port.</p> <p>When you change the physical port to a value of None, the IVM retains the virtual Fibre Channel adapter on the management partition, but removes the connection to the physical port on the physical Fibre Channel adapter. If you later reassign a physical port to the WWPN pair, the IVM reuses the original virtual Fibre Channel adapter on the management partition and connects the adapter to the newly assigned physical port.</p> |

The following table lists the Virtual I/O Server commands that you can run to view information about the Fibre Channel adapters.

Table 7. Virtual I/O Server commands that display information about Fibre Channel adapters

| Virtual I/O Server command | Information displayed by command |
|----------------------------|--|
| lsmap | <ul style="list-style-type: none"> • Displays the virtual Fibre Channel adapters on the Virtual I/O Server that are connected to the physical Fibre Channel adapter • Displays attributes of the virtual Fibre Channel adapters on the client logical partitions that are associated with the virtual Fibre Channel adapters on the Virtual I/O Server that are connected to the physical Fibre Channel adapter |
| lsnports | <p>Displays information about the physical ports on the physical Fibre Channel adapters that support NPIV, such as:</p> <ul style="list-style-type: none"> • The name and location code of the physical port • The number of available physical ports • The total number of WWPNs that the physical port can support • Whether the switches, to which the physical Fibre Channel adapters are cabled, support NPIV |

Virtual SCSI

Using virtual Small Computer Serial Interface (SCSI), client logical partitions can share disk storage and tape or optical devices that are assigned to the Virtual I/O Server (VIOS) logical partition.

Disk, tape, or optical devices attached to physical adapters in the VIOS logical partition can be shared by one or more client logical partitions. The VIOS is a standard storage subsystem that provides standard

logical unit numbers (LUNs) that are compliant with the SCSI. The VIOS can export a pool of heterogeneous physical storage as a homogeneous pool of block storage in the form of SCSI disks. The VIOS is a localized storage subsystem. Unlike typical storage subsystems that are physically located in the SAN, the SCSI devices exported by the VIOS are limited to the domain within the server. Therefore, although the SCSI LUNs are SCSI-compliant, they might not meet the needs of all applications, particularly those that exist in a distributed environment.

The following SCSI peripheral device types are supported:

- Disk backed by logical volume
- Disk backed by physical volume
- Disk backed by file
- Optical CD-ROM, DVD-RAM, and DVD-ROM
- Optical DVD-RAM backed by file
- Tape devices

Virtual SCSI is based on a client-server relationship. The VIOS owns the physical resources and the *virtual SCSI server adapter*, and acts as a server, or SCSI target device. The client logical partitions have a SCSI initiator referred to as the *virtual SCSI client adapter*, and access the virtual SCSI targets as standard SCSI LUNs. You configure the virtual adapters by using the HMC or Integrated Virtualization Manager. The configuration and provisioning of virtual disk resources is performed by using the VIOS. Physical disks owned by the VIOS can be either exported and assigned to a client logical partition as a whole or can be partitioned into parts, such as logical volumes or files. The logical volumes and files can then be assigned to different logical partitions. Therefore, using virtual SCSI, you can share adapters and disk devices. To make a physical volume, logical volume, or file available to a client logical partition requires that it must be assigned to a virtual SCSI server adapter on the VIOS. The client logical partition accesses its assigned disks through a virtual-SCSI client adapter. The virtual-SCSI client adapter recognizes standard SCSI devices and LUNs through this virtual adapter.

On the VIOS, you can thin-provision a client virtual-SCSI device for better storage space utilization. In a thin-provisioned device, the used storage space might be greater than the actual used storage space. If the blocks of storage space in a thin-provisioned device are unused, the device is not entirely backed by physical storage space. With thin-provisioning, the storage capacity of the storage pool can be exceeded. When the storage capacity is exceeded, a threshold exceeded alert is raised. To identify that a threshold alert has occurred, check the errors listed in the VIOS system error log by running the **errlog** command in the VIOS command-line interface. To recover after the threshold has exceeded, you can add physical volumes to the storage pool. You can verify that the threshold is no longer exceeded in the VIOS system error log. For instructions on how to add physical volumes to the storage pool by using the VIOS command-line interface, see “Adding physical volumes to the storage pool” on page 120. For instructions on how to add physical volumes to the storage pool by using the VIOS configuration menu, see “Adding physical volumes to the storage pool” on page 134. You can also increase the storage capacity of the storage pool by deleting data.

On the VIOS, multiple applications running on the virtual client can manage reservations on virtual disks of the client by using the Persistent Reserves standard. These reservations persist across hard resets, logical unit resets, or initiator target nexus loss. Persistent reservations that are supported by logical devices from the VIOS shared storage pools support the required features for the SCSI-3 Persistent Reserves standard.

On the VIOS, you can thick-provision a virtual disk. In a thick-provisioned virtual disk, you can allocate or reserve storage space while initially provisioning the virtual disk. The allocated storage space for the thick-provisioned virtual disk is guaranteed. This operation ensures that there are no failures because of lack of storage space. By using thick-provisioning, initial storage in the virtual disk is faster because disk blocks might be allocated to the disk during initial provisioning of the virtual disk.

The following figure shows a standard virtual SCSI configuration.

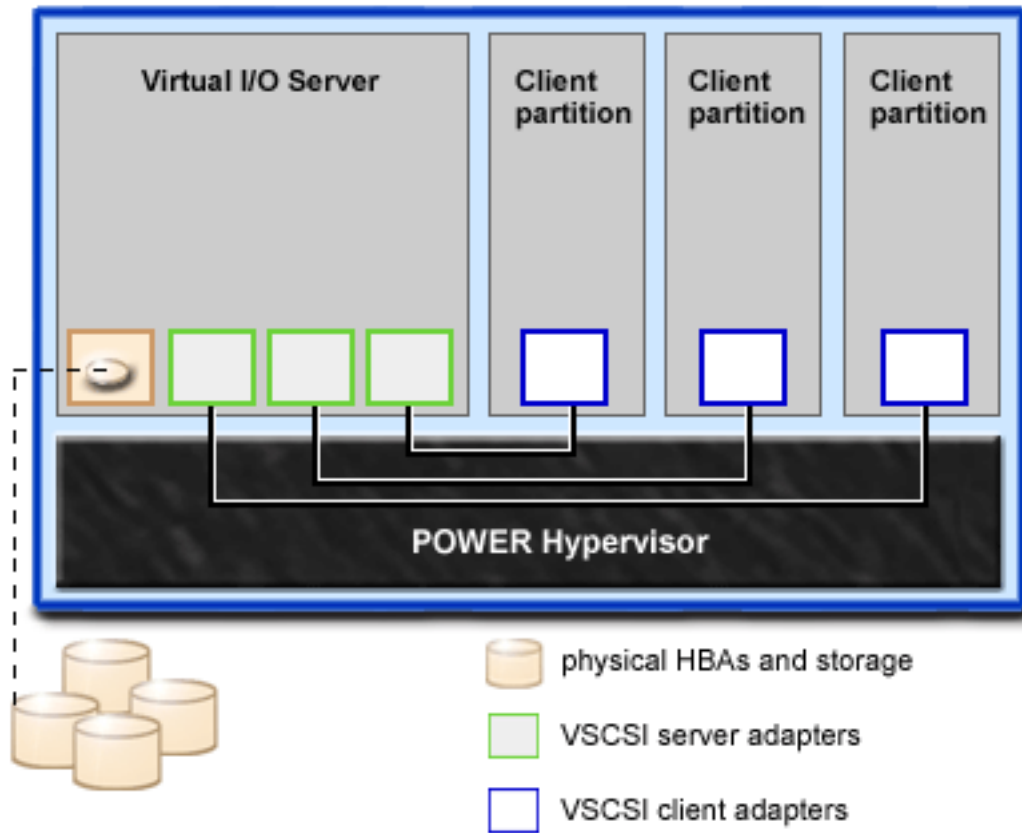

Note: The VIOS must be fully operational for the client logical partitions to be able to access virtual devices.

Related tasks:

“Adding physical volumes to the storage pool” on page 120

You can add physical volumes to the storage pool by using the Virtual I/O Server (VIOS) command-line interface.

“Adding physical volumes to the storage pool” on page 134

You can add physical volumes to the storage pool by using the Virtual I/O Server (VIOS) configuration menu.

Virtual I/O Server storage subsystem overview

Learn about the Virtual I/O Server storage subsystem.

The Virtual I/O Server storage subsystem is a standard storage subsystem that provides standard logical unit numbers (LUNs) compliant with the Small Computer Serial Interface (SCSI). The Virtual I/O Server is a localized storage subsystem. Unlike typical storage subsystems that are physically located in the SAN, the SCSI devices exported by the Virtual I/O Server are limited to the domain within the server.

Like typical disk storage subsystems, the Virtual I/O Server has a distinct front end and back end. The front end is the interface to which client logical partitions attach to view standard SCSI-compliant LUNs. Devices on the front end are called *virtual SCSI devices*. The back end is made up of physical storage resources. These physical resources include physical disk storage, both SAN devices and internal storage devices, optical devices, tape devices, logical volumes, and files.

To create a virtual device, some physical storage must be allocated and assigned to a virtual SCSI server adapter. This process creates a virtual device instance (vtscsiX or vtoptX). The device instance can be considered a mapping device. It is not a real device, but rather a mechanism for managing the mapping of the portion of physical back-end storage to the front-end virtual SCSI device. This mapping device re-creates the physical-to-virtual allocations in a persistent manner when the Virtual I/O Server is restarted.

Physical storage

Learn more about physical storage, logical volumes, and the devices and configurations that are supported by the Virtual I/O Server.

Physical volumes:

Physical volumes can be exported to client partitions as virtual Small Computer Serial Interface (SCSI) disks. The Virtual I/O Server (VIOS) is capable of taking a pool of heterogeneous physical disk storage attached to its back end and exporting this as homogeneous storage in the form of SCSI disk LUNs.

The VIOS must be able to accurately identify a physical volume each time it boots, even if an event such as a storage area network (SAN) reconfiguration or adapter change has taken place. Physical volume attributes, such as the name, address, and location, might change after the system reboots due to SAN reconfiguration. However, the VIOS must be able to recognize that this is the same device and update the virtual device mappings. Hence, to export a physical volume as a virtual device, the physical volume must have either a unique identifier (UDID), a physical identifier (PVID), or an IEEE volume attribute.

For instructions about determine whether your disks have one of these identifiers, see “Identifying exportable disks” on page 113.

The following commands are used to manage physical volumes.

Table 8. Physical volume commands and their descriptions

| Physical volume command | Description |
|-------------------------|---|
| lspv | Displays information about physical volumes within the VIOS logical partition. |
| migratepv | Moves allocated physical partitions from one physical volume to one or more other physical volumes. |

Logical volumes:

Understand how logical volumes can be exported to client partitions as virtual Small Computer Serial Interface (SCSI) disks. A logical volume is a portion of a physical volume.

A hierarchy of structures is used to manage disk storage. Each individual disk drive or LUN, called a *physical volume*, has a name, such as `/dev/hdisk0`. Every physical volume in use either belongs to a volume group or is used directly for virtual storage. All of the physical volumes in a volume group are divided into physical partitions of the same size. The number of physical partitions in each region varies, depending on the total capacity of the disk drive.

Within each volume group, one or more logical volumes are defined. Logical volumes are groups of information located on physical volumes. Data on logical volumes appears to the user to be contiguous but can be discontinuous on the physical volume. This allows logical volumes to be resized or relocated and to have their contents replicated.

Each logical volume consists of one or more logical partitions. Each logical partition corresponds to at least one physical partition. Although the logical partitions are numbered consecutively, the underlying physical partitions are not necessarily consecutive or contiguous.

After installation, the system has one volume group (the rootvg volume group) consisting of a base set of logical volumes required to start the system.

You can use the commands described in the following table to manage logical volumes.

Table 9. Logical volume commands and their descriptions

| Logical volume command | Description |
|------------------------|--|
| chlv | Changes the characteristics of a logical volume. |
| cplv | Copies the contents of a logical volume to a new logical volume. |
| extendlv | Increases the size of a logical volume. |
| lslv | Displays information about the logical volume. |
| mklv | Creates a logical volume. |
| mklvcopy | Creates a copy of a logical volume. |
| rmlv | Removes logical volumes from a volume group. |
| rmlvcopy | Removes a copy of a logical volume. |

Creating one or more distinct volume groups rather than using logical volumes that are created in the rootvg volume group allows you to install any newer versions of the Virtual I/O Server while maintaining client data by exporting and importing the volume groups created for virtual I/O.

Notes:

- Logical volumes used as virtual disks must be less than 1 TB (where TB equals 1 099 511 627 776 bytes) in size.
- For best performance, avoid using logical volumes (on the Virtual I/O Server) as virtual disks that are mirrored or striped across multiple physical volumes.

Volume groups:

Find information about volume groups.

A volume group is a type of storage pool that contains one or more physical volumes of varying sizes and types. A physical volume can belong to only one volume group per system. There can be up to 4096 active volume groups on the Virtual I/O Server.

When a physical volume is assigned to a volume group, the physical blocks of storage media on it are organized into physical partitions of a size determined by the system when you create the volume group. For more information, see “Physical partitions” on page 25.

When you install the Virtual I/O Server, the root volume group called rootvg is automatically created that contains the base set of logical volumes required to start the system logical partition. The rootvg includes paging space, the journal log, boot data, and dump storage, each in its own separate logical volume. The rootvg has attributes that differ from user-defined volume groups. For example, the rootvg cannot be imported or exported. When using a command or procedure on the rootvg, you must be familiar with its unique characteristics.

Table 10. Frequently used volume group commands and their descriptions

| Command | Description |
|---------------------|--|
| activatevg | Activates a volume group |
| chvg | Changes the attributes of a volume group |
| deactivatevg | Deactivates a volume group |

Table 10. Frequently used volume group commands and their descriptions (continued)

| Command | Description |
|-----------------|---|
| exportvg | Exports the definition of a volume group |
| extendvg | Adds a physical volume to a volume group |
| importvg | Imports a new volume group definition |
| lsvg | Displays information about a volume group |
| mkvg | Creates a volume group |
| reducevg | Removes a physical volume from a volume group |
| syncvg | Synchronizes logical volume copies that are not current |

Small systems might require only one volume group to contain all of the physical volumes (beyond the rootvg volume group). You can create separate volume groups to make maintenance easier because groups other than the one being serviced can remain active. Because the rootvg must always be online, it contains only the minimum number of physical volumes necessary for system operation. It is recommended that the rootvg not be used for client data.

You can move data from one physical volume to other physical volumes in the same volume group by using the **migratepv** command. This command allows you to free a physical volume so it can be removed from the volume group. For example, you could move data from a physical volume that is to be replaced.

Physical partitions:

This topic contains information about physical partitions.

When you add a physical volume to a volume group, the physical volume is partitioned into contiguous, equal-sized units of space called *physical partitions*. A physical partition is the smallest unit of storage space allocation and is a contiguous space on a physical volume.

Physical volumes inherit the volume group's physical partition size.

Logical partitions:

This topic contains information logical storage partitions.

When you create a logical volume, you specify its size in megabytes or gigabytes. The system allocates the number of logical partitions that are required to create a logical volume of at least the specified size. A logical partition is one or two physical partitions, depending on whether the logical volume is defined with mirroring enabled. If mirroring is disabled, there is only one copy of the logical volume (the default). In this case, there is a direct mapping of one logical partition to one physical partition. Each instance, including the first, is called a copy.

Quorums:

Find information about quorums.

A quorum exists when a majority of Volume Group Descriptor Areas and Volume Group Status Areas (VGDA/VGSA) and their disks are active. A quorum ensures data integrity of the VGDA/VGSA in the event of a disk failure. Each physical disk in a volume group has at least one VGDA/VGSA. When a volume group is created onto a single disk, the volume group initially has two VGDA/VGSA on the disk. If a volume group consists of two disks, one disk still has two VGDA/VGSA, but the other disk has one VGDA/VGSA. When the volume group is made up of three or more disks, each disk is allocated just one VGDA/VGSA.

A quorum is lost when enough disks and their VGDA/VGSA are unreachable so that a 51% majority of VGDA/VGSA no longer exists.

When a quorum is lost, the volume group deactivates itself so that the disks are no longer accessible by the logical volume manager. This prevents further disk I/O to that volume group so that data is not lost or assumed to be written when physical problems occur. As a result of the deactivation, the user is notified in the error log that a hardware error has occurred and service must be performed.

A volume group that has been deactivated because its quorum has been lost can be reactivated by using the **activatevg -f** command.

Virtual media repository:

The virtual media repository provides a single container to store and manage file-backed virtual optical media files. Media stored in the repository can be loaded into file-backed virtual optical devices for exporting to client partitions.

Only one repository can be created within a Virtual I/O Server.

The virtual media repository is available with Virtual I/O Server Version 1.5 or later.

The virtual media repository is created and managed using the following commands.

Table 11. Virtual media repository commands and their descriptions

| Command | Description |
|------------------|---|
| chrep | Changes the characteristics of the virtual media repository |
| chvopt | Changes the characteristics of a virtual optical media |
| loadopt | Loads file-backed virtual optical media into a file-backed virtual optical device |
| lsrep | Displays information about the virtual media repository |
| lsvopt | Displays information about file-backed virtual optical devices |
| mkrep | Creates the virtual media repository |
| mkvdev | Creates file-backed virtual optical devices |
| mkvopt | Creates file-backed virtual optical media |
| rmrep | Removes the virtual media repository |
| rmvopt | Removes file-backed virtual optical media |
| unloadopt | Unloads file-backed virtual optical media from a file-backed virtual optical device |

Clusters:

Learn about using the Virtual I/O Server (VIOS) and creating a clustering configuration.

On VIOS Version 2.2.0.11, Fix Pack 24, Service Pack 1, you can create a cluster that consists of only one VIOS partition that is connected to the same shared storage pool. On VIOS Version 2.2.1.3, or later, you can create a cluster that consists of up to four networked VIOS partitions. Thus, a cluster consists of up to four VIOS logical partitions with a shared storage pool that provides distributed storage access to the VIOS logical partitions in the cluster. Each cluster requires a separate repository disk and shared storage pool disks. The shared storage pool can be accessed by all VIOS logical partitions in the cluster.

All the VIOS logical partitions within a cluster must have access to all the physical volumes in a shared storage pool.

You can create and manage clusters by using the commands in the following table.

Table 12. Cluster commands and their descriptions

| Command | Description |
|----------------|---|
| cluster | Provides cluster management and listing capabilities. |

Storage pools:

Learn about logical volume storage pools and file storage pools.

In Virtual I/O Server (VIOS) Version 1.5, and later, you can create the following types of storage pools:

- Logical volume storage pools (LVPOOL)
- File storage pools (FBPOOL)

In Virtual I/O Server (VIOS) Version 2.2.0.11, Fix Pack 24, Service Pack 1, and later, you can create shared storage pools. Shared storage pools provide distributed storage access to all VIOS logical partitions in a cluster.

Like volume groups, logical volume storage pools are collections of one or more physical volumes. The physical volumes that comprise a logical volume storage pool can be of varying sizes and types. File storage pools are created within a parent logical volume storage pool and contain a logical volume containing a file system with files.

Logical volume storage pools store logical volume backing devices, file-backed storage pools, and the virtual media repository. File storage pools store file-backing devices.

By using storage pools, you are not required to have extensive knowledge of how to manage volume groups and logical volumes to create and assign logical storage to a client logical partition. Devices created by using a storage pool are not limited to the size of the individual physical volumes.

On the VIOS, you can use shared storage pools. Shared storage pools provide distributed storage access to all VIOS logical partitions in a cluster. Each cluster consists of up to four VIOS logical partitions.

Storage pools are created and managed using the following commands.

Table 13. Storage pool commands and their descriptions

| Command | Description |
|-----------------|---|
| alert | Sets, removes, and lists all the alerts for the storage pool in a cluster. |
| chsp | Changes the characteristics of a storage pool. |
| chbdsp | Changes the characteristics of a backing device within a storage pool. |
| lssp | Displays information about a storage pool. |
| mkbdsp | Assigns storage from a storage pool to be a backing device for a virtual Small Computer Serial Interface (SCSI) adapter. |
| mksp | Creates a storage pool. This storage pool is created by default when you create a cluster. |
| rmbdsp | Removes a backing device from its virtual SCSI adapter, or a VIOS object (Version 2.2.0.11, Fix Pack 24, Service Pack 1, or later), and returns the storage back to the storage pool. |
| rmsp | Removes a file storage pool. This storage pool is removed by default when you remove a cluster. |
| snapshot | Creates, deletes, and rolls back a snapshot image of a single logical unit or multiple logical units. |

In VIOS logical partitions prior to Version 2.2.0.11, Fix Pack 24, Service Pack 1, each VIOS logical partition has a single default storage pool that can be modified only by the prime administrator. By default, *rootvg*, which is a logical volume pool, is the default storage pool unless the prime administrator configures a different default storage pool.

Do not create client storage in rootvg. By creating one or more distinct logical volume storage pools rather than using the rootvg volume group, you can install any newer versions of the VIOS while maintaining client data by exporting and importing the volume groups created for virtual I/O.

Unless explicitly specified otherwise, the storage pool commands operate on the default storage pool. This situation can be useful on systems that contain most or all of its backing devices in a single storage pool.

Note: In VIOS logical partitions prior to Version 2.2.0.11, Fix Pack 24, Service Pack 1, storage pools cannot be used when you assign whole physical volumes as backing devices.

Optical devices:

Optical devices can be exported by the Virtual I/O Server. This topic gives information about what types of optical devices are supported.

The Virtual I/O Server supports exporting optical Small Computer Serial Interface (SCSI) devices. These are referred to as a *virtual SCSI optical devices*. Virtual optical devices can be backed by DVD drives or files. Depending on the backing device, the Virtual I/O Server will export a virtual optical device with one of following profiles:

- DVD-ROM
- DVD-RAM

Virtual optical devices that are backed by physical optical devices can be assigned to only one client logical partition at a time. In order to use the device on a different client logical partition, it must first be removed from its current logical partition and reassigned to the logical partition that will use the device.

Tape:

Tape devices can be exported by the Virtual I/O Server. This topic gives information about what types of tape devices are supported.

The Virtual I/O Server supports exporting physical tape devices to client logical partitions. These are referred to as *virtual Small Computer Serial Interface (SCSI) tape devices*. Virtual SCSI tape devices are backed up by physical tape devices.

Virtual SCSI tape devices are assigned to only one client logical partition at any given time. To use the device on a different client logical partition, it must first be removed from its current logical partition and reassigned to the logical partition that will use the device.

Restriction:

- The physical tape device must be attached by a serial-attached SCSI (SAS) or Universal Serial Bus (USB) tape device and both the drive types must be DAT320.
- The Virtual I/O Server does not support media movers, even if the physical device supports them.
- It is recommended that you assign the tape device to its own Virtual I/O Server adapter because as tape devices often send large amounts of data, which might affect the performance of any other device on the adapter.

Virtual storage

Disks, tapes, and optical devices are supported as virtual Small Computer Serial Interface (SCSI) devices. This topic describes how those devices function in a virtualized environment and provides information on what devices are supported.

Disk:

Disk devices can be exported by the Virtual I/O Server. This topic gives information about what types of disks and configurations are supported.

The Virtual I/O Server supports exporting disk Small Computer Serial Interface (SCSI) devices. These are referred to as *virtual SCSI disks*. All virtual SCSI disks must be backed by physical storage. The following types of physical storage can be used to back virtual disks:

- Virtual SCSI disk backed by a physical disk
- Virtual SCSI disk backed by a logical volume
- Virtual SCSI disk backed by a file

Regardless of whether the virtual SCSI disk is backed by a physical disk, logical volume, or a file, all standard SCSI rules apply to the device. The virtual SCSI device will behave as a standard SCSI-compliant disk device, and it can serve as a boot device or a Network Installation Management (NIM) target, for example.

Virtual SCSI Client Adapter Path Timeout

The virtual SCSI Client Adapter Path Timeout feature allows the client adapter to detect whether a Virtual I/O Server is not responding to I/O requests. Use this feature only in configurations in which devices are available to a client logical partition from multiple Virtual I/O Servers. These configurations could be either configurations where Multipath I/O (MPIO) is being used or where a volume group is being mirrored by devices on multiple Virtual I/O Servers.

If no I/O requests issued to the virtual SCSI server adapter have been serviced within the number of seconds specified by the virtual SCSI path timeout value, one more attempt is made to contact the virtual SCSI server adapter, waiting up to 60 seconds for a response.

If, after 60 seconds, there is still no response from the server adapter, all outstanding I/O requests to that adapter are failed and an error is written to the client logical partition error log. If MPIO is being used, the MPIO Path Control Module will retry the I/O requests down another path. Otherwise, the failed requests will be returned to the applications. If the devices on this adapter are part of a mirrored volume group, those devices will be marked as *missing* and the Logical Volume Manager logs errors in the client logical partition error log. If one of the failed devices is the root volume group (rootvg) for the logical partition, and the rootvg is not available via another path or is not being mirrored on another Virtual I/O Server, the client logical partition is likely to shut down. The virtual SCSI client adapter attempts to reestablish communication with the Virtual I/O Server and logs a message in the system error log when it is able to do so. Mirrored volume groups must be manually resynchronized by running the **varyonvg** command when the missing devices are once again available.

A configurable virtual SCSI client adapter ODM attribute, **vscsi_path_to**, is provided. This is a tunable attribute that is specific to an AIX client. The path timeouts for the Linux operating system are configured differently. This attribute is used both to indicate whether the feature is enabled and to store the value of the path timeout if the feature is enabled.

The system administrator sets the ODM attribute to 0 to disable the feature, or to the time, in seconds, to wait before checking if the path to the server adapter has failed. If the feature is enabled, a minimum setting of 30 seconds is required. If a setting between 0 and 30 seconds is entered, the value will be changed to 30 seconds upon the next adapter reconfiguration or reboot.

This feature is disabled by default, thus the default value of `vscsi_path_to` is 0. Exercise careful consideration when setting this value, keeping in mind that when the virtual SCSI server adapter is servicing the I/O request, the storage device the request is being sent to may be either local to the VIO Server or on a SAN.

The `vscsi_path_to` client adapter attribute can be set by using the SMIT utility or by using the `chdev -P` command. The attribute setting can also be viewed by using SMIT or the `lsattr` command. The setting will not take affect until the adapter is reconfigured or the client partition is rebooted.

Optical:

Optical devices can be exported by the Virtual I/O Server. This topic gives information about what types of optical devices are supported.

The Virtual I/O Server supports exporting physical optical devices to client logical partitions. These are referred to as *virtual Small Computer Serial Interface (SCSI) optical devices*. Virtual SCSI optical devices can be backed by DVD drives or files. Depending on the backing device, the Virtual I/O Server will export a virtual optical device with one of following profiles:

- DVD-ROM
- DVD-RAM

For example, file-backed virtual SCSI optical devices are exported as DVD-RAM devices. File-backed virtual SCSI optical devices can be backed by read-write or read-only files. Depending on the file permissions, the device can appear to contain a DVD-ROM or DVD-RAM disk. Read-write media files (DVD-RAM) cannot be loaded into more than one file-backed virtual SCSI optical device simultaneously. Read-only media files (DVD-ROM) can be loaded into multiple file-backed virtual SCSI optical devices simultaneously.

Virtual SCSI optical devices that are backed by physical optical devices can be assigned to only one client logical partition at any given time. To use the device on a different client logical partition, it must first be removed from its current logical partition and reassigned to the logical partition that will use the device.

Virtual SCSI optical devices will always appear as SCSI devices on the client logical partitions regardless of whether the device type exported from the Virtual I/O Server is a SCSI, IDE, USB device, or a file.

Tape:

Tape devices can be exported by the Virtual I/O Server. This topic gives information about what types of tape devices are supported.

The Virtual I/O Server supports exporting physical tape devices to client logical partitions. These are referred to as *virtual Small Computer Serial Interface (SCSI) tape devices*. Virtual SCSI tape devices are backed up by physical tape devices.

Virtual SCSI tape devices are assigned to only one client logical partition at any given time. To use the device on a different client logical partition, it must first be removed from its current logical partition and reassigned to the logical partition that will use the device.

Restriction:

- The physical tape device must be attached by a serial-attached SCSI (SAS) or Universal Serial Bus (USB) tape device and both the drive types must be DAT320.
- The Virtual I/O Server does not support media movers, even if the physical device supports them.
- It is recommended that you assign the tape device to its own Virtual I/O Server adapter because as tape devices often send large amounts of data, which might affect the performance of any other device on the adapter.

Device compatibility in a Virtual I/O Server environment:

Learn more about virtual-to-physical device compatibility in a Virtual I/O Server environment.

The virtual-to-physical device (p2v) compatibility described in this topic refers only to the data on the device, not necessarily to the capabilities of the device. A device is p2v compatible when the data retrieved from that device is identical regardless of whether it is accessed directly through a physical attachment or virtually (for example, through the Virtual I/O Server). That is, every logical block (for example, LBA 0 through LBA n-1) returns identical data for both physical and virtual devices. Device capacity must also be equal in order to claim p2v compliance. You can use the Virtual I/O Server `chkdev` command to determine if a device is p2v compatible.

Virtual disk devices exported by the Virtual I/O Server are referred to as virtual Small Computer Serial Interface (SCSI) disks. A virtual SCSI disk device may be backed by an entire physical volume, a logical volume, a multi-path device, or a file.

Data replication (such as copy services) and device movement between physical and virtual environments are common operations in today's datacenter. These operations, involving devices in a virtualized environment, often have a dependency on p2v compliance.

Copy Services refer to various solutions that provide data replication function including data migration, flashcopy, point-in-time copy, and remote mirror and copy solutions. These capabilities are commonly used for disaster recovery, cloning, backup/restore, and more.

Device movement between physical and virtual environments refers to the ability to move a disk device between physical (for example, a direct-attached SAN) and virtual I/O (for example, . Virtual I/O Server-attached SAN) environments and use the disk without having to backup or restore the data. This capability is very useful for server consolidation.

The operations above may work if the device is p2v compatible. However, not all device combinations and data replication solutions have been tested. See claims by the Copy Services vendor for support claims for devices managed by Virtual I/O Server.

A device is p2v compatible if it meets the following criteria:

- It is an entire physical volume (for example, a LUN)
- Device capacity is identical in both physical and virtual environments
- The Virtual I/O Server is able to manage this physical volume using a UDID or iEEE ID. For more information, see the Determining if a physical volume is managed by UDID or iEEE topic below.

Devices managed by the following multipathing solutions within the Virtual I/O Server are expected to be UDID devices.

- All multipath I/O (MPIO) versions, including Subsystem Device Driver Path Control Module (SDDPCM), EMC PCM, and Hitachi Dynamic Link Manager (HDLM) PCM
- EMC PowerPath 4.4.2.2 or later
- IBM® Subsystem Device Driver (SDD) 1.6.2.3 or later
- Hitachi HDLM 5.6.1 or later

Virtual SCSI devices created with earlier versions of PowerPath, HDLM, and SDD are not managed by UDID format and are not expected to be p2v compliant. The operations mentioned above (for example, data replication or movement between Virtual I/O Server and non-Virtual I/O Server environments) are not likely to work in these cases.

Related information:

 [chkdev command](#)

Determining whether a physical volume is managed by UDID or IEEE:

Determine whether a physical volume is or can be managed by a unit device identifier (UDID) or IEEE. You can use the Virtual I/O Server **chkdev** command to display this data.

Before you begin

In order to determine whether a physical volume is or can be managed by the UDID format, the following must be verified:

- If it is an existing Virtual I/O Server LUN, determine if its format is UDID.
- If it is a LUN to be moved to Virtual I/O Server, first verify that the Virtual I/O Server is prepared to see that LUN as a UDID LUN by checking it at the source host.

Note: Moving a physical disk to a Virtual I/O Server that is not capable of managing the device using UDID may result in data loss. In this case, backup the data prior to allocating the LUN to the Virtual I/O Server.

About this task

To determine whether a device has a UDID or IEEE volume attribute identifier, complete the following steps:

Procedure

1. To determine whether a device has an UDID or an IEEE volume attribute identifier for the Virtual I/O Server, type `chkdev -verbose`. Output similar to the following example is displayed:

```
NAME:                hdisk1
IDENTIFIER:          210Chp0-c4HkKbc904N37006NETAPPfcp
PHYS2VIRT_CAPABLE:  YES
VIRT2NPIV_CAPABLE:  NA
VIRT2PHYS_CAPABLE:  NA
PVID:               00c58e40599f2f900000000000000000
UDID:               2708ECVBZ1SC10IC35L146UCDY10-003IBXscsi
IEEE:
VTD:
```

```
NAME:                hdisk2
IDENTIFIER:          600A0B800012DD0D000000AB441ED6AC
PHYS2VIRT_CAPABLE:  YES
VIRT2NPIV_CAPABLE:  NA
VIRT2PHYS_CAPABLE:  NA
PVID:               00c58e40dcf83c850000000000000000
UDID:
IEEE:               600A0B800012DD0D000000AB441ED6AC
VTD:
```

If the *IEEE:* field does not appear, then the device does not have an IEEE volume attribute identifier.

2. To determine whether a device has an UDID for the AIX operating system, type `odmget -qattribute=unique_id CuAt`

The disks that have a UDID are listed. Output similar to the following example is displayed:

```
CuAt:
name = "hdisk1"
attribute = "unique_id"
value = "2708ECVBZ1SC10IC35L146UCDY10-003IBXscsi"
type = "R"
generic = ""
rep = "n1"
```

```

nls_index = 79

CuAt:
name = "hdisk2"
attribute = "unique_id"
value = "210800038FB50AST373453LC03IBXscsi"
type = "R"
generic = ""
rep = "n1"
nls_index = 79

```

- To determine whether a device has an IEEE volume attribute identifier for the AIX operating system, run the following command: `lsattr -l hdiskX`. Disks with an IEEE volume attribute identifier have a value in the `ieee_volname` field. Output similar to the following example is displayed:

```

...
cache_method    fast_write                Write Caching method
ieee_volname    600A0B800012DD0D00000AB441ED6AC IEEE Unique volume name
lun_id          0x001a000000000000      Logical Unit Number
...

```

If the `ieee_volname` field does not appear, then the device does not have an IEEE volume attribute identifier.

Note: DS4K and FAS*T*T storage that are using the Redundant Disk Array Controller (RDAC) driver for multipathing are managed using an IEEE ID.

Related information:

 [chkdev command](#)

Mapping devices

Mapping devices are used to facilitate the mapping of physical resources to a virtual device.

Virtual networking

Learn about virtual Ethernet, Host Ethernet Adapter (or Integrated Virtual Ethernet), Internet Protocol Version 6 (IPv6), Link Aggregation (or EtherChannel), Shared Ethernet Adapter, Shared Ethernet Adapter failover, and VLAN.

Virtual Ethernet technology facilitates IP-based communication between logical partitions on the same system using virtual local area network (VLAN)-capable software switch systems. Using Shared Ethernet Adapter technology, logical partitions can communicate with other systems outside the hardware unit without assigning physical Ethernet slots to the logical partitions.

Host Ethernet Adapter

A *Host Ethernet Adapter (HEA)* is a physical Ethernet adapter that is integrated directly into the GX+ bus on a managed system. HEAs offer high throughput, low latency, and virtualization support for Ethernet connections. HEAs are also known as Integrated Virtual Ethernet adapters (IVE adapters).

Unlike most other types of I/O devices, you can never assign the HEA itself to a logical partition. Instead, multiple logical partitions can connect directly to the HEA and use the HEA resources. This allows these logical partitions to access external networks through the HEA without having to go through an Ethernet bridge on another logical partition.

To connect a logical partition to an HEA, you must create a logical Host Ethernet Adapter (LHEA) for the logical partition. A *logical Host Ethernet Adapter (LHEA)* is a representation of a physical HEA on a logical partition. An LHEA appears to the operating system as if it were a physical Ethernet adapter, just as a virtual Ethernet adapter appears as if it were a physical Ethernet adapter. When you create an LHEA for a logical partition, you specify the resources that the logical partition can use on the actual physical HEA. Each logical partition can have one LHEA for each physical HEA on the managed system. Each LHEA can have one or more logical ports, and each logical port can connect to a physical port on the HEA.

You can create an LHEA for a logical partition using either of the following methods:

- You can add the LHEA to a partition profile, shut down the logical partition, and reactivate the logical partition using the partition profile with the LHEA.
- You can add the LHEA to a running logical partition using dynamic logical partitioning. This method can be used for Linux logical partitions only if you install the following operating systems on the logical partition:
 - Red Hat Enterprise Linux version 4.6, or later
 - Red Hat Enterprise Linux version 5.1, or later
 - SUSE Linux Enterprise Server Version 10, or later
 - SUSE Linux Enterprise Server Version 11, or later

When you activate a logical partition, the LHEAs in the partition profile are considered to be required resources. If the physical HEA resources required by the LHEAs are not available, then the logical partition cannot be activated. However, when the logical partition is active, you can remove any LHEAs you want from the logical partition.

After you create an LHEA for a logical partition, a network device is created in the logical partition. This network device is named `entX` on AIX logical partitions and `ethX` on Linux logical partitions, where `X` represents sequentially assigned numbers. The user can then set up TCP/IP configuration like a physical Ethernet device to communicate with other logical partitions.

You can configure a logical partition so that it is the only logical partition that can access a physical port of an HEA by specifying *promiscuous mode* for an LHEA that is assigned to the logical partition. When an LHEA is in promiscuous mode, no other logical partitions can access the logical ports of the physical port that is associated with the LHEA that is in promiscuous mode. You might want to configure a logical partition to promiscuous mode in the following situations:

- If you want to connect more than 16 logical partitions to each other and to an external network through a physical port on an HEA, you can create a logical port on a Virtual I/O Server logical partition and configure an Ethernet bridge between the logical port and a virtual Ethernet adapter on a virtual LAN. This allows all logical partitions with virtual Ethernet adapters on the virtual LAN to communicate with the physical port through the Ethernet bridge. If you configure an Ethernet bridge between a logical port and a virtual Ethernet adapter, the physical port that is connected to the logical port must have the following properties:
 - The physical port must be configured so that the Virtual I/O Server logical partition is the promiscuous mode logical partition for the physical port.
 - The physical port can have only one logical port.
- You want the logical partition to have dedicated access to a physical port.
- You want to use tools such as `tcpdump` or `iptrace`.

A logical port can communicate with all other logical ports that are connected to the same physical port on the HEA. The physical port and its associated logical ports form a logical Ethernet network. Broadcast and multicast packets are distributed on this logical network as though it was a physical Ethernet network. You can connect up to 16 logical ports to a physical port using this logical network. By extension, you can connect up to 16 logical partitions to each other and to an external network through this logical network. The actual number of logical ports that you can connect to a physical port depends upon the Multi-Core Scaling value of the physical port group. It also depends on the number of logical ports that have been created for other physical ports within the physical port group. By default, the Multi-Core Scaling value of each physical port group is set to 4, which allows four logical ports to be connected to the physical ports in the physical port group. To allow up to 16 logical ports to be connected to the physical ports in the physical port group, you must change the Multi-Core Scaling value of the physical port group to 1 and restart the managed system.

You can set each logical port to restrict or allow packets that are tagged for specific VLANs. You can set a logical port to accept packets with any VLAN ID, or you can set a logical port to accept only the VLAN IDs that you specify. You can specify up to 20 individual VLAN IDs for each logical port.

The physical ports on an HEA are always configured on the managed system level. If you use an HMC to manage a system, you must use the HMC to configure the physical ports on any HEAs belonging to the managed system. Also, the physical port configuration applies to all logical partitions that use the physical port. (Some properties might require setup in the operating system as well. For example, the maximum packet size for a physical port on the HEA must be set on the managed system level using the HMC. However, you must also set the maximum packet size for each logical port within the operating system.) By contrast, if a system is unpartitioned and is not managed by an HMC, you can configure the physical ports on an HEA within the operating system as if the physical ports were ports on a regular physical Ethernet adapter.

HEA hardware does not support half duplex mode.

You can change the properties of a logical port on an LHEA by using dynamic logical partitioning to remove the logical port from the logical partition. You can also add the logical port back to the logical partition using the changed properties. If the operating system of the logical partition does not support dynamic logical partitioning for LHEAs, and you want to change any logical port property other than the VLANs on which the logical port participates, you must set a partition profile for the logical partition so that the partition profile contains the wanted logical port properties, shut down the logical partition, and activate the logical partition using the new or changed partition profile. If the operating system of the logical partition does not support dynamic logical partitioning for LHEAs, and you want to change the VLANs on which the logical port participates, you must remove the logical port from a partition profile belonging to the logical partition, shut down and activate the logical partition using the changed partition profile, add the logical port back to the partition profile using the changed VLAN configuration, and shut down and activate the logical partition again using the changed partition profile.

Internet Protocol version 6

Internet Protocol version 6 (IPv6) is the next generation of Internet Protocol and is gradually replacing the current Internet standard, Internet Protocol version 4 (IPv4). The key IPv6 enhancement is the expansion of the IP address space from 32 bits to 128 bits, providing virtually unlimited, unique IP addresses.

IPv6 provides several advantages over IPv4, including expanded routing and addressing, routing simplification, header format simplification, improved traffic control, autoconfiguration, and security.

For more information about IPv6, see Internet Protocol (IP) version 6.

Note: For more information about IPv6 on the Linux operating system, see the documentation for the Linux operating system.

Link Aggregation or EtherChannel devices

A Link Aggregation, or EtherChannel, device is a network port-aggregation technology that allows several Ethernet adapters to be aggregated. The adapters can then act as a single Ethernet device. Link Aggregation helps provide more throughput over a single IP address than would be possible with a single Ethernet adapter.

For example, `ent0` and `ent1` can be aggregated to `ent3`. The system considers these aggregated adapters as one adapter, and all adapters in the Link Aggregation device are given the same hardware address, so they are treated by remote systems as if they are one adapter.

Link Aggregation can help provide more redundancy because individual links might fail, and the Link Aggregation device will fail over to another adapter in the device to maintain connectivity. For example,

in the previous example, if `ent0` fails, the packets are automatically sent on the next available adapter, `ent1`, without disruption to existing user connections. `ent0` automatically returns to service on the Link Aggregation device when it recovers.

You can configure a Shared Ethernet Adapter to use a Link Aggregation, or EtherChannel, device as the physical adapter.

Virtual Ethernet adapters

Virtual Ethernet adapters allow client logical partitions to send and receive network traffic without having a physical Ethernet adapter.

Virtual Ethernet adapters allow logical partitions within the same system to communicate without having to use physical Ethernet adapters. Within the system, virtual Ethernet adapters are connected to an IEEE 802.1q virtual Ethernet switch. Using this switch function, logical partitions can communicate with each other by using virtual Ethernet adapters and assigning VIDs. With VIDs, virtual Ethernet adapters can share a common logical network. The system transmits packets by copying the packet directly from the memory of the sender logical partition to the receive buffers of the receiver logical partition without any intermediate buffering of the packet.

Virtual Ethernet adapters can be used without using the Virtual I/O Server, but the logical partitions will not be able to communicate with external systems. However, in this situation, you can use another device, called a Host Ethernet Adapter (or Integrated Virtual Ethernet), to facilitate communication between logical partitions on the system and external networks.

You can create virtual Ethernet adapters using the Hardware Management Console (HMC) and configure them using the Virtual I/O Server command-line interface. You can also use the Integrated Virtualization Manager to create and manage virtual Ethernet adapters. With the Virtual I/O Server Version 2.2, or later, you can add, remove, or modify the existing set of VLANs for a virtual Ethernet adapter that is assigned to an active partition on a POWER7 processor-based server by using the HMC. The server firmware level must be at least AH720_064+ for high end servers, AM720_064+ for midrange servers, and AL720_064+ for low end servers. The HMC must be at Version 7.7.2.0, with mandatory efex MH01235, or later, to perform this task.

Note: The AL720_064+ server firmware level is only supported on POWER7 processor-based servers, or later.

Consider using virtual Ethernet on the Virtual I/O Server in the following situations:

- When the capacity or the bandwidth requirement of the individual logical partition is inconsistent with, or is less than, the total bandwidth of a physical Ethernet adapter. Logical partitions that use the full bandwidth or capacity of a physical Ethernet adapter should use dedicated Ethernet adapters.
- When you need an Ethernet connection, but there is no slot available in which to install a dedicated adapter.

Virtual local area networks

Virtual local area networks (VLAN) allows the physical network to be logically segmented.

VLAN is a method to logically segment a physical network so that layer 2 connectivity is restricted to members that belong to the same VLAN. This separation is achieved by tagging Ethernet packets with their VLAN membership information and then restricting delivery to members of that VLAN. VLAN is described by the IEEE 802.1Q standard.

The VLAN tag information is referred to as VLAN ID (VID). Ports on a switch are configured as being members of a VLAN designated by the VID for that port. The default VID for a port is referred to as the Port VID (PVID). The VID can be added to an Ethernet packet either by a VLAN-aware host, or by the switch in the case of VLAN-unaware hosts. Ports on an Ethernet switch must therefore be configured with information indicating whether the host connected is VLAN-aware.

For VLAN-unaware hosts, a port is set up as untagged and the switch will tag all packets entering through that port with the Port VLAN ID (PVID). It will also untag all packets exiting that port before delivery to the VLAN unaware host. A port used to connect VLAN-unaware hosts is called an *untagged port*, and it can be a member of only a single VLAN identified by its PVID. Hosts that are VLAN-aware can insert and remove their own tags and can be members of more than one VLAN. These hosts are typically attached to ports that do not remove the tags before delivering the packets to the host, but will insert the PVID tag when an untagged packet enters the port. A port will only allow packets that are untagged or tagged with the tag of one of the VLANs that the port belongs to. These VLAN rules are in addition to the regular media access control (MAC) address-based forwarding rules followed by a switch. Therefore, a packet with a broadcast or multicast destination MAC is also delivered to member ports that belong to the VLAN that is identified by the tags in the packet. This mechanism ensures the logical separation of the physical network based on membership in a VLAN.

Shared Ethernet Adapters

With Shared Ethernet Adapters on the Virtual I/O Server logical partition, virtual Ethernet adapters on client logical partitions can send and receive outside network traffic.

A Shared Ethernet Adapter is a Virtual I/O Server component that bridges a physical Ethernet adapter and one or more virtual Ethernet adapters:

- The real adapter can be a physical Ethernet adapter, a Link Aggregation or EtherChannel device, or a Logical Host Ethernet Adapter . The real adapter cannot be another Shared Ethernet Adapter or a VLAN pseudo-device.
- The virtual Ethernet adapter must be a virtual I/O Ethernet adapter. It cannot be any other type of device or adapter.

Using a Shared Ethernet Adapter, logical partitions on the virtual network can share access to the physical network and communicate with stand-alone servers and logical partitions on other systems. The Shared Ethernet Adapter eliminates the need for each client logical partition to a dedicated physical adapter to connect to the external network.

A Shared Ethernet Adapter provides access by connecting the internal VLANs with the VLANs on the external switches. Using this connection, logical partitions can share the IP subnet with stand-alone systems and other external logical partitions. The Shared Ethernet Adapter forwards outbound packets received from a virtual Ethernet adapter to the external network and forwards inbound packets to the appropriate client logical partition over the virtual Ethernet link to that logical partition. The Shared Ethernet Adapter processes packets at layer 2, so the original MAC address and VLAN tags of the packet are visible to other systems on the physical network.

The Shared Ethernet Adapter has a bandwidth apportioning feature, also known as Virtual I/O Server quality of service (QoS). QoS allows the Virtual I/O Server to give a higher priority to some types of packets. In accordance with the IEEE 801.q specification, Virtual I/O Server administrators can instruct the Shared Ethernet Adapter to inspect bridged VLAN-tagged traffic for the VLAN priority field in the VLAN header. The 3-bit VLAN priority field allows each individual packet to be prioritized with a value from 0 to 7 to distinguish more important traffic from less important traffic. More important traffic is sent preferentially and uses more Virtual I/O Server bandwidth than less important traffic.

Note: When using the trunk of the Virtual Ethernet Adapter on an HMC, only traffic on VLANs with specified VLAN IDs is delivered to the Virtual I/O Server with a VLAN tag. Consequently, to use this feature, the adapter must be configured with additional VLAN IDs when the trunk of the Virtual Ethernet Adapter is configured. Untagged traffic is always treated as though it belonged to the default priority class, that is, as if it had a priority value of 0.

Depending on the VLAN priority values found in the VLAN headers, packets are prioritized as follows.

Table 14. VLAN traffic priority values and relative importance

| Priority value and importance |
|-------------------------------|
| 1 (Least important) |
| 2 |
| 0 (Default) |
| 3 |
| 4 |
| 5 |
| 6 |
| 7 (Most important) |

The Virtual I/O Server administrator can use QoS by setting the Shared Ethernet Adapter `qos_mode` attribute to either strict or loose mode. The default is disabled mode. The following definitions describe these modes:

disabled mode

This is the default mode. VLAN traffic is not inspected for the priority field. An example follows:

```
chdev -dev <SEA device name> -attr qos_mode=disabled
```

strict mode

More important traffic is sent preferentially over less important traffic. This mode provides better performance and more bandwidth to more important traffic; however, it can result in substantial delays for less important traffic. An example follows:

```
chdev -dev <SEA device name> -attr qos_mode=strict
```

loose mode

A cap is placed on each priority level so that after a number of bytes is sent for each priority level, the following level is serviced. This method ensures that all packets are eventually sent. More important traffic is given less bandwidth with this mode than with strict mode; however, the caps in loose mode are such that more bytes are sent for the more important traffic, so it still gets more bandwidth than less important traffic. An example follows:

```
chdev -dev <SEA device name> -attr qos_mode=loose
```

Note: In either strict or loose mode, because the Shared Ethernet Adapter uses several threads to bridge traffic, it is still possible for less important traffic from one thread to be sent before more important traffic of another thread.

GARP VLAN Registration Protocol

Shared Ethernet Adapters, in Virtual I/O Server Version 1.4 or later, support GARP VLAN Registration Protocol (GVRP), which is based on Generic Attribute Registration Protocol (GARP). GVRP allows for the dynamic registration of VLANs over networks, which can reduce the number of errors in the configuration of a large network. By propagating registration across the network through the transmission of Bridge Protocol Data Units (BPDUs), devices on the network have accurate knowledge of the bridged VLANs configured on the network.

When GVRP is enabled, communication travels one way, from the Shared Ethernet Adapter to the switch. The Shared Ethernet Adapter notifies the switch which VLANs can communicate with the network. The Shared Ethernet Adapter does not configure VLANs to communicate with the network based on information received from the switch. Rather, the configuration of VLANs that communicate with the network is statically determined by the virtual Ethernet adapter configuration settings.

Host Ethernet Adapter or Integrated Virtual Ethernet

A logical Host Ethernet Adapter (LHEA), which is sometimes referred to as Integrated Virtual Ethernet, is a physical adapter that you can use to configure virtual Ethernet. With Virtual I/O Server Version 1.4, or

later, you can assign a logical host Ethernet port of an LHEA, as the real adapter of a Shared Ethernet Adapter. The logical host Ethernet port is associated with a physical port on the Host Ethernet Adapter. The Shared Ethernet Adapter uses the standard device driver interfaces provided by the Virtual I/O Server to communicate with the Host Ethernet Adapter.

To use a Shared Ethernet Adapter with a Host Ethernet Adapter, the following requirements must be met:

- The logical host Ethernet port must be the only port assigned to the physical port on the Host Ethernet Adapter. No other ports of the LHEA can be assigned to the physical port on the Host Ethernet Adapter.
- The LHEA on the Virtual I/O Server logical partition must be set to promiscuous mode. (In an Integrated Virtualization Manager environment, the mode is set to promiscuous by default.) *Promiscuous mode* allows the LHEA (on the Virtual I/O Server) to receive all unicast, multicast, and broadcast network traffic from the physical network.

Recommendations

Consider using Shared Ethernet Adapters on the Virtual I/O Server in the following situations:

- When the capacity or the bandwidth requirement of the individual logical partition is inconsistent or is less than the total bandwidth of a physical Ethernet adapter. Logical partitions that use the full bandwidth or capacity of a physical Ethernet adapter should use dedicated Ethernet adapters.
- If you plan to migrate a client logical partition from one system to another.

Consider assigning a Shared Ethernet Adapter to a Logical Host Ethernet port when the number of Ethernet adapters that you need is more than the number of ports available on the LHEA, or you anticipate that your needs will grow beyond that number. If the number of Ethernet adapters that you need is fewer than or equal to the number of ports available on the LHEA, and you do not anticipate needing more ports in the future, you can use the ports of the LHEA for network connectivity rather than the Shared Ethernet Adapter.

Shared memory

Shared memory is physical memory that is assigned to the shared memory pool and shared among multiple logical partitions. The *shared memory pool* is a defined collection of physical memory blocks that are managed as a single memory pool by the hypervisor. Logical partitions that you configure to use shared memory (hereafter referred to as *shared memory partitions*) share the memory in the pool with other shared memory partitions.

For example, you create a shared memory pool with 16 GB of physical memory. You then create three logical partitions, configure them to use shared memory, and activate the shared memory partitions. Each shared memory partition can use the 16 GB that are in the shared memory pool.

The hypervisor determines the amount of memory allocated from the shared memory pool to each shared memory partition based on the workload and memory configuration of each shared memory partition. When allocating the physical memory to the shared memory partitions, the hypervisor ensures that each shared memory partition can access only the memory allocated to the shared memory partition at any given time. A shared memory partition cannot access the physical memory allocated to another shared memory partition.

The amount of memory that you assign to the shared memory partitions can be greater than the amount of memory in the shared memory pool. For example, you can assign 12 GB to shared memory partition 1, 8 GB to shared memory partition 2, and 4 GB to shared memory partition 3. Together, the shared memory partitions use 24 GB of memory, but the shared memory pool has only 16 GB of memory. In this situation, the memory configuration is considered overcommitted.

Overcommitted memory configurations are possible because the hypervisor virtualizes and manages all of the memory for the shared memory partitions in the shared memory pool as follows:

1. When shared memory partitions are not actively using their memory pages, the hypervisor allocates those unused memory pages to shared memory partitions that currently need them. When the sum of the physical memory currently used by the shared memory partitions is less than or equal to the amount of memory in the shared memory pool, the memory configuration is *logically overcommitted*. In a logically overcommitted memory configuration, the shared memory pool has enough physical memory to contain the memory used by all shared memory partitions at one point in time. The hypervisor does not need to store any data in auxiliary storage.
2. When a shared memory partition requires more memory than the hypervisor can provide to it by allocating unused portions of the shared memory pool, the hypervisor stores some of the memory that belongs to a shared memory partition in the shared memory pool and stores the remainder of the memory that belongs to the shared memory partition in auxiliary storage. When the sum of the physical memory currently used by the shared memory partitions is greater than the amount of memory in the shared memory pool, the memory configuration is *physically overcommitted*. In a physically overcommitted memory configuration, the shared memory pool does not have enough physical memory to contain the memory used by all the shared memory partitions at one point in time. The hypervisor stores the difference in auxiliary storage. When the operating system attempts to access the data, the hypervisor might need to retrieve the data from auxiliary storage before the operating system can access it.

Because the memory that you assign to a shared memory partition might not always reside in the shared memory pool, the memory that you assign to a shared memory partition is *logical memory*. Logical memory is the address space, assigned to a logical partition, that the operating system perceives as its main storage. For a shared memory partition, a subset of the logical memory is backed up by physical main storage (or physical memory from the shared memory pool) and the remaining logical memory is kept in auxiliary storage.

A Virtual I/O Server logical partition provides access to the auxiliary storage, or paging space devices, required for shared memory partitions in an overcommitted memory configuration. A *paging space device* is a physical or logical device that is used by a Virtual I/O Server to provide the paging space for a shared memory partition. The *paging space* is an area of nonvolatile storage used to hold portions of a shared memory partition's logical memory that do not reside in the shared memory pool. When the operating system that runs in a shared memory partition attempts to access data, and the data is located in the paging space device that is assigned to the shared memory partition, the hypervisor sends a request to a Virtual I/O Server to retrieve the data and write it to the shared memory pool so that the operating system can access it.

On systems that are managed by a Hardware Management Console (HMC), you can assign up to two Virtual I/O Server (VIOS) logical partitions to the shared memory pool at a time (hereafter referred to as *paging VIOS partitions*). When you assign two paging VIOS partitions to the shared memory pool, you can configure the paging space devices such that both paging VIOS partitions have access to the same paging space devices. When one paging VIOS partition becomes unavailable, the hypervisor sends a request to the other paging VIOS partition to retrieve the data on the paging space device.

You cannot configure paging VIOS partitions to use shared memory. Paging VIOS partitions do not use the memory in the shared memory pool. You assign paging VIOS partitions to the shared memory pool so that they can provide access to the paging space devices for the shared memory partitions that are assigned to the shared memory pool.

Driven by workload demands from the shared memory partitions, the hypervisor manages overcommitted memory configurations by continually performing the following tasks:

- Allocating portions of physical memory from the shared memory pool to the shared memory partitions as needed

- Requesting a paging VIOS partition to read and write data between the shared memory pool and the paging space devices as needed

The ability to share memory among multiple logical partitions is known as the PowerVM Active Memory Sharing technology. The PowerVM Active Memory Sharing technology is available with the PowerVM Enterprise Edition for which you must obtain and enter a PowerVM Editions activation code.

Related reference:

“Configuration requirements for shared memory” on page 78

Review the requirements for the system, Virtual I/O Server (VIOS), logical partitions, and paging space devices so that you can successfully configure shared memory.

Related information:

 [Paging space device](#)

Paging VIOS partition

A Virtual I/O Server (VIOS) logical partition that is assigned to the shared memory pool (hereafter referred to as a *paging VIOS partition*) provides access to the paging space devices for the logical partitions that are assigned to the shared memory pool (hereafter referred to as *shared memory partitions*).

When the operating system that runs in a shared memory partition attempts to access data, and the data is located in the paging space device that is assigned to the shared memory partition, the hypervisor sends a request to a paging VIOS partition to retrieve the data and write it to the shared memory pool so that the operating system can access it.

A paging VIOS partition is not a shared memory partition and does not use the memory in the shared memory pool. A paging VIOS partition provides access to the paging space devices for the shared memory partitions.

Integrated Virtualization Manager

On systems that are managed by the Integrated Virtualization Manager, the management partition is the paging VIOS partition for the shared memory partitions that are assigned to the shared memory pool. When you create the shared memory pool, you assign a paging storage pool to the shared memory pool. The paging storage pool provides the paging space devices for the shared memory partitions that are assigned to the shared memory pool.

HMC

On systems that are managed by a Hardware Management Console (HMC), you can assign one or two paging VIOS partitions to the shared memory pool. When you assign a single paging VIOS partition to the shared memory pool, the paging VIOS partition provides access to all of the paging space devices for the shared memory partitions. The paging space devices can be located in physical storage in the server or on a storage area network (SAN). When you assign two paging VIOS partitions to the shared memory pool, you can configure each paging VIOS partition to access paging space devices in one of the following ways:

- You can configure each paging VIOS partition to access independent paging space devices. Paging space devices that are accessed by only one paging VIOS partition, or independent paging space devices, can be located in physical storage in the server or on a SAN.
- You can configure both paging VIOS partitions to access the same, or common, paging space devices. In this configuration, the paging VIOS partitions provide redundant access to paging space devices. When one paging VIOS partition becomes unavailable, the hypervisor sends a request to the other paging VIOS partition to retrieve the data on the paging space device. Common paging space devices must be located on a SAN to enable symmetrical access from both paging VIOS partitions.

- You can configure each paging VIOS partition to access some independent paging space devices and some common paging space devices.

If you configure the shared memory pool with two paging VIOS partitions, you can configure a shared memory partition to use either a single paging VIOS partition or redundant paging VIOS partitions. When you configure a shared memory partition to use redundant paging VIOS partitions, you assign a primary paging VIOS partition and a secondary paging VIOS partition to the shared memory partition. The hypervisor uses the primary paging VIOS partition to access the shared memory partition's paging space device. At this point, the primary paging VIOS partition is the current paging VIOS partition for the shared memory partition. The current paging VIOS partition is the paging VIOS partition that the hypervisor uses at any point in time to access data in the paging space device that is assigned to the shared memory partition. If the primary paging VIOS partition becomes unavailable, the hypervisor uses the secondary paging VIOS partition to access the shared memory partition's paging space device. At this point, the secondary paging VIOS partition becomes the current paging VIOS partition for the shared memory partition and continues as the current paging VIOS partition even after the primary paging VIOS partition becomes available again.

You do not need to assign the same primary and secondary paging VIOS partitions to all of the shared memory partitions. For example, you assign paging VIOS partition A and paging VIOS partition B to the shared memory pool. For one shared memory partition, you can assign paging VIOS partition A as the primary paging VIOS partition and paging VIOS partition B as the secondary paging VIOS partition. For a different shared memory partition, you can assign paging VIOS partition B as the primary paging VIOS partition and paging VIOS partition A as the secondary paging VIOS partition.

The following figure shows an example of a system with four shared memory partitions, two paging VIOS partitions, and four paging space devices.

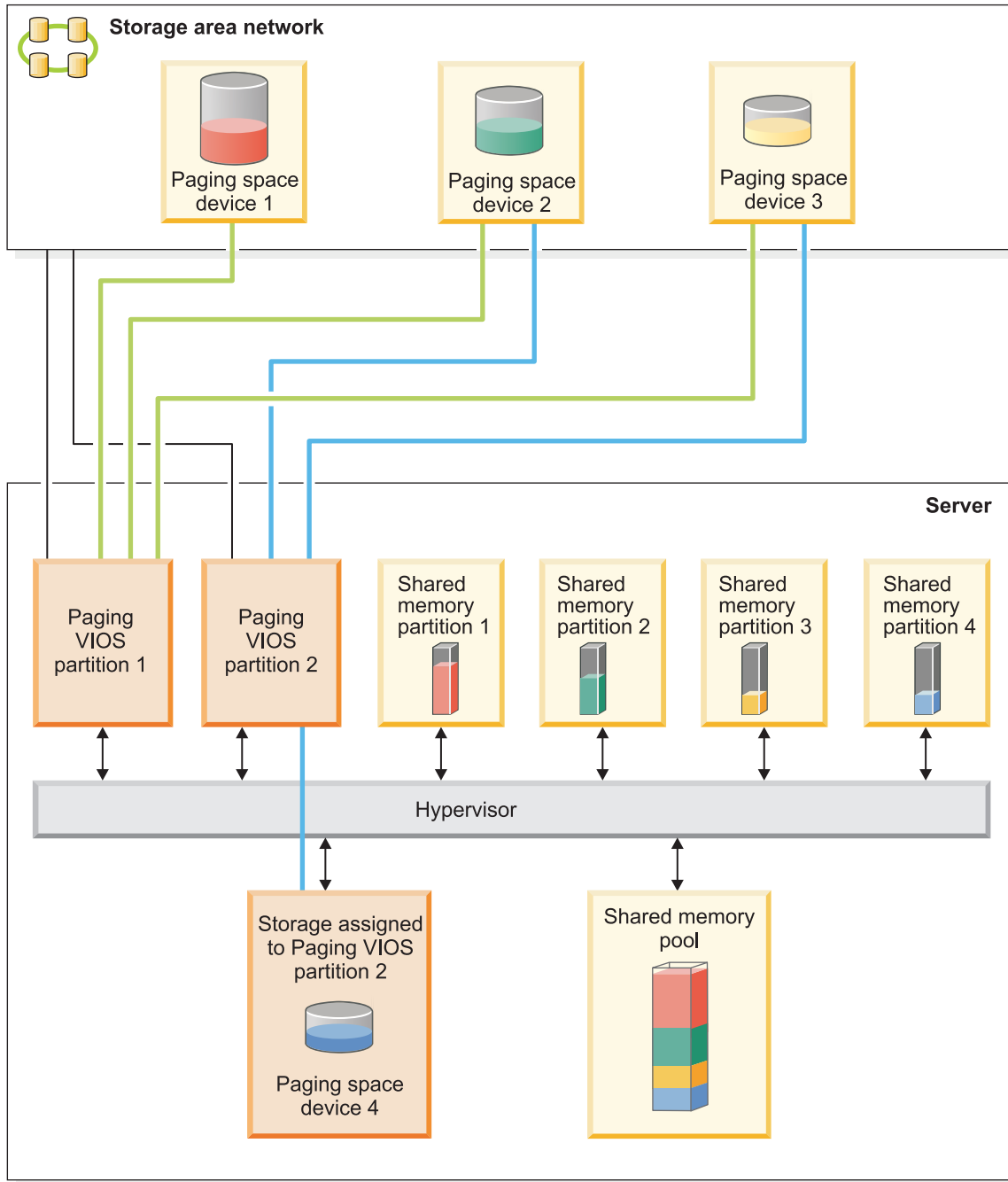

The example shows the configuration options for paging VIOS partitions and paging space devices as described in the following table.

Table 15. Examples of paging VIOS partition configurations

| Configuration option | Example |
|--|---|
| <p>The paging space device that is assigned to a shared memory partition is located in physical storage in the server and is accessed by a single paging VIOS partition.</p> | <p>Paging space device 4 provides the paging space for Shared memory partition 4. Shared memory partition 4 is assigned to use Paging VIOS partition 2 to access Paging space device 4. Paging space device 4 is located in physical storage in the server and is assigned to Paging VIOS partition 2. Paging VIOS partition 2 is the only paging VIOS partition that can access Paging space device 4 (This relationship is shown by the blue line that connects Paging VIOS partition 2 to Paging space device 4.).</p> |
| <p>The paging space device that is assigned to a shared memory partition is located on a SAN and is accessed by a single paging VIOS partition.</p> | <p>Paging space device 1 provides the paging space for Shared memory partition 1. Shared memory partition 1 is assigned to use Paging VIOS partition 1 to access Paging space device 1. Paging space device 1 is connected to the SAN. Paging VIOS partition 1 is also connected to the SAN and is the only paging VIOS partition that can access Paging space device 1 (This relationship is shown by the green line that connects Paging VIOS partition 1 to Paging space device 1.).</p> |

Table 15. Examples of paging VIOS partition configurations (continued)

| Configuration option | Example |
|---|---|
| <p>The paging space device that is assigned to a shared memory partition is located on a SAN and is accessed redundantly by two paging VIOS partitions.</p> | <p>Paging space device 2 provides the paging space for Shared memory partition 2. Paging space device 2 is connected to the SAN. Paging VIOS partition 1 and Paging VIOS partition 2 are also connected to the SAN and can both access Paging space device 2. (These relationships are shown by the green line that connects Paging VIOS partition 1 to Paging space device 2 and the blue line that connects Paging VIOS partition 2 to Paging space device 2.) Shared memory partition 2 is assigned to use redundant paging VIOS partitions to access Paging space device 2. Paging VIOS partition 1 is configured as the primary paging VIOS partition and Paging VIOS partition 2 is configured as the secondary paging VIOS partition.</p> <p>Similarly, Paging space device 3 provides the paging space for Shared memory partition 3. Paging space device 3 is connected to the SAN. Paging VIOS partition 1 and Paging VIOS partition 2 are also connected to the SAN and can both access Paging space device 3. (These relationships are shown by the green line that connects Paging VIOS partition 1 to Paging space device 3 and the blue line that connects Paging VIOS partition 2 to Paging space device 3.) Shared memory partition 3 is assigned to use redundant paging VIOS partitions to access Paging space device 3. Paging VIOS partition 2 is configured as the primary paging VIOS partition and Paging VIOS partition 1 is configured as the secondary paging VIOS partition.</p> <p>Because Paging VIOS partition 1 and Paging VIOS partition 2 both have access to Paging space device 2 and Paging space device 3, Paging space device 2 and Paging space device 3 are common paging space devices that are accessed redundantly by Paging VIOS partition 1 and Paging VIOS partition 2. If Paging VIOS partition 1 becomes unavailable and Shared memory partition 2 needs to access data on its paging space device, the hypervisor sends a request to Paging VIOS partition 2 to retrieve the data on Paging space device 2. Similarly, if Paging VIOS partition 2 becomes unavailable and Shared memory partition 3 needs to access the data on its paging space device, the hypervisor sends a request to Paging VIOS partition 1 to retrieve the data on Paging space device 3.</p> |

Table 15. Examples of paging VIOS partition configurations (continued)

| Configuration option | Example |
|---|---|
| <p>A paging VIOS partition accesses both independent and common paging space devices.</p> | <p>Paging space device 1 and Paging space device 4 are independent paging space devices because only one paging VIOS partition accesses each. Paging VIOS partition 1 accesses Paging space device 1, and Paging VIOS partition 2 accesses Paging space device 4. Paging space device 2 and paging space device 3 are common paging space devices because both paging VIOS partitions access each. (These relationships are shown by the green and blue lines that connect the paging VIOS partitions to the paging space devices.)</p> <p>Paging VIOS partition 1 accesses the independent paging space device Paging space device 1, and also accesses the common paging space devices Paging space device 2 and Paging space device 3. Paging VIOS partition 2 accesses the independent paging space device Paging space device 4 and also accesses the common paging space devices Paging space device 2 and Paging space device 3.</p> |

When a single paging VIOS partition is assigned to the shared memory pool, you must shut down the shared memory partitions before you shut down the paging VIOS partition so that the shared memory partitions are not suspended when they attempt to access their paging space devices. When two paging VIOS partitions are assigned to the shared memory pool and the shared memory partitions are configured to use redundant paging VIOS partitions, you do not need to shut down the shared memory partitions to shut down a paging VIOS partition. When one paging VIOS partition is shut down, the shared memory partitions use the other paging VIOS partition to access their paging space devices. For example, you can shut down a paging VIOS partition and install VIOS updates without shutting down the shared memory partitions.

You can configure multiple VIOS logical partitions to provide access to paging space devices. However, you can only assign up to two of those VIOS partitions to the shared memory pool at any given time.

After you configure the shared memory partitions, you can later change the redundancy configuration of the paging VIOS partitions for a shared memory partition by modifying the partition profile of the shared memory partition and restarting the shared memory partition with the modified partition profile:

- You can change which paging VIOS partitions are assigned to a shared memory partition as the primary and secondary paging VIOS partitions.
- You can change the number of paging VIOS partitions that are assigned to a shared memory partition.

Virtual I/O Server management

Learn about management tools for the Virtual I/O Server, such as the Virtual I/O Server command-line interface, and several Tivoli® products that can manage different aspects of the Virtual I/O Server.

For systems that are not managed by a Hardware Management Console (HMC), the Virtual I/O Server becomes the management partition and provides a graphical user interface, called the Integrated Virtualization Manager, to help you manage the system. For more information, see Integrated Virtualization Manager.

Virtual I/O Server command-line interface

Learn about accessing and using the Virtual I/O Server command-line interface.

The Virtual I/O Server is configured and managed through a command-line interface. In environments where HMC is not present, you can also perform some Virtual I/O Server tasks using the Integrated Virtualization Manager. All aspects of Virtual I/O Server administration can be accomplished through the command-line interface, including the following:

- Device management (physical, virtual, logical volume manager (LVM))
- Network configuration
- Software installation and update
- Security
- User management
- Maintenance tasks

In addition, in environments managed by the Integrated Virtualization Manager, you can use the Virtual I/O Server command-line interface to manage logical partitions.

The first time you log in to the Virtual I/O Server, use the **padmin** user ID, which is the prime administrator user ID. You will be prompted for a new password.

Restricted shell

After logging in, you will be placed into a restricted Korn shell. The restricted Korn shell works in the same way as a standard Korn shell, except that you cannot perform the following:

- Change the current working directory
- Set the value of the **SHELL**, **ENV**, or **PATH** variables
- Specify the path name of the command that contains a forward slash (/)
- Redirect output of a command using any of the following characters: >, >|, <>, >>

As a result of these restrictions, you cannot execute commands that are not accessible to your **PATH** variables. In addition, these restrictions prevent you from sending command output directly to a file. Instead, command output can be piped to the **tee** command.

After you log in, you can type **help** to get information about the supported commands. For example, to get help on the **errlog** command, type **help errlog**.

Execution mode

The Virtual I/O Server command-line interface functions similarly to a standard command-line interface. Commands are issued with appropriate accompanying flags and parameters. For example, to list all adapters, type the following:

```
lsdev -type adapter
```

In addition, scripts can be run within the Virtual I/O Server command-line interface environment.

In addition to the Virtual I/O Server command-line interface commands, the following standard shell commands are provided.

Table 16. Standard shell commands and their functions

| Command | Function |
|--------------|--|
| awk | Matches patterns and performs actions on them. |
| cat | Concatenates or displays files. |
| chmod | Changes file modes. |
| cp | Copies files. |

Table 16. Standard shell commands and their functions (continued)

| Command | Function |
|--------------|---|
| date | Displays the date and time. |
| grep | Searches a file for a pattern. |
| ls | Displays the contents of a directory. |
| mkdir | Makes a directory. |
| man | Displays manual entries for the Virtual I/O Server commands. |
| more | Displays the contents of files one screen at a time. |
| rm | Removes files. |
| sed | Provides a stream editor. |
| stty | Sets, resets, and reports workstation operating parameters. |
| tee | Displays the output of a program and copies it to a file. |
| vi | Edits files with full screen display. |
| wc | Counts the number of lines, words, bytes, and characters in a file. |
| who | Identifies the users currently logged in. |

As each command is executed, the user log and the global command log are updated.

The user log contains a list of each Virtual I/O Server command, including arguments, that a user has executed. One user log for each user in the system is created. This log is located in the home directory of the user and can be viewed by using either the **cat** or the **vi** commands.

The global command log is made up of all the Virtual I/O Server command-line interface commands executed by all users, including arguments, the date and time the command was executed, and from which user ID it was executed. The global command log is viewable only by the **padmin** user ID, and it can be viewed by using the **lsgcl** command. If the global command log exceeds 1 MB, the log is truncated to 250 KB to prevent the file system from reaching its capacity.

Note: Integrated Virtualization Manager commands are audited in a separate place and are viewable either in **Application Logs**, or by running the following command from the command line:

```
lssvcevents -t console --filter severities=audit
```

Remote script

Secure Shell (SSH) is shipped with the Virtual I/O Server. Hence, scripts and commands can run remotely after an exchange of SSH keys. To set up and run the commands remotely, perform the following steps:

1. From the command line on the remote system, type the **ssh** command and verify that the Virtual I/O Server has been added as a known host. If not, you must perform the following steps to exchange ssh keys.

```
# ssh padmin@<vios> ioscli ioslevel
padmin@<vios>'s password:
2.1.2.0
```

Where <vios> is either the Virtual I/O Server host name or its TCP/IP address.

2. Generate the public ssh key on the remote system.
3. Transfer the ssh key to the Virtual I/O Server. The transfer can be done using File Transfer Protocol (FTP).
4. On the Virtual I/O Server, type the following command to copy the public key to the **.ssh** directory:

```
$ cat id_rsa.pub >> .ssh/authorized_keys2
```

5. From the command line on the remote system, type the same **ssh** command from step 1 to add the Virtual I/O Server as a known host. The command prompts the user for a password if it has not already been added as a known host.
6. From the command line on the remote system, type the same **ssh** command from step 1 to verify that the **ssh** command can run without requiring the user to enter a password.

Related information:

 [Virtual I/O Server and Integrated Virtualization Manager commands](#)

Tivoli software and the Virtual I/O Server

Learn about integrating the Virtual I/O Server into your Tivoli environment for Tivoli Application Dependency Discovery Manager, Tivoli Monitoring, Tivoli Storage Manager, Tivoli Usage and Accounting Manager, Tivoli Identity Manager, and TotalStorage Productivity Center.

Tivoli Application Dependency Discovery Manager

Tivoli Application Dependency Discovery Manager (TADDM) discovers infrastructure elements found in the typical data center, including application software, hosts and operating environments (including the Virtual I/O Server), network components (such as routers, switches, load balancers, firewalls, and storage), and network services (such as LDAP, NFS, and DNS). Based on the data it collects, TADDM automatically creates and maintains application infrastructure maps that include runtime dependencies, configuration values, and change history. With this information, you can determine the interdependences between business applications, software applications, and physical components to help you ensure and improve application availability in your environment. For example, you can do the following tasks:

- You can isolate configuration-related application problems.
- You can plan for application changes to minimize or eliminate unplanned disruptions.
- You can create a shared topological definition of applications for use by other management applications.
- You can determine the effect of a single configuration change on a business application or service.
- You can see what changes take place in the application environment and where.

TADDM includes an agent-free discovery engine, which means that the Virtual I/O Server does not require that an agent or client be installed and configured in order to be discovered by TADDM. Instead, TADDM uses discovery sensors that rely on open and secure protocols and access mechanisms to discover the data center components.

Tivoli Identity Manager

With Tivoli Identity Manager, you can manage identities and users across several platforms, including AIX systems, Windows systems, Solaris systems, and so on. With Tivoli Identity Manager 4.7 and later, you can also include Virtual I/O Server users. Tivoli Identity Manager provides a Virtual I/O Server adapter that acts as an interface between the Virtual I/O Server and the Tivoli Identity Manager Server. The adapter might not be located on the Virtual I/O Server and the Tivoli Identity Manager Server manages access to the Virtual I/O Server by using your security system.

The adapter runs as a service, independent of whether a user is logged on to the Tivoli Identity Manager Server. The adapter acts as a trusted virtual administrator on the Virtual I/O Server, performing tasks like the following:

- Creating a user ID to authorize access to the Virtual I/O Server.
- Modifying an existing user ID to access the Virtual I/O Server.
- Removing access from a user ID. This deletes the user ID from the Virtual I/O Server.
- Suspending a user account by temporarily deactivating access to the Virtual I/O Server.

- Restoring a user account by reactivating access to the Virtual I/O Server.
- Changing a user account password on the Virtual I/O Server.
- Reconciling the user information of all current users on the Virtual I/O Server.
- Reconciling the user information of a particular user account on the Virtual I/O Server by performing a lookup.

Tivoli Monitoring

Virtual I/O Server V1.3.0.1 (fix pack 8.1), includes the Tivoli Monitoring System Edition agent. With Tivoli Monitoring System Edition , you can monitor the health and availability of multiple servers (including the Virtual I/O Server) from the Tivoli Enterprise Portal. Tivoli Monitoring System Edition gathers data from the Virtual I/O Server, including data about physical volumes, logical volumes, storage pools, storage mappings, network mappings, real memory, processor resources, mounted file system sizes, and so on. From the Tivoli Enterprise Portal, you can view a graphical representation of the data, use predefined thresholds to alert you on key metrics, and resolve issues based on recommendations provided by the Expert Advice feature of Tivoli Monitoring.

Tivoli Storage Manager

Virtual I/O Server 1.4 includes the Tivoli Storage Manager client. With Tivoli Storage Manager, you can protect Virtual I/O Server data from failures and other errors by storing backup and disaster-recovery data in a hierarchy of offline storage. Tivoli Storage Manager can help protect computers running a variety of different operating environments, including the Virtual I/O Server, on a variety of different hardware. If you configure the Tivoli Storage Manager client on the Virtual I/O Server, you can include the Virtual I/O Server in your standard backup framework.

Tivoli Usage and Accounting Manager

Virtual I/O Server 1.4 includes the Tivoli Usage and Accounting Manager agent on the Virtual I/O Server. Tivoli Usage and Accounting Manager helps you track, allocate, and invoice your IT costs by collecting, analyzing, and reporting on the actual resources used by entities such as cost centers, departments, and users. Tivoli Usage and Accounting Manager can gather data from multi-tiered datacenters that include Windows, AIX, Virtual I/O Server, HP/UX Sun Solaris, Linux, and VMware.

TotalStorage Productivity Center

With Virtual I/O Server 1.5.2, you can configure the TotalStorage Productivity Center agents on the Virtual I/O Server. TotalStorage Productivity Center is an integrated, storage infrastructure management suite that is designed to help simplify and automate the management of storage devices, storage networks, and capacity utilization of file systems and databases. When you install and configure the TotalStorage Productivity Center agents on the Virtual I/O Server, you can use the TotalStorage Productivity Center user interface to collect and view information about the Virtual I/O Server. You can then perform the following tasks using the TotalStorage Productivity Center user interface:

1. Run a discovery job for the agents on the Virtual I/O Server.
2. Run probes, run scans, and ping jobs to collect storage information about the Virtual I/O Server.
3. Generate reports using the Fabric Manager and the Data Manager to view the storage information gathered.
4. View the storage information gathered using the topology Viewer.

Related tasks:

“Configuring the Tivoli agents and clients on the Virtual I/O Server” on page 161

You can configure and start the Tivoli Monitoring agent, Tivoli Usage and Accounting Manager, the Tivoli Storage Manager client, and the Tivoli TotalStorage Productivity Center agents.

Related information:

- [IBM Tivoli Application Dependency Discovery Manager Information Center](#)
- [IBM Tivoli Identity Manager](#)
- [IBM Tivoli Monitoring version 6.2.1 documentation](#)
- [IBM Tivoli Monitoring Virtual I/O Server Premium Agent User's Guide](#)
- [IBM Tivoli Storage Manager](#)
- [IBM Tivoli Usage and Accounting Manager Information Center](#)
- [IBM TotalStorage Productivity Center Information Center](#)

Systems Director software

Learn about integrating the Virtual I/O Server into your Systems Director environment.

Systems Director is a platform-management foundation that streamlines the way you manage physical and virtual systems across a heterogeneous environment. By leveraging industry standards, Systems Director supports multiple operating systems and virtualization technologies across many platforms.

Through a single user interface, Systems Director provides consistent views for viewing managed systems, determining how these systems relate to one another, and identifying their statuses, thus helping to correlate technical resources with business needs. A set of common tasks included with Systems Director provides many of the core capabilities that are required for basic management. These common tasks include discovery, inventory, configuration, system health, monitoring, updates, event notification and automation across managed systems.

Systems Director's Web and command-line interfaces provide a consistent interface focused on these common tasks:

- Discovering, navigating and visualizing systems on the network with the detailed inventory and relationships to the other network resources
- Notifying users of problems that occur on systems and the ability to navigate to the source of the problem
- Notifying users when systems need updates, and distributing and installing updates on a schedule
- Analyzing real-time data for systems, and setting critical thresholds that notify the administrator of emerging problems
- Configuring settings of a single system, and creating a configuration plan that can apply those settings to multiple systems
- Updating installed plug-ins to add new features and function to the base capabilities
- Managing the life cycle of virtual resources

Related tasks:

“Configuring the Director agent” on page 167

You can configure and start the Director agent on the Virtual I/O Server.

Related information:

 [IBM Systems Director technical overview](#)

Scenarios: Configuring the Virtual I/O Server

The following scenarios show examples of networking configurations for the Virtual I/O Server logical partition and the client logical partitions. Use the following scenarios and configuration examples to understand more about the Virtual I/O Server and its components.

Scenario: Configuring a Virtual I/O Server without VLAN tagging

Use this scenario to help you become familiar with creating a network without VLAN tagging.

About this task

Situation

You are the system administrator responsible for planning and configuring the network in an environment with the Virtual I/O Server running. You want to configure a single logical subnet on the system that communicates with the switch.

Objective

The objective of this scenario is to configure the network where only Port Virtual LAN ID (PVID) is used, the packets are not tagged, and a single internal network is connected to a switch. There are no virtual local area networks (VLAN) tagged ports set up on the Ethernet switch, and all virtual Ethernet adapters are defined using a single default PVID and no additional VLAN IDs (VIDs).

Prerequisites and assumptions

- The Hardware Management Console (HMC) was set up. For more information about Installing and configuring the Hardware Management Console, see *Installing and configuring the Hardware Management Console*.
- You understand the partitioning concepts as described in the Logical partitioning. For more information about Logical partitioning, see *Logical partitioning*.
- The Virtual I/O Server logical partition has been created and the Virtual I/O Server has been installed. For instructions, see “Installing the Virtual I/O Server and client logical partitions” on page 88.
- You have created the remaining logical partitions that you want added to the network configuration.
- You have an Ethernet switch and a router ready to add to the configuration.
- You have IP addresses for all logical partitions and systems that will be added to the configuration.

While this procedure describes configuration in an HMC environment, this configuration is also possible in an Integrated Virtualization Manager environment.

Configuration steps

The following figure shows the configuration that will be completed during this scenario.

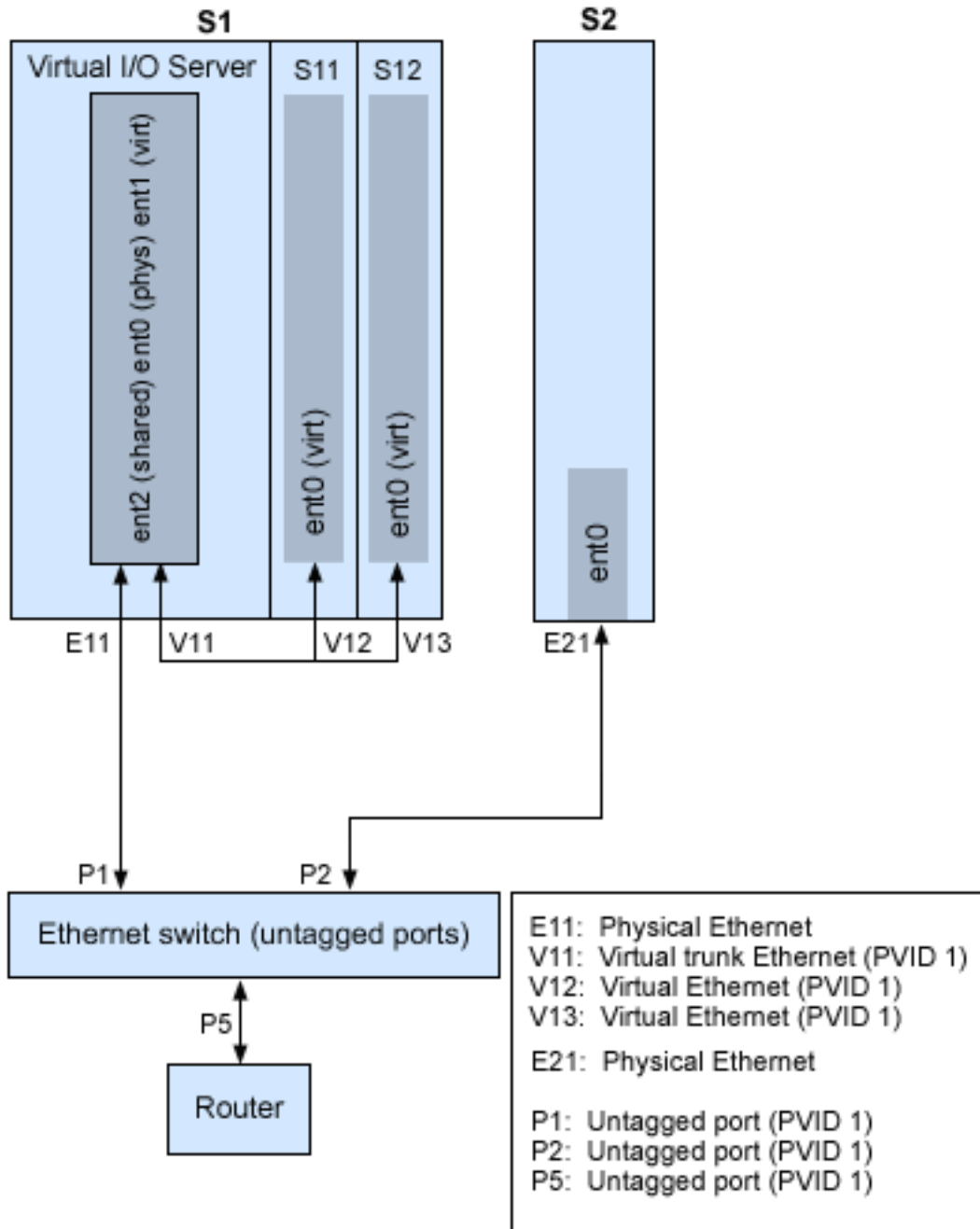

Using the preceding figure as a guide, follow these steps:

Procedure

1. Set up an Ethernet switch with untagged ports. Alternatively, you can use an Ethernet switch that does not use VLAN.
2. For system S1, use the HMC to create a virtual Ethernet adapter (V11) for the Virtual I/O Server with the trunk setting, PVID set to 1, and no additional VIDs.
3. For system S1, use the HMC to create virtual Ethernet adapters V12 and V13 for logical partitions S11 and S12, respectively, with PVID set to 1 and no additional VIDs.

4. For system S1, use the HMC to assign physical Ethernet adapter E11 to the Virtual I/O Server and connect the adapter to the Ethernet switch port P1.
5. On the Virtual I/O Server, set up Shared Ethernet Adapter ent2 with the physical adapter ent0 and virtual adapter ent1.
6. Start the logical partitions. The process recognizes the virtual devices that were created in Step 1.
7. Configure IP addresses for S11 (en0), S12 (en0), and S2 (en0), so that they all belong to the same subnet with the router connected to Ethernet switch port P5.

Results

The Shared Ethernet Adapter on the Virtual I/O Server logical partition can also be configured with IP addresses on the same subnet. This is required only for network connectivity to the Virtual I/O Server logical partition.

Scenario: Configuring a Virtual I/O Server using VLAN tagging

Use this scenario to help you become familiar with creating a network using VLAN tagging.

About this task

Situation

You are the system administrator responsible for planning and configuring the network in an environment with the Virtual I/O Server running. You would like to configure the network so that two logical subnets exist, with some logical partitions on each subnet.

Objective

The objective of this scenario is to configure multiple networks to share a single physical Ethernet adapter. Systems on the same subnet are required to be on the same VLAN and therefore have the same VLAN ID, which allows communication without having to go through the router. The separation in the subnets is achieved by ensuring that the systems on the two subnets have different VLAN IDs.

Prerequisites and assumptions

- The Hardware Management Console (HMC) was set up. For more information about Installing and configuring the Hardware Management Console, see *Installing and configuring the Hardware Management Console*.
- You understand the partitioning concepts as described in the *Logical partitioning*. For more information about Logical partitioning, see *Logical partitioning*.
- The Virtual I/O Server logical partition has been created and the Virtual I/O Server has been installed. For instructions, see “Installing the Virtual I/O Server and client logical partitions” on page 88.
- You have created the remaining AIX or Linux logical partitions that you want added to the network configuration.
- You have an Ethernet switch and a router ready to add to the configuration.
- You have IP addresses for all logical partitions and systems that will be added to the configuration.

You cannot use VLAN in an Integrated Virtualization Manager environment.

Configuration steps

The following figure shows the configuration that will be completed during this scenario.

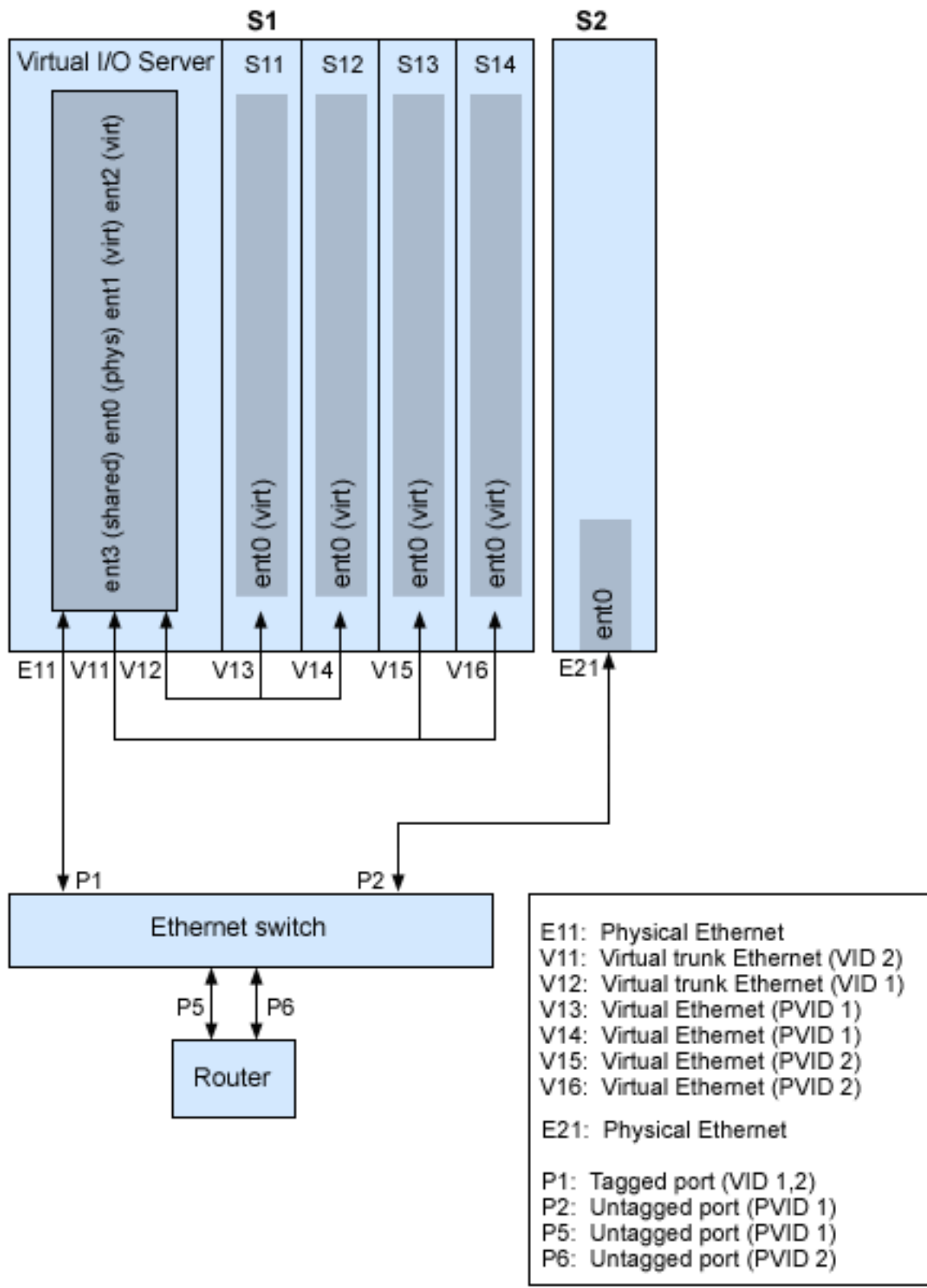

Using the preceding figure as a guide, follow these steps.

Procedure

1. Set up the Ethernet switch ports as follows:
 - P1: Tagged port (VID 1, 2)
 - P2: Untagged port (PVID 1)
 - P5: Untagged port (PVID 1)
 - P6: Untagged port (PVID 2)For instructions on configuring the ports, see the documentation for your switch.
2. For system S1, use the HMC to create virtual Ethernet adapters for the Virtual I/O Server:
 - Create virtual Ethernet adapter V11 for the Virtual I/O Server with the trunk setting selected and VID set to 2. Specify an unused PVID value. This value is required, even though it will not be used.
 - Create virtual Ethernet adapter V12 for the Virtual I/O Server with the trunk setting selected and VID set to 1. Specify an unused PVID value. This value is required, even though it will not be used.
3. For system S1, use the HMC to create virtual Ethernet adapters for other logical partitions:
 - Create virtual adapters V13 and V14 for logical partitions S11 and S12, respectively, with PVID set to 2 and no additional VIDs.
 - Create virtual adapters V15 and V16 for logical partitions S13 and S14, respectively, with PVID set to 1 and no additional VIDs.
4. For system S1, use the HMC to assign the physical Ethernet adapter (E11) to the Virtual I/O Server and connect the adapter to the Ethernet switch port P1.
5. Using the Virtual I/O Server command-line interface, set up a Shared Ethernet Adapter ent3 with the physical adapter ent0 and virtual adapters ent1 and ent2.
6. Configure IP addresses for the following:
 - S13 (en0), S14 (en0), and S2 (en0) belong to VLAN 1 and are on the same subnet. The router is connected to Ethernet switch port P5.
 - S11 (en0) and S12 (en0) belong to VLAN 2 and are on the same subnet. The router is connected to Ethernet switch port P6.

Results

You can configure the Shared Ethernet Adapter on the Virtual I/O Server logical partition with an IP address. This is required only for network connectivity to the Virtual I/O Server.

As the tagged VLAN network is being used, you must define additional VLAN devices over the Shared Ethernet Adapters before configuring IP addresses.

Scenario: Configuring Shared Ethernet Adapter failover

Use this scenario to help you to configure primary and backup Shared Ethernet Adapters in the Virtual I/O Server logical partitions.

About this task

Situation

You are the system administrator responsible for planning and configuring the network in an environment with the Virtual I/O Server running. You want to provide higher network availability to the client logical partition on the system. This can be accomplished by configuring a backup Shared Ethernet Adapter in a different Virtual I/O Server logical partition.

Objective

The objective of this scenario is to configure primary and backup Shared Ethernet Adapters in the Virtual I/O Server logical partitions so that network connectivity in the client logical partitions will not be lost in the case of adapter failure.

Prerequisites and assumptions

- The Hardware Management Console (HMC) was set up. For more information about Installing and configuring the Hardware Management Console, see *Installing and configuring the Hardware Management Console*.
- You understand the partitioning concepts as described in the *Logical partitioning*. For more information about Logical partitioning, see *Logical partitioning*.
- Two separate Virtual I/O Server logical partitions have been created and the Virtual I/O Server has been installed in each logical partition. For instructions, see “Installing the Virtual I/O Server and client logical partitions” on page 88.
- You understand what Shared Ethernet Adapter failover is and how it works. See “Shared Ethernet Adapter failover” on page 82.
- You have created the remaining logical partitions that you want added to the network configuration.
- Each Virtual I/O Server logical partition has an available physical Ethernet adapter assigned to it.
- You have IP addresses for all logical partitions and systems that will be added to the configuration.

You cannot use the Integrated Virtualization Manager with multiple Virtual I/O Server logical partitions on the same server.

The following image depicts a configuration where the Shared Ethernet Adapter failover feature is set up. The client logical partitions H1 and H2 are accessing the physical network using the Shared Ethernet Adapters, which are the primary adapters. The virtual Ethernet adapters used in the shared Ethernet setup are configured with the same VLAN membership information (PVID, VID), but have different priorities. A dedicated virtual network forms the control channel and is required to facilitate communication between the primary and backup shared Ethernet device.

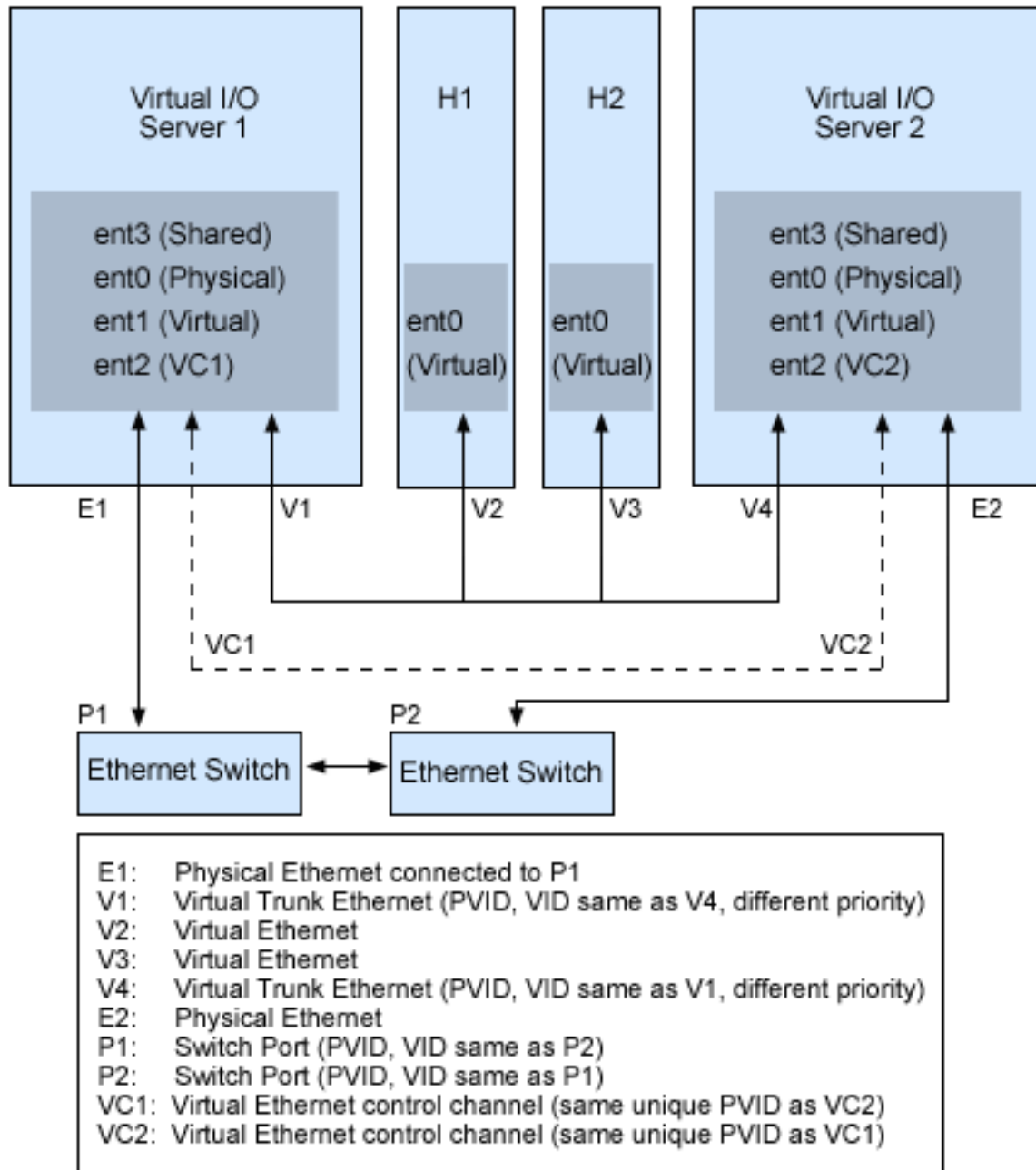

Using the preceding figure as a guide, follow these steps:

Procedure

1. On the HMC, create the virtual Ethernet adapters following these guidelines:
 - Configure the virtual adapters to be used for data as trunk adapters by selecting the trunk setting.
 - Assign different prioritization values (valid values are 1-15) to each virtual adapter.
 - Configure another virtual Ethernet to be used for the control channel by giving it a unique PVID value. Make sure you use the same PVID when creating this virtual Ethernet for both Virtual I/O Server logical partitions.
2. Using the Virtual I/O Server command line, run the following command to configure the Shared Ethernet Adapter. Run this command on both Virtual I/O Server logical partitions involved in the configuration:

```
mkvdev -sea physical_adapter -vadapter virtual_adapter -default
virtual_adapter\
-defaultid PVID_of_virtual_adapter -attr ha_mode=auto
ctl_chan=control_channel_adapter
```

For example, in this scenario, run the following command on both Virtual I/O Server logical partitions:

```
mkvdev -sea ent0 -vadapter ent1 -default ent1 -defaultid 60 -attr ha_mode=auto
ctl_chan=ent2
```

Scenario: Configuring Shared Ethernet Adapter failover with load sharing

Use this scenario to help you to configure primary and backup Shared Ethernet Adapters for load sharing in the Virtual I/O Server (VIOS) logical partitions.

About this task

Situation

You are the system administrator responsible for planning and configuring the network in an environment with the VIOS running. You want to provide load sharing in addition to Shared Ethernet Adapter failover to improve the bandwidth of the VIOS logical partition without impact to higher network availability.

Objective

The objective of this scenario is to configure primary and backup Shared Ethernet Adapters for load sharing so that you can use both the Shared Ethernet Adapters by sharing the bridging workload between them.

Prerequisites and assumptions

- The Hardware Management Console (HMC) was set up. For more information about Installing and configuring the Hardware Management Console, see *Installing and configuring the Hardware Management Console*.
- You understand the partitioning concepts as described in the *Logical partitioning*. For more information about Logical partitioning, see *Logical partitioning*.
- You have configured primary and backup Shared Ethernet Adapters in the VIOS logical partitions. See “Scenario: Configuring Shared Ethernet Adapter failover” on page 56.
- You understand what Shared Ethernet Adapter load sharing is and how it works. See “Shared Ethernet Adapters for load sharing” on page 83.
- The VIOS must be at Version 2.2.1.0, or later.
- The VIOS servers with the primary and backup Shared Ethernet Adapter support load sharing.
- Two or more trunk adapters are configured for the primary and backup Shared Ethernet Adapter pair.
- The virtual local area network (VLAN) definitions of the trunk adapters are identical between the primary and backup Shared Ethernet Adapter pair.
- You cannot use the Integrated Virtualization Manager with multiple VIOS logical partitions on the same server.

Note: Enable load sharing mode on the primary Shared Ethernet Adapter (the Shared Ethernet Adapter with higher priority) before you enable load sharing mode on the backup Shared Ethernet Adapter (the Shared Ethernet Adapter with lower priority).

To configure Shared Ethernet Adapters for load sharing, use the VIOS command line and run the following command. Run this command on both Shared Ethernet Adapters.

```
mkvdev -sea physical_adapter -vadapter virtual_adapter1, virtual_adapter2 -default virtual_adapter1\
-defaultid PVID_of_virtual_adapter1 -attr ha_mode=sharing
ctl_chan=control_channel_adapter
```

For example, in this scenario, run the following command on both Shared Ethernet Adapters:

```
mkvdev -sea ent0 -vadapter ent1,ent2 -default ent1 -defaultid 60 -attr ha_mode=sharing
ctl_chan=ent3
```

What to do next

You can restart load sharing by using the **chdev** command on the backup Shared Ethernet Adapter. To restart load sharing, ensure that the **ha_mode** attribute is set to sharing on both the primary and backup Shared Ethernet Adapter. By using the VIOS command line, run the **chdev** command on the backup Shared Ethernet Adapter. If the load sharing criteria are met, load sharing restarts.

Scenario: Configuring Network Interface Backup in AIX client logical partitions without VLAN tagging

Use this scenario to become familiar with using a Network Interface Backup (NIB) configuration in Virtual I/O clients that are running AIX logical partitions and are not configured for VLAN tagging.

About this task

Situation

In this scenario, you want to configure a highly available virtual environment for your bridged network using the NIB approach to access external networks from your Virtual I/O clients. You do not plan to use VLAN tagging in your network setup. This approach requires you to configure a second Ethernet adapter on a different VLAN for each client and requires a Link Aggregation adapter with NIB features. This configuration is available for AIX logical partitions.

Note: You can also configure Ethernet bonding on Linux logical partitions. For more information, see the documentation for the Linux operating system.

Typically, a Shared Ethernet Adapter failover configuration is the recommended configuration for most environments because it supports environments with or without VLAN tagging. Also, the NIB configuration is more complex than a Shared Ethernet Adapter failover configuration because it must be implemented on each of the clients. However, Shared Ethernet Adapter failover was not available prior to Version 1.2 of Virtual I/O Server, and NIB was the only approach to a highly available virtual environment. Also, you might consider that in an NIB configuration you can distribute clients over both Shared Ethernet Adapters in such a way that half of them will use the first Shared Ethernet Adapter and the other half will use the second Shared Ethernet Adapter as primary adapter.

Objective

Create a virtual Ethernet environment using a Network Interface Backup configuration as depicted in the following figure.

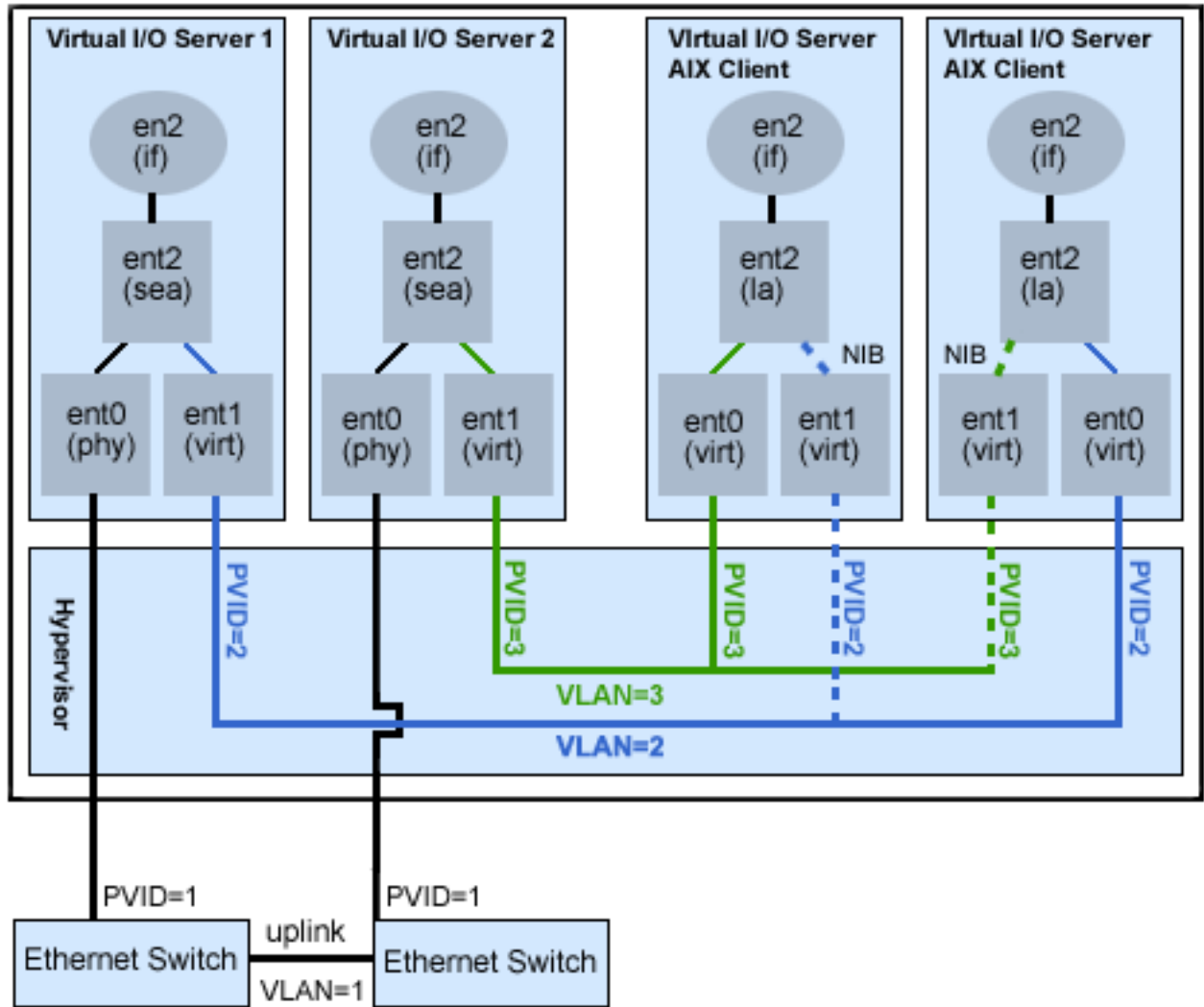

Prerequisites and assumptions

Before completing the configuration tasks, review the following prerequisites and assumptions.

- The Hardware Management Console (HMC) is already set up. For more information about Installing and configuring the Hardware Management Console, see Installing and configuring the Hardware Management Console.
- Two separate Virtual I/O Server logical partitions have been created and the Virtual I/O Server has been installed in each logical partition. See the instructions in “Installing the Virtual I/O Server and client logical partitions” on page 88.
- You have created the remaining logical partitions that you want added to the network configuration.
- Each Virtual I/O Server logical partition has an available physical Ethernet adapter assigned to it.
- You have IP addresses for all logical partitions and systems that will be added to the configuration.

Configuration tasks

Using the figure as a guide, complete the following tasks to configure the NIB virtual environment.

Procedure

1. Create a LAN connection between the Virtual I/O Servers and the external network:
 - a. Configure a Shared Ethernet Adapter on the primary Virtual I/O Server that bridges traffic between the virtual Ethernet and the external network. See “Configuring a Shared Ethernet Adapter” on page 156.
 - b. Configure a Shared Ethernet Adapter on the second Virtual I/O Server, as in step 1.
2. For each client logical partition, use the HMC to create a virtual Ethernet whose PVID matches the PVID of the primary Virtual I/O Server. This will be used as the primary adapter.
3. For each client logical partition, use the HMC to create a second virtual Ethernet whose PVID matches the PVID of the second (backup) Virtual I/O Server. This will be used as the backup adapter.
4. Create the Network Interface Backup setup using a Link Aggregation configuration. Make sure that you specify the following items:
 - a. Select the primary Ethernet Adapter.
 - b. Select the Backup Adapter.
 - c. Specify the Internet Address to Ping. Select the IP address or host name of a host outside of the Virtual I/O Server system that NIB will continuously ping to detect Virtual I/O Server failure.

Results

Note: Keep in mind, when you configure NIB with two virtual Ethernet adapters, the internal networks used must stay separated in the hypervisor. You must use different PVIDs for the two adapters in the client and cannot use additional VIDs on them.

Scenario: Configuring Multi-Path I/O for AIX client logical partitions

Multi-Path I/O (MPIO) helps provide increased availability of virtual Small Computer Serial Interface (SCSI) resources by providing redundant paths to the resource. This topic describes how to set up Multi-Path I/O for AIX client logical partitions.

Before you begin

In order to provide MPIO to AIX client logical partitions, you must have two Virtual I/O Server logical partitions configured on your system. This procedure assumes that the disks are already allocated to both the Virtual I/O Server logical partitions involved in this configuration.

Note: You can also configure MPIO on Linux logical partitions. For more information, see the documentation for the Linux operating system.

About this task

To configure MPIO, follow these steps. In this scenario, hdisk5 in the first Virtual I/O Server logical partition, and hdisk7 in the second Virtual I/O Server logical partition, are used in the configuration.

The following figure shows the configuration that will be completed during this scenario.

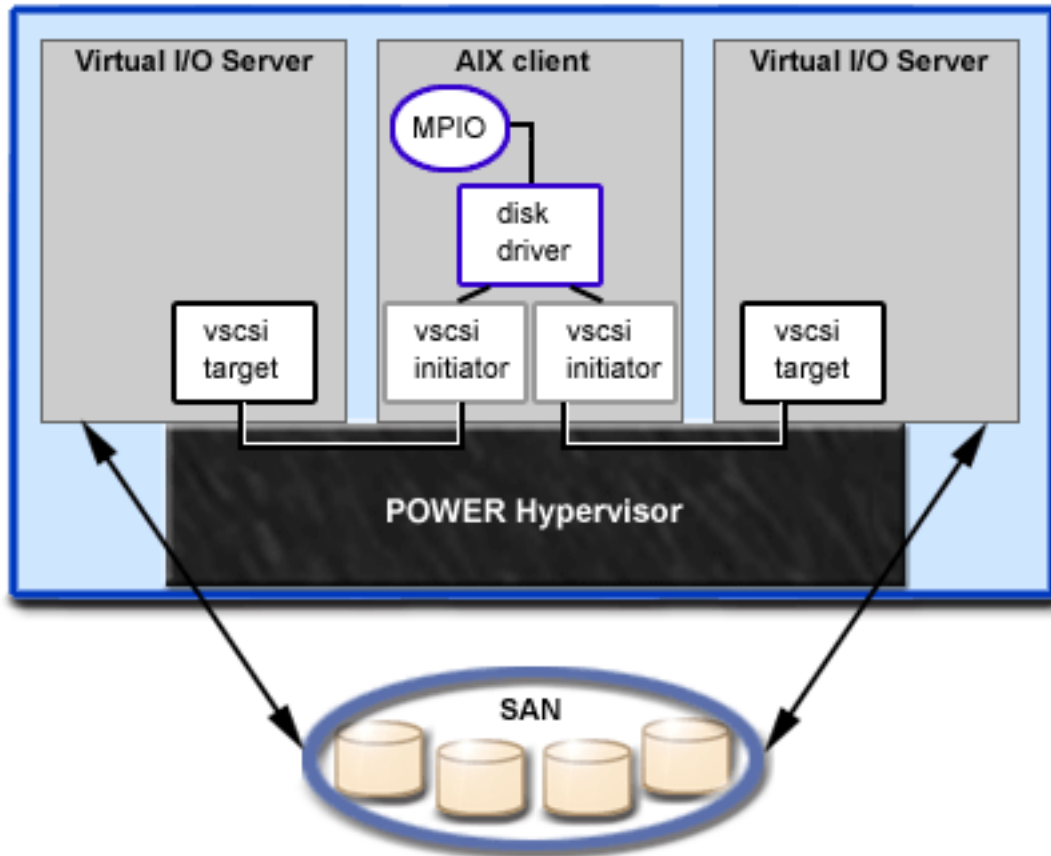

Using the preceding figure as a guide, follow these steps:

Procedure

1. Using the HMC, create SCSI server adapters on the two Virtual I/O Server logical partitions.
2. Using the HMC, create two virtual client SCSI adapters on the client logical partitions, each mapping to one of the Virtual I/O Server logical partitions.
3. On either of the Virtual I/O Server logical partitions, determine which disks are available by typing `lsdev -type disk`. Your results look similar to the following:

```

name          status   description
-----
hdisk3        Available MPIIO Other FC SCSI Disk Drive
hdisk4        Available MPIIO Other FC SCSI Disk Drive
hdisk5        Available MPIIO Other FC SCSI Disk Drive

```

Select which disk that you want to use in the MPIIO configuration. In this scenario, `hdisk5` is selected.

4. Determine the ID of the disk that you have selected. For instructions, see “Identifying exportable disks” on page 113. In this scenario, the disk does not have an IEEE volume attribute identifier or a unique identifier (UDID). Hence, determine the physical identifier (PVID) by running the `lspv hdisk5` command. Your results look similar to the following:

```

hdisk5        00c3e35ca560f919      None

```

The second value is the PVID. In this scenario, the PVID is `00c3e35ca560f919`. Note this value.

5. List the attributes of the disk on the first Virtual I/O Server by using the `lsdev` command. In this scenario, type `lsdev -dev hdisk5 -attr`. Your results look similar to the following

```

..
lun_id          0x5463000000000000          Logical Unit Number ID          False
..
..
pvid           00c3e35ca560f9190000000000000000 Physical volume identifier        False
..
reserve_policy single_path                  Reserve Policy                    True

```

Note the values for `lun_id` and `reserve_policy`. If the `reserve_policy` attribute is set to anything other than `no_reserve`, then you must change it. Set the `reserve_policy` to `no_reserve` by typing `chdev -dev hdiskx -attr reserve_policy=no_reserve`.

- On the second Virtual I/O Server logical partition, list the physical volumes by typing `lspv`. In the output, locate the disk that has the same PVID as the disk identified previously. In this scenario, the PVID for `hdisk7` matched:

```

hdisk7          00c3e35ca560f919          None

```

Tip: Although the PVID values should be identical, the disk numbers on the two Virtual I/O Server logical partitions might vary.

- Determine if the `reserve_policy` attribute is set to `no_reserve` using the `lsdev` command. In this scenario, type `lsdev -dev hdisk7 -attr`. You see results similar to the following:

```

..
lun_id          0x5463000000000000          Logical Unit Number ID          False
..
..
pvid           00c3e35ca560f9190000000000000000 Physical volume identifier        False
..
reserve_policy single_path                  Reserve Policy

```

If the `reserve_policy` attribute is set to anything other than `no_reserve`, you must change it. Set the `reserve_policy` to `no_reserve` by typing `chdev -dev hdiskx -attr reserve_policy=no_reserve`.

- On both Virtual I/O Server logical partitions, use the `mkvdev` to create the virtual devices. In each case, use the appropriate `hdisk` value. In this scenario, type the following commands:
 - On the first Virtual I/O Server logical partition, type `mkvdev -vdev hdisk5 -vadapter vhost5 -dev vhdisk5`
 - On the second Virtual I/O Server logical partition, type `mkvdev -vdev hdisk7 -vadapter vhost7 -dev vhdisk7`

The same LUN is now exported to the client logical partition from both Virtual I/O Server logical partitions.

- AIX can now be installed on the client logical partition. For instructions on installing AIX, see *Installing AIX in a Partitioned Environment* in the *servers* and *AIX Information Center*.
- After you have installed AIX on the client logical partition, check for MPIO by running the following command:

```
lspath
```

You see results similar to the following:

```

Enabled hdisk0 vscsi0
Enabled hdisk0 vscsi1

```

If one of the Virtual I/O Server logical partitions fails, the results of the `lspath` command look similar to the following:

```

Failed  hdisk0 vscsi0
Enabled hdisk0 vscsi1

```

Unless a health check is enabled, the state continues to show `Failed` even after the disk has recovered. To have the state updated automatically, type `chdev -l hdiskx -a hcheck_interval=60 -P`. The client logical partition must be rebooted for this change to take effect.

Planning for the Virtual I/O Server

Use this topic to help gain an understanding of what to consider when planning for the Virtual I/O Server.

Specifications required to create the Virtual I/O Server

This topic defines the range of configuration possibilities, including the minimum number of resources needed and the maximum number of resources allowed to create the Virtual I/O Server (VIOS).

To activate the VIOS, the PowerVM Editions (or Advanced POWER® Virtualization) hardware feature is required. A logical partition with enough resources to share with other logical partitions is required. The following is a list of minimum hardware requirements that must be available to create the VIOS.

Table 17. Resources that are required

| Resource | Requirement |
|--|---|
| Hardware Management Console or Integrated Virtualization Manager | The HMC or Integrated Virtualization Manager is required to create the logical partition and assign resources. |
| Storage adapter | The server logical partition needs at least one storage adapter. |
| Physical disk | The disk must be at least 30 GB. This disk can be shared. |
| Ethernet adapter | If you want to route network traffic from virtual Ethernet adapters to a Shared Ethernet Adapter, you need an Ethernet adapter. |
| Memory | For POWER7 processor-based systems, at least 768 MB of memory is required. |
| Processor | At least 0.1 processor is required. |

The following table defines the limitations for storage management.

Table 18. Limitations for storage management

| Category | Limit |
|---------------------|-----------------------|
| Volume groups | 4096 per system |
| Physical volumes | 1024 per volume group |
| Physical partitions | 1024 per volume group |
| Logical volumes | 1024 per volume group |
| Logical partitions | No limit |

Limitations and restrictions of the Virtual I/O Server configuration

Learn about Virtual I/O Server (VIOS) configuration limitations.

Consider the following when implementing virtual Small Computer Serial Interface (SCSI):

- Virtual SCSI supports the following connection standards for backing devices: Fibre Channel, SCSI, SCSI RAID, iSCSI, SAS, SATA, USB, and IDE.
- The SCSI protocol defines mandatory and optional commands. While virtual SCSI supports all of the mandatory commands, not all of the optional commands are supported.
- There may be utilization implications when using virtual SCSI devices. Because the client/server model is made up of layers of function, using virtual SCSI can consume additional processor cycles when processing I/O requests.
- The VIOS is a dedicated logical partition, to be used only for VIOS operations. Other applications cannot run in the VIOS logical partition.

- If there is a resource shortage, performance degradation might occur. If a VIOS is serving many resources to other logical partitions, ensure that enough processor power is available. In case of high workload across virtual Ethernet adapters and virtual disks, logical partitions might experience delays in accessing resources.
- Logical volumes and files exported as virtual SCSI disks are always configured as single path devices on the client logical partition.
- Logical volumes or files exported as virtual SCSI disks that are part of the root volume group (rootvg) are not persistent if you reinstall the VIOS. However, they are persistent if you update the VIOS to a new service pack. Therefore, before reinstalling the VIOS, ensure that you back up the corresponding clients' virtual disks. When exporting logical volumes, it is best to export logical volumes from a volume group other than the root volume group. When exporting files, it is best to create file storage pools and the virtual media repository in a parent storage pool other than the root volume group.

Consider the following when implementing virtual adapters:

- Only Ethernet adapters can be shared. Other types of network adapters cannot be shared.
- IP forwarding is not supported on the VIOS.
- The maximum number of virtual adapters can be any value from 2 to 65,536. However, if you set the maximum number of virtual adapters to a value higher than 1024, the logical partition might fail to activate or the server firmware might require more system memory to manage the virtual adapters.

The VIOS supports client logical partitions running the following operating systems on the following POWER7 processor-based servers.

Table 19. Minimum operating system versions required for VIOS client logical partitions

| POWER7 processor-based servers | Minimum operating system versions |
|--|--|
| All POWER7 processor-based servers | operating system |
| All POWER7 processor-based servers | AIX 6.1 |
| All POWER7 processor-based servers | AIX 5.3 |
| <ul style="list-style-type: none"> • 02E/4B • 02E/4C • 05F/6B • 05E/6C • 31E/2B • 31E/1C • 31E/2C • 33E/8B • 36E/8C • 17M/MB • 17M/MC • 19F/HB • 79M/HB • 79M/HC • BladeCenter PS/700 • BladeCenter PS/701 • BladeCenter PS/702 • BladeCenter PS/703 • BladeCenter PS/704 | SUSE Linux Enterprise Server 11 Service Pack 1 |

Table 19. Minimum operating system versions required for VIOS client logical partitions (continued)

| POWER7 processor-based servers | Minimum operating system versions |
|--|--|
| <ul style="list-style-type: none"> • 02E/4C • 05E/6C • 31E/1C • 31E/2C • 17M/MC • 79M/HC • BladeCenter PS/703 • BladeCenter PS/704 | SUSE Linux Enterprise Server 10 Service Pack 4 |
| <ul style="list-style-type: none"> • 02E/4B • 05F/6B • 31E/2B • 33E/8B • 36E/8C • 17M/MB • 19F/HB • 79M/HB • BladeCenter PS/700 • BladeCenter PS/701 • BladeCenter PS/702 | SUSE Linux Enterprise Server 10 Service Pack 3 |
| <ul style="list-style-type: none"> • 02E/4C • 05E/6C • 31E/1C • 31E/2C • 17M/MC • 79M/HC | Red Hat Enterprise Linux Version 6.1 |
| <ul style="list-style-type: none"> • 02E/4B • 05F/6B • 31E/2B • 33E/8B • 36E/8C • 17M/MB • 19F/HB • 79M/HB • BladeCenter PS/700 • BladeCenter PS/701 • BladeCenter PS/702 • BladeCenter PS/703 • BladeCenter PS/704 | Red Hat Enterprise Linux Version 6 |
| <ul style="list-style-type: none"> • 02E/4C • 05E/6C • 31E/1C • 31E/2C • 17M/MC • 79M/HC | Red Hat Enterprise Linux Version 5.7 |

Table 19. Minimum operating system versions required for VIOS client logical partitions (continued)

| POWER7 processor-based servers | Minimum operating system versions |
|--|--------------------------------------|
| <ul style="list-style-type: none"> • BladeCenter PS/703 • BladeCenter PS/704 | Red Hat Enterprise Linux Version 5.6 |
| <ul style="list-style-type: none"> • 02E/4B • 05F/6B • 31E/2B • 33E/8B • 36E/8C • 17M/MB • 19F/HB • 79M/HB • BladeCenter PS/700 • BladeCenter PS/701 • BladeCenter PS/702 | Red Hat Enterprise Linux version 5.5 |

Capacity planning

This topic includes capacity-planning considerations for the Virtual I/O Server, including information about hardware resources and limitations.

Client logical partitions might use virtual devices, dedicated devices, or a combination of both. Before you begin to configure and install the Virtual I/O Server and client logical partitions, plan what resources each logical partition will use. Throughput requirements and overall workload must be considered when deciding whether to use virtual or dedicated devices and when allocating resources to the Virtual I/O Server. Compared to dedicated Small Computer Serial Interface (SCSI) disks, virtual SCSI disks might achieve similar throughput numbers depending on several factors, including workload and virtual SCSI resources. However, virtual SCSI devices generally have higher processor utilization when compared with directly attached storage.

Planning for virtual SCSI

Find capacity-planning and performance information for virtual Small Computer Serial Interface (SCSI).

Different I/O subsystems have different performance qualities, as does virtual SCSI. This section discusses the performance differences between physical and virtual I/O. The following topics are described in this section:

Virtual SCSI latency:

Find information about virtual Small Computer Serial Interface (SCSI) latency.

I/O latency is the amount of time that passes between the initiation and completion of a disk I/O operation. For example, consider a program that performs 1000 random disk I/O operations, one at a time. If the time to complete an average operation is 6 milliseconds, the program runs in no fewer than 6 seconds. However, if the average response time is reduced to 3 milliseconds, the run time might be reduced by 3 seconds. Applications that are multithreaded or use asynchronous I/O might be less sensitive to latency, but in most circumstances, lower latency can help improve performance.

Because virtual SCSI is implemented as a client and server model, there is some latency that does not exist with directly attached storage. The latency might range from 0.03 to 0.06 milliseconds per I/O operation depending primarily on the block size of the request. The average latency is comparable for both physical disk and logical volume-backed virtual drives. The latency experienced when using a

Virtual I/O Server in a shared-processor logical partition can be higher and more variable than using a Virtual I/O Server in a dedicated logical partition. For additional information about the performance differences between dedicated logical partitions and shared-processor logical partitions, see “Virtual SCSI sizing considerations.”

The following table identifies latency (in milliseconds) for different block-size transmissions on both physical disk and logical-volume-backed virtual SCSI disks.

Table 20. Increase in disk I/O response time based on block size (in milliseconds)

| Backing type | 4 K | 8 K | 32 K | 64 K | 128 K |
|----------------|-------|-------|-------|-------|-------|
| Physical disk | 0.032 | 0.033 | 0.033 | 0.040 | 0.061 |
| Logical volume | 0.035 | 0.036 | 0.034 | 0.040 | 0.063 |

The average disk-response time increases as the block size increases. The latency increases for a virtual SCSI operation are relatively greater on smaller block sizes because of their shorter response time.

Virtual SCSI bandwidth:

View information about virtual Small Computer Serial Interface (SCSI) bandwidth.

I/O bandwidth is the maximum amount of data that can be read or written to a storage device in a unit of time. Bandwidth can be measured from a single thread or from a set of threads running concurrently. Although many customer applications are more sensitive to latency than bandwidth, bandwidth is crucial for many typical operations, such as backing up and restoring persistent data.

The following table compares the results of bandwidth tests for virtual SCSI and physical I/O performance. In the tests, a single thread operates sequentially on a constant file that is 256 MB in size with a Virtual I/O Server running in a dedicated partition. More I/O operations are issued when reading or writing to the file using a small block size as compared to a larger block size. The test was conducted using a storage server with feature code 6239 (type 5704/0625) and a 2-gigabit Fibre Channel adapter attached to one RAID0 LUN that is composed of 5 physical disks from a DS4400 disk system (formerly a FASTT700). The table shows the comparison of measured bandwidth in megabytes per second (MB/s) using virtual SCSI and local attachment for reads with varying block sizes of operations. The difference between virtual I/O and physical I/O in these tests is attributable to the increased latency when using virtual I/O. Because of the larger number of operations, the bandwidth measured with small block sizes is lower than with large block sizes.

Table 21. Physical and virtual SCSI bandwidth comparison (in MB/s)

| I/O type | 4 K | 8 K | 32 K | 64 K | 128 K |
|----------|------|------|------|-------|-------|
| Virtual | 20.3 | 35.4 | 82.6 | 106.8 | 124.5 |
| Physical | 24.3 | 41.7 | 90.6 | 114.6 | 132.6 |

Virtual SCSI sizing considerations:

Understand the processor and memory-sizing considerations when implementing virtual Small Computer Serial Interface (SCSI).

When you are designing and implementing a virtual SCSI application environment, consider the following sizing issues:

- The amount of memory allocated to the Virtual I/O Server
- The processor entitlement of the Virtual I/O Server

- Whether the Virtual I/O Server is run as a shared-processor logical partition or as a dedicated processor logical partition
- The maximum transfer size limitation for physical devices and AIX clients

The processor impacts of using virtual I/O on the client are insignificant. The processor cycles run on the client to perform a virtual SCSI I/O operation are comparable to that of a locally attached I/O device. Thus, there is no increase or decrease in sizing on the client logical partition for a known task. These sizing techniques do not anticipate combining the function of shared Ethernet with the virtual SCSI server. If the two are combined, consider adding resources to account for the shared Ethernet activity with virtual SCSI.

Virtual SCSI sizing using dedicated processor logical partitions

The amount of processor entitlement required for a virtual SCSI server is based on the maximum I/O rates required of it. Because virtual SCSI servers do not normally run at maximum I/O rates all of the time, the use of surplus processor time is potentially wasted when using dedicated processor logical partitions. In the first of the following sizing methodologies, you need a good understanding of the I/O rates and I/O sizes required of the virtual SCSI server. In the second, size the virtual SCSI server based on the I/O configuration.

The sizing methodology used is based on the observation that the processor time required to perform an I/O operating on the virtual SCSI server is fairly constant for a given I/O size. It is a simplification to make this statement, because different device drivers have subtly varying efficiencies. However, under most circumstances, the I/O devices supported by the virtual SCSI server are sufficiently similar. The following table shows approximate cycles per second for both physical disk and logical volume operations on a 1.65 Ghz processor. These numbers are measured at the physical processor; simultaneous multithreading (SMT) operation is assumed. For other frequencies, scaling by the ratio of the frequencies (for example, 1.5 Ghz = 1.65 Ghz / 1.5 Ghz × cycles per operation) is sufficiently accurate to produce a reasonable sizing.

Table 22. Approximate cycles per second on a 1.65 Ghz logical partition

| Disk type | 4 KB | 8 KB | 32 KB | 64 KB | 128 KB |
|----------------|--------|--------|--------|--------|---------|
| Physical disk | 45,000 | 47,000 | 58,000 | 81,000 | 120,000 |
| Logical volume | 49,000 | 51,000 | 59,000 | 74,000 | 105,000 |

Consider a Virtual I/O Server that uses three client logical partitions on physical disk-backed storage. The first client logical partition requires a maximum of 7,000 8-KB operations per second. The second client logical partition requires a maximum of 10,000 8-KB operations per second. The third client logical partition requires a maximum of 5,000 128-KB operations per second. The number of 1.65 Ghz processors for this requirement is approximately $((7,000 \times 47,000 + 10,000 \times 47,000 + 5,000 \times 120,000) / 1,650,000,000) = 0.85$ processors, which rounds up to a single processor when using a dedicated processor logical partition.

If the I/O rates of the client logical partitions are not known, you can size the Virtual I/O Server to the maximum I/O rate of the storage subsystem attached. The sizing could be biased toward small I/O operations or large I/O operations. Sizing to maximum capacity for large I/O operations will balance the processor capacity of the Virtual I/O Server to the potential I/O bandwidth of the attached I/O. The negative aspect of this sizing methodology is that, in nearly every case, more processor entitlement will be assigned to the Virtual I/O Server than it will typically consume.

Consider a case in which a Virtual I/O Server manages 32 physical SCSI disks. An upper limit of processors required can be established based on assumptions about the I/O rates that the disks can achieve. If it is known that the workload is dominated by 8096-byte operations that are random, then assume that each disk is capable of approximately 200 disk I/O operations per second (15k rpm drives).

At peak, the Virtual I/O Server would need to serve approximately 32 disks × 200 I/O operations per second × 47,000 cycles per operation, resulting in a requirement for approximately 0.19 processor performance. Viewed another way, a Virtual I/O Server running on a single processor should be capable of supporting more than 150 disks doing 8096-byte random I/O operations.

Alternatively, if the Virtual I/O Server is sized for maximum bandwidth, the calculation results in a higher processor requirement. The difference is that maximum bandwidth assumes sequential I/O. Because disks are more efficient when they are performing large, sequential I/O operations than they are when performing small, random I/O operations, a higher number of I/O operations per second can be performed. Assume that the disks are capable of 50 MB per second when doing 128 KB I/O operations. That situation implies each disk could average 390 disk I/O operations per second. Thus, the amount of processing power necessary to support 32 disks, each doing 390 I/O operations per second with an operation cost of 120,000 cycles ($32 \times 390 \times 120,000 / 1,650,000,000$) results in approximately 0.91 processors. Consequently, a Virtual I/O Server running on a single processor should be capable of driving approximately 32 fast disks to maximum throughput.

Virtual SCSI server sizing using shared processor logical partitions

Defining virtual SCSI servers in shared processor logical partitions allows more specific processor resource sizing and potential recovery of unused processor time by uncapped logical partitions. However, using shared-processor logical partitions for virtual SCSI servers can frequently increase I/O response time and make for somewhat more complex processor entitlement sizings.

The sizing methodology should be based on the same operation costs for dedicated logical partition I/O servers, with added entitlement for running in shared-processor logical partitions. Configure the Virtual I/O Server as uncapped, so that, if the Virtual I/O Server is undersized, there is opportunity to get more processor time to serve I/O operations.

Because I/O latency with virtual SCSI can vary due to a number of conditions, consider the following if a logical partition has high I/O requirements:

- Configure the logical partition with physical I/O if the configuration allows.
- In most cases, the Virtual I/O Server logical partition can use a shared, uncapped processor.

Virtual SCSI server memory sizing

Memory sizing in virtual SCSI is simplified because there is no caching of file data in the memory of the virtual SCSI server. Because there is no data caching, the memory requirements for the virtual SCSI server are fairly modest. With large I/O configurations and very high data rates, a 1 GB memory allocation for the virtual SCSI server is likely to be sufficient. For low I/O rate situations with a small number of attached disks, 512 MB will most likely suffice.

Virtual SCSI maximum transfer size limitation

If you add another virtual target device to the virtual SCSI server adapter and the new virtual target device has a smaller maximum transfer size than the other configured devices on that adapter, the Virtual I/O Server does not show a new virtual device to the client. At the time the virtual target device is created, the Virtual I/O Server displays a message stating that the new target device will not be visible to the client until you reboot the client.

To display the maximum transfer size of a physical device, use the following command: `lsdev -attr max_transfer -dev hdiskN`

Planning for Shared Ethernet Adapters

Use this section to find capacity-planning and performance information for Shared Ethernet Adapter. This section contains planning information and performance considerations for using Shared Ethernet Adapters on the Virtual I/O Server.

Network requirements:

This topic includes information you need in order to accurately size your Shared Ethernet Adapter environment.

To plan for using Shared Ethernet Adapters, you must determine your network needs. This section gives overview information of what should be considered when sizing the Shared Ethernet Adapter environment. Sizing the Virtual I/O Server for the Shared Ethernet Adapter involves the following factors:

- Defining the target bandwidth (MB per second), or transaction rate requirements (operations per second). The target performance of the configuration must be determined from your workload requirements.
- Defining the type of workload (streaming or transaction oriented).
- Identifying the maximum transmission unit (MTU) size that will be used (1500 or jumbo frames).
- Determining if the Shared Ethernet Adapter will run in a threaded or nonthreaded environment.
- Knowing the throughput rates that various Ethernet adapters can provide (see Adapter selection).
- Knowing the processor cycles required per byte of throughput or per transaction (see Processor allocation).

Bandwidth requirement

The primary consideration is determining the target bandwidth on the physical Ethernet adapter of the Virtual I/O Server. This will determine the rate that data can be transferred between the Virtual I/O Server and the client logical partitions. After the target rate is known, the correct type and number of network adapters can be selected. For example, Ethernet adapters of various speeds could be used. One or more adapters could be used on individual networks, or they could be combined using Link Aggregation (or EtherChannel).

Workload type

The type of workload to be performed must be considered, whether it is streaming of data for workloads such as file transfer, data backup, or small transaction workloads, such as remote procedure calls. The streaming workload consists of large, full-sized network packets and associated small, TCP acknowledgment packets. Transaction workloads typically involve smaller packets or might involve small requests, such as a URL, and a larger response, such as a Web page. A Virtual I/O Server will need to frequently support streaming and small packet I/O during various periods of time. In that case, approach the sizing from both models.

MTU size

The MTU size of the network adapters must also be considered. The standard Ethernet MTU is 1500 bytes. Gigabit Ethernet and 10 gigabit Ethernet can support 9000-byte MTU jumbo frames. Jumbo frames might reduce the processor cycles for the streaming types of workloads. However, for small workloads, the larger MTU size might not help reduce processor cycles.

Threaded or nonthreaded environment

Use threaded mode when virtual Small Computer Serial Interface (SCSI) will be run on the same Virtual I/O Server logical partition as Shared Ethernet Adapter. Threaded mode helps ensure that virtual SCSI and the Shared Ethernet Adapter can share the processor resource appropriately. However, threading increases instruction-path length, which uses additional processor cycles. If the Virtual I/O Server logical partition will be dedicated to running shared Ethernet devices (and associated virtual Ethernet devices) only, the adapters should be configured with threading disabled. For more information, see “Processor allocation” on page 75.

Adapter throughput

Knowing the throughput capability of different Ethernet adapters can help you determine which adapters to use as Shared Ethernet Adapters and how many adapters to use. For more information, see “Adapter selection.”

Processor entitlement

You must determine how much processor power is required to move data through the adapters at the desired rate. Networking device drivers are typically processor-intensive. Small packets can come in at a faster rate and use more processor cycles than larger packet workloads. Larger packet workloads are typically limited by network wire bandwidth and come in at a slower rate, thus requiring less processor power than small packet workloads for the amount of data transferred.

Adapter selection:

Use this section to find the attributes and performance characteristics of various types of Ethernet adapters to help you select which adapters to use in your environment.

This section provides approximate throughput rates for various Ethernet adapters set at various MTU sizes. Use this information to determine which adapters will be needed to configure a Virtual I/O Server. To make this determination, you must know the desired throughput rate of the client logical partitions.

Following are general guidelines for network throughput. These numbers are not specific, but they can serve as a general guideline for sizing. In the following tables, the 100 MB, 1 GB, and 10 GB speeds are rounded down for estimating.

Table 23. Simplex (one direction) streaming rates

| Adapter speed | Approximate throughput rate |
|--|-----------------------------|
| 10 Mb Ethernet | 1 MB/second |
| 100 Mb Ethernet | 10 MB/second |
| 1000 Mb Ethernet (GB Ethernet) | 100 MB/second |
| 10000 Mb Ethernet (10 GB Ethernet, Host Ethernet Adapter or Integrated Virtual Ethernet) | 1000 MB/second |

Table 24. Full duplex (two direction) streaming rates on full duplex network

| Adapter speed | Approximate throughput rate |
|--|-----------------------------|
| 10 Mb Ethernet | 2 MB/second |
| 100 Mb Ethernet | 20 MB/second |
| 1000 Mb Ethernet (Gb Ethernet) | 150 MB/second |
| 10000 Mb Ethernet (10 Gb Ethernet, Host Ethernet Adapter or Integrated Virtual Ethernet) | 1500 MB/second |

The following tables list maximum network payload speeds, which are user payload data rates that can be obtained by sockets-based programs for applications that are streaming data. The rates are a result of the network bit rate, MTU size, physical level overhead (such as interframe gaps and preamble bits), data link headers, and TCP/IP headers. A gigahertz-speed processor is assumed. These numbers are optimal for a single LAN. If your network traffic is going through additional network devices, your results might vary.

In the following tables, raw bit rate is the physical media bit rate and does not reflect interframe gaps, preamble bits, data link headers, and trailers. Interframe gaps, preamble bits, data link headers, and trailers can all reduce the effective usable bit rate of the wire.

Single direction (simplex) TCP streaming rates are rates that can be achieved by sending data from one machine to another in a memory-to-memory test. Full-duplex media can usually perform slightly better than half-duplex media because the TCP acknowledgment packets can flow without contending for the same wire that the data packets are flowing on.

Table 25. Single direction (simplex) TCP streaming rates

| Network type | Raw bit rate (Mb) | Payload rate (Mb) | Payload rate (MB) |
|---|----------------------------|-------------------|-------------------|
| 10 Mb Ethernet, Half Duplex | 10 | 6 | 0.7 |
| 10 Mb Ethernet, Full Duplex | 10 (20 Mb full duplex) | 9.48 | 1.13 |
| 100 Mb Ethernet, Half Duplex | 100 | 62 | 7.3 |
| 100 Mb Ethernet, Full Duplex | 100 (200 Mb full duplex) | 94.8 | 11.3 |
| 1000 Mb Ethernet, Full Duplex, MTU 1500 | 1000 (2000 Mb full duplex) | 948 | 113 |
| 1000 Mb Ethernet, Full Duplex, MTU 9000 | 1000 (2000 Mb full duplex) | 989 | 117.9 |
| 10000 Mb Ethernet, Full Duplex, Host Ethernet Adapter (or Integrated Virtual Ethernet) MTU 1500 | 10000 | 9479 | 1130 |
| 10000 Mb Ethernet, Full Duplex, Host Ethernet Adapter (or Integrated Virtual Ethernet) MTU 9000 | 10000 | 9899 | 1180 |

Full-duplex TCP streaming workloads have data streaming in both directions. Workloads that can send and receive packets concurrently can take advantage of full duplex media. Some media, for example Ethernet in half-duplex mode, cannot send and receive concurrently, thus they will not perform any better, and can usually degrade performance, when running duplex workloads. Duplex workloads will not increase at a full doubling of the rate of a simplex workload because the TCP acknowledgment packets returning from the receiver must now compete with data packets flowing in the same direction.

Table 26. Two direction (duplex) TCP streaming rates

| Network type | Raw bit rate (Mb) | Payload rate (Mb) | Payload rate (MB) |
|---|----------------------------|-------------------|-------------------|
| 10 Mb Ethernet, Half Duplex | 10 | 5.8 | 0.7 |
| 10 Mb Ethernet, Full Duplex | 10 (20 Mb full duplex) | 18 | 2.2 |
| 100 Mb Ethernet, Half Duplex | 100 | 58 | 7 |
| 100 Mb Ethernet, Full Duplex | 100 (200 Mb full duplex) | 177 | 21.1 |
| 1000 Mb Ethernet, Full Duplex, MTU 1500 | 1000 (2000 Mb full duplex) | 1470 (1660 peak) | 175 (198 peak) |

Table 26. Two direction (duplex) TCP streaming rates (continued)

| Network type | Raw bit rate (Mb) | Payload rate (Mb) | Payload rate (MB) |
|---|----------------------------|--------------------|-------------------|
| 1000 Mb Ethernet, Full Duplex, MTU 9000 | 1000 (2000 Mb full duplex) | 1680 (1938 peak) | 200 (231 peak) |
| 10000 Mb Ethernet, Host Ethernet Adapter (or Integrated Virtual Ethernet) Full Duplex, MTU 1500 | 10000 | 14680 (15099 peak) | 1750 (1800 peak) |
| 10000 Mb Ethernet, Host Ethernet Adapter (or Integrated Virtual Ethernet) Full Duplex, MTU 9000 | 10000 | 16777 (19293 pack) | 2000 (2300 peak) |

Notes:

1. Peak numbers represent optimal throughput with multiple TCP sessions running in each direction. Other rates are for a single TCP session.
2. 1000 MB Ethernet (gigabit Ethernet) duplex rates are for the PCI-X adapter in PCI-X slots.
3. Data rates are for TCP/IP using the IPv4 protocol. Adapters with MTU set to 9000 have RFC 1323 enabled.

Processor allocation:

This section contains processor-allocation guidelines for both dedicated processor logical partitions and shared processor logical partitions.

Because Ethernet running MTU size of 1500 bytes consumes more processor cycles than Ethernet running Jumbo frames (MTU 9000), the guidelines are different for each situation. In general, the processor utilization for large packet workloads on jumbo frames is approximately half that required for MTU 1500.

If MTU is set to 1500, provide one processor (1.65 Ghz) per Gigabit Ethernet adapter to help reach maximum bandwidth. This equals ten 100-Mb Ethernet adapters if you are using smaller networks. For smaller transaction workloads, plan to use one full processor to drive the Gigabit Ethernet workload to maximum throughput. For example, if two Gigabit Ethernet adapters will be used, allocate up to two processors to the logical partition.

If MTU is set to 9000 (jumbo frames), provide 50% of one processor (1.65 Ghz) per Gigabit Ethernet adapter to reach maximum bandwidth. Small packet workloads should plan to use one full processor to drive the Gigabit Ethernet workload. Jumbo frames have no effect on the small packet workload case.

Shared Ethernet Adapter using a dedicated processor logical partition

The sizing provided is divided into two workload types: TCP streaming and TCP request and response. Both MTU 1500 and MTU 9000 networks were used in the sizing, which is provided in terms of machine cycles per byte of throughput for streaming or per transaction for request/response workloads.

The data in the following tables was derived using the following formula:

$$(\text{number of processors} \times \text{processor_utilization} \times \text{processor clock frequency}) / \text{Throughput rate in bytes per second or transaction per second} = \text{cycles per Byte or transaction.}$$

For the purposes of this test, the numbers were measured on a logical partition with one 1.65 Ghz processor with simultaneous multi-threading (SMT) enabled.

For other processor frequencies, the numbers in these tables can be scaled by the ratio of the processor frequencies for approximate values to be used for sizing. For example, for a 1.5 Ghz processor speed, use $1.65/1.5 \times$ cycles per byte value from the table. This example would result in a value of 1.1 times the value in the table, thus requiring 10% more cycles to adjust for the 10% slower clock rate of the 1.5 Ghz processor.

To use these values, multiply your required throughput rate (in bytes or transactions) by the cycles per byte value in the following tables. This result will give you the required machine cycles for the workload for a 1.65 Ghz speed. Then adjust this value by the ratio of the actual machine speed to this 1.65 Ghz speed. To find the number of processors, divide the result by 1,650,000,000 cycles (or the cycles rate if you adjusted to a different speed machine). You would need the resulting number of processors to drive the workload.

For example, if the Virtual I/O Server must deliver 200 MB of streaming throughput, the following formula would be used:

$$200 \times 1024 \times 1024 \times 11.2 = 2,348,810,240 \text{ cycles} / 1,650,000,000 \text{ cycles per processor} = 1.42 \text{ processors.}$$

In round numbers, it would require 1.5 processors in the Virtual I/O Server to handle this workload. Such a workload can then be handled by either a logical partition using two dedicated processors or by a logical partition using 1.5-processor shared processors.

The following tables show the machine cycles per byte for a TCP-streaming workload.

Table 27. Shared Ethernet with threading option enabled

| Type of Streaming | MTU 1500 rate and processor utilization | MTU 1500, cycles per byte | MTU 9000 rate and processor utilization | MTU 9000, cycles per byte |
|-------------------|---|---------------------------|---|---------------------------|
| Simplex | 112.8 MB at 80.6% processor | 11.2 | 117.8 MB at 37.7% processor | 5 |
| Duplex | 162.2 MB at 88.8% processor | 8.6 | 217 MB at 52.5% processor | 3.8 |

Table 28. Shared Ethernet with threading option disabled

| Type of Streaming | MTU 1500 rate and processor utilization | MTU 1500, cycles per byte | MTU 9000 rate and processor utilization | MTU 9000, cycles per byte |
|-------------------|---|---------------------------|---|---------------------------|
| Simplex | 112.8 MB at 66.4% processor | 9.3 | 117.8 MB at 26.7% processor | 3.6 |
| Duplex | 161.6 MB at 76.4% processor | 7.4 | 216.8 MB at 39.6% processor | 2.9 |

The following tables show the machine cycles per transaction for a request and response workload. A transaction is defined as a round-trip request and reply size.

Table 29. Shared Ethernet with threading option enabled

| Size of transaction | Transactions per second and Virtual I/O Server utilization | MTU 1500 or 9000, cycles per transaction |
|----------------------------|--|--|
| Small packets (64 bytes) | 59,722 TPS at 83.4% processor | 23,022 |
| Large packets (1024 bytes) | 51,956 TPS at 80% processor | 25,406 |

Table 30. Shared Ethernet with threading option disabled

| Size of transaction | Transactions per second and Virtual I/O Server utilization | MTU 1500 or 9000, cycles per transaction |
|----------------------------|--|--|
| Small packets (64 bytes) | 60,249 TPS at 65.6% processor | 17,956 |
| Large packets (1024 bytes) | 53,104 TPS at 65% processor | 20,196 |

The preceding tables demonstrate that the threading option of the shared Ethernet adds approximately 16% – 20% more machine cycles per transaction for MTU 1500 streaming, and approximately 31% – 38% more machine cycles per transaction for MTU 9000. The threading option adds more machine cycles per transaction at lower workloads due to the threads being started for each packet. At higher workload rates, like full duplex or the request and response workloads, the threads can run longer without waiting and being redispached. You can configure the thread option for each shared Ethernet adapter by using the Virtual I/O Server commands. Disable the thread option if the shared Ethernet is running in a Virtual I/O Server logical partition by itself (without virtual Small Computer Serial Interface (SCSI) in the same logical partition).

You can enable or disable threading using the **-attr thread** option of the **mkvdev** command. To enable threading, use the **-attr thread=1** option. To disable threading, use the **-attr thread=0** option. For example, the following command disables threading for Shared Ethernet Adapter ent1:

```
mkvdev -sea ent1 -vadapter ent5 -default ent5 -defaultid 1 -attr thread=0
```

Sizing a Virtual I/O Server for shared Ethernet on a shared processor logical partition

Creating a shared-processor logical partition for a Virtual I/O Server can be done if the Virtual I/O Server is running slower-speed networks (for example 10/100 Mb) and a full processor logical partition is not needed. It is recommended that this be done only if the Virtual I/O Server workload is less than half a processor or if the workload is inconsistent. Configuring the Virtual I/O Server logical partition as uncapped might also allow it to use more processor cycles as needed to handle inconsistent throughput. For example, if the network is used only when other processors are idle, the Virtual I/O Server logical partition might be able to use other machine cycles and could be created with minimal processor to handle light workload during the day but the uncapped processor could use more machine cycles at night.

If you are creating a Virtual I/O Server in a shared-processor logical partition, add additional entitled processors as a sizing contingency.

Memory allocation:

Find information about memory allocation and sizing.

In general, 512 MB of memory per logical partition is sufficient for most configurations. Enough memory must be allocated for the Virtual I/O Server data structures. Ethernet adapters and virtual devices use dedicated receive buffers. These buffers are used to store the incoming packets, which are then sent over the outgoing device.

A physical Ethernet adapter typically uses 4 MB for MTU 1500 or 16 MB for MTU 9000 for dedicated receive buffers for gigabit Ethernet. Other Ethernet adapters are similar. Virtual Ethernet, typically uses 6 MB for dedicated receive buffers. However, this number can vary based on workload. Each instance of a physical or virtual Ethernet would need memory for this number of buffers. In addition, the system has an mbuf buffer pool per processor that is used if additional buffers are needed. These mbufs typically occupy 40 MB.

Configuration requirements for shared memory

Review the requirements for the system, Virtual I/O Server (VIOS), logical partitions, and paging space devices so that you can successfully configure shared memory.

System requirements

- The server must be a POWER6 processor-based server, or later.
- The server firmware must be at release 3.4.2, or later.
- The Hardware Management Console (HMC) must be at version 7 release 3.4.2, or later.
- The Integrated Virtualization Manager must be at version 2.1.1, or later.
- The PowerVM Active Memory Sharing technology must be activated. The PowerVM Active Memory Sharing technology is available with the PowerVM Enterprise Edition for which you must obtain and enter a PowerVM Editions activation code.

Paging VIOS partition requirements

- VIOS partitions that provide access to the paging space devices for the shared memory partitions that are assigned to the shared memory pool (hereafter referred to as *paging VIOS partitions*) cannot use shared memory. Paging VIOS partitions must use dedicated memory.
- Paging VIOS partitions must be at version 2.1.1, or later.
- On IVM-managed systems, all logical partitions that use shared memory (hereafter referred to as *shared memory partitions*) must use virtual resources provided by the management partition.
- On HMC-managed systems, consider configuring separate VIOS partitions as server partitions and paging VIOS partitions. For example, configure one VIOS partition to provide virtual resources to the shared memory partitions. Then, configure another VIOS partition as a paging VIOS partition.
- On HMC-managed systems, you can configure multiple VIOS partitions to provide access to paging space devices. However, you can only assign up to two of those VIOS partitions to the shared memory pool at any given time.

Requirements for shared memory partitions

- Shared memory partitions must use shared processors.
- You can assign only virtual adapters to shared memory partitions. This means that you can dynamically add only virtual adapters to shared memory partitions. More specifically, the following table lists the virtual adapters that you can assign shared memory partitions.

Table 31. Virtual adapters that you can assign to shared memory partitions

| AIX and Linux shared memory partitions | shared memory partitions |
|--|---|
| <ul style="list-style-type: none">• Virtual SCSI client adapters• Virtual Ethernet adapters• Virtual fibre channel client adapters• Virtual serial adapters | <ul style="list-style-type: none">• Virtual SCSI client adapters• Virtual Ethernet adapters• Virtual fibre channel client adapters• Virtual serial server adapters |

Table 32. Virtual adapters that you can assign to shared memory partitions

| Linux shared memory partitions |
|--|
| <ul style="list-style-type: none">• Virtual SCSI client adapters• Virtual Ethernet adapters• Virtual fibre channel client adapters• Virtual serial adapters |

You cannot assign Host Ethernet Adapters (HEA) or host connection adapters (HCA) to shared memory partitions.

- Shared memory partitions cannot use the barrier synchronization register.

- Shared memory partitions cannot use huge pages.
- AIX must be at version 6.1 Technology Level 3, or later, to run in a shared memory partition.
- SUSE Linux Enterprise Server must be at version 11, or later, to run in a shared memory partition.
- Red Hat Enterprise Server Version 6, or later, to run in a shared memory partition

Requirements for paging space devices

- The paging space devices for AIX or Linux shared memory partitions must be at least the size of the maximum logical memory of the shared memory partition.
- Paging space devices can only be assigned to one shared memory pool at a time. You cannot assign the same paging space device to a shared memory pool on one system and to another shared memory pool on another system at the same time.
- Paging space devices that are accessed by a single paging VIOS partition must meet the following requirements:
 - They can be physical or logical volumes.
 - They can be located in physical storage on the server or on a storage area network (SAN).
- Paging space devices that are accessed redundantly by two paging VIOS partitions must meet the following requirements:
 - They must be physical volumes.
 - They must be located on a SAN.
 - They must be configured with global IDs.
 - They must be accessible to both paging VIOS partitions.
 - The reserve attribute must be set to no reserve. (The VIOS automatically sets the reserve attribute to no reserve when you add the paging space device to the shared memory pool.)
- Physical volumes that are configured as paging space devices cannot belong to a volume group, such as the rootvg volume group.
- Logical volumes that are configured as paging space devices must be located in a volume group that is dedicated for paging space devices.
- Paging space devices must be available. You cannot use the physical volume or logical volume as a paging space device if it is already configured as a paging space device or virtual disk for another logical partition.
- Paging space devices cannot be used to boot a logical partition.
- After you assign a paging space device to the shared memory pool, you must manage the device by using one of the following tools:
 - The Create/Modify Shared Memory Pool wizard on the HMC.
 - The View/Modify Shared Memory Pool page on the Integrated Virtualization Manager.

Do not change or remove the device using other management tools.
- On logical partitions with the Suspend/Resume feature, paging space devices are used to save suspension data for logical partitions that are configured to use shared memory. The paging space device size must be a minimum of 110% of the maximum memory of the logical partition.

Redundancy considerations

Redundancy options are available at several levels in the virtual I/O environment. Multipathing, mirroring, and RAID redundancy options exist for the Virtual I/O Server and some client logical partitions. Ethernet Link Aggregation (also called EtherChannel) is also an option for the client logical partitions, and the Virtual I/O Server provides Shared Ethernet Adapter failover. There is also support for node failover (PowerHA[®] SystemMirror) for nodes using virtual I/O resources.

This section contains information about redundancy for both the client logical partitions and the Virtual I/O Server. While these configurations help protect from the failure of one of the physical components,

such as a disk or network adapter, they might cause the client logical partition to lose access to its devices if the Virtual I/O Server fails. The Virtual I/O Server can be made redundant by running a second instance of it in another logical partition. When running two instances of the Virtual I/O Server, you can use LVM mirroring, multipath I/O, network interface backup, or multipath routing with dead gateway detection in the client logical partition to provide highly available access to virtual resources hosted in separate Virtual I/O Server logical partitions.

Client logical partitions

This topic includes redundancy considerations for client logical partitions. MPIO, PowerHA SystemMirror, and mirroring for the client logical partition are discussed.

Multipath I/O:

View Multipath I/O (MPIO) information for client logical partitions.

Multiple virtual Small Computer Serial Interface (SCSI) or virtual Fibre Channel adapters in a client logical partition can access the same disk through multiple Virtual I/O Server logical partitions. This section describes a virtual SCSI multipath device configuration. If correctly configured, the client recognizes the disk as a multipath device. If you are using PowerVM Active Memory Sharing technology (or shared memory) or the Suspend/Resume feature, you can also use a multipath configuration to enable two paging VIOS logical partitions to access common paging space devices.

Not all virtual SCSI devices are capable of MPIO. To create an MPIO configuration, the exported device at the Virtual I/O Server must conform to the following rules:

- The device must be backed by a physical volume. Logical volume-backed virtual SCSI devices are not supported in an MPIO configuration.
- The device must be accessible from multiple Virtual I/O Server logical partitions.
- The device must be an MPIO-capable device.

Note: MPIO-capable devices are those that contain a unique identifier (UDID) or IEEE volume identifier. For instructions about how to determine whether disks have a UDID or IEEE volume identifier, see “Identifying exportable disks” on page 113.

When setting up an MPIO configuration for virtual SCSI devices on the client logical partition, you must consider the reservation policy of the device on the Virtual I/O Server. To use an MPIO configuration at the client, none of the virtual SCSI devices on the Virtual I/O Server can be reserving the virtual SCSI device. Ensure the `reserve_policy` attribute of the device is set to `no_reserve`.

Failover is the only supported behavior for MPIO virtual SCSI disks on the client logical partition.

Related tasks:

“Setting the reserve policy attributes of a device” on page 108

In some configurations, you must consider the reservation policy of the device on the Virtual I/O Server (VIOS).

“Scenario: Configuring Multi-Path I/O for AIX client logical partitions” on page 62

Multi-Path I/O (MPIO) helps provide increased availability of virtual Small Computer Serial Interface (SCSI) resources by providing redundant paths to the resource. This topic describes how to set up Multi-Path I/O for AIX client logical partitions.

Related reference:

“Configuration requirements for shared memory” on page 78

Review the requirements for the system, Virtual I/O Server (VIOS), logical partitions, and paging space devices so that you can successfully configure shared memory.

Mirroring for client logical partitions:

Achieve mirroring for client logical partitions by using two virtual Small Computer Serial Interface (SCSI) adapters.

The client partition can mirror its logical volumes using two virtual SCSI client adapters. Each of these adapters should be assigned to separate Virtual I/O Server partitions. The two physical disks are each attached to a separate Virtual I/O Server partition and made available to the client partition through a virtual SCSI server adapter. This configuration protects virtual disks in a client partition against the failure of any of the following:

- One physical disk
- One physical adapter
- One Virtual I/O Server

The performance of your system might be impacted when using a RAID 1 configuration.

PowerHA SystemMirror in the Virtual I/O Server:

Learn about PowerHA SystemMirror in the Virtual I/O Server.

PowerHA SystemMirror and virtual SCSI

Be aware of the following considerations when implementing PowerHA SystemMirror and virtual SCSI:

- The volume group must be defined as Enhanced Concurrent Mode. Enhanced Concurrent Mode is the preferred mode for sharing volume groups in PowerHA SystemMirror clusters because volumes are accessible by multiple PowerHA SystemMirror nodes. If file systems are used on the standby nodes, those file systems are not mounted until the point of failover. If shared volumes are accessed directly (without file systems) in Enhanced Concurrent Mode, these volumes are accessible from multiple nodes, and as a result, access must be controlled at a higher layer.
- If any one cluster node accesses shared volumes through virtual SCSI, then all nodes must. This means that disks cannot be shared between a logical partition using virtual SCSI and a node directly accessing those disks.
- All volume group configuration and maintenance on these shared disks is done from the PowerHA SystemMirror nodes, not from the Virtual I/O Server.

PowerHA SystemMirror and virtual Ethernet

Be aware of the following considerations when implementing PowerHA SystemMirror and virtual Ethernet:

- IP Address Takeover (IPAT) by way of aliasing must be used. IPAT by way of Replacement and MAC Address Takeover are not supported.
- Avoid using the PowerHA SystemMirror PCI Hot Plug facility in a Virtual I/O Server environment. PCI Hot Plug operations are available through the Virtual I/O Server. When an PowerHA SystemMirror node is using virtual I/O, the PowerHA SystemMirror PCI Hot Plug facility is not meaningful because the I/O adapters are virtual rather than physical.
- All virtual Ethernet interfaces defined to PowerHA SystemMirror should be treated as single-adapter networks. In particular, you must use the **ping_client_list** attribute to monitor and detect failure of the network interfaces.
- If the Virtual I/O Server has multiple physical interfaces on the same network, or if there are two or more PowerHA SystemMirror nodes using the Virtual I/O Server in the same frame, PowerHA SystemMirror is not informed of, and does not react to, single physical interface failures. This does not limit the availability of the entire cluster because the Virtual I/O Server routes traffic around the failure.

- If the Virtual I/O Server has only a single physical interface on a network, failure of that physical interface is detected by PowerHA SystemMirror. However, that failure isolates the node from the network.

Link Aggregation or EtherChannel devices:

A Link Aggregation, or EtherChannel, device is a network port-aggregation technology that allows several Ethernet adapters to be aggregated. The adapters can then act as a single Ethernet device. Link Aggregation helps provide more throughput over a single IP address than would be possible with a single Ethernet adapter.

For example, `ent0` and `ent1` can be aggregated to `ent3`. The system considers these aggregated adapters as one adapter, and all adapters in the Link Aggregation device are given the same hardware address, so they are treated by remote systems as if they are one adapter.

Link Aggregation can help provide more redundancy because individual links might fail, and the Link Aggregation device will fail over to another adapter in the device to maintain connectivity. For example, in the previous example, if `ent0` fails, the packets are automatically sent on the next available adapter, `ent1`, without disruption to existing user connections. `ent0` automatically returns to service on the Link Aggregation device when it recovers.

You can configure a Shared Ethernet Adapter to use a Link Aggregation, or EtherChannel, device as the physical adapter.

Shared Ethernet Adapter failover:

Shared Ethernet Adapter failover provides redundancy by configuring a backup Shared Ethernet Adapter on a different Virtual I/O Server logical partition that can be used if the primary Shared Ethernet Adapter fails. The network connectivity in the client logical partitions continues without disruption.

A Shared Ethernet Adapter is comprised of a physical adapter (or several physical adapters grouped under a Link Aggregation device) and one or more virtual Ethernet adapters. It can provide layer 2 connectivity to multiple client logical partitions through the virtual Ethernet adapters.

The Shared Ethernet Adapter failover configuration uses the priority value given to the virtual Ethernet adapters during their creation to determine which Shared Ethernet Adapter will serve as the primary and which will serve as the backup. The Shared Ethernet Adapter that has the virtual Ethernet configured with the numerically lower priority value will be used preferentially as the primary adapter. For the purpose of communicating between themselves to determine when a failover should take place, Shared Ethernet Adapters in failover mode use a VLAN dedicated for such traffic, called the *control channel*. For this reason, a virtual Ethernet (created with a PVID that is unique on the system) must be specified as the control channel virtual Ethernet when each Shared Ethernet Adapter is created in failover mode. Using the control channel, the backup Shared Ethernet Adapter is notified when the primary adapter fails, and network traffic from the client logical partitions is sent over the backup adapter. If and when the primary Shared Ethernet Adapter recovers from its failure, it again begins actively bridging all network traffic.

A Shared Ethernet Adapter in failover mode might optionally have more than one trunk virtual Ethernet. In this case, all the virtual Ethernet adapters in a Shared Ethernet Adapter must have the same priority value. Also, the virtual Ethernet adapter used specifically for the control channel does not need to have the trunk adapter setting enabled. The virtual Ethernet adapters used for the control channel on each Shared Ethernet Adapter in failover mode must have an identical PVID value, and that PVID value must be unique in the system, so that no other virtual Ethernet adapters on the same system are using that PVID.

To ensure prompt recovery times, when you enable the Spanning Tree Protocol on the switch ports connected to the physical adapters of the Shared Ethernet Adapter, you can also enable the portfast

option on those ports. The portfast option allows the switch to immediately forward packets on the port without first completing the Spanning Tree Protocol. (Spanning Tree Protocol blocks the port completely until it is finished.)

The Shared Ethernet Adapter is designed to prevent network loops. However, as an additional precaution, you can enable Bridge Protocol Data Unit (BPDU) Guard on the switch ports connected to the physical adapters of the Shared Ethernet Adapter. BPDU Guard detects looped Spanning Tree Protocol BPDU packets and shuts down the port. This helps prevent broadcast storms on the network. A *broadcast storm* is a situation where one message that is broadcast across a network results in multiple responses. Each response generates more responses, causing excessive transmission of broadcast messages. Severe broadcast storms can block all other network traffic, but they can usually be prevented by carefully configuring a network to block illegal broadcast messages.

Note: When the Shared Ethernet Adapter is using GARP VLAN Registration Protocol (GVRP), it generates BPDU packets, which causes BPDU Guard to shut down the port unnecessarily. Therefore, when the Shared Ethernet Adapter is using GVRP, do not enable BPDU Guard.

For information about how to enable the Spanning Tree Protocol, the portfast option, and BPDU Guard on the ports, see the documentation provided with the switch.

Related tasks:

“Scenario: Configuring Shared Ethernet Adapter failover” on page 56

Use this scenario to help you to configure primary and backup Shared Ethernet Adapters in the Virtual I/O Server logical partitions.

Shared Ethernet Adapters for load sharing:

Learn about configuring Shared Ethernet Adapters with load sharing to share the workload between the primary and backup Shared Ethernet Adapter.

The Shared Ethernet Adapter failover configuration provides redundancy only by configuring a backup Shared Ethernet Adapter on a different Virtual I/O Server (VIOS) logical partition. This backup Shared Ethernet Adapter is in the standby mode and can be used only if the primary Shared Ethernet Adapter fails. Hence, the bandwidth of the backup Shared Ethernet Adapter is not used.

On the VIOS Version 2.2.1.0, or later, you can use the Shared Ethernet Adapter failover with load sharing configuration to use the bandwidth of the backup Shared Ethernet Adapter without any impact to reliability.

In the Shared Ethernet Adapter failover with load sharing configuration, the primary and the backup Shared Ethernet Adapters negotiate the set of virtual local area network (VLAN) IDs that they are responsible for bridging. After successful negotiation, each Shared Ethernet Adapter bridges the assigned trunk adapters and the associated VLANs. Thus, both the primary and the backup Shared Ethernet Adapter bridge the workload for their respective VLANs. If a failure occurs, the active Shared Ethernet Adapter bridges all trunk adapters and the associated VLANs. This action helps to avoid disruption in network services. You can restart load sharing by running the **chdev** command on the backup Shared Ethernet Adapter. For more information, see **chdev** command.

To configure Shared Ethernet Adapter failover with load sharing, you must have two or more trunk adapters with identical VLAN definitions assigned to each Shared Ethernet Adapter. To make optimum use of the Shared Ethernet Adapter failover with load sharing configuration, design the workload so that it is equally distributed among trunk adapters.

Virtual I/O Server logical partition

Redundancy options for the Virtual I/O Server include multi-pathing, Redundant Array of Independent Disks (RAID) configurations, and Link Aggregation (or EtherChannel).

Multipathing:

Multipathing for the physical storage within the Virtual I/O Server provides failover physical path redundancy and load-balancing. The multipathing solutions available in the Virtual I/O Server include MPIO as well as solutions provided by the storage vendors.

RAID:

Redundant Array of Independent Disks (RAID) solutions provide for device level redundancy within the Virtual I/O Server. Some RAID options, such as LVM mirroring and striping, are provided by the Virtual I/O Server software, while other RAID options are made available by the physical storage subsystem.

Link Aggregation or EtherChannel devices:

A Link Aggregation, or EtherChannel, device is a network port-aggregation technology that allows several Ethernet adapters to be aggregated. The adapters can then act as a single Ethernet device. Link Aggregation helps provide more throughput over a single IP address than would be possible with a single Ethernet adapter.

For example, `ent0` and `ent1` can be aggregated to `ent3`. The system considers these aggregated adapters as one adapter, and all adapters in the Link Aggregation device are given the same hardware address, so they are treated by remote systems as if they are one adapter.

Link Aggregation can help provide more redundancy because individual links might fail, and the Link Aggregation device will fail over to another adapter in the device to maintain connectivity. For example, in the previous example, if `ent0` fails, the packets are automatically sent on the next available adapter, `ent1`, without disruption to existing user connections. `ent0` automatically returns to service on the Link Aggregation device when it recovers.

You can configure a Shared Ethernet Adapter to use a Link Aggregation, or EtherChannel, device as the physical adapter.

Redundancy configuration using virtual Fibre Channel adapters

Redundancy configurations help protect your network from physical adapter failures as well as Virtual I/O Server failures.

With N_Port ID Virtualization (NPIV), you can configure the managed system so that multiple logical partitions can access independent physical storage through the same physical Fibre Channel adapter. Each virtual Fibre Channel adapter is identified by a unique worldwide port name (WWPN), which means that you can connect each virtual Fibre Channel adapter to independent physical storage on a SAN.

Similar to virtual Small Computer Serial Interface (SCSI) redundancy, virtual Fibre Channel redundancy can be achieved using Multi-path I/O (MPIO) and mirroring at the client partition. The difference between traditional redundancy with SCSI adapters and the NPIV technology using virtual Fibre Channel adapters, is that the redundancy occurs on the client, because only the client recognizes the disk. The Virtual I/O Server is essentially just a pipe. The second example below uses multiple Virtual I/O Server logical partitions to add redundancy at the Virtual I/O Server level as well.

Example: Host bus adapter failover

This example uses Host bus adapter (HBA) failover to provide a basic level of redundancy for the client logical partition. The figure shows the following connections:

- The storage area network (SAN) connects physical storage to two physical Fibre Channel adapters located on the managed system.
- The physical Fibre Channel adapters are assigned to the Virtual I/O Server and support NPIV.

- The physical Fibre Channel ports are each connected to a virtual Fibre Channel adapter on the Virtual I/O Server. The two virtual Fibre Channel adapters on the Virtual I/O Server are connected to ports on two different physical Fibre Channel adapters in order to provide redundancy for the physical adapters.
- Each virtual Fibre Channel adapter on the Virtual I/O Server is connected to one virtual Fibre Channel adapter on a client logical partition. Each virtual Fibre Channel adapter on each client logical partition receives a pair of unique WWPNs. The client logical partition uses one WWPN to log into the SAN at any given time. The other WWPN is used when you move the client logical partition to another managed system.

The virtual Fibre Channel adapters always has a one-to-one relationship between the client logical partitions and the virtual Fibre Channel adapters on the Virtual I/O Server logical partition. That is, each virtual Fibre Channel adapter that is assigned to a client logical partition must connect to only one virtual Fibre Channel adapter on the Virtual I/O Server, and each virtual Fibre Channel on the Virtual I/O Server must connect to only one virtual Fibre Channel adapter on a client logical partition.

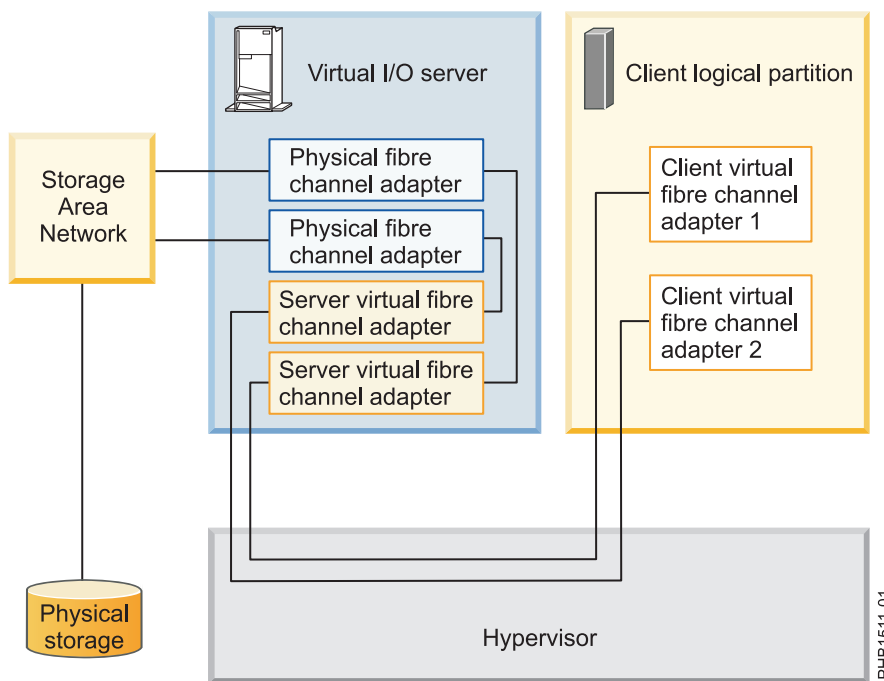

The client can write to the physical storage through client virtual Fibre Channel adapter 1 or 2. If a physical Fibre Channel adapter fails, the client uses the alternative path. This example does not show redundancy in the physical storage, but rather assumes it would be built into the SAN.

Note: It is recommended that you configure virtual Fibre Channel adapters from multiple logical partitions to the same HBA, or you configure virtual Fibre Channel adapters from the same logical partition to different HBAs.

Example: HBA and Virtual I/O Server failover

This example uses HBA and Virtual I/O Server failover to provide a more advanced level of redundancy for the client logical partition. The figure shows the following connections:

- The storage area network (SAN) connects physical storage to two physical Fibre Channel adapters located on the managed system.
- There are two Virtual I/O Server logical partitions to provide redundancy at the Virtual I/O Server level.

- The physical Fibre Channel adapters are assigned to their respective Virtual I/O Server and support NPIV.
- The physical Fibre Channel ports are each connected to a virtual Fibre Channel adapter on the Virtual I/O Server. The two virtual Fibre Channel adapters on the Virtual I/O Server are connected to ports on two different physical Fibre Channel adapters in order to provide redundancy for the physical adapters. A single adapter could have multiple ports.
- Each virtual Fibre Channel adapter on the Virtual I/O Server is connected to one virtual Fibre Channel adapter on a client logical partition. Each virtual Fibre Channel adapter on each client logical partition receives a pair of unique WWPNs. The client logical partition uses one WWPN to log into the SAN at any given time. The other WWPN is used when you move the client logical partition to another managed system.

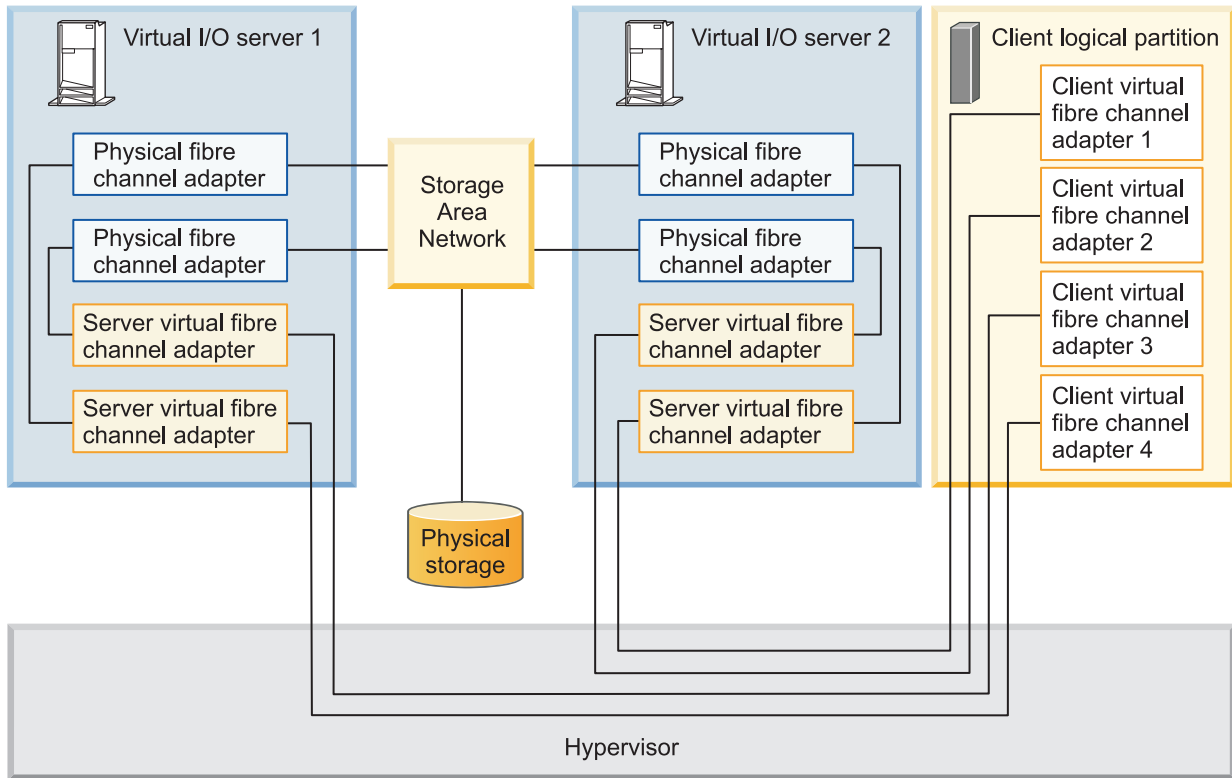

The client can write to the physical storage through virtual Fibre Channel adapter 1 or 2 on the client logical partition through VIOS 2. The client can also write to physical storage through virtual Fibre Channel adapter 3 or 4 on the client logical partition through VIOS 1. If a physical Fibre Channel adapter fails on VIOS 1, the client uses the other physical adapter connected to VIOS 1 or uses the paths connected through VIOS 2. If VIOS 1 fails, then the client uses the path through VIOS 2. This example does not show redundancy in the physical storage, but rather assumes it would be built into the SAN.

Considerations

These examples can become more complex as you add physical storage redundancy and multiple clients, but the concepts remain the same. Consider the following points:

- To avoid configuring the physical Fibre Channel adapter to be a single point of failure for the connection between the client logical partition and its physical storage on the SAN, do not connect two virtual Fibre Channel adapters from the same client logical partition to the same physical Fibre Channel adapter. Instead, connect each virtual Fibre Channel adapter to a different physical Fibre Channel adapter.

- Consider load balancing when mapping a virtual Fibre Channel adapter on the Virtual I/O Server to a physical port on the physical Fibre Channel adapter.
- Consider what level of redundancy already exists in the SAN to determine whether to configure multiple physical storage units.
- Consider using two Virtual I/O Server logical partitions. Since the Virtual I/O Server is central to communication between logical partitions and the external network, it is important to provide a level of redundancy for the Virtual I/O Server. Multiple Virtual I/O Server logical partitions require more resources as well, so you should plan accordingly.
- NPIV technology is useful when you want to move logical partitions between servers. For example, in active partition mobility, if you use the redundancy configurations above, in combination with physical adapters, you can stop all the I/O activity through the dedicated, physical adapter and direct all traffic through a virtual Fibre Channel adapter until the logical partition is successfully moved. The dedicated physical adapter would need to be connected to the same storage as the virtual path. Since you cannot migrate a physical adapter, all I/O activity is routed through the virtual path while you move the partition. After the logical partition is moved successfully, you need to set up the dedicated path (on the destination logical partition) if you want to use the same redundancy configuration you had configured on the original logical partition. Then the I/O activity can resume through the dedicated adapter, using the virtual Fibre Channel adapter as a secondary path.

Related information:

 [Virtual I/O Server Deployment Examples](#)

 [Configuring a virtual Fibre Channel adapter using the HMC](#)

 [Configuring logical partitions to use virtual Fibre Channel on the Integrated Virtualization Manager](#)

Security considerations

Review the security considerations for virtual Small Computer Serial Interface (SCSI), virtual Ethernet, and Shared Ethernet Adapter and the additional security options available.

Systems allow cross-partition device sharing and communication. Functions such as dynamic LPAR, shared processors, virtual networking, virtual storage, and workload management all require facilities to ensure that system-security requirements are met. Cross-partition and virtualization features are designed to not introduce any security exposure beyond what is implied by the function. For example, a virtual LAN connection would have the same security considerations as a physical network connection. Carefully consider how to utilize cross-partition virtualization features in high-security environments. Any visibility between logical partitions must be manually created through administrative system-configuration choices.

Using virtual SCSI, the Virtual I/O Server provides storage to client logical partitions. However, instead of SCSI or fiber cable, the connection for this functionality is done by the firmware. The virtual SCSI device drivers of the Virtual I/O Server and the firmware ensure that only the system administrator of the Virtual I/O Server has control over which logical partitions can access data on Virtual I/O Server storage devices. For example, a client logical partition that has access to a logical volume 1v001 exported by the Virtual I/O Server logical partition cannot access 1v002, even if it is in the same volume group.

Similar to virtual SCSI, the firmware also provides the connection between logical partitions when using virtual Ethernet. The firmware provides the Ethernet switch functionality. The connection to the external network is provided by the Shared Ethernet Adapter function on the Virtual I/O Server. This part of the Virtual I/O Server acts as a layer-2 bridge to the physical adapters. A VLAN ID tag is inserted into every Ethernet frame. The Ethernet switch restricts the frames to the ports that are authorized to receive frames with that VLAN ID. Every port on an Ethernet switch can be configured to be a member of several VLANs. Only the network adapters, both virtual and physical, that are connected to a port (virtual or physical) that belongs to the same VLAN can receive the frames. The implementation of this VLAN standard ensures that the logical partitions cannot access restricted data.

Installing the Virtual I/O Server and client logical partitions

Find instructions for installing the Virtual I/O Server and client logical partitions by deploying a system plan or manually creating the logical partition and logical partition profiles and installing the Virtual I/O Server (VIOS) and client operating systems.

These instructions apply to installing the Virtual I/O Server and client logical partitions on a system that is managed by a Hardware Management Console (HMC). If you plan to install the Virtual I/O Server on a system that is not managed by an HMC, then you need to install the Integrated Virtualization Manager. For instructions, see *Installing the Integrated Virtualization Manager*.

The installation procedures vary depending on the following factors:

- The version of HMC attached to the managed system on which you plan to install the Virtual I/O Server and client logical partitions. HMC Version 7 displays a different interface than prior versions of the HMC. HMC Version 7 also provides the ability to deploy a system plan that includes the Virtual I/O Server and client logical partitions.
- Whether you plan to deploy a system plan that includes the Virtual I/O Server and client logical partitions. When you deploy a system plan, the HMC automatically performs the following tasks based on the information provided in the system plan:
 - Creates the Virtual I/O Server logical partition and logical partition profile.
 - Installs the Virtual I/O Server and provisions virtual resources.
 - Creates the client logical partitions and logical partition profiles.
 - Installs the AIX and Linux operating systems on client logical partitions. The HMC must be at V7R3.3.0, or later.

Note: As an alternative to the HMC, you can use the Systems Director Management Console (SDMC) to install the VIOS and client logical partitions.

Related information:

 [Installing the Virtual I/O Server using NIM](#)

 [Installing the VIOS and client virtual hosts by using the SDMC](#)

Installing the Virtual I/O Server manually by using HMC Version 7, release 7.1, and later

You can create the Virtual I/O Server logical partition and logical partition profile, and you can install the Virtual I/O Server (VIOS) by using the Hardware Management Console (HMC) Version 7, release 7.1, or later.

Before you begin

Before you start, ensure that you meet the following requirements:

- The system on which you plan to install the Virtual I/O Server is managed by a Hardware Management Console (HMC).
- The HMC is at Version 7, release 7.1, or later.

What to do next

Note: As an alternative to the HMC, you can use the Systems Director Management Console (SDMC) to install the VIOS manually.

Related information:

 Installing the VIOS manually by using the SDMC

Entering the activation code for PowerVM Editions by using HMC Version 7

Use these instructions to enter the PowerVM Editions (or Advanced POWER Virtualization) activation code using the Hardware Management Console (HMC) Version 7, or later.

About this task

If PowerVM Editions is not enabled on your system, you can use the HMC to enter the activation code that you received when you ordered the feature.

Use the following procedure to enter the activation code for the PowerVM Standard Edition and the PowerVM Enterprise Edition. For information about the PowerVM Editions, see PowerVM Editions overview.

To enter your activation code, follow these steps:

Procedure

1. In the Navigation area, expand **Systems Management**.
2. Select **Servers**.
3. In the contents area, select the managed system on which you plan to use PowerVM Editions. For example, this might be the system on which you plan to install the Virtual I/O Server, or it might be the system in which you plan to use the Micro-Partitioning technology.
4. Click **Tasks** and select **Capacity on Demand (CoD) > PowerVM > Enter Activation Code**.
5. Enter your activation code and click **OK**.

What to do next

Note: As an alternative to the HMC, you can use the Systems Director Management Console (SDMC) to enter the PowerVM Editions (or Advanced POWER Virtualization) activation code.

Related information:

 Entering the activation code by using the SDMC

Creating the Virtual I/O Server logical partition on an HMC managed system

You can use the Hardware Management Console (HMC) Version 7, release 7.1, or later to create a logical partition and partition profile for the Virtual I/O Server (VIOS).

About this task

You can use the Hardware Management Console (HMC) Version 7, release 7.1, or later to create the Virtual I/O Server partition and profile manually. Or, you can deploy a system plan to create the Virtual I/O Server (VIOS) partition and profile. When you deploy a system plan you can optionally create client logical partitions and their profiles on the managed system as well.

What to do next

Note: As an alternative to the HMC, you can use the Systems Director Management Console (SDMC) to create a logical partition and partition profile for the VIOS.

Related information:

 Creating the VIOS virtual server on an SDMC managed host

Creating the Virtual I/O Server logical partition and partition profile manually by using the HMC:

You can use the Hardware Management Console (HMC) Version 7, release 7.1, or later to create a logical partition and partition profile for the Virtual I/O Server (VIOS).

Before you begin

Before you start, ensure that you meet the following requirements:

- You are a super administrator or an operator.
- The PowerVM Editions (or Advanced POWER Virtualization) feature is activated. For instructions, see “Entering the activation code for PowerVM Editions by using HMC Version 7” on page 89.

About this task

The Virtual I/O Server requires a minimum of 30 GB of disk space.

To create a logical partition and a partition profile on your server by using the HMC, follow these steps:

Procedure

1. In the Navigation area, expand **Systems Management**.
2. Select **Servers**.
3. In the contents area, select the server on which you want to create the partition profile.
4. Click **Tasks** and select **Configuration > Create Logical Partition > VIO Server**.
5. On the Create Partition page, enter a name and ID for the Virtual I/O Server partition.
6. On the Partition Profile page, complete the following steps:
 - a. Enter a profile name for the Virtual I/O Server partition.
 - b. Ensure that the **Use all the resources in the system** check box is cleared (not selected).
7. On the Processors page, decide if you want to use shared or dedicated processors (based on your environment) by making the appropriate selection.
8. On the Processing Settings page, enter the appropriate amount of processing units and virtual processors that you want to assign to the Virtual I/O Server partition.
9. On the Memory page, select the appropriate amount of memory that you want to assign to the Virtual I/O Server partition. The required minimum value is 512 MB.
10. On the I/O page, select the physical I/O resources that you want in the Virtual I/O Server partition.
11. On the Virtual Adapters page, create the appropriate adapters for your environment.
12. On the Logical Host Ethernet Adapter (LHEA) page, configure one or more LHEAs for the Virtual I/O Server partition. (Host Ethernet Adapter is sometimes referred to as Integrated Virtual Ethernet.)
13. On the Optional Settings page, complete the following steps:
 - a. Decide if you want connection monitoring by making the appropriate selection.
 - b. If you want the Virtual I/O Server to start when the managed system starts, select the **Automatically start with managed system** option.
 - c. Decide if you want to enable redundant error path reporting by making the appropriate selection.
 - d. Select the boot mode for the Virtual I/O Server partition. In most cases, the **Normal** boot mode is the appropriate selection.
14. Verify your selections in the Profile Summary window and click **Finish**.

What to do next

After you create the partition and partition profile, you are ready to install the Virtual I/O Server. For instructions, see one of the following procedures:

- “Installing the Virtual I/O Server from the HMC” on page 91
- “Installing the Virtual I/O Server from CD or DVD” on page 92

Note: As an alternative to the HMC, you can use the Systems Director Management Console (SDMC) to create the VIOS partition and profile.

Related information:

 Creating the VIOS virtual server and virtual server profile by using the SDMC

Creating the Virtual I/O Server logical partition and client logical partitions by using the HMC to deploy a system plan:

You use the Hardware Management Console (HMC) Version 7, release 7.1, or later, to deploy a system plan on a POWER7 managed system to create a logical partition and profile for the Virtual I/O Server (VIOS). You also can use the system plan to optionally create client logical partitions and their profiles on the managed system.

Before you begin

Before you start, ensure that you meet the following requirements:

- The system to which you plan to deploy the system plan is managed by a Hardware Management Console (HMC) at Version 7, release 7.1, or later.
- The system plan can only create the Virtual I/O Server management partition and profile and client logical partitions and profiles.

What to do next

After you use the system plan to create your management and client logical partitions and their associated partition profiles, you are ready to install the Virtual I/O Server. For instructions, see one of the following procedures:

- Installing the Virtual I/O Server from the HMC
- Installing the Virtual I/O Server from CD or DVD

Note: As an alternative to the HMC, you can use the Systems Director Management Console (SDMC) to deploy a system plan on a POWER7 managed system to create a logical partition and profile for the VIOS.

Installing the Virtual I/O Server from the HMC

Find instructions for installing the Virtual I/O Server (VIOS) from the HMC by using the **installios** command.

Before you begin

Before you start, complete the following tasks:

1. Ensure that you meet the following requirements:
 - There is an HMC attached to the managed system.
 - The Virtual I/O Server logical partition and logical partition profile are created. For instructions, see “Creating the Virtual I/O Server logical partition and partition profile manually by using the HMC” on page 89.
 - If you are installing Virtual I/O Server Version 2.2.1.0, or later, ensure that the HMC is at Version 7 Release 7.4.0, or later.
 - The Virtual I/O Server logical partition has at least one Ethernet adapter and a 16 GB disk assigned to it.
 - You have **hmcsuperadmin** authority.
2. Gather the following information:
 - Static IP address for the Virtual I/O Server

- Subnet mask for the Virtual I/O Server
- Default gateway for the Virtual I/O Server

About this task

To install the Virtual I/O Server, follow these steps:

Procedure

1. Insert the Virtual I/O Server CD or DVD into the HMC.
2. If you are installing the Virtual I/O Server through the public network interface, continue to step 3. If you are installing the Virtual I/O Server through a private network interface, type the following from the HMC command line:

```
export INSTALLIOS_PRIVATE_IF=interface
```

 where *interface* is the network interface through which the installation should take place.
3. From the HMC command line, type:

```
installios
```
4. Follow the installation instructions according to the system prompts.

What to do next

After you install the Virtual I/O Server, finish the installation by checking for updates, setting up remote connections, creating additional user IDs, and so on. For instructions, see “Finishing the Virtual I/O Server installation” on page 94.

Note: As an alternative to the HMC, you can use the Systems Director Management Console (SDMC) to install the VIOS.

Related information:

 [Installing the VIOS from the SDMC](#)

Installing the Virtual I/O Server from CD or DVD

Find instructions for installing the Virtual I/O Server from a CD or DVD device that is attached to the Virtual I/O Server (VIOS) logical partition.

Before you begin

Before you start, ensure that you meet the following requirements:

- There is an HMC attached to the managed system.
- The Virtual I/O Server logical partition and logical partition profile are created. For instructions, see “Creating the Virtual I/O Server logical partition and partition profile manually by using the HMC” on page 89.
- A CD or DVD optical device is assigned to the Virtual I/O Server logical partition.

About this task

To install the Virtual I/O Server from CD or DVD, follow these steps:

Procedure

1. Activate the Virtual I/O Server logical partition using the HMC Version 7 (or later) or HMC Version 6 (or earlier):
 - Activate the Virtual I/O Server using the HMC Version 7 or later:
 - a. Insert the Virtual I/O Server CD or DVD into the Virtual I/O Server logical partition.
 - b. In the HMC navigation area, expand **Systems Management** > **Servers**.

- c. Select the server on which the Virtual I/O Server logical partition is located.
 - d. In the contents area, select the Virtual I/O Server logical partition.
 - e. Click **Tasks > Operations > Activate**. The Activate Partition menu opens with a selection of logical partition profiles. Ensure the correct profile is highlighted.
 - f. Select **Open a terminal window or console session** to open a virtual terminal (vterm) window.
 - g. Click **(Advanced)** to open the advanced options menu.
 - h. For the boot mode, select **SMS**.
 - i. Click **OK** to close the advanced options menu.
 - j. Click **OK**. A virtual terminal window opens for the logical partition.
- Activate the Virtual I/O Server using the HMC Version 6 or earlier:
 - a. Insert the Virtual I/O Server CD or DVD into the Virtual I/O Server logical partition.
 - b. On the HMC, right-click the logical partition to open the menu.
 - c. Click **Activate**. The Activate Partition menu opens with a selection of logical partition profiles. Ensure the correct profile is highlighted.
 - d. Select **Open a terminal window or console session** to open a virtual terminal (vterm) window.
 - e. Click **(Advanced)** to open the advanced options menu.
 - f. For the boot mode, select **SMS**.
 - g. Click **OK** to close the advanced options menu.
 - h. Click **OK**. A virtual terminal window opens for the logical partition.
2. Select the boot device:
 - a. Select **Select Boot Options** and press Enter.
 - b. Select **Select Install/Boot Device** and press Enter.
 - c. Select **Select 1st Boot Device** and press Enter.
 - d. Select **CD/DVD** and press Enter.
 - e. Select the media type that corresponds to the optical device and press Enter.
 - f. Select the device number that corresponds to the optical device and press Enter.
 - g. Set the boot sequence to configure the first boot device. The optical device is now the first device in the Current Boot Sequence list.
 - h. Exit the SMS menu by pressing the x key, and confirm that you want to exit SMS.
 3. Install the Virtual I/O Server:
 - a. Select the desired console and press Enter.
 - b. Select a language for the BOS menus and press Enter.
 - c. Select **Start Install Now with Default Settings** and press Enter. Select **Change/Show Installation Settings and Install** to change the installation and system settings.
 - d. Select **Continue with Install**. The system will reboot after the installation is complete.

What to do next

After you install the Virtual I/O Server, finish the installation by checking for updates, setting up remote connects, creating additional user IDs, and so on. For instructions, see “Finishing the Virtual I/O Server installation” on page 94.

Note: As an alternative to the HMC, you can use the Systems Director Management Console (SDMC) to install the VIOS from a CD or DVD device.

Related information:

 Installing the VIOS from CD or DVD by using the SDMC

Finishing the Virtual I/O Server installation

After you install Virtual I/O Server, you must check for updates, set up remote connects, create additional user IDs, and so on.

Before you begin

This procedure assumes that Virtual I/O Server is installed. For instructions, see “Installing the Virtual I/O Server and client logical partitions” on page 88.

About this task

To finish the installation, complete the following steps:

Procedure

1. Accept the software maintenance terms and conditions, and the Virtual I/O Server product license. For instructions, see “Viewing and accepting the Virtual I/O Server license.”
2. Set up remote connections to the Virtual I/O Server. For instructions, see “Connecting to the Virtual I/O Server by using OpenSSH” on page 205.
3. Optional: Create the following additional user IDs. After the installation, the only active user ID is the prime administrator (padmin). You can create the following additional user IDs: system administrator, service representative, and development engineer. For information about creating user IDs, see “Managing users on the Virtual I/O Server” on page 219.
4. Configure the TCP/IP connection for the Virtual I/O Server using the **mktcpip** command. You must complete this task before you can perform any dynamic logical partitioning operations. Alternatively, you can use the configuration assistance menu to configure TCP/IP connections. You can access the configuration assistance menu by running the **cfgassist** command.

What to do next

When you are finished, do one of the following tasks:

- Create client logical partitions.

Note: You do not need to perform this task if you deployed a system plan to create all your client logical partitions.

- Configure the Virtual I/O Server and install client operating systems. For information, see “Configuring the Virtual I/O Server” on page 102 and Logical partitioning. For more information about Logical partitioning, see Logical partitioning.

Related information:

 Finishing the installation on the SDMC

Viewing and accepting the Virtual I/O Server license:

You must view and accept the license before using the Virtual I/O Server.

Before you begin

Before you start, ensure that the Virtual I/O Server logical partition profile is created and the Virtual I/O Server is installed. For instructions, see “Installing the Virtual I/O Server and client logical partitions” on page 88.

About this task

To view and accept the Virtual I/O Server license, complete the following steps:

Procedure

1. Log in to the Virtual I/O Server using the **padmin** user ID.
2. Choose a new password. The software maintenance terms and conditions appear.
3. View and accept the Virtual I/O Server product license.

Note: If you installed the Virtual I/O Server by deploying a system plan, then you have already accepted the Virtual I/O Server product license and do not need to complete this step.

- a. To view the Virtual I/O Server product license, type `license -ls` on the command line. By default, the license is displayed in English. To change the language in which the license is displayed, follow these steps:
 - 1) View the list of available locales to display the license by typing the following command:

```
license -ls
```
 - 2) View the license in another language by typing the following command:

```
license -view -lang Name
```

For example, to view the license in Japanese, type the following command:

```
license -view -lang ja_JP
```
 - b. To accept the Virtual I/O Server product license, type `license -accept` on the command line.
4. In the installation program, English is the default language. If you need to change the language setting for the system, follow these steps:
 - a. View the available languages by typing the following command:

```
chlang -ls
```
 - b. Change the language by typing the following command, replacing *Name* with the name of the language you are switching to:

```
chlang -lang Name
```

Note: If the language fileset is not installed, use the **-dev Media** flag to install it. For example, to install and change the language to Japanese, type the following command:

```
chlang -lang ja_JP -dev /dev/cd0
```

Related information:

 Viewing and accepting the license by using the SDMC

Reinstalling the Virtual I/O Server of a paging VIOS partition

When you reinstall the Virtual I/O Server (VIOS) that is assigned to the shared memory pool (hereafter referred to as a *paging VIOS partition*), you need to reconfigure the shared memory environment. For example, you might need to add the paging space devices again to the shared memory pool.

About this task

The paging VIOS partitions store information about the paging space devices that are assigned to a shared memory pool. The Hardware Management Console (HMC) obtains information about the paging space devices that are assigned to the shared memory pool from the paging VIOS partitions. When you reinstall the VIOS, the information about the paging space devices is lost. For the paging VIOS partitions to regain the information, you must assign the paging space devices again to the share memory pool after you reinstall the VIOS.

The following table shows the reconfiguration tasks that you must perform in the shared memory environment when you reinstall the Virtual I/O Server of a paging VIOS partition.

Table 33. Shared memory reconfiguration tasks for reinstalling the Virtual I/O Server of a paging VIOS partition

| Number of paging VIOS partitions that are assigned to the shared memory pool | Number of paging VIOS partitions for which you want to reinstall the VIOS | Reconfiguration steps | Instructions |
|--|---|--|---|
| 1 | 1 | <ol style="list-style-type: none"> 1. Shut down all logical partitions that use shared memory (hereafter referred to as <i>shared memory partitions</i>). 2. Reinstall the VIOS. 3. Add the paging space devices again to the shared memory pool. | <ol style="list-style-type: none"> 1. Shutting down and restarting logical partitions 2. Installing the Virtual I/O Server manually using the HMC version 7 3. Adding and removing paging space devices to and from the shared memory pool |
| 2 | 1 | <ol style="list-style-type: none"> 1. Shut down each shared memory partition that uses the paging VIOS partition (that you plan to reinstall) as the primary or secondary paging VIOS partition. 2. Remove the paging VIOS partition from the shared memory pool. 3. Reinstall the VIOS. 4. Add the paging VIOS partition again to the shared memory pool. | <ol style="list-style-type: none"> 1. Shutting down and restarting logical partitions 2. Removing a paging VIOS partition from the shared memory pool 3. Installing the Virtual I/O Server manually using the HMC version 7 4. Adding a paging VIOS partition to the shared memory pool |
| 2 | 2 | <ol style="list-style-type: none"> 1. Shut down all the shared memory partitions. 2. Reinstall the VIOS of each paging VIOS partition. 3. Add the paging space devices again to the shared memory pool. | <ol style="list-style-type: none"> 1. Shutting down and restarting logical partitions 2. Installing the Virtual I/O Server manually using the HMC version 7 3. Adding and removing paging space devices to and from the shared memory pool |

Migrating the Virtual I/O Server

You can migrate the Virtual I/O Server (VIOS) logical partition from the Hardware Management Console (HMC) Version 7, or later, from a DVD device that is attached to the Virtual I/O Server logical partition.

Before you start, verify that the following statements are true:

- The system on which you plan to migrate the Virtual I/O Server is managed by a Hardware Management Console (HMC) Version 7, or later.
- The Virtual I/O Server is at Version 1.3, or later.
- The rootvg volume group has been assigned to the Virtual I/O Server.

Note: If you are using an Integrated Virtualization Manager (IVM) environment, see Migrating the Virtual I/O Server from DVD when using the Integrated Virtualization Manager.

In most cases, user configuration files from the previous version of the Virtual I/O Server are saved when the new version is installed. If you have two or more Virtual I/O Server logical partitions in your environment for redundancy, you are able to shut down and migrate one Virtual I/O Server logical partition without interrupting any clients. After the migration is complete and the Virtual I/O Server logical partition is running again, the logical partition will be available to clients without additional configuration.

Attention: Do not use the Virtual I/O Server `updateios` command to migrate the Virtual I/O Server.

Note: As an alternative to the HMC, you can use the Systems Director Management Console (SDMC) to install the VIOS from a CD or DVD device.

Related information:

 [Migrating the Virtual I/O Server using NIM](#)

 [Migrating the VIOS by using the SDMC](#)

Migrating the Virtual I/O Server from the HMC

Find instructions for migrating the Virtual I/O Server (VIOS) to Version 2.1.0.0, or later, from the Hardware Management Console (HMC) by using the `installios` command.

Before you begin

Before you start, verify you meet the following requirements:

- HMC is attached to the managed system.
- The Virtual I/O Server logical partition has at least one Ethernet adapter and a 16 GB disk assigned to it.
- You have `hmcsuperadmin` authority.
- You have the Virtual I/O Server migration media.

Note: The migration media is separate from the installation media.

- The Virtual I/O Server is currently at Version 1.3 or later.
- The disk name (**PV_name**) of your root volume group (rootvg) is `hdisk0`. You can verify the disk name by running the following command from the Virtual I/O Server command line interface: `lsvg -pv rootvg`

Note: If the disk name is anything other than `hdisk0`, you cannot use the migration DVD to perform the migration. Instead, see Migrating the Virtual I/O Server from a downloaded migration image to ensure that you can migrate the Virtual I/O Server successfully.

- The rootvg volume group has been assigned to the Virtual I/O Server
- Use the `startnetsvc` command to note what services you have started for the Virtual I/O Server.
- Determine the services and agents that are configured (by using the `cfgsvc` command) for use with the Virtual I/O Server. Use the `lssvc` command to display a list of all agents. Use the `lssvc` with the agent name parameter (`lssvc <agent_name>`) to display information for a specified agent.

Note: If any parameters have been set for an agent or service, you will need to reconfigure the parameters after you complete the migration process.

- Back up the `mksysb` image before migrating Virtual I/O Server. Run the `backupios` command and save the `mksysb` image to a safe location.

About this task

To migrate the Virtual I/O Server, follow these steps:

Procedure

1. Insert the **Virtual I/O Server migration DVD** into the HMC.
2. If you are installing the Virtual I/O Server through the public network interface, continue to step 3. If you are installing the Virtual I/O Server through a private network interface, type the following command from the HMC command line:

```
export INSTALLIOS_PRIVATE_IF=interface
```

where *interface* is the network interface through which the installation should take place.

3. From the HMC command line, type:

```
installios
```

Attention: Do not use the Virtual I/O Server **updateios** command to migrate the Virtual I/O Server.

4. Follow the installation instructions according to the system prompts.

What to do next

After the migration is complete, the Virtual I/O Server logical partition is restarted to its preserved configuration prior to the migration installation. It is recommended to perform the following tasks:

- Verify that migration was successful by checking the results of the **installp** command and by running the **ioslevel** command. The results of the **ioslevel** command indicate the ioslevel is now \$ *ioslevel* 2.1.0.0.
- Restart previously running daemons and agents:
 1. Log on to the Virtual I/O Server as padmin user.
 2. Complete the following command: \$ motd -overwrite "<enter previous banner message>"
 3. Start up any previously running daemons, such as FTP and Telnet.
 4. Start up any previously running agents, such as ituam.
- Check for updates to the Virtual I/O Server. For instructions, see the Fix Central website.

Remember: The Virtual I/O Server migration media is separate from the Virtual I/O Server installation media. Do not use the installation media for updates after you perform a migration. It does not contain updates and you will lose your current configuration. Only apply updates using the instructions from the Virtual I/O Server Support for Power Systems™ Web site.

Note: As an alternative to the HMC, you can use the Systems Director Management Console (SDMC) to migrate the VIOS to Version 2.1.0.0, or later.

Related tasks:

“Backing up the Virtual I/O Server to a remote file system by creating a mksysb image” on page 183
You can back up the Virtual I/O Server base code, applied fix packs, custom device drivers to support disk subsystems, and some user-defined metadata to a remote file system by creating a mksysb file.

Related information:

 [Migrating the Virtual I/O Server from DVD when using the Integrated Virtualization Manager](#)

 [Migrating the VIOS from the SDMC](#)

Migrating the Virtual I/O Server from a downloaded image

Find instructions for migrating the Virtual I/O Server (VIOS) to Version 2.1.0.0, or later, from the Hardware Management Console (HMC) when the disk name of the root volume group (rootvg) is not hdisk0.

Before you begin

Ensure that you have the latest HMC installation image. You can obtain the latest installation image from the Fix Central website.

About this task

If the disk name (**PV_name**) of your root volume group (rootvg) is anything other than `hdisk0`, complete the following steps to migrate the Virtual I/O Server:

Procedure

1. If the system detects that the first migratable disk does not contain a Virtual I/O Server installation during a non-prompted migration, the migration will switch to the prompted mode. At this point, the migration is cancelled and the **Migration Confirmation Menu** on the console for the logical partition is displayed with the following message at the bottom of the screen: Cannot proceed with VIOS migration. The selected disk does not contain a VIOS. To resolve this problem, you must end the installation process by pressing CTRL-C from the session that executed the `installios` command.
2. Download the Virtual I/O Server migration image from the Virtual I/O Server Web site.
3. Determine the PVID value for the hard disk of your root volume group (rootvg). There are two ways to obtain the PVID value:

- From the HMC command line, run the following command: `viosvr cmd -m cecl -p vios1 -c "lspv"`

The command returns information such as in the following example:

| NAME | PVID | VG | STATUS |
|--------|------------------|--------|--------|
| hdisk0 | 00cd1b0ef5e5g5g8 | None | |
| hdisk1 | 00cd1b0ec1b17302 | rootvg | active |
| hdisk2 | none | None | |

- From the Virtual I/O Server command line with `padmin` user authority, run the `lspv` to obtain the PVID value of the disk targeted for the installation.

The command returns information such as in the following example:

| NAME | PVID | VG | STATUS |
|--------|------------------|--------|--------|
| hdisk0 | 00cd1b0ef5e5g5g8 | None | |
| hdisk1 | 00cd1b0ec1b17302 | rootvg | active |
| hdisk2 | none | None | |

4. From the HMC command line, run the `installios` command with flags. Specify option `-E` with the PVID value of the Virtual I/O Server target disk that is the migration destination. For example, based on the following example information, you might run this command: `installios -s cecl -S 255.255.255.0 -p vios -r vios_prof -i 10.10.1.69 -d /dev/cdrom -m 0e:f0:c0:00:40:02 -g 10.10.1.169 -P auto -D auto -E 00cd1b0ec1b17302`

```
VIOS image source           = /dev/cdrom
managed_system              = cecl
VIOS partition              = vios
VIOS partition profile      = vios_prof
VIOS IP address             = 10.10.1.69
VIOS subnet mask           = 255.255.255.0
VIOS gateway address       = 10.10.1.169
VIOS network MAC address   = 0ef0c0004002
VIOS network adapter speed = auto
VIOS network adapter duplex = auto
VIOS target disk PVID      = 00cd1b0ec1b17302  △ rootvg
```

Note: When you install the Virtual I/O Server with the `installios` command, if the installation process cannot find the PVID value that you entered with the `-E` option, the installation proceeds in the prompt mode.

From the HMC terminal that is running the `installios` command, a message of `info=prompting_for_data_at_console` is displayed. The LED code for the partition shows a code of

0c48. Either run the `mkvterm -m cec1 -p vios` command from the HMC to interact with the virtual console to continue the migration or to rerun the `installios` command with the corrected PVID value. Note that rerunning the `installios` command recopies the image from media to the disk.

What to do next

After the migration is complete, the Virtual I/O Server logical partition is restarted to its preserved configuration before the migration installation. It is recommended to perform the following tasks:

- Verify that migration was successful by checking the results of the `installp` command and by running the `ioslevel` command. The results of the `ioslevel` command indicate the ioslevel is now `$ ioslevel 2.1.0.0`.
- Restart previously running daemons and agents:
 1. Log on to the Virtual I/O Server as `padmin` user.
 2. Complete the following command: `$ motd -overwrite "<enter previous banner message>"`
 3. Start up any previously running daemons, such as FTP and Telnet.
 4. Start up any previously running agents, such as `ituam`.
- Check for updates to the Virtual I/O Server. For instructions, see the Fix Central website.

Remember: The Virtual I/O Server migration media is separate from the Virtual I/O Server installation media. Do not use the installation media for updates after you perform a migration. It does not contain updates and you can lose your current configuration. Only apply updates using the instructions from the Virtual I/O Server Support for Power Systems Web site.

Note: As an alternative to the HMC, you can use the Systems Director Management Console (SDMC) to migrate the VIOS to Version 2.1.0.0, or later, when the disk name of the root volume group (`rootvg`) is not `hdisk0`.

Related information:

 [Migrating the VIOS from a downloaded image by using the SDMC](#)

Migrating the Virtual I/O Server from DVD

Find instructions for migrating the Virtual I/O Server (VIOS) from a DVD device that is attached to the VIOS logical partition.

Before you begin

Before you start, ensure that you meet the following requirements:

- An HMC is attached to the managed system.
- A DVD optical device is assigned to the Virtual I/O Server logical partition.
- The Virtual I/O Server migration installation media is required.

Note: The Virtual I/O Server migration installation media is separate from the Virtual I/O Server installation media.

- The Virtual I/O Server is currently at Version 1.3, or later.
- The root volume group (`rootvg`) has been assigned to the Virtual I/O Server
- Use the `startnetsvc` command to note what services you have started for the Virtual I/O Server.
- Determine the services and agents that are configured (by using the `cfgsvc` command) for use with the Virtual I/O Server. Use the `lssvc` command to display a list of all agents. Use the `lssvc` with the agent name parameter (`lssvc <agent_name>`) to display information for a specified agent.

Note: If any parameters have been set for an agent or service, you will need to reconfigure the parameters after you complete the migration process.

- Back up the mksysb image before migrating the Virtual I/O Server. Run the **backupios** command and save the mksysb image to a safe location.

Note: If you are using an Integrated Virtualization Manager (IVM) environment, see Migrating the Virtual I/O Server from DVD when using the Integrated Virtualization Manager.

About this task

To migrate the Virtual I/O Server from a DVD, follow these steps:

Procedure

1. Activate the Virtual I/O Server logical partition using the HMC, Version 7 (or later):
 - a. Insert the **Virtual I/O Server migration DVD** into the DVD drive assigned to the Virtual I/O Server logical partition.
 - b. In the HMC navigation area, expand **Systems Management > Servers**.
 - c. Select the server on which the Virtual I/O Server logical partition is located.
 - d. In the contents area, select the Virtual I/O Server logical partition.
 - e. Click **Tasks > Operations > Activate**. The Activate Partition menu opens with a selection of logical partition profiles. Ensure that the correct profile is highlighted.
 - f. Select **Open a terminal window or console session** to open a virtual terminal (vterm) window.
 - g. Click **Advanced** to open the advanced options menu.
 - h. For the boot mode, select **SMS**.
 - i. Click **OK** to close the advanced options menu.
 - j. Click **OK**. A virtual terminal window opens for the logical partition.
2. Select the boot device:
 - a. Select **Select Boot Options** and press Enter.
 - b. Select **Select Install/Boot Device** and press Enter.
 - c. Select **CD/DVD** and press Enter.
 - d. Select the device number that corresponds to the DVD and press Enter. You can also select **List all devices** and select the device number from a list and press Enter.
 - e. Select **Normal mode boot**.
 - f. Select **Yes** to exit SMS.
3. Install the Virtual I/O Server:
 - a. Select the desired console and press Enter.
 - b. Select a language for the BOS menus and press Enter.
 - c. Select **Start Install Now with Default Settings** and press Enter. You can also verify the installation and system settings by typing 2 to select **Change/Show Installation Settings and Install**.

Note: You should not have to change installation settings simply to select the migration installation method. If a previous version of the operating system exists, the installation method defaults to migration.

- d. Select **Continue with Install**. The system will reboot after the installation is complete.

What to do next

After the migration is complete, the Virtual I/O Server logical partition is restarted to its preserved configuration prior to the migration installation. It is recommended that you perform the following tasks:

- Verify that migration was successful by checking the results of the **installp** command and by running the **ioslevel** command. The results of the **ioslevel** command indicate the ioslevel is now \$ *ioslevel 2.1.0.0*.

- Restart previously running daemons and agents:
 1. Log on to the Virtual I/O Server as padmin user.
 2. Complete the following command: `$ motd -overwrite "<enter previous banner message>"`
 3. Start any previously running daemons, such as FTP and Telnet.
 4. Start any previously running agents, such as ituam.
- Check for updates to the Virtual I/O Server. For instructions, see the Fix Central website.



Remember: The Virtual I/O Server migration media is separate from the Virtual I/O Server installation media. Do not use the installation media for updates after you perform a migration. It does not contain updates and you will lose your current configuration. Only apply updates using the instructions from the Virtual I/O Server Support for Power Systems Web site.

Note: As an alternative to the HMC, you can use the Systems Director Management Console (SDMC) to migrate the VIOS from a DVD device that is attached to the VIOS logical partition.

Related tasks:

“Backing up the Virtual I/O Server to a remote file system by creating a mksysb image” on page 183
 You can back up the Virtual I/O Server base code, applied fix packs, custom device drivers to support disk subsystems, and some user-defined metadata to a remote file system by creating a mksysb file.

Related information:

-  [Migrating the Virtual I/O Server from DVD when using the Integrated Virtualization Manager](#)
-  [Migrating the VIOS from the DVD by using the SDMC](#)

Configuring the Virtual I/O Server

You need to configure virtual Small Computer Serial Interface (SCSI) and virtual Ethernet devices on the Virtual I/O Server. Optionally, you can also configure virtual Fibre Channel adapters, Tivoli agents and clients, and configure the Virtual I/O Server as an LDAP client.

About this task

Configuring virtual SCSI on the Virtual I/O Server

You can configure virtual Small Computer Serial Interface (SCSI) devices by deploying a system plan, creating volume groups and logical volumes, and configuring the Virtual I/O Server to support SCSI-2 reserve functions.

About this task

Provisioning virtual disk resources occurs on the Virtual I/O Server. Physical disks owned by the Virtual I/O Server can either be exported and assigned to a client logical partition as a whole or can be partitioned into parts, such as logical volumes or files. These logical volumes and files can be exported as virtual disks to one or more client logical partitions. Therefore, by using virtual SCSI, you can share adapters as well as disk devices.

To make a physical volume, logical volume, or file available to a client logical partition requires that it be assigned to a virtual SCSI server adapter on the Virtual I/O Server. The SCSI client adapter is linked to a particular virtual SCSI server adapter in the Virtual I/O Server logical partition. The client logical partition accesses its assigned disks through the virtual SCSI client adapter. The Virtual I/O Server client adapter sees standard SCSI devices and LUNs through this virtual adapter. Assigning disk resources to a SCSI server adapter in the Virtual I/O Server effectively allocates resources to a SCSI client adapter in the client logical partition.

Creating the virtual target device on the Virtual I/O Server

Creating the virtual target device on the Virtual I/O Server maps the virtual Small Computer Serial Interface (SCSI) adapter with the file, logical volume, tape, optical device or physical disk.

About this task

With the Virtual I/O Server Version 2.1 and later, you can export the following types of physical devices:

- Virtual SCSI disk backed by a physical volume
- Virtual SCSI disk backed by a logical volume
- Virtual SCSI disk backed by a file
- Virtual SCSI optical backed by a physical optical device
- Virtual SCSI optical backed by a file
- Virtual SCSI tape backed by a physical tape device

After a virtual device is assigned to a client partition, the Virtual I/O Server must be available before the client logical partitions can access it.

Creating a virtual target device on a Virtual I/O Server that maps to a physical or logical volume, tape or physical optical device:

You can create a virtual target device on a Virtual I/O Server that maps the virtual Small Computer Serial Interface (SCSI) adapter to a physical disk, tape, or physical optical device, or to a logical volume that is based on a volume group.

About this task

The following procedure can be repeated to provide additional virtual disk storage to any client logical partition.

Before you start, ensure the following statements are true:

1. At least one physical volume, tape, or optical device, or logical volume is defined on the Virtual I/O Server. For information, see “Logical volumes” on page 23.
2. The virtual adapters for the Virtual I/O Server and the client logical partitions are created. This usually occurs during the creation of the logical partition profile. For information about creating the logical partition, see Installing the Virtual I/O Server.
3. Be aware of the maximum transfer size limitation when you use AIX clients and physical devices. If you have an existing and active AIX client, and you want to add another virtual target device to the virtual SCSI server adapter used by that client, ensure that the `max_transfer` attribute is the same size or larger than the devices already in use.

Tip: If you are using the HMC, Version 7 release 3.4.2 or later, you can use the HMC graphical interface to create a virtual target device on the Virtual I/O Server.

To create a virtual target device that maps a virtual SCSI server adapter to a physical device or logical volume, complete the following steps from the Virtual I/O Server command-line interface:

Procedure

1. Use the `lsdev` command to ensure that the virtual SCSI adapter is available. For example, running `lsdev -virtual` returns results similar to the following:

```
name      status    description
ent3      Available Virtual I/O Ethernet Adapter (1-lan)
vhost0    Available Virtual SCSI Server Adapter
vhost1    Available Virtual SCSI Server Adapter
vsa0      Available LPAR Virtual Serial Adapter
```

```
vtscsi0 Available Virtual Target Device - Logical Volume
vtscsi1 Available Virtual Target Device - File-backed Disk
vtscsi2 Available Virtual Target Device - File-backed Disk
```

2. To create a virtual target device, which maps the virtual SCSI server adapter to a physical device or logical volume, run the **mkvdev** command:

```
mkvdev -vdev TargetDevice -vadapter VirtualSCSIServerAdapter
```

Where:

- *TargetDevice* is the name of the target device, as follows:
 - To map a logical volume to the virtual SCSI server adapter, use the name of the logical volume. For example, *lv_4G*.
 - To map a physical volume to the virtual SCSI server adapter, use *hdiskx*. For example, *hdisk5*.
 - To map an optical device to the virtual SCSI server adapter, use *cdx*. For example, *cd0*.
 - To map a tape device to a virtual SCSI adapter, use *rmtx*. For example, *rmt1*.
- *VirtualSCSIServerAdapter* is the name of the virtual SCSI server adapter.

Note: If needed, use the **lsdev** and **lsmap -all** commands to determine the target device and virtual SCSI server adapter that you want to map to one another.

The storage is available to the client logical partition either the next time it starts, or the next time the appropriate virtual SCSI client adapter is probed (on a Linux logical partition), or configured (on an AIX logical partition).

3. View the newly created virtual target device by running the **lsdev** command. For example, running **lsdev -virtual** returns results similar to the following:

```
name      status      description
vhost3    Available   Virtual SCSI Server Adapter
vsa0      Available   LPAR Virtual Serial Adapter
vtscsi0   Available   Virtual Target Device - Logical Volume
vttape0   Available   Virtual Target Device - Tape
```

4. View the logical connection between the newly created devices by running the **lsmap** command. For example, running **lsmap -vadapter vhost3** returns results similar to the following:

```
SVSA      Physloc                      Client PartitionID
-----
vhost3    U9111.520.10DDEEC-V1-C20    0x00000000

VTD
Status    vtscsi0
LUN       Available
          0x8100000000000000
Backing device  lv_4G
Physloc
```

The physical location is a combination of the slot number, in this case 20, and the logical partition ID. The storage is now available to the client logical partition either the next time it starts, or the next time the appropriate virtual SCSI client adapter is probed, or configured.

What to do next

If you later need to remove the virtual target device, you can do so by using the **rmvdev** command.

Related concepts:

“Virtual SCSI sizing considerations” on page 69

Understand the processor and memory-sizing considerations when implementing virtual Small Computer Serial Interface (SCSI).

Related information:

 Creating a virtual disk for a VIOS logical partition using the HMC

 Virtual I/O Server and Integrated Virtualization Manager commands

Creating a virtual target device on a Virtual I/O Server that maps to a file or logical volume:

You can create a virtual target device on a Virtual I/O Server that maps the virtual Small Computer Serial Interface (SCSI) adapter to a file or a logical volume that is based on a storage pool.

About this task

The following procedure can be repeated to provide additional virtual disk storage to any client logical partition.

Before you start, ensure the following statements are true:

- The Virtual I/O Server is at Version 1.5 or later.
- At least one file is defined in a file storage pool, or at least one logical volume is defined in a logical volume storage pool on the Virtual I/O Server. For information, see “Virtual storage” on page 29 and “Storage pools” on page 27.
- The virtual adapters for the Virtual I/O Server and the client logical partitions are created. This usually occurs during the creation of the logical partition profile. For information about creating the logical partition, see Installing the Virtual I/O Server.

Tip: If you are using the HMC, Version 7 release 3.4.2 or later, you can use the HMC graphical interface to create a virtual target device on the Virtual I/O Server.

To create a virtual target device that maps a virtual SCSI server adapter to a file or logical volume, complete the following steps from the Virtual I/O Server command-line interface:

Procedure

1. Use the **lsdev** command to ensure that the virtual SCSI adapter is available. For example, running `lsdev -virtual` returns results similar to the following:

```
name      status    description
ent3     Available Virtual I/O Ethernet Adapter (1-lan)
vhost0   Available Virtual SCSI Server Adapter
vhost1   Available Virtual SCSI Server Adapter
vsa0     Available LPAR Virtual Serial Adapter
vtscsi0  Available Virtual Target Device - Logical Volume
vtscsi1  Available Virtual Target Device - File-backed Disk
vtscsi2  Available Virtual Target Device - File-backed Disk
```

2. To create a virtual target device, which maps the virtual SCSI server adapter to a file or logical volume, run the **mkbdsp** command:

```
mkbdsp -sp StoragePool -bd BackingDevice -vadapter VirtualSCSIServerAdapter -tn TargetDeviceName
```

Where:

- *StoragePool* is the name of the storage pool that contains the file or logical volume to which you plan to map the virtual SCSI server adapter. For example, fbPool.
- *BackingDevice* is the name of the file or logical volume to which you plan to map the virtual SCSI server adapter. For example, devFile.

- *VirtualSCSIAdapter* is the name of the virtual SCSI server adapter. For example, vhost4.
- *TargetDeviceName* is the name of the target device. For example, fbvtd1.

The storage is available to the client logical partition either the next time it starts, or the next time the appropriate virtual SCSI client adapter is probed (on a Linux logical partition), or configured (on an AIX logical partition).

3. View the newly created virtual target device by running the **lsdev** command. For example, running `lsdev -virtual` returns results similar to the following:

```
name      status      description
vhost4    Available   Virtual SCSI Server Adapter
vsa0      Available   LPAR Virtual Serial Adapter
fbvtd1    Available   Virtual Target Device - File-backed Disk
```

4. View the logical connection between the newly created devices by running the **lsmmap** command. For example, running `lsmmap -vadapter vhost4` returns results similar to the following:

```
SVSA      Physloc                      Client PartitionID
-----
vhost4    U9117.570.10C8BCE-V6-C2      0x00000000



VTD              fbvtd1
Status           Available
LUN              0x8100000000000000
Backing device   /var/vio/storagepools/fbPool/devFile
Physloc
```

The physical location is a combination of the slot number, in this case 2, and the logical partition ID. The virtual device can now be attached from the client logical partition.

What to do next

If you later need to remove the virtual target device and backup device (file or logical volume), use the **rmbdsp** command. An option is available on the **rmbdsp** command to remove the virtual target device without removing the backup device. A backup device file is associated with a virtual target device by inode number rather than by file name, so do not change the inode number of a backing device file. The inode number might change if you alter a backup device file (using the AIX **rm**, **mv**, and **cp** commands), while the backup device file is associated with a virtual target device.

Related information:

-  [Creating a virtual disk for a VIOS logical partition using the HMC](#)
-  [Virtual I/O Server and Integrated Virtualization Manager commands](#)

Creating a virtual target device on a Virtual I/O Server that maps to a file-backed virtual optical device:

You can create a virtual target device on a Virtual I/O Server that maps the virtual Small Computer Serial Interface (SCSI) adapter to a file-backed virtual optical device.

About this task

The following procedure can be repeated to provide additional virtual disk storage to any client logical partition.

Before you start, complete the following steps:

1. Ensure that the Virtual I/O Server is at Version 1.5 or later.
2. Ensure that the virtual adapters for the Virtual I/O Server and the client logical partitions are created. This usually occurs during the creation of the logical partition profile. For information about creating the logical partition, see “Installing the Virtual I/O Server and client logical partitions” on page 88.

Tip: If you are using the HMC, Version 7 release 3.4.2 or later, you can use the HMC graphical interface to create a virtual target device on the Virtual I/O Server.

To create a virtual target device that maps a virtual SCSI server adapter to a file-backed virtual optical device, complete the following steps from the Virtual I/O Server command-line interface:

Procedure

1. Use the **lsdev** command to ensure that the virtual SCSI adapter is available. For example, running `lsdev -virtual` returns results similar to the following:

```
name      status    description
ent3      Available Virtual I/O Ethernet Adapter (1-lan)
vhost0    Available Virtual SCSI Server Adapter
vhost1    Available Virtual SCSI Server Adapter
vsa0      Available LPAR Virtual Serial Adapter
vtscsi0   Available Virtual Target Device - Logical Volume
vtscsi1   Available Virtual Target Device - File-backed Disk
vtscsi2   Available Virtual Target Device - File-backed Disk
```

2. To create a virtual target device, which maps the virtual SCSI server adapter to a file-backed virtual optical device, run the **mkvdev** command:

```
mkvdev -fbo -vadapter VirtualSCSIServerAdapter
```

where *VirtualSCSIServerAdapter* is the name of the virtual SCSI server adapter. For example, *vhost1*.

Note: No backing device is specified when creating virtual target devices for file-backed virtual optical devices because the drive is considered to contain no media. For information about loading media into a file-backed optical drive, see the **loadopt** command.

The optical device is available to the client logical partition either the next time it starts, or the next time the appropriate virtual SCSI client adapter is probed (on a Linux logical partition), or configured (on an AIX logical partition).

3. View the newly created virtual target device by running the **lsdev** command. For example, running `lsdev -virtual` returns results similar to the following:

```
name      status    description
vhost4    Available Virtual SCSI Server Adapter
vsa0      Available LPAR Virtual Serial Adapter
vtopt0    Available Virtual Target Device - File-backed Optical
```

4. View the logical connection between the newly created devices by running the **lsmmap** command. For example, running `lsmmap -vadapter vhost1` returns results similar to the following:

```
SVSA      Physloc                               Client PartitionID
-----
vhost1    U9117.570.10C8BCE-V6-C2  0x00000000

VTD              vtopt0
LUN              0x8200000000000000
Backing device   Physloc
```

The physical location is a combination of the slot number, in this case 2, and the logical partition ID. The virtual device can now be attached from the client logical partition.

What to do next

You can use the **loadopt** command to load file-backed virtual optical media into the file-backed virtual optical device.

If you later need to remove the virtual target device, you can do so by using the **rmvdev** command.

Related information:

- ➔ Creating a virtual disk for a VIOS logical partition using the HMC
- ➔ Virtual I/O Server and Integrated Virtualization Manager commands

Setting the reserve policy attributes of a device:

In some configurations, you must consider the reservation policy of the device on the Virtual I/O Server (VIOS).

About this task

The following table explains the situations in which the reservation policy of the device on the VIOS is important for systems that are managed by the Hardware Management Console (HMC) and the Integrated Virtualization Manager (IVM).

Table 34. Situations where the reservation policy of a device is important

| HMC-managed systems | IVM-managed systems |
|--|---|
| <ul style="list-style-type: none">• To use a Multipath I/O (MPIO) configuration at the client, none of the virtual Small Computer Serial Interface (SCSI) devices on the VIOS can reserve the virtual SCSI device. Set the <code>reserve_policy</code> attribute of the device to <code>no_reserve</code>.• For virtual SCSI devices used with Live Partition Mobility or the Suspend/Resume feature, the reserve attribute on the physical storage that is used by the mobile partition can be set as follows:<ul style="list-style-type: none">– You can set the reserve policy attribute to <code>no_reserve</code>.– You can set the reserve policy attribute to <code>pr_shared</code> when the following products are at the following versions:<ul style="list-style-type: none">- HMC Version 7 release 3.5.0, or later- VIOS Version 2.1.2.0, or later- The physical adapters support the SCSI-3 Persistent Reserves standard <p>The reserve attribute must be the same on the source and destination VIOS partitions for successful partition mobility.</p> <ul style="list-style-type: none">• For PowerVM Active Memory Sharing or Suspend/Resume features, the VIOS automatically sets the reserve attribute on the physical volume to <code>no_reserve</code>. The VIOS performs this action when you add a paging space device to the shared memory pool. | <p>For virtual SCSI devices used with Live Partition Mobility, the reserve attribute on the physical storage that is used by the mobile partition can be set as follows:</p> <ul style="list-style-type: none">• You can set the reserve policy attribute to <code>no_reserve</code>.• You can set the reserve policy attribute to <code>pr_shared</code> when the following products are at the following versions:<ul style="list-style-type: none">– IVM Version 2.1.2.0, or later– The physical adapters support the SCSI-3 Persistent Reserves standard <p>The reserve attribute must be the same on the source and destination management partitions for successful partition mobility.</p> |

Procedure

1. From a VIOS partition, list the disks (or paging space devices) to which the VIOS has access. Run the following command:

```
lsdev -type disk
```
2. To determine the reserve policy of a disk, run the following command, where `hdiskX` is the name of the disk that you identified in step 1. For example, `hdisk5`.

```
lsdev -dev hdiskX -attr reserve_policy
```

The results might look like the following output:

```
..
reserve_policy  no_reserve                                Reserve Policy                                True
```

Based on the information in Table 34 on page 108, you might need to change the `reserve_policy` so that you can use the disk in any of the described configurations.

3. To set the `reserve_policy`, run the **chdev** command. For example:

```
chdev -dev hdiskX -attr reserve_policy=reservation
```

where:

- *hdiskX* is the name of the disk for which you want to set the `reserve_policy` attribute to `no_reserve`.
 - *reservation* is either `no_reserve` or `pr_shared`.
4. Repeat this procedure from the other VIOS partition.

Requirements:

- a. Although the `reserve_policy` attribute is an attribute of the device, each VIOS saves the value of the attribute. You must set the `reserve_policy` attribute from both VIOS partitions so that both VIOS partitions recognize the `reserve_policy` of the device.
- b. For partition mobility, the `reserve_policy` on the destination VIOS partition must be the same as the `reserve_policy` on the source VIOS partition. For example, if the `reserve_policy` on the source VIOS partition is `pr_shared`, the `reserve_policy` on the destination VIOS partition must also be `pr_shared`.

Related information:

 [Setting the reserve policy attributes of a device on the SDMC](#)

Creating logical volume storage pools on a Virtual I/O Server

You can create a logical volume storage pool on a Virtual I/O Server using the Hardware Management Console or the **mksp** and **mkbdsp** commands.

Before you begin

Before you start, ensure that the Virtual I/O Server is at Version 1.5 or later.

Tip: If you are using the HMC, Version 7 release 3.4.2 or later, you can use the HMC graphical interface to create logical volume storage pools on the Virtual I/O Server.

About this task

Logical volume storage pools are volume groups, which are collections of one or more physical volumes. The physical volumes that comprise a logical volume storage pool can be of varying sizes and types.

To create a logical volume storage pool, complete the following steps from the Virtual I/O Server command-line interface:

Procedure

1. Create a logical volume storage pool by running the **mksp** command:

```
mksp -f dev_clients hdisk2 hdisk4
```

In this example, the name of the storage pool is `dev_clients` and it contains `hdisk2` and `hdisk4`.



2. Define a logical volume, which will be visible as a disk to the client logical partition. The size of this logical volume will act as the size of disks that will be available to the client logical partition. Use the **mkbdsp** command to create a 11 GB logical volume called `dev_dbsrv` as follows:

```
mkbdsp -sp dev_clients 11G -bd dev_dbsrv
```

If you also want to create a virtual target device, which maps the virtual Small Computer Serial Interface (SCSI) server adapter to the logical volume, add `-vadapter vhostx` to the end of the command. For example:

```
mkbdsp -sp dev_clients 11G -bd dev_dbsrv -vadapter vhost4
```

Related information:

-  Creating storage pools on a Virtual I/O Server by using the HMC
-  Virtual I/O Server and Integrated Virtualization Manager commands

Creating file storage pools on a Virtual I/O Server

You can create a file storage pool on a Virtual I/O Server using the `mksp` and `mkbdsp` commands.

Before you begin

Before you start, ensure that the Virtual I/O Server is at Version 1.5 or later.

Tip: If you are using the HMC, Version 7 release 3.4.2 or later, you can use the HMC graphical interface to create file storage pools on the Virtual I/O Server.

About this task

File storage pools are created within a parent logical volume storage pool and contain a logical volume containing a file system with files.

To create a file storage pool, complete the following steps from the Virtual I/O Server command-line interface:

Procedure

1. Create a file storage pool by running the `mksp` command:

```
mksp -fb dev_fbclt -sp dev_clients -size 7g
```

In this example, the name of the file storage pool is `dev_fbclt` and the parent storage pool is `dev_clients`.



2. Define a file, which will be visible as a disk to the client logical partition. The size of the file determines the size of the disk presented to the client logical partition. Use the `mkbdsp` command to create a 3 GB file called `dev_dbsrv` as follows:

```
mkbdsp -sp dev_fbclt 3G -bd dev_dbsrv
```

If you also want to create a virtual target device, which maps the virtual Small Computer Serial Interface (SCSI) server adapter to the file, add `-vadapter vhostx` to the end of the command. For example:

```
mkbdsp -sp dev_fbclt 3G -bd dev_dbsrv -vadapter vhost4
```

Related information:

-  Creating storage pools on a Virtual I/O Server by using the HMC
-  Virtual I/O Server and Integrated Virtualization Manager commands

Creating the virtual media repository on a Virtual I/O Server

You can create the virtual media repository on a Virtual I/O Server using the `mkrep` command.

Before you begin

Before you start, ensure that the Virtual I/O Server is at Version 1.5 or later.

About this task

The virtual media repository provides a single container to store and manage file-backed virtual optical media files. Media stored in the repository can be loaded into file-backed virtual optical devices for exporting to client partitions.

Only one repository can be created within a Virtual I/O Server.

Tip: If you are using the HMC, Version 7 release 3.4.2 or later, you can use the HMC graphical interface to create a virtual media repository on the Virtual I/O Server.



Procedure

To create the virtual media repository from the Virtual I/O Server command-line interface, run the **mkrep** command:

```
mkrep -sp prod_store -size 6g
```

In this example, the name of the parent storage pool is `prod_store`.

Related information:

-  Changing optical devices by using the Hardware Management Console
-  Virtual I/O Server and Integrated Virtualization Manager commands

Creating volume groups and logical volumes on a Virtual I/O Server

You can create logical volumes and volume groups on a Virtual I/O Server using the **mkvg** and **mklv** commands.

About this task

If you are using the HMC, Version 7 release 3.4.2 or later, you can use the HMC graphical interface to create volume groups and logical volumes on a Virtual I/O Server.

Otherwise, use the **mklv** command from the Virtual I/O Server command-line interface. To create the logical volume on a separate disk, you must first create a volume group and assign one or more disks by using the **mkvg** command.



Procedure

1. Create a volume group and assign a disk to this volume group by using the **mkvg** command. In this example, the name of the volume group is `rootvg_clients`

```
mkvg -f -vg rootvg_clients hdisk2
```
2. Define a logical volume, which will be visible as a disk to the client logical partition. The size of this logical volume will act as the size of disks that will be available to the client logical partition. Use the **mklv** command to create a 2 GB logical volume as follows:

```
mklv -lv rootvg_dbsrv rootvg_clients 2G
```

Related information:

-  Changing a physical volume for a VIOS logical partition using the HMC
-  Changing a storage pool for a VIOS logical partition using the HMC

Configure the Virtual I/O Server to support SCSI-2 reserve functions

Understand the virtual Small Computer Serial Interface (SCSI) setup requirements to support applications using SCSI reserve and release.

About this task

Virtual I/O Server Versions 1.3 and later provide support for applications that are enabled to use SCSI-2 reserve functions that are controlled by the client logical partition. Typically, SCSI reserve and release is used in clustered environments where contention for SCSI disk resources might require greater control. To ensure that Virtual I/O Server supports these environments, configure the Virtual I/O Server to support SCSI-2 reserve and release. If the applications you are using provide information about the policy to use for the SCSI-2 reserve functions on the client logical partition, follow those procedures for setting the reserve policy.

Complete the following tasks to configure the Virtual I/O Server to support SCSI-2 reserve environments:

Procedure

1. Configure the Virtual I/O Server `reserve_policy` for `single_path`, using the following command:

```
chdev -dev1 hdiskN -attr reserve_policy=single_path
```

Note: Perform this task when the device is not in use. If you run this command while the device is open or in use, then you must use the **-perm** flag with this command. If you use the **-perm** flag, the changes do not take effect until the device is unconfigured and reconfigured.

2. Configure the `client_reserve` feature on the Virtual I/O Server.

- If you are creating a virtual target device, use the following command:

```
mkvdev -vdev hdiskN -vadapter vhostN -attr client_reserve=yes
```

where *hdiskN* is the virtual target device name and *vhostN* is the virtual SCSI server adapter name.

- If the virtual target device has already been created, use the following command:

```
chdev -dev vtscsiN -attr client_reserve=yes
```

where *vtscsiN* is the virtual device name.

Note: If the `client_reserve` attribute is set to `yes`, you cannot set the `mirrored` attribute to `true`. This is because the `client_reserve` and Peer-to-Peer Remote Copy (PPRC) features are mutually exclusive.

3. On the Virtual client, complete the following steps to configure the SCSI reserve and release support for the virtual disk backed by the physical disk that you configured in step 1. This is specific to an AIX client.

- a. Set the reserve policy on the Virtual client to `single_path`, using the following command:

```
chdev -a reserve_policy=single_path -l hdiskN
```

where *hdiskN* is the virtual disk name

Note: Perform this task when the device is not in use. If you run this command while the device is open or in use, then you must use the **-P** flag. In that case, the changes do not take effect until the device is unconfigured and reconfigured.

- b. Set the `hcheck_cmd` attribute so that the MPIO code uses the inquiry option. If the `hcheck_cmd` attribute is set to **test unit ready** and the backing device is reserved, then `test unit ready` will fail and log an error on the client.

```
chdev -a hcheck_cmd=inquiry -l hdiskN
```

where *hdiskN* is the virtual disk name.

Configure the Virtual I/O Server to support exporting the PPRC secondary disk to client partitions

This topic describes how to export a Peer-to-Peer Remote Copy (PPRC) secondary device to a client partition. You can perform this task by creating a virtual target device with the PPRC secondary device as a backing device.

About this task

Virtual I/O Server (VIOS) Versions 2.2.0.0 and later, provide support for devices that are enabled to use the Peer-to-Peer Remote Copy (PPRC) feature. The PPRC feature can be used for real-time mirroring of disks. Typically, a PPRC pair consists of a primary virtual target device and a secondary virtual target device. The secondary virtual target device stores the backup data from the primary virtual target device. To enable exporting of the PPRC secondary virtual target device to a client partition, use the following command:

```
mkvdev -vdev hdiskN -vadaptor vhostN -attr mirrored=true
```

Where:

- *hdiskN* is the secondary virtual target device name
- *vhostN* is the virtual Small Computer Serial Interface (SCSI) server adapter name

Identifying exportable disks

To export a physical volume as a virtual device, the physical volume must have an IEEE volume attribute, a unique identifier (UDID), or a physical identifier (PVID).

About this task

To identify exportable disks, complete the following steps:

Procedure

1. Determine whether a device has an IEEE volume attribute identifier by running the following command from the Virtual I/O Server command line:

```
lsdev -dev hdiskX -attr
```

Disks with an IEEE volume attribute identifier have a value in the `ieee_volname` field. Output similar to the following is displayed:

```
...
cache_method    fast_write          Write Caching method
False
ieee_volname    600A0B800012DD0D00000AB441ED6AC IEEE Unique volume name
False
lun_id         0x001a000000000000 Logical Unit Number
False
...
```

If the `ieee_volname` field does not appear, then the device does not have an IEEE volume attribute identifier.

2. If the device does not have an IEEE volume attribute identifier, then determine whether the device has a UDID by completing the following steps:
 - a. Type `oem_setup_env`.
 - b. Type `odmget -qattribute=unique_id CuAt`. The disks that have a UDID are listed. Output similar to the following is displayed:

```
CuAt:
name = "hdisk1"
attribute = "unique_id"
value = "2708ECVBZ1SC10IC35L146UCDY10-003IBXscsi"
type = "R"
```

```

generic = ""
rep = "n1"
nls_index = 79

CuAt:
name = "hdisk2"
attribute = "unique_id"
value = "210800038FB50AST373453LC03IBXscsi"
type = "R"
generic = ""
rep = "n1"
nls_index = 79

```

Devices in the list that are accessible from other Virtual I/O Server partitions can be used in virtual Small Computer Serial Interface (SCSI) MPIO configurations.

c. Type `exit`.

3. If the device does not have either an IEEE volume attribute identifier or a UDID, then determine whether the device has a PVID by running the following command:

```
lspv
```

The disks and their respective PVIDs are listed. Output similar to the following is displayed:

| NAME | PVID | VG | STATUS |
|--------|------------------|--------|--------|
| hdisk0 | 00c5e10c1608fd80 | rootvg | active |
| hdisk1 | 00c5e10cf7eb2195 | rootvg | active |
| hdisk2 | 00c5e10c44df5673 | None | |
| hdisk3 | 00c5e10cf3ba6a9a | None | |
| hdisk4 | none | None | |

4. If the device does not have either an IEEE volume attribute identifier, a UDID, or a PVID, then complete one of the following tasks to assign an identifier:
 - a. Upgrade your vendor software and then repeat this entire procedure, Identifying exportable disks, from the beginning. The latest versions of some vendor software include support for identifying devices using a UDID. Before upgrading, ensure that you preserve any virtual SCSI devices that you created when using the versions of the software that did not support identifying devices using a UDID. For information and upgrade instructions, see the documentation provided by your vendor software.
 - b. If the upgraded vendor software does not produce a UDID or IEEE volume attribute identifier, then put a PVID on the physical volume by running the following command:

```
chdev -dev hdiskX -attr pv=yes
```

Getting started with shared storage pools by using the VIOS command line

Learn about using the Virtual I/O Server (VIOS) command-line interface to manage shared storage pools.

On VIOS Version 2.2.0.11, Fix Pack 24, Service Pack 1, or later, you can create a clustering configuration. VIOS partitions connected to the same shared storage pool must be part of the same cluster. Each cluster has a default storage pool. You can use the VIOS command-line interface to manage shared storage pools.

Notes:

- On VIOS Version 2.2.0.11, Fix Pack 24, Service Pack 1, a cluster consists of only one VIOS partition. VIOS Version 2.2.1.0 supports only one cluster in a VIOS partition.
- On VIOS Version 2.2.1.3, or later, a cluster consists of up to four networked VIOS partitions.

The following sections describe how you can create a configuration of a cluster with each cluster consisting of two VIOS partitions and several client partitions that use logical units, and how you can use the VIOS command-line interface.

To perform the shell command operations listed in the following sections on the VIOS, log in to the VIOS by using the **padmin** user ID.

Configuring the system to create shared storage pools

Learn about configuring the system to create Virtual I/O Server (VIOS) shared storage pools.

Before creating shared storage pools, ensure that all logical partitions are preconfigured by using the Hardware Management Console (HMC) as described in this topic. The names of logical partitions, clusters, logical units, and storage pool names must not contain more than 16 characters in length.

Configuring the VIOS logical partitions

Configure four VIOS logical partitions with the following characteristics:

- There must be at least one CPU and one physical CPU of entitlement.
- The logical partitions must be configured as VIOS logical partitions.
- The logical partitions must consist of at least 4 GB of memory.
- The logical partitions must consist of at least one physical Fibre Channel adapter.
- The rootvg device for a VIOS logical partition cannot be included in storage pool provisioning.
- The associated rootvg device must be installed with VIOS Version 2.2.1.3, or later.
- The VIOS logical partition must be configured with sufficient number of virtual server Small Computer Serial Interface (SCSI) adapter connections required for the client logical partitions.
- The VIOS logical partitions in the cluster require access to all the SAN-based physical volumes in the shared storage pool of the cluster.

One VIOS logical partition must have a network connection either through an Integrated Virtual Ethernet adapter or through a physical adapter.

Note: In shared storage pools, the Shared Ethernet Adapter must be in threaded mode. For more information, see “Network attributes” on page 236.

Restriction: You cannot use the logical units in a cluster as paging devices for PowerVM Active Memory Sharing or Suspend/Resume features.

Configuring client logical partitions

Configure client logical partitions with the following characteristics:

- The client logical partitions must be configured as AIX or Linux client systems.
- They must have at least 1 GB of minimum memory.
- The associated rootvg device must be installed with the appropriate AIX or Linux system software.
- Each client logical partition must be configured with a sufficient number of virtual SCSI adapter connections to map to the virtual server SCSI adapter connections of the required VIOS logical partitions.

You can define more client logical partitions.

Storage provisioning

When a cluster is created, you must specify one physical volume for the repository physical volume and at least one physical volume for the storage pool physical volume. The storage pool physical volumes are used to provide storage to the actual data generated by the client partitions. The repository physical volume is used to perform cluster communication and store the cluster configuration. The maximum client storage capacity matches the total storage capacity of all storage pool physical volumes. The

repository disk must have at least 20 GB of available storage space. The physical volumes in the storage pool must have at least 20 GB of available storage space in total.

Use any method that is available for the SAN vendor to create each physical volume with at least 20 GB of available storage space. Map the physical volume to the logical partition Fibre Channel adapter for each VIOS in the cluster. The physical volumes must only be mapped to the VIOS logical partitions connected to the shared storage pool.

Note: Each of the VIOS logical partitions assign *hdisk* names to all physical volumes available through the Fibre Channel ports, such as *hdisk0* and *hdisk1*. The VIOS logical partition might select different *hdisk* numbers for the same volumes to the other VIOS logical partition in the same cluster. For example, the *viosA1* VIOS logical partition can have *hdisk9* assigned to a specific SAN disk, whereas the *viosA2* VIOS logical partition can have the *hdisk3* name assigned to that same disk. For some tasks, the unique device ID (UDID) can be used to distinguish the volumes. Use the **chkdev** command to obtain the UDID for each disk.

Related information:

 [chkdev command](#)

Managing a cluster by using the VIOS command line

You can use the command-line interface on the Virtual I/O Server (VIOS) to manage a cluster and the VIOS logical partitions.

Note: To add or remove devices in a cluster, you must use the Fully Qualified Domain Name (FQDN) of the device.

Creating a cluster with a single VIOS logical partition:

You can create a cluster with a single VIOS logical partition by using the VIOS command-line interface.

Before you begin

Before you start, ensure that the following requirements are satisfied:

1. Log in to the *viosA1* VIOS logical partition by using the **padmin** user ID, which provides a restricted Korn shell environment.
2. Locate the physical volumes to be used for the *clusterA* cluster. For example, entering the `lspv -free` command returns results similar to the following:

| NAME | PVID | SIZE (megabytes) |
|--------|------------------|------------------|
| hdisk0 | none | 17408 |
| hdisk2 | 000d44516400a5c2 | 20480 |
| hdisk3 | 000d4451605a0d99 | 20482 |
| hdisk4 | none | 10250 |
| hdisk5 | none | 20485 |
| hdisk6 | none | 20490 |
| hdisk7 | none | 20495 |
| hdisk8 | none | 20500 |
| hdisk9 | none | 20505 |

The **lspv** command displays a list of physical volumes along with the ID. The physical volume ID indicates that the device might be in use. The system administrator must ensure that the physical volume is not in use before adding it to the cluster repository or shared storage pool. For example, you can select the *hdisk9* physical volume for the repository, and *hdisk5* and *hdisk7* physical volumes for the storage pool.

About this task

To create a cluster with one VIOS logical partition, complete the following steps:

Procedure

1. Run the **cluster** command to create the cluster. In the following example, the storage pool for the *clusterA* cluster is named *poolA*.

```
cluster -create -clustername clusterA -repopvs hdisk9 -spname poolA -sppvs hdisk5 hdisk7 -hostname  
viosA1_HostName
```

Restriction: In a cluster configuration, you cannot change the host name of a VIOS logical partition. To change the host name, perform the following options, as applicable:

- If there are two or more VIOS logical partitions in the cluster, remove the VIOS logical partitions and change the host name. Subsequently, you can recreate the VIOS logical partitions.
 - If there is only one VIOS logical partition in the cluster, you must delete the cluster and change the host name. Subsequently, you can recreate the cluster.
2. After you create the cluster, run the **lspv** command to display the list of all the physical volumes visible to the logical partition. For example, entering the **lspv** command returns results similar to the following:

| NAME | PVID | VG | STATUS |
|--------|------------------|---------------|--------|
| hdisk0 | none | None | |
| hdisk1 | 000d4451b445ccc7 | rootvg | active |
| hdisk2 | 000d44516400a5c2 | 20480 | |
| hdisk3 | 000d4451605a0d99 | 10250 | |
| hdisk4 | none | 20485 | |
| hdisk5 | none | 20490 | |
| hdisk6 | none | 20495 | |
| hdisk7 | none | 20500 | |
| hdisk8 | none | 20505 | |
| hdisk9 | none | caavg_private | active |

Note: The disk for the repository has a volume group name *caavg_private*. Volume group commands such as **exportvg** and **lsvg** must not be run on the repository disk.

3. To display a list of physical volumes for which the usage cannot be determined, run the **lspv** command. For example, entering the **lspv -free** command returns results similar to the following:

| NAME | PVID | SIZE (megabytes) |
|--------|------------------|------------------|
| hdisk0 | none | 17408 |
| hdisk2 | 000d44516400a5c2 | 20480 |
| hdisk3 | 000d4451605a0d99 | 20482 |
| hdisk4 | none | 10250 |
| hdisk6 | none | 20490 |
| hdisk8 | none | 20500 |

4. To display the physical volumes in the storage pool, run the **lspv** command. For example, entering the **lspv -clustername clusterA -sp poolA** command returns results similar to the following:

| PV NAME | SIZE(MB) | PVUIDID |
|---------|----------|----------------------------------|
| hdisk5 | 20480 | 200B75CXHW1026D07210790003IBMfcp |
| hdisk7 | 20495 | 200B75CXHW1020207210790003IBMfcp |

5. To display cluster information, run the **cluster** command. For example, entering the **cluster -status -clustername clusterA** command returns results similar to the following:

```
Partition Name: npiv-fvt-client6.austin.ibm.com  
Partition uuid: f67f82b25a3711df9fc1001a64b913a4  
Partition mtm:  
Partition Number: 3
```

```
Partition Name: npiv-fvt-client7.austin.ibm.com  
Partition uuid: ac68162e5a3911dfada5001a64b924e8  
Partition mtm:  
Partition Number: 7
```

What to do next

To list cluster configuration information, use the **lscluster** command. For example, entering the **lscluster -m** command returns results similar to the following:

Calling node query for all nodes

Node query number of nodes examined: 1

```
Node name: viosA1
Cluster shorthand id for node: 1
uuid for node: ff8dd204-2de1-11e0-beef-00145eb8a94c
State of node: UP NODE_LOCAL
Smoothed rtt to node: 0
Mean Deviation in network rtt to node: 0
Number of zones this node is a member in: 0
Number of clusters node is a member in: 1
CLUSTER NAME      TYPE SHID  UUID
clusterA          local  a3fe209a-4959-11e0-809c-00145eb8a94c
Number of points_of_contact for node: 0
Point-of-contact interface & contact state
n/a
```

For more information, see `lscluster` command.

Related information:

[↗ cluster command](#)

[↗ lspv command](#)

Adding a VIOS logical partition to a cluster:

You can add a VIOS logical partition to a cluster by using the VIOS command-line interface.

About this task

To add a VIOS logical partition to a cluster:

Procedure

1. Run the **cluster** command to add a VIOS logical partition to a cluster. The fully qualified network host name for the VIOS logical partition must be specified. For example,
`cluster -addnode -clustername clusterA -hostname viosA2_hostname`

In this example, the *viosA2* VIOS logical partition is added to the *clusterA* cluster.

2. To display the VIOS logical partitions in the cluster, use the **cluster** command. For example,
`cluster -status -clustername clusterA`
3. Log in to the VIOS logical partition by using the **padmin** user ID to confirm the cluster characteristics as seen by the VIOS logical partition. For example, the cluster characteristics of the *clusterA* cluster as seen by the *viosA2* VIOS logical partition are as follows:

```
cluster -status -clustername clusterA
lssp -clustername clusterA
lssp -clustername clusterA -sp poolA -bd
lspv -clustername clusterA -sp poolA
```

4. You can map the existing logical units to the virtual server adapters of the VIOS logical partitions. In this example, the logical units added to the *viosA1* VIOS logical partition must be visible. However, these logical units are not yet mapped to the virtual server adapters that are provided by the *viosA2* VIOS logical partition. To map existing logical units to the virtual server adapters of the *viosA2* VIOS logical partition (while logged in to the *viosA2* VIOS logical partition) and to list the mappings, enter the following commands:

```
mkbdsp -clustername clusterA -sp poolA -bd luA1 -vadapter vhost0
```



```
mkbdsp -clustername clusterA -sp poolA -bd luA2 -vadapter vhost1
lsmmap -clustername clusterA -all
```

The client systems can now be reconfigured to accommodate the new mappings.

Related information:

-  cluster command
-  lsmmap command
-  lspv command
-  lssp command
-  mkbdsp command

Removing a VIOS logical partition from a cluster:

You can remove a VIOS logical partition from a cluster by using the VIOS command-line interface.

About this task

After adding a logical partition to a cluster and enabling the client mapping to the same logical unit, you can remove the VIOS logical partition from the cluster. To remove a VIOS logical partition from a cluster:

Procedure

1. Run the **cluster** command to remove a VIOS logical partition from a cluster. Specify the fully qualified network host name for the VIOS logical partition. For example,
`cluster -rmnode -clustername clusterA -hostname viosA1_hostname`

Note: You cannot run this command on the VIOS logical partition that is being removed.

2. To verify the removal of the node and the retention of objects that are still logged in to other partitions, run the **cluster** and **lssp** commands. For example,

```
cluster -status -clustername clusterA
lssp -clustername clusterA -sp poolA -bd
lssp -clustername clusterA
lspv -clustername clusterA -sp poolA
```



Note: If the VIOS logical partition is mapped to a logical unit in the storage pool of the cluster, removing that VIOS logical partition from a cluster fails. To remove the logical partition, unmap the logical unit.

Related tasks:

“Unmapping a logical unit” on page 127

You can unmap a logical unit by using the Virtual I/O Server (VIOS) command-line interface.

Related information:

-  cluster command
-  lspv command
-  lssp command

Deleting a cluster:

You can delete a cluster by using the Virtual I/O Server (VIOS) command-line interface.

About this task

Notes:

- You cannot restore a cluster if you delete the cluster. You cannot restore a VIOS logical partition in a cluster if the VIOS logical partition is removed from the cluster.
- Deleting a cluster fails if the VIOS logical partition has any mappings to logical units in the shared storage pool or if there are any logical units within the shared storage pool. Before you perform the delete operation, remove all logical partition mappings and logical units.

To delete a cluster, including the physical volumes provisioned to its storage pool, complete the following steps:

Procedure

1. Run the **cluster** command. For example, enter `cluster -delete -clustername clusterA` to delete the `clusterA` cluster.
2. To verify that the physical volumes are released to the free state, run the **lspv** command. For example, when you enter `lspv -free`, all the physical volumes should be displayed in the free physical volume list.

Related concepts:

“Removing logical units” on page 128

You can remove logical units from the shared storage pool by using the Virtual I/O Server (VIOS) command-line interface.

Related tasks:

“Unmapping a logical unit” on page 127

You can unmap a logical unit by using the Virtual I/O Server (VIOS) command-line interface.

Related information:

 [cluster command](#)

 [lspv command](#)

Managing storage pools by using the VIOS command line

You can use the command-line interface on the Virtual I/O Server (VIOS) to manage shared storage pools.

Adding storage space to the storage pool:

When more storage space is required in a storage pool, you can add one or more physical volumes in the storage pool by using the Virtual I/O Server (VIOS) command-line interface.

Adding physical volumes to the storage pool:

You can add physical volumes to the storage pool by using the Virtual I/O Server (VIOS) command-line interface.

Before you begin

Prerequisites

Before you start, ensure that there are physical volumes capable of being added to the storage pool. To display a list of physical volumes for which the usage cannot be determined, enter the `lspv -free` or `lspv -capable` commands immediately before changing the storage provisioning. Another VIOS logical partition might have taken a physical volume. For example, entering the `lspv -free` command returns results similar to the following:

| NAME | PVID | SIZE (megabytes) |
|--------|------------------|------------------|
| hdisk0 | none | 17408 |
| hdisk3 | 000d4451605a0d99 | 20482 |
| hdisk4 | none | 10250 |
| hdisk6 | none | 20490 |
| hdisk8 | none | 20500 |

List the physical volumes that are capable of being included in the storage pool. For example, entering the `lspv -clustername clusterA -capable` command returns results similar to the following:

| PV NAME | SIZE (MB) | PVUID |
|---------|-----------|---------------------------------|
| hdisk0 | 17408 | 200B75CXHW1025F07210790003IBMfc |
| hdisk3 | 20482 | 200B75CXHW1031007210790003IBMfc |
| hdisk4 | 10250 | 200B75CXHW1031107210790003IBMfc |
| hdisk6 | 20490 | 200B75CXHW1031307210790003IBMfc |
| hdisk8 | 20500 | 200B75CXHW1031A07210790003IBMfc |

To determine if a physical volume is in use, run the `prepdev` command. If the physical volume is in use as a cluster repository disk or as a storage pool disk, you will receive an error message. For example, by entering `prepdev -dev hdisk5`, you can determine if the `hdisk5` physical volume is in use. Output similar to the following is displayed:

```
WARNING!
The VIOS has detected that this physical volume is currently in use. Data will be
lost and cannot be undone when destructive actions are taken. These actions should
only be done after confirming that the current physical volume usage and data are
no longer needed.
The VIOS could not determine the current usage of this device.
```

If the physical volume is in use as a cluster repository disk or as a storage pool disk, you can use the `cleandisk` command to make the physical volume available.

Note: Ensure that the physical volume is no longer required, because running the `cleandisk` command results in loss of data on the physical volume.

- To remove a cluster repository disk signature from the `hdisk4` physical volume, enter the following command:
`cleandisk -r hdisk4`
- To remove a storage pool disk signature from the `hdisk4` physical volume, enter the following command:
`cleandisk -s hdisk4`

About this task

To add one or more physical volumes to a storage pool, complete the following steps:

Procedure

1. Add physical volumes to the storage pool by using the `chsp` command. For example,
`chsp -add -clustername clusterA -sp poolA hdisk4 hdisk8`

In this example, the `hdisk4` and `hdisk8` physical volumes are added to the storage pool.

2. To display the list of physical volumes in the storage pool, use the `lspv` command. For example, entering the `lspv -clustername clusterA -sp poolA` command returns results similar to the following:





| PV NAME | SIZE (MB) | PVUID |
|---------|-----------|---------------------------------|
| hdisk4 | 20485 | 200B75CXHW1031207210790003IBMfc |

| | | |
|--------|-------|----------------------------------|
| hdisk5 | 20495 | 200B75CXHW1031907210790003IBMfcp |
| hdisk6 | 10250 | 200B75CXHW1031107210790003IBMfcp |
| hdisk8 | 20500 | 200B75CXHW1031A07210790003IBMfcp |

- To display the list of the remaining free physical volumes that can be included in the cluster, use the **lspv** command. For example, entering the `lspv -clustername clusterA -capable` command returns results similar to the following:

| PV NAME | SIZE (MB) | PVUIDID |
|---------|-----------|----------------------------------|
| hdisk0 | 17408 | 200B75CXHW1025F07210790003IBMfcp |
| hdisk3 | 20482 | 200B75CXHW1031007210790003IBMfcp |
| hdisk6 | 20490 | 200B75CXHW1031307210790003IBMfcp |
| hdisk9 | 20505 | 200B75CXHW1031A07210790003IBMfcp |

Related information:

-  [chsp command](#)
-  [cleandisk command](#)
-  [lspv command](#)
-  [prepdev command](#)

Replacing physical volumes in the storage pool:

You can replace physical volumes in the storage pool by using the command-line interface on VIOS Version 2.2.1.3, or later.

About this task

When more storage space is needed in a storage pool you can also remove and replace existing physical volumes in a storage pool. If you are replacing the existing physical volume with a physical volume that has a larger capacity, the capacity of the shared storage pool will increase.

Restrictions:

- You can replace physical volumes only in one cluster at a time.
- Do not use this task to only increase the capacity of the shared storage pool.

To remove and replace physical volumes in the storage pool, complete the following steps:

Procedure

- Remove and replace a physical volume that is currently in a storage pool by running the **chsp** command. For example,

```
chsp -replace -clustername clusterA -sp poolA -oldpv hdisk4 -newpv hdisk9
```

In this example, the *hdisk4* physical volume is replaced by the *hdisk9* physical volume in the storage pool. The replaced disk is returned to the free physical volume list.

Note: If the size of physical volume that is being replaced is large, the replace operation might take a longer time to complete.

- To see the new set of physical volumes in the storage pool, run the **lspv** command. For example, entering the `lspv -clustername clusterA -sp poolA` command returns results similar to the following:

| PV NAME | SIZE (MB) | PVUIDID |
|---------|-----------|----------------------------------|
| hdisk0 | 20485 | 200B75CXHW1031207210790003IBMfcp |
| hdisk1 | 20495 | 200B75CXHW1031907210790003IBMfcp |
| hdisk8 | 20500 | 200B75CXHW1031A07210790003IBMfcp |
| hdisk9 | 20505 | 200B75CXHW1031A07210790003IBMfcp |

Related information:

 [chsp command](#)

 [lspv command](#)

Changing the storage threshold:

You can change the threshold limit of the storage usage by using the Virtual I/O Server (VIOS) command-line interface.

The shared storage pool memory is used to store virtual client partition user data. You must view threshold alerts to verify if the free space decreases to a value lower than the acceptable value.

Important: Free space must not reduce to a value below 5% of the total space. If this reduction occurs, I/O operations on the virtual client partition might fail. To avoid this failure, you must add physical volumes to the pool or delete data from the pool to create free space.

The threshold limit for alert generation is a percentage value. If the actual storage usage transitions to a value that is either higher or lower than the threshold limit, an alert is raised and an entry is made into the VIOS error log in the VIOS logical partition that is a Primary Notification Node (PNN). If a PNN does not exist, the error log is created on the Database Node (DBN). To determine whether the VIOS logical partition is a PNN or the DBN, run the `lssrc -ls vio_daemon` command. The system error log is used to track the threshold condition. These conditions are propagated to the Hardware Management Console (HMC) or the Systems Director Management Console (SDMC) if they are connected to the VIOS partition. The threshold limit can be changed to a value from 1% - 99%, with the number representing the amount of free space. The default threshold monitoring is set to alert when the free space decreases to a value lower than 35% of the total capacity.

For example, if the threshold limit is 20% and the amount of free space decreases to a value lower than 20%, an alert is raised with an indication that the threshold limit was exceeded. After you add storage space, by adding storage capacity to the storage pool, and the amount of free space exceeds 20%, another alert is raised with the indication that the threshold is no longer exceeded. An optimum threshold limit depends on the administrative capability to respond to alerts and on how quickly storage is used.

The following list describes how to change the threshold limit, and remove and view threshold alerts:

- To change the threshold limit, run the **alert** command. In the following example, the threshold limit is changed to 10%. Thus, an *exceeded* alert is raised when the free space decreases to a value lower than 10% of the physical storage pool capacity.

```
alert -set -clustername clusterA -spname poolA -type threshold -value 10
```

Note: You can check threshold alerts in the VIOS system error log.

- To remove the threshold alert from the storage pool, enter the `alert -unset` command.

```
alert -unset -clustername clusterA -spname poolA -type threshold
```

Note: If you disable the threshold alert notification feature, a threshold alert will not be raised before the free space in a storage pool decreases to a value lower than the acceptable value. Threshold alerts are important when you use thin-provisioned logical units in shared storage pool.

- To view the threshold alert on the storage pool, enter the `alert -list` command.

```
alert -list -clustername clusterA -spname poolA -type threshold
```

- To list the error log, enter the `errlog -ls | more` command. You can look for log entries containing the following information:

- Information messages
- **VIO_ALERT_EVENT** label
- *Threshold Exceeded* alert

Related information:

 alert command

Managing logical units by using the VIOS command line

You can use the command-line interface on the Virtual I/O Server (VIOS) to manage logical units in shared storage pools.

Provisioning client partitions with logical unit storage:

You can provision client partitions with logical unit storage by using the command-line interface on the Virtual I/O Server (VIOS).

Creating logical units:

You can create logical units and assign the logical units to virtual server adapters by using the Virtual I/O Server (VIOS) command-line interface.

About this task

A logical unit provides the backing storage for the virtual volume of a client partition. By using the following procedure, you can assign a logical unit for each client partition from the shared storage pool of a cluster. Subsequently, you can map the logical unit to the virtual server adapter associated with the virtual Small Computer Serial Interface (SCSI) adapter of the client partition by using the Hardware Management Console (HMC).

When the mapping operations are complete, the logical unit path is similar to the following example:

```
SAN Storage <=> poolA <=> luA1 <=> viosA1 vtscsi0 <=> viosA1 vhost0 <=> client1 vscsi0 <=> client hdisk0.
```

Notes:

- A single logical unit can be mapped by multiple virtual server adapters, and thus, accessed by multiple client partitions. However, this mapping typically requires either an additional software layer such as a database management system or the use of the Persistent Reserves standard to manage access to the shared logical unit.
- A logical unit can be mapped from multiple VIOS partitions to a single virtual client.

To create logical units and assign the logical units to virtual server adapters, complete the following steps:

Procedure

1. Obtain the physical location identifiers for the virtual server adapters by running the **lsmmap** command. For example, entering the `lsmmap -all` command returns results similar to the following:

| SVSA | Physloc | Client Partition ID |
|--------|--------------------------------|---------------------|
| vhost0 | U8203.E4A.10D4451-V4-C12 | 0x00000000 |
| VTD | NO VIRTUAL TARGET DEVICE FOUND | |
| SVSA | Physloc | Client Partition ID |
| vhost1 | U8203.E4A.10D4451-V4-C13 | 0x00000000 |

Where, `Physloc` identifies the VIOS virtual server adapter related to the HMC property for the `viosA1` VIOS logical partition illustrated in the following figure.

General Hardware **Virtual Adapters** Settings Other

Actions ▾

Virtual resources allow for the sharing of physical hardware between logical partitions. The current virtual adapter settings are listed below.

Maximum virtual adapters : * 20

Number of virtual adapters : 6

--- Select Action --- ▾

| Select | Type ^ | Adapter ID ^ | Connecting Partition ^ | Connecting Adapter ^ | Required ^ |
|--------------------------|---------------|--------------|------------------------|----------------------|------------|
| <input type="checkbox"/> | Ethernet | 11 | N/A | N/A | Yes |
| <input type="checkbox"/> | Server SCSI | 12 | Client1(2) | 4 | Yes |
| <input type="checkbox"/> | Server SCSI | 13 | Client2(7) | 3 | Yes |
| <input type="checkbox"/> | Server Serial | 0 | Any Partition | Any Partition Slot | Yes |
| <input type="checkbox"/> | Server Serial | 1 | Any Partition | Any Partition Slot | Yes |
| <input type="checkbox"/> | VASI | 2 | N/A | N/A | N/A |

Total: 6 Filtered: 6 Selected: 0

Where:

- -C12 of the *vhost0* virtual SCSI adapter `physloc` corresponds to the server SCSI adapter ID 12, which maps to virtual SCSI adapter 4 on the *client1* client partition with ID 2
- -C13 of the *vhost1* virtual SCSI adapter `physloc` corresponds to the server SCSI adapter ID 13, which maps to virtual SCSI adapter 3 on the *client2* client partition with ID 7

The virtual target devices (VTD) also consist of a **Physloc** field. However, the **Physloc** field is empty for VTDs because the HMC property is not applicable to a VTD.

2. Create the logical unit by running the **mkbdsp** command. For example:

- The *luA1* logical unit is created in the *poolA* storage pool of the *clusterA* cluster, with thin-provisioning and an initial provisional size of 100 MB.

```
mkbdsp -clustername clusterA -sp poolA 100M -bd luA1
```

- The *luA3* logical unit is created in the *poolA* storage pool of the *clusterA* cluster, with thick-provisioning and an initial provisional size of 100 MB.

```
mkbdsp -clustername clusterA -sp poolA 100M -bd luA3 -thick
```

3. Map the logical unit to the virtual server adapter associated with the client partition by running the **mkbdsp** command. For example:

- The *luA1* logical unit is thin-provisioned and mapped to the *vscsi0* virtual server adapter associated with the *client1* client partition, which the HMC properties and the **lsmap** command indicate as *vhost0*.

```
mkbdsp -clustername clusterA -sp poolA -bd luA1 -vadapter vhost0
```

- The *luA3* logical unit is thick-provisioned and mapped to the *vscsi0* virtual server adapter associated with the *client1* client partition, which the HMC properties and the **lsmap** command indicate as *vhost0*.

```
mkbdsp -clustername clusterA -sp poolA -bd luA3 -vadapter vhost0 -thick
```

4. Create the logical unit in the shared storage pool, and map it to the virtual server adapter associated with the client partition. For example:

- The *luA2* logical unit is created in the *poolA* storage pool of the *clusterA* cluster, with thin-provisioning and an initial provisional size of 200 MB. The *luA2* logical unit is then mapped to the *vscsi0* virtual server adapter associated with the *client2* client partition, which the HMC properties and the **lsmap** command indicate as *vhost1*.

```
mkbdsp -clustername clusterA -sp poolA 200M -bd luA2 -vadapter vhost1 -tn vtscsi1
```

- The *luA4* logical unit is created in the *poolA* storage pool of the *clusterA* cluster, with thick-provisioning and an initial provisional size of 200 MB. The *luA4* logical unit is then mapped to the *vscsi0* virtual server adapter associated with the *client2* client partition, which the HMC properties and the **lsmmap** command indicate as *vhost1*.

```
mkbdsp -clustername clusterA -sp poolA 200M -bd luA4 -vadapter vhost1 -tn vtscsi1 -thick
```

Note: The `-tn vtscsiX` option is not mandatory. If this option is omitted, a default value is used. By specifying the virtual target name, you can run the **lsdevinfo** command and search for information using the target name. In addition, you can map multiple logical units to the same virtual host adapter. The virtual target name is used to distinguish the mappings.

5. Display the logical unit information. For example, entering the `lssp -clustername clusterA -sp poolA -bd` command returns results similar to the following. Here, the logical unit is the backing device, or *bd*.

| LU Name | Size (MB) | ProvisionType | LU UDID |
|---------|-----------|---------------|----------------------------------|
| luA1 | 100 | THIN | 258f9b298bc302d9c7ee368ff50d04e3 |
| luA2 | 200 | THIN | 7957267e7f0ae3fc8b9768edf061d2f8 |
| luA3 | 100 | THICK | 459f9b298bc302fc9c7ee368f50d04e3 |
| luA4 | 200 | THICK | 6657267e7d0ae3fc7b9768edf061d2d2 |



Entering the `lsmmap -all` command returns results similar to the following:

| SVSA | Physloc | Client Partition ID |
|----------------|---------------------------------------|---------------------|
| vhost0 | U8203.E4A.10D4451-V4-C12 | 0x00000002 |
| VTD | vtscsi0 | |
| Status | Available | |
| LUN | 0x8100000000000000 | |
| Backing device | lua1.b1277fffd5f38acb365413b55e51638 | |
| Physloc | | |
| Mirrored | N/A | |
| VTD | vtscsi1 | |
| Status | Available | |
| LUN | 0x8200000000000000 | |
| Backing device | lua2.8f5a2c27dce01bf443383a01c7f723d0 | |
| Physloc | | |
| Mirrored | N/A | |

Results

In the examples in this topic, the *vscsi0* virtual client SCSI adapter on client partitions *Client1* and *Client2* was mapped to the logical units *luA1* and *luA2*.

Related information:

-  [lsmmap command](#)
-  [lssp command](#)
-  [mkbdsp command](#)

Enabling the logical unit backed storage:

You can enable the logical unit backed storage by using the Virtual I/O Server (VIOS) command-line interface.

About this task

To display the virtual physical volumes that the logical units represent in the client environments and enable the logical unit backed storage, complete the following steps:

Procedure

1. Log in to the client as root user.
2. Enter the following commands in the Korn shell:

```
cfgmgr
lspv
lsdev -c adapter -F 'name physloc'
lsdev -t vdisk -F 'name physloc'
```

The **cfgmgr** command reassembles device configuration information and picks up the new mapping for the virtual Small Computer Serial Interface (SCSI) adapter. The **lspv** and **lsdev** commands on the client, and the **lsdev** command on the VIOS can be used to verify the association of the *hdiskX* physical volume and the *vscsiX* virtual SCSI adapter to the *vhostY* virtual server adapter on the VIOS partition (where, X and Y are appropriate instance numbers). After the *vscsiX* to *hdiskX* mapping is verified, the normal volume group, file system management, and I/O can proceed on the client partitions, as if the *hdiskX* physical volume is another direct connection SCSI device. Other than establishing the client virtual physical volume association with a VIOS path, no further action is required on the client. Hence, you can exit the client shell.



These steps are unique to the AIX client. The Linux operating system also supports adding new storage devices dynamically. Run the following commands:

```
ls -vscsi
lsscsi
echo "- - -" > /sys/class/scsi_host/hostX/scan
lsscsi
cat /sys/class/scsi_host/hostX/partition_name
```

The **ls -vscsi** command displays all virtual SCSI host adapters. The **partition_name** attribute displays the connected VIOS partition. Replace *hostX* with the host number to which storage has been added. The **lsscsi** command displays all attached SCSI disks.

Note: When new data is written to the *hdiskX* physical volume, the VIOS logical partition monitors for overruns of threshold limits. A shell connection to each of the logical partitions must be maintained to observe threshold alerts in the VIOS error log. Alerts can also be captured by using management tools. The threshold limit can be changed to avoid or delay the alerts.

Related information:

-  [cfgmgr command](#)
-  [lsdev command](#)
-  [lspv command](#)

Unmapping a logical unit:

You can unmap a logical unit by using the Virtual I/O Server (VIOS) command-line interface.

About this task

To unmap logical units from the virtual server adapter, complete the following steps:

Procedure

1. To display the mapping of the virtual server adapter, enter the **lsmap -all** command.

| SVSA | Physloc | Client Partition ID |
|--------|--------------------------|---------------------|
| vhost0 | U8203.E4A.10D4451-V4-C12 | 0x00000002 |
| VTD | vtscsi0 | |
| Status | Available | |
| LUN | 0x8100000000000000 | |



```
Backing device      testLU.b1277fffdd5f38acb365413b55e51638
Physloc
Mirrored           N/A

VTD                vtscsi1
Status             Available
LUN                0x8200000000000000
Backing device     test_LU.8f5a2c27dce01bf443383a01c7f723d0
Physloc
Mirrored           N/A
```

- To unmap a logical unit, run the **rmbdsp** command with the **-vtd** option. If you do not use the **-vtd** option, the entire logical unit is removed. In the following example, the mapping for the *luA2* logical unit is removed.

```
rmbdsp -vtd vtscsi1
```

Related information:

-  [lsmap command](#)
-  [rmbdsp command](#)

Removing logical units:

You can remove logical units from the shared storage pool by using the Virtual I/O Server (VIOS) command-line interface.

Before removing the logical units from shared storage pools, you must delete the mapping of physical volumes by reconfiguring the clients that reference the logical unit path.

To remove a logical unit from the shared storage pool, use the following commands, as applicable:

- To display logical unit information, run the **lssp** command. For example, entering the **lssp -clustername clusterA -sp poolA -bd** command returns results similar to the following:

```
LU Name   Size (MB)   ProvisionType   LU UDID
-----
luA1      100         THIN            258f9b298bc302d9c7ee368ff50d04e3
luA2      200         THIN            7957267e7f0ae3fc8b9768edf061d2f8
luA3      100         THICK           459f9b298bc302fc9c7ee368f50d04e3
luA4      200         THICK           6657267e7d0ae3fc7b9768edf061d2d2
```

- To remove a logical unit, run the **rmbdsp** command. For example:

```
rmbdsp -clustername clusterA -sp poolA -bd luA2
```

Notes:

- Returning a logical unit to the shared storage pool might cause a storage threshold transition alert.
- If the logical unit is still mapped to a different VIOS logical partition, the **rmbdsp** command fails.
- If the logical unit is only mapped to virtual server adapters on the same VIOS logical partition on which you run the command, the mappings and the logical unit are deleted. To see the VIOS logical partition that actually has the logical unit mapped, run the **lsmap -clustername** command.
- To remove one of the multiple logical units with the same name, specify the unique identifier of the logical unit. For example, when there is a second logical unit *luA1*, entering the following command removes that logical unit.

```
rmbdsp -clustername clusterA -sp poolA -luudid 258f9b298bc302d9c7ee368ff50d04e3
```

- To remove all the logical units from the shared storage pool, run the **rmbdsp** command with the **-all** option.

```
rmbdsp -all
```

The shared storage pool is not removed when all the logical units are removed. All physical volumes previously added to the pool remain in the pool and cannot be removed when the pool exists. Delete the cluster to delete the default pool and recover the physical volumes.

To remove all the logical units, there must be no virtual target device assigned to any logical unit. Run the **rmbdsp** command with the **-vtd** option on each virtual target device assigned to the logical units to ensure that no virtual target device is assigned to any logical unit.

Related tasks:

“Deleting a cluster” on page 119

You can delete a cluster by using the Virtual I/O Server (VIOS) command-line interface.

Related information:

 [lssp command](#)

 [rmbdsp command](#)

Migrating a cluster configuration

You can migrate the cluster that you created and configured on the VIOS logical partition with Version 2.2.0.11, Fix Pack 24, Service Pack 1 to the VIOS logical partition with Version 2.2.1.0, or later. By performing this task, you can restore the previous shared storage pool mappings with a new shared storage pool and database versions.

About this task

To migrate a cluster that you created and configured on the VIOS logical partition with Version 2.2.0.11, Fix Pack 24, Service Pack 1 to the VIOS logical partition with Version 2.2.1.0, or later:

Procedure

1. Create a backup of the cluster that you want to migrate on the VIOS logical partition with Version 2.2.0.11, Fix Pack 24, Service Pack 1. For example:

```
viosbr -backup -file oldCluster -clustername clusterA
```

Save the backup file that is generated on a different system. For example:
oldCluster.clusterA.tar.gz.

2. Reinstall the VIOS logical partition with Version 2.2.1.0, or later.

Note: Do not change the physical volumes that are used for the storage pool.

3. Migrate the backup file created in step 1 to the VIOS logical partition with Version 2.2.1.0, or later. For example:

```
viosbr -migrate -file oldCluster.clusterA.tar.gz
```

This step migrates the backup file to the VIOS logical partition with Version 2.2.1.0, or later. For example: oldCluster_MIGRATED.clusterA.tar.gz.

4. Clean the physical volume that will be used as the cluster repository disk. For example:

```
cleandisk -r hdisk9
```

Note: Do not change the physical volumes that are used for the storage pool.

5. Restore the network devices by using the migrated backup file. For example:

- `viosbr -restore -file oldCluster_MIGRATED.clusterA.tar.gz -clustername clusterA -repopvs hdisk9 -type net`
- `viosbr -restore -file oldCluster_MIGRATED.clusterA.tar.gz -clustername clusterA -subfile clusterAMTM9117-MMA0206AB272P9.xml -type net`

6. Restore the cluster by using the migrated backup file. For example:

- `viosbr -restore -file oldCluster_MIGRATED.clusterA.tar.gz -clustername clusterA -repopvs hdisk9`
- `viosbr -restore -file oldCluster_MIGRATED.clusterA.tar.gz -clustername clusterA -subfile clusterAMTM9117-MMA0206AB272P9.xml`

After a successful restore operation, the cluster and all shared storage pool mappings are configured as in the VIOS logical partition with Version 2.2.0.11, Fix Pack 24, Service Pack 1.

7. Verify that the cluster restored successfully by listing the status of the nodes in the cluster. For example:

```
cluster -status -clustername clusterA
```

8. List the storage mappings on the VIOS. For example:

```
lsmmap -all
```

Getting started with shared storage pools by using the VIOS configuration menu

Learn about using the Virtual I/O Server (VIOS) configuration menu to manage shared storage pools.

On VIOS Version 2.2.0.11, Fix Pack 24, Service Pack 1, or later, you can create a clustering configuration. VIOS partitions connected to the same shared storage pool must be part of the same cluster. Each cluster has a default storage pool. You can use the VIOS command-line interface to manage shared storage pools.

Notes:

- On VIOS Version 2.2.0.11, Fix Pack 24, Service Pack 1, a cluster consists of only one VIOS partition.
- VIOS Version 2.2.1.0 supports only one cluster in a VIOS partition.
- On VIOS Version 2.2.1.3, or later, a cluster consists of up to four networked VIOS partitions.

To access VIOS configuration menu, run the **cfgassist** command from the command-line interface. On the VIOS configuration menu, move the cursor to the **Shared Storage Pools** menu and press Enter. Use the submenus to manage clusters, VIOS logical partitions, storage pools, and logical units in shared storage pools.

To select information, such as existing cluster names, associated storage pool names, snapshot names, and logical unit names on the **Shared Storage Pools** menu, you can use the following wizards on the VIOS configuration menu:

- Cluster and Storage Pool Selection wizard: On the **Shared Storage Pools** menu, you can use the Cluster and Storage Pool Selection wizard to select the name of an existing cluster and associated storage pool. The Cluster and Storage Pool Selection wizard displays the set of cluster names. After you select a cluster, the wizard displays the names of the associated storage pools.
- Logical Unit Selection wizard: On the **Manage Logical Units in Storage Pool** submenu, you can use the Logical Unit Selection wizard to select the names of logical units. You can identify multiple logical unit names, redisplay the Logical Unit Selection wizard, and change the logical unit selection.
- Snapshot Selection wizard: On the **Manage Logical Units in Storage Pool** submenu, you can use the Snapshot Selection wizard to select snapshots and logical units. You can select cluster names and the storage pool name.

Related information:

 [cfgassist command](#)

Managing a cluster by using the VIOS configuration menu

You can use the Virtual I/O Server (VIOS) configuration menu to manage a cluster and the Virtual I/O Server logical partitions.

Creating a cluster:

You can create a cluster in shared storage pools by using the Virtual I/O Server (VIOS) configuration menu.

About this task

To create a cluster in shared storage pools:

Procedure

1. From the **Shared Storage Pools** menu, move the cursor to the **Manage Cluster and VIOS Nodes** submenu and press Enter.
2. From the **Manage Cluster and VIOS Nodes** submenu, move the cursor to the **Create Cluster** option and press Enter. The Create Cluster window opens.
3. Enter the cluster name being created in the **Cluster name** field.
4. Enter the storage pool name in the **Storage Pool name** field.
5. Press F4 or Esc + 4 in the **Physical Volumes for Repository** field and select the repository physical volumes.
6. Press F4 or Esc + 4 in the **Physical Volumes for Storage Pool** field and select the physical volume names for the storage pool.
7. To clean the physical volumes, type yes in the **Clean physical volumes before use** field. Otherwise, type no.
8. Press Enter to create a cluster.
9. In the confirmation window that opens, select **Yes** to proceed with creating the cluster.

Listing all clusters:

You can list all clusters in shared storage pools by using the Virtual I/O Server (VIOS) configuration menu.

About this task

To list all clusters in shared storage pools:

Procedure

1. From the **Shared Storage Pools** menu, move the cursor to the **Manage Cluster and VIOS Nodes** submenu and press Enter.
2. From the **Manage Cluster and VIOS Nodes** submenu, move the cursor to the **List All Clusters** option and press Enter. The list of all clusters that are associated with the VIOS logical partition is displayed.

Deleting a cluster:

You can delete a cluster from shared storage pools by using the Virtual I/O Server (VIOS) configuration menu.

About this task

Notes:

- You cannot restore a cluster if you delete the cluster. You cannot restore a VIOS logical partition in a cluster if the VIOS logical partition is removed from the cluster.
- Deleting a cluster fails if the VIOS logical partition has any mappings to logical units in the shared storage pool or if there are any logical units within the shared storage pool. Before you perform the delete operation, remove all logical partition mappings and logical units.

To delete a cluster from shared storage pools:

Procedure

1. From the **Shared Storage Pools** menu, move the cursor to the **Manage Cluster and VIOS Nodes** submenu and press Enter.

2. From the **Manage Cluster and VIOS Nodes** submenu, move the cursor to the **Delete Cluster** option and press Enter. The Cluster and Storage Pool Selection wizard starts.
3. Select the cluster name to be deleted. The Delete Cluster window displays the cluster name that you selected.
4. Press Enter to delete the cluster.
5. In the confirmation window that opens, select **Yes** to proceed with deleting the cluster.

Related concepts:

“Unmapping logical units” on page 138

Learn about unmapping logical units by using the Virtual I/O Server (VIOS) configuration menu.

Related tasks:

“Deleting a logical unit” on page 139

You can delete a logical unit from shared storage pools by using the Virtual I/O Server (VIOS) configuration menu.

Adding VIOS nodes to a cluster:

You can add Virtual I/O Server (VIOS) nodes to a cluster by using the Virtual I/O Server (VIOS) configuration menu.

About this task

To add VIOS nodes to a cluster:

Procedure

1. From the **Shared Storage Pools** menu, move the cursor to the **Manage Cluster and VIOS Nodes** submenu and press Enter.
2. From the **Manage Cluster and VIOS Nodes** submenu, move the cursor to the **Add VIOS Nodes to Cluster** option and press Enter. The Cluster and Storage Pool Selection wizard starts.
3. Select the cluster name. The Add VIOS Nodes to Cluster window displays the cluster name that you selected.
4. Enter the VIOS node names in the **Network names of Nodes to add** field. Enter multiple node names separated by a space.
5. Press Enter to add the VIOS nodes.
6. In the confirmation window that opens, select **Yes** to proceed with adding the VIOS nodes.

Deleting VIOS nodes from a cluster:

You can delete Virtual I/O Server (VIOS) nodes from a cluster by using the Virtual I/O Server (VIOS) configuration menu.

About this task

To delete VIOS nodes from a cluster:

Procedure

1. From the **Shared Storage Pools** menu, move the cursor to the **Manage Cluster and VIOS Nodes** submenu and press Enter.
2. From the **Manage Cluster and VIOS Nodes** submenu, move the cursor to the **Delete Nodes from Cluster** option and press Enter. The Cluster and Storage Pool Selection wizard starts.
3. Select the cluster name. The nodes of the cluster are displayed.
4. Select one or more nodes and press Enter. The Delete VIOS Nodes From Cluster window opens.
5. Press F4 or Esc + 4 in the **Network names of Nodes to delete** field to change the node selection.

6. Press Enter to delete the VIOS nodes.
7. In the confirmation window that opens, select **Yes** to proceed with deleting the VIOS nodes.

Note: If the VIOS logical partition is mapped to a logical unit in the storage pool of the cluster, deleting VIOS nodes from a cluster fails. To remove the logical partition, unmap the logical unit.

Related concepts:

“Unmapping logical units” on page 138

Learn about unmapping logical units by using the Virtual I/O Server (VIOS) configuration menu.

Listing VIOS nodes in a cluster:

You can list all Virtual I/O Server (VIOS) nodes in a cluster by using the Virtual I/O Server (VIOS) configuration menu.

About this task

To list all Virtual I/O Server nodes in a cluster:

Procedure

1. From the **Shared Storage Pools** menu, move the cursor to the **Manage Cluster and VIOS Nodes** submenu and press Enter.
2. From the **Manage Cluster and VIOS Nodes** submenu, move the cursor to the **List Nodes in Cluster** option and press Enter.
3. Select the cluster name in the window that opens. The list of all VIOS nodes associated with the cluster is displayed.

Managing storage pools by using the VIOS configuration menu

You can use the Virtual I/O Server (VIOS) configuration menu to manage shared storage pools.

Listing storage pools in a cluster:

You can list storage pools in a cluster by using the Virtual I/O Server (VIOS) configuration menu.

About this task

To list storage pools in a cluster:

Procedure

1. From the **Shared Storage Pools** menu, move the cursor to the **Manage Storage Pools in Cluster** submenu and press Enter.
2. From the **Manage Storage Pools in Cluster** submenu, move the cursor to the **List Storage Pools in Cluster** option and press Enter.
3. Select the cluster name in the window that opens. The list of all storage pools associated with the cluster is displayed.

Listing physical volumes in the storage pool:

You can list the physical volumes in the storage pool by using the Virtual I/O Server (VIOS) configuration menu.

About this task

To list the physical volumes in the storage pool:

Procedure

1. From the **Shared Storage Pools** menu, move the cursor to the **Manage Storage Pools in Cluster** submenu and press Enter.
2. From the **Manage Storage Pools in Cluster** submenu, move the cursor to the **List Physical Volumes in Storage Pool** option and press Enter. The Cluster and Storage Pool Selection wizard starts.
3. Select the cluster name and press Enter.
4. Select the storage pool name and press Enter. The list of all physical volumes associated with the storage pool is displayed.

Adding storage space to the storage pool:

When more storage space is required in a storage pool, you can use the Virtual I/O Server (VIOS) configuration menu to add one or more physical volumes to the storage pool.

Adding physical volumes to the storage pool:

You can add physical volumes to the storage pool by using the Virtual I/O Server (VIOS) configuration menu.

About this task

To add physical volumes to the storage pool:

Procedure

1. From the **Manage Storage Pools in Cluster** submenu, move the cursor to the **Change/Show Physical Volumes in Storage Pool** submenu and press Enter.
2. From the **Change/Show Physical Volumes in Storage Pool** submenu, move the cursor to the **Add Physical Volumes to Storage Pool** option and press Enter. The Cluster and Storage Pool Selection wizard starts.
3. Select the cluster name and press Enter.
4. Select the storage pool name and press Enter. The Add Physical Volumes to Storage Pool window displays the cluster name and storage pool name that you selected.
5. Press F4 or Esc + 4 in the **Physical Volumes to add** field and select the physical volume. You can select multiple physical volumes.
6. To clean the physical volumes, type yes in the **Clean physical volumes before use** field. Otherwise, type no.
7. Press Enter to add the physical volumes to the storage pool.
8. In the confirmation window that opens, select **Yes** to proceed with adding the physical volumes to the storage pool.

Replacing physical volumes in the storage pool:

You can replace physical volumes in the storage pool by using the Virtual I/O Server (VIOS) configuration menu.

About this task

When more storage space is needed in a storage pool you can also remove and replace existing physical volumes in a storage pool. If you are replacing the existing physical volume with a physical volume that has a larger capacity, the capacity of the shared storage pool will increase.

Restrictions:

- You can replace physical volumes only in one cluster at a time.

- Do not use this task to only increase the capacity of the shared storage pool.

To remove and replace physical volumes in the storage pool:

Procedure

1. From the **Manage Storage Pools in Cluster** submenu, move the cursor to the **Change/Show Physical Volumes in Storage Pool** submenu and press Enter.
2. From the **Change/Show Physical Volumes in Storage Pool** submenu, move the cursor to the **Replace Physical Volumes in Storage Pool** option and press Enter. The Cluster and Storage Pool Selection wizard starts.
3. Select the cluster name and press Enter.
4. Select the storage pool name and press Enter. The Replace Physical Volumes in Storage Pool window displays the cluster name and storage pool name that you selected.
5. Press F4 or Esc + 4 in the **Physical Volumes to replace** field and select the physical volume. You can select multiple physical volumes.
6. Press F4 or Esc + 4 in the **Physical Volumes to add** field and select the physical volume. You can select multiple physical volumes.
7. Press Enter to replace the physical volumes in the storage pool.
8. In the confirmation window that opens, select **Yes** to proceed with replacing the physical volumes in the storage pool.

Results

Note: If the size of physical volume that is being replaced is large, the replace operation might take a longer time to complete.

Listing physical volumes in the storage pool:

You can list the physical volumes in the storage pool by using the Virtual I/O Server (VIOS) configuration menu.

About this task

To list the physical volumes in the storage pool:

Procedure

1. From the **Manage Storage Pools in Cluster** submenu, move the cursor to the **Change/Show Physical Volumes in Storage Pool** submenu and press Enter.
2. From the **Change/Show Physical Volumes in Storage Pool** submenu, move the cursor to the **Physical Volumes** option and press Enter. The Cluster and Storage Pool Selection wizard starts.
3. Select the cluster name and press Enter.
4. Select the storage pool name and press Enter. The list of all physical volumes associated with the storage pool is displayed.

Setting and modifying the storage pool threshold alert:

You can use the Virtual I/O Server (VIOS) configuration menu to perform tasks related to setting or modifying the storage pool threshold alert on the VIOS configuration menu.

Listing the storage pool threshold alert value:

You can list the threshold alert value of the storage pool by using the Virtual I/O Server (VIOS) configuration menu.

About this task

To list the threshold alert value of the storage pool:

Procedure

1. From the **Manage Storage Pools in Cluster** submenu, move the cursor to the **Set/Modify Storage Pool Threshold Alert** submenu and press Enter.
2. From the **Set/Modify Storage Pool Threshold Alert** submenu, move the cursor to the **List threshold alert levels in Storage Pool** option and press Enter. The Cluster and Storage Pool Selection wizard starts.
3. Select the cluster name and press Enter.
4. Select the storage pool name and press Enter. The threshold alert value of the storage pool is displayed.

Changing the storage pool threshold alert value:

You can change the threshold alert value of the storage pool by using the Virtual I/O Server (VIOS) configuration menu.

About this task

To change the threshold alert value of the storage pool:

Procedure

1. From the **Manage Storage Pools in Cluster** submenu, move the cursor to the **Set/Modify Storage Pool Threshold Alert** submenu and press Enter.
2. From the **Set/Modify Storage Pool Threshold Alert** submenu, move the cursor to the **Change threshold alert level in Storage Pool** option and press Enter. The Cluster and Storage Pool Selection wizard starts.
3. Select the cluster name and press Enter.
4. Select the storage pool name and press Enter. The Change Threshold Alert Level in Storage Pool window displays the cluster name, storage pool name, and current threshold alert value of the storage pool.
5. Enter the new threshold alert value in the **New threshold alert level** field.
6. Press Enter to update the new threshold alert value.

Removing the storage pool threshold alert value:

You can remove the threshold alert value of the storage pool by using the Virtual I/O Server (VIOS) configuration menu.

About this task

To remove the threshold alert value of the storage pool:

Procedure

1. From the **Manage Storage Pools in Cluster** submenu, move the cursor to the **Set/Modify Storage Pool Threshold Alert** submenu and press Enter.
2. From the **Set/Modify Storage Pool Threshold Alert** submenu, move the cursor to the **Remove threshold alert level in Storage Pool** option and press Enter. The Cluster and Storage Pool Selection wizard starts.
3. Select the cluster name and press Enter.

4. Select the storage pool name and press Enter. The Remove Threshold Alert Level in Storage Pool window displays the cluster name and storage pool name that you selected.
5. Press Enter to remove the threshold alert level of the storage pool.

Managing logical units by using the VIOS configuration menu

You can use the Virtual I/O Server (VIOS) configuration menu to manage logical units in shared storage pools.

Creating and mapping logical units:

You can create and map logical units in shared storage pools by using the Virtual I/O Server (VIOS) configuration menu.

About this task

To create and map logical units in shared storage pools:

Procedure

1. From the **Shared Storage Pools**, move the cursor to the **Manage Logical Units in Storage Pool** submenu and press Enter.
2. From the **Manage Logical Units in Storage Pool** submenu, move the cursor to the **Create and Map Logical Unit** option and press Enter. The Cluster and Storage Pool Selection wizard starts.
3. Select the cluster name and press Enter.
4. Select the storage pool name and press Enter. The Create and Map Logical Unit window displays the cluster name and storage pool name that you selected.
5. Enter the logical unit name being created in the **Logical Unit name** field.
6. Enter the logical unit size in megabytes in the **Logical Unit size** field.
7. Press F4 or Esc + 4 in the **Virtual server adapter to map** field and select the virtual server adapter name that you want to map.
8. Enter the virtual target device name in the **Virtual target device name** field.
9. Press Enter to create and map the logical unit.

Creating logical units:

You can create logical units in shared storage pools by using the Virtual I/O Server (VIOS) configuration menu.

About this task

To create logical units in shared storage pools:

Procedure

1. From the **Shared Storage Pools**, move the cursor to the **Manage Logical Units in Storage Pool** submenu and press Enter.
2. From the **Manage Logical Units in Storage Pool** submenu, move the cursor to the **Create Logical Unit** option and press Enter. The Cluster and Storage Pool Selection wizard starts.
3. Select the cluster name and press Enter.
4. Select the storage pool name and press Enter. The Create Logical Unit window displays the cluster name and storage pool name that you selected.
5. Enter the logical unit name being created in the **Logical Unit name** field.
6. Enter the logical unit size in megabytes in the **Logical Unit size** field.
7. Press Enter to create the logical unit.

Mapping logical units:

You can map an existing logical unit to a virtual server adapter in shared storage pools by using the Virtual I/O Server (VIOS) configuration menu.

About this task

To map an existing logical unit to a virtual server adapter in shared storage pools:

Procedure

1. From the **Shared Storage Pools**, move the cursor to the **Manage Logical Units in Storage Pool** submenu and press Enter.
2. From the **Manage Logical Units in Storage Pool** submenu, move the cursor to the **Map Logical Unit** option and press Enter. The Cluster and Storage Pool Selection wizard starts.
3. Select the cluster name and press Enter.
4. Select the storage pool name and press Enter. The Logical Unit Selection wizard starts.
5. Select the logical unit name and press Enter. The Map Logical Unit window displays the cluster name, storage pool name, and the logical unit name that you selected.
6. Press F4 or Esc + 4 in the **Virtual server adapter to map** field and select the virtual server adapter name that you want to map.
7. Enter the virtual target device name in the **Virtual target device name** field.
8. Press Enter to map the logical unit.

Unmapping logical units:

Learn about unmapping logical units by using the Virtual I/O Server (VIOS) configuration menu.

Unmapping logical units by logical unit name:

You can unmap logical units by selecting the logical unit names by using the Virtual I/O Server (VIOS) configuration menu.

About this task

To unmap logical units by selecting the logical unit names:

Procedure

1. From the **Manage Logical Units in Storage Pool** submenu, move the cursor to the **Unmap Logical Unit** submenu and press Enter.
2. From the **Unmap Logical Unit** submenu, move the cursor to the **Unmap Logical Unit by LU Name** option and press Enter. The Cluster and Storage Pool Selection wizard starts.
3. Select the cluster name and press Enter.
4. Select the storage pool name and press Enter. The Logical Unit Selection By LU Name window opens.
5. Move the cursor to the logical unit names that you want to unmap and press F7 (function key 7). You can select multiple logical unit names. To unmap all logical units, select **ALL**.
6. Press Enter after selecting the logical units to unmap. The Unmap Logical Unit By LU Name window displays the cluster name, storage pool name, and the logical unit names that you selected.
7. Type yes in the **Confirm unmap** field to confirm that you want to unmap the logical units.
8. Press Enter to unmap the logical units.

Unmapping logical units by virtual server adapter name:

You can unmap logical units by virtual server adapter name by using the Virtual I/O Server (VIOS) configuration menu.

About this task

To unmap logical units by selecting the virtual server adapter names:

Procedure

1. From the **Manage Logical Units in Storage Pool** submenu, move the cursor to the **Unmap Logical Unit** submenu and press Enter.
2. From the **Unmap Logical Unit** submenu, move the cursor to the **Unmap Logical Unit by Virtual Server Adapter Name** option and press Enter. The Cluster and Storage Pool Selection wizard starts.
3. Select the cluster name and press Enter.
4. Select the storage pool name and press Enter. The Logical Unit Selection By Virtual Server Adapter Name window opens.
5. Move the cursor to the virtual server adapter names corresponding to the logical unit that you want to unmap and press F7 (function key 7). You can select multiple virtual server adapter names. To select all virtual server adapter names, select **ALL**.
6. Press Enter after selecting the virtual server adapter names. The Unmap Logical Unit By VAdapter window displays the cluster name, storage pool name, and the logical unit names corresponding to the virtual server adapter names that you selected.
7. Type yes in the **Confirm unmap** field to confirm that you want to unmap the logical units.
8. Press Enter to unmap the logical units.

Unmapping logical units by virtual target device name:

You can unmap logical units by virtual target device name by using the Virtual I/O Server (VIOS) configuration menu.

About this task

To unmap logical units by selecting the virtual target device names:

Procedure

1. From the **Manage Logical Units in Storage Pool** submenu, move the cursor to the **Unmap Logical Unit** submenu and press Enter.
2. From the **Unmap Logical Unit** submenu, move the cursor to the **Unmap Logical Unit by Virtual Target Device Name** and press Enter. The Cluster and Storage Pool Selection wizard starts.
3. Select the cluster name and press Enter.
4. Select the storage pool name and press Enter. The Logical Unit Selection By Virtual Target Device Name window opens.
5. Move the cursor to the virtual target device names corresponding to the logical unit that you want to unmap and press F7 (function key 7). You can select multiple virtual target device names. To select all virtual target device names, select **ALL**.
6. Press Enter after selecting the virtual target device names. The Unmap Logical Unit By VTD window displays the cluster name, storage pool name, and the logical unit names corresponding to the virtual target device names that you selected.
7. Type yes in the **Confirm unmap** field to confirm that you want to unmap the logical units.
8. Press Enter to unmap the logical units.

Deleting a logical unit:

You can delete a logical unit from shared storage pools by using the Virtual I/O Server (VIOS) configuration menu.

About this task

To delete a logical unit from shared storage pools:

Procedure

1. From the **Shared Storage Pools**, move the cursor to the **Manage Logical Units in Storage Pool** submenu and press Enter.
2. From the **Manage Logical Units in Storage Pool** submenu, move the cursor to the **Delete Logical Unit** option and press Enter. The Cluster and Storage Pool Selection wizard starts.
3. Select the cluster name and press Enter.
4. Select the storage pool name and press Enter. The Logical Unit Selection wizard starts.
5. Select the logical unit name and press Enter. The Delete Logical Unit window displays the cluster name, storage pool name, and the logical unit name that you selected.
6. Press Enter to delete the logical unit.
7. In the confirmation window that opens, select **Yes** to proceed with deleting the logical unit.

Listing logical units:

You can list logical units in shared storage pools by using the Virtual I/O Server (VIOS) configuration menu.

About this task

To list logical units in shared storage pools:

Procedure

1. From the **Shared Storage Pools**, move the cursor to the **Manage Logical Units in Storage Pool** submenu and press Enter.
2. From the **Manage Logical Units in Storage Pool** submenu, move the cursor to the **List Logical Units** option and press Enter. The Cluster and Storage Pool Selection wizard starts.
3. Select the cluster name and press Enter.
4. Select the storage pool name and press Enter. The list of all logical units associated with the shared storage pool is displayed.

Listing logical unit maps:

You can list the logical unit mappings in shared storage pools by using the Virtual I/O Server (VIOS) configuration menu.

About this task

To list the logical unit mappings in shared storage pools:

Procedure

1. From the **Shared Storage Pools**, move the cursor to the **Manage Logical Units in Storage Pool** submenu and press Enter.
2. From the **Manage Logical Units in Storage Pool** submenu, move the cursor to the **List Logical Unit Maps** option and press Enter. The Cluster and Storage Pool Selection wizard starts.
3. Select the cluster name and press Enter.

4. Select the storage pool name and press Enter. The list of all logical unit mappings associated with the shared storage pool is displayed.

Creating a logical unit snapshot:

You can create snapshots of logical units in shared storage pools by using the Virtual I/O Server (VIOS) configuration menu. Snapshots are images of a single logical unit or multiple logical units.

Before you begin

Note: Before you create a snapshot, perform synchronization of the virtual disk on the client partition.

About this task

To create snapshots of logical units in shared storage pools:

Procedure

1. From the **Shared Storage Pools**, move the cursor to the **Manage Logical Units in Storage Pool** submenu and press Enter.
2. From the **Manage Logical Units in Storage Pool** submenu, move the cursor to the **Create Logical Unit Snapshot** option and press Enter. The Cluster and Storage Pool Selection wizard starts.
3. Select the cluster name and press Enter.
4. Select the storage pool name and press Enter. The Logical Unit Selection wizard starts.
5. Select the logical unit names and press Enter. The Create Logical Unit Snapshot window displays the cluster name, storage pool name, and the logical unit names that you selected.
6. Enter the snapshot name in the **Snapshot name** field.
7. Press Enter to create the snapshot of the logical units.

Listing logical unit snapshots:

Learn about listing snapshots of logical units by using the Virtual I/O Server (VIOS) configuration menu. Snapshots are images of a single logical unit or multiple logical units.

Listing snapshots for a logical unit:

You can list snapshots for a logical unit in shared storage pools by using the Virtual I/O Server (VIOS) configuration menu.

About this task

To list snapshots for a logical unit in shared storage pools:

Procedure

1. From the **Manage Logical Units in Storage Pool** submenu, move the cursor to the **List Logical Unit Snapshot** submenu and press Enter.
2. From the **List Logical Unit Snapshot** submenu, move the cursor to the **List Snapshots for a Logical Unit** option and press Enter. The Cluster and Storage Pool Selection wizard starts.
3. Select the cluster name and press Enter.
4. Select the storage pool name and press Enter.
5. Select the logical unit name in the window that opens and press Enter. The List Snapshots for a Logical Unit window displays the cluster name, storage pool name, and the logical unit names.
6. Press Enter to display the set of snapshots that are associated with the selected logical unit.

Listing logical units in a snapshot:

You can list the logical units in a snapshot in shared storage pools by using the Virtual I/O Server (VIOS) configuration menu.

About this task

To list the logical units in a snapshot:

Procedure

1. From the **Manage Logical Units in Storage Pool** submenu, move the cursor to the **List Logical Unit Snapshot** submenu and press Enter.
2. From the **List Logical Unit Snapshot** submenu, move the cursor to the **List Logical Units in a Snapshot** option and press Enter. The Cluster and Storage Pool Selection wizard starts.
3. Select the cluster name and press Enter.
4. Select the storage pool name and press Enter.
5. Select the snapshot name in the window that opens. The List Logical Units in a Snapshot window displays the cluster name, storage pool name, and the snapshot name.
6. Press Enter to display the set of logical units that are associated with the selected snapshot.

Listing all logical unit snapshots:

You can list all logical unit snapshots in shared storage pools by using the Virtual I/O Server (VIOS) configuration menu.

About this task

To list all logical unit snapshots in shared storage pools:

Procedure

1. From the **Manage Logical Units in Storage Pool** submenu, move the cursor to the **List Logical Unit Snapshot** submenu and press Enter.
2. From the **List Logical Unit Snapshot** submenu, move the cursor to the **List All Logical Unit Snapshots** option and press Enter. The Cluster and Storage Pool Selection wizard starts.
3. Select the cluster name and press Enter.
4. Select the storage pool name and press Enter.
5. Press Enter to display all logical unit snapshots.

Rolling back to the logical unit snapshot:

You can roll back to the logical unit snapshot in shared storage pools by using the Virtual I/O Server (VIOS) configuration menu. Snapshots are images of a single logical unit or multiple logical units.

Before you begin

Note:

- If the logical unit is a rootvg device, you must shut down the client partition before you roll back to the logical unit snapshot.
- If the logical unit is a datavg device, stop access to all the volume groups in the virtual disk by using the **varyoffvg** command.

About this task

To roll back to a logical unit snapshot:

Procedure

1. From the **Shared Storage Pools**, move the cursor to the **Manage Logical Units in Storage Pool** submenu and press Enter.
2. From the **Manage Logical Units in Storage Pool** submenu, move the cursor to the **Roll Back to Snapshot** option and press Enter.
3. Enter the cluster name, storage pool name, the snapshot to roll back to, and the list of logical units and press Enter.
4. Press Enter to roll back to the selected snapshot.
5. In the confirmation window that opens, press Enter to proceed with rolling back to the selected snapshot.

Deleting a logical unit snapshot:

You can delete a logical unit snapshot in shared storage pools by using the Virtual I/O Server (VIOS) configuration menu. Snapshots are images of a single logical unit or multiple logical units.

About this task

To delete a logical unit snapshot:

Procedure

1. From the **Shared Storage Pools**, move the cursor to the **Manage Logical Units in Storage Pool** submenu and press Enter.
2. From the **Manage Logical Units in Storage Pool** submenu, move the cursor to the **Delete Snapshot** option and press Enter.
3. Enter the cluster name, storage pool name, the snapshot to delete, and the list of logical units. Press Enter.
4. Press Enter to delete the selected snapshot.
5. In the confirmation window that opens, press Enter to proceed with deleting the selected snapshot.

Getting started with Trusted Logging

Learn about using the Virtual I/O Server (VIOS) command line to configure the Trusted Logging capability for increased log security.

By using the PowerSC Trusted Logging capability, you can configure AIX logical partitions to write to log files that are stored on an attached VIOS. Data is transmitted to the VIOS directly through the hypervisor. Thus, configured network connectivity is not required between the client logical partitions and the VIOS on which the log files are stored.

The VIOS administrator can create and manage the log files by using the VIOS command-line interface. The following table lists the commands that can be used to configure and manage the Trusted Logging capability.

Table 35. Commands to configure and manage the Trusted Logging capability

| Command | Description |
|----------------|--|
| chvlog | Changes the configuration of an existing virtual log. |
| chvrepo | Changes the configuration of a virtual log repository. |
| lsvlog | Lists the currently defined virtual logs. |

Table 35. Commands to configure and manage the Trusted Logging capability (continued)

| Command | Description |
|-----------------|--|
| lsvlrepo | Lists the current configuration of the virtual log repositories. |
| mkvlog | Creates a new virtual log. |
| rmvlog | Removes an existing virtual log. |

The Trusted Logging capability introduces the following concepts:

- Virtual log repositories
- Virtual logs
- Virtual log devices

These concepts are present in the VIOS as illustrated in the following figure. The virtual log devices are attached to virtual Small Computer Serial Interface (SCSI) adapters to expose the virtual log functions to client logical partitions. The virtual log devices are backed by virtual logs. Virtual logs are present in the VIOS file system as subdirectories within the virtual log repository. The virtual log repository is a directory in the VIOS file system.

The following figure shows the concepts of the Trusted Logging capability.

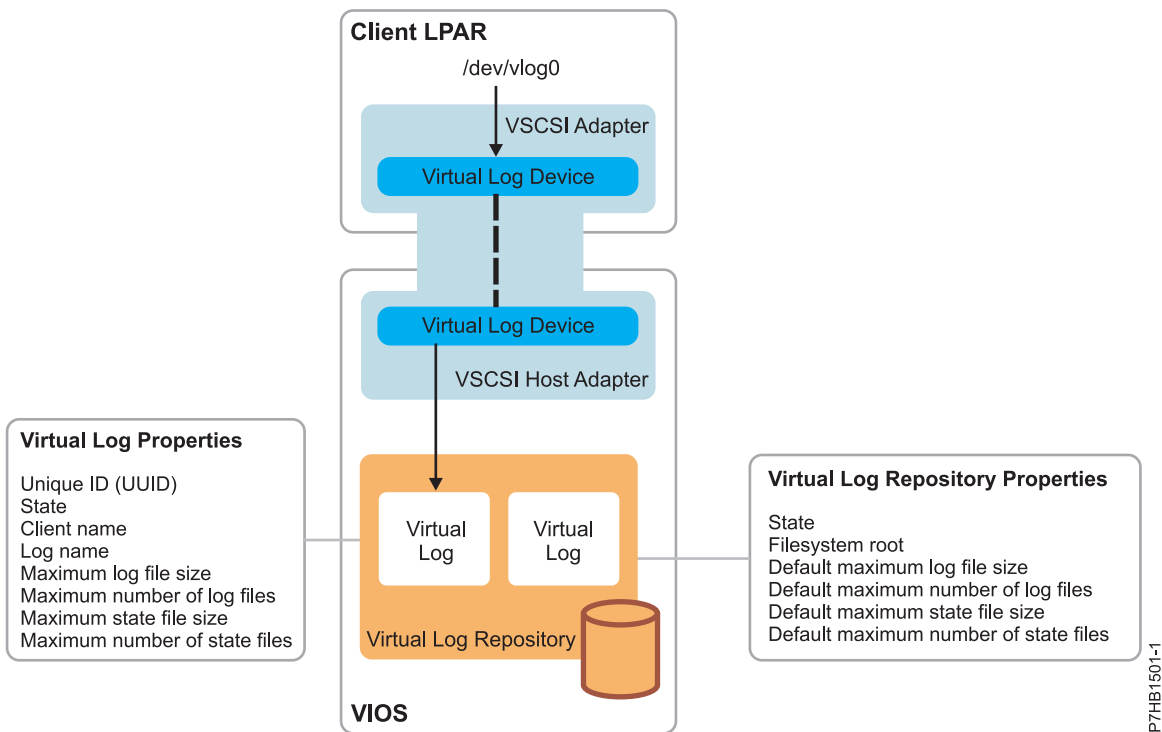

Related reference:

[PowerSC](#)

[Trusted Logging](#)

Related information:

[chvlog command](#)

[chvrepo command](#)

[lsvlog command](#)

[lsvrepo command](#)

[mkvlog command](#)

[rmvlog command](#)

Virtual log repositories

Virtual log repositories are directories in the file system accessible by the Virtual I/O Server (VIOS). You can create one or more virtual logs in a virtual log repository.

Every VIOS has at least the local virtual log repository in the `/var/vio/vlogs` directory by default. If the VIOS is configured to use shared storage pools, there is another repository associated with each shared storage pool. When virtual logs are created, they are placed inside a specified virtual log repository. If an alternative repository is not specified, the local repository is used by default. The VIOS administrator can change the location of the local repository in the file system. However, shared storage pool repositories must reside in a fixed location.

Virtual logs

A virtual log is a directory in a virtual log repository.

The virtual log is used to store logs that are generated by an AIX logical partition. The properties of a virtual log can either be specified or inherited from the virtual log repository when the virtual log is created. The following table lists the virtual log properties.

Table 36. Virtual log properties

| Property | Description |
|------------------|--|
| Unique ID (UUID) | Specifies the unique ID of the virtual log. This value is assigned when the virtual log is created and is retained permanently. If a logical partition is migrated to another system, the virtual log is re-created with the same configuration and unique ID on the destination Virtual I/O Server (VIOS) partition. For more information, see “Live Partition Mobility of virtual log devices” on page 150. |
| State | Indicates whether the virtual log can be attached to a client logical partition. It has the following possible values: <ul style="list-style-type: none">• Enabled: Indicates that the virtual log can be attached to a client logical partition.• Migrated: Indicates that the virtual log is active on another VIOS after a migration operation.• Disabled: Indicates that the virtual log is not available for use by a client logical partition. |
| Client name | Indicates the name of the client. This property can be set to any value. However, typically all virtual logs intended for a particular client logical partition are assigned the same client name, for ease of administration. If a virtual log is created and attached to a client logical partition in a single operation, the VIOS attempts to obtain the host name from the client logical partition and use that as the client name if it is not specified on the command line. |

Table 36. Virtual log properties (continued)

| Property | Description |
|-------------------------------|--|
| Log name | Indicates the name of a virtual log. This property can be assigned any value by the administrator of the client logical partition, depending on the purpose, and must be provided when a new virtual log is created. For example, you can create two virtual logs, <i>audit</i> and <i>syslog</i> , for a given logical partition for the collection of audit and syslog data. |
| Maximum log file size | Specifies the maximum file size of the virtual log in bytes. |
| Maximum number of log files | Specifies the maximum number of virtual log files. |
| Maximum state file size | Specifies the maximum size of the state file in bytes. A state file consists of additional information about when the virtual log devices were configured, opened, closed, and various other operations that might be of interest in an analysis of log activity. |
| Maximum number of state files | Specifies the maximum number of state files. A state file consists of additional information about when the virtual log devices were configured, opened, closed, and various other operations that might be of interest in an analysis of log activity. |

Notes:

- The client name and log name properties also define the directory within the virtual log repository in which the log is stored. A virtual log repository contains a subdirectory for each client name. This subdirectory contains a directory for each log name. For example, with the local virtual log repository set to the default directory `/var/vio/vlogs`, a virtual log with the client name *lpar-01* and the log name *audit* stores the logs in the `/var/vio/vlogs/lpar-01/audit/` directory.
- If you rename the logical partition or change the host name, the client name property is not automatically updated. Use the **chvlog** command to change the value of the client name for the virtual log.

Each virtual log consists of the following types of information:

- Log data: Raw log data generated by the client logical partition. The log data is stored in files named in the *client_name_log_name.nnn* format.
- State data: Additional information about when the virtual log devices were configured, opened, closed, and various other operations that might be of interest in an analysis of log activity. This data is generated without any explicit user action. The state data is stored in files that are named in the *client_name_log_name.state.nnn* format.

In both cases, *nnn* starts at 000. The data is written to that file until the next write operation increases the size of the file to a value more than the maximum log file size. When the size of the file increases to a value more than the maximum log file size, *nnn* is incremented and a new file is created, overwriting any existing file with that name. Log data is written to the new file until *nnn* is incremented again and it reaches the limit specified in the properties of the virtual log. At this stage, *nnn* is reset to 000.

For example, consider a virtual log with the following properties:

```
Client name:          lpar-01
Log name:            audit
Maximum number of log files:  3
Maximum log file size:  2091216
Maximum number of state files: 2
Maximum state file size:  1000000
```

After a period of continued log generation, where the log files might have wrapped multiple times, the following directory contents are expected. The new log data are written to *lpar-01_audit.002* and the new state data are written to *lpar-01_audit.state.000*. For example, running `ls -l /var/vio/vlogs/lpar-01/audit` results in the following output:

```

-rw----- 1 root    system    2091216 May 25 18:28 lpar-01_audit.000
-rw----- 1 root    system    2091216 May 25 18:38 lpar-01_audit.001
-rw----- 1 root    system    752104  May 25 18:48 lpar-01_audit.002
-rw----- 1 root    system    16450   May 25 18:45 lpar-01_audit.state.000
-rw----- 1 root    system    1000000 May 21 07:23 lpar-01_audit.state.001

```

Virtual log devices

A virtual log device is a virtual target device on the Virtual I/O Server (VIOS), attached to a virtual Small Computer Serial Interface (SCSI) host adapter and backed by a virtual log.

By creating virtual log devices, virtual logs are made available to client logical partitions. The following sections describe the use of the local virtual log repositories.

See “Virtual log devices with shared storage pools” on page 150 topic for the commands that can also be used to work with virtual logs within a shared storage pool.

Configuring the virtual log repository

You can configure a virtual log repository by using the **chvlrepo** command. You can display the properties of the virtual log repositories by using the **lsvlrepo** command.

To configure or display the properties of a virtual log repository, use the following commands, as applicable:

- To display the current properties of virtual log repositories, enter the **lsvlrepo** command. Entering the **lsvlrepo -detail** command returns results similar to the following:

```

Local Repository:
State:                enabled
Repository Root:      /var/vio/vlogs
Maximum Log Files:    10
Maximum Log File Size: 2097152
Maximum State Files:  10
Maximum State File Size: 1048576

```

- To display this information in a custom format, use the **-field** flag. Specify a string with field names, separated by characters that are not alphanumeric, to display a customized output. The output contains one line for every virtual log repository. For example, entering the **lsvlrepo -field "state-path lf"** command returns results similar to one of the following:

```

- enabled-/tmp/vlogs/ 10
- disabled-/var/vio/SSP/CTA1/D_E_F_A_U_L_T_061310/vlogs/ 3

```

See **lsvlrepo** command for a list of all field names.

- To change the directory in which virtual logs are stored, enter the **chvlrepo** command. The virtual log repository directory cannot be changed if any virtual logs exist in the repository. To change the directory, enter the following command:

```
chvlrepo -path /mnt/logs
```

- You can change properties, such as the default number and size of log files, by using other options of the **chvlrepo** command. See **chvlrepo** command for a list of all the options. For example, entering the following command changes the default values for virtual logs that are created in the local virtual log repository to have four log files, each up to 3 MB in size, and two state files, each up to 100 KB in size:

```
chvlrepo -lf 4 -lfs 3M -sf 2 -sfs 100K
```

Changing these default values does not change the configuration of existing virtual logs.

- You can also use the **chvlrepo** command to disable the repository to stop the creation of virtual logs. A virtual log repository cannot be disabled if there are any virtual logs in the repository. For example, entering the following command disables the repository:

```
chvlrepo -state disabled
```

Creating a virtual log

You can create a virtual log and attach it to a virtual Small Computer Serial Interface (SCSI) host adapter by using the **mkvlog** command.

About this task

To create a virtual log and attach it to a virtual SCSI (VSCSI) host adapter, complete the following tasks:

Procedure

1. Enter the **mkvlog** command to create virtual logs. For example, entering the `mkvlog -name syslog -client lpar-01` command returns results similar to the following:

```
Virtual log 0000000000000005b3f6b7cfcec4c67 created
```

This command creates the *syslog* virtual log with the *lpar-01* client name and other properties inherited from the default values that are associated with the virtual log repository. The **mkvlog** command returns the UUID that has been assigned to the new virtual log.

2. Attach the virtual log that has been created to a VSCSI host adapter for use by a client logical partition. The VSCSI host adapter must not be configured to use the *Any Client Can Connect* mode. If you specify this mode, you cannot identify the logical partition that generated the log messages in the log files of the virtual log. For example, to attach the virtual log with UUID

`0000000000000005b3f6b7cfcec4c67` to the VSCSI host adapter *vhost0*, enter the following command:

```
mkvlog -uuid 0000000000000005b3f6b7cfcec4c67 -vadapter vhost0
```

Results similar to the following are displayed:

```
vtlog0 Available
```

Results

You can also create a virtual log and attach it to a VSCSI host adapter by using a single command instead of using the commands specified in step 1 and 2. For example, entering the `mkvlog -name audit -vadapter vhost1` command creates a new virtual log with the log name *audit*. This virtual log is attached to the VSCSI host adapter *vhost1*, with the client name set to the host name of the client logical partition that is attached to *vhost1*. Results similar to the following are displayed:

```
Virtual log 000000000000000d96e956aa842d5f4 created
vtlog0 Available
```

Note: If the client logical partition is running, the client name does not need to be specified because the **mkvlog** command discovers the client name from the client logical partition.

Listing virtual logs or virtual log devices

You can list virtual logs or virtual log devices by using the **lsvlog** command.

To list virtual logs or virtual log devices, use the following commands, as applicable:

- To display the properties of virtual logs, enter the **lsvlog** command. For example, entering the **lsvlog** command returns results similar to the following:

| Client Name | Log Name | UUID | VTD |
|-------------|----------|----------------------------------|---------------|
| lpar-03 | syslog | 02392437473b6c552680a9ddd2fd8d06 | vhost1/vtlog1 |
| lpar-02 | syslog | 956f8c1c25208091495c721e0796f456 | vhost0/vtlog0 |
| lpar-01 | audit | 9705340b31a7883573a1cd04b2254efd | |
| lpar-01 | syslog | b27a94a8e187ee5c917577c2a2df0268 | |

- You can filter the output by using options such as **-uuid** to display only the log with a specific UUID. For example, entering the `lsvlog -uuid 02392437473b6c552680a9ddd2fd8d06` command returns results similar to the following:

| Client Name | Log Name | UUID | VTD |
|-------------|----------|----------------------------------|---------------|
| lpar-03 | syslog | 02392437473b6c552680a9ddd2fd8d06 | vhost1/vtlog1 |

- To display all properties for each virtual log, use the **-detail** option. The virtual logs are displayed and are sorted by client name. For example, entering the `lsvlog -uuid 02392437473b6c552680a9ddd2fd8d06 -detail` command returns results similar to the following:

```
Client Name: lpar-03
Log Name:          syslog
UUID:             02392437473b6c552680a9ddd2fd8d06
Virtual Target Device: vtlog1
Parent Adapter:   vhost1
State:            enabled
Logical Unit Address: 8100000000000000
Log Directory:    /var/vio/vlogs/lpar-03/syslog
Maximum Log Files: 10
Maximum Log File Size: 1048576
Maximum State Files: 10
Maximum State File Size: 1048576
```

- To display this information in a custom format, use the **-field** option. Specify a string with field names separated by characters that are not alphanumeric. For example, entering the `lsvlog -field "uuid\tsfs:sf"` command lists all virtual logs. Results similar to the following are displayed:

```
02392437473b6c552680a9ddd2fd8d06      1048576:10
956f8c1c25208091495c721e0796f456     1048576:10
9705340b31a7883573a1cd04b2254efd      1048576:5
b27a94a8e187ee5c917577c2a2df0268     65536:20
```

Related information:

 [lsvlog command](#)

Reconfiguring virtual logs or virtual log devices

You can reconfigure virtual logs or virtual log devices by using the **chvlog** command.

To reconfigure virtual logs or virtual log devices, use the following commands, as applicable:

- To change the properties of a virtual log, enter the **chvlog** command. You can change the properties of virtual logs even if the virtual log is attached to a virtual log device on a virtual Small Computer Serial Interface (SCSI) adapter, and the changes are immediate.
- If the virtual log is connected to a virtual SCSI adapter, it can be specified by using the name of the virtual log device. For example, to change the log file size on the running virtual log device `vtlog0` to 2 MB, enter the `chvlog -dev vtlog0 -lfs 2M` command. Results similar to the following are displayed:
Updated device.
- Regardless of whether a virtual log is connected to a virtual SCSI adapter, a virtual log can always be specified by using the UUID of the virtual log. For example, to change the state of the virtual log with UUID `0000000000000003cee6408c885d677` to disabled, enter the `chvlog -uuid 0000000000000003cee6408c885d677 -state disabled` command. Results similar to the following are displayed:
Updated device.
- The state property for a virtual log controls whether the virtual log can be connected to a virtual SCSI adapter. Therefore, it is not valid to change the state property when the virtual log is attached to a virtual log device. For example, to change the state of the virtual log with UUID `0000000000000003cee6408c885d677` to *disabled* when it is connected to a virtual SCSI host adapter, enter the `chvlog -uuid 0000000000000003cee6408c885d677 -state disabled` command. Results similar to the following are displayed:
To change the state, the virtual log must not be connected to a device.

If you enter the **lsvlog** command, the VTD column is blank for this virtual log.

Note: To delete the virtual log device while retaining the virtual log, use the **rmvlog -d** command.

Removing virtual logs or virtual log devices

You can use the **rmvlog** command to remove virtual logs or virtual log devices from a virtual Small Computer Serial Interface (SCSI) adapter, or to unconfigure a virtual log device. The virtual log can be specified by using the UUID or by the associated virtual log device name, if it exists.

To remove virtual log devices or virtual logs, use the following commands, as applicable:

- To change the specified virtual log device from the *Available* state to the *Defined* state, enter the **rmvlog** command. To specify the virtual log device by name, use the **-dev** option. For example, entering **rmvlog -dev vtlog0** returns results similar to the following:

```
vtlog0 Defined
```

- To specify the virtual log device, use the **-uuid** option. When you use this option, the virtual log device that is currently associated with a virtual log and the specified UUID is changed. For example, entering **rmvlog -uuid 0000000000000000a3e4dd0ba75972c2** returns results similar to the following:

```
vtlog0 Defined
```

- To remove the specified virtual log device, specify the **-d** option in addition to either the **-dev** or **-uuid** option. When you use the **-d** option, the virtual log device is deleted. However, the virtual log and all associated properties and data are retained. For example, entering the **rmvlog -dev vtlog0 -d** returns results similar to the following:

```
vtlog0 deleted
```

- To remove the virtual log device and the virtual log, specify the **-db** option. When you use this option, the data is still retained. For example, entering the **rmvlog -uuid 9705340b31a7883573a1cd04b2254efd -db** command returns results similar to the following:

```
Virtual log 9705340b31a7883573a1cd04b2254efd deleted.
```

- To remove the virtual log device, the virtual log, and any log files that are associated with the virtual log, specify the **-dbdata** option. For example, entering the **rmvlog -dev vtlog0 -dbdata** command returns results similar to the following:

```
vtlog1 deleted
```

```
Virtual log 02392437473b6c552680a9ddd2fd8d06 deleted.
```

```
Log files deleted.
```

Live Partition Mobility of virtual log devices

When a client logical partition is moved from one host system to another during Live Partition Mobility, new virtual log devices are created on the destination Virtual I/O Server (VIOS).

When you do not use Shared Storage Pools, these new virtual logs are independent of the virtual logs on the source VIOS. The configuration data of the source virtual log without the log file content is copied to the destination virtual log during migration. After migration, the source virtual log is placed in the migrated state to indicate that the virtual log is no longer active on the system and that it has been moved to another system. If you use a migration operation to move the client logical partition back to the original host system, and you select the original VIOS to host the virtual logs of the logical partition, the existing virtual log is moved back to the enabled state.

Virtual log devices with shared storage pools

You can use the Trusted Logging feature to direct log data to a file system shared across Virtual I/O Server (VIOS) logical partitions.

By using the Trusted Logging feature with shared storage pools, you can obtain a single view of logical partition activity across several separate systems.

Benefits of using virtual log devices with shared storage pools:

Using virtual log devices with shared storage pools provides multipath logs on a single system and Live Partition Mobility of virtual logs.

You can use the trusted log feature to direct log data to a file system shared across more than one Virtual I/O Server (VIOS) and obtain a single view of logical partition activity across several separate systems. This feature provides the following benefits:

- **Multipath logs on a single system:** By using virtual logs in shared storage pools, more than one VIOS on a single host can make the same virtual log available to a client logical partition through different virtual Small Computer Serial Interface (SCSI) host adapters. The client logical partition detects the multipath arrangement and tolerates the deactivation of a single VIOS by failing over to an alternative path, without losing log data.

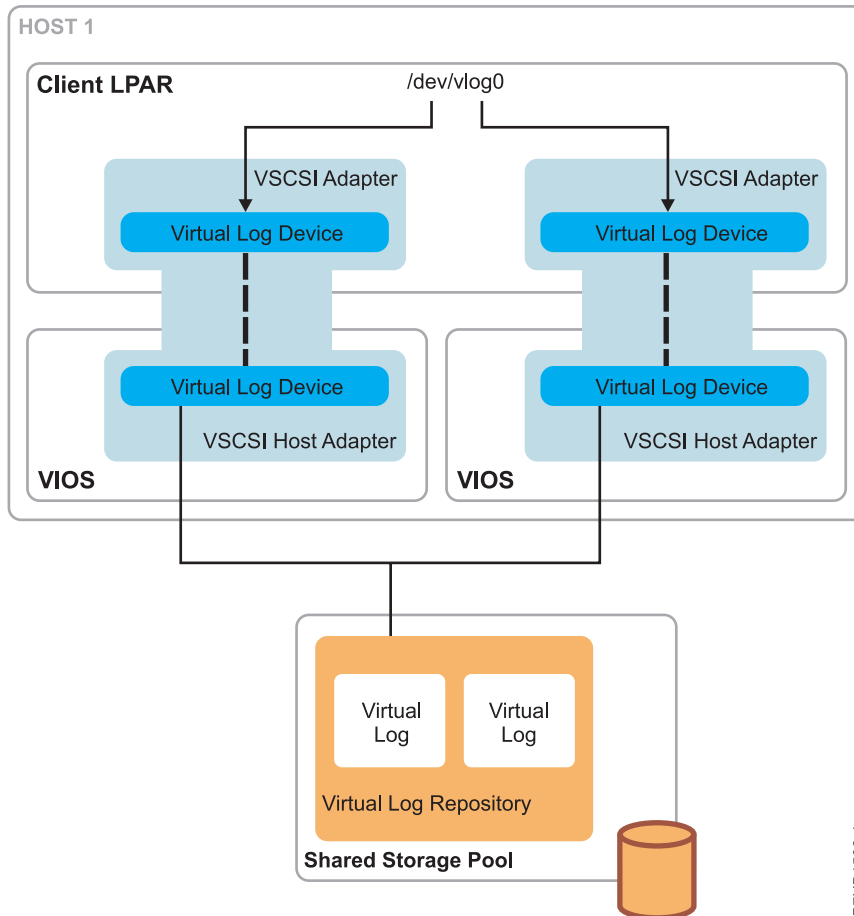

- **Live Partition Mobility of virtual logs:** When VIOS logical partitions on two different hosts have visibility of the same shared storage pool virtual log repository, a migration operation is able to continuously write to a single set of log files inside the shared storage pool, rather than to two different local virtual log repositories. Thus, in contrast to Live Partition Mobility with local virtual log repositories where the log files are split across two file systems, a single log file continues to be written across the migration operation.

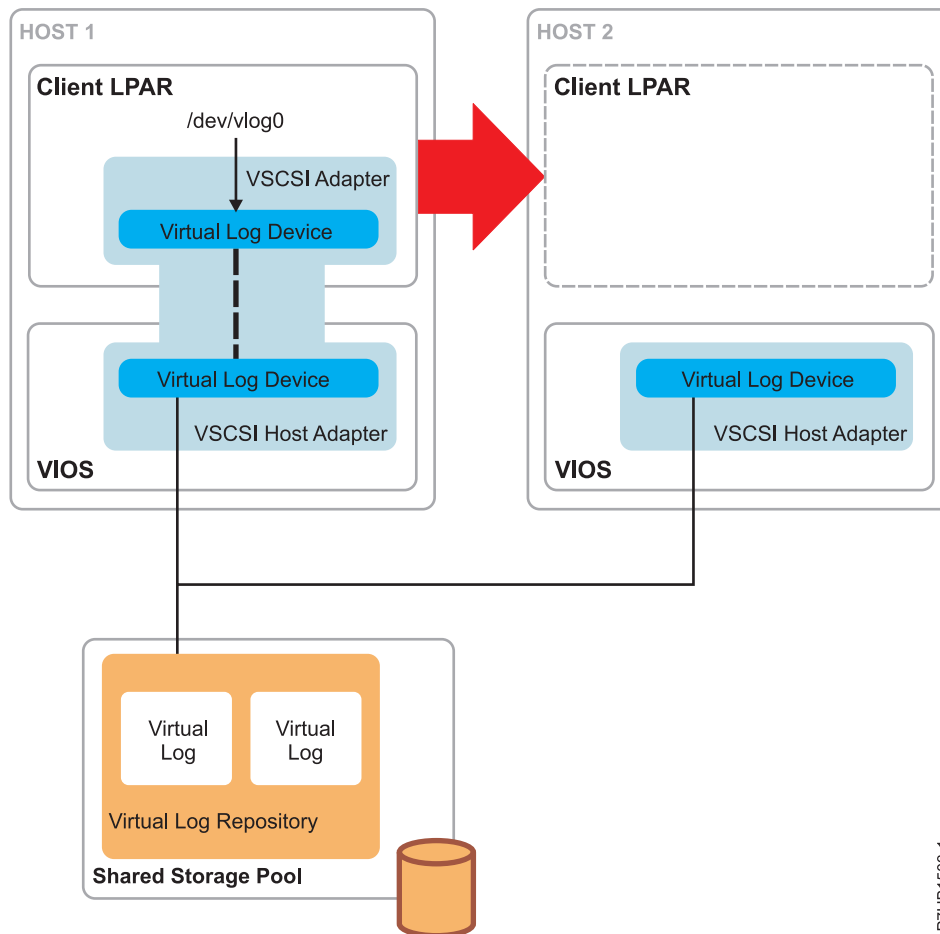

P7HB1503-1

Using virtual log devices with shared storage pools:

Learn about using virtual log devices with shared storage pools.

About this task

To use virtual logs with shared storage pools, the VIOS logical partitions must be clustered together. For instructions, see “Configuring the system to create shared storage pools” on page 115. This process creates a shared storage pool, the name of which is used in virtual log commands to operate on virtual logs within that shared storage pool. To create a virtual log inside a shared storage pool, complete the following tasks:

Procedure

1. Run the `mkvlog` command as described in “Creating a virtual log” on page 148. In addition, specify the `-sp` option to indicate the shared storage pool to use. For example, entering the `mkvlog -sp spool1 -name syslog -client lpar-01` command returns results similar to the following:

```
Virtual log f5dee41bf54660c2841c989811de41dd created
```
2. Attach the virtual log that was created in the shared storage pool to virtual Small Computer Serial Interface (SCSI) adapters. For example, entering the `mkvlog -uuid f5dee41bf54660c2841c989811de41dd -vadapter vhost0` command returns results similar to the following:

```
vtlog1 Available
```

Results

Notes:

- The **lsvlog**, **chvlog** and **rmvlog** commands operate on virtual logs in shared storage pools in the same way that they operate on virtual logs in the local virtual log repository. However, the **chvlog** command cannot be used to change virtual logs that are currently connected to virtual log devices anywhere in the cluster. The virtual log devices must be removed before changes can be made to the virtual log configuration.
- Additionally, the root path to a shared storage pool virtual log repository cannot be changed. The location is decided by the mount point of the shared storage pool on the Virtual I/O Server (VIOS).

Each shared storage pool has a separate virtual log repository with a separate set of default properties that are inherited by virtual logs created within that virtual log repository. By default, the **lsvlrepo** command displays the properties of all virtual log repositories. You can use the **-local** and **-sp** options to display the properties of a specific virtual log repository.

Getting started with Trusted Firewall

Learn about using the Trusted Firewall feature that is supported on the PowerSC Editions. You can use this feature to perform intervirtual LAN routing functions by using the Security Virtual Machine (SVM) kernel extension.

With Virtual I/O Server (VIOS) Version 2.2.1.5, or later, you can configure and manage the Trusted Firewall feature. By using this feature, logical partitions on different VLANs of the same server can communicate through the shared Ethernet adapter. The shared Ethernet adapter calls the intervirtual LAN routing functions through the SVM kernel extension.

The SVM kernel extension consists of the following intervirtual LAN routing functions:

- Layer 3 routing: VLANs represent different logical networks. Hence, a layer 3 router is required to connect the VLANs.
- Network filtering rules: Network filtering rules are required to permit, deny, or route intervirtual LAN network traffic. Network filtering rules can be configured by using the VIOS command-line interface.

The following table lists the commands that can be used to configure and manage the Trusted Firewall feature by using the VIOS command-line interface.

Table 37. Commands to configure and manage the Trusted Firewall feature

| Command | Description |
|-----------------|---|
| chvfilt | Changes the definition of a VLAN-crossing filter rule in the filter rule table. |
| genvfilt | Adds a filter rule for the VLAN-crossing between logical partitions on the same Power Systems server. |
| lsvfilt | Lists the VLAN-crossing filter rules and their status. |
| mkvfilt | Activates the VLAN-crossing filter rules defined by the genvfilt command. |
| rmvfilt | Removes the VLAN-crossing filter rules from the filter table. |
| vlantfw | Displays or clears the IP and Media Access Control (MAC) mappings. |

Related reference:

 [PowerSC](#)

 [Trusted Firewall](#)

Related information:

 [chvfilt command](#)

 [genvfilt command](#)

 [lsvfilt command](#)

 [mkvfilt command](#)

 [rmvfilt command](#)

 [vlanfw command](#)

Configuring virtual Ethernet on the Virtual I/O Server

You can configure virtual Ethernet devices by deploying a system plan, create and configure a Shared Ethernet Adapter, and configure a Link Aggregation device.

Related information:

 [Configuring virtual Ethernet by using the SDMC](#)

Creating a virtual Ethernet adapter by using HMC Version 7

You can create a virtual Ethernet adapter on a Virtual I/O Server (VIOS) so that client logical partitions can access the external network without having to own a physical Ethernet adapter.

Before you begin

If you plan to use a Shared Ethernet Adapter with a Host Ethernet Adapter (or Integrated Virtual Ethernet), ensure that the Logical Host Ethernet Adapter (LHEA) on the Virtual I/O Server is set to promiscuous mode. For instructions, see “Setting the LHEA to promiscuous mode” on page 155.

About this task

To create a virtual Ethernet adapter on the Virtual I/O Server using the Hardware Management Console (HMC), Version 7 or later, complete the following steps:

Procedure

1. In the navigation area, expand **Systems Management** > **Servers** and select the server on which the Virtual I/O Server logical partition is located.
2. In the contents area, select the Virtual I/O Server logical partition.
3. Click **Tasks** and select **Configuration** > **Manage Profiles**. The Managed Profiles page is displayed.
4. Select the profile in which you want to create the Shared Ethernet Adapter and click **Actions** > **Edit**. The Logical Partition Profile Properties page is displayed.
5. Click the **Virtual Adapters** tab.
6. Click **Actions** > **Create** > **Ethernet adapter**.
7. Select **IEEE 802.1Q-compatible adapter**.
8. If you are using multiple VLANs, add any additional VLAN IDs for the client logical partitions that must communicate with the external network using this virtual adapter.
9. Select **Access external network** to use this adapter as a gateway between VLANs and an external network. This Ethernet adapter is configured as part of the Shared Ethernet Adapter.

10. If you are not using Shared Ethernet Adapter failover, you can use the default trunk priority. If you are using Shared Ethernet Adapter failover, then set the trunk priority for the primary share Ethernet adapter to a lower number than that of the backup Shared Ethernet Adapter.
11. When you are finished, click **OK**.
12. Assign or create one of the following real adapters:
 - Assign a physical Ethernet adapter to the Virtual I/O Server.
 - If you plan to aggregate more than one physical Ethernet adapter into a Link Aggregation or EtherChannel device, then assign multiple physical Ethernet adapters to the Virtual I/O Server.
 - If you plan to use the Shared Ethernet Adapter with a Host Ethernet Adapter, then create an LHEA for the Virtual I/O Server logical partition.
13. Click **OK** to exit the Logical Partition Profile Properties page.
14. Click **Close** to exit the Managed Profiles page.
15. Repeat this procedure for additional Shared Ethernet Adapters that you require.

What to do next

When you are finished, configure the Shared Ethernet Adapter using the Virtual I/O Server command-line interface or the Hardware Management Console graphical interface, Version 7 Release 3.4.2 or later.

Note: As an alternative to the HMC, you can use the Systems Director Management Console (SDMC) to create a virtual Ethernet adapter on a VIOS so that client logical partitions can access the external network without having to own a physical Ethernet adapter.

Related tasks:

“Configuring a Shared Ethernet Adapter” on page 156
Find instructions for configuring Shared Ethernet Adapters.

Related information:

 [Creating a Shared Ethernet Adapter by using the SDMC](#)

Setting the LHEA to promiscuous mode:

To use a Shared Ethernet Adapter with a Host Ethernet Adapter (or Integrated Virtual Ethernet), you must set the Logical Host Ethernet Adapter (LHEA) to promiscuous mode.

Before you begin

Before you start, use the Hardware Management Console (HMC) to determine the physical port of the Host Ethernet Adapter that is associated with the Logical Host Ethernet port. Determine this information for the Logical Host Ethernet port that is the real adapter of the Shared Ethernet Adapter on the Virtual I/O Server. You can find this information in the partition properties of the Virtual I/O Server, and the managed system properties of the server on which the Virtual I/O Server is located.

About this task

To set the Logical Host Ethernet port (that is the real adapter of the Shared Ethernet Adapter) to promiscuous mode, complete the following steps using the HMC:

Procedure

1. In the navigation area, expand **Systems Management** and click **Servers**.
2. In the contents area, select the server on which the Virtual I/O Server logical partition is located.
3. Click **Tasks** and select **Hardware (information) > Adapters > Host Ethernet**. The HEAs page is shown.

4. Select the physical location code of the Host Ethernet Adapter.
5. Select the physical port associated with the Logical Host Ethernet port on the Virtual I/O Server logical partition, and click **Configure**. The HEA Physical Port Configuration page is shown.
6. Select **VIOS** in the Promiscuous LPAR field.
7. Click **OK** twice to return to the contents area.

What to do next

Note: As an alternative to the HMC, you can use the Systems Director Management Console (SDMC) to set the Logical Host Ethernet Adapter (LHEA) to promiscuous mode.

Related information:

 [Setting the LHEA to promiscuous mode by using the SDMC](#)

Configuring a Shared Ethernet Adapter

Find instructions for configuring Shared Ethernet Adapters.

Before you begin

Before you can configure a Shared Ethernet Adapter, you must first create the adapter using the Hardware Management Console (HMC). For instructions, see “Creating a virtual Ethernet adapter by using HMC Version 7” on page 154.

About this task

To configure a Shared Ethernet Adapter using the HMC, Version 7 release 3.4.2 or later, see [Creating a shared Ethernet adapter for a Virtual I/O Server logical partition using the Hardware Management Console](#).

To configure a Shared Ethernet Adapter using versions prior to the HMC, Version 7 Release 3.4.2, complete the following steps from the Virtual I/O Server command-line interface:

Procedure

1. Verify that the virtual Ethernet trunk adapter is available by running the following command:
`lsdev -virtual`
2. Identify the appropriate physical Ethernet adapter that will be used to create the Shared Ethernet Adapter by running the following command:
`lsdev -type adapter`

Notes:

- Ensure that TCP/IP is not configured on the interface for the physical Ethernet adapter. If TCP/IP is configured, the `mkvdev` command in the next step fails.
 - You can also use a Link Aggregation, or EtherChannel, device as the Shared Ethernet Adapter.
 - If you plan to use the Host Ethernet Adapter or Integrated Virtual Ethernet with the Shared Ethernet Adapter, ensure that you use the Logical Host Ethernet Adapter to create the Shared Ethernet Adapter.
3. Configure the Shared Ethernet Adapter by running the following command:

```
mkvdev -sea target_device -vadapter virtual_ethernet_adapters \  
-default DefaultVirtualEthernetAdapter -defaultid SEADefaultPVID
```

Where:

target_device

The physical adapter being used as part of the Shared Ethernet Adapter device.

virtual_ethernet_adapters

The virtual Ethernet adapter or adapters that will use the Shared Ethernet Adapter.

DefaultVirtualEthernetAdapter

The default virtual Ethernet adapter used to handle untagged packets. If you have only one virtual Ethernet adapter for this logical partition, use it as the default.

SEADefaultPVID

The PVID associated with your default virtual Ethernet adapter.

For example:

- To create Shared Ethernet Adapter `ent3` with `ent0` as the physical Ethernet adapter (or Link Aggregation) and `ent2` as the only virtual Ethernet adapter (defined with a PVID of 1), type the following command:

```
mkvdev -sea ent0 -vadapter ent2 -default ent2 -defaultid 1
```

- To obtain the value for the `SEADefaultPVID` attribute in the `mkvdev` command, type the following command:

```
enstat -all ent2 | grep "Port VLAN ID:"
```

Output similar to the following example is displayed:

```
Port VLAN ID: 1
```

4. Verify that the Shared Ethernet Adapter was created by running the following command:

```
lsdev -virtual
```
5. Do you plan to access the Virtual I/O Server from the network with the physical device used to create the Shared Ethernet Adapter?
 - Yes: Go to step 6.
 - No: You are finished with this procedure and do not need to complete the remaining steps.
6. Do you plan to set bandwidth apportioning by defining a Quality of Service (QoS)?
 - Yes: Go to step 11 to enable the Shared Ethernet Adapter device to prioritize traffic.
 - No: Go to step 9 to configure a TCP/IP connection.
7. Do you plan to define IP addresses on any VLANs other than the VLAN specified by the PVID of the Shared Ethernet Adapter?
 - Yes: Go to step 8 to create VLAN pseudo-devices.
 - No: Go to step 9 to configure a TCP/IP connection.
8. To configure VLAN pseudo-devices, complete the following steps:

- a. Create a VLAN pseudo-device on the Shared Ethernet Adapter by running the following command:

```
mkvdev -vlan TargetAdapter -tagid TagID
```

Where:

- *TargetAdapter* is the Shared Ethernet Adapter.
- *TagID* is the VLAN ID that you defined when creating the virtual Ethernet adapter associated with the Shared Ethernet Adapter.

For example, to create a VLAN pseudo-device using the Shared Ethernet Adapter `ent3` that you just created with a VLAN ID of 1, type the following command:

```
mkvdev -vlan ent3 -tagid 1
```

- b. Verify that the VLAN pseudo-device was created by running the following command:

```
lsdev -virtual
```
 - c. Repeat this step for any additional VLAN pseudo-devices that you need.
9. Run the following command to configure the first TCP/IP connection. The first connection must be on the same VLAN and logical subnet as the default gateway.

```
mktcpip -hostname Hostname -inetaddr Address -interface Interface -netmask \
SubnetMask -gateway Gateway -nsrvaddr NameServerAddress -nsrvdomain Domain
```

Where:

- *Hostname* is the host name of the Virtual I/O Server
- *Address* is the IP address you want to use for the TCP/IP connection
- *Interface* is the interface associated with either the Shared Ethernet Adapter device or a VLAN pseudo-device. For example, if the Shared Ethernet Adapter device is ent3, the associated interface is en3.
- *Subnetmask* is the subnet mask address for your subnet.
- *Gateway* is the gateway address for your subnet.
- *NameServerAddress* is the address of your domain name server.
- *Domain* is the name of your domain.

If you do not have additional VLANs, then you are finished with this procedure and do not need to complete the remaining step.

10. Run the following command to configure additional TCP/IP connections:

```
chdev -dev interface -perm -attr netaddr=IPaddress -attr netmask=netmask
-attr state=up
```

When using this command, enter the interface (enX) associated with either the Shared Ethernet Adapter device or VLAN pseudo-device.

11. Enable the Shared Ethernet Adapter device to prioritize traffic. Client logical partitions must insert a VLAN priority value in their VLAN header. For AIX clients, a VLAN pseudo-device must be created over the Virtual I/O Ethernet Adapter, and the VLAN priority attribute must be set (the default value is 0). Do the following steps to enable traffic prioritization on an AIX client:

Note: You can also configure VLANs on Linux logical partitions. For more information, see the documentation for the Linux operating system.

- a. Set the Shared Ethernet Adapter `qos_mode` attribute to either `strict` or `loose` mode. Use one of the following commands: `chdev -dev <SEA device name> -attr qos_mode=strict` or `chdev -dev <SEA device name> -attr qos_mode=loose`. For more information about the modes, see Shared Ethernet Adapter.
- b. From the HMC, create a Virtual I/O Ethernet Adapter for the AIX client with all of the tagged VLANs that are required (specified in the Additional VLAN ID list). Packets sent over the default VLAN ID (specified in the **Adapter ID** or **Virtual LAN ID** field) will not be tagged as VLAN; therefore, a VLAN priority value cannot be assigned to them.
- c. On the AIX client, run the **smitty vlan** command.
- d. Select **Add a VLAN**.
- e. Select the name of the Virtual I/O Ethernet Adapter created in step 1.
- f. In the VLAN Tag ID attribute, specify one of the tagged VLANs that are configured on the Virtual I/O Ethernet Adapter that you created in step 1.
- g. Specify an attribute value (0 - 7) in the VLAN Priority attribute, which corresponds to the importance the VIOS should give to the traffic sent over that VLAN pseudo-device.
- h. Configure the interface over the VLAN pseudo-device created in step 6.

Traffic sent over the interface created in step 7 will be tagged as VLAN and its VLAN header will have the VLAN priority value specified in step 6. When this traffic is bridged by a Shared Ethernet Adapter that has been enabled for bandwidth apportioning, the VLAN priority value is used to determine how quickly it should be sent in relation to other packets at different priorities.

Results

The Shared Ethernet Adapter is now configured. After you configure the TCP/IP connections for the virtual adapters on the client logical partitions using the client logical partitions' operating systems, those logical partitions can communicate with the external network.

Related concepts:

“Shared Ethernet Adapter failover” on page 82

Shared Ethernet Adapter failover provides redundancy by configuring a backup Shared Ethernet Adapter on a different Virtual I/O Server logical partition that can be used if the primary Shared Ethernet Adapter fails. The network connectivity in the client logical partitions continues without disruption.

“Shared Ethernet Adapters” on page 37

With Shared Ethernet Adapters on the Virtual I/O Server logical partition, virtual Ethernet adapters on client logical partitions can send and receive outside network traffic.

Related information:

 [Creating a shared Ethernet adapter for a VIOS logical partition using the HMC](#)

 [Virtual I/O Server and Integrated Virtualization Manager commands](#)

Configuring a Link Aggregation or EtherChannel device

Configure a Link Aggregation device, also called an EtherChannel device, by using the `mkvdev` command. A Link Aggregation device can be used as the physical Ethernet adapter in the Shared Ethernet Adapter configuration.

About this task

Configure a Link Aggregation device by typing the following command:

```
mkvdev -lnagg TargetAdapter ... [-attr Attribute=Value ...]
```

For example, to create Link Aggregation device `ent5` with physical Ethernet adapters `ent3`, `ent4`, and backup adapter `ent2`, type the following:

```
mkvdev -lnagg ent3,ent4 -attr backup_adapter=ent2
```

After the Link Aggregation device is configured, you can add adapters to it, remove adapters from it, or modify its attributes using the `cfglnagg` command.

Assigning the virtual Fibre Channel adapter to a physical Fibre Channel adapter

To enable N-Port ID Virtualization (NPIV) on managed systems, connect the virtual Fibre Channel adapter on the Virtual I/O Server logical partition to a physical port on a physical Fibre Channel adapter.

Before you begin

Before you start, verify that the following statements are true:

- Verify that you have created the virtual Fibre Channel adapters on the Virtual I/O Server logical partition and associated them with virtual Fibre Channel adapters on the client logical partition.
- Verify that you have created the virtual Fibre Channel adapters on each client logical partition and associated them with a virtual Fibre Channel adapter on the Virtual I/O Server logical partition.

About this task

After the virtual Fibre Channel adapters are created, you need to connect the virtual Fibre Channel adapter on the Virtual I/O Server logical partition to the physical ports of the physical Fibre Channel adapter. The physical Fibre Channel adapter should be connected to the physical storage that you want the associated client logical partition to access.

Tip: If you are using the HMC, Version 7 Release 3.4.2 or later, you can use the HMC graphical interface to assign the virtual Fibre Channel adapter on a Virtual I/O Server to a physical Fibre Channel adapter.

To assign the virtual Fibre Channel adapter to a physical port on a physical Fibre Channel adapter, complete the following steps from the Virtual I/O Server command-line interface:

Procedure

1. Use the **lsnports** command to display information for the available number of NPIV ports and available worldwide port names (WWPNs). For example, running **lsnports** returns results similar to the following:

| Name | Physloc | fabric | tports | aports | swwpns | awwpns |
|------|----------------------------|--------|--------|--------|--------|--------|
| fcs0 | U789D.001.DQDMLWV-P1-C1-T1 | 1 | 64 | 64 | 2048 | 2047 |
| fcs1 | U787A.001.DPM0WVZ-P1-C1-T2 | 1 | 63 | 62 | 504 | 496 |

Note: If there are no NPIV ports in the Virtual I/O Server logical partition, the error code `E_NO_NPIV_PORTS(62)` is displayed.

2. To connect the virtual Fibre Channel adapter on the Virtual I/O Server logical partition to a physical port on a physical Fibre Channel adapter, run the **vfcmmap** command: `vfcmmap -vadapter virtual Fibre Channel adapter -fcp Fibre Channel port name` where:
 - *Virtual Fibre Channel adapter* is the name of the virtual Fibre Channel adapter created on the Virtual I/O Server logical partition.
 - *Fibre Channel port name* is the name of the physical Fibre Channel port.

Note: If no parameter is specified with the `-fcp` flag, the command unmaps the virtual Fibre Channel adapter from the physical Fibre Channel port.

3. Use the **lsmmap** command to display the mapping between virtual host adapters and the physical devices to which they are backed. To list NPIV mapping information, type: `lsmmap -all -npiv`. The system displays a message similar to the following:

| Name | Physloc | CIntID | CIntName | CIntOS |
|----------|--------------------------|--------|----------|--------|
| vfchost0 | U8203.E4A.HV40026-V1-C12 | 1 | HV-40026 | AIX |

```
Status:NOT_LOGGED_IN
FC name:fcs0      FC loc code:U789C.001.0607088-P1-C5-T1
Ports logged in:0
Flags:1 <not_mapped, not_connected>
VFC client name:  VFC client DRC:
```

What to do next

When you are finished, consider the following tasks:

- For each logical partition, verify that both WWPNs are assigned to the same physical storage and have the same level of access on the storage area network (SAN). For instructions, see the System Storage[®] SAN Volume Controller.

Note: To determine the WWPNs that are assigned to a logical partition, use the Hardware Management Console (HMC) to view the partition properties or partition profile properties of the client logical partition.

- If you later need to remove the connection between the virtual Fibre Channel adapter created on the Virtual I/O Server logical partition and the physical port, you can do so by using the **vfcmap** command and not specifying a parameter for the **-fcp** flag.

Related information:

Configuring a virtual Fibre Channel adapter

 Changing virtual Fibre Channel by using the Hardware Management Console

 Virtual I/O Server and Integrated Virtualization Manager commands

Configuring the Tivoli agents and clients on the Virtual I/O Server

You can configure and start the Tivoli Monitoring agent, Tivoli Usage and Accounting Manager, the Tivoli Storage Manager client, and the Tivoli TotalStorage Productivity Center agents.

Related concepts:

“Tivoli software and the Virtual I/O Server” on page 49

Learn about integrating the Virtual I/O Server into your Tivoli environment for Tivoli Application Dependency Discovery Manager, Tivoli Monitoring, Tivoli Storage Manager, Tivoli Usage and Accounting Manager, Tivoli Identity Manager, and TotalStorage Productivity Center.

Related information:

 `cfgsvc` command

Configuring the Tivoli Monitoring agent

You can configure and start the Tivoli Monitoring agent on the Virtual I/O Server.

Before you begin

With Tivoli Monitoring System Edition , you can monitor the health and availability of multiple servers (including the Virtual I/O Server) from the Tivoli Enterprise Portal. Tivoli Monitoring System Edition gathers data from the Virtual I/O Server, including data about physical volumes, logical volumes, storage pools, storage mappings, network mappings, real memory, processor resources, mounted file system sizes, and so on. From the Tivoli Enterprise Portal, you can view a graphical representation of the data, use predefined thresholds to alert you on key metrics, and resolve issues based on recommendations provided by the Expert Advice feature of Tivoli Monitoring.

Before you start, complete the following tasks:

- Ensure that the Virtual I/O Server is running fix pack 8.1.0.
- Verify that you are a super administrator of the HMC.
- Verify that you are the prime administrator of the Virtual I/O Server.

About this task

To configure and start the monitoring agent, complete the following steps:

Procedure

1. List all of the available monitoring agents using the **lssvc** command. For example,

```
$lssvc
ITM_premium
```
2. Based on the output of the **lssvc** command, decide which monitoring agent you want to configure. For example, `ITM_premium`
3. List all of the attributes that are associated with the monitoring agent using the **cfgsvc** command. For example:

```
$csvgsvc -ls ITM_premium
HOSTNAME
RESTART_ON_REBOOT
MANAGING_SYSTEM
```

4. Configure the monitoring agent with its associated attributes using the **cfgsvc** command:

```
cfgsvc ITM_agent_name -attr Restart_On_Reboot=value hostname=name_or_address1
managing_system=name_or_address2
```

Where:

- *ITM_agent_name* is the name of the monitoring agent. For example, ITM_premium.
- *value* must be either TRUE or FALSE as follows:
 - TRUE: *ITM_agent_name* restarts whenever the Virtual I/O Server restarts
 - FALSE: *ITM_agent_name* does not restart whenever the Virtual I/O Server restarts
- *name_or_address1* is either the host name or IP address of the Tivoli Enterprise Monitoring Server (TEMS) server to which *ITM_agent_name* sends data.
- *name_or_address2* is either the host name or IP address of the Hardware Management Console (HMC) attached to the managed system on which the Virtual I/O Server with the monitoring agent is located.

For example:

```
cfgsvc ITM_premium -attr Restart_On_Reboot=TRUE hostname=tems_server managing_system=hmc_console
```

In this example, the ITM_premium monitoring agent is configured to send data to tems_server, and to restart whenever the Virtual I/O Server restarts.

5. Start the monitoring agent using the **startsvc** command. For example:

```
startsvc ITM_premium
```
6. From the HMC, complete the following steps so that the monitoring agent can gather information from the HMC.

Note: After you configure a secure shell connection for one monitoring agent, you do not need to configure it again for any additional agents.

- a. Determine the name of the managed system on which the Virtual I/O Server with the monitoring agent is located.
- b. Obtain the public key for the Virtual I/O Server by running the following command:

```
viosvr cmd -m managed_system_name -p vios_name -c "cfgsvc -key ITM_agent_name"
```

Where:

- *managed_system_name* is the name of the managed system on which the Virtual I/O Server with the monitoring agent or client is located.
 - *vios_name* is the name of the Virtual I/O Server logical partition (with the monitoring agent) as defined on the HMC.
 - *ITM_agent_name* is the name of the monitoring agent. For example, ITM_premium.
- c. Update the authorized_key2 file on the HMC by running the **mkauthkeys** command:

```
mkauthkeys --add public_key
```

where *public_key* is the output from the **viosvr cmd** command in step 6b.

For example:

```
$ viosvr cmd -m commo126041 -p VIOS7 -c "cfgsvc ITM_premium -key"
ssh-rsa AAAAB3NzaC1yc2EAAAABIwAAAQEA vjDZ
sS0guWz fzf p9BbweG0QMxv1tbDrtyWsgPbA2ExHA+xduWA51K0oFGarK2F
C7e7NjKW+UmqQbrh/KSyKKwozjp4xwGNGhLmfan85ZpFR7wy9UQG1bLgXZ
xYrY7yyQQQDjvwosWafzkjpG3iW/xmWD5PKLBmob2QkKJbxjne+wqGwHT
RYDGI iyhCBI d fFaLZgkXTZ2diZ98rL8LIv3qb+Tsm1B28AL4t+10GGew24
```

```

21sB+8p4kamPJCYfKePHo67yP4NyKyPBFHY3TpTrca4/y1KEBT0Va3Pebr
5JEIUvWYs6/RW+bUQk1Sb6eYbcRJFHhN513F+ofd0vj39zwQ== root@vi
os7.vios.austin.ibx.com
$ mkauthkeys --add 'ssh-rsa AAAAB3NzaC1yc2EAAAABIwAAAQEAjDZ
sS0guWzFzfp9BbweG0QMXv1tbDrtyWsgPbA2ExHA+xduWA51K0oFGarK2F
C7e7NjKW+UmgQbrh/KSyKKwozjp4xWGNghLmfan85ZpFR7wy9UQG1bLgXZ
xYrY7yQQODjvwosWafzkjpG3iW/xmWD5PKLBmob2QkKJbxjne+wqGwHT
RYDGIiyhCBIdfFaLZgkXTZ2diZ98rL8LIv3qb+Tsm1B28AL4t+10GGeW24
21sB+8p4kamPJCYfKePHo67yP4NyKyPBFHY3TpTrca4/y1KEBT0Va3Pebr
5JEIUvWYs6/RW+bUQk1Sb6eYbcRJFHhN513F+ofd0vj39zwQ== root@vi
os7.vios.austin.ibx.com'

```

Results

When you are finished, you can view the data gathered by the monitoring agent from the Tivoli Enterprise Portal.

Related information:

 IBM Tivoli Monitoring version 6.2.1 documentation

 Tivoli Monitoring Virtual I/O Server Premium Agent User's Guide

Configuring the Tivoli Usage and Accounting Manager agent

You can configure and start the Tivoli Usage and Accounting Manager agent on the Virtual I/O Server.

About this task

With Virtual I/O Server 1.4, you can configure the Tivoli Usage and Accounting Manager agent on the Virtual I/O Server. Tivoli Usage and Accounting Manager helps you track, allocate, and invoice your IT costs by collecting, analyzing, and reporting on the actual resources used by entities such as cost centers, departments, and users. Tivoli Usage and Accounting Manager can gather data from multi-tiered datacenters that include Windows, AIX, Virtual I/O Server, HP/UX Sun Solaris, Linux, and VMware.

Before you start, ensure that the Virtual I/O Server is installed. The Tivoli Usage and Accounting Manager agent is packaged with the Virtual I/O Server and is installed when the Virtual I/O Server is installed. For instructions, see “Installing the Virtual I/O Server and client logical partitions” on page 88.

To configure and start the Tivoli Usage and Accounting Manager agent, complete the following steps:

Procedure

1. Optional: Add optional variables to the A_config.par file to enhance data collection. The A_config.par file is located at /home/padmin/tivoli/ituam/A_config.par.

2. List all of the available Tivoli Usage and Accounting Manager agents using the **lssvc** command. For example,

```

$lssvc
ITUAM_base

```

3. Based on the output of the **lssvc** command, decide which Tivoli Usage and Accounting Manager agent you want to configure. For example, ITUAM_base

4. List all of the attributes that are associated with the Tivoli Usage and Accounting Manager agent using the **cfgsvc** command. For example:

```

$cfgsvc -ls ITUAM_base
ACCT_DATA0
ACCT_DATA1
ISYSTEM
IPROCESS

```

5. Configure the Tivoli Usage and Accounting Manager agent with its associated attributes using the **cfgsvc** command:

```
cfgsvc ITUAM_agent_name -attr ACCT_DATA0=value1 ACCT_DATA1=value2 ISYSTEM=value3 IPROCESS=value4
```

Where:

- *ITUAM_agent_name* is the name of the Tivoli Usage and Accounting Manager agent. For example, ITUAM_base.
 - *value1* is the size (in MB) of the first data file that holds daily accounting information.
 - *value2* is the size (in MB) of the second data file that holds daily accounting information.
 - *value3* is the time (in minutes) when the agent generates system interval records.
 - *value4* is the time (in minutes) when the system generates aggregate process records.
6. Start the Tivoli Usage and Accounting Manager agent using the **startsvc** command. For example:
- ```
startsvc ITUAM_base
```

## Results

After you start the Tivoli Usage and Accounting Manager agent, it begins to collect data and generate log files. You can configure the Tivoli Usage and Accounting Manager server to retrieve the log files, which are then processed by the Tivoli Usage and Accounting Manager Processing Engine. You can work with the data from the Tivoli Usage and Accounting Manager Processing Engine as follows:

- You can generate customized reports, spreadsheets, and graphs. Tivoli Usage and Accounting Manager provides full data access and reporting capabilities by integrating Microsoft SQL Server Reporting Services or Crystal Reports with a Database Management System (DBMS).
- You can view high-level and detailed cost and usage information.
- You can allocate, distribute, or charge IT costs to users, cost centers, and organizations in a manner that is fair, understandable, and reproducible.

For more information, see the Tivoli Usage and Accounting Manager Information Center.

### Related reference:

“Configuration attributes for Tivoli agents and clients” on page 227

Learn about required and optional configuration attributes and variables for the Tivoli Monitoring agent, the Tivoli Usage and Accounting Manager agent, the Tivoli Storage Manager client, and the TotalStorage Productivity Center agents.

## Configuring the Tivoli Storage Manager client

You can configure the Tivoli Storage Manager client on the Virtual I/O Server.

### About this task

With Virtual I/O Server 1.4, you can configure the Tivoli Storage Manager client on the Virtual I/O Server. With Tivoli Storage Manager, you can protect your data from failures and other errors by storing backup and disaster-recovery data in a hierarchy of offline storage. Tivoli Storage Manager can help protect computers running a variety of different operating environments, including the Virtual I/O Server, on a variety of different hardware. If you configure the Tivoli Storage Manager client on the Virtual I/O Server, you can include the Virtual I/O Server in your standard backup framework.

Before you start, ensure that the Virtual I/O Server is installed. The Tivoli Storage Manager client is packaged with the Virtual I/O Server and is installed when the Virtual I/O Server is installed. For instructions, see “Installing the Virtual I/O Server and client logical partitions” on page 88.

To configure and start the Tivoli Storage Manager client, complete the following steps:

### Procedure

1. List all of the available Tivoli Storage Manager clients using the **lssvc** command. For example,

```
$lssvc
TSM_base
```

2. Based on the output of the **lssvc** command, decide which Tivoli Storage Manager client you want to configure. For example, `TSM_base`
3. List all of the attributes that are associated with the Tivoli Storage Manager client using the **cfgsvc** command. For example:

```
$cfgsvc -ls TSM_base
SERVERNAME
SERVERIP
NODENAME
```

4. Configure the Tivoli Storage Manager client with its associated attributes using the **cfgsvc** command:  
`cfgsvc TSM_client_name -attr SERVERNAME=hostname SERVERIP=name_or_address NODENAME=vios`

Where:

- *TSM\_client\_name* is the name of the Tivoli Storage Manager client. For example, `TSM_base`.
  - *hostname* is the host name of the Tivoli Storage Manager server to which the Tivoli Storage Manager client is associated.
  - *name\_or\_address* is the IP address or domain name of the Tivoli Storage Manager server to which the Tivoli Storage Manager client is associated.
  - *vios* is the name of the machine on which the Tivoli Storage Manager client is installed. The name must match the name registered on the Tivoli Storage Manager server.
5. Ask the Tivoli Storage Manager administrator to register the client node, the Virtual I/O Server, with the Tivoli Storage Manager server.

## Results

After you are finished, you are ready to back up and restore the Virtual I/O Server using the Tivoli Storage Manager. For instructions, see the following procedures:

- “Backing up the Virtual I/O Server by using Tivoli Storage Manager” on page 189
- “Restoring the Virtual I/O Server by using Tivoli Storage Manager” on page 197

## Configuring the TotalStorage Productivity Center agents

You can configure and start the TotalStorage Productivity Center agents on the Virtual I/O Server.

### About this task

With Virtual I/O Server 1.5.2, you can configure the TotalStorage Productivity Center agents on the Virtual I/O Server. TotalStorage Productivity Center is an integrated, storage infrastructure management suite that is designed to help simplify and automate the management of storage devices, storage networks, and capacity utilization of file systems and databases. When you configure the TotalStorage Productivity Center agents on the Virtual I/O Server, you can use the TotalStorage Productivity Center user interface to collect and view information about the Virtual I/O Server.

**Note:** The TotalStorage Productivity Center agent Version 6.2.2.0, or later, is shipped on the Virtual I/O Expansion media. This version of the TotalStorage Productivity Center agent requires the GSKit8 libraries, which are also shipped on the Virtual I/O Expansion media.

Before you start, complete the following tasks:

1. Use the **ioslevel** command to verify that the Virtual I/O Server is at Version 1.5.2, or later.
2. Ensure that there are no other operations running on the Virtual I/O Server. Configuring the TotalStorage Productivity Center consumes all of the processing time.

3. In addition to the memory required by the Virtual I/O Server logical partition, ensure that you have allocated a minimum of 1 GB of memory to the Virtual I/O Server for the TotalStorage Productivity Center agents.

To configure and start the TotalStorage Productivity Center agents, complete the following steps:

## Procedure

1. List all of the available TotalStorage Productivity Center agents using the **lssvc** command. For example,

```
$lssvc
TPC
```

The TPC agent includes both the TPC\_data and TPC\_fabric agents. When you configure the TPC agent, you configure both the TPC\_data and TPC\_fabric agents.

2. List all of the attributes that are associated with the TotalStorage Productivity Center agent using the **lssvc** command. For example:

```
$lssvc TPC
A:
S:
devAuth:
caPass:
caPort:
amRegPort:
amPubPort:
dataPort:
devPort:
newCA:
oldCA:
daScan:
daScript:
daInstall:
faInstall:
U:
```

The A, S, devAuth, and caPass attributes are required. The remainder of the attributes are optional. For more information about the attributes, see "Configuration attributes for Tivoli agents and clients" on page 227.

3. Configure the TotalStorage Productivity Center agent with its associated attributes using the **cfgsvc** command:

```
cfgsvc TPC -attr S=tpc_server_hostname A=agent_manager_hostname devAuth=password_1 caPass=password_2
```

Where:

- *tpc\_server\_hostname* is the host name or IP address of the TotalStorage Productivity Center server that is associated with the TotalStorage Productivity Center agent.
  - *agent\_manager\_hostname* is the name or IP address of the Agent Manager.
  - *password\_1* is the password required to authenticate to the TotalStorage Productivity Center device server.
  - *password\_2* is the password required to authenticate to the common agent.
4. Select the language that you want to use during the installation and configuration.
  5. Accept the license agreement to install the agents according to the attributes specified in step 3.
  6. Start each TotalStorage Productivity Center agent using the **startsvc** command:
    - To start the TPC\_data agent, run the following command:  
startsvc TPC\_data
    - To start the TPC\_fabric agent, run the following command:  
startsvc TPC\_fabric



## Results

After you start the TotalStorage Productivity Center agents, you can perform the following tasks using the TotalStorage Productivity Center user interface:

1. Run a discovery job for the agents on the Virtual I/O Server.
2. Run probes, scans, and ping jobs to collect storage information about the Virtual I/O Server.
3. Generate reports using the Fabric Manager and the Data Manager to view the storage information gathered.
4. View the storage information gathered using the topology Viewer.

For more information, see the *TotalStorage Productivity Center support for agents on a Virtual I/O Server* PDF file. To view or download the PDF file, go to the TotalStorage Productivity Center v3.3.1.81 Interim Fix Web site.

## Configuring the Director agent

You can configure and start the Director agent on the Virtual I/O Server.

### Before you begin

Before you start, use the `ioslevel` command to verify that the Virtual I/O Server is at Version 2.1.0.1-FP-20.1, or later.

### About this task

With Virtual I/O Server 2.1.0.1-FP-20.1, you can configure the Director agent on the Virtual I/O Server. Using the Director agent, you can view and track hardware configuration details of the system and monitor performance and use of critical components, such as processors, disks, and memory.

To configure and start the Director agent, complete the following steps:

### Procedure

1. List the available Director using the `lssvc` command. For example,

```
$lssvc
DIRECTOR_agent
```

2. Configure the Director agent to be started per default:

```
cfgsvc DIRECTOR_agent -attr RESTART_ON_REBOOT=TRUE
```

`RESTART_ON_REBOOT` designates whether the Director agent restarts if the Virtual I/O Server is rebooted.

3. Start the Director agent using the `startsvc` command. To start the `DIRECTOR_agent` agent, run the following command:

```
startsvc DIRECTOR_agent
```

### Related concepts:

“Systems Director software” on page 51

Learn about integrating the Virtual I/O Server into your Systems Director environment.

“Tivoli software and the Virtual I/O Server” on page 49

Learn about integrating the Virtual I/O Server into your Tivoli environment for Tivoli Application Dependency Discovery Manager, Tivoli Monitoring, Tivoli Storage Manager, Tivoli Usage and Accounting Manager, Tivoli Identity Manager, and TotalStorage Productivity Center.

### Related information:

 [cfgsvc command](#)

## Configuring the Virtual I/O Server as an LDAP client

Virtual I/O Server Version 1.4 can be configured as an LDAP client and then you can manage Virtual I/O Server from an LDAP server.

### Before you begin

Before you start, gather the following information:

- The name of the Lightweight Directory Access Protocol (LDAP) server or servers to which you want the Virtual I/O Server to be an LDAP client.
- The administrator distinguish name (DN) and password for the LDAP server or servers to which you want the Virtual I/O Server to be an LDAP client.

### About this task

To configure the Virtual I/O Server as an LDAP client, complete the following steps:

#### Procedure

1. Change Virtual I/O Server users to LDAP users by running the following command:

```
chuser -ldap -attr Attributes=Value username
```

where *username* is the name of the user you want to change to an LDAP user.

2. Set up the LDAP client by running the following command:

```
mkldap -host ldapserv1 -bind cn=admin -passwd adminpwd
```

Where:

- *ldapserv1* is the LDAP server or list of LDAP servers to which you want the Virtual I/O Server to be an LDAP client
- *cn=admin* is the administrator DN of *ldapserv1*
- *adminpwd* is the password for *cn=admin*

Configuring the LDAP client automatically starts communication between the LDAP server and the LDAP client (the Virtual I/O Server). To stop communication, use the **stopnetsvc** command.

---

## Managing the Virtual I/O Server

You can manage virtual Small Computer Serial Interface (SCSI) and virtual Ethernet devices on the Virtual I/O Server, as well as back up, restore, update, and monitor the Virtual I/O Server.

## About this task

Most of the information in this topic is specific to management in an HMC environment. For information about management tasks in an Integrated Virtualization Manager environment, see Integrated Virtualization Manager.

## Managing storage

You can import and export volume groups and storage pools, map virtual disks to physical disks, increase virtual Small Computer Serial Interface (SCSI) device capacity, change the virtual SCSI queue depth, back up and restore files and file systems, and collect and view information using the TotalStorage Productivity Center.

### Importing and exporting volume groups and logical volume storage pools

You can use the **importvg** and **exportvg** commands to move a user-defined volume group from one system to another.

#### About this task

Consider the following when importing and exporting volume groups and logical volume storage pools:

- The import procedure introduces the volume group to its new system.
- You can use the **importvg** command to reintroduce a volume group or logical volume storage pool to the system that it had been previously associated with and had been exported from.
- The **importvg** command changes the name of an imported logical volume if a logical volume of that name already exists on the new system. If the **importvg** command must rename a logical volume, it prints an error message to standard error.
- The export procedure removes the definition of a volume group from a system.
- You can use the **importvg** and **exportvg** commands to add a physical volume that contains data to a volume group by putting the disk to be added in its own volume group.
- The rootvg volume group cannot be exported or imported.

#### Importing volume groups and logical volume storage pools:

You can use the **importvg** command to import a volume group or logical volume storage pool.

#### About this task

To import a volume group or logical volume storage pool, complete the following steps:

##### Procedure

1. Run the following command to import the volume group or logical volume storage pool:

```
importvg -vg volumeGroupName physicalVolumeName
```

Where:

- *volumeGroupName* is an optional parameter that specifies the name to use for the imported volume group.
  - *physicalVolumeName* is the name of a physical volume that belongs to the imported volume group.
2. If you know that the imported volume group or logical volume storage pool is not the parent of the virtual media repository or any file storage pools, then you are finished importing the volume group or logical volume storage pool and do not need to complete the remaining steps.
  3. If you know that imported volume group or logical volume storage pool is the parent of the virtual media repository or any file storage pools, or if you are unsure, then complete the following steps:

- a. Run the `mount all` command to mount any file systems contained in the imported volume group or logical volume storage pool. This command might return errors for file systems that are already mounted.
- b. If you are importing a volume group or logical volume storage to the same system from which you exported it, run the `cfgdev` to reconfigure any devices that were unconfigured when you exported the volume group or logical volume storage pool.

**What to do next**

To export a volume group or logical volume storage pool, see “Exporting volume groups and logical volume storage pools.”

**Exporting volume groups and logical volume storage pools:**

You can use the `exportvg` command to export a volume group or logical volume storage pool.

**Before you begin**

Before you start, complete the following tasks:

1. Determine whether the volume group or logical volume storage pool that you plan to export is a parent to the virtual media repository or to any file storage pools by completing the following steps:
  - a. Run the `lsrep` command to determine whether the volume group or logical volume storage pool that you plan to export is a parent of the virtual media repository. The Parent Pool field displays the parent volume group or logical volume pool of the virtual media repository.
  - b. Run the following command to determine whether a file storage pool is a child of the volume group or logical volume pool that you plan to export:

```
lssp -detail -sp FilePoolName
```

The results list the parent volume group or logical volume storage pool of the file storage pool.

2. If the volume group or logical volume storage pool that you plan to export is a parent of the virtual media repository or a file storage pool, then complete the following steps.

*Table 38. Prerequisites steps if the volume group or logical volume storage pool is a parent of the virtual media repository or a file storage pool*

| Parent of Virtual Media Repository                                                                                                                                                                                                                                                                                                                                                                                                                                                                                                                                                                                                                                                                                       | Parent of a file storage pool                                                                                                                                                                                                                                                                                                                                                                                                                                                                                                                                                                                                                                                                                                                                                                                                                                                                               |
|--------------------------------------------------------------------------------------------------------------------------------------------------------------------------------------------------------------------------------------------------------------------------------------------------------------------------------------------------------------------------------------------------------------------------------------------------------------------------------------------------------------------------------------------------------------------------------------------------------------------------------------------------------------------------------------------------------------------------|-------------------------------------------------------------------------------------------------------------------------------------------------------------------------------------------------------------------------------------------------------------------------------------------------------------------------------------------------------------------------------------------------------------------------------------------------------------------------------------------------------------------------------------------------------------------------------------------------------------------------------------------------------------------------------------------------------------------------------------------------------------------------------------------------------------------------------------------------------------------------------------------------------------|
| <ol style="list-style-type: none"> <li>1. Unload the backing device of each file-backed optical virtual target device (VTD) that has a media file loaded, by completing the following steps:               <ol style="list-style-type: none"> <li>a. Retrieve a list of the file-backed optical VTDs by running the following command:<br/><code>lsmmap -all -type file_opt</code></li> <li>b. For each device that shows a backing device, run the following command to unload the backing device:<br/><code>unloadopt -vtd VirtualTargetDevice</code></li> </ol> </li> <li>2. Unmount the Virtual Media Repository file system by running the following command:<br/><code>umount /var/vio/VMLibrary</code></li> </ol> | <ol style="list-style-type: none"> <li>1. Unconfigure the virtual target devices (VTDs) associated with the files contained in the file storage pools by completing the following steps:               <ol style="list-style-type: none"> <li>a. Retrieve a list of VTDs by running the following command:<br/><code>lssp -bd -sp FilePoolName</code><br/><br/>where <i>FilePoolName</i> is the name of a file storage pool that is a child of the volume group or logical volume storage pool that you plan to export.</li> <li>b. For each file that lists a VTD, run the following command:<br/><code>rmdev -dev VirtualTargetDevice -ucfg</code></li> </ol> </li> <li>2. Unmount the file storage pool by running the following command:<br/><code>umount /var/vio/storagepools/FilePoolName</code><br/><br/>where <i>FilePoolName</i> is the name of the file storage pool to be unmounted.</li> </ol> |

## About this task

To export the volume group or logical volume storage pool, run the following commands:

### Procedure

1. `deactivatevg VolumeGroupName`
2. `exportvg VolumeGroupName`

### What to do next

To import a volume group or logical volume storage pool, see “Importing volume groups and logical volume storage pools” on page 169.

## Mapping virtual disks to physical disks

Find instructions for mapping a virtual disk on a client logical partition to its physical disk on the Virtual I/O Server.

### About this task

This procedure shows how to map a virtual Small Computer Serial Interface (SCSI) disk on an AIX or Linux client logical partition to the physical device (disk or logical volume) on the Virtual I/O Server.

To map a virtual disk to a physical disk, you need the following information. This information is gathered during this procedure:

- Virtual device name
- Slot number of the virtual SCSI client adapter
- Logical unit number (LUN) of the virtual SCSI device
- Client logical partition ID

Follow these steps to map a virtual disk on an AIX or Linux client logical partition to its physical disk on the Virtual I/O Server:

### Procedure

1. Display virtual SCSI device information on the AIX or Linux client logical partition by typing the following command:

```
lscfg -l devicename
```

This command returns results similar to the following:

```
U9117.570.1012A9F-V3-C2-T1-L810000000000 Virtual SCSI Disk Drive
```

2. Record the slot number, which is located in the output, following the card location label *C*. This identifies the slot number of the virtual SCSI client adapter. In this example, the slot number is 2.
3. Record the LUN, which is located in the output, following the LUN label *L*. In this example, the LUN is 810000000000.
4. Record the logical partition ID of the AIX or Linux client logical partition:
  - a. Connect to the AIX or Linux client logical partition. For example, using Telnet.
  - b. On the AIX or Linux logical partition, run the `uname -L` command.

Your results should look similar to the following:

```
2 fumi02
```

The logical partition ID is the first number listed. In this example, the logical partition ID is 2. This number is used in the next step.

c. Type `exit`.

5. If you have multiple Virtual I/O Server logical partitions running on your system, determine which Virtual I/O Server logical partition is serving the virtual SCSI device. Use the slot number of the client adapter that is linked to a Virtual I/O Server, and a server adapter. Use the HMC command line to list information about virtual SCSI client adapters in the client logical partition.

Log in to the HMC, and from the HMC command line, type `lshwres`. Specify the managed console name for the `-m` parameter and the client logical partition ID for the `lpar_ids` parameter.

**Note:**

- The managed console name, which is used for the `-m` parameter, is determined by typing `lssyscfg -r sys -F name` from the HMC command line.
- Use the client logical partition ID recorded in Step 4 for the `-lpar_ids` parameter.

For example:

```
lshwres -r virtualio --rsubtype scsi -m fumi --filter lpar_ids=2
```

This example returns results similar to the following:

```
lpar_name=fumi02,lpar_id=2,slot_num=2,state=null,adapter_type=client,remote_lpar_id=1,remote_lpar_name=fumi01,remote_slot_num=2,is_required=1,backing_devices=none
```

Record the name of the Virtual I/O Server located in the `remote_lpar_name` field and slot number of the virtual SCSI server adapter, which is located in the `remote_lpar_id` field. In this example, the name of the Virtual I/O Server is `fumi01` and the slot number of the virtual SCSI server adapter is 2.

6. Log in to the Virtual I/O Server.
7. List virtual adapters and devices on the Virtual I/O Server by typing the following command:  

```
lsmap -all
```
8. Find the virtual SCSI server adapter (`vhostX`) that has a slot ID that matches the remote slot ID recorded in Step 5. On that adapter, run the following command:  

```
lsmap -vadapter devicename
```
9. From the list of devices, match the LUN recorded in step 3 on page 171 with LUNs listed. This is the physical device.

## Results

### Increasing virtual SCSI device capacity

As storage demands increase for virtual client logical partitions, you can add physical storage to increase the size of your virtual devices and allocate that storage to your virtual environment.

### About this task

You can increase the capacity of your virtual Small Computer Serial Interface (SCSI) devices by increasing the size of physical or logical volumes. With Virtual I/O Server Version 1.3 and later, you can do this without disrupting client operations. To increase the size of files and logical volumes based on storage pools, the Virtual I/O Server must be at Version 1.5 or later.

**Tip:** If you are using the HMC, Version 7 release 3.4.2 or later, you can use the HMC graphical interface to increase the capacity of a virtual SCSI device on a Virtual I/O Server.

To increase virtual SCSI device capacity, complete the following steps:

### Procedure

1. Increase the size of the physical volumes, logical volumes, or files:

- Physical volumes: Consult your storage documentation to determine whether your storage subsystem supports expanding the size of a logical unit number (LUN). For Virtual I/O Server Version 2.1.2.0, ensure that the Virtual I/O Server recognizes and adjusts to the new size by running the following command: `chvg -chksize vg1`, where *vg1* is the name of the expanding volume group.

The Virtual I/O Server examines all the disks in volume group *vg1* to determine whether they have grown in size. For those disks that have grown in size, the Virtual I/O Server attempts to add additional physical partitions to the physical volumes. If necessary, the Virtual I/O Server determines the correct 1016 multiplier and conversion to a big volume group.

- Logical volumes based on volume groups:
    - a. Run the **extendlv** command. For example: `extendlv lv3 100M`. This example increases logical volume *lv3* by 100 MB.
    - b. If there is no additional space in the logical volume, complete the following tasks:
      - 1) Increase the size of the volume group by completing one of the following steps:
        - Increase the size of the physical volumes. Consult your storage documentation for instructions.
        - Add physical volumes to a volume group by running the **extendvg** command. For example: `extendvg vg1 hdisk2`. This example adds physical volume *hdisk2* to volume group *vg1*.
      - 2) Allocate the increased volume to partitions by resizing logical volumes. Run the **extendlv** command to increase the size of a logical volume.
  - Logical volumes based on storage pools:
    - a. Run the **chbdsp** command. For example: `chbdsp -sp lvPool -bd lv3 -size 100M`. This example increases logical volume *lv3* by 100 MB.
    - b. If there is no additional space in the logical volume, complete the following tasks:
      - 1) Increase the size of the logical volume storage pool by completing one of the following steps:
        - Increase the size of the physical volumes. Consult your storage documentation for instructions.
        - Add physical volumes to the storage pool by running the **chsp** command. For example: `chsp -add -sp sp1 hdisk2`. This example adds physical volume *hdisk2* to storage pool *sp1*.
      - 2) Allocate the increased volume to partitions by resizing logical volumes. Run the **chbdsp** command to increase the size of a logical volume.
  - Files:
    - a. Run the **chbdsp** command. For example: `chbdsp -sp fbPool -bd fb3 -size 100M`. This example increases file *fb3* by 100 MB.
    - b. If there is no additional space in the file, increase the size of the file storage pool by running the **chsp** command. For example: `chsp -add -sp fbPool -size 100M`. This example increases file storage pool *fbPool* by 100MB.
    - c. If there is no additional space in the file storage pool, increase the size of the parent storage pool by completing one of the following tasks:
      - Increase the size of the physical volumes. Consult your storage documentation for instructions.
      - Add physical volumes to the parent storage pool by running the **chsp** command. For example: `chsp -add -sp sp1 hdisk2`. This example adds physical volume *hdisk2* to storage pool *sp1*.
      - Increase the size of the file storage pool by running the **chsp** command.
2. If you are running Virtual I/O Server versions prior to 1.3, then you need to either reconfigure the virtual device (using the **cfgdev** command) or restart the Virtual I/O Server.

3. If you are running Virtual I/O Server Version 1.3 or later, then restarting or reconfiguring a logical partition is not required to begin using the additional resources. If the physical storage resources have been set up and properly allocated to the system as a system resource, as soon as the Virtual I/O Server recognizes the changes in storage volume, the increased storage capacity is available to the client logical partitions.
4. On the client logical partition, ensure that the operating system recognizes and adjusts to the new size. For example, if AIX is the operating system on the client logical partition, run the following command:

```
chvg -g vg1
```

In this example, AIX examines all the disks in volume group *vg1* to see if they have grown in size. For the disks that have grown in size, AIX attempts to add additional physical partitions to physical volumes. If necessary, AIX will determine proper 1016 multiplier and conversion to the big volume group.

#### Related information:

 [chlv Command](#)

 [chvg Command](#)

 [Changing a storage pool for a VIOS logical partition using the HMC](#)

## Changing the virtual SCSI queue depth

Increasing the virtual Small Computer Serial Interface (SCSI) queue depth might provide performance improvements for some virtual configurations. Understand the factors involved in determining a change to the virtual SCSI queue depth value.

The virtual SCSI queue depth value determines how many requests the disk head driver will queue to the virtual SCSI client driver at any one time. For AIX client logical partitions, you can change this value from the default value of 3 to a value from 1 - 256 by using the **chdev** command. For Linux client logical partitions, you can change this value from the default value of 16 to a value from 1 - 256 by using the **echo** command.

Increasing this value might improve the throughput of the disk in specific configurations. However, several factors must be taken into consideration. These factors include the value of the queue-depth attribute for all of the physical storage devices on the Virtual I/O Server being used as a virtual target device by the disk instance on the client logical partition, and the maximum transfer size for the virtual SCSI client adapter instance that is the parent device for the disk instance.

For AIX and Linux client logical partitions, the maximum transfer size for virtual SCSI client adapters is set by the Virtual I/O Server, which determines the value based on the resources available on the server and the maximum transfer size set for the physical storage devices on that server. Other factors include the queue depth and maximum transfer size of other devices involved in mirrored-volume-group or Multipath I/O (MPIO) configurations. Increasing the queue depth for some devices might reduce the resources available for other devices on that same shared adapter and decrease the throughput for those devices.

To change the queue depth for an AIX client logical partition, on the client logical partition use the **chdev** command with the **queue\_depth=value** attribute as in the following example:

```
chdev -l hdiskN -a "queue_depth=value"
```

*hdiskN* represents the name of a physical volume and *value* is the value you assign between 1 and 256.

To change the queue depth for a client logical partition on the client logical partition, use the **echo** command as in the following example:

```
echo 16 > /sys/devices/vio/30000003/host0/target0:0:1/0:0:1:0/queue_depth
```



By default, the value of the **queue\_depth** attribute for a disk on the Linux operating system is 16.

To view the current setting for the **queue\_depth** value, from the client logical partition issue the following command:

```
lsattr -El hdiskN
```

## Backing up and restoring files and file systems

You can use the **backup** and **restore** commands to back up and restore individual files or entire file systems.

### About this task

Backing up and restoring files and files systems can be useful for tasks, such as saving a file-backed device.

The following commands are used to back up and restore files and files systems.

*Table 39. Backup and restore commands and their descriptions*

| Command        | Description                                                                                                                                                                                                                                                                                                                                                                                                                                                                                                                                                                                               |
|----------------|-----------------------------------------------------------------------------------------------------------------------------------------------------------------------------------------------------------------------------------------------------------------------------------------------------------------------------------------------------------------------------------------------------------------------------------------------------------------------------------------------------------------------------------------------------------------------------------------------------------|
| <b>backup</b>  | Backs up files and file systems to media, such as physical tape and disk. For example: <ul style="list-style-type: none"><li>• You can back up all the files and subdirectories in a directory using full path names or relative path names.</li><li>• You can back up the root file system.</li><li>• You can back up all the files in the root file system that have been modified since the last backup.</li><li>• You can back up virtual optical media files from the virtual media repository.</li></ul>                                                                                            |
| <b>restore</b> | Reads archives created by the <b>backup</b> command and extracts the files stored there. For example: <ul style="list-style-type: none"><li>• You can restore a specific file into the current directory.</li><li>• You can restore a specific file from tape into the virtual media repository.</li><li>• You can restore a specific directory and the contents of that directory from a file name archive or a file system archive.</li><li>• You can restore an entire file system.</li><li>• You can restore only the permissions or only the ACL attributes of the files from the archive.</li></ul> |

## Managing storage using the TotalStorage Productivity Center

You can use the TotalStorage Productivity Center collect and view information about the Virtual I/O Server.

### About this task

With Virtual I/O Server 1.5.2, you can install and configure the TotalStorage Productivity Center agents on the Virtual I/O Server. TotalStorage Productivity Center is an integrated, infrastructure management suite for storage that is designed to help simplify and automate the management of storage devices, storage networks, and capacity utilization of file systems and databases. When you install and configure the TotalStorage Productivity Center agents on the Virtual I/O Server, you can use the TotalStorage Productivity Center interface to collect and view information about the Virtual I/O Server. You can then perform the following tasks using the TotalStorage Productivity Center interface:

1. Run a discovery job for the agents on the Virtual I/O Server.
2. Run probes, run scans, and ping jobs to collect storage information about the Virtual I/O Server.
3. Generate reports using the Fabric Manager and the Data Manager to view the storage information gathered.

4. View the storage information gathered using the topology Viewer.

**Related tasks:**

“Configuring the TotalStorage Productivity Center agents” on page 165

You can configure and start the TotalStorage Productivity Center agents on the Virtual I/O Server.

## Managing networks

You can change the network configuration of the Virtual I/O Server logical partition, enable and disable GARP VLAN Registration Protocol (GVRP) on your Shared Ethernet Adapters, use Simple Network Management Protocol (SNMP) to manage systems and devices in complex networks, and upgrade to Internet Protocol Version 6 (IPv6).

### Changing the network configuration of the Virtual I/O Server logical partition

Follow these steps to change or remove the network settings on the Virtual I/O Server logical partition, such as the IP address, subnet mask, gateway, and nameserver address

#### About this task

In this scenario, the Virtual I/O Server logical partition already has its network configuration set. The current configuration will be removed, and the updated configuration will then be set. If you plan to undo your Internet Protocol Version 6 (IPv6) configuration, use the following process and commands to completely remove the TCP/IP interface and then configure a new TCP/IP interface for Internet Protocol Version 4 (IPv4).

#### Procedure

1. View the current network configuration using the **lstcpip** command.
2. Remove the current network configuration by running the **rmtcpip** command. You can remove all network settings or just the specific settings that need to be updated.
3. Configure the new network settings using the **mktcpip** command.

#### Example

The following example is for IPv4 where the Virtual I/O Server logical partition needs to have its domain name server (DNS) information updated from its current address to 9.41.88.180:

1. Run `lstcpip -namesrv` to view the current configuration. Ensure you want to update this configuration.
2. Run `rmtcpip -namesrv` to remove the current configuration.
3. Run `mktcpip -nsrvaddr 9.41.88.180` to update the nameserver address.

### Dynamically adding or removing VLANs on the Virtual I/O Server

With the Virtual I/O Server Version 2.2, or later, you can add, change, or remove the existing set of VLANs for a virtual Ethernet adapter that is assigned to an active partition on a POWER7 processor-based server by using the Hardware Management Console (HMC).

#### Before you begin

Before you perform this task, ensure that you meet the following requirements:

- The server must be a POWER7 processor-based server, or later.
- The server firmware level must be at least AH720\_064+ for high end servers, AM720\_064+ for midrange servers, and AL720\_064+ for low end servers.

**Note:** The AL720\_064+ server firmware level is only supported on POWER7 processor-based servers, or later.

- The Virtual I/O Server must be at Version 2.2, or later.

- The HMC must be at Version 7.7.2.0, with mandatory efex MH01235, or later.

## About this task

You can use the HMC graphical interface or the **chhwres** command from the HMC command-line interface to add, remove, or modify VLANs for a virtual Ethernet adapter that is assigned to an active partition. You can also edit the IEEE standard of the virtual Ethernet adapter dynamically. To specify additional VLANs, you must set the virtual Ethernet adapter to the IEEE 802.1Q standard.

To add, remove, or modify VLANs on the Virtual I/O Server, complete the following steps:

## Procedure

1. Run the **lssyscfg** command to verify if the managed system supports adding, removing, or modifying VLANs on the Virtual I/O Server. For example,

```
lssyscfg -r sys -m <managed system> -F capabilities
```

If the managed server supports adding, removing, or modifying VLANs, this command returns the `virtual_eth_dlpar_capable` value.

2. Use the **chhwres** command to add, remove, or modify additional VLANs to the virtual Ethernet adapter that is assigned to an active partition. You can also edit the IEEE standard of the virtual Ethernet adapter dynamically by using the **chhwres** command. For example,

In this example, the VLAN ID 5 is added to the existing VLAN IDs for the virtual Ethernet adapter, and the virtual Ethernet adapter is set to the IEEE 802.1Q standard.

```
chhwres -r virtualio --rsubtype eth -m <managed system> -o s {-p <partition name> |
--id <partition ID>} -s <virtual slot number> -a "addl_vlan_ids+=5,ieee_virtual_eth=1"
```

In this example, the VLAN ID 6 is removed from the existing VLAN IDs for the virtual Ethernet adapter.

```
chhwres -r virtualio --rsubtype eth -m <managed system> -o s {-p <partition name> |
--id <partition ID>} -s <virtual slot number> -a "addl_vlan_ids-=6"
```

In this example, the VLAN IDs 2, 3, and 5 are assigned to the virtual Ethernet adapter instead of the existing VLAN IDs.

```
chhwres -r virtualio --rsubtype eth -m <managed system> -o s {-p <partition name> |
--id <partition ID>} -s <virtual slot number> -a "addl_vlan_ids=2,3,5"
```

You can provide a comma-separated list of VLANs to the attributes, **addl\_vlan\_ids=**, **addl\_vlan\_ids+=**, and **addl\_vlan\_ids-=**.

## Enabling and disabling GVRP

You can enable and disable GARP VLAN Registration Protocol (GVRP) on your Shared Ethernet Adapters to control dynamic registration of VLANs over networks.

## Before you begin

With Virtual I/O Server Version 1.4, Shared Ethernet Adapters support GARP VLAN Registration Protocol (GVRP) which is based on GARP (Generic Attribute Registration Protocol). GVRP allows for the dynamic registration of VLANs over networks.

By default, GVRP is disabled on Shared Ethernet Adapters.

Before you start, create and configure the Shared Ethernet Adapter. For instructions, see “Creating a virtual Ethernet adapter by using HMC Version 7” on page 154.

## Procedure

To enable or disable GVRP, run the following command:

```
chdev -dev Name -attr gvrp=yes/no
```

Where:

- *Name* is the name of the Shared Ethernet Adapter.
- *yes/no* defines whether GVRP is enabled or disabled. Type *yes* to enable GVRP and type *no* to disable GVRP.

## Managing SNMP on the Virtual I/O Server

Find commands for enabling, disabling, and working with SNMP on the Virtual I/O Server.

### About this task

Simple Network Management Protocol (SNMP) is a set of protocols for monitoring systems and devices in complex networks. SNMP network management is based on the familiar client-server model that is widely used in Internet protocol (IP) network applications. Each managed host runs a process called an agent. The agent is a server process that maintains information about managed devices in the Management Information Base (MIB) database for the host. Hosts that are involved in network management decision-making can run a process called a manager. A manager is a client application that generates requests for MIB information and processes responses. In addition, a manager might send requests to agent servers to modify MIB information.

In general, network administrators use SNMP to more easily manage their networks for the following reasons:

- It hides the underlying system network
- The administrator can manage and monitor all network components from one console

SNMP is available on Virtual I/O Server Version 1.4 and later.

The following table lists the SNMP management tasks available on the Virtual I/O Server, as well as the commands you need to run to accomplish each task.

*Table 40. Tasks and associated commands for working with SNMP on the Virtual I/O Server*

| Task                                                                                                 | Command                  |
|------------------------------------------------------------------------------------------------------|--------------------------|
| Enable SNMP                                                                                          | <code>startnetsvc</code> |
| Select which SNMP agent you want to run                                                              | <code>snmpv3_ssw</code>  |
| Issue SNMP requests to agents                                                                        | <code>c1_snmp</code>     |
| Process SNMP responses returned by agents                                                            | <code>c1_snmp</code>     |
| Request MIB information managed by an SNMP agent                                                     | <code>snmp_info</code>   |
| Modify MIB information managed by an SNMP agent                                                      | <code>snmp_info</code>   |
| Generate a notification, or trap, that reports an event to the SNMP manager with a specified message | <code>snmp_trap</code>   |
| Disable SNMP                                                                                         | <code>stopnetsvc</code>  |

### Related information:

 Network Management

## Upgrading the Virtual I/O Server from IPv4 to IPv6

To take advantage of enhancements, such as expanded addressing and routing simplification, use the `mktcpip` command to upgrade the Virtual I/O Server from Internet Protocol Version 4 (IPv4) to Internet Protocol Version 6 (IPv6).

## About this task

IPv6 is the next generation of Internet protocol and is gradually replacing the current Internet standard, Internet Protocol Version 4 (IPv4). The key IPv6 enhancement is the expansion of the IP address space from 32 bits to 128 bits, providing virtually unlimited, unique IP addresses. IPv6 provides several advantages over IPv4 including expanded routing and addressing, routing simplification, header format simplification, improved traffic control, autoconfiguration, and security.

## Procedure

Run the following command to upgrade from the Virtual I/O Server from IPv4 to IPv6:

```
mktcpip -auto [-interface interface]
```

where *interface* specifies which interface you want to configure for IPv6.

This command automatically performs the following tasks:

- Configures all link-local addresses for IPv6 that are currently configured for IPv4.
- Turns on the specified interfaces daemon that support IPv6.
- Starts the `ndpd-host` daemon.
- Ensures that the IPv6 configuration remains intact after you reboot the Virtual I/O Server.

## What to do next

If you decide that you want to undo the IPv6 configuration, you must completely remove the TCP/IP interface and then configure a new TCP/IP interface for IPv4. For instructions, see “Changing the network configuration of the Virtual I/O Server logical partition” on page 176.

## Backing up the Virtual I/O Server

You can back up the Virtual I/O Server (VIOS) and user-defined virtual devices using the **backupios** command or the **viosbr** command. You can also use Tivoli Storage Manager to schedule backups and to store backups on another server.

## About this task

The VIOS contains the following types of information that you need to back up: the VIOS itself and user-defined virtual devices.

- The VIOS includes the base code, applied fix packs, custom device drivers to support disk subsystems, and some user-defined metadata. All this information is backed up when you use the **backupios** command.
- User-defined virtual devices include metadata, like virtual devices mappings, that define the relationship between the physical environment and the virtual environment. You can back up user-defined virtual devices in one of the following ways:
  - You can back up user-defined virtual devices by using the **viosbr** command. Use this option in situations where you plan to restore the configuration information to the same VIOS partition from which it was backed up.
  - You can back up user-defined virtual devices by saving the data to a location that is automatically backed up when you use the **backupios** command to back up the VIOS. Use this option in situations where you plan to restore the VIOS to a new or different system. (For example, in the event of a system failure or disaster.) Furthermore, in these situations, you must also back up the following components of your environment. Back up these components to fully recover your VIOS configuration:
    - External device configurations, such as storage area network (SAN) devices.

- Resources defined on the Hardware Management Console (HMC), such as processor and memory allocations. In other words, back up your HMC partition profile data for the VIOS and its client partitions.
- The operating systems and applications running in the client logical partitions.

You can back up and restore the VIOS as follows.

*Table 41. Backup and restoration methods for the VIOS*

| Backup method          | Media                   | Restoration method                                                                                              |
|------------------------|-------------------------|-----------------------------------------------------------------------------------------------------------------|
| To tape                | Tape                    | From tape                                                                                                       |
| To DVD                 | DVD-RAM                 | From DVD                                                                                                        |
| To remote file system  | nim_resources.tar image | From an HMC using the Network Installation Management (NIM) on Linux facility and the <b>installios</b> command |
| To remote file system  | mksysb image            | From an AIX 5L™ NIM server and a standard mksysb system installation                                            |
| Tivoli Storage Manager | mksysb image            | Tivoli Storage Manager                                                                                          |



**Note:** As an alternative to the HMC, you can use the Systems Director Management Console (SDMC) to back up the VIOS.

**Related tasks:**

“Restoring the Virtual I/O Server” on page 190

You can restore the Virtual I/O Server (VIOS) and user-defined virtual devices using the **installios** command, the **viosbr** command, or Tivoli Storage Manager.

**Related information:**

-  backupios command
-  viosbr command
-  Backing up the VIOS by using the SDMC

**Backing up the Virtual I/O Server to tape**

You can back up the Virtual I/O Server base code, applied fix packs, custom device drivers to support disk subsystems, and some user-defined metadata to tape.

**Before you begin**

If the system is managed by the Integrated Virtualization Manager, then you need to back up your partition profile data for the management partition and its clients before you back up the Virtual I/O Server. For instructions, see Backing up and restoring partition data. (Alternatively, you can use the **bkprofddata** command.)

**About this task**

To back up the Virtual I/O Server to tape, follow these steps:

**Procedure**

1. Assign a tape drive to the Virtual I/O Server.
2. Get the device name by typing the following command:  

```
lsdev -type tape
```

If the tape device is in the Defined state, type the following command, where *dev* is the name of your tape device:

```
cfgdev -dev dev
```

3. Type the following command, where *tape\_device* is the name of the tape device you want to back up to:

```
backupios -tape tape_device
```

This command creates a bootable tape that you can use to restore the Virtual I/O Server.

4. If you plan to restore the Virtual I/O Server to a different system from which it was backed up, you need to back up the user-defined virtual devices. For instructions, see “Backing up user-defined virtual devices by using the **backupios** command” on page 184.

#### Related information:

 [Backing up to tape on the SDMC](#)

## Backing up the Virtual I/O Server to one or more DVDs

You can back up the Virtual I/O Server base code, applied fix packs, custom device drivers to support disk subsystems, and some user-defined metadata to DVD.

### Before you begin

If the system is managed by the Integrated Virtualization Manager, then you need to back up your partition profile data for the management partition and its clients before you back up the Virtual I/O Server. For instructions, see [Backing up and restoring partition data](#). (Alternatively, you can use the **bkprofddata** command.)

### About this task

To back up the Virtual I/O Server to one or more DVDs, follow these steps. Only DVD-RAM media can be used to back up the Virtual I/O Server.

**Note:** Vendor disk drives might support burning to additional disk types, such as CD-RW and DVD-R. Refer to the documentation for your drive to determine which disk types are supported.

### Procedure

1. Assign an optical drive to the Virtual I/O Server logical partition.
2. Get the device name by typing the following command:

```
lsdev -type optical
```

If the device is in the Defined state, type:

```
cfgdev -dev dev
```

3. Run the **backupios** command with the **-cd** option. Specify the path to the device. For example:

```
backupios -cd /dev/cd0
```

**Note:** If the Virtual I/O Server does not fit on one DVD, then the **backupios** command provides instructions for disk replacement and removal until all the volumes have been created.

This command creates one or more bootable DVDs that you can use to restore the Virtual I/O Server.

4. If you plan to restore the Virtual I/O Server to a different system from which it was backed up, then you need to back up the user-defined virtual devices. For instructions, see “Backing up user-defined virtual devices by using the **backupios** command” on page 184.

## Related information:

 [Backing up to one or more DVDs on the SDMC](#)

## Backing up the Virtual I/O Server to a remote file system by creating a `nim_resources.tar` file

You can back up the Virtual I/O Server base code, applied fix packs, custom device drivers to support disk subsystems, and some user-defined metadata to a remote file system by creating a `nim_resources.tar` file.

### Before you begin

Backing up the Virtual I/O Server to a remote file system will create the `nim_resources.tar` image in the directory you specify. The `nim_resources.tar` file contains all the necessary resources to restore the Virtual I/O Server, including the `mksysb` image, the `bosinst.data` file, the network boot image, and Shared Product Object Tree (SPOT) resource.

The **backupios** command empties the `target_disks_stanza` section of `bosinst.data` and sets `RECOVER_DEVICES=Default`. This allows the `mksysb` file generated by the command to be cloned to another logical partition. If you plan to use the `nim_resources.tar` image to install to a specific disk, then you need to repopulate the `target_disk_stanza` section of `bosinst.data` and replace this file in the `nim_resources.tar` image. All other parts of the `nim_resources.tar` image must remain unchanged.

Before you start, complete the following tasks:

1. If the system is managed by the Integrated Virtualization Manager, then you need to back up your partition profile data for the management partition and its clients before you back up the Virtual I/O Server. For instructions, see [Backing up and restoring partition data](#). (Alternatively, you can use the **bkprofddata** command.)
2. Ensure that the remote file system is available and mounted.
3. Ensure that the Virtual I/O Server has root write access to the server on which the backup will be created.

### About this task

To back up the Virtual I/O Server to a remote file system, follow these steps:

#### Procedure

1. Create a mount directory where the backup image, `nim_resources.tar`, will be written. For example, to create the directory `/home/backup`, type:  

```
mkdir /home/backup
```
2. Mount an exported directory on the mount directory. For example:  

```
mount server1:/export/ios_backup /home/backup
```
3. Run the **backupios** command with the **-file** option. Specify the path to the mounted directory. For example:  

```
backupios -file /home/backup
```

This command creates a `nim_resources.tar` file that you can use to restore the Virtual I/O Server from the HMC.

4. If you plan to restore the Virtual I/O Server to a different system from which it was backed up, then you need to back up the user-defined virtual devices. For instructions, see [“Backing up user-defined virtual devices by using the \*\*backupios\*\* command”](#) on page 184.



## Related information:

 [Backing up to a remote file system by using the SDMC](#)

## Backing up the Virtual I/O Server to a remote file system by creating a mksysb image

You can back up the Virtual I/O Server base code, applied fix packs, custom device drivers to support disk subsystems, and some user-defined metadata to a remote file system by creating a mksysb file.

### Before you begin

Backing up the Virtual I/O Server to a remote file system will create the mksysb image in the directory you specify. The mksysb image is an installable image of the root volume group in a file.

Before you start, complete the following tasks:

1. If the system is managed by the Integrated Virtualization Manager, then you need to back up your partition profile data for the management partition and its clients before you back up the Virtual I/O Server. For instructions, see [Backing up and restoring partition data](#). (Alternatively, you can use the **bkprofddata** command.)
2. If you plan to restore the Virtual I/O Server from a Network Installation Management (NIM) server, verify that the NIM server is at the latest release of AIX.
3. Ensure that the remote file system is available and mounted.
4. Ensure that the Virtual I/O Server has root write access to the server on which the backup will be created.

### About this task

To back up the Virtual I/O Server to a remote file system, follow these steps:

#### Procedure

1. Create a mount directory where the backup image, mksysb image, will be written. For example, to create the directory `/home/backup`, type:

```
mkdir /home/backup
```

2. Mount an exported directory on the mount directory. For example:

```
mount server1:/export/ios_backup /home/backup
```

where *server1* is the NIM server from which you plan to restore the Virtual I/O Server.

3. Run the **backupios** command with the **-file** option. Specify the path to the mounted directory. For example:

```
backupios -file /home/backup/filename.mksysb -mksysb
```

where *filename* is the name of mksysb image that this command creates in the specified directory. You can use the mksysb image to restore the Virtual I/O Server from a NIM server.

4. If you plan to restore the Virtual I/O Server to a different system from which it was backed up, then you need to back up the user-defined virtual devices. For instructions, see “Backing up user-defined virtual devices by using the **backupios** command” on page 184.

## Related information:

 [Backing up to a remote file system by creating a mksysb image on the SDMC](#)

## Backing up user-defined virtual devices

You can back up user-defined virtual devices by saving the data to a location that is automatically backed up when you use the **backupios** command to back up the Virtual I/O Server (VIOS). Alternatively, you can back up user-defined virtual devices by using the **viosbr** command.

## About this task

User-defined virtual devices include metadata, such as virtual device mappings, that define the relationship between the physical environment and the virtual environment. You can back up user-defined virtual devices in one of the following ways:

- You can back up user-defined virtual devices by saving the data to a location that is automatically backed up when you use the **backupios** command to back up the VIOS. Use this option in situations where you plan to restore the VIOS to a new or different system. (For example, in the event of a system failure or disaster.)
- You can back up user-defined virtual devices by using the **viosbr** command. Use this option in situations where you plan to restore the configuration information to the same VIOS partition from which it was backed up.

### Related tasks:

“Restoring user-defined virtual devices” on page 195

You can restore user-defined virtual devices on the Virtual I/O Server (VIOS) by restoring volume groups and manually re-creating virtual device mappings. Alternatively, you can restore user-defined virtual devices by using the **viosbr** command.

### Related information:

 [Backing up user-defined virtual devices on the SDMC](#)

### Backing up user-defined virtual devices by using the **backupios** command:

In addition to backing up the Virtual I/O Server (VIOS), you must back up user-defined virtual devices (such as virtual device mappings) in case you have a system failure or disaster. In this situation, back up user-defined virtual devices by saving the data to a location that is automatically backed up when you use the **backupios** command to back up the VIOS.

### Before you begin

User-defined virtual devices include metadata, such as virtual device mappings, that define the relationship between the physical environment and the virtual environment. In situations where you plan to restore the VIOS to a new or different system, you need to back up both the VIOS and user-defined virtual devices. (For example, in the event of a system failure or disaster.)

Before you start, complete the following tasks:

1. Back up the VIOS to tape, DVD, or a remote file system. For instructions, see one of the following procedures:
  - “Backing up the Virtual I/O Server to tape” on page 180
  - “Backing up the Virtual I/O Server to one or more DVDs” on page 181
  - “Backing up the Virtual I/O Server to a remote file system by creating a `nim_resources.tar` file” on page 182
  - “Backing up the Virtual I/O Server to a remote file system by creating a `mksysb` image” on page 183
2. Decide whether you want to create a script of the following procedure. Scripting these commands makes it easy to schedule automated backups of the information.

### About this task

To back up user-defined virtual devices, complete the following steps:

## Procedure

1. List volume groups (and storage pools) to determine what user-defined disk structures you want to back up by running the following command:

```
lsvg
```

2. Activate each volume group (and storage pool) that you want to back up by running the following command for each volume group:

```
activatevg volume_group
```

where *volume\_group* is the name of the volume group (or storage pool) that you want to activate.

3. Back up each volume group (and storage pool) by running the following command for each volume group:

```
savevgstruct volume_group
```

where *volume\_group* is the name of the volume group (or storage pool) that you want to back up. This command writes a backup of the structure of a volume group (and therefore a storage pool) to the **/home/ios/vgbackups** directory.

4. Save the information about network settings, adapters, users, and security settings to the **/home/padmin** directory by running each command with the **tee** command as follows:

```
command | tee /home/padmin/filename
```

Where:

- *command* is the command that produces the information you want to save.
- *filename* is the name of the file to which you want to save the information.

Table 42. Commands that provide the information to save

| Command                                                                                                                                                                                                                  | Information provided                                                                                                                 |
|--------------------------------------------------------------------------------------------------------------------------------------------------------------------------------------------------------------------------|--------------------------------------------------------------------------------------------------------------------------------------|
| <code>cfgnamesrv -ls</code>                                                                                                                                                                                              | Shows all system configuration database entries related to domain name server information used by local resolver routines.           |
| <code>entstat -all devicename</code><br><i>devicename</i> is the name of a device whose attributes or statistics you want to save. Run this command for each device whose attributes or statistics you want to save.     | Shows Ethernet driver and device statistics for the device specified.                                                                |
| <code>hostmap -ls</code>                                                                                                                                                                                                 | Shows all entries in the system configuration database.                                                                              |
| <code>ioslevel</code>                                                                                                                                                                                                    | Shows the current maintenance level of the Virtual I/O Server.                                                                       |
| <code>lsdev -dev devicename -attr</code><br><i>devicename</i> is the name of a device whose attributes or statistics you want to save. Run this command for each device whose attributes or statistics you want to save. | Shows the attributes of the device specified.                                                                                        |
| <code>lsdev -type adapter</code>                                                                                                                                                                                         | Shows information about physical and logical adapters.                                                                               |
| <code>lsuser</code>                                                                                                                                                                                                      | Shows a list of all attributes of all the system users.                                                                              |
| <code>netstat -routinfo</code>                                                                                                                                                                                           | Shows the routing tables, including the user-configured and current costs of each route.                                             |
| <code>netstat -state</code>                                                                                                                                                                                              | Shows the state of all configured interfaces.                                                                                        |
| <code>optimizenet -list</code>                                                                                                                                                                                           | Shows characteristics of all network tuning parameters, including the current and reboot value, range, unit, type, and dependencies. |
| <code>viosecure -firewall view</code>                                                                                                                                                                                    | Shows a list of allowed ports.                                                                                                       |

Table 42. Commands that provide the information to save (continued)

| Command                              | Information provided                                           |
|--------------------------------------|----------------------------------------------------------------|
| <code>viosecure -view -nonint</code> | Shows all the security level settings for noninteractive mode. |

#### Related tasks:

“Scheduling backups of the Virtual I/O Server and user-defined virtual devices by creating a script and **crontab** file entry” on page 187

You can schedule regular backups of the Virtual I/O Server (VIOS) and user-defined virtual devices to ensure that your backup copy accurately reflects the current configuration.

“Backing up user-defined virtual devices by using the **viosbr** command”

You can back up user-defined virtual devices by using the **viosbr** command. Use the **viosbr** command when you plan to restore the information to the same Virtual I/O Server (VIOS) logical partition from which it was backed up.

#### Related information:

 Backing up user-defined virtual devices by using the **backupios** command

#### Backing up user-defined virtual devices by using the **viosbr** command:

You can back up user-defined virtual devices by using the **viosbr** command. Use the **viosbr** command when you plan to restore the information to the same Virtual I/O Server (VIOS) logical partition from which it was backed up.

#### Before you begin

You can use the **viosbr** command to back up all the relevant data to recover a VIOS after an installation. The **viosbr** command backs up all the device properties and the virtual devices configuration on the VIOS. You can include information about some or all of the following devices in the backup:

- Logical devices, such as storage pools, clusters, file-backed storage pools, the virtual media repository, and paging space devices.
- Virtual devices, such as Etherchannel, Shared Ethernet Adapter, virtual server adapters, and virtual-server Fibre Channel adapters.
- Device attributes for devices like disks, optical devices, tape devices, fscsi controllers, Ethernet adapters, Ethernet interfaces, and logical Host Ethernet Adapters.

Before you start, run the **ioslevel** command to verify that the VIOS is at Version 2.1.2.0, or later.

#### About this task

#### Procedure

To back up all the device attributes and logical and virtual device mappings on the VIOS, run the following command:

```
viosbr -backup -file /tmp/myserverbackup
```

where `/tmp/myserverbackup` is the file to which you want to back up the configuration information.

### Related tasks:

“Restoring user-defined virtual devices by using the **viosbr** command” on page 196

You can restore user-defined virtual devices by using the **viosbr** command. Use the **viosbr** command when you plan to restore the information to the same Virtual I/O Server (VIOS) logical partition from which it was backed up.

“Scheduling backups of user-defined virtual devices by using the **viosbr** command” on page 188

You can schedule regular backups of the user-defined virtual devices on the Virtual I/O Server (VIOS) logical partition. Scheduling regular backups ensures that your backup copy accurately reflects the current configuration.

“Backing up user-defined virtual devices by using the **backupios** command” on page 184

In addition to backing up the Virtual I/O Server (VIOS), you must back up user-defined virtual devices (such as virtual device mappings) in case you have a system failure or disaster. In this situation, back up user-defined virtual devices by saving the data to a location that is automatically backed up when you use the **backupios** command to back up the VIOS.

### Related information:

 [ioslevel command](#)

 [viosbr command](#)

 [Backing up user-defined virtual devices by using the viosbr command](#)

## Scheduling backups of the Virtual I/O Server and user-defined virtual devices

You can schedule regular backups of the Virtual I/O Server (VIOS) and user-defined virtual devices to ensure that your backup copy accurately reflects the current configuration.

### About this task

To ensure that your backup of the VIOS accurately reflects your current running VIOS, back up the VIOS and the user-defined virtual devices each time that the configuration changes. For example:

- Changing the VIOS, like installing a fix pack.
- Adding, deleting, or changing the external device configuration, like changing the SAN configuration.
- Adding, deleting, or changing resource allocations and assignments for the VIOS, like memory, processors, or virtual and physical devices.
- Adding, deleting, or changing user-defined virtual device configurations, like virtual device mappings.

You can schedule backups in one of the following ways:

- You can schedule backups of the VIOS and user-defined virtual devices by creating a script that includes the **backupios** command. Then, create a crontab file entry that runs the script on a regular interval. Use this option in situations where you plan to restore the VIOS to a new or different system. (For example, use this option in the event of a system failure or disaster.)
- You can schedule backups of the configuration information for the user-defined virtual devices by using the **viosbr** command. Use this option in situations where you plan to restore the configuration information to the same VIOS partition from which it was backed up.

### Related information:

 [Scheduling backups on the SDMC](#)

## Scheduling backups of the Virtual I/O Server and user-defined virtual devices by creating a script and crontab file entry:

You can schedule regular backups of the Virtual I/O Server (VIOS) and user-defined virtual devices to ensure that your backup copy accurately reflects the current configuration.

## About this task

To ensure that your backup of the VIOS accurately reflects your current running VIOS, back up the VIOS each time that its configuration changes. For example:

- Changing the VIOS, like installing a fix pack.
- Adding, deleting, or changing the external device configuration, like changing the SAN configuration.
- Adding, deleting, or changing resource allocations and assignments for the VIOS, like memory, processors, or virtual and physical devices.
- Adding, deleting, or changing user-defined virtual device configurations, like virtual device mappings.

Before you start, ensure that you are logged in to the VIOS as the prime administrator (`padmin`).

To back up the VIOS and user-defined virtual devices, complete the following tasks:

### Procedure

1. Create a script for backing up the VIOS, and save it in a directory that is accessible to the **padmin** user ID. For example, create a script called *backup* and save it in the `/home/padmin` directory. Ensure that your script includes the following information:
  - The **backupios** command for backing up the VIOS.
  - Commands for saving information about user-defined virtual devices.
  - Commands to save the virtual devices information to a location that is automatically backed up when you use the **backupios** command to back up the VIOS.
2. Create a **crontab** file entry that runs the *backup* script on a regular interval. For example, to run *backup* every Saturday at 2:00 a.m., type the following commands:
  - a. `crontab -e`
  - b. `0 2 * * 6 /home/padmin/backup`

When you complete the task, remember to save and exit.

### Related information:

 [backupios command](#)

 [crontab command](#)

 [Scheduling backups by creating a script and crontab file entry](#)

### Scheduling backups of user-defined virtual devices by using the **viosbr** command:

You can schedule regular backups of the user-defined virtual devices on the Virtual I/O Server (VIOS) logical partition. Scheduling regular backups ensures that your backup copy accurately reflects the current configuration.

## About this task

To ensure that your backup of the user-defined virtual devices accurately reflects your currently running VIOS, back up the configuration information of the user-defined virtual devices each time that the configuration changes.

Before you start, run the **ioslevel** command to verify that the VIOS is at Version 2.1.2.0, or later.

### Procedure

To back up the configuration information of the user-defined virtual devices, run the **viosbr** command as follows:

```
viosbr -backup -file /tmp/myserverbackup -frequency how_often
```

where:

- */tmp/myserverbackup* is the file to which you want to back up the configuration information.
- *how\_often* is the frequency with which you want to back up the configuration information. You can specify one of the following values:
  - *daily*: Daily backups occur every day at 00:00.
  - *weekly*: Weekly backups occur every Sunday at 00:00.
  - *monthly*: Monthly backups occur on the first day of every month at 00:01.

#### Related tasks:

“Backing up user-defined virtual devices by using the **viosbr** command” on page 186

You can back up user-defined virtual devices by using the **viosbr** command. Use the **viosbr** command when you plan to restore the information to the same Virtual I/O Server (VIOS) logical partition from which it was backed up.

#### Related information:

 [ioslevel command](#)

 [viosbr command](#)

 [Scheduling backups of user-defined virtual devices by using the viosbr command](#)

## Backing up the Virtual I/O Server by using Tivoli Storage Manager

You can use the Tivoli Storage Manager to automatically back up the Virtual I/O Server on regular intervals, or you can perform incremental backups.

#### Related information:

 [Backing up using Tivoli Storage Manager](#)

### Backing up the Virtual I/O Server by using Tivoli Storage Manager automated backup:

You can automate backups of the Virtual I/O Server using the **crontab** command and the Tivoli Storage Manager scheduler.

#### About this task

Before you start, complete the following tasks:

- Ensure that you configured the Tivoli Storage Manager client on the Virtual I/O Server. For instructions, see “Configuring the Tivoli Storage Manager client” on page 164.
- Ensure that you are logged into the Virtual I/O Server as the prime administrator (padmin).

To automate backups of the Virtual I/O Server, complete the following steps:

#### Procedure

1. Write a script that creates a mksysb image of the Virtual I/O Server and save it in a directory that is accessible to the **padmin** user ID. For example, create a script called *backup* and save it in the */home/padmin* directory. If you plan to restore the Virtual I/O Server to a different system from which it was backed up, then ensure that your script includes commands for saving information about user-defined virtual devices. For more information, see the following tasks:
  - For instructions about how to create a mksysb image, see “Backing up the Virtual I/O Server to a remote file system by creating a mksysb image” on page 183.
  - For instructions about how to save user-defined virtual devices, see “Backing up user-defined virtual devices by using the **backupios** command” on page 184.
2. Create a **crontab** file entry that runs the *backup* script on a regular interval. For example, to create a mksysb image every Saturday at 2:00 a.m., type the following commands:
  - a. `crontab -e`

b. `0 2 0 0 6 /home/padmin/backup`

When you are finished, remember to save and exit.

3. Work with the Tivoli Storage Manager administrator to associate the Tivoli Storage Manager client node with one or more schedules that are part of the policy domain. This task is not performed on the Tivoli Storage Manager client on the Virtual I/O Server. This task is performed by the Tivoli Storage Manager administrator on the Tivoli Storage Manager server.
4. Start the client scheduler and connect to the server schedule using the **dsmc** command as follows:  
`dsmc -schedule`
5. If you want the client scheduler to restart when the Virtual I/O Server restarts, then add the following entry to the `/etc/inittab` file:  
`itsm::once:/usr/bin/dsmc sched > /dev/null 2>&1 # TSM scheduler`

#### Related information:

 Automated backup on the SDMC

### Backing up the Virtual I/O Server by using Tivoli Storage Manager incremental backup:

You can back up the Virtual I/O Server at any time by performing an incremental backup with the Tivoli Storage Manager.

#### About this task

Perform incremental backups in situations where the automated backup does not suit your needs. For example, before you upgrade the Virtual I/O Server, perform an incremental backup to ensure that you have a backup of the current configuration. Then, after you upgrade the Virtual I/O Server, perform another incremental backup to ensure that you have a backup of the upgraded configuration.

Before you start, complete the following tasks:

- Ensure that you configured the Tivoli Storage Manager client on the Virtual I/O Server. For instructions, see “Configuring the Tivoli Storage Manager client” on page 164.
- Ensure that you have a `mksysb` image of the Virtual I/O Server. If you plan to restore the Virtual I/O Server to a different system from which it was backed up, then ensure that the `mksysb` includes information about user-defined virtual devices. For more information, see the following tasks:
  - For instructions about how to create a `mksysb` image, see “Backing up the Virtual I/O Server to a remote file system by creating a `mksysb` image” on page 183.
  - For instructions about how to save user-defined virtual devices, see “Backing up user-defined virtual devices by using the **backupios** command” on page 184.

#### Procedure

To perform an incremental backup of the of the Virtual I/O Server, run the **dsmc** command. For example,  
`dsmc -incremental sourcefilespec`

Where `sourcefilespec` is the directory path to where the `mksysb` file is located. For example, `/home/padmin/mksysb_image`.

#### Related information:

 Incremental backup on the SDMC

### Restoring the Virtual I/O Server

You can restore the Virtual I/O Server (VIOS) and user-defined virtual devices using the **installios** command, the **viosbr** command, or Tivoli Storage Manager.



## About this task

The VIOS contains the following types of information that you need to restore: the VIOS itself and user-defined virtual devices.

- The VIOS includes the base code, applied fix packs, custom device drivers to support disk subsystems, and some user-defined metadata. All this information is restored when you use the **installios** command.
- User-defined virtual devices include metadata, such as virtual devices mappings, that define the relationship between the physical environment and the virtual environment. You can restore user-defined virtual devices in one of the following ways:
  - You can restore user-defined virtual devices by using the **viosbr** command. Use this option in situations where you plan to restore the configuration information to the same VIOS partition from which it was backed up.
  - You can restore user-defined virtual devices by restoring the volume groups and manually recreating virtual device mappings. Use this option in situations where you plan to restore the VIOS to a new or different system. (For example, in the event of a system failure or disaster.) Furthermore, in these situations, you also need to restore the following components of your environment. Back up these components to fully recover your VIOS configuration:
    - External device configurations, such as storage area network (SAN) devices.
    - Resources defined on the Hardware Management Console (HMC), such as processor and memory allocations. In other words, restore your HMC partition profile data for the VIOS and its client partitions.
    - The operating systems and applications running in the client logical partitions.

**Note:** To perform Live Partition Mobility after you restore the VIOS, ensure that you restart the HMC.

You can back up and restore the VIOS as follows.

*Table 43. Backup and restoration methods for the VIOS*

| Backup method          | Media                   | Restoration method                                                                                              |
|------------------------|-------------------------|-----------------------------------------------------------------------------------------------------------------|
| To tape                | Tape                    | From tape                                                                                                       |
| To DVD                 | DVD-RAM                 | From DVD                                                                                                        |
| To remote file system  | nim_resources.tar image | From an HMC using the Network Installation Management (NIM) on Linux facility and the <b>installios</b> command |
| To remote file system  | mksysb image            | From an AIX 5L NIM server and a standard mksysb system installation                                             |
| Tivoli Storage Manager | mksysb image            | Tivoli Storage Manager                                                                                          |

## What to do next

**Note:** As an alternative to the HMC, you can use the Systems Director Management Console (SDMC) to restore the Virtual I/O Server (VIOS).

### Related tasks:

“Backing up the Virtual I/O Server” on page 179

You can back up the Virtual I/O Server (VIOS) and user-defined virtual devices using the **backupios** command or the **viosbr** command. You can also use Tivoli Storage Manager to schedule backups and to store backups on another server.

### Related information:

 [installios command](#)

 [viosbr command](#)

 [Restoring the VIOS by using the SDMC](#)

## Restoring the Virtual I/O Server from tape

You can restore the Virtual I/O Server base code, applied fix packs, custom device drivers to support disk subsystems, and some user-defined metadata from tape.

### Before you begin

If the system is managed by the Integrated Virtualization Manager, then you need to restore your partition profile data for the management partition and its clients before you restore the Virtual I/O Server. For instructions, see Backing up and restoring partition data. (Alternatively, you can use the **rstprofdata** command.)

### About this task

To restore the Virtual I/O Server from tape, follow these steps:

### Procedure

1. Specify the Virtual I/O Server logical partition to boot from the tape by using the **bootlist** command. Alternatively, you can alter the bootlist in the System Management Services (SMS).
2. Insert the tape into the tape drive.
3. From the SMS menu, select to install from the tape drive.
4. Follow the installation steps according to the system prompts.
5. If you restored the Virtual I/O Server to a different system from which it was backed up, then you need to restore the user-defined virtual devices. For instructions, see “Restoring user-defined virtual devices manually” on page 195.

### Related information:

 [Restoring from tape on the SDMC](#)

## Restoring the Virtual I/O Server from one or more DVDs

You can restore the Virtual I/O Server base code, applied fix packs, custom device drivers to support disk subsystems, and some user-defined metadata from one or more DVDs.

### Before you begin

If the system is managed by the Integrated Virtualization Manager, then you need to restore your partition profile data for the management partition and its clients before you restore the Virtual I/O Server. For instructions, see Backing up and restoring partition data. (Alternatively, you can use the **rstprofdata** command.)

### About this task

To restore the Virtual I/O Server from a one or more DVDs, follow these steps:

## Procedure

1. Specify the Virtual I/O Server partition to boot from the DVD by using the **bootlist** command. Alternatively, you can alter the bootlist in the System Management Services (SMS).
2. Insert the DVD into the optical drive.
3. From the SMS menu, select to install from the optical drive.
4. Follow the installation steps according to the system prompts.
5. If you restored the Virtual I/O Server to a different system from which it was backed up, then you need to restore the user-defined virtual devices. For instructions, see “Restoring user-defined virtual devices manually” on page 195.

### Related information:

 Restoring from one or more DVDs on the SDMC

## Restoring the Virtual I/O Server from the HMC by using a `nim_resources.tar` file

You can restore the Virtual I/O Server (VIOS) base code, applied fix packs, custom device drivers to support disk subsystems, and some user-defined metadata from a `nim_resources.tar` image stored in a remote file system.

### Before you begin

If the system is managed by the Integrated Virtualization Manager, then you need to restore your partition profile data for the management partition and its clients before you restore the Virtual I/O Server. For instructions, see Backing up and restoring partition data. (Alternatively, you can use the **rstprofdata** command.)

### About this task

To restore the Virtual I/O Server from a `nim_resources.tar` image in a file system, complete the following steps:

## Procedure

1. Run the **installios** command from the HMC command line. This restores a backup image, `nim_resources.tar`, that was created using the **backupios** command.
2. Follow the installation procedures according to the system prompts. The source of the installation images is the exported directory from the backup procedure. For example, `server1:/export/ios_backup`.
3. When the restoration is finished, open a virtual terminal connection (for example, using telnet) to the Virtual I/O Server that you restored. Some additional user input might be required.
4. If you restored the Virtual I/O Server to a different system from which it was backed up, you must restore the user-defined virtual devices. For instructions, see “Restoring user-defined virtual devices manually” on page 195.

### What to do next

**Note:** As an alternative to the HMC, you can use the Systems Director Management Console (SDMC) to restore the VIOS base code, applied fix packs, custom device drivers to support disk subsystems, and some user-defined metadata from a `nim_resources.tar` image stored in a remote file system.

### Related information:

 Restoring from the SDMC using a `nim_resources.tar` file

## Restoring the Virtual I/O Server from a NIM server by using a `mksysb` file

You can restore the Virtual I/O Server base code, applied fix packs, custom device drivers to support disk subsystems, and some user-defined metadata from a `mksysb` image stored in a remote file system.

## Before you begin

Before you start, complete the following tasks:

- Ensure that the server to which you plan to restore the Virtual I/O Server is defined as a Network Installation Management (NIM) resource.
- Ensure that the `mksysb` file (that contains the backup of the Virtual I/O Server) is on the NIM server.
- If the system is managed by the Integrated Virtualization Manager, then you need to restore your partition profile data for the management partition and its clients before you restore the Virtual I/O Server. For instructions, see [Backing up and restoring partition data](#). (Alternatively, you can use the `rstprofdata` command.)

## About this task

To restore the Virtual I/O Server from a `mksysb` image in a file system, complete the following tasks:

### Procedure

1. Define the `mksysb` file as a NIM resource, specifically, a NIM object, by running the `nim` command. To view a detailed description of the `nim` command, see [nim Command](#). For example:

```
nim -o define -t mksysb -a server=servername -alocation=/export/ios_backup/
filename.mksysb objectname
```

Where:

- `servername` is the name of the server that holds the NIM resource.
- `filename` is the name of the `mksysb` file.
- `objectname` is the name by which NIM registers and recognizes the `mksysb` file.

2. Define a Shared Product Object Tree (SPOT) resource for the `mksysb` file by running the `nim` command. For example:

```
nim -o define -t spot -a server=servername -a location=/export/ios_backup/
SPOT -a source=objectname SPOTname
```

Where:

- `servername` is the name of the server that holds the NIM resource.
- `objectname` is the name by which NIM registers and recognizes the `mksysb` file.
- `SPOTname` is the NIM object name for the `mksysb` image that was created in the previous step.

3. Install the Virtual I/O Server from the `mksysb` file using the `smit` command. For example:

```
smit nim_bosinst
```





Ensure the following entry fields contain the following specifications.

Table 44. Specifications for the SMIT command

| Field                            | Specification                       |
|----------------------------------|-------------------------------------|
| Installation TYPE                | <code>mksysb</code>                 |
| SPOT                             | <code>SPOTname</code> from step 3   |
| MKSYSB                           | <code>objectname</code> from step 2 |
| Remain NIM client after install? | <code>no</code>                     |

4. Start the Virtual I/O Server logical partition. For instructions, see step 3, [Boot the Virtual I/O Server, or Installing the Virtual I/O Server using NIM](#).
5. If you restored the Virtual I/O Server to a different system from which it was backed up, you must restore the user-defined virtual devices. For instructions, see [“Restoring user-defined virtual devices manually”](#) on page 195.

### Related information:

-  Using the NIM define operation
-  Defining a SPOT resource
-  Installing a client using NIM
-  Restoring from a NIM server using a mkysyb file on the SDMC

## Restoring user-defined virtual devices

You can restore user-defined virtual devices on the Virtual I/O Server (VIOS) by restoring volume groups and manually re-creating virtual device mappings. Alternatively, you can restore user-defined virtual devices by using the **viosbr** command.

### About this task

User-defined virtual devices include metadata, such as virtual device mappings, that define the relationship between the physical environment and the virtual environment. You can restore user-defined virtual devices in one of the following ways:

- You can restore user-defined virtual devices by restoring volume groups and manually re-creating virtual device mappings. Use this option in situations where you plan to restore the VIOS to a new or different system. (For example, use this option in the event of a system failure or disaster.)
- You can restore user-defined virtual devices by using the **viosbr** command. Use this option in situations where you plan to restore the configuration information to the same VIOS partition from which it was backed up.

### Related tasks:

“Backing up user-defined virtual devices” on page 183

You can back up user-defined virtual devices by saving the data to a location that is automatically backed up when you use the **backupios** command to back up the Virtual I/O Server (VIOS). Alternatively, you can back up user-defined virtual devices by using the **viosbr** command.

### Related information:

-  Restoring user-defined virtual devices on the SDMC

### Restoring user-defined virtual devices manually:

In addition to restoring the Virtual I/O Server (VIOS), you might need to restore user-defined virtual devices (such as virtual device mappings). For example, in the event of a system failure, system migration, or disaster, you need to restore both the VIOS and user-defined virtual devices. In this situation, restore the volume groups by using the **restorevgstruct** command and manually re-create the virtual device mappings by using the **mkvdev** command.

### Before you begin

User-defined virtual devices include metadata, such as virtual device mappings, that define the relationship between the physical environment and the virtual environment. In situations where you plan to restore the VIOS to a new or different system, you need to back up both the VIOS and user-defined virtual devices. (For example, in the event of a system failure or disaster, you must restore both the VIOS and user-defined virtual devices.)

Before you start, restore the VIOS from tape, DVD, or a remote file system. For instructions, see one of the following procedures:

- “Restoring the Virtual I/O Server from tape” on page 192
- “Restoring the Virtual I/O Server from one or more DVDs” on page 192
- “Restoring the Virtual I/O Server from the HMC by using a nim\_resources.tar file” on page 193

- “Restoring the Virtual I/O Server from a NIM server by using a mksysb file” on page 193

### About this task

To restore user-defined virtual devices, complete the following steps:

#### Procedure

1. List all the backed-up volume groups (or storage pools) by running the following command:

```
restorevgstruct -ls
```

This command lists the files located in the `/home/ios/vgbackups` directory.

2. Run the `lspv` command to determine which disks are empty.
3. Restore the volume groups (or storage pools) to the empty disks by running the following command for each volume group (or storage pool):

```
restorevgstruct -vg volumegroup hdiskx
```

Where:





- *volume*group is the name of a volume group (or storage pool) from step 1.
  - *hdisk*x is the name of an empty disk from step 2.
4. Re-create the mappings between the virtual devices and physical devices by using the `mkvdev` command. Re-create mappings for storage device mappings, shared Ethernet and Ethernet adapter mappings, and virtual LAN settings. You can find mapping information in the file that you specified in the `tee` command from the backup procedure. For example, `/home/padmin/filename`.

#### Related tasks:

“Restoring user-defined virtual devices by using the `viosbr` command”

You can restore user-defined virtual devices by using the `viosbr` command. Use the `viosbr` command when you plan to restore the information to the same Virtual I/O Server (VIOS) logical partition from which it was backed up.

#### Related information:

-  [mkvdev command](#)
-  [restorevgstruct command](#)
-  [tee command](#)
-  [Restoring user-defined virtual devices manually on the SDMC](#)

#### Restoring user-defined virtual devices by using the `viosbr` command:

You can restore user-defined virtual devices by using the `viosbr` command. Use the `viosbr` command when you plan to restore the information to the same Virtual I/O Server (VIOS) logical partition from which it was backed up.

#### Before you begin

The `viosbr` command restores the VIOS partition to the same state in which it was when the backup was taken. With the information available from the backup, the command performs the following actions:

- Sets the attribute values for physical devices, such as controllers, adapters, disks, optical devices, tape devices, and Ethernet interfaces.
- Imports logical devices, such as volume groups or storage pools, clusters, logical volumes, file systems, and repositories.
- Creates virtual devices and their corresponding mappings for devices like Etherchannel, Shared Ethernet Adapter, virtual target devices, virtual Fibre Channel adapters, and paging space devices.

Before you start, complete the following tasks:

1. Run the **ioslevel** command to verify that the VIOS is at Version 2.1.2.0, or later.
2. Determine the backup file that you want to restore. The backup file must be a file that was created by using the **viosbr -backup** command.
3. Verify that the VIOS partition to which you plan to restore the information is the same VIOS partition from which it was backed up.

### About this task

### Procedure

To restore all the possible devices and display a summary of deployed and nondeployed devices, run the following command:

```
viosbr -restore -file /home/padmin/cfgbackups/myserverbackup.002.tar.gz
```

where */home/padmin/cfgbackups/myserverbackup.002.tar.gz* is the backup file that contains the information that you want to restore. The system displays information like the following output:

```
Backed up Devices that are unable to restore/change
=====
<Name(s) of non-deployed devices>
DEPLOYED or CHANGED devices:
=====
Dev name during BACKUP Dev name after RESTORE

<Name(s) of deployed devices>
```

### Related tasks:

“Backing up user-defined virtual devices by using the **viosbr** command” on page 186

You can back up user-defined virtual devices by using the **viosbr** command. Use the **viosbr** command when you plan to restore the information to the same Virtual I/O Server (VIOS) logical partition from which it was backed up.

“Restoring user-defined virtual devices manually” on page 195

In addition to restoring the Virtual I/O Server (VIOS), you might need to restore user-defined virtual devices (such as virtual device mappings). For example, in the event of a system failure, system migration, or disaster, you need to restore both the VIOS and user-defined virtual devices. In this situation, restore the volume groups by using the **restorevgstruct** command and manually re-create the virtual device mappings by using the **mkvdev** command.

### Related information:

 [ioslevel command](#)

 [viosbr command](#)

 [Restoring user-defined virtual devices by using the viosbr command](#)

## Restoring the Virtual I/O Server by using Tivoli Storage Manager

You can use the Tivoli Storage Manager to restore the mksysb image of the Virtual I/O Server.

### About this task

You can restore the Virtual I/O Server to the system from which it was backed up, or to a new or different system (for example, in the event of a system failure or disaster). The following procedure applies to restoring the Virtual I/O Server to the system from which it was backed up. First, you restore the mksysb image to the Virtual I/O Server using the **dsnc** command on the Tivoli Storage Manager client. But restoring the mksysb image does not restore the Virtual I/O Server. You then need to transfer the mksysb image to another system and convert the mksysb image to an installable format.

To restore the Virtual I/O Server to a new or different system, use one of the following procedures:

- “Restoring the Virtual I/O Server from tape” on page 192
- “Restoring the Virtual I/O Server from one or more DVDs” on page 192
- “Restoring the Virtual I/O Server from the HMC by using a `nim_resources.tar` file” on page 193
- “Restoring the Virtual I/O Server from a NIM server by using a `mksysb` file” on page 193

Before you start, complete the following tasks:

1. Ensure that the system to which you plan to transfer the `mksysb` image is running AIX.
2. Ensure that the system running AIX has a DVD-RW or CD-RW drive.
3. Ensure that AIX has the `cdrecord` and `mkisofs` RPMs downloaded and installed. To download and install the RPMs, see the AIX Toolbox for Linux Applications Web site.

**Restriction:** Interactive mode is not supported on the Virtual I/O Server. You can view session information by typing `dsmc` on the Virtual I/O Server command line.

To restore the Virtual I/O Server using Tivoli Storage Manager, complete the following tasks:

### Procedure

1. Determine which file you want to restore by running the `dsmc` command to display the files that have been backed up to the Tivoli Storage Manager server:

```
dsmc -query
```

2. Restore the `mksysb` image using the `dsmc` command. For example:

```
dsmc -restore sourcefilespec
```

Where *sourcefilespec* is the directory path to the location where you want to restore the `mksysb` image. For example, `/home/padmin/mksysb_image`

3. Transfer the `mksysb` image to a server with a DVD-RW or CD-RW drive by running the following File Transfer Protocol (FTP) commands:
  - a. Run the following command to make sure that the FTP server is started on the Virtual I/O Server:

```
startnetsvc ftp
```
  - b. Run the following command to make sure that the FTP server is started on the Virtual I/O Server:

```
startnetsvc ftp
```
  - c. Open an FTP session to the server with the DVD-RW or CD-RW drive: `ftp server_hostname`, where *server\_hostname* is the hostname of the server with the DVD-RW or CD-RW drive.
  - d. At the FTP prompt, change to the installation directory to the directory where you want to save the `mksysb` image.
  - e. Set the transfer mode to binary: `binary`
  - f. Turn off interactive prompting if it is on: `prompt`
  - g. Transfer the `mksysb` image to the server: `mput mksysb_image`
  - h. Close the FTP session, after transferring `mksysb` image, by typing `quit`.
4. Write the `mksysb` image to CD or DVD using the `mkcd` or `mkdvd` commands.
5. Reinstall the Virtual I/O Server using the CD or DVD that you just created. For instructions, see “Restoring the Virtual I/O Server from one or more DVDs” on page 192.



#### Related reference:

 [mkcd Command](#)

 [mkdvd Command](#)

#### Related information:

 [Restoring using Tivoli Storage Manager](#)

## Installing or replacing a PCI adapter with the system power on in Virtual I/O Server

You can install or replace a PCI adapter in the Virtual I/O Server logical partition or in the Integrated Virtualization Manager management partition.

### Before you begin

The Virtual I/O Server includes a PCI Hot Plug Manager that is similar to the PCI Hot Plug Manager in the AIX operating system. The PCI Hot Plug Manager allows you to hot plug PCI adapters into the server and then activate them for the logical partition without having to reboot the system. Use the PCI Hot Plug Manager for adding, identifying, or replacing PCI adapters in the system that are currently assigned to the Virtual I/O Server.

### Getting started

#### Before you begin

##### Prerequisites:

- If you are installing a new adapter, an empty system slot must be assigned to the Virtual I/O Server logical partition. This task can be done through dynamic logical partitioning (DLPAR) operations.
  - If you are using a Hardware Management Console (HMC), you must also update the logical partition profile of the Virtual I/O Server so that the new adapter is configured to the Virtual I/O Server after you restart the system.
  - If you are using the Integrated Virtualization Manager, an empty slot is probably already assigned to the Virtual I/O Server logical partition because all slots are assigned to the Virtual I/O Server by default. You only need to assign an empty slot to the Virtual I/O Server logical partition if you previously assigned all empty slots to other logical partitions.
- If you are installing a new adapter, ensure that you have the software required to support the new adapter and determine whether there are any existing PTF prerequisites to install.
- If you need help determining the PCI slot in which to place a PCI adapter, see the PCI adapter placement.

#### About this task

Follow these steps to access the Virtual I/O Server, PCI Hot Plug Manager:

#### Procedure

1. If you are using the Integrated Virtualization Manager, connect to the command-line interface.
2. Use the **diagmenu** command to open the Virtual I/O Server diagnostic menu. The menus are similar to the AIX diagnostic menus.
3. Select **Task Selection**, then press Enter.
4. At the Task Selection list, select **PCI Hot Plug Manager**.

## Installing a PCI adapter

### About this task

To install a PCI adapter with the system power on in Virtual I/O Server, do the following steps:

#### Procedure

1. From the PCI Hot Plug Manager, select **Add a PCI Hot Plug Adapter**, then press Enter. The Add a Hot-Plug Adapter window is displayed.
2. Select the appropriate empty PCI slot from those listed, and press Enter. A fast-blinking amber LED located at the back of the server near the adapter indicates that the slot has been identified.
3. Follow the instructions on the screen to install the adapter until the LED for the specified PCI slot is set to the Action state.
  - a. Set the adapter LED to the action state so that the indicator light for the adapter slot flashes
  - b. Physically install the adapter
  - c. Finish the adapter installation task in **diagmenu**.
4. Run the `cfgdev` command to configure the device for the Virtual I/O Server.

#### Results

If you are installing a PCI, Fibre Channel adapter, it is now ready to be attached to a SAN and have LUNs assigned to the Virtual I/O Server for virtualization.

## Replacing a PCI adapter

### Before you begin

**Prerequisite:** Before you can remove or replace a storage adapter, you must unconfigure that adapter. See “Unconfiguring storage adapters” on page 201 for instructions.

### About this task

To replace a PCI adapter with the system power on in Virtual I/O Server, do the following steps:

#### Procedure

1. From the PCI Hot Plug Manager, select **Unconfigure a Device**, then press Enter.
2. Press F4 (or Esc +4) to display the **Device Names** menu.
3. Select the adapter you are removing in the **Device Names** menu.
4. In the **Keep Definition** field, use the Tab key to answer Yes. In the **Unconfigure Child Devices** field, use the Tab key again to answer YES, then press Enter.
5. Press Enter to verify the information on the **ARE YOU SURE** screen. Successful unconfiguration is indicated by the OK message displayed next to the Command field at the top of the screen.
6. Press F4 (or Esc +4) twice to return to the Hot Plug Manager.
7. Select **replace/remove PCI Hot Plug adapter**.
8. Select the slot that has the device to be removed from the system.
9. Select **replace**. A fast-blinking amber LED located at the back of the machine near the adapter indicates that the slot has been identified.
10. Press Enter which places the adapter in the action state, meaning it is ready to be removed from the system.

## Unconfiguring storage adapters

### About this task

Before you can remove or replace a storage adapter, you must unconfigure that adapter. Storage adapters are generally parent devices to media devices, such as disk drives or tape drives. Removing the parent requires that all attached child devices either be removed or placed in the define state.

Unconfiguring a storage adapter involves the following tasks:

- Closing all applications that are using the adapter you are removing, replacing, or moving
- Unmounting file systems
- Ensuring that all devices connected to the adapter are identified and stopped
- Listing all slots that are currently in use or a slot that is occupied by a specific adapter
- Identifying the adapter's slot location
- Making parent and child devices unavailable
- Making the adapter unavailable

If the adapter supports physical volumes that are in use by a client logical partition, then You can perform steps on the client logical partition before unconfiguring the storage adapter. For instructions, see "Preparing the client logical partitions." For example, the adapter might be in use because the physical volume was used to create a virtual target device, or it might be part of a volume group used to create a virtual target device.

Follow these steps to unconfigure SCSI, SSA, and Fibre Channel storage adapters:

### Procedure

1. Connect to the Virtual I/O Server command-line interface.
2. Use the `oem_setup_env` command to close all applications that are using the adapter you are unconfiguring.
3. Type `lsslot-c pci` to list all the hot plug slots in the system unit and display their characteristics.
4. Type `lsdev -C` to list the current state of all the devices in the system unit.
5. Type `umount` to unmount previously mounted file systems, directories, or files using this adapter.
6. Type `rmdev -l adapter -R` to make the adapter unavailable.

**Attention:** Do not use the `-d` flag with the `rmdev` command for hot plug operations because this action removes your configuration.

## Preparing the client logical partitions

### About this task

If the virtual target devices of the client logical partitions are not available, the client logical partitions can fail or they might be unable to perform I/O operations for a particular application. If you use the HMC to manage the system, you might have redundant Virtual I/O Server logical partitions, which allow for Virtual I/O Server maintenance and avoid downtime for client logical partitions. If you are replacing an adapter on the Virtual I/O Server and your client logical partition is dependent on one or more of the physical volumes accessed by that adapter, then You can take action on the client before you unconfigure the adapter.

The virtual target devices must be in the define state before the Virtual I/O Server adapter can be replaced. Do not remove the virtual devices permanently.

## Procedure

To prepare the client logical partitions so that you can unconfigure an adapter, complete the following steps depending on your situation.

Table 45. Situations and steps for preparing the client logical partitions

| Situation                                                                                                                                                                                                            | Steps                                                                                                                                                                                                                                                                                                                                                                                                                                                                                                               |
|----------------------------------------------------------------------------------------------------------------------------------------------------------------------------------------------------------------------|---------------------------------------------------------------------------------------------------------------------------------------------------------------------------------------------------------------------------------------------------------------------------------------------------------------------------------------------------------------------------------------------------------------------------------------------------------------------------------------------------------------------|
| You have redundant hardware on the Virtual I/O Server for the adapter.                                                                                                                                               | No action is required on the client logical partition.                                                                                                                                                                                                                                                                                                                                                                                                                                                              |
| HMC-managed systems only: You have redundant Virtual I/O Server logical partitions that, in conjunction with virtual client adapters, provide multiple paths to the physical volume on the client logical partition. | No action is required on the client logical partition. However, path errors might be logged on the client logical partition.                                                                                                                                                                                                                                                                                                                                                                                        |
| HMC-managed systems only: You have redundant Virtual I/O Server logical partitions that, in conjunction with virtual client adapters, provide multiple physical volumes that are used to mirror a volume group.      | See the procedures for your client operating system.                                                                                                                                                                                                                                                                                                                                                                                                                                                                |
| You do not have redundant Virtual I/O Server logical partitions.                                                                                                                                                     | Shut down the client logical partition.<br><br>For instructions, see the following topics about shutting down logical partitions: <ul style="list-style-type: none"><li>• For systems that are managed by the HMC, see “Shutting down AIX logical partitions using the HMC”, and “Shutting down Linux logical partitions using the HMC” in the Logical partitioning.<sup>1</sup></li><li>• For systems that are managed by the Integrated Virtualization Manager, see “Shutting down logical partitions.”</li></ul> |

<sup>1</sup>The Logical partitioning can be found on the Hardware Information website at [add URL here](#).

## Shutting down logical partitions

You can use the Integrated Virtualization Manager to shut down the logical partitions or to shut down the entire managed system.

### Before you begin

Use any role other than View Only to perform this task.

### About this task

The Integrated Virtualization Manager provides the following types of shutdown options for logical partitions:

- Operating System (recommended)
- Delayed
- Immediate

The recommended shutdown method is to use the client operating systems shutdown command. Use the immediate shutdown method only as a last resort because using this method causes an abnormal shutdown which might result in data loss.

If you choose the Delayed shutdown method, then be aware of the following considerations:

- Shutting down the logical partitions is equivalent to pressing and holding the white control-panel power button on a server that is not partitioned.

- Use this procedure only if you cannot successfully shut down the logical partitions through operating system commands. When you use this procedure to shut down the selected logical partitions, the logical partitions wait a predetermined amount of time to shut down. This allows the logical partitions time to end jobs and write data to disks. If the logical partition is unable to shut down within the predetermined amount of time, it ends abnormally, and the next restart might take a long time.

If you plan to shut down the entire managed system, shut down each client logical partition, then shut down the Virtual I/O Server management partition.

To shut down a logical partition, complete the following steps in the Integrated Virtualization Manager:

### Procedure

1. In the navigation area, select **View/Modify Partitions** under **Partition Management**. The View/Modify Partitions page is displayed.
2. Select the logical partition that you want to shut down.
3. From the Tasks menu, click **Shutdown**. The Shutdown Partitions page is displayed.
4. Select the shutdown type.
5. Optional: Select **Restart after shutdown completes** if you want the logical partition to start immediately after it shuts down.
6. Click **OK** to shut down the partition. The View/Modify Partitions page is displayed, and the logical partition state has a value of shutdown.

## Viewing information and statistics about the Virtual I/O Server, the server, and virtual resources

You can view information and statistics about the Virtual I/O Server, the server, and virtual resources to help you manage and monitor the system, and troubleshoot problems.

### About this task

The following table lists the information and statistics available on the Virtual I/O Server, as well as the commands you need to run to view the information and statistics.

*Table 46. Information and associated commands for the Virtual I/O Server*

| Information to view                                                                                                                                                          | Command       |
|------------------------------------------------------------------------------------------------------------------------------------------------------------------------------|---------------|
| Statistics about kernel threads, virtual memory, disks, traps, and processor activity.                                                                                       | <b>vmstat</b> |
| Statistics for a Fibre Channel device driver.                                                                                                                                | <b>fcstat</b> |
| A summary of virtual memory usage.                                                                                                                                           | <b>svmon</b>  |
| Information about the Virtual I/O Server and the server, such as the server model, machine ID, Virtual I/O Server logical partition name and ID, and the LAN network number. | <b>uname</b>  |

Table 46. Information and associated commands for the Virtual I/O Server (continued)

| Information to view                                                                                                                                                                                                                                                                                                                                                                                                                                                                                                                                                                                                                                                                                                                                                                                                                                                                                                                                                                                                                                                                                                                                                                                                                    | Command              |
|----------------------------------------------------------------------------------------------------------------------------------------------------------------------------------------------------------------------------------------------------------------------------------------------------------------------------------------------------------------------------------------------------------------------------------------------------------------------------------------------------------------------------------------------------------------------------------------------------------------------------------------------------------------------------------------------------------------------------------------------------------------------------------------------------------------------------------------------------------------------------------------------------------------------------------------------------------------------------------------------------------------------------------------------------------------------------------------------------------------------------------------------------------------------------------------------------------------------------------------|----------------------|
| <p>Generic and device-specific statistics for an Ethernet driver or device, including the following information for a Shared Ethernet Adapter:</p> <ul style="list-style-type: none"> <li>• Shared Ethernet Adapter statistics: <ul style="list-style-type: none"> <li>– Number of real and virtual adapters (If you are using Shared Ethernet Adapter failover, this number does not include the control channel adapter)</li> <li>– Shared Ethernet Adapter flags</li> <li>– VLAN IDs</li> <li>– Information about real and virtual adapters</li> </ul> </li> <li>• Shared Ethernet Adapter failover statistics: <ul style="list-style-type: none"> <li>– High availability statistics</li> <li>– Packet types</li> <li>– State of the Shared Ethernet Adapter</li> <li>– Bridging mode</li> </ul> </li> <li>• GARP VLAN Registration Protocol (GVRP) statistics: <ul style="list-style-type: none"> <li>– Bridge Protocol Data Unit (BPDU) statistics</li> <li>– Generic Attribute Registration Protocol (GARP) statistics</li> <li>– GARP VLAN Registration Protocol (GVRP) statistics</li> </ul> </li> <li>• Listing of the individual adapter statistics for the adapters associated with the Shared Ethernet Adapter</li> </ul> | <p><b>enstat</b></p> |

The **vmstat**, **fcstat**, **svmon**, and **uname** commands are available with Virtual I/O Server Version 1.5 or later.

## Monitoring the Virtual I/O Server

You can monitor the Virtual I/O Server using error logs or Tivoli Monitoring.

### Error logs

AIX and Linux client logical partitions log errors against failing I/O operations. Hardware errors on the client logical partitions associated with virtual devices usually have corresponding errors logged on the server. However, if the failure is within the client logical partition, there will not be errors on the server.

**Note:** On Linux client logical partitions, if the algorithm for retrying Small Computer Serial Interface (SCSI) temporary errors is different from the algorithm used by AIX, the errors might not be recorded on the server.

### Tivoli Monitoring

With Virtual I/O Server V1.3.0.1 (fix pack 8.1), you can install and configure the Tivoli Monitoring System Edition agent on the Virtual I/O Server. With Tivoli Monitoring System Edition, you can monitor the health and availability of multiple servers (including the Virtual I/O Server) from the Tivoli Enterprise Portal. Tivoli Monitoring System Edition gathers data from the Virtual I/O Server, including data about physical volumes, logical volumes, storage pools, storage mappings, network mappings, real memory, processor resources, mounted file system sizes, and so on. From the Tivoli Enterprise Portal, you can view a graphical representation of the data, use predefined thresholds to alert you on key metrics, and resolve issues based on recommendations provided by the Expert Advice feature of Tivoli Monitoring.

---

## Security on the Virtual I/O Server

Become familiar with the Virtual I/O Server security features.

Beginning with Version 1.3 of the Virtual I/O Server, you can set security options that provide tighter security controls over your Virtual I/O Server environment. These options allow you to select a level of system security hardening and specify the settings allowable within that level. The Virtual I/O Server security feature also allows you to control network traffic by enabling the Virtual I/O Server firewall. You can configure these options using the **viosecure** command. To help you set up system security when you initially install the Virtual I/O Server, the Virtual I/O Server provides the configuration assistance menu. You can access the configuration assistance menu by running the **cfgassist** command.

Using the **viosecure** command, you can set, change, and view current security settings. By default, no Virtual I/O Server security levels are set. You must run the **viosecure** command to change the settings.

The following sections provide an overview of these features.

### Virtual I/O Server system security hardening

The system security hardening feature protects all elements of a system by tightening security or implementing a higher level of security. Although hundreds of security configurations are possible with the Virtual I/O Server security settings, you can easily implement security controls by specifying a high, medium, or low security level.

Using the system security hardening features provided by Virtual I/O Server, you can specify values such as the following:

- Password policy settings
- Actions such as **usrck**, **pwdck**, **grpck**, and **sysck**
- Default file-creation settings
- Settings included in the **crontab** command

Configuring a system at too high a security level might deny services that are needed. For example, **telnet** and **rlogin** are disabled for high level security because the login password is sent over the network unencrypted. If a system is configured at too low a security level, the system might be vulnerable to security threats. Since each enterprise has its own unique set of security requirements, the predefined High, Medium, and Low security configuration settings are best suited as a starting point for security configuration rather than an exact match for the security requirements of a particular enterprise. As you become more familiar with the security settings, you can make adjustments by choosing the hardening rules you want to apply. You can get information about the hardening rules by running the **man** command.

### Virtual I/O Server firewall

Using the Virtual I/O Server firewall, you can enforce limitations on IP activity in your virtual environment. With this feature, you can specify which ports and network services are allowed access to the Virtual I/O Server system. For example, if you need to restrict login activity from an unauthorized port, you can specify the port name or number and specify **deny** to remove it from the allow list. You can also restrict a specific IP address.

### Connecting to the Virtual I/O Server by using OpenSSH

You can set up remote connections to the Virtual I/O Server using secure connections.

## About this task

You can use the Open Source Secure Sockets Layer (OpenSSL) and Portable Secure Shell (OpenSSH) software to connect to the Virtual I/O Server using secure connections. For more information about OpenSSL and OpenSSH, see the OpenSSL Project and Portable SSH Web sites.

To connect to the Virtual I/O Server using OpenSSH, complete the following tasks:

### Procedure

1. If you are using a version of Virtual I/O Server prior to Version 1.3.0, then install OpenSSH before you connect. For instructions, see “Downloading, installing, and updating OpenSSH and OpenSSL” on page 207.
2. Connect to the Virtual I/O Server. If you are using Version 1.3.0 or later, then connect using either an interactive or noninteractive shell. If you are using a version prior to 1.3.0, then connect using only an interactive shell.

- To connect using an interactive shell, type the following command from the command line of a remote system:

```
ssh username@vioshostname
```

where *username* is your user name for the Virtual I/O Server and *vioshostname* is the name of the Virtual I/O Server.

- To connect using a noninteractive shell, run the following command:

```
ssh username@vioshostname command
```

Where:

- *username* is your user name for the Virtual I/O Server.
- *vioshostname* is the name of the Virtual I/O Server.
- *command* is the command that you want to run. For example, `ioscli lsmapping -all`.

**Note:** When using a noninteractive shell, remember to use the full command form (including the `ioscli` prefix) for all Virtual I/O Server commands.

3. Authenticate SSH. If you are using Version 1.3.0 or later, then authenticate using either passwords or keys. If you are using a version prior to 1.3.0, then authenticate using only passwords.

- To authenticate using passwords, enter your user name and password when prompted by the SSH client.
- To authenticate using keys, perform the following steps on the SSH client's operating system:
  - a. Create a directory called `$HOME/.ssh` to store the keys. You can use RSA or DSA keys.
  - b. Run the **ssh-keygen** command to generate public and private keys. For example,  

```
ssh-keygen -t rsa
```

This creates the following files in the `$HOME/.ssh` directory:

- Private key: `id_rsa`
- Public key: `id_rsa.pub`

- c. Run the following command to append the public key to the `authorized_keys2` file on the Virtual I/O Server:

```
cat $HOME/.ssh/public_key_file | ssh username@vioshostname tee -a /home/username/.ssh/authorized_keys2
```

Where:

- *public\_key\_file* is the public key file that is generated in the previous step. For example, `id_rsa.pub`.
- *username* is your user name for the Virtual I/O Server.



- *vioshostname* is the name of the Virtual I/O Server.

## What to do next

The Virtual I/O Server might not include the latest version of OpenSSH or OpenSSL with each release. In addition, there might be OpenSSH or OpenSSL updates released in between Virtual I/O Server releases. In these situations, you can update OpenSSH and OpenSSL on the Virtual I/O Server by downloading and installing OpenSSH and OpenSSL. For instructions, see “Downloading, installing, and updating OpenSSH and OpenSSL.”

## Downloading, installing, and updating OpenSSH and OpenSSL

If you are using a Virtual I/O Server version prior to 1.3, you must download and install OpenSSH and OpenSSL software before you can connect to the Virtual I/O Server using OpenSSH. You can also use this procedure to update OpenSSH and OpenSSL on the Virtual I/O Server.

### About this task

OpenSSH and OpenSSL might need to be updated on your Virtual I/O Server if the Virtual I/O Server did not include the latest version of OpenSSH or OpenSSL, or if there were OpenSSH or OpenSSL updates released in between Virtual I/O Server releases. In these situations, you can update OpenSSH and OpenSSL on the Virtual I/O Server by downloading and installing OpenSSH and OpenSSL using the following procedure.

For more information about OpenSSL and OpenSSH, see the OpenSSL Project and Portable SSH Web sites.

### Downloading the Open Source software:

#### About this task

The OpenSSL software contains the encrypted library that is required to use the OpenSSH software. To download the software, complete the following tasks:

#### Procedure

1. Download the OpenSSL RPM package to your workstation or host computer.
  - a. To get the RPM package, go to the AIX Toolbox for Linux Applications Web site and click the **AIX Toolbox Cryptographic Content** link on the right side of the Web page.
  - b. If you are registered to download the RPM packages, then sign in and accept the license agreement.
  - c. If you are not registered to download the RPM packages, then complete the registration process and accept the license agreement. After registering, you are redirected to the download page.
  - d. Select any version of the package for download: **openssl - Secure Sockets Layer and cryptography libraries and tools** and click **Download Now** to start the download.
2. Download the OpenSSH software by completing the following steps:

**Note:** Alternatively, you can install the software from the AIX Expansion Pack.

- a. From your workstation (or host computer), go to the SourceFORGE.net Web site.
  - b. Click **Download OpenSSH on AIX** to view the latest file releases.
  - c. Select the appropriate download package and click **Download**.
  - d. Click the openssh package (tar.Z file) to continue with the download.
3. Create a directory on the Virtual I/O Server for the Open Source software files. For example, to create an installation directory named `install_ssh`, run the following command: `mkdir install_ssh`.
  4. Transfer the software packages to the Virtual I/O Server by running the following File Transfer Protocol (FTP) commands from the computer on which you downloaded the software packages:

- a. Run the following command to make sure that the FTP server is started on the Virtual I/O Server:  
`startnetsvc ftp`
- b. Open an FTP session to the Virtual I/O Server on your local host: `ftp vios_server_hostname`, where `vios_server_hostname` is the host name of the Virtual I/O Server.
- c. At the FTP prompt, change to the installation directory that you created for the Open Source files:  
`cd install_ssh`, where `install_ssh` is the directory that contains the Open Source files.
- d. Set the transfer mode to binary: `binary`
- e. Turn off interactive prompting if it is on: `prompt`
- f. Transfer the downloaded software to the Virtual I/O Server: `mput ssl_software_pkg`, where `ssl_software_pkg` is the software that you downloaded.
- g. Close the FTP session, after transferring both software packages, by typing `quit`.

## Install the Open Source software on the Virtual I/O Server:

### About this task

To install the software, complete the following steps:

#### Procedure

1. Run the following command from the Virtual I/O Server command line: `updateios -dev install_ssh -accept -install`, where `install_ssh` is the directory that contains the Open Source files. The installation program automatically starts the Secure Shell daemon (`sshd`) on the server.
2. Begin using the `ssh` and `scp` commands; no further configuration is required.

#### Restrictions:

- The `sftp` command is not supported on versions of Virtual I/O Server earlier than 1.3.
- Noninteractive shells are not supported using OpenSSH with the Virtual I/O Server versions earlier than 1.3.

## Configuring Virtual I/O Server system security hardening

Set the security level to specify security hardening rules for your Virtual I/O Server system.

### Before you begin

To implement system security hardening rules, you can use the `viorecure` command to specify a security level of high, medium, or low. A default set of rules is defined for each level. You can also set a level of default, which returns the system to the system standard settings and removes any level settings that have been applied.

### About this task

The low level security settings are a subset of the medium level security settings, which are a subset of the high level security settings. Therefore, the *high* level is the most restrictive and provides the greatest level of control. You can apply all of the rules for a specified level or select which rules to activate for your environment. By default, no Virtual I/O Server security levels are set; you must run the `viorecure` command to modify the settings.

Use the following tasks to configure the system security settings.

### Setting a security level

#### Procedure

To set a Virtual I/O Server security level of high, medium, or low, use the command `viorecure -level`. For example:

```
viosecure -level low -apply
```

## Changing the settings in a security level Procedure

To set a Virtual I/O Server security level in which you specify which hardening rules to apply for the setting, run the **viosecure** command interactively. For example:

1. At the Virtual I/O Server command line, type `viosecure -level high`. All the security level options (hardening rules) at that level are displayed ten at a time (pressing Enter displays the next set in the sequence).
2. Review the options displayed and make your selection by entering the numbers, separated by a comma, that you want to apply, or type **ALL** to apply all the options or **NONE** to apply none of the options.
3. Press **Enter** to display the next set of options, and continue entering your selections.

**Note:** To exit the command without making any changes, type “q”.

## Viewing the current security setting Procedure

To display the current Virtual I/O Server security level setting use the **viosecure** command with the **-view** flag. For example:

```
viosecure -view
```

## Removing security level settings Procedure

- To unset any previously set system security levels and return the system to the standard system settings, run the following command: `viosecure -level default`
- To remove the security settings that have been applied, run the following command: `viosecure -undo`

## Configuring Virtual I/O Server firewall settings

Enable the Virtual I/O Server firewall to control IP activity.

### Before you begin

The Virtual I/O Server firewall is not enabled by default. To enable the Virtual I/O Server firewall, you must turn it on by using the **viosecure** command with the **-firewall** option. When you enable it, the default setting is activated, which allows access for the following IP services:

- ftp
- ftp-data
- ssh
- web
- https
- rmc
- cimom

**Note:** The firewall settings are contained in the file `viosecure.ctl` in the `/home/ios/security` directory. If for some reason the `viosecure.ctl` file does not exist when you run the command to enable the firewall, you receive an error. You can use the **-force** option to enable the standard firewall default ports.

You can use the default setting or configure the firewall settings to meet the needs of your environment by specifying which ports or port services to allow. You can also turn off the firewall to deactivate the settings.

## About this task

Use the following tasks at the Virtual I/O Server command line to configure the Virtual I/O Server firewall settings:

### Procedure

1. Enable the Virtual I/O Server firewall by running the following command:  
`viosecure -firewall on`
2. Specify the ports to allow or deny, by using the following command:  
`viosecure -firwall allow | deny -port number`
3. View the current firewall settings by running the following command:  
`viosecure -firewall view`
4. If you want to disable the firewall configuration, run the following command:  
`viosecure -firewall off`

## Configuring a Kerberos client on the Virtual I/O Server

You can configure a Kerberos client on the Virtual I/O Server to enhance security in communications across the Internet.

### Before you begin

Before you start, ensure that the Virtual I/O Server Version 1.5 or later.

## About this task

Kerberos is a network authentication protocol that provides authentication for client and server applications by using a secret-key cryptography. It negotiates authenticated, and optionally encrypted, communications between two points anywhere on the Internet. Kerberos authentication generally works as follows:

1. A Kerberos client sends a request for a ticket to the Key Distribution Center (KDC).
2. The KDC creates a ticket-granting ticket (TGT) for the client and encrypts it using the client's password as the key.
3. The KDC returns the encrypted TGT to the client.
4. The client attempts to decrypt the TGT, using its password.
5. If the client successfully decrypts the TGT (for example, if the client gives the correct password), the client keeps the decrypted TGT. The TGT indicates proof of the client's identity.

### Procedure

To configure a Kerberos client on the Virtual I/O Server, run the following command.

```
mkkrb5c1nt -c KDC_server -r realm_name \ -s Kerberos_server -d Kerberos_client
```

Where:

- *KDC\_server* is the name of the KDC server.
- *realm\_name* is the name of the realm to which you want to configure the Kerberos client.
- *Kerberos\_server* is the fully qualified host name of the Kerberos server.
- *Kerberos\_client* is the domain name of the Kerberos client.

For example:

```
mkkrb5c1nt -c bob.kerberso.com -r KERBER.COM \ -s bob.kerberso.com -d testbox.com
```

In this example, you configure the Kerberos client, `testbox.com`, to the Kerberos server, `bob.kerberso.com`. The KDC is running on `bob.kerberso.com`.

## Using role-based access control with the Virtual I/O Server

With Virtual I/O Server Version 2.2, and later, a system administrator can define roles based on job functions in an organization by using role-based access control (RBAC).

A system administrator can use role-based access control (RBAC) to define roles for users in the Virtual I/O Server. A role confers a set of permissions or authorizations to the assigned user. Thus, a user can only perform a specific set of system functions depending on the access rights that are given. For example, if the system administrator creates the role **UserManagement** with authorization to access user management commands and assigns this role to a user, that user can manage users on the system but has no further access rights.

The benefits of using role-based access control with the Virtual I/O Server are as follows:

- Splitting system management functions
- Providing better security by granting only necessary access rights to users
- Implementing and enforcing system management and access control consistently
- Managing and auditing system functions with ease

## Authorizations

The Virtual I/O Server creates authorizations that closely emulate the authorizations of the AIX operating system. The authorizations emulate naming conventions and descriptions, but are only applicable to the Virtual I/O Server specific requirements. By default, the **padmin** user is granted all the authorizations on the Virtual I/O Server, and can run all the commands. The other types of users (created by using the **mkuser** command) retain their command execution permissions.

The **mkauth** command creates a new user-defined authorization in the authorization database. You can create authorization hierarchies by using a dot (.) in the *auth* parameter to create an authorization of the form *ParentAuth.SubParentAuth.SubSubParentAuth...*. All parent elements in the *auth* parameter must exist in the authorization database before the authorization is created. The maximum number of parent elements that you can use to create an authorization is eight.

You can set authorization attributes when you create authorizations through the *Attribute=Value* parameter. Every authorization that you create must have a value for the **id** authorization attribute. If you do not specify the **id** attribute using the **mkauth** command, the command automatically generates a unique ID for the authorization. If you specify an ID, the value must be unique and greater than 15000. The IDs 1 - 15000 are reserved for system-defined authorizations.

### Naming convention:

The system-defined authorizations in the Virtual I/O Server start with **vios.**. Hence, user-defined authorizations must not start with **vios.** or **aix.**. Since the authorizations that start with **vios.** and **aix.** are considered system-defined authorizations, users cannot add any further hierarchies to these authorizations.

### Restriction:

Unlike in the AIX operating system, users cannot create authorizations for all Virtual I/O Server commands. In the AIX operating system, an authorized user can create a hierarchy of authorizations for all the commands. However, in the Virtual I/O Server, authorizations can only be created for the

commands or scripts owned by the user. Users cannot create any authorizations that start with **vios.** or **aix.** since they are considered system-defined authorizations. Hence, users cannot add any further hierarchies to these authorizations.

Authorization names must not begin with a dash (-), plus sign (+), at sign (@), or tilde (~). They must not contain spaces, tabs, or newline characters. You cannot use the keywords **ALL**, **default**, **ALLOW\_OWNER**, **ALLOW\_GROUP**, **ALLOW\_ALL**, or an asterisk (\*) as an authorization name. Do not use the following characters within an authorization string:

- : (colon)
- " (quotation mark)
- # (number sign)
- , (comma)
- = (equal sign)
- \ (backslash)
- / (forward slash)
- ? (question mark)
- ' (single quotation mark)
- ` (grave accent)

The following table lists the authorizations corresponding to the Virtual I/O Server commands. The **vios** and subsequent child authorizations, for example, **vios** and **vios.device** are not used. If a user is given a role that has either the parent or subsequent child authorization, for example, **vios** or **vios.device**, that user will have access to all the subsequent children authorizations and their related commands. For example, a role with the authorization **vios.device**, gives the user access to all **vios.device.config** and **vios.device.manage** authorizations and their related commands.

*Table 47. Authorizations corresponding to Virtual I/O Server commands*

| Command            | Command options | Authorization                     |
|--------------------|-----------------|-----------------------------------|
| <b>activatevg</b>  | All             | vios.lvm.manage.varyon            |
| <b>alert</b>       | All             | vios.system.cluster.alert         |
| <b>alt_root_vg</b> | All             | vios.lvm.change.altrootvg         |
| <b>artexdiff</b>   | All             | vios.system.rtxpert.diff          |
| <b>artexget</b>    | All             | vios.system.rtxpert.get           |
| <b>artexlist</b>   | All             | vios.system.rtxpert.list          |
| <b>artexmerge</b>  | All             | vios.system.rtxpert.merge         |
| <b>artexset</b>    | All             | vios.system.rtxpert.set           |
| <b>backup</b>      | All             | vios.fs.backup                    |
| <b>backupios</b>   | All             | vios.install.backup               |
| <b>bootlist</b>    | All             | vios.install.bootlist             |
| <b>cattracerpt</b> | All             | vios.system.trace.format          |
| <b>cfgassist</b>   | All             | vios.security.cfgassist           |
| <b>cfgdev</b>      | All             | vios.device.config                |
| <b>cfglnagg</b>    | All             | vios.network.config.lnagg         |
| <b>cfgnamesrv</b>  | All             | vios.system.dns                   |
| <b>cfgsvc</b>      | All             | vios.system.config.agent          |
| <b>chauth</b>      | All             | vios.security.auth.change         |
| <b>chbdsp</b>      | All             | vios.device.manage.backing.change |

Table 47. Authorizations corresponding to Virtual I/O Server commands (continued)

| Command             | Command options | Authorization                     |
|---------------------|-----------------|-----------------------------------|
| <b>chdate</b>       | All             | vios.system.config.date.change    |
| <b>chdev</b>        | All             | vios.device.manage.change         |
| <b>checkfs</b>      | All             | vios.fs.check                     |
| <b>chedition</b>    | All             | vios.system.edition               |
| <b>chkdev</b>       | All             | vios.device.manage.check          |
| <b>chlang</b>       | All             | vios.system.config.locale         |
| <b>chlv</b>         | All             | vios.lvm.manage.change            |
| <b>chpath</b>       | All             | vios.device.manage.path.change    |
| <b>chrep</b>        | All             | vios.device.manage.repos.change   |
| <b>chrole</b>       | All             | vios.security.role.change         |
| <b>chsp</b>         | All             | vios.device.manage.spool.change   |
| <b>htcpip</b>       | All             | vios.network.tcpip.change         |
| <b>chuser</b>       | All             | vios.security.user.change         |
| <b>chvg</b>         | All             | vios.lvm.manage.change            |
| <b>chvlog</b>       | All             | vios.device.manage.vlog.change    |
| <b>chv1repo</b>     | All             | vios.device.manage.v1repo.change  |
| <b>chvopt</b>       | All             | vios.device.manage.optical.change |
| <b>cl_snmp</b>      | All             | vios.security.manage.snmp.query   |
| <b>cleandisk</b>    | All             | aix.system.cluster                |
| <b>cluster</b>      | All             | vios.system.cluster.create        |
| <b>cplv</b>         | All             | vios.lvm.manage.copy              |
| <b>cpvdi</b>        | All             | vios.lvm.manage.copy              |
| <b>deactivatevg</b> | All             | vios.lvm.manage.varyoff           |
| <b>diagmenu</b>     | All             | vios.system.diagnostics           |
| <b>dsmc</b>         | All             | vios.system.manage.tsm            |
| <b>entstat</b>      | All             | vios.network.stat.ent             |
| <b>errlog</b>       | <b>-rm</b>      | vios.system.log                   |
|                     | Others          | vios.system.log.view              |
| <b>exportvg</b>     | All             | vios.lvm.manage.export            |
| <b>extendlv</b>     | All             | vios.lvm.manage.extend            |
| <b>extendvg</b>     | All             | vios.lvm.manage.extend            |
| <b>fcstat</b>       | All             | vios.network.stat.fc              |
| <b>fsck</b>         | All             | vios.fs.check                     |
| <b>hostmap</b>      | All             | vios.system.config.address        |
| <b>hostname</b>     | All             | vios.system.config.hostname       |
| <b>importvg</b>     | All             | vios.lvm.manage.import            |
| <b>invscout</b>     | All             | vios.system.firmware.scout        |
| <b>ioslevel</b>     | All             | vios.system.level                 |
| <b>ldapadd</b>      | All             | vios.security.manage.ldap.add     |
| <b>ldapsearch</b>   | All             | vios.security.manage.ldap.search  |

Table 47. Authorizations corresponding to Virtual I/O Server commands (continued)

| Command              | Command options | Authorization                                                                                                                                                                                 |
|----------------------|-----------------|-----------------------------------------------------------------------------------------------------------------------------------------------------------------------------------------------|
| <b>ldfware</b>       | All             | vios.system.firmware.load                                                                                                                                                                     |
| <b>license</b>       | <b>-accept</b>  | vios.system.license                                                                                                                                                                           |
|                      | Others          | vios.system.license.view                                                                                                                                                                      |
| <b>loadopt</b>       | All             | vios.device.manage.optical.load                                                                                                                                                               |
| <b>loginmsg</b>      | All             | vios.security.user.login.msg                                                                                                                                                                  |
| <b>lsauth</b>        | All             | vios.security.auth.list                                                                                                                                                                       |
| <b>lsdev</b>         | All             | vios.device.manage.list                                                                                                                                                                       |
| <b>lsfailedlogin</b> | All             | vios.security.user.login.fail                                                                                                                                                                 |
| <b>lsfware</b>       | All             | vios.system.firmware.list                                                                                                                                                                     |
| <b>lsgcl</b>         | All             | vios.security.log.list                                                                                                                                                                        |
| <b>lslparinfo</b>    | All             | vios.system.lpar.list                                                                                                                                                                         |
| <b>lslv</b>          | All             | vios.lvm.manage.list                                                                                                                                                                          |
| <b>lsmap</b>         | All             | vios.device.manage.map.phyvirt                                                                                                                                                                |
| <b>lsnetvc</b>       | All             | vios.network.service.list                                                                                                                                                                     |
| <b>lsnports</b>      | All             | vios.device.manage.list                                                                                                                                                                       |
| <b>lspath</b>        | All             | vios.device.manage.list                                                                                                                                                                       |
| <b>lspv</b>          | All             | vios.device.manage.list                                                                                                                                                                       |
| <b>lsrep</b>         | All             | vios.device.manage.repos.list                                                                                                                                                                 |
| <b>lsrole</b>        | All             | vios.security.role.list                                                                                                                                                                       |
| <b>lssecattr</b>     | <b>-c</b>       | vios.security.cmd.list                                                                                                                                                                        |
|                      | <b>-d</b>       | vios.security.device.list                                                                                                                                                                     |
|                      | <b>-f</b>       | vios.security.file.list                                                                                                                                                                       |
|                      | <b>-p</b>       | vios.security.proc.list                                                                                                                                                                       |
| <b>lssp</b>          | All             | vios.device.manage.spool.list                                                                                                                                                                 |
| <b>lssvc</b>         | All             | vios.system.config.agent.list                                                                                                                                                                 |
| <b>lssw</b>          | All             | vios.system.software.list                                                                                                                                                                     |
| <b>lstcpip</b>       | All             | vios.network.tcpip.list                                                                                                                                                                       |
| <b>lsuser</b>        | All             | vios.security.user.list<br><b>Note:</b> Any user can run this command to view a minimal set of user attributes. However, only users with this authorization can view all the user attributes. |
| <b>lsvg</b>          | All             | vios.lvm.manage.list                                                                                                                                                                          |
| <b>lsvlog</b>        | All             | vios.device.manage.vlog.list                                                                                                                                                                  |
| <b>lsvlrepo</b>      | All             | vios.device.manage.vlrepo.list                                                                                                                                                                |
| <b>lsvopt</b>        | All             | vios.device.manage.optical.list                                                                                                                                                               |
| <b>migratepv</b>     | All             | vios.device.manage.migrate                                                                                                                                                                    |
| <b>mirrorios</b>     | All             | vios.lvm.manage.mirrorios.create                                                                                                                                                              |
| <b>mkauth</b>        | All             | vios.security.auth.create                                                                                                                                                                     |
| <b>mkbdsp</b>        | All             | vios.device.manage.backing.create                                                                                                                                                             |
| <b>mkkrb5clnt</b>    | All             | vios.security.manage.kerberos.create                                                                                                                                                          |
| <b>mkldap</b>        | All             | vios.security.manage.ldap.create                                                                                                                                                              |



Table 47. Authorizations corresponding to Virtual I/O Server commands (continued)

| Command            | Command options | Authorization                                                                                                                                                                                       |
|--------------------|-----------------|-----------------------------------------------------------------------------------------------------------------------------------------------------------------------------------------------------|
| mklv               | All             | vios.lvm.manage.create                                                                                                                                                                              |
| mklvcopy           | All             | vios.lvm.manage.mirror.create                                                                                                                                                                       |
| mkpath             | All             | vios.device.manage.path.create                                                                                                                                                                      |
| mkrep              | All             | vios.device.manage.repos.create                                                                                                                                                                     |
| mkrole             | All             | vios.security.role.create                                                                                                                                                                           |
| mksp               | All             | vios.device.manage.spool.create                                                                                                                                                                     |
| mktcpip            | All             | vios.network.tcpip.config                                                                                                                                                                           |
| mkuser             | All             | vios.security.user.create                                                                                                                                                                           |
| mkvdev             | -fbo            | vios.device.manage.create.virtualdisk                                                                                                                                                               |
|                    | -lnagg          | vios.device.manage.create.lnagg                                                                                                                                                                     |
|                    | -sea            | vios.device.manage.create.sea                                                                                                                                                                       |
|                    | -vdev           | vios.device.manage.create.virtualdisk                                                                                                                                                               |
|                    | -vlan           | vios.device.manage.create.vlan                                                                                                                                                                      |
| mkvg               | All             | vios.lvm.manage.create                                                                                                                                                                              |
| mkvlog             | All             | vios.device.manage.vlog.create                                                                                                                                                                      |
| mkvopt             | All             | vios.device.manage.optical.create                                                                                                                                                                   |
| motd               | All             | vios.security.user.msg                                                                                                                                                                              |
| mount              | All             | vios.fs.mount                                                                                                                                                                                       |
| netstat            | All             | vios.network.tcpip.list                                                                                                                                                                             |
| optimizenet        | All             | vios.network.config.tune                                                                                                                                                                            |
| oem_platform_level | All             | vios.system.level                                                                                                                                                                                   |
| oem_setup_env      | All             | vios.oemsetupenv                                                                                                                                                                                    |
| passwd             | All             | vios.security.passwd<br><b>Note:</b> A user can change the password without having this authorization. This authorization is required only if the user wants to change the password of other users. |
| pdump              | All             | vios.system.dump.platform                                                                                                                                                                           |
| ping               | All             | vios.network.ping                                                                                                                                                                                   |
| postprocesssvc     | All             | vios.system.config.agent                                                                                                                                                                            |
| prepdev            | All             | vios.device.config.prepare                                                                                                                                                                          |
| redefvg            | All             | vios.lvm.manage.reorg                                                                                                                                                                               |
| reducevg           | All             | vios.lvm.manage.change                                                                                                                                                                              |
| refreshvlan        | All             | vios.network.config.refvlan                                                                                                                                                                         |
| remote_management  | All             | vios.system.manage.remote                                                                                                                                                                           |
| replphyvol         | All             | vios.device.manage.replace                                                                                                                                                                          |
| restore            | All             | vios.fs.backup                                                                                                                                                                                      |
| restorevgstruct    | All             | vios.lvm.manage.restore                                                                                                                                                                             |
| rmauth             | All             | vios.security.auth.remove                                                                                                                                                                           |
| rmbdsp             | All             | vios.device.manage.backing.remove                                                                                                                                                                   |
| rmdev              | All             | vios.device.manage.remove                                                                                                                                                                           |
| rmlv               | All             | vios.lvm.manage.remove                                                                                                                                                                              |

Table 47. Authorizations corresponding to Virtual I/O Server commands (continued)

| Command             | Command options | Authorization                                                                                                             |
|---------------------|-----------------|---------------------------------------------------------------------------------------------------------------------------|
| <b>rmlvcopy</b>     | All             | vios.lvm.manage.mirror.remove                                                                                             |
| <b>rmpath</b>       | All             | vios.device.manage.path.remove                                                                                            |
| <b>rmrep</b>        | All             | vios.device.manage.repos.remove                                                                                           |
| <b>rmrole</b>       | All             | vios.security.role.remove                                                                                                 |
| <b>rmsecattr</b>    | <b>-c</b>       | vios.security.cmd.remove                                                                                                  |
|                     | <b>-d</b>       | vios.security.device.remove                                                                                               |
|                     | <b>-f</b>       | vios.security.file.remove                                                                                                 |
| <b>rmsp</b>         | All             | vios.device.manage.spool.remove                                                                                           |
| <b>rmtcpip</b>      | All             | vios.network.tcpip.remove                                                                                                 |
| <b>rmuser</b>       | All             | vios.security.user.remove                                                                                                 |
| <b>rmvdev</b>       | All             | vios.device.manage.remove                                                                                                 |
| <b>rmvlog</b>       | All             | vios.device.manage.vlog.remove                                                                                            |
| <b>rmvopt</b>       | All             | vios.device.manage.optical.remove                                                                                         |
| <b>rolelist</b>     | <b>-p</b>       | vios.security.proc.role.list<br><b>Note:</b> You can run other options of this command without having any authorizations. |
|                     | <b>-u</b>       | vios.security.role.list                                                                                                   |
| <b>savevgstruct</b> | All             | vios.lvm.manage.save                                                                                                      |
| <b>save_base</b>    | All             | vios.device.manage.saveinfo                                                                                               |
| <b>seastat</b>      | All             | vios.network.stat.sea                                                                                                     |
| <b>setkst</b>       | All             | vios.security.kst.set                                                                                                     |
| <b>setsecattr</b>   | <b>-c</b>       | vios.security.cmd.set                                                                                                     |
|                     | <b>-d</b>       | vios.security.device.set                                                                                                  |
|                     | <b>-f</b>       | vios.security.file.set                                                                                                    |
|                     | <b>-o</b>       | vios.security.domain.set                                                                                                  |
|                     | <b>-p</b>       | vios.security.proc.set                                                                                                    |
| <b>showmount</b>    | All             | vios.fs.mount.show                                                                                                        |
| <b>shutdown</b>     | All             | vios.system.boot.shutdown                                                                                                 |
| <b>snap</b>         | All             | vios.system.trace.format                                                                                                  |
| <b>snapshot</b>     | All             | vios.device.manage.backing.create                                                                                         |
| <b>snmp_info</b>    | All             | vios.security.manage.snmp.info                                                                                            |
| <b>snmpv3_ssw</b>   | All             | vios.security.manage.snmp.switch                                                                                          |
| <b>snmp_trap</b>    | All             | vios.security.manage.snmp.trap                                                                                            |
| <b>startnetshvc</b> | All             | vios.network.service.start                                                                                                |
| <b>startsvc</b>     | All             | vios.system.config.agent.start                                                                                            |
| <b>startsysdump</b> | All             | vios.system.dump                                                                                                          |
| <b>starttrace</b>   | All             | vios.system.trace.start                                                                                                   |
| <b>stopnetshvc</b>  | All             | vios.network.service.stop                                                                                                 |
| <b>stopsvc</b>      | All             | vios.system.config.agent.stop                                                                                             |
| <b>stoptrace</b>    | All             | vios.system.trace.stop                                                                                                    |

Table 47. Authorizations corresponding to Virtual I/O Server commands (continued)

| Command            | Command options | Authorization                                                                                                    |
|--------------------|-----------------|------------------------------------------------------------------------------------------------------------------|
| <b>svmon</b>       | All             | vios.system.stat.memory                                                                                          |
| <b>syncvg</b>      | All             | vios.lvm.manage.sync                                                                                             |
| <b>sysstat</b>     | All             | vios.system.stat.list                                                                                            |
| <b>topas</b>       | All             | vios.system.config.topas                                                                                         |
| <b>topasrec</b>    | All             | vios.system.config.topasrec                                                                                      |
| <b>tracepriv</b>   | All             | vios.security.priv.trace                                                                                         |
| <b>traceroute</b>  | All             | vios.network.route.trace                                                                                         |
| <b>uname</b>       | All             | vios.system.uname                                                                                                |
| <b>unloadopt</b>   | All             | vios.device.manage.optical.unload                                                                                |
| <b>unmirrorios</b> | All             | vios.lvm.manage.mirrorios.remove                                                                                 |
| <b>unmount</b>     | All             | vios.fs.unmount                                                                                                  |
| <b>updateios</b>   | All             | vios.install                                                                                                     |
| <b>vasistat</b>    | All             | vios.network.stat.vasi                                                                                           |
| <b>vfcmap</b>      | All             | vios.device.manage.map.virt                                                                                      |
| <b>viosbr</b>      | <b>-view</b>    | vios.system.backup.cfg.view                                                                                      |
|                    | Others          | vios.system.backup.cfg<br><b>Note:</b> To run any other options of this command, this authorization is required. |
| <b>viosecure</b>   | All             | vios.security.manage.firewall                                                                                    |
| <b>viostat</b>     | All             | vios.system.stat.io                                                                                              |
| <b>vmstat</b>      | All             | vios.system.stat.memory                                                                                          |
| <b>wkldagent</b>   | All             | vios.system.manage.workload.agent                                                                                |
| <b>wkldmgr</b>     | All             | vios.system.manage.workload.manager                                                                              |
| <b>wkldout</b>     | All             | vios.system.manage.workload.process                                                                              |

## Roles

The Virtual I/O Server retains its current roles and will have the appropriate authorizations assigned to the roles. Additional roles that closely emulate the roles in the AIX operating system can be created. The roles emulate naming conventions and descriptions, but are only applicable to the Virtual I/O Server specific requirements. Users cannot view, use, or modify any of the default roles in the AIX operating system.

The following roles are the default roles in the AIX operating system. These roles are unavailable to the Virtual I/O Server users, and are not displayed.

- AccountAdmin
- BackupRestore
- DomainAdmin
- FSAdmin
- SecPolicy
- SysBoot
- SysConfig
- isso

- sa
- so

The following roles are the default roles in the Virtual I/O Server:

- Admin
- DEUser
- PAdmin
- RunDiagnostics
- SRUser
- SYSAdm
- ViewOnly

The **mkrole** command creates a role. The *newrole* parameter must be a unique role name. You cannot use the **ALL** or **default** keywords as the role name. Every role must have a unique role ID that is used for security decisions. If you do not specify the **id** attribute when you create a role, the **mkrole** command automatically assigns a unique ID to the role.

### Naming convention:

There is no standard naming convention for roles. However, existing names of roles cannot be used for creating roles.

### Restriction:

The role parameter cannot contain spaces, tabs, or newline characters. To prevent inconsistencies, restrict role names to characters in the POSIX portable file name character set. You cannot use the keywords **ALL** or **default** as a role name. Do not use the following characters within a role-name string:

- : (colon)
- " (quotation mark)
- # (number sign)
- , (comma)
- = (equal sign)
- \ (backslash)
- / (forward slash)
- ? (question mark)
- ' (single quotation mark)
- ` (grave accent)

### Privileges

A **Privilege** is an attribute of a process through which the process can bypass specific restrictions and limitations of the system. Privileges are associated with a process and are acquired by running a privileged command. Privileges are defined as bit-masks in the operating system kernel and enforce access control over privileged operations. For example, the privilege bit **PV\_KER\_TIME** might control the kernel operation to modify the system date and time. Nearly 80 privileges are included with the operating system and provide granular control over privileged operations. You can acquire the least privilege required to perform an operation through division of privileged operations in the kernel. This feature leads to enhanced security because a process hacker can only get access to one or two privileges in the system, and not to root user privileges.

Authorizations and roles are a user-level tool to configure user access to privileged operations. Privileges are the restriction mechanism used in the operating system kernel to determine if a process has authorization to perform an action. Hence, if a user is in a role session that has an authorization to run a command, and that command is run, a set of privileges are assigned to the process. There is no direct mapping of authorizations and roles to privileges. Access to several commands can be provided through an authorization. Each of those commands can be granted a different set of privileges.

The following table lists the commands related to role-based access control (RBAC).

Table 48. RBAC commands and their descriptions

| Command           | Description                                                                                                                                            |
|-------------------|--------------------------------------------------------------------------------------------------------------------------------------------------------|
| <b>chauth</b>     | Modifies attributes of the authorization that is identified by the <i>newauth</i> parameter                                                            |
| <b>chrole</b>     | Changes attributes of the role identified by the <i>role</i> parameter                                                                                 |
| <b>lsauth</b>     | Displays attributes of user-defined and system-defined authorizations from the authorization database                                                  |
| <b>lsrole</b>     | Displays the role attributes                                                                                                                           |
| <b>lssecattr</b>  | Lists the security attributes of one or more commands, devices, or processes                                                                           |
| <b>mkauth</b>     | Creates new user-defined authorizations in the authorization database                                                                                  |
| <b>mkrole</b>     | Creates new roles                                                                                                                                      |
| <b>rmauth</b>     | Removes the user-defined authorization identified by the <i>auth</i> parameter                                                                         |
| <b>rmrole</b>     | Removes the role identified by the <i>role</i> parameter from the roles database                                                                       |
| <b>rmsecattr</b>  | Removes the security attributes for a command, a device, or a file entry that is identified by the <i>Name</i> parameter from the appropriate database |
| <b>rolelist</b>   | Provides role and authorization information to the caller about the roles assigned to them                                                             |
| <b>setkst</b>     | Reads the security databases and loads the information from the databases into the kernel security tables                                              |
| <b>setsecattr</b> | Sets the security attributes of the command, device, or process that are specified by the <i>Name</i> parameter                                        |
| <b>swrole</b>     | Creates a role session with the roles that are specified by the <i>Role</i> parameter                                                                  |
| <b>tracepriv</b>  | Records the privileges that a command attempts to use when the command is run                                                                          |

## Managing users on the Virtual I/O Server

You can create, list, change, switch, and remove users by using Virtual I/O Server or the Tivoli Identity Manager.

### About this task

When the Virtual I/O Server is installed, the only user type that is active is the prime administrator (**padmin** having the default role **PAdmin**). The prime administrator can create additional user IDs with types of system administrator, service representative, development engineer, or other users with different roles.

**Note:** You cannot create the prime administrator (**padmin**) user ID. It is automatically created, enabled, and the role **PAdmin** is assigned as the default role after the Virtual I/O Server is installed.

The following table lists the user management tasks available on the Virtual I/O Server, as well as the commands you must run to accomplish each task.

Table 49. Tasks and associated commands for working with Virtual I/O Server users

| Task                                                                               | Command                                                                                                                                                                                                  |
|------------------------------------------------------------------------------------|----------------------------------------------------------------------------------------------------------------------------------------------------------------------------------------------------------|
| Change passwords                                                                   | <b>cfgassist</b>                                                                                                                                                                                         |
| Create a system administrator user ID                                              | <b>mkuser</b> . This assigns <b>Admin</b> as the default role.                                                                                                                                           |
| Create a service representative (SR) user ID                                       | <b>mkuser</b> with the <b>-sr</b> flag. This assigns <b>SRUser</b> as the default role.                                                                                                                  |
| Create a development engineer (DE) user ID                                         | <b>mkuser</b> with the <b>-de</b> flag. This assigns <b>DEUser</b> as the default role.                                                                                                                  |
| Create users with varied access rights                                             | <b>mkuser</b> with the <b>-attr</b> flag by specifying <b>roles</b> and <b>default_roles</b> attributes. This assigns users with varied access rights, enabling them to access a varied set of commands. |
| Create an LDAP user                                                                | <b>mkuser</b> with the <b>-ldap</b> flag                                                                                                                                                                 |
| List a user's attributes<br>For example, determine whether a user is an LDAP user. | <b>lsuser</b>                                                                                                                                                                                            |
| Change a user's attributes                                                         | <b>chuser</b>                                                                                                                                                                                            |
| Switch to another user                                                             | <b>su</b>                                                                                                                                                                                                |
| Remove a user                                                                      | <b>rmuser</b>                                                                                                                                                                                            |

You can use the Tivoli Identity Manager to automate the management of Virtual I/O Server users. Tivoli Identity Manager provides a Virtual I/O Server adapter that acts as an interface between the Virtual I/O Server and the Tivoli Identity Manager Server. The adapter acts as a trusted virtual administrator on the Virtual I/O Server, performing tasks like the following:

- Creating a user ID to authorize access to the Virtual I/O Server.
- Modifying an existing user ID to access the Virtual I/O Server.
- Removing access from a user ID. This deletes the user ID from the Virtual I/O Server.
- Suspending a user account by temporarily deactivating access to the Virtual I/O Server.
- Restoring a user account by reactivating access to the Virtual I/O Server.
- Changing a user account password on the Virtual I/O Server.
- Reconciling the user information of all current users on the Virtual I/O Server.
- Reconciling the user information of a particular user account on the Virtual I/O Server by performing a lookup.

For more information, see the Tivoli Identity Manager product manuals.

---

## Troubleshooting the Virtual I/O Server

Find information about diagnosing Virtual I/O Server problems and information about how to correct those problems.

This section includes information about troubleshooting the Virtual I/O Server. For information about troubleshooting the Integrated Virtualization Manager, see *Troubleshooting the Integrated Virtualization Manager*.

### Troubleshooting the Virtual I/O Server logical partition

Find information and procedures for troubleshooting and diagnosing the Virtual I/O Server logical partition.

## Troubleshooting virtual SCSI problems

Find information and procedures for troubleshooting virtual Small Computer Serial Interface (SCSI) problems in the Virtual I/O Server.

### About this task

For problem determination and maintenance, use the **diagmenu** command provided by the Virtual I/O Server.

If you are still having problems after using the **diagmenu** command, contact your next level of support and ask for assistance.

Refer to the AIX fast-path problem-isolation documentation  in the Service provider information because, in certain cases, the diagnostic procedures described in the AIX fast-path problem-isolation documentation are not available from the **diagmenu** command menu.

## Correcting a failed Shared Ethernet Adapter configuration

You can troubleshoot errors that occur when you configure a Shared Ethernet Adapter, such as those that result in message 0514-040, by using the **lsdev**, **netstat**, and **entstat** commands.

### Before you begin

When you configure a Shared Ethernet Adapter the configuration can fail with the following error:

```
Method error (/usr/lib/methods/cfgsea):
0514-040 Error initializing a device into the kernel.
```

### About this task

To correct the problem, complete the following steps:

#### Procedure

1. Verify that the physical and virtual adapters that are being used to create the shared Ethernet adapter are available by running the following command:  

```
lsdev -type adapter
```
2. Make sure that the interface of neither the physical nor any of the virtual adapters are configured. Run the following command:  

```
netstat -state
```

**Important:** None of the interfaces of the adapters must be listed in the output. If any interface name (for example, *en0*) does is listed in the output, detach it as follows:

```
chdev -dev interface_name -attr state=detach
```

You might want to perform this step from a console connection because it is possible that detaching this interface will end your network connection to the Virtual I/O Server.

3. Verify that the virtual adapters that are used for data are trunk adapters by running the following command:  

```
entstat -all entX | grep Trunk
```

#### Note:

- The trunk adapter does not apply to the virtual adapter that is used as the control channel in a Shared Ethernet Adapter Failover configuration.
- If any of the virtual adapters that are used for data are not trunk adapters, you need to enable them to access external networks from the HMC.

4. Verify that the physical device and the virtual adapters in the Shared Ethernet Adapter are in agreement on the checksum offload setting:
  - a. Determine the checksum offload setting on physical device by running the following command:
 

```
lsdev -dev device_name -attr chksum_offload
```

where *device\_name* is the name of the physical device. For example, ent0.
  - b. If *chksum\_offload* is set to *yes*, enable checksum offload for all of the virtual adapters in the Shared Ethernet Adapter by running the following command:
 

```
chdev -dev device_name -attr chksum_offload=yes
```

Where *device\_name* is the name of a virtual adapter in the Shared Ethernet Adapter. For example, ent2.
  - c. If *chksum\_offload* is set to *no*, disable checksum offload for all of the virtual adapters in the Shared Ethernet Adapter by running the following command:
 

```
chdev -dev device_name -attr chksum_offload=no
```

where *device\_name* is the name of a virtual adapter in the Shared Ethernet Adapter.
  - d. If there is no output, the physical device does not support checksum offload and therefore does not have the attribute. To resolve the error, disable checksum offload for all of the virtual adapters in the Shared Ethernet Adapter by running the following command:
 

```
chdev -dev device_name -attr chksum_offload=no
```

where *device\_name* is the name of a virtual adapter in the Shared Ethernet Adapter.
5. If the real adapter is a Host Ethernet Adapter port, also known as, a Logical Integrated Virtual Ethernet adapter port, make sure that the Virtual I/O Server has been configured as the promiscuous logical partition for the physical port of the logical Integrated Virtual Ethernet adapter from the HMC.

## Debugging problems with Ethernet connectivity

You can determine Ethernet connectivity problems by examining Ethernet statistics produced by the **entstat** command. Then, you can debug the problems using the **starttrace** and **stoptrace** commands.

### About this task

To help debug problems with Ethernet connectivity, follow these steps:

#### Procedure

1. Verify that the source client logical partition can ping another client logical partition on the same system without going through the Virtual I/O Server. If this fails, the problem is likely in the client logical partition's virtual Ethernet setup. If the ping is successful, proceed to the next step.
2. Start a ping on the source logical partition to a destination machine so that the packets are sent through the Virtual I/O Server. This ping will most likely fail. Proceed to the next step with the ping test running.
3. On the Virtual I/O Server, type the following command:
 

```
entstat -all SEA_adapter
```

where *SEA\_adapter* is the name of your Shared Ethernet Adapter.

4. Verify that the VLAN ID to which the logical partition belongs is associated with the correct virtual adapter in the VLAN IDs section of the output. Examine the ETHERNET STATISTICS for the virtual adapter for this VLAN and verify that the packet counts under the Receive statistics column are increasing.

This verifies that the packets are being received by the Virtual I/O Server through the correct adapter. If the packets are not being received, the problem might be in the virtual adapter configuration. Verify the VLAN ID information for the adapters using the Hardware Management Console (HMC).



5. Examine the ETHERNET STATISTICS for the physical adapter for this VLAN and verify that the packet counts under the Transmit statistics column are increasing. This step verifies that the packets are being sent out of the Virtual I/O Server.
  - If this count is increasing, then the packets are going out of the physical adapter. Continue to step 6.
  - If this count is not increasing, then the packets are not going out of the physical adapter, and to further debug the problem, you must begin the system trace utility. Follow the instructions in step 9 to collect a system trace, statistical information, and the configuration description. Contact service and support if you need to debug the problem further.
6. Verify that the target system outside (on physical side of Virtual I/O Server) is receiving packets and sending out replies. If this is not happening, either the wrong physical adapter is associated with the Shared Ethernet Adapter or the Ethernet switch might not be configured correctly.
7. Examine the ETHERNET STATISTICS for the physical adapter for this VLAN and verify that the packet counts under the Receive statistics column are increasing. This step verifies that the ping replies are being received by the Virtual I/O Server. If this count is not increasing, the switch might not be configured correctly.
8. Examine the ETHERNET STATISTICS for the virtual adapter for this VLAN and verify that the packet counts under the Transmit statistics column are increasing. This step verifies that the packet is being transmitted by the Virtual I/O Server through the correct virtual adapter. If this count is not increasing, start the system trace utility. Follow the instructions in step 9 to collect a system trace, statistical information, and the configuration description. Work with service and support to debug the problem further.
9. Use the Virtual I/O Server trace utility to debug connectivity problems. Start a system trace using the **starttrace** command specifying the trace hook ID. The trace hook ID for Shared Ethernet Adapter is 48F. Use the **stoptrace** command to stop the trace. Use the **cattracerpt** command to read the trace log, format the trace entries, and write a report to standard output.

## Enabling noninteractive shells on Virtual I/O Server 1.3 or later

After upgrading the Virtual I/O Server to 1.3 or later, you can enable noninteractive shells using the **startnetsvc** command.

### Before you begin

If you installed OpenSSH on a level of the Virtual I/O Server prior to 1.3, and then upgraded to 1.3 or later, noninteractive shells might not work because the SSH configuration file needs modification.

### Procedure

To enable noninteractive shells in Virtual I/O Server 1.3 or later, run the following command from the SSH client:

```
ioscli startnetsvc ssh
```

**Note:** You can run the **startnetsvc** command when the SSH service is running. In this situation, the command appears to fail, but is successful.

## Recovering when disks cannot be located

Learn how to recover from disks not displaying when trying to boot or install a client logical partition.

### About this task

Occasionally, the disk that is needed to install the client logical partition cannot be located. In this situation, if the client is already installed, start the client logical partition. Ensure that you have the latest levels of the software and firmware. Then ensure that the **Slot number** of the virtual Small Computer

Serial Interface (SCSI) server adapter matches the **Remote partition virtual slot number** of the virtual SCSI client adapter.

## Procedure

1. Ensure that you have the latest levels of the Hardware Management Console, firmware, and Virtual I/O Server. Follow these steps:
  - a. To check whether you have the latest level of the HMC, see the Installing and configuring the Hardware Management Console. For more information about Installing and configuring the Hardware Management Console, see Installing and configuring the Hardware Management Console.
  - b. Ensure that you have the latest firmware.
2. Ensure the server virtual SCSI adapter slot number is mapped correctly to the client logical partition remote slot number:
  - a. In the navigation area, expand **Systems Management > Servers** and click the server on which the Virtual I/O Server logical partition is located.
  - b. In the contents area, select the Virtual I/O Server logical partition.
  - c. Click **Tasks** and select **Properties**.
  - d. Click the **Virtual Adapters** tab.
  - e. Click **Virtual SCSI**.
  - f. If the values of the **Remote Partition** and **Remote Adapter** are **Any Partition** and **Any Partition Slot**, then complete the following steps:
    - Expand **Virtual SCSI** and click the slot number.
    - Select **Only selected client partition can connect**.
    - Enter the client logical partition's ID and adapter and click **OK**
    - Click **Virtual SCSI**.
  - g. Record values of the **Remote Partition** and **Remote Adapter**. These values represent the client logical partition and the slot number of the client's virtual SCSI adapter that can connect to the associated server adapter. For example, the values of **Remote Partition**, **Remote Adapter**, and **Adapter** are as follows: AIX\_client, 2, 3. This means that virtual SCSI adapter 2 on the client logical partition AIX\_client can connect to the Virtual I/O Server virtual SCSI adapter 3.
  - h. Repeat steps a through g for the client logical partition.
3. Ensure the server virtual SCSI adapter slot number is mapped correctly to the client logical partition remote slot number. Follow these steps:
  - a. Right-click the server profile, and select **Properties**.
  - b. Click the Virtual I/O Server tab.
  - c. If the **Only selected remote partition and slot can connect** radio button is not selected, select it.
  - d. Note the **Remote partition** and **Remote partition virtual slot number** values. This shows the client logical partition name and the client logical partition virtual slot number. This is the client logical partition and slot number that can connect to the slot given in the **Slot number** dialog box at the top of the **Virtual SCSI Adapter Properties** window.
  - e. Repeat items a through e in this step for the client logical partition.
4. The **Adapter** value on the client logical partition must match the **Remote Adapter** on the Virtual I/O Server logical partition, and the **Adapter** value on the Virtual I/O Server logical partition must match the **Remote Adapter** on the client logical partition. If these numbers do not match, from the HMC, modify the profile properties to reflect the correct mapping.
5. From the Virtual I/O Server command line, type `cfgdev`.
6. Shut down and reactivate the client logical partition.
7. From the Virtual I/O Server command line, type `lsmmap -all`. You see results similar to the following:

| SVSA           | Physloc                                                       | Client Partition ID |
|----------------|---------------------------------------------------------------|---------------------|
| vhost0         | U9113.550.10BE8DD-V1-C3                                       | 0x00000002          |
| VTD            | vhdisk0                                                       |                     |
| LUN            | 0x8100000000000000                                            |                     |
| Backing device | hdisk5                                                        |                     |
| Physloc        | U787B.001.DNW025F-P1-C5-T1-W5005076300C10899-L536F00000000000 |                     |

In this example, the client logical partition ID is 2 (0x00000002).

**Note:** If the client logical partition is not yet installed, the Client Partition ID is 0x00000000. The slot number of the server SCSI adapter is displayed under Physloc column. The digits following the -C specify the slot number. In this case, the slot number is 3.

- From the Virtual I/O Server command line, type `lsdev -virtual`. You see results similar to the following:

| name    | status    | description                  |
|---------|-----------|------------------------------|
| vhost0  | Available | Virtual SCSI Server Adapter  |
| vhdisk0 | Available | Virtual Target Device - Disk |

## What to do next

**Note:** As an alternative to the HMC, you can use the Systems Director Management Console (SDMC) to recover from disks not displaying when trying to boot or install a client logical partition.

### Related information:

 [Recovering when disks cannot be located by using the SDMC](#)

## Troubleshooting AIX client logical partitions

Find information and procedures for troubleshooting AIX client logical partitions.

### About this task

If your client partition is using virtual I/O resources, check the Service Focal Point™ and Virtual I/O Server first to ensure that the problem is not on the server.

On client partitions running the current level of AIX, when a hardware error is logged on the server and a corresponding error is logged on the client partition, the Virtual I/O Server provides a correlation error message in the error report.

Run the following command to gather an error report:

```
errpt -a
```

Running the `errpt` command returns results similar to the following:

```
LABEL: VSCSI_ERR2
IDENTIFIER: 857033C6

Date/Time: Tue Feb 15 09:18:11 2005
Sequence Number: 50
Machine Id: 00C25EEE4C00
Node Id: vio_client53A
Class: S
Type: TEMP
Resource Name: vscsi2
```

```
Description
Underlying transport error
```

Probable Causes  
PROCESSOR

Failure Causes  
PROCESSOR

Recommended Actions  
PERFORM PROBLEM DETERMINATION PROCEDURES

Detail Data  
Error Log Type  
01  
Reserve  
00  
Error Number  
0006  
RC  
0000 0002  
VSCSI Pointer

Compare the LABEL, IDENTIFIER, and Error Number values from your error report to the values in the following table to help identify the problem and determine a resolution.

*Table 50. Labels, identifiers, error numbers, problem descriptions, and resolutions of common virtual Small Computer Serial Interface (SCSI) client logical partition problems*

| Label      | Identifier | Error Number            | Problem                                                                                                                        | Resolution                                                                                     |
|------------|------------|-------------------------|--------------------------------------------------------------------------------------------------------------------------------|------------------------------------------------------------------------------------------------|
| VSCSI_ERR2 | 857033C6   | 0006<br>RC<br>0000 0002 | The virtual SCSI server adapter on the Virtual I/O Server logical partition is not open.                                       | Make the server adapter on the Virtual I/O Server logical partition available for use.         |
|            |            | 001C<br>RC<br>0000 0000 | The virtual SCSI server adapter on the Virtual I/O Server logical partition has been closed abruptly.                          | Determine why the server adapter in the Virtual I/O Server logical partition was closed.       |
| VSCSI_ERR3 | ED995F18   | 000D<br>RC<br>FFFF FFF0 | The virtual SCSI server adapter on the Virtual I/O Server logical partition is being used by another client logical partition. | Terminate the client logical partition that is using the server adapter.                       |
|            |            | 000D<br>RC<br>FFFF FFF9 | The virtual SCSI server adapter (partition number and slot number) specified in the client adapter definition does not exist.  | On the HMC, correct the client adapter definition to associate it with a valid server adapter. |

## Reference information for the Virtual I/O Server

Find reference information about the Virtual I/O Server commands, configuration attributes for Tivoli agents and clients, networking statistics and attributes, and Virtual I/O Server user types.

## Virtual I/O Server and Integrated Virtualization Manager command descriptions

You can view a description of each Virtual I/O Server and Integrated Virtualization Manager command.

For more information about Virtual I/O Server and Integrated Virtualization Manager commands, see Virtual I/O Server and Integrated Virtualization Manager commands.

## Configuration attributes for Tivoli agents and clients

Learn about required and optional configuration attributes and variables for the Tivoli Monitoring agent, the Tivoli Usage and Accounting Manager agent, the Tivoli Storage Manager client, and the TotalStorage Productivity Center agents.

In the following tables, the term *attribute* refers to an option that you can add to a Virtual I/O Server command. The term *variable* refers to an option that you can specify in a configuration file for Tivoli Storage Manager or Tivoli Usage and Accounting Manager.

### Tivoli Monitoring

Table 51. Tivoli Monitoring configuration attributes

| Attribute         | Description                                                                                                                                                                                                                                                                                                                                                                                                                                                                                                                                                                           |
|-------------------|---------------------------------------------------------------------------------------------------------------------------------------------------------------------------------------------------------------------------------------------------------------------------------------------------------------------------------------------------------------------------------------------------------------------------------------------------------------------------------------------------------------------------------------------------------------------------------------|
| HOSTNAME          | The host name or IP address of the Tivoli Enterprise Monitoring Server (TEMS) server to which the monitoring agent sends data.                                                                                                                                                                                                                                                                                                                                                                                                                                                        |
| MANAGING_SYSTEM   | <p>The host name or IP address of the Hardware Management Console (HMC) attached to the managed system on which the Virtual I/O Server with the monitoring agent is located. You can specify only one HMC per monitoring agent.</p> <p>If you do not specify the MANAGING_SYSTEM attribute, the Virtual I/O Server uses the Resource Monitoring and Control (RMC) connection to obtain the host name or IP address of the HMC.</p> <p>If the monitoring agent is running on the Integrated Virtualization Manager, then you do not need to specify the MANAGING_SYSTEM attribute.</p> |
| RESTART_ON_REBOOT | Determines whether the monitoring agent restarts whenever the Virtual I/O Server restarts. TRUE indicates that the monitoring agent restarts whenever the Virtual I/O Server restarts. FALSE indicates that the monitoring agent does not restart whenever the Virtual I/O Server restarts.                                                                                                                                                                                                                                                                                           |

### Tivoli Storage Manager

Table 52. Tivoli Storage Manager configuration attributes

| Attribute  | Description                                                                                                                  |
|------------|------------------------------------------------------------------------------------------------------------------------------|
| SERVERNAME | The host name of the Tivoli Storage Manager server to which the Tivoli Storage Manager client is associated.                 |
| SERVERIP   | The IP address or domain name of the Tivoli Storage Manager server to which the Tivoli Storage Manager client is associated. |

Table 52. Tivoli Storage Manager configuration attributes (continued)

| Attribute | Description                                                                      |
|-----------|----------------------------------------------------------------------------------|
| NODENAME  | The name of the machine on which the Tivoli Storage Manager client is installed. |

## Tivoli Usage and Accounting Manager

Table 53. Tivoli Usage and Accounting Manager configuration variables in the A\_config.par file

| Variable        | Description                                                                                            | Possible values                                                                                                                                                                                                                                                                | Default value |
|-----------------|--------------------------------------------------------------------------------------------------------|--------------------------------------------------------------------------------------------------------------------------------------------------------------------------------------------------------------------------------------------------------------------------------|---------------|
| AACCT_TRANS_IDS | Designates the AIX advanced accounting record types included within the usage reports.                 | 1, 4, 6, 7, 8, 10, 11, or 16                                                                                                                                                                                                                                                   | 10            |
| AACCT_ONLY      | Determines whether the Usage and Accounting Manager agent collects accounting data.                    | <ul style="list-style-type: none"> <li>Y: Indicates that the Usage and Accounting Manager agent collects accounting data.</li> <li>N: Indicates that the Usage and Accounting Manager agent does not collect accounting data.</li> </ul>                                       | Y             |
| ITUAM_SAMPLE    | Determines whether the Usage and Accounting Manager agent collects data about the storage file system. | <ul style="list-style-type: none"> <li>Y: Indicates that the Usage and Accounting Manager agent collects data about the storage file system.</li> <li>N: Indicates that the Usage and Accounting Manager agent does not collect data about the storage file system.</li> </ul> | N             |

Table 54. Tivoli Usage and Accounting Manager configuration attributes

| Attribute  | Description                                                                       |
|------------|-----------------------------------------------------------------------------------|
| ACCT_DATA0 | The size, in MB, of the first data file that holds daily accounting information.  |
| ACCT_DATA1 | The size, in MB, of the second data file that holds daily accounting information. |
| ISYSTEM    | The time, in minutes, when the agent generates system interval records.           |
| IPROCESS   | The time, in minutes, when the system generates aggregate process records.        |

## TotalStorage Productivity Center attributes

Table 55. TotalStorage Productivity Center configuration attributes

| Attribute | Description                                                                                                                                                                | Required or optional |
|-----------|----------------------------------------------------------------------------------------------------------------------------------------------------------------------------|----------------------|
| S         | Host name or IP address of the TotalStorage Productivity Center Server associated with the TotalStorage Productivity Center agent.                                         | Required             |
| A         | Host name or IP address of the Agent Manager.                                                                                                                              | Required             |
| devAuth   | Password for authentication to the TotalStorage Productivity Center device server.                                                                                         | Required             |
| caPass    | Password for authentication to the command agent.                                                                                                                          | Required             |
| caPort    | Number that identifies the port for the common agent. The default is 9510.                                                                                                 | Optional             |
| amRegPort | Number that identifies the registration port for the Agent Manager. The default is 9511.                                                                                   | Optional             |
| amPubPort | Number that identifies the public port for the Agent Manager. The default is 9513.                                                                                         | Optional             |
| dataPort  | Number that identifies the port for the TotalStorage Productivity Center Data server. The default is 9549.                                                                 | Optional             |
| devPort   | Number that identifies the port of the TotalStorage Productivity Center Device server. The default is 9550.                                                                | Optional             |
| newCA     | The default is true.                                                                                                                                                       | Optional             |
| oldCA     | The default is false.                                                                                                                                                      | Optional             |
| daScan    | Runs a scan for the TPC_data agent after installation. The default is true.                                                                                                | Optional             |
| daScript  | Runs the script for the TPC_data agent after installation. The default is true.                                                                                            | Optional             |
| daIntsall | Installs the TPC_data agent. The default is true.                                                                                                                          | Optional             |
| faInstall | Installs the TPC_fabric agent. The default is true.                                                                                                                        | Optional             |
| U         | Uninstalls the TotalStorage Productivity Center agents. Possible values include: <ul style="list-style-type: none"> <li>• all</li> <li>• data</li> <li>• fabric</li> </ul> | Optional             |

### Related information:

- [IBM Tivoli Application Dependency Discovery Manager Information Center](#)
- [IBM Tivoli Identity Manager](#)
- [IBM Tivoli Monitoring version 6.2.1 documentation](#)
- [IBM Tivoli Monitoring Virtual I/O Server Premium Agent User's Guide](#)
- [IBM Tivoli Storage Manager](#)
- [IBM Tivoli Usage and Accounting Manager Information Center](#)
- [IBM TotalStorage Productivity Center Information Center](#)

## GARP VLAN Registration Protocol statistics

Learn about Bridge Protocol Data Unit (BPDU), Generic Attribute Registration Protocol (GARP), and GARP VLAN Registration Protocol (GVRP) displayed by running the **entstat -all** command. You can also view examples.

BPDU refers to all protocol packets that are exchanged between the switch and the Shared Ethernet Adapter. The only bridge protocol currently available with the Shared Ethernet Adapter is GARP. GARP is a generic protocol used to exchange attribute information between two entities. The only type of GARP currently available on the Shared Ethernet Adapter is GVRP. With GVRP, the attributes exchanged are VLAN values.

### BPDU statistics

The BPDU statistics include all BPDU packets sent or received.

Table 56. Descriptions of BPDU statistics

| BPDU statistic | Description                                                                                                                                                                                                                   |
|----------------|-------------------------------------------------------------------------------------------------------------------------------------------------------------------------------------------------------------------------------|
| Transmit       | <b>Packets</b><br>Number of packets sent.<br><br><b>Failed packets</b><br>Number of packets that could not be sent (for example, packets that could not be sent because there was no memory to allocate the outgoing packet). |



Table 56. Descriptions of BPDU statistics (continued)

| BPDU statistic | Description                                                                                                                                                                                                                                                                                                                                                                                                                                                                                                                                                                                                                                                                                           |
|----------------|-------------------------------------------------------------------------------------------------------------------------------------------------------------------------------------------------------------------------------------------------------------------------------------------------------------------------------------------------------------------------------------------------------------------------------------------------------------------------------------------------------------------------------------------------------------------------------------------------------------------------------------------------------------------------------------------------------|
| Receive        | <p><b>Packets</b><br/>Number of packets received.</p> <p><b>Unprocessed Packets</b><br/>Packets that could not be processed because the protocol was not running at the time.</p> <p><b>Non-contiguous Packets</b><br/>Packets that were received in several packet fragments.</p> <p><b>Packets with unknown PID</b><br/>Packets that had a protocol ID (PID) different than GARP. A high number is typical because the switch might be exchanging other BPDU protocol packets that the Shared Ethernet Adapter does not support.</p> <p><b>Packets with Wrong Length</b><br/>Packets whose specified length (in the Ethernet header) does not match the length of the Ethernet packet received.</p> |

## GARP statistics

The GARP statistics include those BPDU packets sent or received that are of type GARP.

Table 57. Descriptions of GARP statistics

| GARP statistic | Description                                                                                                                                                                                                                                                                                                                                                                                                                                                                                                                                                                                                                                                                                                                           |
|----------------|---------------------------------------------------------------------------------------------------------------------------------------------------------------------------------------------------------------------------------------------------------------------------------------------------------------------------------------------------------------------------------------------------------------------------------------------------------------------------------------------------------------------------------------------------------------------------------------------------------------------------------------------------------------------------------------------------------------------------------------|
| Transmit       | <p><b>Packets</b><br/>Number of packets sent.</p> <p><b>Failed packets</b><br/>Number of packets that could not be sent (for example, packets that could not be sent because there was no memory to allocate the outgoing packet).</p> <p><b>Leave All Events</b><br/>Packets sent with event type <i>Leave All</i>.</p> <p><b>Join Empty Events</b><br/>Packets sent with event type <i>Join Empty</i></p> <p><b>Join In Events</b><br/>Packets sent with event type <i>Join In</i></p> <p><b>Leave Empty Events</b><br/>Packets sent with event type <i>Leave Empty</i></p> <p><b>Leave In Events</b><br/>Packets sent with event type <i>Leave In</i></p> <p><b>Empty Events</b><br/>Packets sent with event type <i>Empty</i></p> |

Table 57. Descriptions of GARP statistics (continued)

| GARP statistic | Description                                                                                                                                                                                                                                                                                                                                                                                                                                                                                                                                                                                                                                                                                                                                                                                                                                                                                                                                                                                                   |
|----------------|---------------------------------------------------------------------------------------------------------------------------------------------------------------------------------------------------------------------------------------------------------------------------------------------------------------------------------------------------------------------------------------------------------------------------------------------------------------------------------------------------------------------------------------------------------------------------------------------------------------------------------------------------------------------------------------------------------------------------------------------------------------------------------------------------------------------------------------------------------------------------------------------------------------------------------------------------------------------------------------------------------------|
| Receive        | <p><b>Packets</b><br/>Number of packets received</p> <p><b>Unprocessed Packets</b><br/>Packets that could not be processed because the protocol was not running at the time.</p> <p><b>Packets with Unknown Attr Type:</b><br/>Packets with an unsupported attribute type. A high number is typical because the switch might be exchanging other GARP protocol packets that the Shared Ethernet Adapter does not support. For example, GARP Multicast Registration Protocol (GMRP).</p> <p><b>Leave All Events</b><br/>Packets received with event type <i>Leave All</i></p> <p><b>Join Empty Events</b><br/>Packets received with event type <i>Join Empty</i></p> <p><b>Join In Events</b><br/>Packets received with event type <i>Join In</i></p> <p><b>Leave Empty Events</b><br/>Packets received with event type <i>Leave Empty</i></p> <p><b>Leave In Events</b><br/>Packets received with event type <i>Leave In</i></p> <p><b>Empty Events</b><br/>Packets received with event type <i>Empty</i></p> |

## GVRP statistics

The GVRP statistics include those GARP packets sent or received that are exchanging VLAN information using GVRP.

Table 58. Descriptions of GVRP statistics

| GVRP statistic | Description                                                                                                                                                                                                                                                                                                                                                                                                                                                                                                                                                                                                                                                                                                                          |
|----------------|--------------------------------------------------------------------------------------------------------------------------------------------------------------------------------------------------------------------------------------------------------------------------------------------------------------------------------------------------------------------------------------------------------------------------------------------------------------------------------------------------------------------------------------------------------------------------------------------------------------------------------------------------------------------------------------------------------------------------------------|
| Transmit       | <p><b>Packets</b><br/>Number of packets sent</p> <p><b>Failed packets</b><br/>Number of packets that could not be sent (for example, packets that could not be sent because there was no memory to allocate the outgoing packet).</p> <p><b>Leave All Events</b><br/>Packets sent with event type <i>Leave All</i>.</p> <p><b>Join Empty Events</b><br/>Packets sent with event type <i>Join Empty</i></p> <p><b>Join In Events</b><br/>Packets sent with event type <i>Join In</i></p> <p><b>Leave Empty Events</b><br/>Packets sent with event type <i>Leave Empty</i></p> <p><b>Leave In Events</b><br/>Packets sent with event type <i>Leave In</i></p> <p><b>Empty Events</b><br/>Packets sent with event type <i>Empty</i></p> |

Table 58. Descriptions of GVRP statistics (continued)

| GVRP statistic | Description                                                                                                                                                                                                                                                                                                                                                                                                                                                                                                                                                                                                                                                                                                                                                                                                                                                                                                                                                                                                                                                                                                                                                                                                                                                                                                           |
|----------------|-----------------------------------------------------------------------------------------------------------------------------------------------------------------------------------------------------------------------------------------------------------------------------------------------------------------------------------------------------------------------------------------------------------------------------------------------------------------------------------------------------------------------------------------------------------------------------------------------------------------------------------------------------------------------------------------------------------------------------------------------------------------------------------------------------------------------------------------------------------------------------------------------------------------------------------------------------------------------------------------------------------------------------------------------------------------------------------------------------------------------------------------------------------------------------------------------------------------------------------------------------------------------------------------------------------------------|
| Receive        | <p><b>Packets</b><br/>Number of packets received.</p> <p><b>Unprocessed Packets</b><br/>Packets that could not be processed because the protocol was not running at the time.</p> <p><b>Packets with Invalid Length</b><br/>Packets that contains one or more attributes whose length does not correspond to its event type.</p> <p><b>Packets with Invalid Event</b><br/>Packets that contain one or more attributes whose event type is invalid.</p> <p><b>Packets with Invalid Value</b><br/>Packets that contain one or more attributes whose value is invalid (for example, an invalid VLAN ID).</p> <p><b>Total Invalid Attributes</b><br/>Sum of all of the attributes that had an invalid parameter.</p> <p><b>Total Valid Attributes</b><br/>Sum of all of the attributes that had no invalid parameters.</p> <p><b>Leave All Events</b><br/>Packets sent with event type <i>Leave All</i>.</p> <p><b>Join Empty Events</b><br/>Packets sent with event type <i>Join Empty</i></p> <p><b>Join In Events</b><br/>Packets sent with event type <i>Join In</i></p> <p><b>Leave Empty Events</b><br/>Packets sent with event type <i>Leave Empty</i></p> <p><b>Leave In Events</b><br/>Packets sent with event type <i>Leave In</i></p> <p><b>Empty Events</b><br/>Packets sent with event type <i>Empty</i></p> |

## Example statistics

Running the `entstat -a11` command returns results similar to the following:

```

Statistics for adapters in the Shared Ethernet Adapter ent3

Number of adapters: 2
SEA Flags: 00000009
 < THREAD >
 < GVRP >
VLAN IDs :
ent2: 1
Real Side Statistics:
Packets received: 0
Packets bridged: 0

```

Packets consumed: 0  
Packets transmitted: 0  
Packets dropped: 0  
Virtual Side Statistics:  
Packets received: 0  
Packets bridged: 0  
Packets consumed: 0  
Packets transmitted: 0  
Packets dropped: 0  
Other Statistics:  
Output packets generated: 0  
Output packets dropped: 0  
Device output failures: 0  
Memory allocation failures: 0  
ICMP error packets sent: 0  
Non IP packets larger than MTU: 0  
Thread queue overflow packets: 0

-----  
Bridge Protocol Data Units (BPDU) Statistics:

Transmit Statistics:

-----  
Packets: 2  
Failed packets: 0

Receive Statistics:

-----  
Packets: 1370  
Unprocessed Packets: 0  
Non-contiguous Packets: 0  
Packets w/ Unknown PID: 1370  
Packets w/ Wrong Length: 0

-----  
General Attribute Registration Protocol (GARP) Statistics:

Transmit Statistic:

-----  
Packets: 2  
Failed packets: 0

Receive Statistics:

-----  
Packets: 0  
Unprocessed Packets: 0  
Packets w/ Unknow Attr. Type: 0

Leave All Events: 0  
Join Empty Events: 0  
Join In Events: 2  
Leave Empty Events: 0  
Leave In Events: 0  
Empty Events: 0

Leave All Events: 0  
Join Empty Events: 0  
Join In Events: 0  
Leave Empty Events: 0  
Leave In Events: 0  
Empty Events: 0

-----  
GARP VLAN Registration Protocol (GVRP) Statistics:

Transmit Statistics:

-----  
Packets: 2  
Failed packets: 0

Receive Statistics:

-----  
Packets: 0  
Unprocessed Packets: 0  
Attributes w/ Invalid Length: 0  
Attributes w/ Invalid Event: 0  
Attributes w/ Invalid Value: 0  
Total Invalid Attributes: 0  
Total Valid Attributes: 0

Leave All Events: 0  
Join Empty Events: 0  
Join In Events: 2  
Leave Empty Events: 0  
Leave In Events: 0  
Empty Events: 0

Leave All Events: 0  
Join Empty Events: 0  
Join In Events: 0  
Leave Empty Events: 0  
Leave In Events: 0  
Empty Events: 0

## Network attributes

Find instructions for managing network attributes.

You can use several of the Virtual I/O Server commands, including **chdev**, **mkvdev**, and **cfglnagg**, to change device or network attributes. This section defines attributes that can be modified.

### Ethernet attributes

You can modify the following Ethernet attributes.

| Attribute                                       | Description                                                                                                                                                                                                                                                                                                                                                                                                                                                                                                                                                                                                                                                                                                                                                                                                                                   |
|-------------------------------------------------|-----------------------------------------------------------------------------------------------------------------------------------------------------------------------------------------------------------------------------------------------------------------------------------------------------------------------------------------------------------------------------------------------------------------------------------------------------------------------------------------------------------------------------------------------------------------------------------------------------------------------------------------------------------------------------------------------------------------------------------------------------------------------------------------------------------------------------------------------|
| <b>Maximum Transmission Unit</b> ( <i>mtu</i> ) | Specifies maximum transmission unit (MTU). This value can be any number from 60 through 65535, but it is media dependent.                                                                                                                                                                                                                                                                                                                                                                                                                                                                                                                                                                                                                                                                                                                     |
| <b>Interface State</b> ( <i>state</i> )         | <p><b>detach</b> Removes an interface from the network interface list. If the last interface is detached, the network interface driver code is unloaded. To change the interface route of an attached interface, that interface must be detached and added again with the <b>chdev -dev Interface -attr state=detach</b> command.</p> <p><b>down</b> Marks an interface as inactive, which keeps the system from trying to transmit messages through that interface. Routes that use the interface, however, are not automatically disabled. (<b>chdev -dev Interface -attr state=down</b>)</p> <p><b>up</b> Marks an interface as active. This parameter is used automatically when setting the first address for an interface. It can also be used to enable an interface after the <b>chdev -dev Interface -attr state=up</b> command.</p> |
| <b>Network Mask</b> ( <i>netmask</i> )          | <p>Specifies how much of the address to reserve for subdividing networks into subnetworks.</p> <p>The <i>mask</i> includes both the network part of the local address and the subnet part, which is taken from the host field of the address. The mask can be specified as a single hexadecimal number beginning with 0x, in standard Internet dotted-decimal notation.</p> <p>In the 32-bit address, the mask contains bits with a value of 1 for the bit positions reserved for the network and subnet parts, and a bit with the value of 0 for the bit positions that specify the host. The mask contains the standard network portion, and the subnet segment is contiguous with the network segment.</p>                                                                                                                                 |

### Shared Ethernet Adapter attributes

You can modify the following Shared Ethernet Adapter attributes.

| Attribute                                       | Description                                                                 |
|-------------------------------------------------|-----------------------------------------------------------------------------|
| <b>PVID</b> ( <i>pvid</i> )                     | Specifies the PVID to use for the Shared Ethernet Adapter.                  |
| <b>PVID adapter</b> ( <i>pvid_adapter</i> )     | Specifies the default virtual adapter to use for non-VLAN tagged packets.   |
| <b>Physical adapter</b> ( <i>real_adapter</i> ) | Specifies the physical adapter associated with the Shared Ethernet Adapter. |

| Attribute                                                     | Description                                                                                                                                                                                                                                                                                                                                                                                                                                                                                                                                                                                                                                                                                                                                                                                                                                                                                                                                                                                                                                                                                                                                                                                                                                                                                                                                                                                                                                                                                                                                                                                           |
|---------------------------------------------------------------|-------------------------------------------------------------------------------------------------------------------------------------------------------------------------------------------------------------------------------------------------------------------------------------------------------------------------------------------------------------------------------------------------------------------------------------------------------------------------------------------------------------------------------------------------------------------------------------------------------------------------------------------------------------------------------------------------------------------------------------------------------------------------------------------------------------------------------------------------------------------------------------------------------------------------------------------------------------------------------------------------------------------------------------------------------------------------------------------------------------------------------------------------------------------------------------------------------------------------------------------------------------------------------------------------------------------------------------------------------------------------------------------------------------------------------------------------------------------------------------------------------------------------------------------------------------------------------------------------------|
| <b>Thread</b> ( <i>thread</i> )                               | <p>Activates or deactivates threading on the Shared Ethernet Adapter. Activating this option adds approximately 16 - 20% more machine cycles per transaction for MTU 1500 streaming, and approximately 31 – 38% more machine cycles per transaction for MTU 9000. The threading option adds more machine cycles per transaction at lower workloads due to the threads being started for each packet. At higher workload rates, such as full duplex or the request/response workloads, the threads can run longer without waiting and being redispached.</p> <p>Threaded mode should be used when virtual Small Computer Serial Interface (SCSI) will be run on the same Virtual I/O Server logical partition as Shared Ethernet Adapter. Threaded mode helps ensure that virtual SCSI and the Shared Ethernet Adapter can share the processor resource appropriately. However, threading adds more instruction path length, which uses additional processor cycles. If the Virtual I/O Server logical partition will be dedicated to running shared Ethernet devices (and associated virtual Ethernet devices) only, the adapters should be configured with threading disabled.</p> <p>You can enable or disable threading using the <b>-attr thread</b> option of the <b>mkvdev</b> command. To enable threading, use the <b>-attr thread=1</b> option. To disable threading, use the <b>-attr thread=0</b> option. For example, the following command disables threading for Shared Ethernet Adapter ent1:</p> <pre>mkvdev -sea ent1 -vadapter ent5 -default ent5 -defaultid 1 -attr thread=0</pre> |
| <b>Virtual adapters</b><br>( <i>virt_adapter</i> )            | <p>Lists the virtual Ethernet adapters associated with the Shared Ethernet Adapter.</p>                                                                                                                                                                                                                                                                                                                                                                                                                                                                                                                                                                                                                                                                                                                                                                                                                                                                                                                                                                                                                                                                                                                                                                                                                                                                                                                                                                                                                                                                                                               |
| <b>TCP segmentation offload</b><br>( <i>largesend</i> )       | <p>Enables TCP largesend capability (also known as segmentation offload) from logical partitions to the physical adapter. The physical adapter must be enabled for TCP largesend for the segmentation offload from the logical partition to the Shared Ethernet Adapter to work. Also, the logical partition must be capable of performing a largesend operation. On AIX, largesend can be enabled on a logical partition using the <b>ifconfig</b> command.</p> <p>You can enable or disable TCP largesend using the <b>-a largesend</b> option of the <b>chdev</b> command. To enable it, use the <b>'-a largesend=1'</b> option. To disable it, use the <b>'-a largesend=0'</b> option.</p> <p>For example, the following command enables <i>largesend</i> for Shared Ethernet Adapter ent1:</p> <pre>chdev -l ent1 -a largesend=1</pre> <p>By default the setting is disabled (largesend=0).</p>                                                                                                                                                                                                                                                                                                                                                                                                                                                                                                                                                                                                                                                                                                  |
| <b>Jumbo frames</b><br>( <i>jumbo_frames</i> )                | <p>Allows the interface configured over the Shared Ethernet Adapter to increase its MTU to 9000 bytes (the default is 1500). If the underlying physical adapter does not support jumbo frames and the <i>jumbo_frames</i> attribute is set to yes, then configuration fails. The underlying physical adapter must support jumbo frames. The Shared Ethernet Adapter automatically enables jumbo frames on its underlying physical adapter if <i>jumbo_frames</i> is set to yes. You cannot change the value of <i>jumbo_frames</i> at run time.</p>                                                                                                                                                                                                                                                                                                                                                                                                                                                                                                                                                                                                                                                                                                                                                                                                                                                                                                                                                                                                                                                   |
| <b>GARP VLAN Registration Protocol (GVRP)</b> ( <i>gvrp</i> ) | <p>Enables and disables GVRP on a Shared Ethernet Adapter.</p>                                                                                                                                                                                                                                                                                                                                                                                                                                                                                                                                                                                                                                                                                                                                                                                                                                                                                                                                                                                                                                                                                                                                                                                                                                                                                                                                                                                                                                                                                                                                        |

## Shared Ethernet Adapter failover attributes

You can modify the following Shared Ethernet Adapter failover attributes.

| Attribute                                             | Description                                                                                                                                                                                                                                                                                                                                                                                                                                                                                                                                                                               |
|-------------------------------------------------------|-------------------------------------------------------------------------------------------------------------------------------------------------------------------------------------------------------------------------------------------------------------------------------------------------------------------------------------------------------------------------------------------------------------------------------------------------------------------------------------------------------------------------------------------------------------------------------------------|
| <b>High availability mode</b><br>( <i>ha_mode</i> )   | Determines whether the devices participate in a failover setup. The default is disabled. Typically, a Shared Ethernet Adapter in a failover setup is operating in auto mode, and the primary adapter is decided based on which adapter has the highest priority (lowest numerical value). A shared Ethernet device can be forced into the standby mode, where it will behave as the backup device as long as it can detect the presence of a functional primary.                                                                                                                          |
| <b>Control Channel</b> ( <i>ctl_chan</i> )            | Sets the virtual Ethernet device that is required for a Shared Ethernet Adapter in a failover setup so that it can communicate with the other adapter. There is no default value for this attribute, and it is required when the <i>ha_mode</i> is not set to disabled.                                                                                                                                                                                                                                                                                                                   |
| <b>Internet address to ping</b><br>( <i>netaddr</i> ) | Optional attribute that can be specified for a Shared Ethernet Adapter that has been configured in a failover setup. When this attribute is specified, a shared Ethernet device will periodically ping the IP address to verify connectivity (in addition to checking for link status of the physical devices). If it detects a loss of connectivity to the specified ping host, it will initiate a failover to the backup Shared Ethernet Adapter. This attribute is not supported when you use a Shared Ethernet Adapter with a Host Ethernet Adapter (or Integrated Virtual Ethernet). |

## INET attributes

You can modify the following INET attributes.

| Attribute                            | Description                                                                                                                                                                                                                                                                                                                                                                                                                                                                                                                                                                                                                                                                                                                                                                                                                                                                                                                                                                                                                                                                                                                                                                                                                                                                                                                                                                                                                                                                                                                                                                                                                                                                                                                                                                                                             |
|--------------------------------------|-------------------------------------------------------------------------------------------------------------------------------------------------------------------------------------------------------------------------------------------------------------------------------------------------------------------------------------------------------------------------------------------------------------------------------------------------------------------------------------------------------------------------------------------------------------------------------------------------------------------------------------------------------------------------------------------------------------------------------------------------------------------------------------------------------------------------------------------------------------------------------------------------------------------------------------------------------------------------------------------------------------------------------------------------------------------------------------------------------------------------------------------------------------------------------------------------------------------------------------------------------------------------------------------------------------------------------------------------------------------------------------------------------------------------------------------------------------------------------------------------------------------------------------------------------------------------------------------------------------------------------------------------------------------------------------------------------------------------------------------------------------------------------------------------------------------------|
| <b>Host Name</b> ( <i>hostname</i> ) | <p>Specify the host name that you want to assign to the current machine.</p> <p>When specifying the host name, use ASCII characters, preferably alphanumeric only. Do not use a period in the host name. Avoid using hexadecimal or decimal values as the first character (for example 3Comm, where 3C might be interpreted as a hexadecimal character). For compatibility with earlier hosts, use an unqualified host name of fewer than 32 characters.</p> <p>If the host uses a domain name server for name resolution, the host name must contain the full domain name.</p> <p>In the hierarchical domain naming system, names consist of a sequence of subnames that are not case-sensitive and that are separated by periods with no embedded blanks. The DOMAIN protocol specifies that a local domain name must be fewer than 64 characters, and that a host name must be fewer than 32 characters in length. The host name is given first. Optionally, the full domain name can be specified; the host name is followed by a period, a series of local domain names separated by periods, and finally by the root domain. A fully specified domain name for a host, including periods, must be fewer than 255 characters in length and in the following form:<br/>host.subdomain.subdomain.rootdomain</p> <p>In a hierarchical network, certain hosts are designated as name servers that resolve names into Internet addresses for other hosts. This arrangement has two advantages over the flat name space: resources of each host on the network are not consumed in resolving names, and the person who manages the system does not need to maintain name-resolution files on each machine on the network. The set of names managed by a single name server is known as its <i>zone of authority</i>.</p> |
| <b>Gateway</b> ( <i>gateway</i> )    | Identifies the gateway to which packets are addressed. The <i>Gateway</i> parameter can be specified either by symbolic name or numeric address.                                                                                                                                                                                                                                                                                                                                                                                                                                                                                                                                                                                                                                                                                                                                                                                                                                                                                                                                                                                                                                                                                                                                                                                                                                                                                                                                                                                                                                                                                                                                                                                                                                                                        |



| Attribute                     | Description                                                                                                                                                                                                                                                                                                                                                                                                                                                                                                                                                                                                                                                                                                                                                                                             |
|-------------------------------|---------------------------------------------------------------------------------------------------------------------------------------------------------------------------------------------------------------------------------------------------------------------------------------------------------------------------------------------------------------------------------------------------------------------------------------------------------------------------------------------------------------------------------------------------------------------------------------------------------------------------------------------------------------------------------------------------------------------------------------------------------------------------------------------------------|
| <b>Route</b> ( <i>route</i> ) | <p>Specifies the route. The format of the <i>Route</i> attribute is: <i>route=destination, gateway, [metric]</i>.</p> <p><b>destination</b><br/>Identifies the host or network to which you are directing the route. The <i>Destination</i> parameter can be specified either by symbolic name or numeric address.</p> <p><b>gateway</b><br/>Identifies the gateway to which packets are addressed. The <i>Gateway</i> parameter can be specified either by symbolic name or numeric address.</p> <p><b>metric</b><br/>Sets the routing metric. The default is 0 (zero). The routing metric is used by the routing protocol (the <i>routed</i> daemon). Higher metrics have the effect of making a route less favorable. Metrics are counted as additional hops to the destination network or host.</p> |

## Adapter attributes

You can modify the following adapter attributes. The attribute behavior can vary, based on the adapter and driver you have.

| Attribute                                 | Adapters/Drivers                                                                                                                                            | Description                                                                                                                                                                                                                                                                                                                                                                                                                                                                                                                                                                                                                                                                                                        |
|-------------------------------------------|-------------------------------------------------------------------------------------------------------------------------------------------------------------|--------------------------------------------------------------------------------------------------------------------------------------------------------------------------------------------------------------------------------------------------------------------------------------------------------------------------------------------------------------------------------------------------------------------------------------------------------------------------------------------------------------------------------------------------------------------------------------------------------------------------------------------------------------------------------------------------------------------|
| <b>Media Speed</b> ( <i>media_speed</i> ) | <ul style="list-style-type: none"> <li>2-Port 10/100/1000 Base-TX PCI-X Adapter</li> <li>10/100/1000 Base-T Ethernet PCI-X Adapter Device Driver</li> </ul> | <p>The media speed attribute indicates the speed at which the adapter attempts to operate. The available speeds are 10 Mbps half-duplex, 10 Mbps full-duplex, 100 Mbps half-duplex, 100 Mbps full-duplex and autonegotiation, with a default of autonegotiation. Select auto-negotiate when the adapter should use autonegotiation across the network to determine the speed. When the network will not support autonegotiation, select the specific speed.</p> <p>1000 MBps half and full duplex are not valid values. According to the IEEE 802.3z specification, gigabit speeds of any duplexity must be autonegotiated for copper (TX)-based adapters. If these speeds are desired, select auto-negotiate.</p> |
| <b>Media Speed</b> ( <i>media_speed</i> ) | <ul style="list-style-type: none"> <li>2-Port Gigabit Ethernet-SX PCI-X Adapter</li> <li>Gigabit Ethernet-SX PCI-X Adapter Device Driver</li> </ul>         | <p>The media speed attribute indicates the speed at which the adapter attempts to operate. The available speeds are 1000 Mbps full-duplex and autonegotiation. The default is autonegotiation. Select auto-negotiate when the adapter should use autonegotiation across the network to determine the duplexity. When the network does not support autonegotiation, select 1000 Mbps full-duplex.</p>                                                                                                                                                                                                                                                                                                               |

| Attribute                                                        | Adapters/Drivers                                                                                                                                 | Description                                                                                                                                                                                                                                                                                                                                                                                                                                                                                                                                                                                                                                                            |
|------------------------------------------------------------------|--------------------------------------------------------------------------------------------------------------------------------------------------|------------------------------------------------------------------------------------------------------------------------------------------------------------------------------------------------------------------------------------------------------------------------------------------------------------------------------------------------------------------------------------------------------------------------------------------------------------------------------------------------------------------------------------------------------------------------------------------------------------------------------------------------------------------------|
| <b>Media Speed</b> ( <i>media_speed</i> )                        | <ul style="list-style-type: none"> <li>10/100 Mbps Ethernet PCI Adapter Device Driver</li> </ul>                                                 | <p>The media speed attribute indicates the speed at which the adapter attempts to operate. The available speeds are 10 Mbps half-duplex, 10 Mbps full-duplex, 100 Mbps half-duplex, 100 Mbps full-duplex and autonegotiation, with a default of autonegotiation. When the adapter should use autonegotiation across the network to determine the speed, select autonegotiate. When the network will not support autonegotiation, select the specific speed.</p> <p>If autonegotiation is selected, the remote link device must also be set to autonegotiate to ensure the link works correctly.</p>                                                                    |
| <b>Media Speed</b> ( <i>media_speed</i> )                        | <ul style="list-style-type: none"> <li>10/100/1000 Base-T Ethernet PCI adapter</li> <li>Gigabit Ethernet-SX PCI Adapter Device Driver</li> </ul> | <p>The media speed attribute indicates the speed at which the adapter attempts to operate. The available speeds are 10 Mbps half-duplex, 10 Mbps full-duplex, 100 Mbps half-duplex, 100 Mbps full-duplex and autonegotiation, with a default of autonegotiation. Select autonegotiate when the adapter should use autonegotiation across the network to determine the speed. When the network will not support autonegotiation, select the specific speed.</p> <p>For the adapter to run at 1000 Mbit/s, the autonegotiation setting must be selected.<br/> <b>Note:</b> For the Gigabit Ethernet-SX PCI Adapter, the only selection available is autonegotiation.</p> |
| <b>Enable Alternate Ethernet Address</b> ( <i>use_alt_addr</i> ) |                                                                                                                                                  | <p>Setting this attribute to yes indicates that the address of the adapter, as it appears on the network, is the one specified by the Alternate Ethernet Address attribute. If you specify the no value, the unique adapter address written in a ROM on the adapter card is used. The default value is no.</p>                                                                                                                                                                                                                                                                                                                                                         |
| <b>Alternate Ethernet Address</b> ( <i>alt_addr</i> )            |                                                                                                                                                  | <p>Allows the adapter unique address, as it appears on the LAN network, to be changed. The value entered must be an Ethernet address of 12 hexadecimal digits and must not be the same as the address of any other Ethernet adapter. There is no default value. This field has no effect unless the Enable Alternate Ethernet Address attribute is set to yes value, in which case this field must be filled in. A typical Ethernet address is 0x02608C000001. All 12 hexadecimal digits, including leading zeros, must be entered.</p>                                                                                                                                |
| <b>Enable Link Polling</b> ( <i>poll_link</i> )                  | <ul style="list-style-type: none"> <li>10/100Mbps Ethernet PCI Adapter Device Driver</li> </ul>                                                  | <p>Select no to cause the device driver to poll the adapter to determine the status of the link at a specified time interval. The time interval value is specified in the <b>Poll Link Time Interval</b> field. If you select no, the device driver will not poll the adapter for its link status. The default value is no.</p>                                                                                                                                                                                                                                                                                                                                        |

| Attribute                                                 | Adapters/Drivers                                                                                                                                                                                                                                                                                                                        | Description                                                                                                                                                                                                                                                                                                                |
|-----------------------------------------------------------|-----------------------------------------------------------------------------------------------------------------------------------------------------------------------------------------------------------------------------------------------------------------------------------------------------------------------------------------|----------------------------------------------------------------------------------------------------------------------------------------------------------------------------------------------------------------------------------------------------------------------------------------------------------------------------|
| <b>Poll Link Time Interval</b><br><i>(poll_link_time)</i> | <ul style="list-style-type: none"> <li>• 10/100Mbps Ethernet PCI Adapter Device Driver</li> </ul>                                                                                                                                                                                                                                       | <p>The amount of time, in milliseconds, between polls to the adapter for its link status that the device driver is allowed. This value is required when the <b>Enable Link Polling</b> option is set to yes. A value between 100 through 1000 can be specified. The incremental value is 10. The default value is 500.</p> |
| <b>Flow Control</b> <i>(flow_ctrl)</i>                    | <ul style="list-style-type: none"> <li>• 10/100/1000 Base-T Ethernet PCI-X Adapter Device Driver</li> <li>• Gigabit Ethernet-SX PCI-X Adapter Device Driver</li> <li>• 2-Port 10/100/1000 Base-TX PCI-X Adapter</li> <li>• 2-Port Gigabit Ethernet-SX PCI-X Adapter</li> <li>• Gigabit Ethernet-SX PCI Adapter Device Driver</li> </ul> | <p>This attribute specifies whether the adapter should enable transmit and receive flow control. The default value is no.</p>                                                                                                                                                                                              |
| <b>Transmit Jumbo Frames</b><br><i>(jumbo_frames)</i>     | <ul style="list-style-type: none"> <li>• 10/100/1000 Base-T Ethernet PCI-X Adapter Device Driver</li> <li>• Gigabit Ethernet-SX PCI-X Adapter Device Driver</li> <li>• 2-Port 10/100/1000 Base-TX PCI-X Adapter</li> <li>• 2-Port Gigabit Ethernet-SX PCI-X Adapter</li> <li>• Gigabit Ethernet-SX PCI Adapter Device Driver</li> </ul> | <p>Setting this attribute to yes indicates that frames up to 9018 bytes in length might be transmitted on this adapter. If you specify no, the maximum size of frames transmitted is 1518 bytes. Frames up to 9018 bytes in length can always be received on this adapter.</p>                                             |

| Attribute                                                                 | Adapters/Drivers                                                                                                                                                                                                                                                                                                                                                             | Description                                                                                                                                                                                                                                                                                                                                                                                                                                                                                                                                                                                                                                                                                                                                                                                                                                                                                                                                                                                                                                                                                                                                                                                                                                                                                                                                                                                                                                                                                                                                                                                                                                                                                                                                         |
|---------------------------------------------------------------------------|------------------------------------------------------------------------------------------------------------------------------------------------------------------------------------------------------------------------------------------------------------------------------------------------------------------------------------------------------------------------------|-----------------------------------------------------------------------------------------------------------------------------------------------------------------------------------------------------------------------------------------------------------------------------------------------------------------------------------------------------------------------------------------------------------------------------------------------------------------------------------------------------------------------------------------------------------------------------------------------------------------------------------------------------------------------------------------------------------------------------------------------------------------------------------------------------------------------------------------------------------------------------------------------------------------------------------------------------------------------------------------------------------------------------------------------------------------------------------------------------------------------------------------------------------------------------------------------------------------------------------------------------------------------------------------------------------------------------------------------------------------------------------------------------------------------------------------------------------------------------------------------------------------------------------------------------------------------------------------------------------------------------------------------------------------------------------------------------------------------------------------------------|
| <b>Checksum Offload</b><br><i>(chksum_offload)</i>                        | <ul style="list-style-type: none"> <li>• 10/100/1000 Base-T Ethernet PCI-X Adapter Device Driver</li> <li>• Gigabit Ethernet-SX PCI-X Adapter Device Driver</li> <li>• 2-Port 10/100/1000 Base-TX PCI-X Adapter</li> <li>• 2-Port Gigabit Ethernet-SX PCI-X Adapter</li> <li>• Gigabit Ethernet-SX PCI Adapter Device Driver</li> <li>• Virtual Ethernet adapters</li> </ul> | <p>Setting this attribute to yes indicates that the adapter calculates the checksum for transmitted and received TCP frames. If you specify no, the checksum will be calculated by the appropriate software.</p> <p>When a virtual Ethernet adapter has checksum offload enabled, the adapter advertises it to the hypervisor. The hypervisor tracks which virtual Ethernet adapters have checksum offload enabled and manages inter-partition communication accordingly.</p> <p>When network packets are routed through the Shared Ethernet Adapter, there is a potential for link errors. In this environment, the packets must traverse the physical link with a checksum. Communication works in the following way:</p> <ul style="list-style-type: none"> <li>• When a packet is received from the physical link, the physical adapter verifies the checksum. If the packet's destination is a virtual Ethernet adapter with checksum offload enabled, the receiver does not have to perform checksum verification. A receiver that does not have checksum offload enabled will accept the packet after checksum verification.</li> <li>• When a packet originates from a virtual Ethernet adapter with checksum offload enabled, it travels to the physical adapter without a checksum. The physical adapter will generate a checksum before sending the packet out. Packets originating from a virtual Ethernet adapter with checksum offload disabled generate the checksum at the source.</li> </ul> <p>To enable checksum offload for a Shared Ethernet Adapter, all constituent devices must have it enabled as well. The shared Ethernet device will fail if the underlying devices do not have the same checksum offload settings.</p> |
| <b>Enable Hardware Transmit TCP Resegmentation</b><br><i>(large_send)</i> | <ul style="list-style-type: none"> <li>• 10/100/1000 Base-T Ethernet PCI-X Adapter Device Driver</li> <li>• Gigabit Ethernet-SX PCI-X Adapter Device Driver</li> <li>• 2-Port 10/100/1000 Base-TX PCI-X Adapter</li> <li>• 2-Port Gigabit Ethernet-SX PCI-X Adapter</li> <li>• Gigabit Ethernet-SX PCI Adapter Device Driver</li> </ul>                                      | <p>This attribute specifies whether the adapter is to perform transmit TCP resegmentation for TCP segments. The default value is no.</p>                                                                                                                                                                                                                                                                                                                                                                                                                                                                                                                                                                                                                                                                                                                                                                                                                                                                                                                                                                                                                                                                                                                                                                                                                                                                                                                                                                                                                                                                                                                                                                                                            |

## Link Aggregation (EtherChannel) device attributes

You can modify the following Link Aggregation, or EtherChannel, attributes.

| Attribute                                                    | Description                                                                                                                                                                                                                                                                                                                                                                                                                                                                                                                                                                                                                                                                                                                                                                                                                                                                                                                                                                                                                                                                                                                                                                                                            |
|--------------------------------------------------------------|------------------------------------------------------------------------------------------------------------------------------------------------------------------------------------------------------------------------------------------------------------------------------------------------------------------------------------------------------------------------------------------------------------------------------------------------------------------------------------------------------------------------------------------------------------------------------------------------------------------------------------------------------------------------------------------------------------------------------------------------------------------------------------------------------------------------------------------------------------------------------------------------------------------------------------------------------------------------------------------------------------------------------------------------------------------------------------------------------------------------------------------------------------------------------------------------------------------------|
| <b>Link Aggregation adapters</b><br>( <i>adapter_names</i> ) | The adapters that currently make up the Link Aggregation device. If you want to modify these adapters, modify this attribute and select all the adapters that should belong to the Link Aggregation device. When you use this attribute to select all of the adapters that should belong to the Link Aggregation device, its interface must not have an IP address configured.                                                                                                                                                                                                                                                                                                                                                                                                                                                                                                                                                                                                                                                                                                                                                                                                                                         |
| <b>Mode</b> ( <i>mode</i> )                                  | <p>The type of channel that is configured. In standard mode, the channel sends the packets to the adapter based on an algorithm (the value used for this calculation is determined by the Hash Mode attribute). In round_robin mode, the channel gives one packet to each adapter before repeating the loop. The default mode is standard.</p> <p>Using the 802.3ad mode, the Link Aggregation Control Protocol (LACP) negotiates the adapters in the Link Aggregation device with an LACP-enabled switch.</p> <p>If the Hash Mode attribute is set to anything other than the default, this attribute must be set to standard or 802.3ad. Otherwise, the configuration of the Link Aggregation device will fail.</p>                                                                                                                                                                                                                                                                                                                                                                                                                                                                                                  |
| <b>Hash Mode</b> ( <i>hash_mode</i> )                        | <p>If operating under standard or IEEE 802.3ad mode, the hash mode attribute determines how the outgoing adapter for each packet is chosen. Following are the different modes:</p> <ul style="list-style-type: none"> <li>• default: uses the destination IP address to determine the outgoing adapter.</li> <li>• src_port: uses the source TCP or UDP port for that connection.</li> <li>• dst_port: uses the destination TCP or UDP port for that connection.</li> <li>• src_dst_port: uses both the source and destination TCP or UDP ports for that connection to determine the outgoing adapter.</li> </ul> <p>You cannot use round-robin mode with any hash mode value other than default. The Link Aggregation device configuration will fail if you attempt this combination.</p> <p>If the packet is not TCP or UDP, it uses the default hashing mode (destination IP address).</p> <p>Using TCP or UDP ports for hashing can make better use of the adapters in the Link Aggregation device, because connections to the same destination IP address can be sent over different adapters (while still retaining the order of the packets), thus increasing the bandwidth of the Link Aggregation device.</p> |
| <b>Internet Address to Ping</b><br>( <i>netaddr</i> )        | This field is optional. The IP address that the Link Aggregation device should ping to verify that the network is up. This is only valid when there is a backup adapter and when there are one or more adapters in the Link Aggregation device. An address of zero (or all zeros) is ignored and disables the sending of ping packets if a valid address was previously defined. The default is to leave this field blank.                                                                                                                                                                                                                                                                                                                                                                                                                                                                                                                                                                                                                                                                                                                                                                                             |
| <b>Retry Timeout</b> ( <i>retry_time</i> )                   | This field is optional. It controls how often the Link Aggregation device sends out a ping packet to poll the current adapter for link status. This is valid only when the Link Aggregation device has one or more adapters, a backup adapter is defined, and the <b>Internet Address to Ping</b> field contains a non-zero address. Specify the timeout value in seconds. The range of valid values is 1 to 100 seconds. The default value is 1 second.                                                                                                                                                                                                                                                                                                                                                                                                                                                                                                                                                                                                                                                                                                                                                               |
| <b>Number of Retries</b><br>( <i>num_retries</i> )           | This field is optional. It specifies the number of lost ping packets before the Link Aggregation device switches adapters. This is valid only when the Link Aggregation device has one or more adapters, a backup adapter is defined, and the <b>Internet Address to Ping</b> field contains a non-zero address. The range of valid values is 2 to 100 retries. The default value is 3.                                                                                                                                                                                                                                                                                                                                                                                                                                                                                                                                                                                                                                                                                                                                                                                                                                |

| Attribute                                                                 | Description                                                                                                                                                                                                                          |
|---------------------------------------------------------------------------|--------------------------------------------------------------------------------------------------------------------------------------------------------------------------------------------------------------------------------------|
| <b>Enable Gigabit Ethernet Jumbo Frames</b><br>( <i>use_jumbo_frame</i> ) | This field is optional. To use this attribute, all of the underlying adapters, as well as the switch, must support jumbo frames. This will work only with a Standard Ethernet (en) interface, not an IEEE 802.3 (et) interface.      |
| <b>Enable Alternate Address</b><br>( <i>use_alt_addr</i> )                | This field is optional. If you set this to yes, you can specify a MAC address that you want the Link Aggregation device to use. If you set this option to no, the Link Aggregation device uses the MAC address of the first adapter. |
| <b>Alternate Address</b><br>( <i>alt_addr</i> )                           | If <b>Enable Alternate Address</b> is set to yes, specify the MAC address that you want to use. The address you specify must start with 0x and be a 12-digit hexadecimal address.                                                    |

## VLAN attributes

You can modify the following VLAN attributes.

| Attribute                                   | Value                                                                          |
|---------------------------------------------|--------------------------------------------------------------------------------|
| <b>VLAN Tag ID</b> ( <i>vlan_tag_id</i> )   | The unique ID associated with the VLAN driver. You can specify from 1 to 4094. |
| <b>Base Adapter</b> ( <i>base_adapter</i> ) | The network adapter to which the VLAN device driver is connected.              |

## Shared Ethernet Adapter Quality of Service (QoS) attribute

You can modify the following qos\_mode attribute.

### disabled mode

This is the default mode. VLAN traffic is not inspected for the priority field. For example,

```
chdev -dev <sea device name> -attr qos_mode=disabled
```

### strict mode

More important traffic is bridged over less important traffic. This mode provides better performance and more bandwidth to more important traffic; however, it can result in substantial delays for less important traffic. For example,

```
chdev -dev <sea device name> -attr qos_mode=strict
```

### loose mode

A cap is placed on each priority level, so that after a number of bytes are sent for each priority level, the next level is serviced. This method ensures that all packets will eventually be sent. More important traffic is given less bandwidth with this mode than with strict mode; however, the caps in loose mode are such that more bytes are sent for the more important traffic, so it still gets more bandwidth than less important traffic. For example,

```
chdev -dev <sea device name> -attr qos_mode=loose
```

## Client-specific Shared Ethernet Adapter statistics

To gather network statistics at a client level, enable advanced accounting on the Shared Ethernet Adapter to provide more information about its network traffic. To enable client statistics, set the Shared Ethernet Adapter accounting attribute to enabled (the default value is disabled). When advanced accounting is enabled, the Shared Ethernet Adapter keeps track of the hardware (MAC) addresses of all of the packets it receives from the LPAR clients, and increments packet and byte counts for each client independently. After advanced accounting is enabled on the Shared Ethernet Adapter, you can generate a report to view per-client statistics by running the **seastat** command.

**Note:** Advanced accounting must be enabled on the Shared Ethernet Adapter before you can use the **seastat** command to print any statistics.

To enable advanced accounting on the Shared Ethernet Adapter, enter the following command:

```
chdev -dev <sea device name> -attr accounting=enabled
```

The following command displays per-client Shared Ethernet Adapter statistics. The optional `-n` flag disables name resolution on IP addresses.

```
seastat -d <sea device name> [-n]
```

The following command clears all of the per-client Shared Ethernet Adapter statistics that have been gathered:

```
seastat -d <sea device name> -c
```

## Shared Ethernet Adapter failover statistics

Learn about Shared Ethernet Adapter failover statistics, such as high availability information and packet types, and view examples.

### Statistic descriptions

Table 59. Descriptions of Shared Ethernet Adapter failover statistics

| Statistic         | Description                                                                                                                                                                                                                                                                                                                                                                                                                                                                                                                                                                                                                                                                                                                                                                                                                                                                                                                                                                                                                  |
|-------------------|------------------------------------------------------------------------------------------------------------------------------------------------------------------------------------------------------------------------------------------------------------------------------------------------------------------------------------------------------------------------------------------------------------------------------------------------------------------------------------------------------------------------------------------------------------------------------------------------------------------------------------------------------------------------------------------------------------------------------------------------------------------------------------------------------------------------------------------------------------------------------------------------------------------------------------------------------------------------------------------------------------------------------|
| High availability | <p><b>Control Channel PVID</b><br/>Port VLAN ID of the virtual Ethernet adapter used as the control channel.</p> <p><b>Control Packets in</b><br/>Number of packets received on the control channel.</p> <p><b>Control Packets out</b><br/>Number of packets sent on the control channel.</p>                                                                                                                                                                                                                                                                                                                                                                                                                                                                                                                                                                                                                                                                                                                                |
| Packet types      | <p><b>Keep-Alive Packets</b><br/>Number of keep-alive packets received on the control channel. Keep-alive packets are received on the backup Shared Ethernet Adapter while the primary Shared Ethernet Adapter is active.</p> <p><b>Recovery Packets</b><br/>Number of recovery packets received on the control channel. Recovery packets are sent by the primary Shared Ethernet Adapter when it recovers from a failure and is ready to be active again.</p> <p><b>Notify Packets</b><br/>Number of notify packets received on the control channel. Notify packets are sent by the backup Shared Ethernet Adapter when it detects that the primary Shared Ethernet Adapter has recovered.</p> <p><b>Limbo Packets</b><br/>Number of limbo packets received on the control channel. Limbo packets are sent by the primary Shared Ethernet Adapter when it detects that its physical network is not operational, or when it cannot ping the specified remote host (to inform the backup that it needs to become active).</p> |

Table 59. Descriptions of Shared Ethernet Adapter failover statistics (continued)

| Statistic                             | Description                                                                                                                                                                                                                                                                                                                                                                                                                                                                                                                                                                                                                                                                                                                                                                                                                                                                                                                                                                                                  |
|---------------------------------------|--------------------------------------------------------------------------------------------------------------------------------------------------------------------------------------------------------------------------------------------------------------------------------------------------------------------------------------------------------------------------------------------------------------------------------------------------------------------------------------------------------------------------------------------------------------------------------------------------------------------------------------------------------------------------------------------------------------------------------------------------------------------------------------------------------------------------------------------------------------------------------------------------------------------------------------------------------------------------------------------------------------|
| State                                 | <p>The current state of the Shared Ethernet Adapter.</p> <p><b>INIT</b> The Shared Ethernet Adapter failover protocol has just been initiated.</p> <p><b>PRIMARY</b><br/>The Shared Ethernet Adapter is actively connecting traffic between the VLANs to the network.</p> <p><b>BACKUP</b><br/>The Shared Ethernet Adapter is idle and not connecting traffic between the VLANs and the network.</p> <p><b>RECOVERY</b><br/>The primary Shared Ethernet Adapter recovered from a failure and is ready to be active again.</p> <p><b>NOTIFY</b><br/>The backup Shared Ethernet Adapter detected that the primary Shared Ethernet Adapter recovered from a failure and that it needs to become idle again.</p> <p><b>LIMBO</b><br/>One of the following situations is true:</p> <ul style="list-style-type: none"> <li>• The physical network is not operational.</li> <li>• The physical network's state is unknown.</li> <li>• The Shared Ethernet Adapter cannot ping the specified remote host.</li> </ul> |
| Bridge Mode                           | <p>Describes to what level, if any, the Shared Ethernet Adapter is currently bridging traffic.</p> <p><b>Unicast</b><br/>The Shared Ethernet Adapter is only sending and receiving unicast traffic (no multicast or broadcast traffic). To avoid broadcast storms, the Shared Ethernet Adapter sends and receives unicast traffic only while it is in the INIT or the RECOVERY states.</p> <p><b>All</b> The Shared Ethernet Adapter is sending and receiving all types of network traffic.</p> <p><b>None</b> The Shared Ethernet Adapter is not sending or receiving any network traffic.</p>                                                                                                                                                                                                                                                                                                                                                                                                              |
| Number of Times Server became Backup  | Number of times the Shared Ethernet Adapter was active and became idle because of a failure.                                                                                                                                                                                                                                                                                                                                                                                                                                                                                                                                                                                                                                                                                                                                                                                                                                                                                                                 |
| Number of Times Server became Primary | Number of times the Shared Ethernet Adapter was idle and became active because the primary Shared Ethernet Adapter failed.                                                                                                                                                                                                                                                                                                                                                                                                                                                                                                                                                                                                                                                                                                                                                                                                                                                                                   |



Table 59. Descriptions of Shared Ethernet Adapter failover statistics (continued)

| Statistic              | Description                                                                                                                                                                                                                                                                                                                                                                                                                                                                                                                                                                                                                                                                                                                                                                                                                                                                                                                                                                                                                                                                                                                |
|------------------------|----------------------------------------------------------------------------------------------------------------------------------------------------------------------------------------------------------------------------------------------------------------------------------------------------------------------------------------------------------------------------------------------------------------------------------------------------------------------------------------------------------------------------------------------------------------------------------------------------------------------------------------------------------------------------------------------------------------------------------------------------------------------------------------------------------------------------------------------------------------------------------------------------------------------------------------------------------------------------------------------------------------------------------------------------------------------------------------------------------------------------|
| High Availability Mode | <p>How the Shared Ethernet Adapter behaves regarding the Shared Ethernet Adapter failover protocol.</p> <p><b>Auto</b> The Shared Ethernet Adapter failover protocol determines whether the Shared Ethernet Adapter acts as the primary Shared Ethernet Adapter or as the backup Shared Ethernet Adapter.</p> <p><b>Standby</b> The Shared Ethernet Adapter operates as a backup if there is another Shared Ethernet Adapter available to act as the primary. <i>Standby</i> causes a primary Shared Ethernet Adapter to become a backup Shared Ethernet Adapter if there is another Shared Ethernet Adapter that can become the primary Shared Ethernet Adapter.</p> <p><b>Priority</b> Specifies the trunk priority of the virtual Ethernet adapters of the Shared Ethernet Adapter. It is used by the Shared Ethernet Adapter protocol to determine which Shared Ethernet Adapter acts as the primary Shared Ethernet Adapter and which Shared Ethernet Adapter acts as the backup Shared Ethernet Adapter. Values range from 1 to 12, where a lower number is favored to act as a primary Shared Ethernet Adapter.</p> |

## Example statistics

Running the `entstat -all` command returns results similar to the following:

```
ETHERNET STATISTICS (ent8) :
Device Type: Shared Ethernet Adapter
Hardware Address: 00:0d:60:0c:05:00
Elapsed Time: 3 days 20 hours 34 minutes 26 seconds

Transmit Statistics:

Packets: 7978002
Bytes: 919151749
Interrupts: 3
Transmit Errors: 0
Packets Dropped: 0

Receive Statistics:

Packets: 5701362
Bytes: 664049607
Interrupts: 5523380
Receive Errors: 0
Packets Dropped: 0
Bad Packets: 0

Max Packets on S/W Transmit Queue: 2
S/W Transmit Queue Overflow: 0
Current S/W+H/W Transmit Queue Length: 1

Elapsed Time: 0 days 0 hours 0 minutes 0 seconds
Broadcast Packets: 5312086
Multicast Packets: 265589
No Carrier Sense: 0
DMA Underrun: 0
Lost CTS Errors: 0
Max Collision Errors: 0
Late Collision Errors: 0
Deferred: 0
Broadcast Packets: 3740225
Multicast Packets: 194986
CRC Errors: 0
DMA Overrun: 0
Alignment Errors: 0
No Resource Errors: 0
Receive Collision Errors: 0
Packet Too Short Errors: 0
```

SQE Test: 0  
Timeout Errors: 0  
Single Collision Count: 0  
Multiple Collision Count: 0  
Current HW Transmit Queue Length: 1  
Packet Too Long Errors: 0  
Packets Discarded by Adapter: 0  
Receiver Start Count: 0

General Statistics:

-----  
No mbuf Errors: 0  
Adapter Reset Count: 0  
Adapter Data Rate: 0  
Driver Flags: Up Broadcast Running  
Simplex 64BitSupport ChecksumOffLoad  
DataRateSet

-----  
Statistics for adapters in the Shared Ethernet Adapter ent8  
-----

Number of adapters: 2  
SEA Flags: 00000001  
< THREAD >  
VLAN IDs :  
ent7: 1

Real Side Statistics:  
Packets received: 5701344  
Packets bridged: 5673198  
Packets consumed: 3963314  
Packets fragmented: 0  
Packets transmitted: 28685  
Packets dropped: 0

Virtual Side Statistics:  
Packets received: 0  
Packets bridged: 0  
Packets consumed: 0  
Packets fragmented: 0  
Packets transmitted: 5673253  
Packets dropped: 0

Other Statistics:  
Output packets generated: 28685  
Output packets dropped: 0  
Device output failures: 0  
Memory allocation failures: 0  
ICMP error packets sent: 0  
Non IP packets larger than MTU: 0  
Thread queue overflow packets: 0

High Availability Statistics:  
Control Channel PVID: 99  
Control Packets in: 0  
Control Packets out: 818825

Type of Packets Received:  
Keep-Alive Packets: 0  
Recovery Packets: 0  
Notify Packets: 0  
Limbo Packets: 0  
State: LIMBO  
Bridge Mode: All  
Number of Times Server became Backup: 0  
Number of Times Server became Primary: 0  
High Availability Mode: Auto  
Priority: 1

-----  
Real Adapter: ent2

ETHERNET STATISTICS (ent2) :  
Device Type: 10/100 Mbps Ethernet PCI Adapter II (1410ff01)  
Hardware Address: 00:0d:60:0c:05:00

Transmit Statistics:

-----  
Packets: 28684  
Bytes: 3704108  
Interrupts: 3  
Transmit Errors: 0  
Packets Dropped: 0

Receive Statistics:

-----  
Packets: 5701362  
Bytes: 664049607  
Interrupts: 5523380  
Receive Errors: 0  
Packets Dropped: 0  
Bad Packets: 0

Max Packets on S/W Transmit Queue: 2  
S/W Transmit Queue Overflow: 0  
Current S/W+H/W Transmit Queue Length: 1

Broadcast Packets: 21  
Multicast Packets: 0  
No Carrier Sense: 0  
DMA Underrun: 0  
Lost CTS Errors: 0  
Max Collision Errors: 0  
Late Collision Errors: 0  
Deferred: 0  
SQE Test: 0  
Timeout Errors: 0  
Single Collision Count: 0  
Multiple Collision Count: 0  
Current HW Transmit Queue Length: 1

Broadcast Packets: 3740225  
Multicast Packets: 194986  
CRC Errors: 0  
DMA Overrun: 0  
Alignment Errors: 0  
No Resource Errors: 0  
Receive Collision Errors: 0  
Packet Too Short Errors: 0  
Packet Too Long Errors: 0  
Packets Discarded by Adapter: 0  
Receiver Start Count: 0

General Statistics:

-----  
No mbuf Errors: 0  
Adapter Reset Count: 0  
Adapter Data Rate: 200  
Driver Flags: Up Broadcast Running  
Simplex Promiscuous AlternateAddress  
64BitSupport ChecksumOffload PrivateSegment LargeSend DataRateSet

10/100 Mbps Ethernet PCI Adapter II (1410ff01) Specific Statistics:

-----  
Link Status: Up  
Media Speed Selected: Auto negotiation  
Media Speed Running: 100 Mbps Full Duplex  
Receive Pool Buffer Size: 1024  
No Receive Pool Buffer Errors: 0  
Receive Buffer Too Small Errors: 0  
Entries to transmit timeout routine: 0  
Transmit IPsec packets: 0  
Transmit IPsec packets dropped: 0  
Receive IPsec packets: 0  
Receive IPsec SA offload count: 0  
Transmit Large Send packets: 0  
Transmit Large Send packets dropped: 0  
Packets with Transmit collisions:  
1 collisions: 0    6 collisions: 0    11 collisions: 0  
2 collisions: 0    7 collisions: 0    12 collisions: 0  
3 collisions: 0    8 collisions: 0    13 collisions: 0  
4 collisions: 0    9 collisions: 0    14 collisions: 0  
5 collisions: 0    10 collisions: 0    15 collisions: 0

-----  
Virtual Adapter: ent7

ETHERNET STATISTICS (ent7) :  
Device Type: Virtual I/O Ethernet Adapter (1-lan)  
Hardware Address: 8a:83:54:5b:4e:9a

Transmit Statistics:

Receive Statistics:

-----  
Packets: 7949318  
Bytes: 915447641  
Interrupts: 0  
Transmit Errors: 0  
Packets Dropped: 0

-----  
Packets: 0  
Bytes: 0  
Interrupts: 0  
Receive Errors: 0  
Packets Dropped: 0  
Bad Packets: 0

Max Packets on S/W Transmit Queue: 0  
S/W Transmit Queue Overflow: 0  
Current S/W+H/W Transmit Queue Length: 0

Broadcast Packets: 5312065  
Multicast Packets: 265589  
No Carrier Sense: 0  
DMA Underrun: 0  
Lost CTS Errors: 0  
Max Collision Errors: 0  
Late Collision Errors: 0  
Deferred: 0  
SQE Test: 0  
Timeout Errors: 0  
Single Collision Count: 0  
Multiple Collision Count: 0  
Current HW Transmit Queue Length: 0

Broadcast Packets: 0  
Multicast Packets: 0  
CRC Errors: 0  
DMA Overrun: 0  
Alignment Errors: 0  
No Resource Errors: 0  
Receive Collision Errors: 0  
Packet Too Short Errors: 0  
Packet Too Long Errors: 0  
Packets Discarded by Adapter: 0  
Receiver Start Count: 0

General Statistics:

-----  
No mbuf Errors: 0  
Adapter Reset Count: 0  
Adapter Data Rate: 20000  
Driver Flags: Up Broadcast Running  
Simplex Promiscuous AllMulticast  
64BitSupport ChecksumOffload DataRateSet

Virtual I/O Ethernet Adapter (1-lan) Specific Statistics:

-----  
RQ Length: 4481  
No Copy Buffers: 0  
Trunk Adapter: True  
Priority: 1 Active: True  
Filter MCast Mode: False  
Filters: 255  
Enabled: 1 Queued: 0 Overflow: 0  
LAN State: Operational

Hypervisor Send Failures: 2371664  
Receiver Failures: 2371664  
Send Errors: 0

Hypervisor Receive Failures: 0

ILLAN Attributes: 0000000000003103 [0000000000003103]

PVID: 1      VIDs: None

Switch ID: ETHERNET0

| Buffers | Reg | Alloc | Min | Max  | MaxA | LowReg |
|---------|-----|-------|-----|------|------|--------|
| tiny    | 512 | 512   | 512 | 2048 | 512  | 512    |
| small   | 512 | 512   | 512 | 2048 | 512  | 512    |
| medium  | 128 | 128   | 128 | 256  | 128  | 128    |
| large   | 24  | 24    | 24  | 64   | 24   | 24     |
| huge    | 24  | 24    | 24  | 64   | 24   | 24     |

-----  
Control Adapter: ent9

ETHERNET STATISTICS (ent9) :  
Device Type: Virtual I/O Ethernet Adapter (1-lan)  
Hardware Address: 8a:83:54:5b:4e:9b

Transmit Statistics:

-----  
Packets: 821297  
Bytes: 21353722  
Interrupts: 0  
Transmit Errors: 0  
Packets Dropped: 0

Receive Statistics:

-----  
Packets: 0  
Bytes: 0  
Interrupts: 0  
Receive Errors: 0  
Packets Dropped: 0  
Bad Packets: 0

Max Packets on S/W Transmit Queue: 0  
S/W Transmit Queue Overflow: 0  
Current S/W+H/W Transmit Queue Length: 0

Broadcast Packets: 821297  
Multicast Packets: 0  
No Carrier Sense: 0  
DMA Underrun: 0  
Lost CTS Errors: 0  
Max Collision Errors: 0  
Late Collision Errors: 0  
Deferred: 0  
SQE Test: 0  
Timeout Errors: 0  
Single Collision Count: 0  
Multiple Collision Count: 0  
Current HW Transmit Queue Length: 0

Broadcast Packets: 0  
Multicast Packets: 0  
CRC Errors: 0  
DMA Overrun: 0  
Alignment Errors: 0  
No Resource Errors: 0  
Receive Collision Errors: 0  
Packet Too Short Errors: 0  
Packet Too Long Errors: 0  
Packets Discarded by Adapter: 0  
Receiver Start Count: 0

General Statistics:

-----  
No mbuf Errors: 0  
Adapter Reset Count: 0  
Adapter Data Rate: 20000  
Driver Flags: Up Broadcast Running  
Simplex 64BitSupport ChecksumOffload DataRateSet

Virtual I/O Ethernet Adapter (1-lan) Specific Statistics:

-----  
RQ Length: 4481  
No Copy Buffers: 0  
Trunk Adapter: False  
Filter MCast Mode: False  
Filters: 255  
Enabled: 0 Queued: 0 Overflow: 0  
LAN State: Operational

Hypervisor Send Failures: 0  
Receiver Failures: 0  
Send Errors: 0

Hypervisor Receive Failures: 0

ILLAN Attributes: 0000000000003002 [0000000000003002]

PVID: 99      VIDs: None

Switch ID: ETHERNET0

| Buffers | Reg | Alloc | Min | Max  | MaxA | LowReg |
|---------|-----|-------|-----|------|------|--------|
| tiny    | 512 | 512   | 512 | 2048 | 512  | 512    |
| small   | 512 | 512   | 512 | 2048 | 512  | 512    |

|        |     |     |     |     |     |     |
|--------|-----|-----|-----|-----|-----|-----|
| medium | 128 | 128 | 128 | 256 | 128 | 128 |
| large  | 24  | 24  | 24  | 64  | 24  | 24  |
| huge   | 24  | 24  | 24  | 64  | 24  | 24  |

## Shared Ethernet Adapter statistics

Learn about general Shared Ethernet Adapter statistics, such as VLAN IDs and packet information, and view examples.

### Statistic descriptions

Table 60. Descriptions of Shared Ethernet Adapter statistics

| Statistic                     | Description                                                                                                                                                                                                                                                                                                                                                                                                                                                                                                                                                                                                                                        |
|-------------------------------|----------------------------------------------------------------------------------------------------------------------------------------------------------------------------------------------------------------------------------------------------------------------------------------------------------------------------------------------------------------------------------------------------------------------------------------------------------------------------------------------------------------------------------------------------------------------------------------------------------------------------------------------------|
| Number of adapters            | Includes the real adapter and all of the virtual adapters.<br><b>Note:</b> If you are using Shared Ethernet Adapter failover, then the control channel adapter is not included.                                                                                                                                                                                                                                                                                                                                                                                                                                                                    |
| Shared Ethernet Adapter flags | Denotes the features that the Shared Ethernet Adapter is currently running.<br><br><b>THREAD</b><br>The Shared Ethernet Adapter is operating in threaded mode, where incoming packets are queued and processed by different threads; its absence denotes interrupt mode, where packets are processed in the same interrupt where they are received.<br><br><b>LARGSEND</b><br>The large send feature has been enabled on the Shared Ethernet Adapter.<br><br><b>JUMBO_FRAMES</b><br>The jumbo frames feature has been enabled on the Shared Ethernet Adapter.<br><br><b>GVRP</b> The GVRP feature has been enabled on the Shared Ethernet Adapter. |
| VLAN IDs                      | List of VLAN IDs that have access to the network through the Shared Ethernet Adapter (this includes PVID and all tagged VLANs).                                                                                                                                                                                                                                                                                                                                                                                                                                                                                                                    |

Table 60. Descriptions of Shared Ethernet Adapter statistics (continued)

| Statistic     | Description                                                                                                                                                                                                                                                                                                                                                                                                                                                                                                                                                                                                                                                                                                                                                                                                                                                                                                                                                                                                                                                                                                                                                                                                                                                                                                                                                                                                                                                            |
|---------------|------------------------------------------------------------------------------------------------------------------------------------------------------------------------------------------------------------------------------------------------------------------------------------------------------------------------------------------------------------------------------------------------------------------------------------------------------------------------------------------------------------------------------------------------------------------------------------------------------------------------------------------------------------------------------------------------------------------------------------------------------------------------------------------------------------------------------------------------------------------------------------------------------------------------------------------------------------------------------------------------------------------------------------------------------------------------------------------------------------------------------------------------------------------------------------------------------------------------------------------------------------------------------------------------------------------------------------------------------------------------------------------------------------------------------------------------------------------------|
| Real adapters | <p><b>Packets received</b><br/>Number of packets received on the physical network.</p> <p><b>Packets bridged</b><br/>Number of packets received on the physical network that were sent to the virtual network.</p> <p><b>Packets consumed</b><br/>Number of packets received on the physical network that were addressed to the interface configured over the Shared Ethernet Adapter.</p> <p><b>Packets fragmented</b><br/>Number of packets received on the physical network that were fragmented before being sent to the virtual network. They were fragmented because they were bigger than the outgoing adapter's Maximum Transmission Unit (MTU).</p> <p><b>Packets transmitted</b><br/>Number of packets sent on the physical network. This includes packets sent from the interface configured over the Shared Ethernet Adapter, as well as each packet sent from the virtual network to the physical network (including fragments).</p> <p><b>Packets dropped</b><br/>Number of packets received on the physical network that were dropped for one of the following reasons:</p> <ul style="list-style-type: none"> <li>• The packet was the oldest packet on a thread's queue and there was no space to accommodate a newly received packet.</li> <li>• The packet had an invalid VLAN ID and could not be processed.</li> <li>• The packet was addressed to the Shared Ethernet Adapter interface, but its interface had no filters registered.</li> </ul> |

Table 60. Descriptions of Shared Ethernet Adapter statistics (continued)

| Statistic                  | Description                                                                                                                                                                                                                                                                                                                                                                                                                                                                                                                                                                                                                                                                                                                                                                                                                                                                                                                                                                                                                                                                                                                                                                                                                                                                                                                                                                                                                                  |
|----------------------------|----------------------------------------------------------------------------------------------------------------------------------------------------------------------------------------------------------------------------------------------------------------------------------------------------------------------------------------------------------------------------------------------------------------------------------------------------------------------------------------------------------------------------------------------------------------------------------------------------------------------------------------------------------------------------------------------------------------------------------------------------------------------------------------------------------------------------------------------------------------------------------------------------------------------------------------------------------------------------------------------------------------------------------------------------------------------------------------------------------------------------------------------------------------------------------------------------------------------------------------------------------------------------------------------------------------------------------------------------------------------------------------------------------------------------------------------|
| Virtual adapters           | <p><b>Packets received</b><br/>Number of packets received on the virtual network. In other words, the number of packets received on all of the virtual adapters.</p> <p><b>Packets bridged</b><br/>Number of packets received on the virtual network that were sent to the physical network.</p> <p><b>Packets consumed</b><br/>Number of packets received on the virtual network that were addressed to the interface configured over the Shared Ethernet Adapter.</p> <p><b>Packets fragmented</b><br/>Number of packets received on the virtual network that were fragmented before being sent to the physical network. They were fragmented because they were bigger than the outgoing adapter's MTU.</p> <p><b>Packets transmitted</b><br/>Number of packets sent on the virtual network. This includes packets sent from the interface configured over the Shared Ethernet Adapter, as well as each packet sent from the physical network to the virtual network (including fragments).</p> <p><b>Packets dropped</b><br/>Number of packets received on the virtual network that were dropped for one of the following reasons:</p> <ul style="list-style-type: none"> <li>• The packet was the oldest packet on a thread's queue and there was no space to accommodate a newly received packet.</li> <li>• The packet was addressed to the Shared Ethernet Adapter interface, but its interface had no filters registered.</li> </ul> |
| Output packets generated   | Number of packets with a valid VLAN tag or no VLAN tag sent out of the interface configured over the Shared Ethernet Adapter.                                                                                                                                                                                                                                                                                                                                                                                                                                                                                                                                                                                                                                                                                                                                                                                                                                                                                                                                                                                                                                                                                                                                                                                                                                                                                                                |
| Output packets dropped     | Number of packets sent out of the interface configured over the Shared Ethernet Adapter that are dropped because of an invalid VLAN tag.                                                                                                                                                                                                                                                                                                                                                                                                                                                                                                                                                                                                                                                                                                                                                                                                                                                                                                                                                                                                                                                                                                                                                                                                                                                                                                     |
| Device output failures     | Number of packets that could not be sent due to underlying device errors. This includes errors sent on the physical network and virtual network, including fragments and Internet Control Message Protocol (ICMP) error packets generated by the Shared Ethernet Adapter.                                                                                                                                                                                                                                                                                                                                                                                                                                                                                                                                                                                                                                                                                                                                                                                                                                                                                                                                                                                                                                                                                                                                                                    |
| Memory allocation failures | Number of packets that could not be sent because there was insufficient network memory to complete an operation.                                                                                                                                                                                                                                                                                                                                                                                                                                                                                                                                                                                                                                                                                                                                                                                                                                                                                                                                                                                                                                                                                                                                                                                                                                                                                                                             |



Table 60. Descriptions of Shared Ethernet Adapter statistics (continued)

| Statistic                      | Description                                                                                                                                                     |
|--------------------------------|-----------------------------------------------------------------------------------------------------------------------------------------------------------------|
| ICMP error packets sent        | Number of ICMP error packets successfully sent when a big packet could not be fragmented because the <i>don't fragment</i> bit was set.                         |
| Non IP packets larger than MTU | Number of packets that could not be sent because they were bigger than the outgoing adapter's MTU and could not be fragmented because they were not IP packets. |
| Thread queue overflow packets  | Number of packets that were dropped from the thread queues because there was no space to accommodate a newly received packet.                                   |

## Example statistics

ETHERNET STATISTICS (ent8) :

Device Type: Shared Ethernet Adapter

Hardware Address: 00:0d:60:0c:05:00

Elapsed Time: 3 days 20 hours 34 minutes 26 seconds

Transmit Statistics:

-----

Packets: 7978002

Bytes: 919151749

Interrupts: 3

Transmit Errors: 0

Packets Dropped: 0

Receive Statistics:

-----

Packets: 5701362

Bytes: 664049607

Interrupts: 5523380

Receive Errors: 0

Packets Dropped: 0

Bad Packets: 0

Max Packets on S/W Transmit Queue: 2

S/W Transmit Queue Overflow: 0

Current S/W+H/W Transmit Queue Length: 1

Elapsed Time: 0 days 0 hours 0 minutes 0 seconds

Broadcast Packets: 5312086

Multicast Packets: 265589

No Carrier Sense: 0

DMA Underrun: 0

Lost CTS Errors: 0

Max Collision Errors: 0

Late Collision Errors: 0

Deferred: 0

SQE Test: 0

Timeout Errors: 0

Single Collision Count: 0

Multiple Collision Count: 0

Current HW Transmit Queue Length: 1

Broadcast Packets: 3740225

Multicast Packets: 194986

CRC Errors: 0

DMA Overrun: 0

Alignment Errors: 0

No Resource Errors: 0

Receive Collision Errors: 0

Packet Too Short Errors: 0

Packet Too Long Errors: 0

Packets Discarded by Adapter: 0

Receiver Start Count: 0

General Statistics:

-----

No mbuf Errors: 0

Adapter Reset Count: 0

Adapter Data Rate: 0

Driver Flags: Up Broadcast Running

Simplex 64BitSupport ChecksumOffLoad

DataRateSet

-----  
 Statistics for adapters in the Shared Ethernet Adapter ent8  
 -----

Number of adapters: 2

SEA Flags: 00000001

< THREAD >

VLAN IDs :

ent7: 1

Real Side Statistics:  
Packets received: 5701344  
Packets bridged: 5673198  
Packets consumed: 3963314  
Packets fragmented: 0  
Packets transmitted: 28685  
Packets dropped: 0  
Virtual Side Statistics:  
Packets received: 0  
Packets bridged: 0  
Packets consumed: 0  
Packets fragmented: 0  
Packets transmitted: 5673253  
Packets dropped: 0  
Other Statistics:  
Output packets generated: 28685  
Output packets dropped: 0  
Device output failures: 0  
Memory allocation failures: 0  
ICMP error packets sent: 0  
Non IP packets larger than MTU: 0  
Thread queue overflow packets: 0

-----  
Real Adapter: ent2

ETHERNET STATISTICS (ent2) :  
Device Type: 10/100 Mbps Ethernet PCI Adapter II (1410ff01)  
Hardware Address: 00:0d:60:0c:05:00

Transmit Statistics:

-----  
Packets: 28684  
Bytes: 3704108  
Interrupts: 3  
Transmit Errors: 0  
Packets Dropped: 0

Receive Statistics:

-----  
Packets: 5701362  
Bytes: 664049607  
Interrupts: 5523380  
Receive Errors: 0  
Packets Dropped: 0  
Bad Packets: 0

Max Packets on S/W Transmit Queue: 2  
S/W Transmit Queue Overflow: 0  
Current S/W+H/W Transmit Queue Length: 1

Broadcast Packets: 21  
Multicast Packets: 0  
No Carrier Sense: 0  
DMA Underrun: 0  
Lost CTS Errors: 0  
Max Collision Errors: 0  
Late Collision Errors: 0  
Deferred: 0  
SQE Test: 0  
Timeout Errors: 0  
Single Collision Count: 0  
Multiple Collision Count: 0  
Current HW Transmit Queue Length: 1

Broadcast Packets: 3740225  
Multicast Packets: 194986  
CRC Errors: 0  
DMA Overrun: 0  
Alignment Errors: 0  
No Resource Errors: 0  
Receive Collision Errors: 0  
Packet Too Short Errors: 0  
Packet Too Long Errors: 0  
Packets Discarded by Adapter: 0  
Receiver Start Count: 0

General Statistics:

-----  
No mbuf Errors: 0  
Adapter Reset Count: 0  
Adapter Data Rate: 200  
Driver Flags: Up Broadcast Running  
Simplex Promiscuous AlternateAddress  
64BitSupport ChecksumOffload PrivateSegment LargeSend DataRateSet

10/100 Mbps Ethernet PCI Adapter II (1410ff01) Specific Statistics:

```

Link Status: Up
Media Speed Selected: Auto negotiation
Media Speed Running: 100 Mbps Full Duplex
Receive Pool Buffer Size: 1024
No Receive Pool Buffer Errors: 0
Receive Buffer Too Small Errors: 0
Entries to transmit timeout routine: 0
Transmit IPsec packets: 0
Transmit IPsec packets dropped: 0
Receive IPsec packets: 0
Receive IPsec SA offload count: 0
Transmit Large Send packets: 0
Transmit Large Send packets dropped: 0
Packets with Transmit collisions:
 1 collisions: 0 6 collisions: 0 11 collisions: 0
 2 collisions: 0 7 collisions: 0 12 collisions: 0
 3 collisions: 0 8 collisions: 0 13 collisions: 0
 4 collisions: 0 9 collisions: 0 14 collisions: 0
 5 collisions: 0 10 collisions: 0 15 collisions: 0

```

```

Virtual Adapter: ent7

```

```

ETHERNET STATISTICS (ent7) :
Device Type: Virtual I/O Ethernet Adapter (1-lan)
Hardware Address: 8a:83:54:5b:4e:9a

```

Transmit Statistics:

```

Packets: 7949318
Bytes: 915447641
Interrupts: 0
Transmit Errors: 0
Packets Dropped: 0

```

Receive Statistics:

```

Packets: 0
Bytes: 0
Interrupts: 0
Receive Errors: 0
Packets Dropped: 0
Bad Packets: 0

```

```

Max Packets on S/W Transmit Queue: 0
S/W Transmit Queue Overflow: 0
Current S/W+H/W Transmit Queue Length: 0

```

```

Broadcast Packets: 5312065
Multicast Packets: 265589
No Carrier Sense: 0
DMA Underrun: 0
Lost CTS Errors: 0
Max Collision Errors: 0
Late Collision Errors: 0
Deferred: 0
SQE Test: 0
Timeout Errors: 0
Single Collision Count: 0
Multiple Collision Count: 0
Current HW Transmit Queue Length: 0

```

```

Broadcast Packets: 0
Multicast Packets: 0
CRC Errors: 0
DMA Overrun: 0
Alignment Errors: 0
No Resource Errors: 0
Receive Collision Errors: 0
Packet Too Short Errors: 0
Packet Too Long Errors: 0
Packets Discarded by Adapter: 0
Receiver Start Count: 0

```

General Statistics:

```

No mbuf Errors: 0
Adapter Reset Count: 0
Adapter Data Rate: 20000
Driver Flags: Up Broadcast Running
Simplex Promiscuous AllMulticast
64BitSupport ChecksumOffload DataRateSet

```

Virtual I/O Ethernet Adapter (1-lan) Specific Statistics:

```

RQ Length: 4481

```

No Copy Buffers: 0  
Trunk Adapter: True  
  Priority: 1 Active: True  
Filter MCast Mode: False  
Filters: 255  
  Enabled: 1 Queued: 0 Overflow: 0  
LAN State: Operational

Hypervisor Send Failures: 2371664  
  Receiver Failures: 2371664  
  Send Errors: 0

Hypervisor Receive Failures: 0

ILLAN Attributes: 0000000000003103 [0000000000003103]

PVID: 1       VIDs: None

Switch ID: ETHERNET0

| Buffers | Reg | Alloc | Min | Max  | MaxA | LowReg |
|---------|-----|-------|-----|------|------|--------|
| tiny    | 512 | 512   | 512 | 2048 | 512  | 512    |
| small   | 512 | 512   | 512 | 2048 | 512  | 512    |
| medium  | 128 | 128   | 128 | 256  | 128  | 128    |
| large   | 24  | 24    | 24  | 64   | 24   | 24     |
| huge    | 24  | 24    | 24  | 64   | 24   | 24     |

## User types for the Virtual I/O Server

Learn about Virtual I/O Server user types and their user permissions.

The Virtual I/O Server has the following user types: prime administrator, system administrator, service representative user, and development engineer user. After installation, the only user type that is active is the prime administrator.

### Prime administrator

The prime administrator (**padmin**) user ID is the only user ID that is enabled after installation of the Virtual I/O Server and can run every Virtual I/O Server command. There can be only one prime administrator in the Virtual I/O Server.

### System administrator

The system administrator user ID has access to all commands except the following commands:

- **lsfailedlogin**
- **lsgcl**
- **mirrorios**
- **mkuser**
- **oem\_setup\_env**
- **rmuser**
- **shutdown**
- **unmirrorios**

The prime administrator can create an unlimited number of system administrator IDs.

### Service representative

Create the service representative (SR) user so that an service representative can log in to the system and perform diagnostic routines. Upon logging in, the SR user is placed directly into the diagnostic menus.

## **Development engineer**

Create a Development engineer (DE) user ID so that an development engineer can log in to the system and debug problems.

### **View**

This role is a read-only role and can perform only list-type (ls) functions. Users with this role do not have the authority to change the system configuration and do not have write permission to their home directories.



---

## Notices

This information was developed for products and services offered in the U.S.A.

The manufacturer may not offer the products, services, or features discussed in this document in other countries. Consult the manufacturer's representative for information on the products and services currently available in your area. Any reference to the manufacturer's product, program, or service is not intended to state or imply that only that product, program, or service may be used. Any functionally equivalent product, program, or service that does not infringe any intellectual property right of the manufacturer may be used instead. However, it is the user's responsibility to evaluate and verify the operation of any product, program, or service.

The manufacturer may have patents or pending patent applications covering subject matter described in this document. The furnishing of this document does not grant you any license to these patents. You can send license inquiries, in writing, to the manufacturer.

For license inquiries regarding double-byte character set (DBCS) information, contact the Intellectual Property Department in your country or send inquiries, in writing, to the manufacturer.

**The following paragraph does not apply to the United Kingdom or any other country where such provisions are inconsistent with local law:** THIS PUBLICATION IS PROVIDED "AS IS " WITHOUT WARRANTY OF ANY KIND, EITHER EXPRESS OR IMPLIED, INCLUDING, BUT NOT LIMITED TO, THE IMPLIED WARRANTIES OF NON-INFRINGEMENT, MERCHANTABILITY OR FITNESS FOR A PARTICULAR PURPOSE. Some states do not allow disclaimer of express or implied warranties in certain transactions, therefore, this statement may not apply to you.

This information could include technical inaccuracies or typographical errors. Changes are periodically made to the information herein; these changes will be incorporated in new editions of the publication. The manufacturer may make improvements and/or changes in the product(s) and/or the program(s) described in this publication at any time without notice.

Any references in this information to websites not owned by the manufacturer are provided for convenience only and do not in any manner serve as an endorsement of those websites. The materials at those websites are not part of the materials for this product and use of those websites is at your own risk.

The manufacturer may use or distribute any of the information you supply in any way it believes appropriate without incurring any obligation to you.

Licensees of this program who wish to have information about it for the purpose of enabling: (i) the exchange of information between independently created programs and other programs (including this one) and (ii) the mutual use of the information which has been exchanged, should contact the manufacturer.

Such information may be available, subject to appropriate terms and conditions, including in some cases, payment of a fee.

The licensed program described in this document and all licensed material available for it are provided by IBM under terms of the IBM Customer Agreement, IBM International Program License Agreement, IBM License Agreement for Machine Code, or any equivalent agreement between us.

Any performance data contained herein was determined in a controlled environment. Therefore, the results obtained in other operating environments may vary significantly. Some measurements may have been made on development-level systems and there is no guarantee that these measurements will be the

same on generally available systems. Furthermore, some measurements may have been estimated through extrapolation. Actual results may vary. Users of this document should verify the applicable data for their specific environment.

Information concerning products not produced by this manufacturer was obtained from the suppliers of those products, their published announcements or other publicly available sources. This manufacturer has not tested those products and cannot confirm the accuracy of performance, compatibility or any other claims related to products not produced by this manufacturer. Questions on the capabilities of products not produced by this manufacturer should be addressed to the suppliers of those products.

All statements regarding the manufacturer's future direction or intent are subject to change or withdrawal without notice, and represent goals and objectives only.

The manufacturer's prices shown are the manufacturer's suggested retail prices, are current and are subject to change without notice. Dealer prices may vary.

This information is for planning purposes only. The information herein is subject to change before the products described become available.

This information contains examples of data and reports used in daily business operations. To illustrate them as completely as possible, the examples include the names of individuals, companies, brands, and products. All of these names are fictitious and any similarity to the names and addresses used by an actual business enterprise is entirely coincidental.

#### COPYRIGHT LICENSE:

This information contains sample application programs in source language, which illustrate programming techniques on various operating platforms. You may copy, modify, and distribute these sample programs in any form without payment to the manufacturer, for the purposes of developing, using, marketing or distributing application programs conforming to the application programming interface for the operating platform for which the sample programs are written. These examples have not been thoroughly tested under all conditions. The manufacturer, therefore, cannot guarantee or imply reliability, serviceability, or function of these programs. The sample programs are provided "AS IS", without warranty of any kind. The manufacturer shall not be liable for any damages arising out of your use of the sample programs.

Each copy or any portion of these sample programs or any derivative work, must include a copyright notice as follows:

© (your company name) (year). Portions of this code are derived from IBM Corp. Sample Programs. © Copyright IBM Corp. \_enter the year or years\_.

If you are viewing this information in softcopy, the photographs and color illustrations may not appear.

---

## Programming interface information

This Virtual I/O Server publication documents intended Programming Interfaces that allow the customer to write programs to obtain the services of Virtual I/O Server.

---

## Trademarks

IBM, the IBM logo, and [ibm.com](http://ibm.com) are trademarks or registered trademarks of International Business Machines Corp., registered in many jurisdictions worldwide. Other product and service names might be trademarks of IBM or other companies. A current list of IBM trademarks is available on the web at [www.ibm.com/legal/copytrade.shtml](http://www.ibm.com/legal/copytrade.shtml).

Linux is a registered trademark of Linus Torvalds in the United States, other countries, or both.



Microsoft and Windows are trademarks of Microsoft Corporation in the United States, other countries, or both.

Red Hat, the Red Hat "Shadow Man" logo, and all Red Hat-based trademarks and logos are trademarks or registered trademarks of Red Hat, Inc., in the United States and other countries.

UNIX is a registered trademark of The Open Group in the United States and other countries.

Other product and service names might be trademarks of IBM or other companies.

---

## Terms and conditions

Permissions for the use of these publications are granted subject to the following terms and conditions.

**Applicability:** These terms and conditions are in addition to any terms of use for the the manufacturer website.

**Personal Use:** You may reproduce these publications for your personal, noncommercial use provided that all proprietary notices are preserved. You may not distribute, display or make derivative works of these publications, or any portion thereof, without the express consent of the manufacturer.

**Commercial Use:** You may reproduce, distribute and display these publications solely within your enterprise provided that all proprietary notices are preserved. You may not make derivative works of these publications, or reproduce, distribute or display these publications or any portion thereof outside your enterprise, without the express consent of the manufacturer.

**Rights:** Except as expressly granted in this permission, no other permissions, licenses or rights are granted, either express or implied, to the Publications or any information, data, software or other intellectual property contained therein.

The manufacturer reserves the right to withdraw the permissions granted herein whenever, in its discretion, the use of the publications is detrimental to its interest or, as determined by the manufacturer, the above instructions are not being properly followed.

You may not download, export or re-export this information except in full compliance with all applicable laws and regulations, including all United States export laws and regulations.

THE MANUFACTURER MAKES NO GUARANTEE ABOUT THE CONTENT OF THESE PUBLICATIONS. THE PUBLICATIONS ARE PROVIDED "AS-IS" AND WITHOUT WARRANTY OF ANY KIND, EITHER EXPRESSED OR IMPLIED, INCLUDING BUT NOT LIMITED TO IMPLIED WARRANTIES OF MERCHANTABILITY, NON-INFRINGEMENT, AND FITNESS FOR A PARTICULAR PURPOSE.

