

Bull

Performance Tools Guide and Reference

AIX



Bull

Performance Tools Guide and Reference

AIX

Software

October 2005

**BULL CEDOC
357 AVENUE PATTON
B.P.20845
49008 ANGERS CEDEX 01
FRANCE**

ORDER REFERENCE
86 A2 55EM 01

The following copyright notice protects this book under the Copyright laws of the United States of America and other countries which prohibit such actions as, but not limited to, copying, distributing, modifying, and making derivative works.

Copyright © Bull S.A. 1992, 2005

Printed in France

Suggestions and criticisms concerning the form, content, and presentation of this book are invited. A form is provided at the end of this book for this purpose.

To order additional copies of this book or other Bull Technical Publications, you are invited to use the Ordering Form also provided at the end of this book.

Trademarks and Acknowledgements

We acknowledge the right of proprietors of trademarks mentioned in this book.

AIX[®] is a registered trademark of International Business Machines Corporation, and is being used under licence.

UNIX is a registered trademark in the United States of America and other countries licensed exclusively through the Open Group.

Linux is a registered trademark of Linus Torvalds.

Contents

About This Book	v
Highlighting	v
Case-Sensitivity in AIX	v
ISO 9000	v
Related Publications	v
Chapter 1. Introduction to Performance Tools and APIs	1
Chapter 2. X-Windows Performance Profiler (Xprofiler)	3
Before You Begin	3
Xprofiler Installation Information	4
Starting the Xprofiler GUI	6
Understanding the Xprofiler Display	20
Controlling how the Display is Updated	25
Other Viewing Options	25
Filtering what You See	27
Clustering Libraries	32
Locating Specific Objects in the Function Call Tree	35
Obtaining Performance Data for Your Application	37
Saving Screen Images of Profiled Data	54
Customizing Xprofiler Resources	56
Chapter 3. CPU Utilization Reporting Tool (curt)	63
Syntax for the curt Command	63
Measurement and Sampling	64
Examples of the curt command	65
Chapter 4. Simple Performance Lock Analysis Tool (splat)	95
splat Command Syntax	95
Measurement and Sampling	96
Examples of Generated Reports	98
Chapter 5. Hardware Performance Monitor APIs and tools	115
Performance Monitor accuracy	115
Performance Monitor context and state	116
Thread accumulation and thread group accumulation	117
Security considerations	117
The pmapi library	117
The hpm library and associated tools	125
Chapter 6. Perfstat API Programming	133
API Characteristics	133
Global Interfaces	133
Component-Specific Interfaces	143
Cached metrics interfaces	157
Change History of the perfstat API	160
Related Information	163
Chapter 7. Kernel Tuning	165
Migration and Compatibility	165
Tunables File Directory	166
Tunable Parameters Type	167
Common Syntax for Tuning Commands	167

Tunable File-Manipulation Commands	169
Initial setup	172
Reboot Tuning Procedure	173
Recovery Procedure	173
Kernel Tuning Using the SMIT Interface	173
Kernel Tuning using the Performance Plug-In for Web-based System Manager	179
Files	189
Related Information	189
Chapter 8. The procmon tool	191
Overview of the procmon tool	191
Components of the procmon tool	191
Filtering processes	193
Performing AIX commands on processes	194
Chapter 9. Profiling tools	195
The timing commands	195
The prof command	195
The gprof command	197
The tprof command	199
Index	207

About This Book

The Performance Tools Guide and Reference provides experienced system administrators, application programmers, service representatives, system engineers, end users, and system programmers with complete, detailed information about the various performance tools that are available for monitoring and tuning AIX® systems and applications running on those systems. This publication is also available on the documentation CD that is shipped with the operating system.

The information contained in this book pertains to systems running AIX 5.2 or later. Any content that is applicable to earlier releases will be noted as such.

Highlighting

The following highlighting conventions are used in this book:

Bold	Identifies commands, subroutines, keywords, files, structures, directories, and other items whose names are predefined by the system. Also identifies graphical objects such as buttons, labels, and icons that the user selects.
<i>Italics</i>	Identifies parameters whose actual names or values are to be supplied by the user.
Monospace	Identifies examples of specific data values, examples of text similar to what you might see displayed, examples of portions of program code similar to what you might write as a programmer, messages from the system, or information you should actually type.

Case-Sensitivity in AIX

Everything in the AIX operating system is case-sensitive, which means that it distinguishes between uppercase and lowercase letters. For example, you can use the **ls** command to list files. If you type **LS**, the system responds that the command is "not found." Likewise, **FILEA**, **FiLea**, and **filea** are three distinct file names, even if they reside in the same directory. To avoid causing undesirable actions to be performed, always ensure that you use the correct case.

ISO 9000

ISO 9000 registered quality systems were used in the development and manufacturing of this product.

Related Publications

The following books contain information about or related to performance monitoring:

AIX 5L Version 5.3 Performance Management Guide

Performance Toolbox Version 2 and 3 for AIX: Guide and Reference

Chapter 1. Introduction to Performance Tools and APIs

The performance of a computer system is based on human expectations and the ability of the computer system to fulfill these expectations. The objective for performance tuning is to make those expectations and their fulfillment match. The path to achieving this objective is a balance between appropriate expectations and optimizing the available system resources. The performance-tuning process demands great skill, knowledge, and experience, and cannot be performed by only analyzing statistics, graphs, and figures. If results are to be achieved, the human aspect of perceived performance must not be neglected. Performance tuning also takes into consideration problem-determination aspects as well as pure performance issues.

Expectations can often be classified as either of the following:

Throughput expectations	A measure of the amount of work performed over a period of time
Response time expectations	The elapsed time between when a request is submitted and when the response from that request is returned

The performance-tuning process can be initiated for a number of reasons:

- To achieve optimal performance in a newly installed system
- To resolve performance problems resulting from the design (sizing) phase
- To resolve performance problems occurring in the run-time (production) phase

Performance tuning on a newly installed system usually involves setting some base parameters for the operating system and applications. Throughout this book, there are sections that describe the characteristics of different system resources and provide guidelines regarding their base tuning parameters, if applicable.

Limitations originating from the sizing phase will either limit the possibility of tuning, or incur greater cost to overcome them. The system may not meet the original performance expectations because of unrealistic expectations, physical problems in the computer environment, or human error in the design or implementation of the system. In the worst case, adding or replacing hardware might be necessary. Be particularly careful when sizing a system to allow enough capacity for unexpected system loads. In other words, do not design the system to be 100 percent busy from the start of the project.

When a system in a productive environment still meets the performance expectations for which it was initially designed, but the demands and needs of the utilizing organization have outgrown the system's basic capacity, performance tuning is performed to delay or even to avoid the cost of adding or replacing hardware.

Many performance-related issues can be traced back to operations performed by a person with limited experience and knowledge who unintentionally restricted some vital logical or physical resource of the system.

Chapter 2. X-Windows Performance Profiler (Xprofiler)

The X-Windows Performance Profiler (Xprofiler) tool helps you analyze your parallel or serial application's performance. It uses procedure-profiling information to construct a graphical display of the functions within your application. Xprofiler provides quick access to the profiled data, which lets you identify the functions that are the most CPU-intensive. The graphical user interface (GUI) also lets you manipulate the display in order to focus on the application's critical areas.

The following Xprofiler topics are covered in this chapter:

- Before You Begin
- Xprofiler installation information
- Starting the Xprofiler GUI
- Customizing Xprofiler resources

The word *function* is used frequently throughout this chapter. Consider it to be synonymous with the terms *routine*, *subroutine*, and *procedure*.

Before You Begin

About Xprofiler

Xprofiler lets you profile both serial and parallel applications. Serial applications generate a single profile data file, while a parallel application produces multiple profile data files. You can use Xprofiler to analyze the resulting profiling information.

Xprofiler provides a set of resource variables that let you customize some of the features of the Xprofiler window and reports.

Requirements and Limitations

To use Xprofiler, your application must be compiled with the **-pg** flag. For more information, see "Compiling Applications to be Profiled" on page 4.

Note: Beginning with AIX 5.3, you can generate a new format of the thread-level profiling **gmon.out** files. Xprofiler does not support this new format, so you must set the **GPROF** environment variable to ensure that you produce the previous format of the **gmon.out** files. For more information, please see the **gprof** Command.

Like the **gprof** command, Xprofiler lets you analyze CPU (busy) usage only. It does not provide other kinds of information, such as CPU idle, I/O, or communication information.

If you compile your application on one processor, and then analyze it on another, you must first make sure that both processors have similar library configurations, at least for the system libraries used by the application. For example, if you run a High Performance Fortran application on a server, then try to analyze the profiled data on a workstation, the levels of High Performance Fortran run-time libraries must match and must be placed in a location on the workstation that Xprofiler recognizes. Otherwise, Xprofiler produces unpredictable results.

Because Xprofiler collects data by sampling, functions that run for a short amount of time may not show any CPU use.

Xprofiler does not give you information about the specific threads in a multi-threaded program. Xprofiler presents the data as a summary of the activities of all the threads.

Comparing Xprofiler and the gprof Command

With Xprofiler, you can produce the same tabular reports that you may be accustomed to seeing with the **gprof** command. As with **gprof**, you can generate the Flat Profile, Call Graph Profile, and Function Index reports.

Unlike **gprof**, Xprofiler provides a GUI that you can use to profile your application. Xprofiler generates a graphical display of your application's performance, as opposed to a text-based report. Xprofiler also lets you profile your application at the source statement level.

From the Xprofiler GUI, you can use all of the same command line flags as **gprof**, as well as some additional flags that are unique to Xprofiler.

Compiling Applications to be Profiled

To use Xprofiler, you must compile and link your application with the **-pg** flag of the compiler command. This applies regardless of whether you are compiling a serial or parallel application. You can compile and link your application all at once, or perform the compile and link operations separately. The following is an example of how you would compile and link all at once:

```
cc -pg -o foo foo.c
```

The following is an example of how you would first compile your application and then link it. To compile, do the following:

```
cc -pg -c foo.c
```

To link, do the following:

```
cc -pg -o foo foo.o
```

Notice that when you compile and link separately, you must use the **-pg** flag with *both* the compile and link commands.

The **-pg** flag compiles and links the application so that when you run it, the CPU usage data is written to one or more output files. For a serial application, this output consists of only one file called **gmon.out**, by default. For parallel applications, the output is written into multiple files, one for each task that is running in the application. To prevent each output file from overwriting the others, the task ID is appended to each **gmon.out** file (for example: **gmon.out.10**).

Note: The **-pg** flag is not a combination of the **-p** and the **-g** compiling flags.

To get a complete picture of your parallel application's performance, you must indicate all of its **gmon.out** files when you load the application into Xprofiler. When you specify more than one **gmon.out** file, Xprofiler shows you the sum of the profile information contained in each file.

The Xprofiler GUI lets you view included functions. Your application must also be compiled with the **-g** flag in order for Xprofiler to display the included functions.

In addition to the **-pg** flag, the **-g** flag is also required for source-statement profiling.

Xprofiler Installation Information

This section contains Xprofiler system requirements, limitations, and information about installing Xprofiler. It also lists the files and directories that are created by installing Xprofiler.

Preinstallation Information

The following are hardware and software requirements for Xprofiler:

Software requirements:

- X-Windows
- X11.Dt.lib 4.2.1.0 or later, if you want to run Xprofiler in the Common Desktop Environment (CDE)

Disk space requirements:

- 6500 512-byte blocks in the `/usr` directory

Limitations

Although it is not required to install Xprofiler on every node, it is advisable to install it on at least one node in each group of nodes that have the same software library levels.

If users plan to collect a **gmon.out** file on one processor and then use Xprofiler to analyze the data on another processor, they should be aware that some shared (system) libraries may not be the same on the two processors. This situation may result in different function-call tree displays for shared libraries.

Installing Xprofiler

There are two methods to install Xprofiler. One method is by using the **installp** command. The other is by using SMIT.

Using the installp Command

To install Xprofiler, type:

```
installp -a -I -X -d device_name xprofiler
```

Using SMIT

To install Xprofiler using SMIT, do the following:

1. Insert the distribution media in the installation device (unless you are installing over a network).
2. Enter the following:

```
smit install_latest
```

This command opens the SMIT panel for installing software.

3. Press **List**. A panel lists the available INPUT devices and directories for software.
4. Select the installation device or directory from the list of available INPUT devices. The original SMIT panel indicates your selection.
5. Press **Do**. The SMIT panel displays the default installation parameters.
6. Type:

```
xprofiler
```

in the **SOFTWARE to install** field and press **Enter**.

7. Once the installation is complete, press **F10** to exit SMIT.

Directories and Files Created by Xprofiler

Installing Xprofiler creates the directories and files shown in the following table:

Table 1. Xprofiler directories and files installed

Directory or file	Description
/usr/lib/nls/msg/En_US/xprofiler.cat	Message catalog for Xprofiler
/usr/lib/nls/msg/en_US/xprofiler.cat	
/usr/lib/nls/msg/C/xprofiler.cat	
/usr/xprofiler/defaults/Xprofiler.ad	Defaults file for X-Windows and Motif resource variables
/usr/xprofiler/bin/.startup_script	Startup script for Xprofiler
/usr/xprofiler/bin/xprofiler	Xprofiler exec file
/usr/xprofiler/help/en_US/xprofiler.sdl	Online help
/usr/xprofiler/help/en_US/xprofiler_msg.sdl	
/usr/xprofiler/help/en_US/graphics	
/usr/xprofiler/README/xprofiler.README	Installation readme file
/usr/xprofiler/samples	Directory containing sample programs

The following symbolic link is made during the installation process of Xprofiler:

This link:	To:
/usr/lpp/X11/lib/X11/app-defaults/Xprofiler	/usr/xprofiler/defaults/Xprofiler.ad
/usr/bin/xprofiler	/usr/xprofiler/bin.startup_script

Starting the Xprofiler GUI

To start Xprofiler, enter the **xprofiler** command on the command line. You must also specify the binary executable file, one or more profile data files, and optionally, one or more flags, which you can do in one of two ways. You can either specify the files and flags on the command line along with the **xprofiler** command, or you can enter the **xprofiler** command alone, then specify the files and flags from within the GUI.

You will have more than one **gmon.out** file if you are profiling a parallel application, because a **gmon.out** file is created for each task in the application when it is run. If you are running a serial application, there may be times when you want to summarize the profiling results from multiple runs of the application. In these cases, you must specify each of the profile data files you want to profile with Xprofiler.

To start Xprofiler and specify the binary executable file, one or more profile data files, and one or more flags, type:

```
xprofiler a.out gmon.out... [flag...]
```

where: **a.out** is the binary executable file, **gmon.out...** is the name of your profile data file (or files), and **flag...** is one or more of the flags listed in the following section on Xprofiler command-line flags.

Xprofiler Command-line Flags

You can specify the same command-line flags with the **xprofiler** command that you do with **gprof**, as well as one additional flag (**-disp_max**), which is specific to Xprofiler. The command-line flags let you control the way Xprofiler displays the profiled output.

You can specify the flags in Table 2 from the command line or from the Xprofiler GUI (see “Specifying Command Line Options (from the GUI)” on page 14 for more information).

Table 2. Xprofiler command-line flags

Use this flag:	To:	For example:
-a	Add alternative paths to search for source code and library files, or changes the current path search order. When using this flag, you can use the “at” symbol (@) to represent the default file path, in order to specify that other paths be searched before the default path.	To set an alternative file search path so that Xprofiler searches pathA , the default path, then pathB , type: xprofiler -a pathA:@:pathB
-b	Suppress the printing of the field descriptions for the Flat Profile , Call Graph Profile , and Function Index reports when they are written to a file with the Save As option of the File menu.	Type: xprofiler -b a.out gmon.out
-c	Load the specified configuration file. If this flag is used on the command line, the configuration file name specified with it will appear in the Configuration File (-c) : text field in Load Files Dialog window and in the Selection field of the Load Configuration File Dialog window. When both the -c and -disp_max flags are specified on the command line, the -disp_max flag is ignored, but the value that was specified with it will appear in the Initial Display (-disp_max) : field in the Load Files Dialog window the next time this window is opened.	To load the configuration file myfile.cfg , type: xprofiler a.out gmon.out -c myfile.cfg
-disp_max	Set the number of function boxes that Xprofiler initially displays in the function call tree. The value supplied with this flag can be any integer between 0 and 5000. Xprofiler displays the function boxes for the most CPU-intensive functions through the number you specify. For example, if you specify 50, Xprofiler displays the function boxes for the 50 functions in your program with the highest CPU usage. After this, you can change the number of function boxes that are displayed using the Filter menu options. This flag has no effect on the content of any of the Xprofiler reports.	To display the function boxes for the 50 most CPU-intensive functions in the function call tree, type: xprofiler -disp_max 50 a.out gmon.out
-e	<p>Deemphasize the general appearance of the function box for the specified function in the function call tree, and limits the number of entries for this function in the Call Graph Profile report. This also applies to the specified function’s descendants, as long as they have not been called by non-specified functions.</p> <p>In the function call tree, the function box for the specified function is made unavailable. The box size and the content of the label remain the same. This also applies to descendant functions, as long as they have not been called by non-specified functions.</p> <p>In the Call Graph Profile report, an entry for a specified function only appears where it is a child of another function, or as a parent of a function that also has at least one non-specified function as its parent. The information for this entry remains unchanged. Entries for descendants of the specified function do not appear unless they have been called by at least one non-specified function in the program.</p>	To deemphasize the appearance of the function boxes for foo and bar and their qualifying descendants in the function call tree, and limit their entries in the Call Graph Profile report, type: xprofiler -e foo -e bar a.out gmon.out

Table 2. Xprofiler command-line flags (continued)

Use this flag:	To:	For example:
<p>-E</p>	<p>Change the general appearance and label information of the function box for the specified function in the function call tree. This flag also limits the number of entries for this function in the Call Graph Profile report, and changes the CPU data associated with them. These results also apply to the specified function's descendants, as long as they have not been called by non-specified functions in the program.</p> <p>In the function call tree, the function box for the specified function is made unavailable, and the box size and shape also changes so that it appears as a square of the smallest allowable size. In addition, the CPU time shown in the function box label, appears as 0. The same applies to function boxes for descendant functions, as long as they have not been called by non-specified functions. This flag also causes the CPU time spent by the specified function to be deducted from the CPU total on the left in the label of the function box for each of the specified function's ancestors.</p> <p>In the Call Graph Profile report, an entry for the specified function only appears where it is a child of another function, or as a parent of a function that also has at least one non-specified function as its parent. When this is the case, the time in the self and descendants columns for this entry is set to 0. In addition, the amount of time that was in the descendants column for the specified function is subtracted from the time listed under the descendants column for the profiled function. As a result, be aware that the value listed in the % time column for most profiled functions in this report will change.</p>	<p>To change the display and label information for foo and bar, as well as their qualifying descendants in the function call tree, and limit their entries and data in the Call Graph Profile report, type: <code>xprofiler -E foo -E bar a.out gmon.out</code></p>
<p>-f</p>	<p>Deemphasize the general appearance of all function boxes in the function call tree, <i>except</i> for that of the specified function and its descendants. In addition, the number of entries in the Call Graph Profile report for the non-specified functions and non-descendant functions is limited. The -f flag overrides the -e flag.</p> <p>In the function call tree, all function boxes <i>except</i> for that of the specified function and its descendants are made unavailable. The size of these boxes and the content of their labels remain the same. For the specified function and its descendants, the appearance of the function boxes and labels remain the same.</p> <p>In the Call Graph Profile report, an entry for a non-specified or non-descendant function only appears where it is a parent or child of a specified function or one of its descendants. All information for this entry remains the same.</p>	<p>To deemphasize the display of function boxes for all functions in the function call tree <i>except</i> for foo, bar, and their descendants, and limit their types of entries in the Call Graph Profile report, type: <code>xprofiler -f foo -f bar a.out gmon.out</code></p>

Table 2. Xprofiler command-line flags (continued)

Use this flag:	To:	For example:
-F	<p>Change the general appearance and label information of all function boxes in the function call tree <i>except</i> for that of the specified function and its descendants. In addition, the number of entries in the Call Graph Profile report for the non-specified and non-descendant functions is limited, and the CPU data associated with them is changed. The -F flag overrides the -E flag.</p> <p>In the function call tree, the function box for the specified function are made unavailable, and its size and shape also changes so that it appears as a square of the smallest allowable size. In addition, the CPU time shown in the function box label, appears as 0.</p> <p>In the Call Graph Profile report, an entry for a non-specified or non-descendant function only appears where it is a parent or child of a specified function or one of its descendants. When this is the case, the time in the self and descendants columns for this entry is set to 0. As a result, be aware that the value listed in the % time column for most profiled functions in this report will change.</p>	<p>To change the display and label information of the function boxes for all functions <i>except</i> the functions foo and bar and their descendants, and limit their types of entries and data in the Call Graph Profile report, type:</p> <pre>xprofiler -F foo -F bar a.out gmon.out</pre>
-h -?	Display the xprofiler command's usage statement.	<pre>xprofiler -h</pre> <p>Usage: xprofiler [program] [-b] [-h] [-s] [-z] [-a path(s)] [-c file] [-L pathname] [[-e function]...] [[-E function]...] [[-f function]...] [[-F function]...] [-disp_max number_of_functions] [[gmon.out]...]</p>
-L	Specify an alternative path name for locating shared libraries. If you plan to specify multiple paths, use the Set File Search Path option of the File menu on the Xprofiler GUI. See "Setting the File Search Sequence" on page 19 for more information.	To specify /lib/profiled/libc.a:shr.o as an alternative path name for your shared libraries, type: <pre>xprofiler -L /lib/profiled/libc.a:shr.o</pre>
-s	Produce the gmon.sum profile data file (if multiple gmon.out files are specified when Xprofiler is started). The gmon.sum file represents the sum of the profile information in all the specified profile files. Note that if you specify a single gmon.out file, the gmon.sum file contains the same data as the gmon.out file.	To write the sum of the data from three profile data files, gmon.out.1 , gmon.out.2 , and gmon.out.3 , into a file called gmon.sum , type: <pre>xprofiler -s a.out gmon.out.1 gmon.out.2 gmon.out.3</pre>
-z	Include functions that have both zero CPU usage and no call counts in the Flat Profile , Call Graph Profile , and Function Index reports. A function will not have a call count if the file that contains its definition was not compiled with the -pg flag, which is common with system library files.	To include all functions used by the application that have zero CPU usage and no call counts in the Flat Profile , Call Graph Profile , and Function Index reports, type: <pre>xprofiler -z a.out gmon.out</pre>

After you enter the **xprofiler** command, the Xprofiler main window appears and displays your application's data.

Loading Files from the Xprofiler GUI

If you enter the **xprofiler** command on its own, you can then specify an executable file, one or more profile data file, and any flags, from within the Xprofiler GUI. You use the **Load File** option of the **File** menu to do this.

If you enter the **xprofiler -h** or **xprofiler -?** command, Xprofiler displays the usage statement for the command and then exits.

When you enter the **xprofiler** command alone, the Xprofiler main window appears. Because you did not load an executable file or specify a profile data file, the window will be empty, as shown below.



Figure 1. The Xprofiler main window.. The screen capture below is an empty Xprofiler window. All that is visible is a menu bar at the top with dropdowns for File, View, Filter, Report, Utility, and Help. Also, there is a description box at the bottom that contains the following text: Empty display, use "File->Load Files" option to load a valid file set.

From the Xprofiler GUI, select **File**, then **Load File** from the menu bar. The Load Files Dialog window will appear, as shown below.

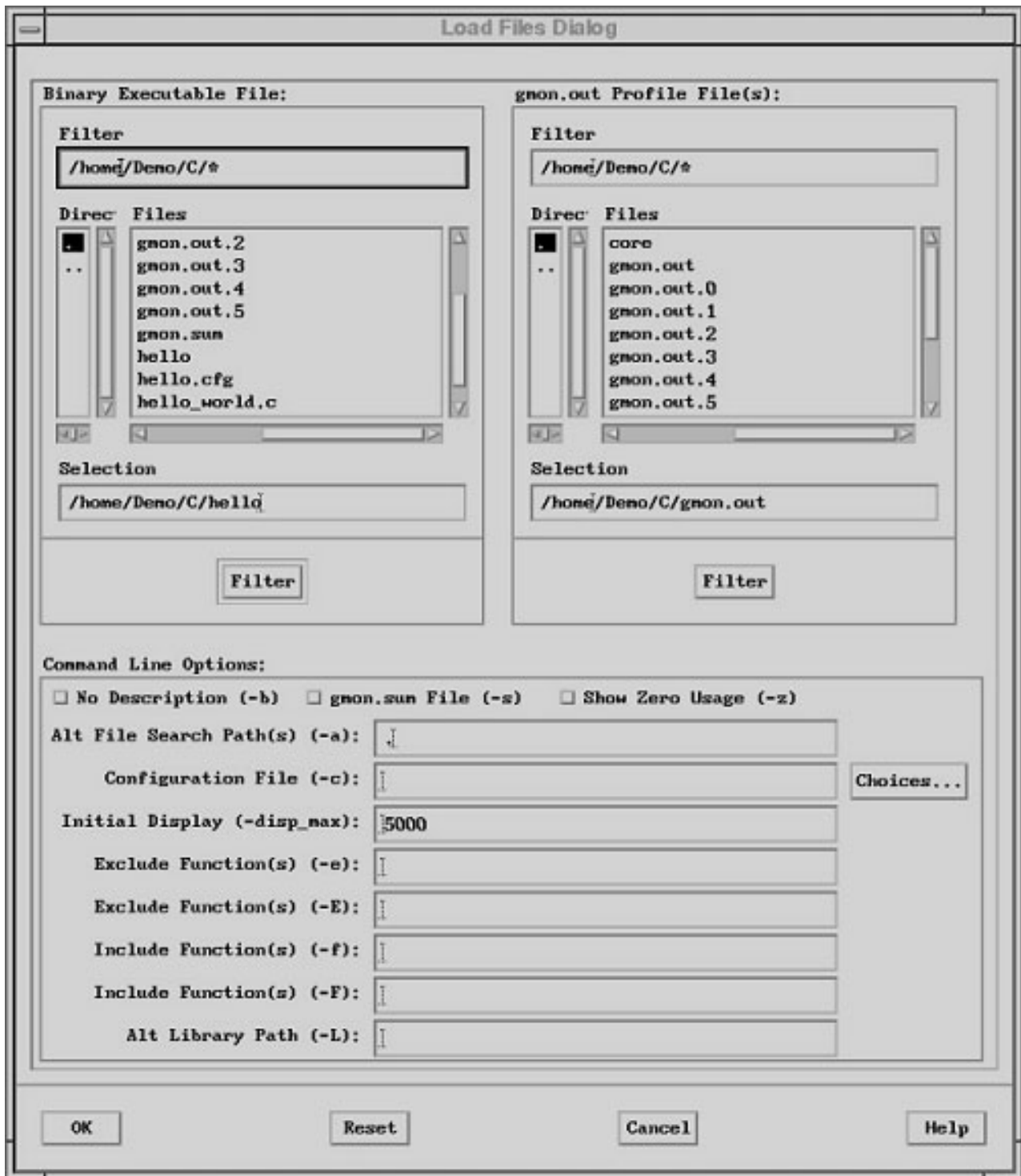

Figure 2. The Load Files Dialog window. The screen capture below is a Load Files Dialog box that is split into three different sections. There are two boxes, side by side at the top, and one long box at the bottom that are described in more detail in the next three figures.

The Load Files Dialog window lets you specify your application's executable file and its corresponding profile data (**gmon.out**) files. When you load a file, you can also specify the various command-line options that let you control the way Xprofiler displays the profiled data.

To load the files for the application you want to profile, you must specify the following:

- the binary executable file
- one or more profile data files

Optionally, you can also specify one or more command-line flags.

The Binary Executable File

You specify the binary executable file from the **Binary Executable File:** area of the Load Files Dialog window.

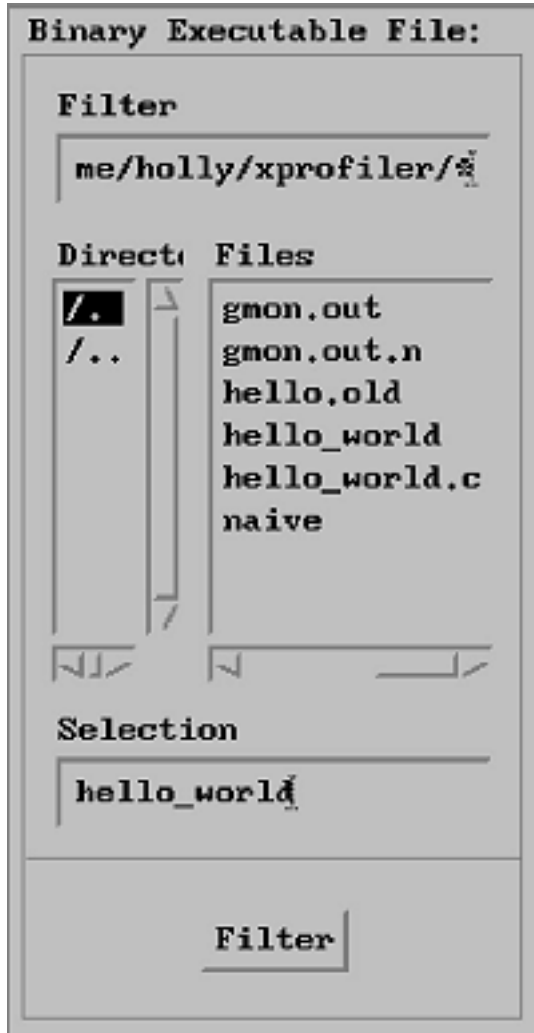

Figure 3. The Binary Executable File dialog. The screen capture below is the Binary Executable File dialog box of the Load Files Dialog window. There is a Filter box at the top that shows the path of the file to load. Underneath the Filter box, there are two selection boxes, side by side that are labeled Directory and Files. The one on the left is to select the Directory in which to locate the executable file, and the one on the right is a listing of the files that are contained in the directory that is selected in the Directory selection box. There is a Selection box that shows the file selected and at the bottom there is a Filter button.

Use the scroll bars of the **Directories** and **Files** selection boxes to locate the executable file you want to load. By default, all of the files in the directory from which you called Xprofiler appear in the **Files** selection box.

To make locating your binary executable files easier, the **Binary Executable File:** area includes a **Filter** button. Filtering lets you limit the files that are displayed in the **Files** selection box to those of a specific directory or of a specific type. For information about filtering, see “Filtering what You See” on page 27.

Profile Data Files

You specify one or more profile data files from the **gmon.out Profile Data File(s)** area of the Load Files Dialog window.

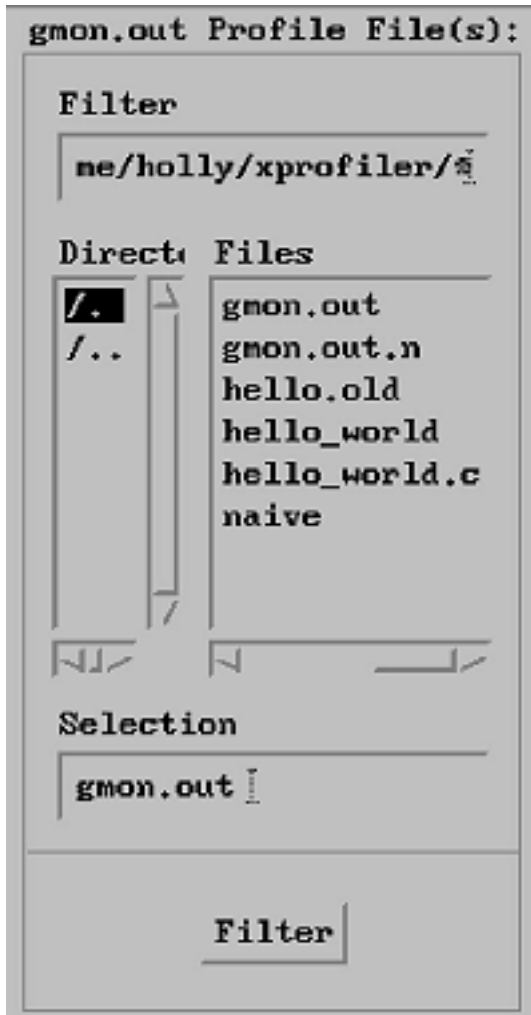

Figure 4. The **gmon.out Profile Data File** area. The screen capture below is the **gmon.out Profile Data File(s)** dialog box of the Load Files Dialog window. There is a **Filter** box at the top that shows the path of the file to use as input. Underneath the **Filter** box, there are two selection boxes, side by side that are labeled **Directory** and **Files**. The one on the left is to select the **Directory** in which to locate the profile file, and the one on the right is a listing of the files that are contained in the **Directory** that is selected in the **Directory** selection box. There is a **Selection** box that shows the file selected and at the bottom there is a **Filter** button.

When you start Xprofiler using the **xprofiler** command, you are not required to indicate the name of the profile data file. If you do not specify a profile data file, Xprofiler searches your directory for the presence of a file named **gmon.out** and, if found, places it in the **Selection** field of the **gmon.out Profile Data File(s)** area, as the default. Xprofiler then uses this file as input, even if it is not related to the binary executable file you specify. Because this will cause Xprofiler to display incorrect data, it is important that you enter the correct file into this field. If the profile data file you want to use is named something other than what appears in the **Selection** field, you must replace it with the correct file name.

Use the scroll bars of the **Directories** and **Files** selection boxes to locate one or more of the profile data (**gmon.out**) files you want to specify. The file you use does not have to be named **gmon.out**, and you can specify more than one profile data file.

To make locating your output files easier, the **gmon.out Profile Data File(s)** area includes a **Filter** button. Filtering lets you limit the files that are displayed in the **Files** selection box to those in a specific directory or of a specific type. For information about filtering, see “Filtering what You See” on page 27.

Specifying Command Line Options (from the GUI)

Specify command-line flags from the **Command Line Options** area of the Load Files Dialog window, which looks similar to the following:

Command Line Options:

No Description (-b) gmon.sum File (-s) Show Zero Usage (-z)

Alt File Search Path(s) (-a):

Configuration File (-c): Choices...

Initial Display (-disp_max):

Exclude Function(s) (-e):

Exclude Function(s) (-E):

Include Function(s) (-f):

Include Function(s) (-F):

Alt Library Path (-L):

Figure 5. The Command Line Options area. The screen capture below is the Command Line Options box of the Load Files Dialog window. There are three check boxes side by side at the top: No description (-b), gmon.sum File (-s), and Show Zero Usage (-z). Below that, there are eight boxes corresponding to the eight Xprofiler GUI command-line flags, Alt File Search Paths (-a), Configuration File (-c), Initial Display (-disp_max), Exclude Functions (-e), Exclude Functions (-E), Include Functions (-f), Include Functions (-F), and Alt Library Path (-L), that are described in great detail below. There is a Choices button next to the Configuration File (-c) box.

You can specify one or more flags as follows:

Table 3. Xprofiler GUI command-line flags

Use this flag:	To:	For example:
-a (field)	<p>Add alternative paths to search for source code and library files, or changes the current path search order. After clicking the OK button, any modifications to this field are also made to the Enter Alt File Search Paths: field of the Alt File Search Path Dialog window. If both the Load Files Dialog window and the Alt File Search Path Dialog window are opened at the same time, when you make path changes in the Alt File Search Path Dialog window and click OK, these changes are also made to the Load Files Dialog window. Also, when both of these windows are open at the same time, clicking the OK or Cancel buttons in the Load Files Dialog window causes both windows to close. If you want to restore the Alt File Search Path(s) (-a): field to the same state as when the Load Files Dialog window was opened, click the Reset button.</p> <p>You can use the “at” symbol (@) with this flag to represent the default file path, in order to specify that other paths be searched before the default path.</p>	<p>To set an alternative file search path so that Xprofiler searches pathA, the default path, then pathB, type pathA:@:pathB in the Alt File Search Path(s) (-a) field.</p>
-b (button)	<p>Suppress the printing of the field descriptions for the Flat Profile, Call Graph Profile, and Function Index reports when they are written to a file with the Save As option of the File menu.</p>	<p>To suppress printing of the field descriptions for the Flat Profile, Call Graph Profile, and Function Index reports in the saved file, set the -b button to the pressed-in position.</p>
-c (field)	<p>Load the specified configuration file. If the -c option was used on the command line, or a configuration file had been previously loaded with the Load Files Dialog window or the Load Configuration File Dialog window, the name of the most recently loaded file will appear in the Configuration File (-c): text field in the Load Files Dialog window, as well as the Selection field of Load Files Dialog window. If the Load Files Dialog window and the Load Configuration File Dialog window are open at the same time, when you specify a configuration file in the Load Configuration File Dialog window and then click the OK button, the name of the specified file also appears in the Load Files Dialog window. Also, when both of these windows are open at the same time, clicking the OK or Cancel button in the Load Files Dialog window causes both windows to close. When entries are made to both the Configuration File (-c): and Initial Display (-disp_max): fields in the Load Files Dialog window, the value in the Initial Display (-disp_max): field is ignored, but is retained the next time this window is opened. If you want to retrieve the file name that was in the Configuration File (-c): field when the Load Files Dialog window was opened, click the Reset button.</p>	<p>To load the configuration file myfile.cfg, type myfile.cfg in the Configuration File (-c) field.</p>

Table 3. Xprofiler GUI command-line flags (continued)

Use this flag:	To:	For example:
<p>-disp_max (field)</p>	<p>Set the number of function boxes that Xprofiler initially displays in the function call tree. The value supplied with this flag can be any integer between 0 and 5000. Xprofiler displays the function boxes for the most CPU-intensive functions through the number you specify. For example, if you specify 50, Xprofiler displays the function boxes for the 50 functions in your program with the highest CPU usage. After this, you can change the number of function boxes that are displayed using the Filter menu options. This flag has no effect on the content of any of the Xprofiler reports.</p>	<p>To display the function boxes for the 50 most CPU-intensive functions in the function call tree, type 50 in the Init Display (-disp_max) field.</p>
<p>-e (field)</p>	<p>Deemphasize the general appearance of the function box for the specified function in the function call tree, and limits the number of entries for this function in the Call Graph Profile report. This also applies to the specified function's descendants, as long as they have not been called by non-specified functions.</p> <p>In the function call tree, the function box for the specified function is made unavailable. The box size and the content of the label remain the same. This also applies to descendant functions, as long as they have not been called by non-specified functions.</p> <p>In the Call Graph Profile report, an entry for a specified function only appears where it is a child of another function, or as a parent of a function that also has at least one non-specified function as its parent. The information for this entry remains unchanged. Entries for descendants of the specified function do not appear unless they have been called by at least one non-specified function in the program.</p>	<p>To deemphasize the appearance of the function boxes for foo and bar and their qualifying descendants in the function call tree, and limit their entries in the Call Graph Profile report, type foo and bar in the Exclude Routines (-e) field.</p> <p>Multiple functions are separated by a space.</p>

Table 3. Xprofiler GUI command-line flags (continued)

Use this flag:	To:	For example:
<p>-E (field)</p>	<p>Change the general appearance and label information of the function box for the specified function in the function call tree. This flag also limits the number of entries for this function in the Call Graph Profile report, and changes the CPU data associated with them. These results also apply to the specified function's descendants, as long as they have not been called by non-specified functions in the program.</p> <p>In the function call tree, the function box for the specified function appears greyed out, and the box size and shape also changes so that it appears as a square of the smallest allowable size. In addition, the CPU time shown in the function box label, appears as 0. The same applies to function boxes for descendant functions, as long as they have not been called by non-specified functions. This flag also causes the CPU time spent by the specified function to be deducted from the CPU total on the left in the label of the function box for each of the specified function's ancestors.</p> <p>In the Call Graph Profile report, an entry for the specified function only appears where it is a child of another function, or as a parent of a function that also has at least one non-specified function as its parent. When this is the case, the time in the self and descendants columns for this entry is set to 0. In addition, the amount of time that was in the descendants column for the specified function is subtracted from the time listed under the descendants column for the profiled function. As a result, be aware that the value listed in the % time column for most profiled functions in this report will change.</p>	<p>To change the display and label information for foo and bar and their qualifying descendants in the function call tree, and limit their entries and data in the Call Graph Profile report, type <code>foo bar</code> in the Exclude Routines (-E) field.</p> <p>Multiple functions are separated by a space.</p>

Table 3. Xprofiler GUI command-line flags (continued)

Use this flag:	To:	For example:
-f (field)	<p>Deemphasize the general appearance of all function boxes in the function call tree, <i>except</i> for that of the specified function and its descendants. In addition, the number of entries in the Call Graph Profile report for the non-specified functions and non-descendant functions is limited. The -f flag overrides the -e flag.</p> <p>In the function call tree, all function boxes <i>except</i> for that of the specified function and its descendants are made unavailable. The size of these boxes and the content of their labels remain the same. For the specified function and its descendants, the appearance of the function boxes and labels remain the same.</p> <p>In the Call Graph Profile report, an entry for a non-specified or non-descendant function only appears where it is a parent or child of a specified function or one of its descendants. All information for this entry remains the same.</p>	<p>To deemphasize the display of function boxes for all functions in the function call tree <i>except</i> for foo and bar and their descendants, and limit their types of entries in the Call Graph Profile report, type foo bar in the Include Routines (-f) field.</p> <p>Multiple functions are separated by a space.</p>
-F (field)	<p>Change the general appearance and label information of all function boxes in the function call tree <i>except</i> for that of the specified function and its descendants. In addition, the number of entries in the Call Graph Profile report for the non-specified and non-descendant functions is limited, and the CPU data associated with them is changed. The -F flag overrides the -E flag.</p> <p>In the function call tree, the function box for the specified function is made unavailable, and its size and shape also changes so that it appears as a square of the smallest allowable size. In addition, the CPU time shown in the function box label, appears as 0.</p> <p>In the Call Graph Profile report, an entry for a non-specified or non-descendant function only appears where it is a parent or child of a specified function or one of its descendants. When this is the case, the time in the self and descendants columns for this entry is set to 0. As a result, be aware that the value listed in the % time column for most profiled functions in this report will change.</p>	<p>To change the display and label information of the function boxes for all functions <i>except</i> the functions foo and bar and their descendants, and limit their types of entries and data in the Call Graph Profile report, type foo bar in the Include Routines (-F) field.</p> <p>Multiple functions are separated by a space.</p>
-L (field)	<p>Set the alternative path name for locating shared objects. If you plan to specify multiple paths, use the Set File Search Path option of the File menu on the Xprofiler GUI. See “Setting the File Search Sequence” on page 19 for information.</p>	<p>To specify /lib/profiled/libc.a:shr.o as an alternative path name for your shared libraries, type /lib/profiled/libc.a:shr.o in this field.</p>

Table 3. Xprofiler GUI command-line flags (continued)

Use this flag:	To:	For example:
-s (button)	Produces the gmon.sum profile data file, if multiple gmon.out files are specified when Xprofiler is started. The gmon.sum file represents the sum of the profile information in all the specified profile files. Note that if you specify a single gmon.out file, the gmon.sum file contains the same data as the gmon.out file.	To write the sum of the data from three profile data files, gmon.out.1 , gmon.out.2 , and gmon.out.3 , into a file called gmon.sum , set the -s button to the pressed-in position.
-z (button)	Includes functions that have both zero CPU usage and no call counts in the Flat Profile , Call Graph Profile , and Function Index reports. A function will not have a call count if the file that contains its definition was not compiled with the -pg flag, which is common with system library files.	To include all functions used by the application that have zero CPU usage and no call counts in the Flat Profile , Call Graph Profile , and Function Index reports, set the -z button to the pressed-in position.

After you have specified the binary executable file, one or more profile data files, and any command-line flags you want to use, click the **OK** button to save the changes and close the window. Xprofiler loads your application and displays its performance data.

Setting the File Search Sequence

You can specify where you want Xprofiler to look for your library files and source code files by using the **Set File Search Paths** option of the **File** menu. By default, Xprofiler searches the default paths first and then any alternative paths you specify.

Default Paths

For library files, Xprofiler uses the paths recorded in the specified **gmon.out** files. If you use the **-L** flag, the path you specify with it will be used instead of those in the **gmon.out** files.

Note: The **-L** flag allows only one path to be specified, and you can use this flag only once.

For source code files, the paths recorded in the specified **a.out** file are used.

Alternative Paths

You specify the alternative paths with the **Set File Search Paths** option of the **File** menu.

For library files, if everything else failed, the search will be extended to the path (or paths) specified by the **LIBPATH** environment variable associated with the executable file.

To specify alternative paths, do the following:

1. Select the **File** menu, and then the **Set File Search Paths** option. The Alt File Search Path Dialog window appears.
2. Enter the name of the path in the **Enter Alt File Search Path(s)** text field. You can specify more than one path by separating each path name with a colon (:) or a space.

Notes:

- a. You can use the “at” symbol (@) with this option to represent the default file path, in order to specify that other paths be searched before the default path. For example, to set the alternative file search paths so that Xprofiler searches **pathA**, the default path, then **pathB**, type **pathA:@:pathB** in the **Alt File Search Path(s) (-a)** field.
 - b. If @ is used in the alternative search path, the two buttons in the Alt File Search Path Dialog window will be unavailable, and will have no effect on the search order.
3. Click the **OK** button. The paths you specified in the text field become the alternative paths.

Changing the Search Sequence

You can change the order of the search sequence for library files and source code files using the **Set File Search Paths** option of the **File** menu. To change the search sequence:

1. Select the **File** menu, and then the **Set File Search Paths** option. The Alt File Search Path Dialog window appears.
2. To indicate that the file search should use alternative paths first, click the **Check alternative path(s) first** button.
3. Click **OK**. This changes the search sequence to the following:
 - a. Alternative paths
 - b. Default paths
 - c. Paths specified in LIBPATH (library files only)

To return the search sequence back to its default order, repeat steps 1 through 3, but in step 2, click the **Check default path(s) first** button. When the action is confirmed (by clicking **OK**), the search sequence will start with the default paths again.

If a file is found in one of the alternative paths or a path in LIBPATH, this path now becomes the default path for this file throughout the current Xprofiler session (until you exit this Xprofiler session or load a new set of data).

Understanding the Xprofiler Display

The primary difference between Xprofiler and the **gprof** command is that Xprofiler gives you a graphical picture of your application's CPU consumption in addition to textual data.

Xprofiler displays your profiled program in a single main window. It uses several types of graphical images to represent the relevant parts of your program. Functions appear as solid green boxes (called *function boxes*), and the calls between them appear as blue arrows (called *call arcs*). The function boxes and call arcs that belong to each library within your application appear within a fenced-in area called a *cluster box*.

Xprofiler Main Window

The Xprofiler main window contains a graphical representation of the functions and calls within your application, as well as their interrelationships. The window provides six menus, including one for online help.

When an application has been loaded, the Xprofiler main window looks similar to the following:

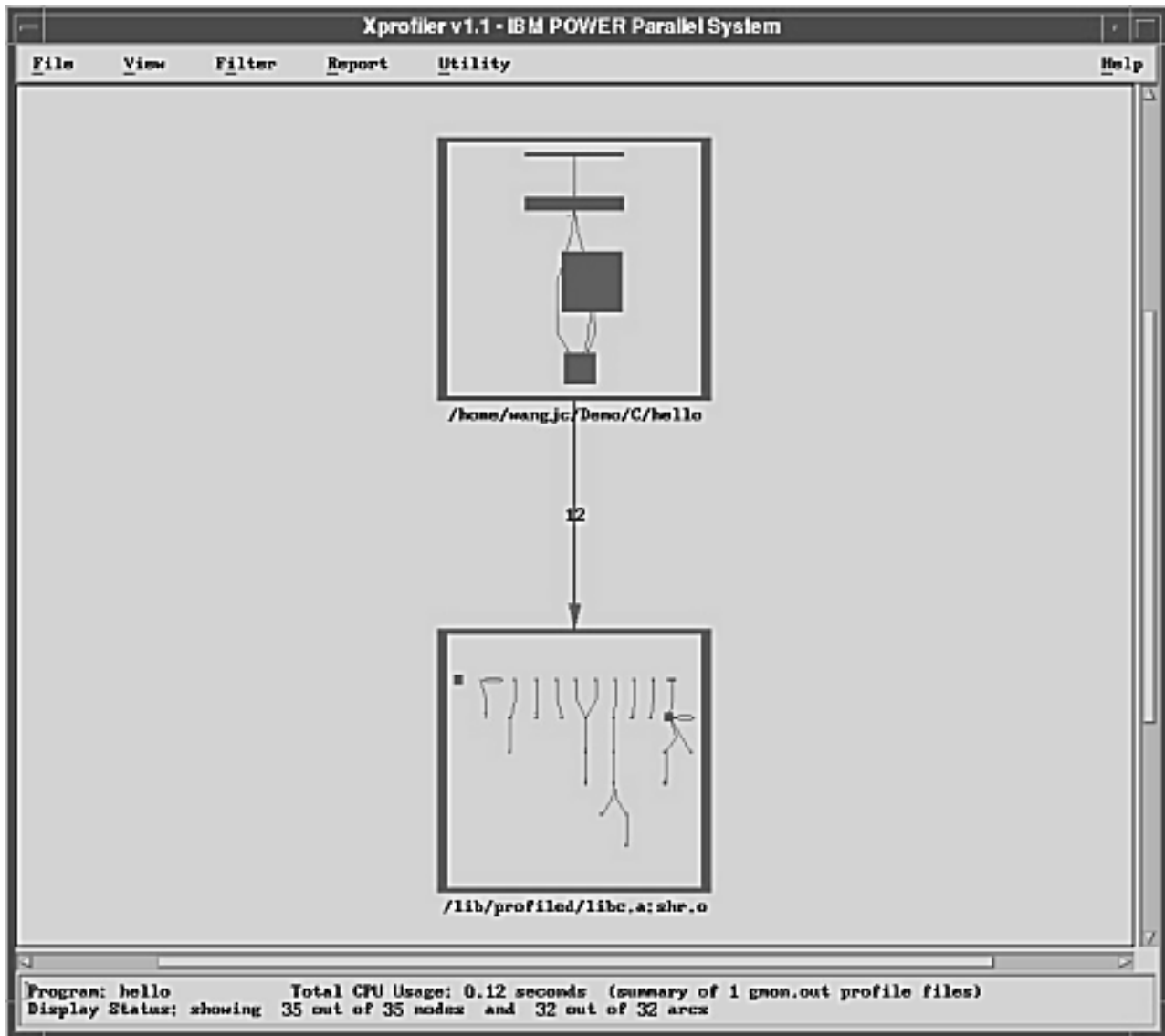

Figure 6. The Xprofiler main window with application loaded. The screen capture below shows one function box displaying a function call tree, with an arc pointing down to another function box displaying a function call tree in the Xprofiler main window.

In the main window, Xprofiler displays the *function call tree*. The function call tree displays the function boxes, call arcs, and cluster boxes that represent the functions within your application.

Note: When Xprofiler first opens, by default, the function boxes for your application will be *clustered* by library. A cluster box appears around each library, and the function boxes and arcs within the cluster box are reduced in size. To see more detail, you must uncluster the functions. To do this, select the **File** menu and then the **Uncluster Functions** option.

Xprofiler's Main Menus

The Xprofiler menus are as follows:

The File menu: The File menu lets you specify the executable (**a.out**) files and profile data (**gmon.out**) files that Xprofiler will use. It also lets you control how your files are accessed and saved.

The View menu: The View menu lets you focus on specific portions of the function call tree in order to get a better view of the application's critical areas.

The Filter menu: The Filter menu lets you add, remove, and change specific parts of the function call tree. By controlling what Xprofiler displays, you can focus on the objects that are most important to you.

The Report menu: The Report menu provides several types of profiled data in a textual and tabular format. In addition to presenting the profiled data, the options of the Report menu let you do the following:

- Display textual data
- Save it to a file
- View the corresponding source code
- Locate the corresponding function box or call arc in the function call tree

The Utility menu: The Utility menu contains one option, **Locate Function By Name**, which lets you highlight a particular function in the function call tree.

Xprofiler's Hidden Menus

The Function menu: The Function menu lets you perform a number of operations for any of the functions shown in the function call tree. You can access statistical data, look at source code, and control which functions are displayed.

The Function menu is not visible from the Xprofiler window. You access it by right-clicking on the function box of the function in which you are interested. By doing this, you open the Function menu, and select this function as well. Then, when you select actions from the Function menu, the actions are applied to this function.

The Arc menu: The Arc menu lets you locate the caller and callee functions for a particular *call arc*. A call arc is the representation of a call between two functions within the function call tree.

The Arc menu is not visible from the Xprofiler window. You access it by right-clicking on the call arc in which you are interested. By doing this, you open the Arc menu, and select that call arc as well. Then, when you perform actions with the Arc menu, they are applied to that call arc.

The Cluster Node menu: The Cluster Node menu lets you control the way your libraries are displayed by Xprofiler. To access the Cluster Node menu, the function boxes in the function call tree must first be clustered by library. For information about clustering and unclustering the function boxes of your application, see “Clustering Libraries” on page 32. When the function call tree is clustered, all the function boxes within each library appear within a *cluster box*.

The Cluster Node menu is not visible from the Xprofiler window. You access it by right-clicking on the edge of the cluster box in which you are interested. By doing this, you open the Cluster Node menu, and select that cluster as well. Then, when you perform actions with the Cluster Node menu, they are applied to the functions within that library cluster.

The Display Status Field

At the bottom of the Xprofiler window is a single field that provides the following information:

- Name of your application
- Number of **gmon.out** files used in this session
- Total amount of CPU used by the application
- Number of functions and calls in your application, and how many of these are currently displayed

How Functions are Represented

Functions are represented by solid green boxes in the function call tree. The size and shape of each function box indicates its CPU usage. The height of each function box represents the amount of CPU time it spent on executing itself. The width of each function box represents the amount of CPU time it spent executing itself, plus its descendant functions.

This type of representation is known as *summary mode*. In summary mode, the size and shape of each function box is determined by the total CPU time of multiple **gmon.out** files used on that function alone, and the total time used by the function and its descendant functions. A function box that is wide and flat represents a function that uses a relatively small amount of CPU on itself (it spends most of its time on its descendants). The function box for a function that spends most of its time executing only itself will be roughly square-shaped.

Functions can also be represented in *average mode*. In average mode, the size and shape of each function box is determined by the average CPU time used on that function alone, among all loaded **gmon.out** files, and the standard deviation of CPU time for that function among all loaded **gmon.out** files. The height of each function node represents the average CPU time, among all the input **gmon.out** files, used on the function itself. The width of each node represents the standard deviation of CPU time, among the **gmon.out** files, used on the function itself. The average mode representation is available only when more than one **gmon.out** file is entered. For more information about summary mode and average mode, see “Controlling the Representation of the Function Call Tree” on page 26.

Under each function box in the function call tree is a label that contains the name of the function and related CPU usage data. For information about the function box labels, see “Obtaining Basic Data” on page 37.

The following figure shows the function boxes for two functions, **sub1** and **printf**, as they would appear in the Xprofiler display.

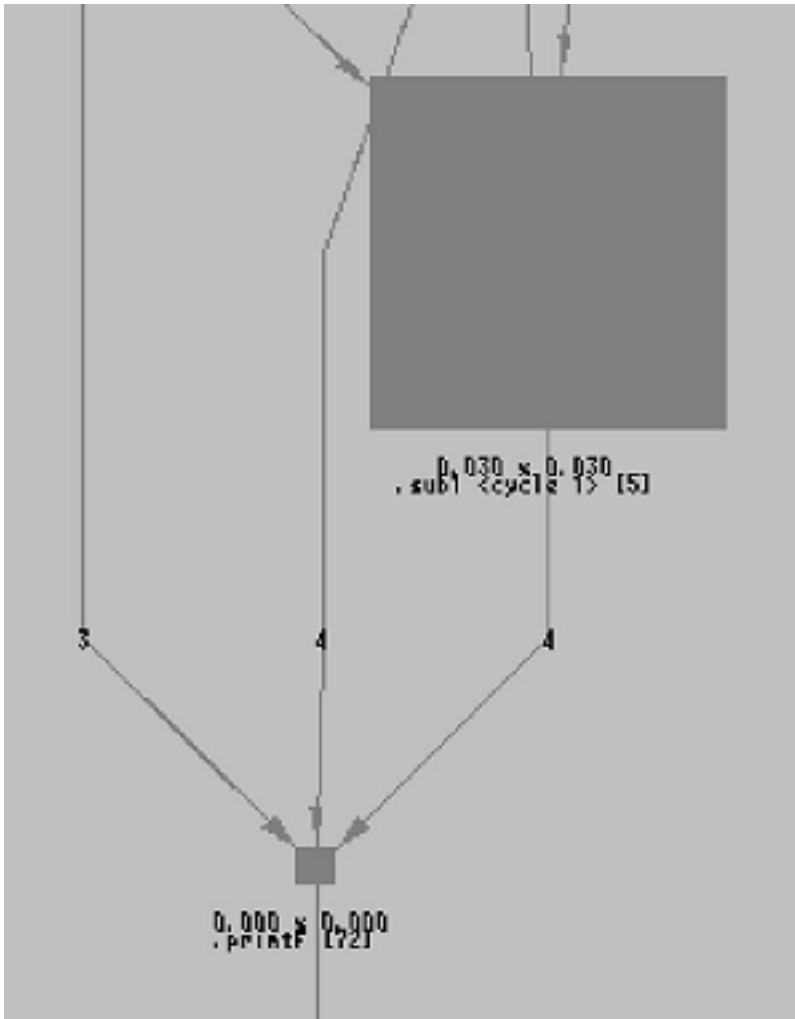

Figure 7. Function boxes and arcs in the Xprofiler display. The screen capture below shows a large function box for the `sub1` function at the top and a small function box for the `printf` function at the bottom.

Each function box has its own menu. To access it, place your mouse cursor over the function box of the function you are interested in and press the right mouse button. Each function also has an information box that lets you get basic performance numbers quickly. To access the information box, place your mouse cursor over the function box of the function you are interested in and press the left mouse button.

How Calls Between Functions are Depicted

The calls made between each of the functions in the function call tree are represented by blue arrows extending between their corresponding function boxes. These lines are called *call arcs*. Each call arc appears as a solid blue line between two functions. The arrowhead indicates the direction of the call; the function represented by the function box it points to is the one that receives the call. The function making the call is known as the *caller*, while the function receiving the call is known as the *callee*.

Each call arc includes a numeric label that indicates how many calls were exchanged between the two corresponding functions.

Each call arc has its own menu that lets you locate the function boxes for its caller and callee functions. To access it, place your mouse cursor over the call arc for the call in which you are interested, and press the right mouse button. Each call arc also has an information box that shows you the number of times the caller function called the callee function. To access the information box, place your mouse cursor over the call arc for the call in which you are interested, and press the left mouse button.

How Library Clusters are Represented

Xprofiler lets you collect the function boxes and call arcs that belong to each of your shared libraries into *cluster boxes*.

Because there will be a box around each library, the individual function boxes and call arcs will be difficult to see. If you want to see more detail, you must uncluster the function boxes. To do this, select the Filter menu and then the **Uncluster Functions** option.

When viewing function boxes within a cluster box, note that the size of each function box is relative to those of the other functions within the same library cluster. On the other hand, when all the libraries are unclustered, the size of each function box is relative to all the functions in the application (as shown in the function call tree).

Each library cluster has its own menu that lets you manipulate the cluster box. To access it, place your mouse cursor over the edge of the cluster box you are interested in, and press the right mouse button. Each cluster also has an information box that shows you the name of the library and the total CPU usage (in seconds) consumed by the functions within it. To access the information box, place your mouse cursor over the edge of the cluster box you are interested in and press the left mouse button.

Controlling how the Display is Updated

The **Utility** menu of the Overview Window lets you choose the mode in which the display is updated. The default is the **Immediate Update** option, which causes the display to show you the items in the highlight area as you are moving it around. The **Delayed Update** option, on the other hand, causes the display to be updated only when you have moved the highlight area over the area in which you are interested, and released the mouse button. The **Immediate Update** option applies only to what you see when you move the highlight area; it has no effect on the resizing of items in highlight area, which is always delayed.

Other Viewing Options

Xprofiler lets you change the way it displays the function call tree, based on your personal preferences.

Controlling the Graphic Style of the Function Call Tree

You can choose between two-dimensional and three-dimensional function boxes in the function call tree. The default style is two-dimensional. To change to three-dimensional, select the **View** menu, and then the **3-D Image** option. The function boxes in the function call tree now appear in three-dimensional format.

Controlling the Orientation of the Function Call Tree

You can choose to have Xprofiler display the function call tree in either top-to-bottom or left-to-right format. The default is top-to-bottom. To see the function call tree displayed in left-to-right format, select the **View** menu, and then the **Layout: Left→Right** option. The function call tree now displays in left-to-right format, as shown below.

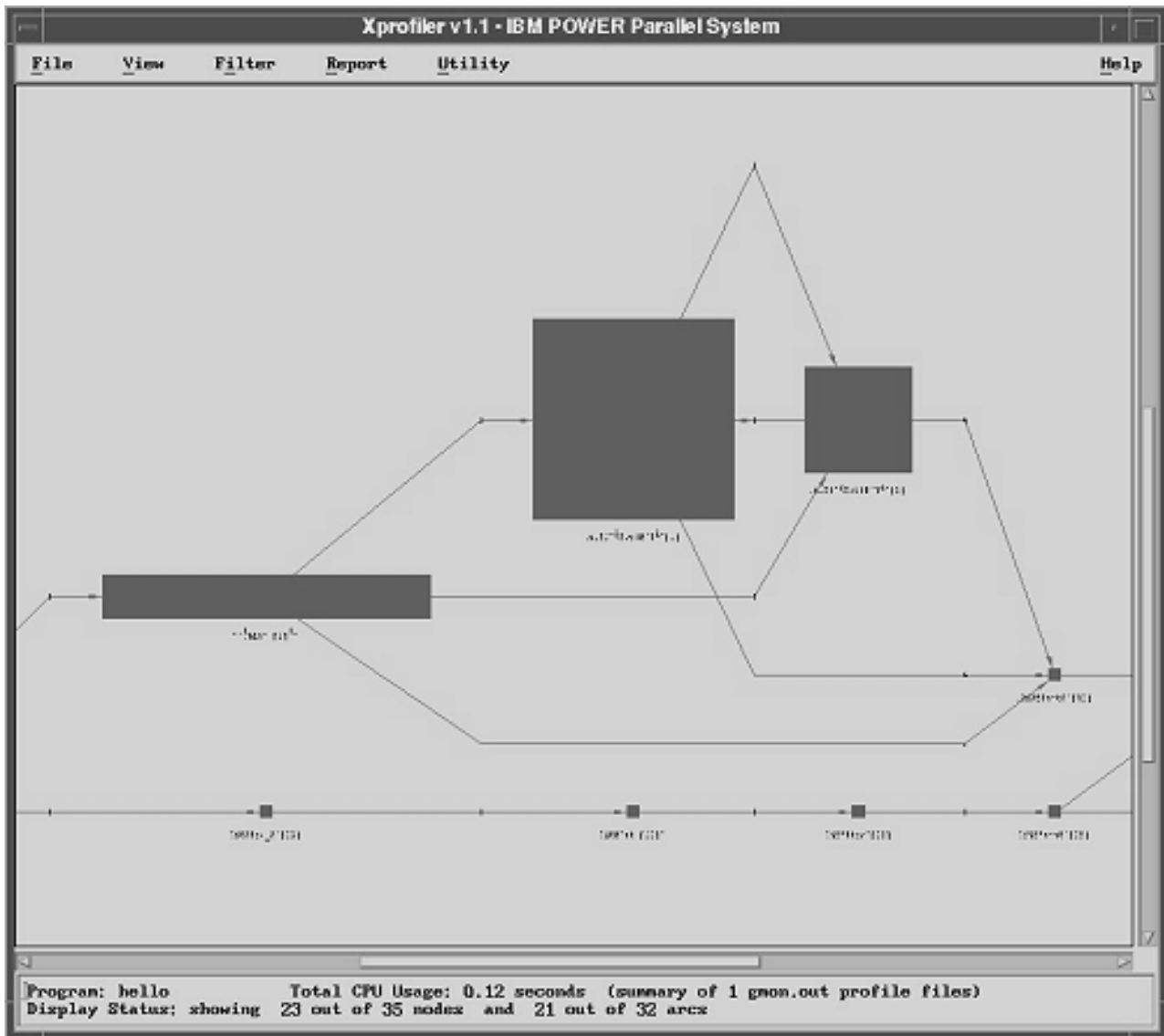

Figure 8. Left-to-right format. The screen capture below shows a function call tree with three different function boxes from left to right.

Controlling the Representation of the Function Call Tree

You can choose to have Xprofiler represent the function call tree in either *summary mode* or *average mode*.

When you select the **Summary Mode** option of the View menu, the size and shape of each function box is determined by the total CPU time of multiple **gmon.out** files used on that function alone, and the total time used by the function and its descendant functions. The height of each function node represents the total CPU time used on the function itself. The width of each node represents the total CPU time used on the function and its descendant functions. When the display is in summary mode, the **Summary Mode** option is unavailable and the **Average Mode** option is activated.

When you select the **Average Mode** option of the View menu, the size and shape of each function box is determined by the average CPU time used on that function alone, among all loaded **gmon.out** files, and the standard deviation of CPU time for that function among all loaded **gmon.out** files. The height of each

function node represents the average CPU time, among all the input **gmon.out** files, used on the function itself. The width of each node represents the standard deviation of CPU time, among the **gmon.out** files, used on the function itself.

The purpose of average mode is to reveal workload balancing problems when an application is involved with multiple **gmon.out** files. In general, a function node with large standard deviation has a wide width, and a node with small standard deviation has a slim width.

Both summary mode and average mode affect only the appearance of the function call tree and the labels associated with it. All the performance data in Xprofiler reports and code displays are always summary data. If only one **gmon.out** file is specified, **Summary Mode** and **Average Mode** will be unavailable, and the display is always in **Summary Mode**.

Filtering what You See

When Xprofiler first opens, the entire function call tree appears in the main window. This includes the function boxes and call arcs that belong to your executable file as well as the shared libraries that it uses. You can simplify what you see in the main window, and there are several ways to do this.

Note: Filtering options of the Filter menu let you change the appearance only of the function call tree. The performance data contained in the reports (through the Reports menu) is not affected.

Restoring the Status of the Function Call Tree

Xprofiler allows you to undo operations that involve adding or removing nodes and arcs from the function call tree. When you undo an operation, you reverse the effect of any operation which adds or removes function boxes or call arcs to the function call tree. When you select the **Undo** option, the function call tree is returned to its appearance just prior to the performance of the add or remove operation. To undo an operation, select the **Filter** menu, and then the **Undo** option. The function call tree is returned to its appearance just prior to the performance of the add or remove operation.

Whenever you invoke the **Undo** option, the function call tree loses its zoom focus and zooms all the way out to reveal the entire function call tree in the main display. When you start Xprofiler, the **Undo** option is unavailable. It is activated only after an add or remove operation involving the function call tree takes place. After you undo an operation, the option is made unavailable again until the next add or remove operation takes place.

The options that activate the **Undo** option include the following:

- In the main **File** menu:
 - Load Configuration
- In the main **Filter** menu:
 - Show Entire Call Tree
 - Hide All Library Calls
 - Add Library Calls
 - Filter by Function Names
 - Filter by CPU Time
 - Filter by Call Counts
- In the **Function** menu:
 - Immediate Parents
 - All Paths To
 - Immediate Children
 - All Paths From
 - All Functions on The Cycle
 - Show This Function Only
 - Hide This Function
 - Hide Descendant Functions

- Hide This & Descendant Functions

If a dialog such as the Load Configuration Dialog or the Filter by CPU Time Dialog is invoked and then canceled immediately, the status of the **Undo** option is not affected. After the option is available, it stays that way until you invoke it, or a new set of files is loaded into Xprofiler through the Load Files Dialog window.

Displaying the Entire Function Call Tree

When you first open Xprofiler, by default, all the function boxes and call arcs of your executable and its shared libraries appear in the main window. After that, you may choose to filter out specific items from the window. However, there may be times when you want to see the entire function call tree again, without having to reload your application. To do this, select the **Filter** menu, and then the **Show Entire Call Tree** option. Xprofiler erases whatever is currently displayed in the main window and replaces it with the entire function call tree.

Excluding and including specific objects

There are a number of ways that Xprofiler lets you control the items that display in the main window. You will want to include or exclude certain objects so that you can more easily focus on the things that are of most interest to you.

Filtering Shared Library Functions

In most cases, your application will call functions that are within shared libraries. By default, these shared libraries display in the Xprofiler window along with your executable file. As a result, the window may get crowded and obscure the items that you most need to see. If this is the case, you can filter the shared libraries from the display. To do this, select the **Filter** menu, and then the **Remove All Library Calls** option.

The shared library function boxes disappear from the function call tree, leaving only the function boxes of your executable file visible.

If you removed the library calls from the display, you may want to restore them. To do this, select the **File** menu and then the **Add Library Calls** option.

The function boxes again appear with the function call tree. Note, however, that all of the shared library calls that were in the initial function call tree may not be added back. This is because the **Add Library Calls** option only adds back in the function boxes for the library functions that were called by functions that are currently displayed in the Xprofiler window.

To add only specific function boxes back into the display, do the following:

1. Select the **Filter** menu, and then the **Filter by Function Names** option. The Filter By Function Names dialog window appears.
2. From the Filter By Function Names Dialog window, click the **add these functions to graph** button, and then type the name of the function you want to add in the **Enter function name** field. If you enter more than one function name, you must separate them with a blank space between each function name string.

If there are multiple functions in your program that include the string you enter in their names, the filter applies to each one. For example, if you specified **sub** and **print**, and your program also included functions named **sub1**, **psub1**, and **printf**. The **sub**, **sub1**, **psub1**, **print**, and **printf** functions would all be added to the graph.

3. Click **OK**. One or more function boxes appears in the Xprofiler display with the function call tree.

Filtering by Function Characteristics

The Filter menu of Xprofiler offers the following options that allow you to add or subtract function boxes from the main window, based on specific characteristics:

- Filter by Function Names
- Filter by CPU Time
- Filter by Call Counts

Each option uses a different window to let you specify the criteria by which you want to include or exclude function boxes from the window.

To filter by function names, do the following:

1. Select the **Filter** menu and then the **Filter by Function Names** option. The following Filter By Function Names Dialog window appears:

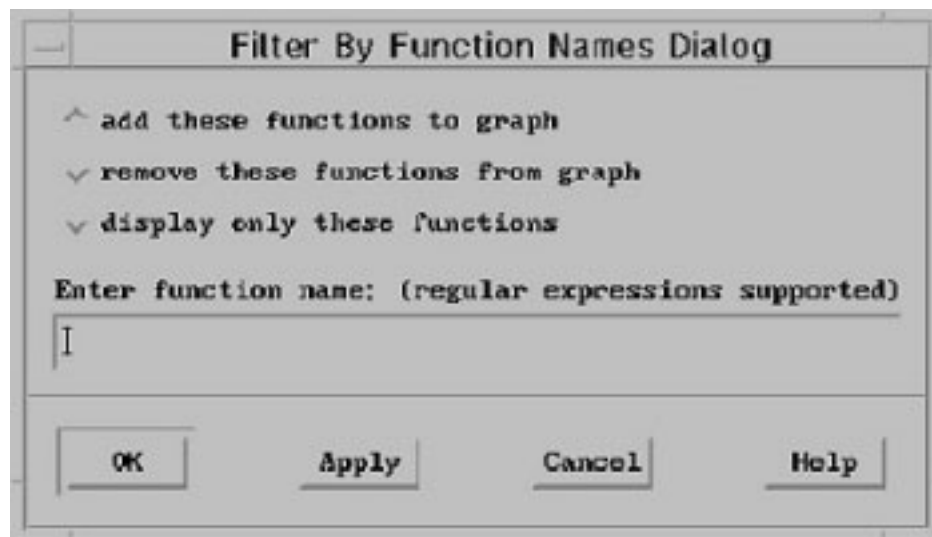

Figure 9. The Filter By Function Names Dialog window. The screen capture below shows the Filter By Function Names Dialog window. There are three check boxes: Add these functions to graph, Remove these functions from graph, and Display only these functions. There is an Enter Function Name box, where regular expressions are supported, and below it there are four buttons: OK, Apply, Cancel, and Help.

The Filter By Function Names Dialog window includes the following options:

- add these functions to graph
 - remove these functions from the graph
 - display only these functions
2. From the Filter By Function Names Dialog window, select the option, and then type the name of the function (or functions) to which you want it applied in the **Enter function name** field. For example, if you want to remove the function box for a function called **printf** from the main window, click the **remove this function from the graph** button, and type **printf** in the **Enter function name** field.
You can enter more than one function name in this field. If there are multiple functions in your program that include the string you enter in their names, the filter will apply to each one. For example, if you specified **sub** and **print**, and your program also included functions named **sub1**, **psub1**, and **printf**, the option you chose would be applied to the **sub**, **sub1**, **psub1**, **print**, and **printf** functions.
 3. Click **OK**. The contents of the function call tree now reflect the filtering options you specified.

To filter by CPU time, do the following:

1. Select the **Filter** menu and then the **Filter by CPU Time** option. The following Filter By CPU Time Dialog window appears:

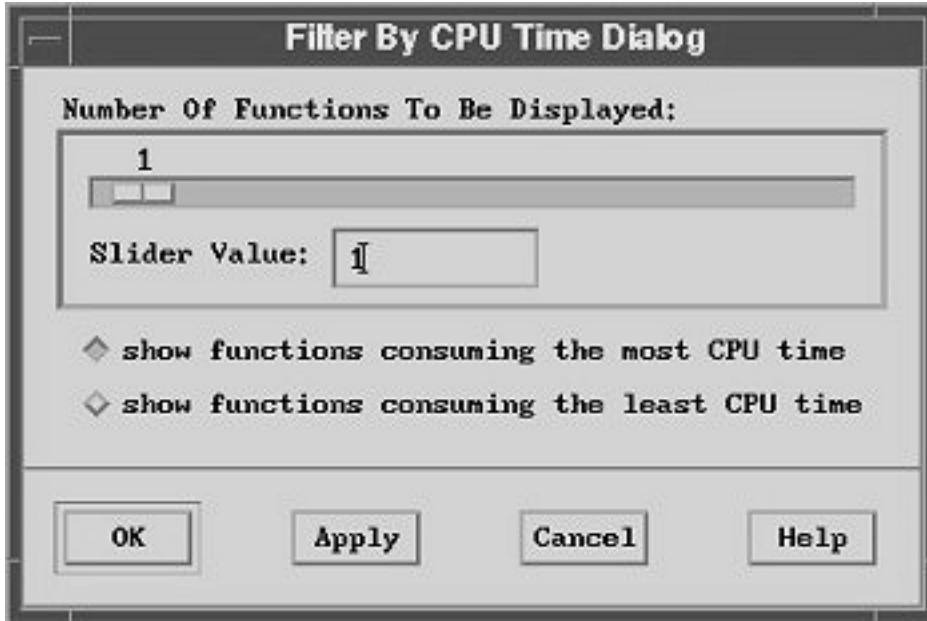

Figure 10. The Filter By CPU Time Dialog window. The screen capture below shows the Filter By CPU Time Dialog window. At the top, the user can select the Number of Functions To Be Displayed by either using the sliding bar to increase the value or type in the number in the Slider Value box. Then, there are two check boxes: Show functions consuming the most CPU time, and Show functions consuming the least CPU time. At the bottom, there are four buttons: OK, Apply, Cancel, and Help.

The Filter By CPU Time Dialog window includes the following options:

- show functions consuming the most CPU time
- show functions consuming the least CPU time

2. Select the option you want (**show functions consuming the most CPU time** is the default).
3. Select the number of functions to which you want it applied (1 is the default). You can move the slider in the **Functions** bar until the desired number appears, or you can enter the number in the **Slider Value** field. The slider and **Slider Value** field are synchronized so when the slider is updated, the text field value is updated also. If you enter a value in the text field, the slider is updated to that value when you click **Apply** or **OK**.

For example, to display the function boxes for the 10 functions in your application that consumed the most CPU, you would select the **show functions consuming the most CPU** button, and specify 10 with the slider or enter the value 10 in the text field.

4. Click **Apply** to show the changes to the function call tree without closing the dialog. Click **OK** to show the changes and close the dialog.

To filter by call counts, do the following:

1. Select the **Filter** menu and then the **Filter by Call Counts** option. The Filter By Call Counts Dialog window appears.

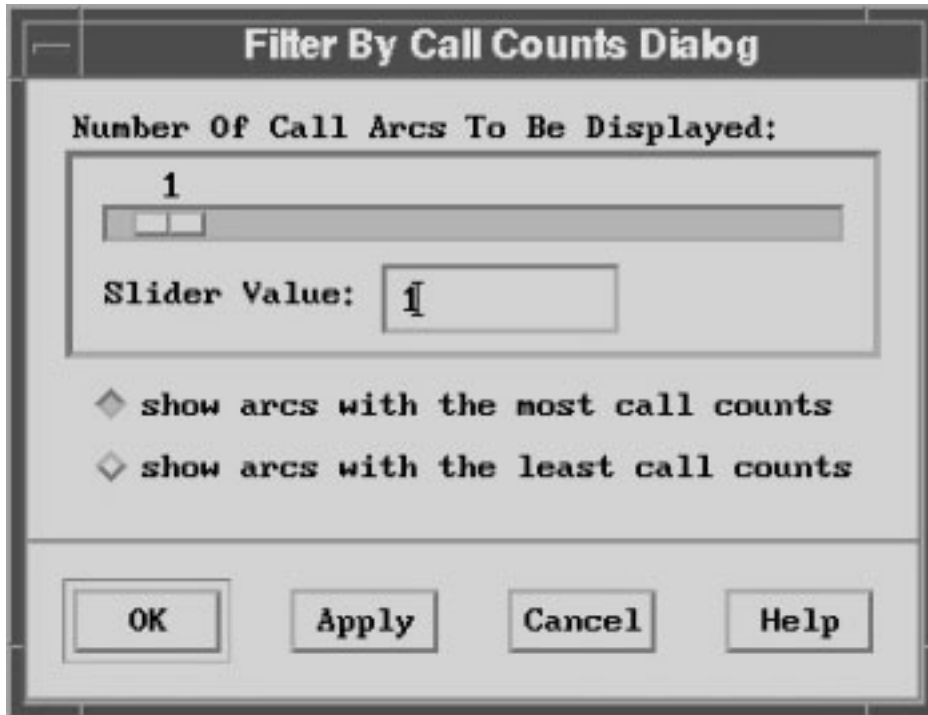

Figure 11. The Filter By Call Counts Dialog window. The screen capture below shows the Filter By Call Counts Dialog window. At the top, the user can select the Number of Call Arcs To Be Displayed by either using the sliding bar to increase the value or type in the number in the Slider Value box. Then, there are two check boxes: Show arcs with the most call counts, and Show arcs with the least call counts. At the bottom, there are four buttons: OK, Apply, Cancel, and Help.

The **Filter By Call Counts Dialog** window includes the following options:

- show arcs with the most call counts
 - show arcs with the least call counts
2. Select the option you want (**show arcs with the most call counts** is the default).
 3. Select the number of call arcs to which you want it applied (1 is the default). If you enter a value in the text field, the slider is updated to that value when you click **Apply** or **OK**.
For example, to display the 10 call arcs in your application that represented the least number of calls, you would select the **show arcs with the least call counts** button, and specify 10 with the slider or enter the value 10 in the text field.
 4. Click **Apply** to show the changes to the function call tree without closing the dialog. Click **OK** to show the changes and close the dialog.

Including and excluding parent and child functions

When tuning the performance of your application, you will want to know which functions consumed the most CPU time, and then you will need to ask several questions in order to understand their behavior:

- Where did each function spend most of the CPU time?
- What other functions called this function? Were the calls made directly or indirectly?
- What other functions did this function call? Were the calls made directly or indirectly?

After you understand how these functions behave, and are able to improve their performance, you can proceed to analyzing the functions that consume less CPU.

When your application is large, the function call tree will also be large. As a result, the functions that are the most CPU-intensive may be difficult to see in the function call tree. To avoid this situation, use the **Filter by CPU** option of the Filter menu, which lets you display only the function boxes for the functions that consume the most CPU time. After you have done this, the Function menu for each function lets you

add the parent and descendant function boxes to the function call tree. By doing this, you create a smaller, simpler function call tree that displays the function boxes associated with the most CPU-intensive area of the application.

A *child* function is one that is directly called by the function of interest. To see only the function boxes for the function of interest and its child functions, do the following:

1. Place your mouse cursor over the function box in which you are interested, and press the right mouse button. The Function menu appears.
2. From the Function menu, select the **Immediate Children** option, and then the **Show Child Functions Only** option.

Xprofiler erases the current display and replaces it with only the function boxes for the function you chose, as well as its child functions.

A *parent* function is one that directly calls the function of interest. To see only the function box for the function of interest and its parent functions, do the following:

1. Place your mouse cursor over the function box in which you are interested, and press the right mouse button. The Function menu appears.
2. From the Function menu, select the **Immediate Parents** option, and then the **Show Parent Functions Only** option.

Xprofiler erases the current display and replaces it with only the function boxes for the function you chose, as well as its parent functions.

You might want to view the function boxes for both the parent and child functions of the function in which you are interested, without erasing the rest of the function call tree. This is especially true if you chose to display the function boxes for two or more of the most CPU-intensive functions with the **Filter by CPU** option of the Filter menu (you suspect that more than one function is consuming too much CPU). Do the following:

1. Place your mouse cursor over the function box in which you are interested, and press the right mouse button. The Function menu appears.
2. From the Function menu, select the **Immediate Parents** option, and then the **Add Parent Functions to Tree** option.

Xprofiler leaves the current display as it is, but adds the parent function boxes.

3. Place your mouse cursor over the same function box and press the right mouse button. The Function menu appears.
4. From the Function menu, select the **Immediate Children** option, and then the **Add Child Functions to Tree** option.

Xprofiler leaves the current display as it is, but now adds the child function boxes in addition to the parents.

Clustering Libraries

When you first open the Xprofiler window, by default, the function boxes of your executable file, and the libraries associated with it, are clustered. Because Xprofiler shrinks the call tree of each library when it places it in a cluster, you must uncluster the function boxes if you want to look closely at a specific function box label.

You can see much more detail for each function, when your display is in the unclustered or *expanded* state, than when it is in the clustered or *collapsed* state. Depending on what you want to do, you must cluster or uncluster (collapse or expand) the display.

The Xprofiler window can be visually crowded, especially if your application calls functions that are within shared libraries; function boxes representing your executable functions as well as the functions of the shared libraries are displayed. As a result, you may want to organize what you see in the Xprofiler window

so you can focus on the areas that are most important to you. You can do this by collecting all the function boxes of each library into a single area, known as a library *cluster*.

The following figure shows the **hello_world** application with its function boxes unclustered.

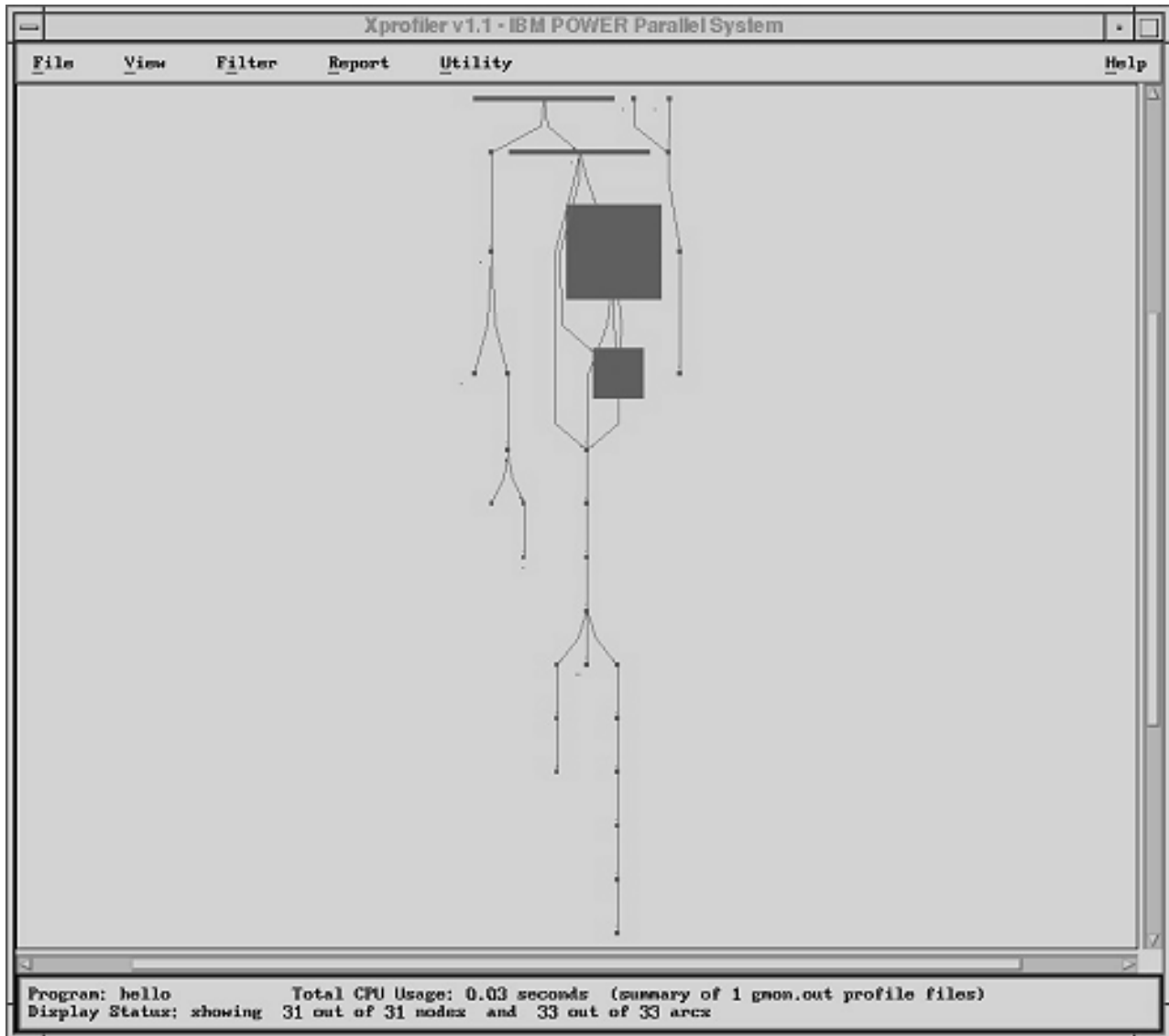

Figure 12. The Xprofiler window with function boxes unclustered. The following screen capture shows the *hello_world* application with the top-to-bottom view of its function boxes unclustered in the Xprofiler main window.

Clustering Functions

If the functions within your application are unclustered, you can use an option of the **Filter** menu to cluster them. To do this, select the **Filter** menu and then the **Cluster Functions by Library** option. The libraries within your application appear within their respective cluster boxes.

After you cluster the functions in your application you can further reduce the size (also referred to as *collapse*) of each cluster box by doing the following:

1. Place your mouse cursor over the edge of the cluster box and press the right mouse button. The Cluster Node menu appears.

2. Select the **Collapse Cluster Node** option. The cluster box and its contents now appear as a small solid green box. In the following figure, the `/lib/profiled/libc.a:shr.o` library is collapsed.

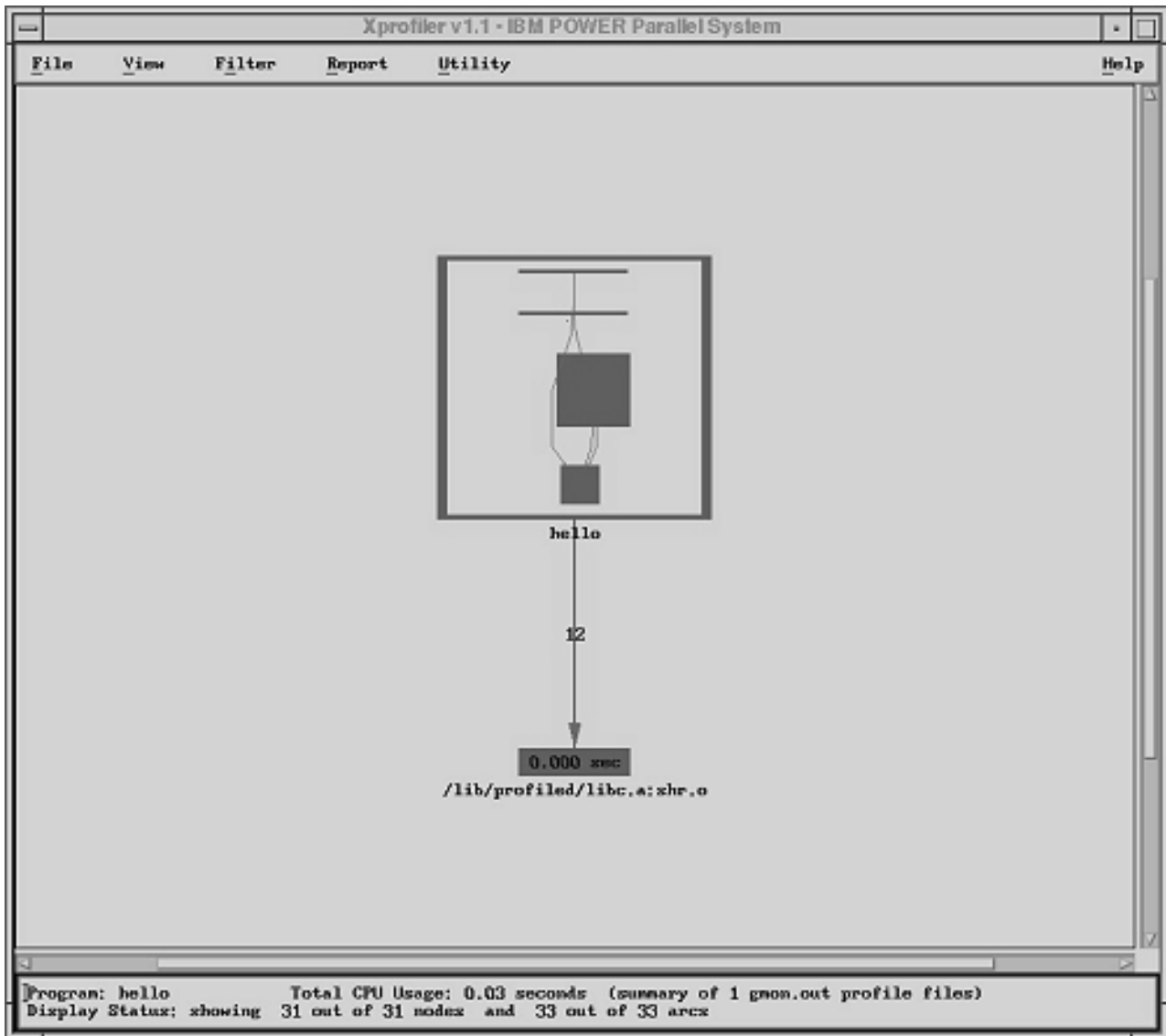

Figure 13. The Xprofiler window with one library cluster box collapsed. The following screen capture shows the function call tree of the `hello` program in the Xprofiler window with one library cluster box collapsed.

To return the cluster box to its original condition (*expand* it), do the following:

1. Place your mouse cursor over the collapsed cluster box and press the right mouse button. The **Cluster Node** menu appears.
2. Select the **Expand Cluster Node** option. The cluster box and its contents appear again.

Unclustering Functions

If the functions within your application are clustered, you can use an option of the **Filter** menu to uncluster them. To do this, select the **Filter** menu, and then the **Uncluster Functions** option. The cluster boxes disappear and the functions boxes of each library expand to fill the Xprofiler window.

If your functions have been clustered, you can remove one or more (but not all) cluster boxes. For example, if you want to uncluster only the functions of your executable file, but keep its shared libraries within their cluster boxes, you would do the following:

1. Place your mouse cursor over the edge of the cluster box that contains the executable and press the right mouse button. The **Cluster Node** menu appears.
2. Select the **Remove Cluster Box** option. The cluster box is removed and the function boxes and call arcs that represent the executable functions, now appear in full detail. The function boxes and call arcs of the shared libraries remain within their cluster boxes, which now appear smaller to make room for the unclustered executable function boxes. The following figure shows the hello_world executable file with its cluster box removed. Its shared library remains within its cluster box.

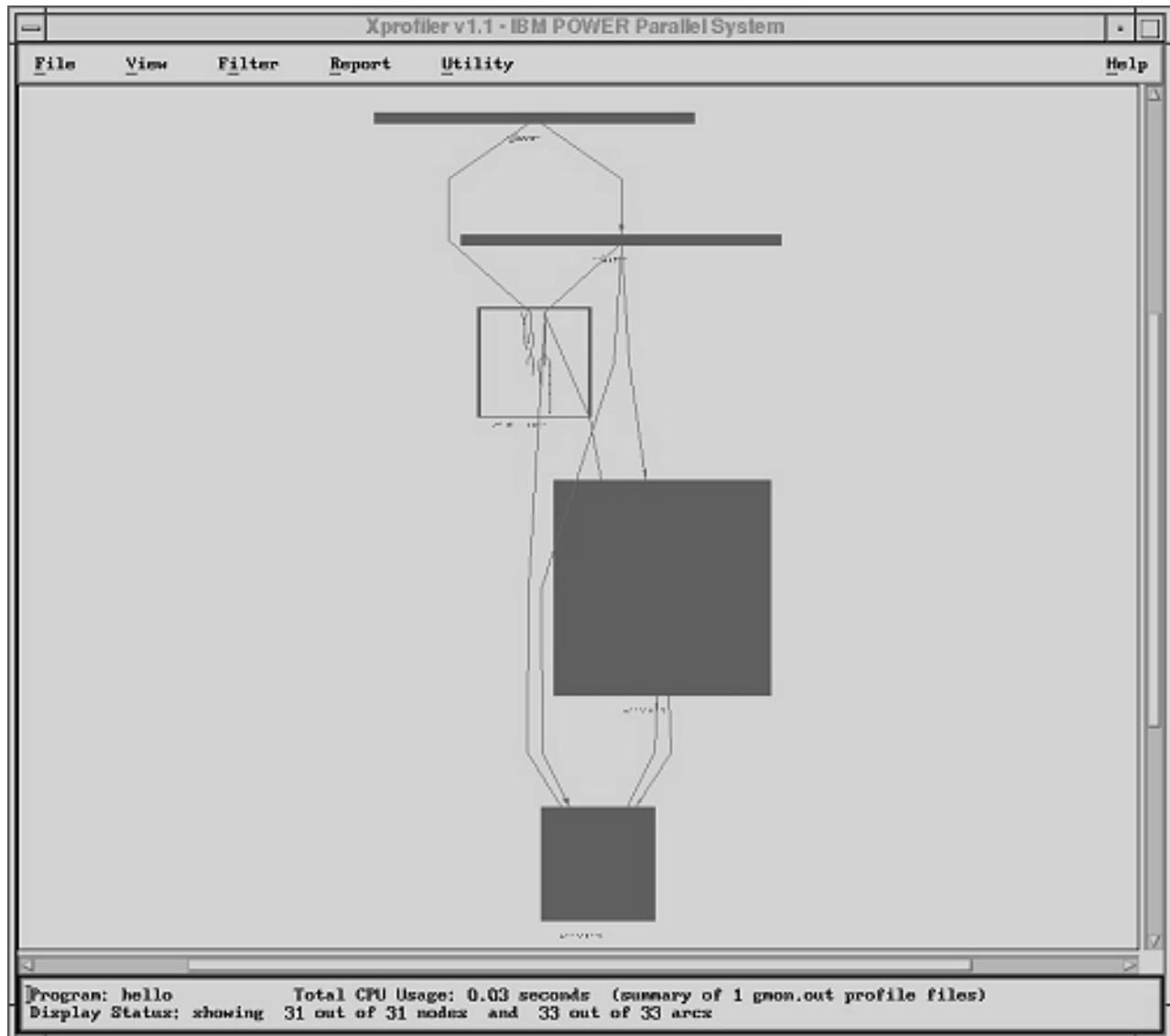

Figure 14. The Xprofiler window with one library cluster box removed. The following screen capture shows the function call tree of the hello program in the Xprofiler window with one library cluster box removed.

Locating Specific Objects in the Function Call Tree

If you are interested in one or more specific functions in a complex program, you may need help locating their corresponding function boxes in the function call tree.

If you want to locate a single function, and you know its name, you can use the **Locate Function By Name** option of the **Utility** menu. To locate a function by name, do the following:

1. Select the **Utility** menu, and then the **Locate Function By Name** option. The **Search By Function Name Dialog** window appears.
2. Type the name of the function you want to locate in the **Enter Function Name** field. The function name you type here must be a continuous string (it cannot include blanks).
3. Click **OK** or **Apply**. The corresponding function box is highlighted (its color changes to red) in the function call tree and Xprofiler zooms in on its location.

To display the function call tree in full detail again, go to the **View** menu and use the **Overview** option.

You might want to see only the function boxes for the functions that you are concerned with, in addition to other specific functions that are related to it. For example, if you want to see all the functions that directly called the function in which you are interested, it might not be easy to separate these function boxes when you view the entire call tree. You would want to display them, as well as the function of interest, alone.

Each function has its own menu. Through the Function menu, you can choose to see the following for the function you are interested in:

- Parent functions (functions that directly call the function of interest)
- Child functions (functions that are directly called by the function of interest)
- Ancestor functions (functions that can call, directly or indirectly, the function of interest)
- Descendant functions (functions that can be called, directly or indirectly, by the function of interest)
- Functions that belong to the same cycle

When you use these options, Xprofiler erases the current display and replaces it with only the function boxes for the function of interest and all the functions of the type you specified.

Locating and Displaying Parent Functions

A *parent* is any function that directly calls the function in which you are interested. To locate the parent function boxes of the function in which you are interested:

1. Click the function box of interest with the right mouse button. The Function menu appears.
2. From the Function menu, select **Immediate Parents** then **Show Parent Functions Only**. Xprofiler redraws the display to show you only the function boxes for the function of interest and its parent functions.

Locating and Displaying Child Functions

A *child* is any function that is directly called by the function in which you are interested. To locate the child functions boxes for the function in which you are interested:

1. Click the function box of interest with the right mouse button. The Function menu appears.
2. From the Function menu, select **Immediate Children** then **Show Child Functions Only**. Xprofiler redraws the display to show you only the function boxes for the function of interest and its child functions.

Locating and Displaying Ancestor Functions

An *ancestor* is any function that can call, directly or indirectly, the function in which you are interested. To locate the ancestor functions:

1. Click the function box of interest with the right mouse button. The Function menu appears.
2. From the Function menu, select **All Paths To** then **Show Ancestor Functions Only**. Xprofiler redraws the display to show you only the function boxes for the function of interest and its ancestor functions.

Locating and Displaying Descendant Functions

A *descendant* is any function that can be called, directly or indirectly, by the function in which you are interested. To locate the descendant functions (all the functions that the function of interest can reach, directly or indirectly):

1. Click the function box of interest with the right mouse button. The Function menu appears.
2. From the Function menu, select **All Paths From** then **Show Descendant Functions Only**. Xprofiler redraws the display to show you only the function boxes for the function of interest and its descendant functions.

Locating and Displaying Functions on a Cycle

To locate the functions that are on the same cycle as the function in which you are interested:

1. Click the function box of interest with the right mouse button. The Function menu appears.
2. From the Function menu, select **All Functions on the Cycle** then **Show Cycle Functions Only**. Xprofiler redraws the display to show you only the function of interest and all the other functions on its cycle.

Obtaining Performance Data for Your Application

With Xprofiler, you can get performance data for your application on a number of levels, and in a number of ways. You can easily view data pertaining to a single function, or you can use the reports provided to get information on your application as a whole.

Obtaining Basic Data

Xprofiler makes it easy to get data on specific items in the function call tree. After you have located the item you are interested in, you can get data a number of ways. If you are having trouble locating a function in the function call tree, see “Locating Specific Objects in the Function Call Tree” on page 35.

Basic Function Data

Below each function box in the function call tree is a label that contains basic performance data, similar to the following:

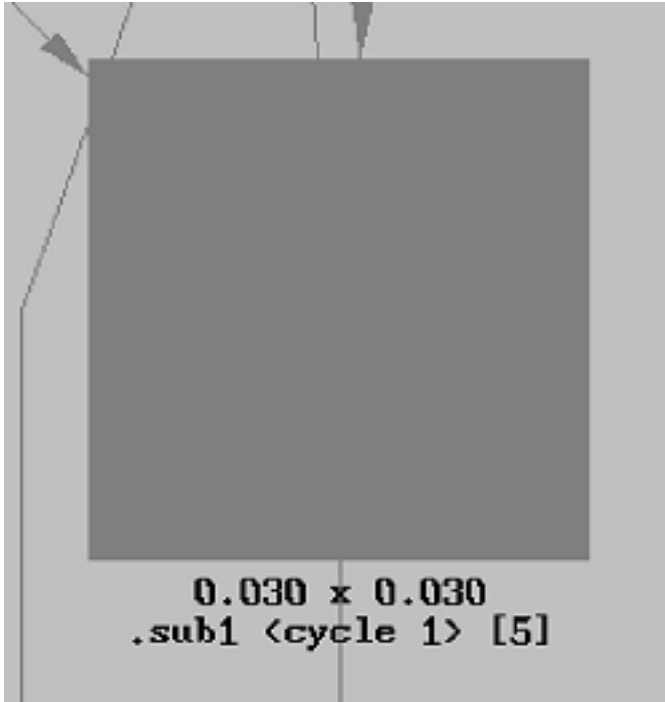

Figure 15. An example of a function box label. The following screen capture shows the details of a function box and in this example it is of the `sub1` function. The following information is listed: The function label (`sub1`), the cycle it is associated with (`1`), and its index (`5`).

The label contains the name of the function, its associated cycle, if any, and its index. In the preceding figure, the name of the function is `sub1`. It is associated with cycle `1`, and its index is `5`. Also, depending on whether the function call tree is viewed in summary mode or average mode, the label will contain different information.

If the function call tree is viewed in summary mode, the label will contain the following information:

- The total amount of CPU time (in seconds) this function spent on itself plus the amount of CPU time it spent on its descendants (the number on the left of the `x`).
- The amount of CPU time (in seconds) this function spent only on itself (the number on the right of the `x`).

If the function call tree is viewed in average mode, the label will contain the following information:

- The average CPU time (in seconds), among all the input `gmon.out` files, used on the function itself
- The standard deviation of CPU time (in seconds), among all the input `gmon.out` files, used on the function itself

For more information about summary mode and average mode, see “Controlling the Representation of the Function Call Tree” on page 26.

Because labels are not always visible in the Xprofiler window when it is fully zoomed out, you may need to zoom in on it in order to see the labels. For information about how to do this, see “Information Boxes” on page 39.

Basic Call Data

Call arc labels appear over each call arc. The label indicates the number of calls that were made between the two functions (from caller to callee). For example:

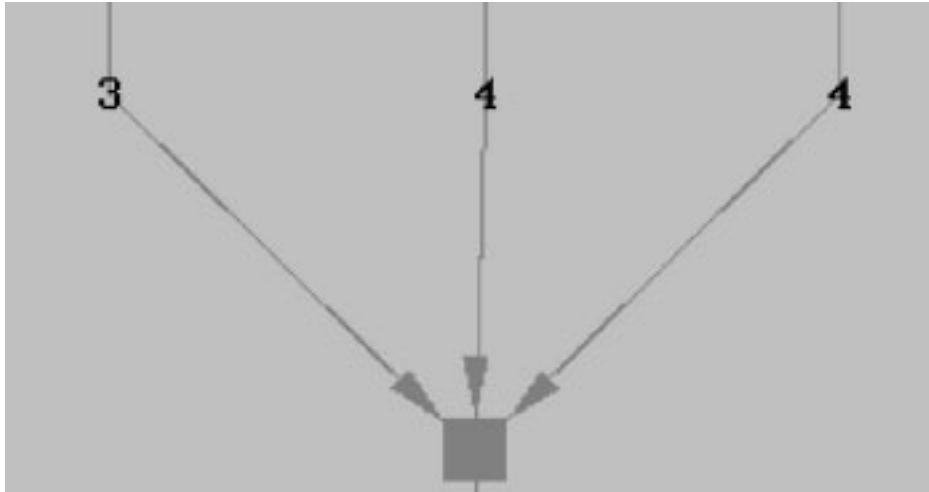

Figure 16. An example of a call arc label. In the screen capture below, there are three arcs pointing to a function box. Each arc has a call arc label that indicates the number of calls that were made between the two functions, and in this example the arc labels are 3, 4, and 4.

To see a call arc label, you can zoom in on it. For information about how to do this, see “Information Boxes.”

Basic Cluster Data

Cluster box labels indicate the name of the library that is represented by that cluster. If it is a shared library, the label shows its full path name.

Information Boxes

For each function box, call arc, and cluster box, a corresponding information box gives you the same basic data that appears on the label. This is useful when the Xprofiler display is fully zoomed out and the labels are not visible. To access the information box, click on the function box, call arc, or cluster box (place the mouse pointer over the edge of the box) with the left mouse button. The information box appears.

For a function, the information box contains the following:

- The name of the function, its associated cycle, if any, and its index.
- The amount of CPU used by this function. There are two values supplied in this field. The first is the amount of CPU time spent on this function plus the time spent on its descendants. The second value represents the amount of CPU time this function spent only on itself.
- The number of times this function was called (by itself or any other function in the application).

For a call, the information box contains the following:

- The caller and callee functions (their names) and their corresponding indexes
- The number of times the caller function called the callee

For a cluster, the information box contains the following:

- The name of the library
- The total CPU usage (in seconds) consumed by the functions within it

Function Menu Statistics Report Option

You can get performance statistics for a single function through the **Statistics Report** option of the **Function** menu. This option lets you see data on the CPU usage and call counts of the selected function. If you are using more than one **gmon.out** file, the **Statistics Report** option breaks down the statistics for each **gmon.out** file you use.

When you select the **Statistics Report** menu option, the Function Level Statistics Report window appears.

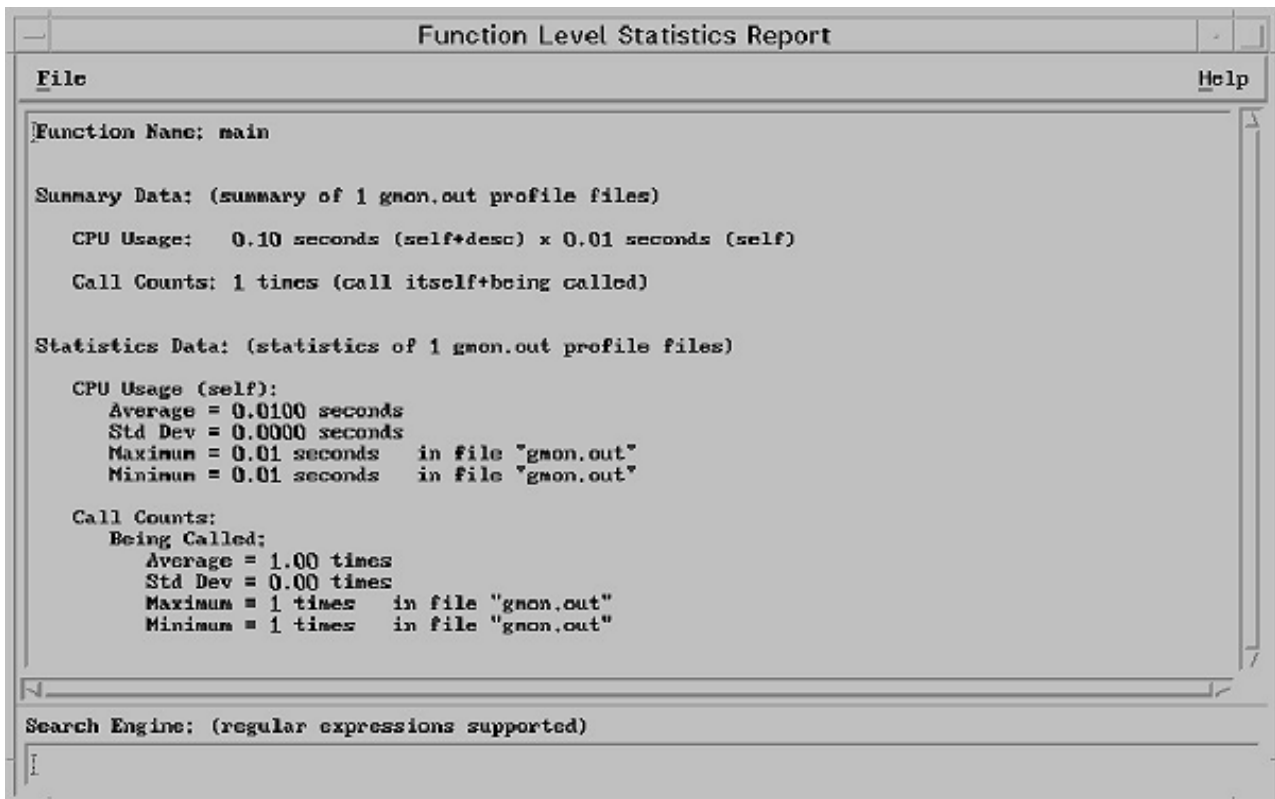

Figure 17. The Function Level Statistics Report window. The screen capture below shows the Function Level Statistics Report window and shows the details of the **main** function. The specifics of a Function Level Statistics Report are detailed below the graphic.

The Function Level Statistics Report window provides the following information:

Function Name

The name of the function you selected.

Summary Data

The total amount of CPU used by this function. If you used multiple **gmon.out** files, the value shown here represents their sum.

The **CPU Usage** field indicates:

- The amount of CPU time used by this function. There are two values supplied in this field. The first is the amount of CPU time spent on this function plus the time spent on its descendants. The second value represents the amount of CPU time this function spent only on itself.

The **Call Counts** field indicates:

- The number of times this function called itself, plus the number of times it was called by other functions.

Statistics Data

The CPU usage and calls made to or by this function, broken down for each **gmon.out** file.

The **CPU Usage** field indicates:

- **Average**
The average CPU time used by the data in each **gmon.out** file.

- **Std Dev**
Standard deviation. A value that represents the difference in CPU usage samplings, per function, from one **gmon.out** file to another. The smaller the standard deviation, the more balanced the workload.
- **Maximum**
Of all the **gmon.out** files, the maximum amount of CPU time used. The corresponding **gmon.out** file appears to the right.
- **Minimum**
Of all the **gmon.out** files, the minimum amount of CPU time used. The corresponding **gmon.out** file appears to the right.

The **Call Counts** field indicates:

- **Average**
The average number of calls made to this function or by this function, for each **gmon.out** file.
- **Std Dev**
Standard deviation. A value that represents the difference in call count sampling, per function, from one **gmon.out** file to another. A small standard deviation value in this field means that the function was almost always called the same number of times in each **gmon.out** file.
- **Maximum**
The maximum number of calls made to this function or by this function in a single **gmon.out** file. The corresponding **gmon.out** file appears to the right.
- **Minimum**
The minimum number of calls made to this function or by this function in a single **gmon.out** file. The corresponding **gmon.out** file appears to the right.

Getting Detailed Data from Reports

Xprofiler provides performance data in textual and tabular format. This data is provided in various tables called *reports*. Similar to the **gprof** command, Xprofiler generates the **Flat Profile**, **Call Graph Profile**, and **Function Index** reports, as well as two additional reports.

You can access the Xprofiler reports from the **Report** menu. The **Report** menu displays the following reports:

- Flat Profile
- Call Graph Profile
- Function Index
- Function Call Summary
- Library Statistics

Each report window includes a File menu. Under the File menu is the **Save As** option, which lets you save the report to a file. For information about using the **Save File Dialog** window to save a report to a file, see “Saving the Call Graph Profile, Function Index, and Flat Profile reports to a file” on page 49.

Note: If you select the **Save As** option from the **Flat Profile**, **Function Index**, or **Function Call Summary** report window, you must either complete the save operation or cancel it before you can select any other option from the menus of these reports. You can, however, use the other Xprofiler menus before completing the save operation or canceling it, with the exception of the **Load Files** option of the **File** menu, which remains unavailable.

Each of the Xprofiler reports are explained as follows.

Flat Profile Report

When you select the **Flat Profile** menu option, the Flat Profile window appears. The Flat Profile report shows you the total execution times and call counts for each function (including shared library calls) within your application. The entries for the functions that use the greatest percentage of the total CPU usage appear at the top of the list, while the remaining functions appear in descending order, based on the amount of time used.

Unless you specified the **-z** flag, the **Flat Profile** report does not include functions that have no CPU usage and no call counts. The data presented in the **Flat Profile** window is the same data that is generated with the **gprof** command.

The Flat Profile report looks similar to the following:

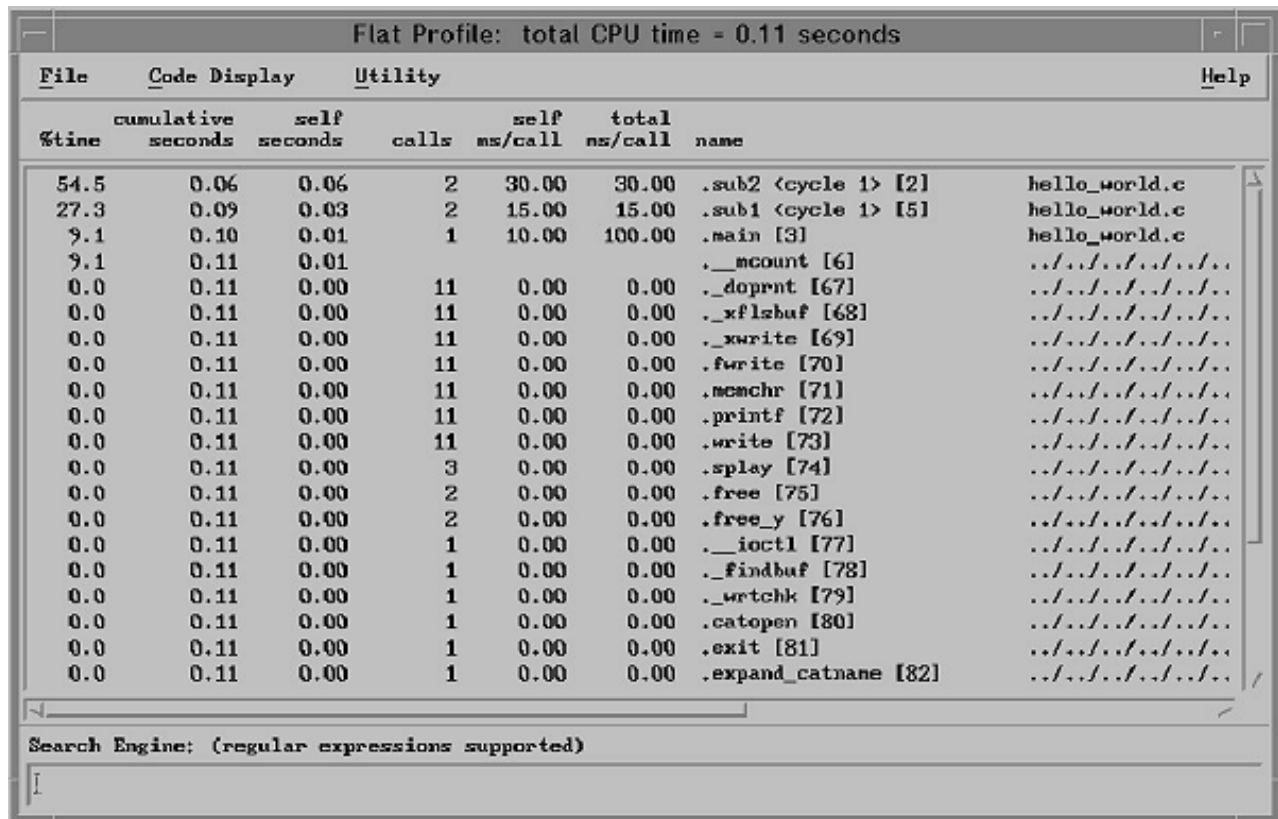

The screenshot shows a window titled "Flat Profile: total CPU time = 0.11 seconds". The window has a menu bar with "File", "Code Display", "Utility", and "Help". Below the menu bar is a table with the following columns: %time, cumulative seconds, self seconds, calls, self ms/call, total ns/call, and name. The table lists various functions and their statistics, sorted by %time in descending order.

%time	cumulative seconds	self seconds	calls	self ms/call	total ns/call	name
54.5	0.06	0.06	2	30.00	30.00	.sub2 <cycle 1> [2] hello_world.c
27.3	0.09	0.03	2	15.00	15.00	.sub1 <cycle 1> [5] hello_world.c
9.1	0.10	0.01	1	10.00	100.00	.main [3] hello_world.c
9.1	0.11	0.01				__mcount [6]
0.0	0.11	0.00	11	0.00	0.00	__dopent [67]
0.0	0.11	0.00	11	0.00	0.00	__xflzbuf [68]
0.0	0.11	0.00	11	0.00	0.00	__xwrite [69]
0.0	0.11	0.00	11	0.00	0.00	.fwrite [70]
0.0	0.11	0.00	11	0.00	0.00	.memcpy [71]
0.0	0.11	0.00	11	0.00	0.00	.printf [72]
0.0	0.11	0.00	11	0.00	0.00	.write [73]
0.0	0.11	0.00	3	0.00	0.00	.splay [74]
0.0	0.11	0.00	2	0.00	0.00	.free [75]
0.0	0.11	0.00	2	0.00	0.00	.free_y [76]
0.0	0.11	0.00	1	0.00	0.00	__ioctl [77]
0.0	0.11	0.00	1	0.00	0.00	__findbuf [78]
0.0	0.11	0.00	1	0.00	0.00	__wrtchk [79]
0.0	0.11	0.00	1	0.00	0.00	.catopen [80]
0.0	0.11	0.00	1	0.00	0.00	.exit [81]
0.0	0.11	0.00	1	0.00	0.00	.expand_catname [82]

Search Engine: (regular expressions supported)

Figure 18. The Flat Profile report. The screen capture below shows an example of a Flat Profile report window. There is a menu bar at the top with the following options: File, Code Display, Utility, and Help. Below the menu bar is a list of statistics that are described below the graphic.

Flat Profile window fields: The **Flat Profile** window contains the following fields:

- **%time**
The percentage of the program's total CPU usage that is consumed by this function.
- **cumulative seconds**
A running sum of the number of seconds used by this function and those listed above it.
- **self seconds**
The number of seconds used by this function alone. Xprofiler uses the **self seconds** values to sort the functions of the **Flat Profile** report.
- **calls**
The number of times this function was called (if this function is profiled). Otherwise, it is blank.

- **self ms/call**

The average number of milliseconds spent in this function per call (if this function is profiled). Otherwise, it is blank.

- **total ms/call**

The average number of milliseconds spent in this function and its descendants per call (if this function is profiled). Otherwise, it is blank.

- **name**

The name of the function. The *index* appears in brackets ([]) to the right of the function name. The index serves as the function's identifier within Xprofiler. It also appears below the corresponding function in the function call tree.

Call Graph Profile Report

The Call Graph Profile menu option lets you view the functions of your application, sorted by the percentage of total CPU usage that each function, and its descendants, consumed. When you select this option, the Call Graph Profile window appears.

Unless you specified the **-z** flag, the **Call Graph Profile** report does not include functions whose CPU usage is 0 (zero) and have no call counts. The data presented in the **Call Graph Profile** window is the same data that is generated with the **gprof** command.

The Call Graph Profile report looks similar to the following:

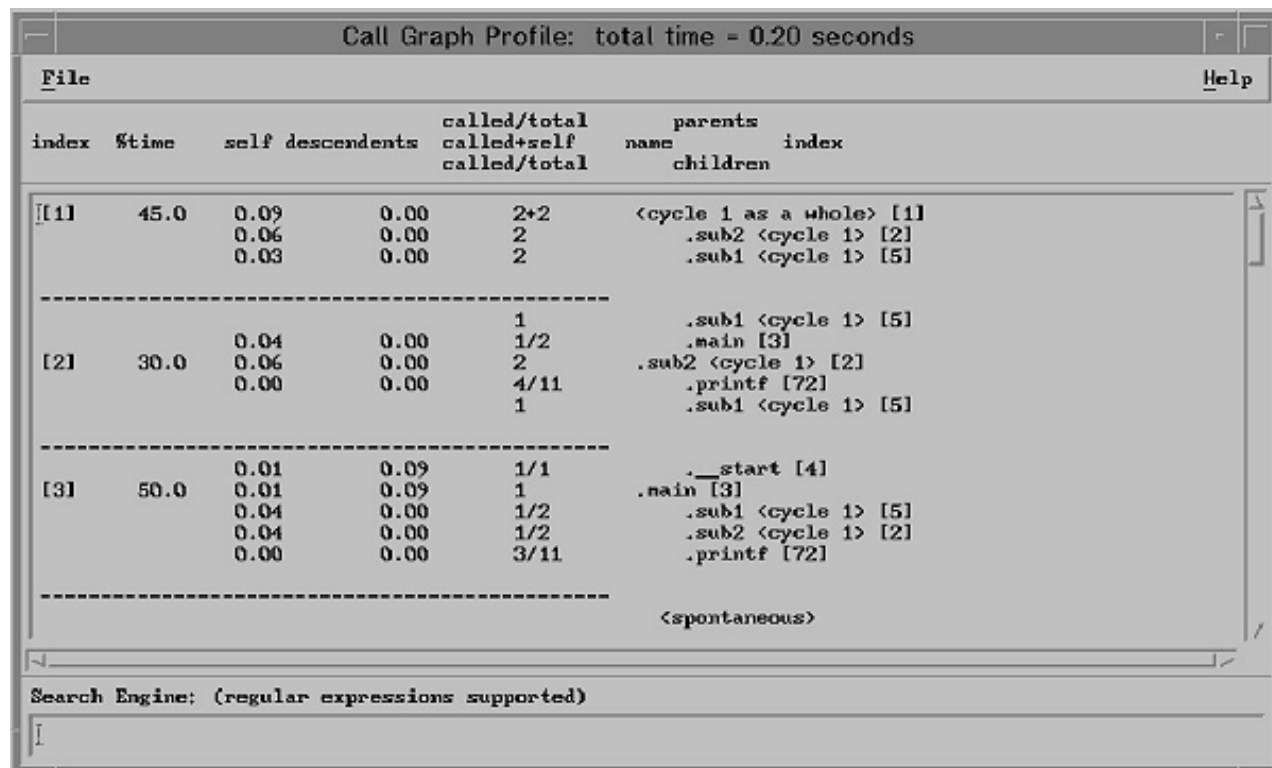

Figure 19. The Call Graph Profile report. The screen capture below shows an example of a Flat Profile report window. There is a menu bar at the top with the following options: File, and Help. Below the menu bar is a list of statistics that are described below the graphic.

Call Graph Profile window fields: The **Call Graph Profile** window contains the following fields:

- **index**

The index of the function in the **Call Graph Profile**. Each function in the **Call Graph Profile** has an associated index number which serves as the function's identifier. The same index also appears with each function box label in the function call tree, as well as other Xprofiler reports.

- **%time**
The percentage of the program's total CPU usage that was consumed by this function and its descendants.
- **self**
The number of seconds this function spends within itself.
- **descendants**
The number of seconds spent in the descendants of this function, on behalf of this function.
- **called/total, called+self, called/total**
The heading of this column refers to the different kinds of calls that take place within your program. The values in this field correspond to the functions listed in the **name, index, parents, children** field to its right. Depending on whether the function is a parent, a child, or the function of interest (the function with the index listed in the **index** field of this row), this value might represent the number of times that:
 - a parent called the function of interest
 - the function of interest called itself, recursively
 - the function of interest called a child

In the following figure, **sub2** is the function of interest, **sub1** and **main** are its parents, and **printf** and **sub1** are its children.

called/total called+self called/total	parents name children	index
1	.sub1 <cycle 1>	[5]
1/2	.main	[3]
2	.sub2 <cycle 1>	[2]
4/11	.printf	[72]
1	.sub1 <cycle 1>	[5]

Figure 20. The called/total, call/self, called/total field. The screen capture below is an example of the called/total, call/self, called/total field of the Call Graph Profile report where **sub2** is the function of interest, **sub1** and **main** are its parents, and **printf** and **sub1** are its children.

- **called/total**
For a parent function, the number of calls made to the function of interest, as well as the total number of calls it made to all functions.
- **called+self**
The number of times the function of interest called itself, recursively.
- **name, index, parents, children**
The layout of the heading of this column indicates the information that is provided. To the left is the name of the function, and to its right is the function's index number. Appearing above the function are its parents, and below are its children.

```

parents
name      index
children

.sub1 <cycle 1> [5]
.main [3]
.sub2 <cycle 1> [2]
.printf [72]
.sub1 <cycle 1> [5]

```

Figure 21. The name/index/parents/children field. The screen capture below is an example of the name/index/parents/children field of the Call Graph Profile report. To the left is the name of the function, and to its right is the function's index number. Appearing above the function are its parents, and below are its children.

- **name**
The name of the function, with an indication of its membership in a cycle, if any. The function of interest appears to the left, while its parent and child functions are indented above and below it.
- **index**
The index of the function in the **Call Graph Profile**. This number corresponds to the index that appears in the *index* column of the **Call Graph Profile** and the on the function box labels in the function call tree.
- **parents**
The parents of the function. A *parent* is any function that directly calls the function in which you are interested.
If any portion of your application was not compiled with the **-pg** flag, Xprofiler cannot identify the parents for the functions within those portions. As a result, these parents will be listed as *spontaneous* in the **Call Graph Profile** report.
- **children**
The children of the function. A *child* is any function that is directly called by the function in which you are interested.

Function Index Report

The Function Index menu option lets you view a list of the function names included in the function call tree. When you select this option, the Function Index window appears and displays the function names in alphabetical order. To the left of each function name is its *index*, enclosed in brackets ([]). The index is the function's identifier, which is assigned by Xprofiler. An index also appears on the label of each corresponding function box in the function call tree, as well as on other reports.

Unless you specified the **-z** flag, the Function Index report does not include functions that have no CPU usage and no call counts.

Like the **Flat Profile** menu option, the **Function Index** menu option includes a **Code Display** menu, so you can view source code or disassembler code. See "Looking at Your Code" on page 50 for more information.

The **Function Index** report looks similar to the following:

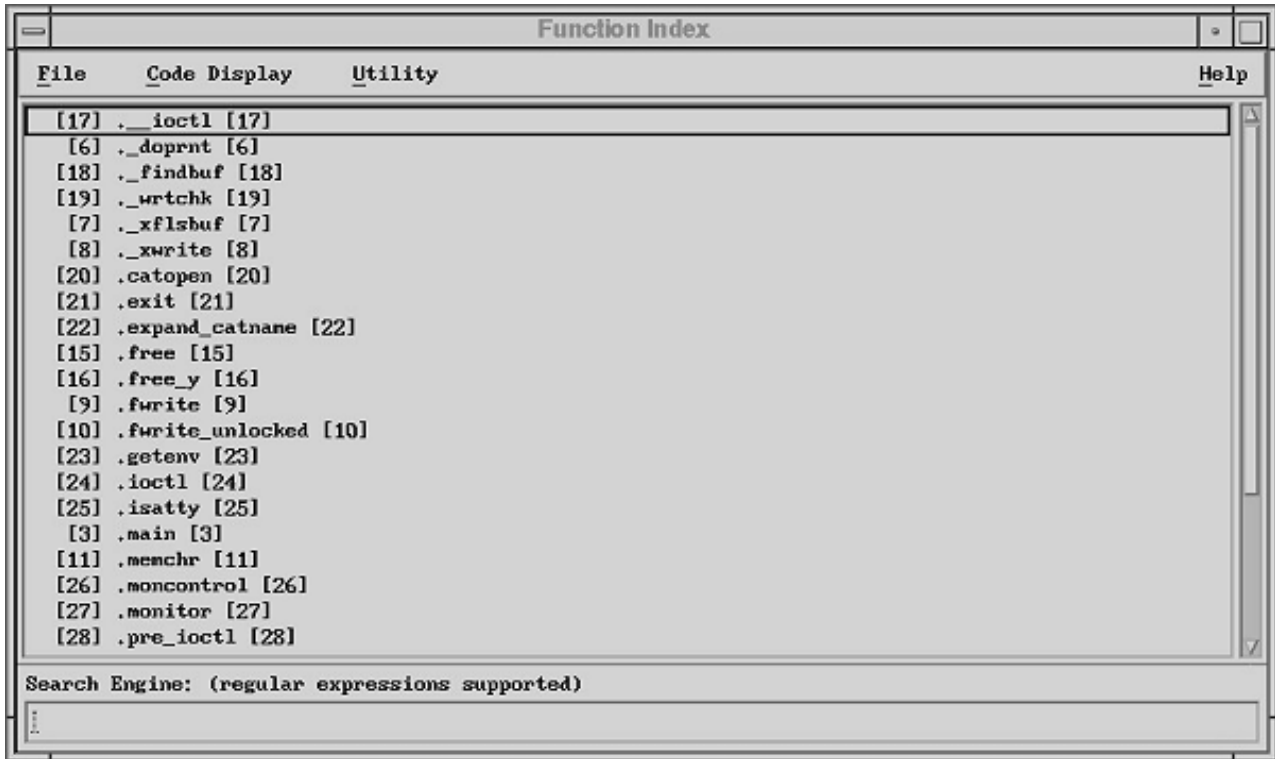

Figure 22. The Function Index report. The following screen capture shows the Function Index Report window. There is a menu bar at the top with the following options: File, Code Display, Utility, and Help. Then, there is a list of the function names included in the function call tree, where to the left of each function name is its index, enclosed in brackets. An index also appears on the label of each corresponding function box in the function call tree.

Function Call Summary Report

The Function Call Summary menu option lets you display all the functions in your application that call other functions. They appear as caller-callee pairs (call arcs, in the function call tree), and are sorted by the number of calls in descending order. When you select this option, the Function Call Summary window appears.

The **Function Call Summary** report looks similar to the following:

Function Call Summary		
File	Utility	Help
%total	calls	function
10.78%	11	calls from .printf [72] to ._doprint [67]
10.78%	11	calls from ._doprint [67] to .fwrite [70]
10.78%	11	calls from ._xflsbuf [68] to ._xwrite [69]
10.78%	11	calls from ._xwrite [69] to .write [73]
10.78%	11	calls from .fwrite [70] to .memchr [71]
10.78%	11	calls from .fwrite [70] to ._xflsbuf [68]
3.92%	4	calls from .sub2 <cycle 1> [2] to .printf [72]
3.92%	4	calls from .sub1 <cycle 1> [5] to .printf [72]
2.94%	3	calls from .free_y [76] to .splay [74]
2.94%	3	calls from .main [3] to .printf [72]
1.96%	2	calls from .free [75] to .free_y [76]
0.98%	1	calls from .ioctl [84] to ._ioctl [77]
0.98%	1	calls from .setlocale [89] to .saved_category_name [88]
0.98%	1	calls from .monitor [87] to .catopen [80]
0.98%	1	calls from .monstn [1465] to .free [75]
0.98%	1	calls from .monstartup [1463] to .free [75]
0.98%	1	calls from .monitor [87] to .moncontrol [86]
0.98%	1	calls from .expand_catname [82] to .getenv [83]
0.98%	1	calls from .expand_catname [82] to .setlocale [89]
0.98%	1	calls from .isatty [85] to .ioctl [84]
0.98%	1	calls from .catopen [80] to .expand_catname [82]

Search Engine: (regular expressions supported)

Figure 23. The Function Call Summary report. The screen capture below shows an example of the Function Call Summary Report window. There is a menu bar at the top with the following options: File, Utility, and Help. There is a list of all the functions in your application that call other functions and they appear as caller-callee pairs (call arcs, in the function call tree), and are sorted by the number of calls in descending order.

Function Call Summary window fields: The Function Call Summary window contains the following fields:

- **%total**
The percentage of the total number of calls generated by this caller-callee pair
- **calls**
The number of calls attributed to this caller-callee pair
- **function**
The name of the caller function and callee function

Library Statistics Report

The Library Statistics menu option lets you display the CPU time consumed and call counts of each library within your application. When you select this option, the Library Statistics window appears.

The **Library Statistics** report looks similar to the following:

Library Statistics							
File							Help
total seconds	%total time	total calls	%total calls	%calls out of	%calls into	%calls within	load unit
0.10	90.91	5	4.90	11.76	0.00	4.90	hello_world
0.01	9.09	97	95.10	0.00	11.76	83.33	/lib/profiled/libc.a : shr.o
0.00	0.00	NA	--	0.00	--	--	/lib/profiled/libc.a : meth.o

Search Engine: (regular expressions supported)

Figure 24. The Library Statistics report. The following screen capture shows an example of the Library Statistics Report window. There is a menu bar at the top with the following options: File, and Help. There is a list of statistics for each library that is described in greater detail below the graphic.

Library Statistics window fields: The **Library Statistics** window contains the following fields:

- **total seconds**
The total CPU usage of the library, in seconds
- **%total time**
The percentage of the total CPU usage that was consumed by this library
- **total calls**
The total number of calls that this library generated
- **%total calls**
The percentage of the total calls that this library generated
- **%calls out of**
The percentage of the total number of calls made from this library to other libraries
- **%calls into**
The percentage of the total number of calls made from other libraries into this library
- **%calls within**
The percentage of the total number of calls made between the functions within this library
- **load unit**
The library's full path name

Saving Reports to a File

Xprofiler lets you save any of the reports you generate with the **Report** menu to a file. You can do this using the **File** and **Report** menus of the Xprofiler GUI.

Saving a single report: To save a single report, go to the **Report** menu on the Xprofiler main window and select the report you want to save. Each report window includes a **File** menu. Select the **File** menu and then the **Save As** option to save the report. A **Save** dialog window appears, which is named according to the report from which you selected the **Save As** option. For example, if you chose **Save As** from the **Flat Profile** window, the save window is named **Save Flat Profile Dialog**.

Saving the Call Graph Profile, Function Index, and Flat Profile reports to a file: You can save the **Call Graph Profile**, **Function Index**, and **Flat Profile** reports to a single file through the **File** menu of the Xprofiler main window. The information you generate here is identical to the output of the **gprof** command. From the **File** menu, select the **Save As** option. The **Save File Dialog** window appears.

To save the reports, do the following:

1. Specify the file into which the profiled data should be placed. You can specify either an existing file or a new one. To specify an existing file, use the scroll bars of the **Directories** and **Files** selection boxes to locate the file. To make locating your files easier, you can also use the **Filter** button (see “Filtering what You See” on page 27 for more information). To specify a new file, type its name in the **Selection** field.
2. Click **OK**. A file that contains the profiled data appears in the directory you specified, under the name you gave it.

Note: After you select the **Save As** option from the **File** menu and the Save Profile Reports window opens, you must either complete the save operation or cancel it before you can select any other option from the menus of its parent window. For example, if you select the **Save As** option from the **Flat Profile** report and the Save File Dialog window appears, you cannot use any other option of the **Flat Profile** report window.

The **File Selection** field of the Save File Dialog window follows Motif standards.

Saving summarized data from multiple profile data files: If you are profiling a parallel program, you can specify more than one profile data (**gmon.out**) file when you start Xprofiler. The **Save gmon.sum As** option of the **File** menu lets you save a summary of the data in each of these files to a single file.

The Xprofiler **Save gmon.sum As** option produces the same result as the **xprofiler -s** command and the **gprof -s** command. If you run Xprofiler later, you can use the file you create here as input with the **-s** flag. In this way, you can accumulate summary data over several runs of your application.

To create a summary file, do the following:

1. Select the **File** menu, and then the **Save gmon.sum As** option. The **Save gmon.sum Dialog** window appears.
2. Specify the file into which the summarized, profiled data should be placed. By default, Xprofiler puts the data into a file called **gmon.sum**. To specify a new file, type its name in the selection field. To specify an existing file, use the scroll bars of the **Directories** and **Files** selection boxes to locate the file you want. To make locating your files easier, you can also use the **Filter** button (see “Filtering what You See” on page 27 for information).
3. Click **OK**. A file that contains the summary data appears in the directory you specified, under the name you specified.

Saving a configuration file: The **Save Configuration** menu option lets you save the names of the functions that are displayed currently to a file. Later, in the same Xprofiler session or in a different session, you can read this configuration file in using the **Load Configuration** option. For more information, see “Loading a configuration file” on page 50.

To save a configuration file, do the following:

1. Select the **File** menu, and then the **Save Configuration** option. The **Save Configuration File Dialog** window opens with the *program.cfg* file as the default value in the **Selection** field, where *program* is the name of the input **a.out** file.
You can use the default file name, enter a file name in the **Selection** field, or select a file from the file list.
2. Specify a file name in the **Selection** field and click **OK**. A configuration file is created that contains the name of the program and the names of the functions that are displayed currently.
3. Specify an existing file name in the **Selection** field and click **OK**. An Overwrite File Dialog window appears so that you can check the file before overwriting it.

If you selected the **Forced File Overwriting** option in the Runtime Options Dialog window, the Overwrite File Dialog window does not open and the specified file is overwritten without warning.

Loading a configuration file: The **Load Configuration** menu option lets you read in a configuration file that you saved. See “Saving a configuration file” on page 49 for more information. The **Load Configuration** option automatically reconstructs the function call tree according to the function names recorded in the configuration file.

To load a configuration file, do the following:

1. Select the File menu, and then the **Load Configuration** option. The **Load Configuration File Dialog** window opens. If configuration files were loaded previously during the current Xprofler session, the name of the file that was most recently loaded will appear in the **Selection** field of this dialog.
You can also load the file with the **-c** flag. For more information, see “Specifying Command Line Options (from the GUI)” on page 14.
2. Select a configuration file from the dialog’s **Files** list or specify a file name in the **Selection** field and click **OK**. The function call tree is redrawn to show only those function boxes for functions that are listed in the configuration file and are called within the program that is currently represented in the display. All corresponding call arcs are also drawn.
If the **a.out** name, that is, the program name in the configuration file, is different from the **a.out** name in the current display, a confirmation dialog asks you whether you still want to load the file.
3. If after loading a configuration file, you want to return the function call tree to its previous state, select the **Filter** menu, and then the **Undo** option.

Looking at Your Code

Xprofler provides several ways for you to view your code. You can view the source code or the disassembler code for your application, for each function. This also applies to any included function code that your application might use.

To view source or included function code, use the Source Code window. To view disassembler code, use the Disassembler Code window. You can access these windows through the Report menu of the Xprofler GUI or the Function menu of the function you are interested in.

Viewing the Source Code

Both the Function menu and Report menu allow you to access the Source Code window, from which you can view your code.

To access the Source Code window through the Function menu:

1. Click the function box you are interested in with the right mouse button. The **Function** menu appears.
2. From the **Function** menu, select the **Show Source Code** option. The **Source Code** window appears.

To access the **Source Code** window through the Report menu:

1. Select the Report menu, and then the **Flat Profile** option. The **Flat Profile** window appears.

2. From the **Flat Profile** window, select the function you would like to view by clicking on its entry in the window. The entry is highlighted to show that it is selected.
3. Select the **Code Display** menu, and then the **Show Source Code** option. The **Source Code** window appears, containing the source code for the function you selected.

Using the Source Code window: The **Source Code** window shows you the source code file for the function you specified from the **Flat Profile** window or the **Function** menu. The **Source Code** window looks similar to the following:

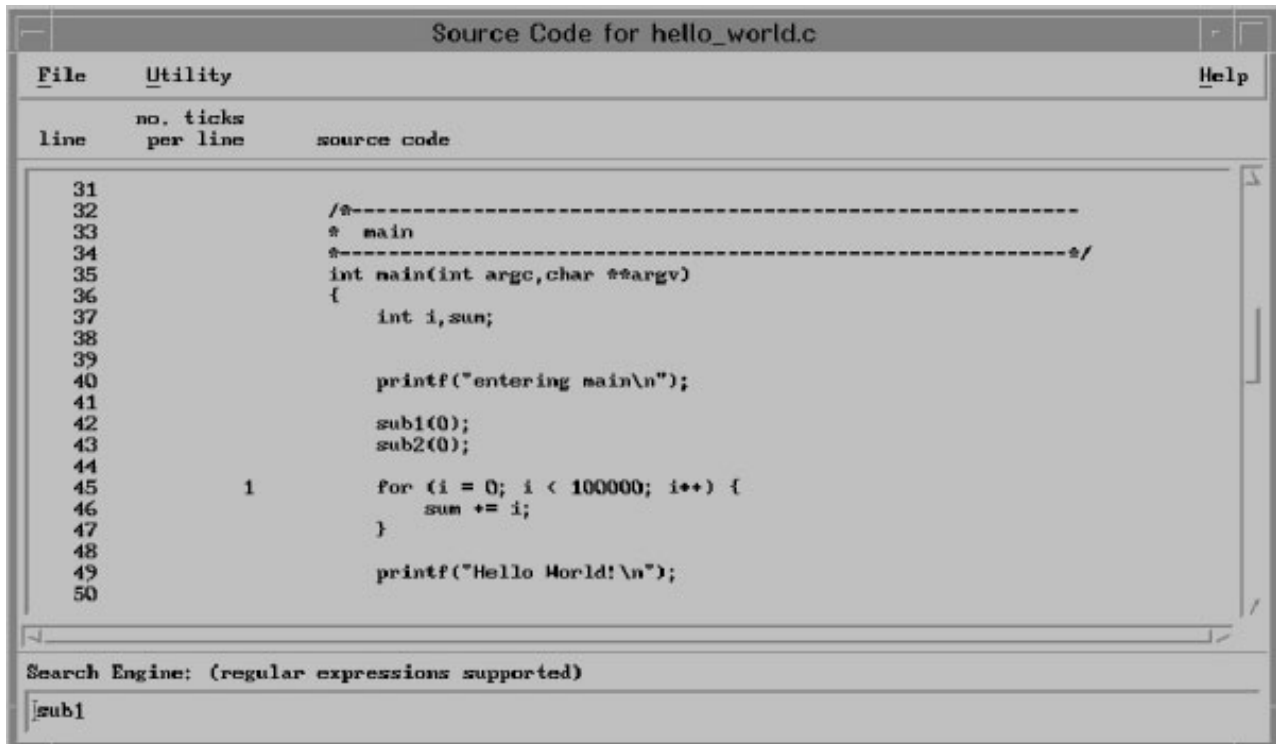

Figure 25. The Source Code window. The following screen capture shows an example of the Source Code window. There is a menu bar at the top with the following options: File, Utility, and Help. The fields of the Source Code window are described in greater detail below the graphic.

The **Source Code** window contains information in the following fields:

- **line**
The source code line number.
- **no. ticks per line**
Each tick represents .01 seconds of CPU time used. The value in this field represents the number of ticks used by the corresponding line of code. For example, if the number 3 appeared in this field, for a source statement, this source statement would have used .03 seconds of CPU time. The CPU usage data only appears in this field if you used the **-g** flag when you compiled your application. Otherwise, this field is blank.
- **source code**
The application's source code.

The **Source Code** window contains the following menus:

- **File**
The **Save As** option lets you save the annotated source code to a file. When you select this option, the **Save File Dialog** window appears. For more information about using the **Save File Dialog** window, see "Saving the Call Graph Profile, Function Index, and Flat Profile reports to a file" on page 49.

To close the **Source Code** window, select **Close**.

- **Utility**

This menu contains the **Show Included Functions** option.

For C++ users, the **Show Included Functions** option lets you view the source code of included function files that are included by the application's source code.

If a selected function does not have an included function file associated with it or does not have the function file information available because the **-g** flag was not used for compiling, the **Utility** menu will be unavailable. The availability of the **Utility** menu indicates whether there is any included function-file information associated with the selected function.

When you select the **Show Included Functions** option, the **Included Functions Dialog** window appears, which lists all of the included function files. Specify a file by either clicking on one of the entries in the list with the left mouse button, or by typing the file name in the **Selection** field. Then click **OK** or **Apply**. After you select a file from the **Included Functions Dialog** window, the **Included Function File** window appears, displaying the source code for the file that you specified.

Viewing the Disassembler Code

Both the **Function** menu and **Report** menu allow you to access the Disassembler Code window, from which you can view your code.

To access the **Disassembler Code** window through the **Function** menu, do the following:

1. Click the function you are interested in with the right mouse button. The **Function** menu appears.
2. From the **Function** menu, select the **Show Disassembler Code** option. The **Disassembler Code** window appears.

To access the Disassembler Code window through the **Report** menu, do the following:

1. Select the **Report** menu, and then the **Flat Profile** option. The **Flat Profile** window appears.
2. From the **Flat Profile** window, select the function you want to view by clicking on its entry in the window. The entry is highlighted to show that it is selected.
3. Select the **Code Display** menu, and then the **Show Disassembler Code** option. The Disassembler Code window appears, and contains the disassembler code for the function you selected.

Using the Disassembler Code window: The Disassembler Code window shows you only the disassembler code for the function you specified from the Flat Profile window. The **Disassembler Code** window looks similar to the following:

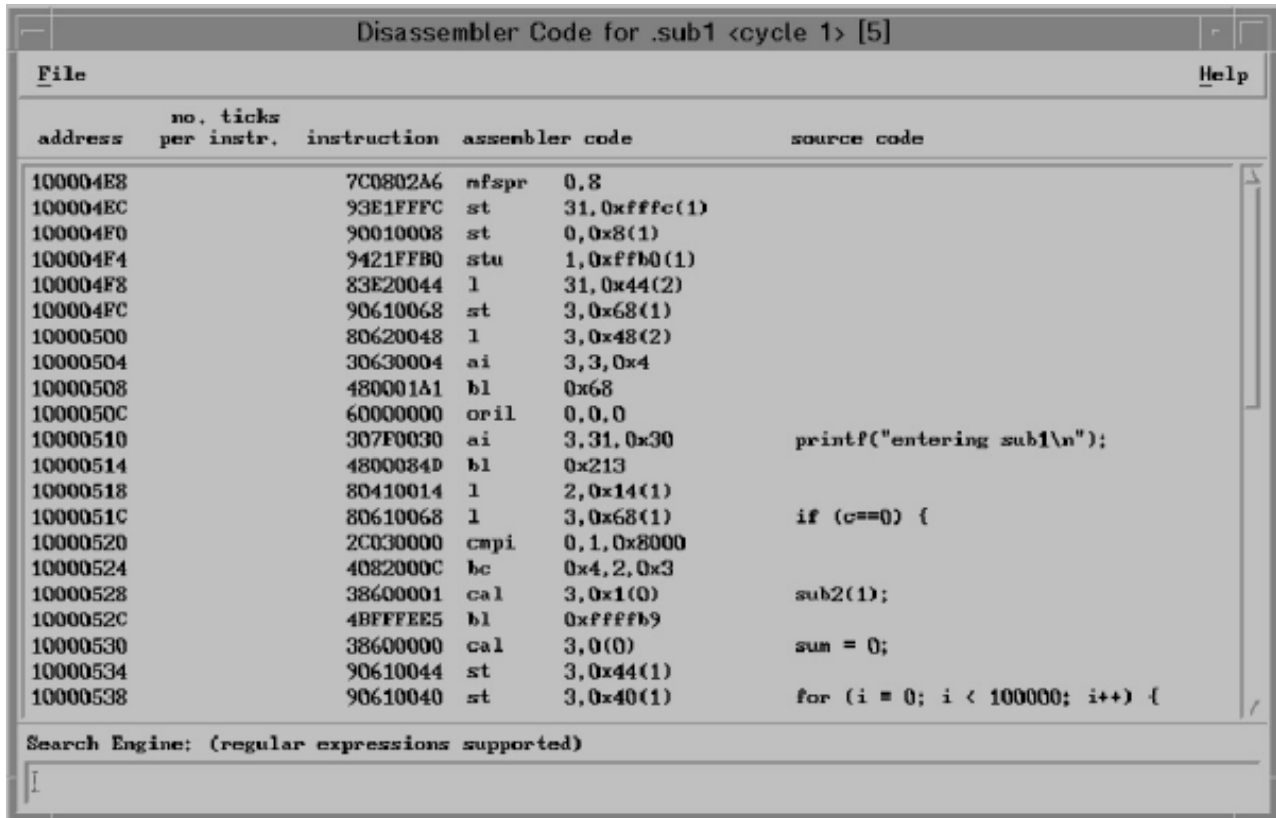

Figure 26. The Disassembler Code window. The following screen capture shows an example of the Disassembler Code window. There is a menu bar at the top with the following options: File, and Help. There are five fields that are described in greater detail below the graphic.

The Disassembler Code window contains information in the following fields:

- **address**
The address of each instruction in the function you selected (from either the **Flat Profile** window or the function call tree).
- **no. ticks per instr.**
Each tick represents .01 seconds of CPU time used. The value in this field represents the number of ticks used by the corresponding instruction. For instance, if the number 3 appeared in this field, this instruction would have used .03 seconds of CPU time.
- **instruction**
The execution instruction.
- **assembler code**
The execution instruction's corresponding assembler code.
- **source code**
The line in your application's source code that corresponds to the execution instruction and assembler code. In order for information to appear in this field, you must have compiled your application with the **-g** flag.

The **Search Engine** field at the bottom of the **Disassembler Code** window lets you search for a specific string in your disassembler code.

The **Disassembler Code** window contains one menu:

- **File**

Select **Save As** to save the annotated disassembler code to a file. When you select this option, the **Save File Dialog** window appears. For information on using the **Save File Dialog** window, see “Saving the Call Graph Profile, Function Index, and Flat Profile reports to a file” on page 49.

To close the **Disassembler Code** window, select **Close**.

Saving Screen Images of Profiled Data

The **File** menu of the Xprofiler GUI includes an option called **Screen Dump** that lets you capture an image of the Xprofiler main window. This option is useful if you want to save a copy of the graphical display to refer to later. You can either save the image as a file in PostScript format, or send it directly to a printer.

To capture a window image, do the following:

1. Select **File** and then **Screen Dump**. The **Screen Dump** menu opens.
2. From the **Screen Dump** menu, select **Set Option**. The Screen Dump Options Dialog window appears.

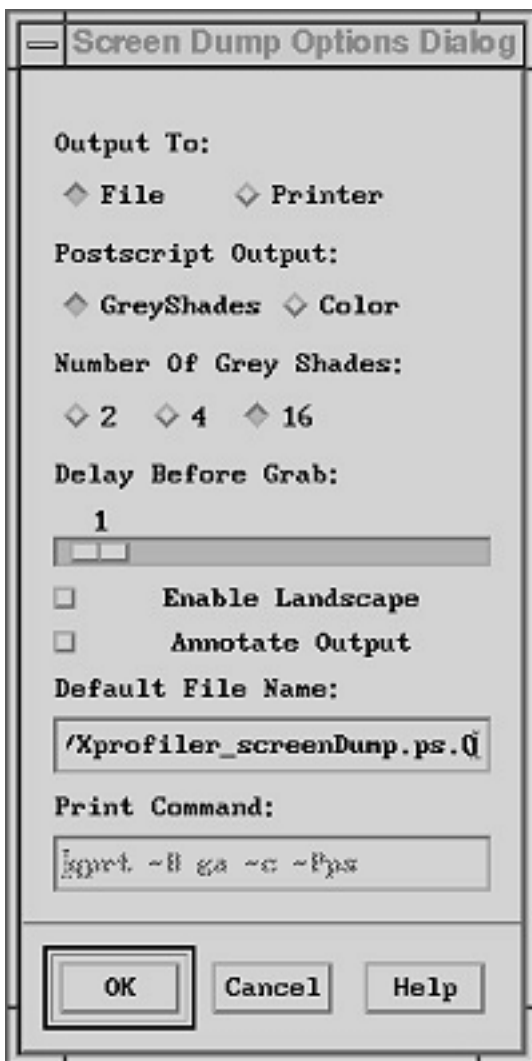

Figure 27. The Screen Dump Options Dialog window. The screen capture below shows an example of the Screen Dump Options Dialog window. Each section of the Screen Dump Options Dialog window is described in greater detail below the graphic.

3. Make the appropriate selections in the fields of the **Screen Dump Options Dialog** window, as follows:
 - **Output To:**

This option lets you specify whether you want to save the captured image as a PostScript file or send it directly to a printer.

If you would like to save the image to a file, select the **File** button. This file, by default, is named **Xprofiler.screenDump.ps.0**, and is displayed in the **Default File Name** field of this dialog window. When you select the **File** button, the text in the **Print Command** field greys out.

To send the image directly to a printer, select the **Printer** button. The image is sent to the printer you specify in the **Print Command** field of this dialog window. When you specify the **Print** option, a file of the image is not saved. Also, selecting this option causes the text in the **Default File Name** field is made unavailable.

- **PostScript Output:**

This option lets you specify whether you want to capture the image in shades of grey or in color.

If you want to capture the image in shades of grey, select the **GreyShades** button. You must also select the number of shades you want the image to include with the **Number of Grey Shades** option, as discussed below.

If you want to capture the image in color, select the **Color** button.

- **Number of Grey Shades**

This option lets you specify the number of grey shades that the captured image will include. Select either the 2, 4, or 16 buttons, depending on the number of shades you want to use. Typically, the more shades you use, the longer it will take to print the image.

- **Delay Before Grab**

This option lets you specify how much of a delay will occur between activating the capturing mechanism and when the image is actually captured. By default, the delay is set to one second, but you may need time to arrange the window the way you want it. Setting the delay to a longer interval gives you some extra time to do this. You set the delay with the slider bar of this field. The number above the slider indicates the time interval in seconds. You can set the delay to a maximum of thirty seconds.

- **Enable Landscape** (button)

This option lets you specify that you want the output to be in landscape format (the default is portrait). To select landscape format, select the **Enable Landscape** button.

- **Annotate Output** (button)

This option lets you specify that you would like information about how the file was created to be included in the PostScript image file. By default, this information is not included. To include this information, select the **Annotate Output** button.

- **Default File Name** (field)

If you chose to put your output in a file, this field lets you specify the file name. The default file name is **Xprofiler.screenDump.ps.0**. If you want to change to a different file name, type it over the one that appears in this field.

If you specify the output file name with an integer suffix (that is, the file name ends with *xxx.nn*, where *nn* is a non-negative integer), the suffix automatically increases by one every time a new output file is written in the same Xprofiler session.

- **Print Command** (field)

If you chose to send the captured image directly to a printer, this field lets you specify the print command. The default print command is **qprt -B ga -c -Pps**. If you want to use a different command, type the new command over the one that appears in this field.

4. Click **OK**. The **Screen Dump Options Dialog** window closes.

After you have set your screen dump options, you need to select the window, or portion of a window, you want to capture. From the **Screen Dump** menu, select the **Select Target Window** option. A cursor that looks like a person's hand appears after the number of seconds you specified. To cancel the capture, click the right mouse button. The hand-shaped cursor will revert to normal and the operation will be terminated.

To capture the entire Xprofiler window, place the cursor in the window and then click the left mouse button.

To capture a portion of the Xprofiler window, do the following:

1. Place the cursor in the upper left corner of the area you want to capture.
2. Press and hold the middle mouse button and drag the cursor diagonally downward, until the area you want to capture is within the rubberband box.
3. Release the middle mouse button to set the location of the rubberband box.
4. Press the left mouse button to capture the image.

If you chose to save the image as a file, the file is stored in the directory that you specified. If you chose to print the image, the image is sent to the printer you specified.

Customizing Xprofiler Resources

You can customize certain features of an X-Window. For example, you can customize its colors, fonts, and orientation. This section lists each of the resource variables you can set for Xprofiler.

You can customize resources by assigning a value to a resource name in a standard X-Windows format. Several resource files are searched according to the following X-Windows convention:

```
/usr/lib/X11/$LANG/app-defaults/Xprofiler
/usr/lib/X11/app-defaults/Xprofiler
$XAPPLRESDIR/Xprofiler
$HOME/.Xdefaults
```

Options in the **.Xdefaults** file take precedence over entries in the preceding files. This allows you to have certain specifications apply to all users in the **app-defaults** file, as well as user-specific preferences set for each user in their **\$HOME/.Xdefaults** file.

You customize a resource by setting a value to a *resource variable* associated with that feature. You store these *resource settings* in a file called **.Xdefaults** in your home directory. You can create this file on a server, and so customize a resource for all users. Individual users may also want to customize resources. The resource settings are essentially your personal preferences for how the X-Windows should look.

For example, consider the following resource variables for a hypothetical X-Windows tool:

```
TOOL*MainWindow.foreground:
TOOL*MainWindow.background:
```

In this example, suppose the resource variable *TOOL*MainWindow.foreground* controls the color of text on the tool's main window. The resource variable *TOOL*MainWindow.background* controls the background color of this same window. If you wanted the tool's main window to have red lettering on a white background, you would insert these lines into the **.Xdefaults** file:

```
TOOL*MainWindow.foreground:   red
TOOL*MainWindow.background:   white
```

Customizable resources and instructions for their use for Xprofiler are defined in **/usr/lib/X11/app-defaults/Xprofiler** file, as well as **/usr/lpp/ppe.xprofiler/defaults/Xprofiler.ad** file. This file contains a set of X-Windows resources for defining graphical user interfaces based on the following criteria:

- Window geometry
- Window title
- Push button and label text
- Color maps
- Text font (in both textual reports and the graphical display)

Xprofiler Resource Variables

You can use the following resource variables to control the appearance and behavior of Xprofiler. The values listed in this section are the defaults; you can change these values to suit your preferences.

Controlling Fonts

To specify the font for the labels that appear with function boxes, call arcs, and cluster boxes:

Use this resource variable:	Specify this default, or a value of your choice:
*narc*font	fixed

To specify the font used in textual reports:

Use this resource variable:	Specify this default, or a value of your choice:
Xprofiler*fontList	rom10

Controlling the Appearance of the Xprofiler Main Window

To specify the size of the main window:

Use this resource variable:	Specify this default, or a value of your choice:
Xprofiler*mainW.height	700
Xprofiler*mainW.width	900

To specify the foreground and background colors of the main window:

Use this resource variable:	Specify this default, or a value of your choice:
Xprofiler*foreground	black
Xprofiler*background	light grey

To specify the number of function boxes that are displayed when you first open the Xprofiler main window:

Use this resource variable:	Specify this default, or a value of your choice:
Xprofiler*InitialDisplayGraph	5000

You can use the **-disp_max** flag to override this value.

To specify the colors of the function boxes and call arcs of the function call tree:

Use this resource variable:	Specify this default, or a value of your choice:
Xprofiler*defaultNodeColor	forest green
Xprofiler*defaultArcColor	royal blue

To specify the color in which a specified function box or call arc is highlighted:

Use this resource variable:	Specify this default, or a value of your choice:
Xprofiler*HighlightNode	red
Xprofiler*HighlightArc	red

To specify the color in which de-emphasized function boxes appear:

Use this resource variable:	Specify this default, or a value of your choice:
Xprofiler*SuppressNode	grey

Function boxes are deemphasized with the **-e**, **-E**, **-f**, and **-F** flags.

Controlling Variables Related to the File Menu

To specify the size of the Load Files Dialog window, use the following:

Use this resource variable:	Specify this default, or a value of your choice:
Xprofiler*loadFile.height	785
Xprofiler*loadFile.width	725

The **Load Files Dialog** window is called by the **Load Files** option of the **File** menu.

To specify whether a confirmation dialog box should appear whenever a file will be overwritten:

Use this resource variable:	Specify this default, or a value of your choice:
Xprofiler*OverwriteOK	False

The value True would be equivalent to selecting the **Set Options** option from the File menu, and then selecting the **Forced File Overwriting** option from the Runtime Options Dialog window.

To specify the alternative search paths for locating source or library files:

Use this resource variable:	Specify this default, or a value of your choice:
Xprofiler*fileSearchPath	. (refers to the current working directory)

The value you specify for the search path is equivalent to the search path you would designate from the Alt File Search Path Dialog window. To get to this window, choose the **Set File Search Paths** option from the File menu.

To specify the file search sequence (whether the default or alternative path is searched first):

Use this resource variable:	Specify this default, or a value of your choice:
Xprofiler*fileSearchDefault	True

The value True is equivalent to selecting the **Set File Search Paths** from the File menu, and then the **Check default path(s) first** option from the Alt File Search Path Dialog window.

Controlling variables related to the Screen Dump option: To specify whether a screen dump will be sent to a printer or placed in a file:

Use this resource variable:	Specify this default, or a value of your choice:
Xprofiler*PrintToFile	True

The value True is equivalent to selecting the **File** button in the **Output To** field of the Screen Dump Options Dialog window. You access the Screen Dump Options Dialog window by selecting **Screen Dump** and then **Set Option** from the File menu.

To specify whether the PostScript screen dump will be created in color or in shades of grey:

Use this resource variable:	Specify this default, or a value of your choice:
Xprofiler*ColorPscript	False

The value False is equivalent to selecting the **GreyShades** button in the **PostScript Output** area of the

Screen Dump Options Dialog window. You access the Screen Dump Options Dialog window by selecting **Screen Dump** and then **Set Option** from the File menu.

To specify the number of grey shades that the PostScript screen dump will include (if you selected **GreyShades** in the **PostScript Output** area):

Use this resource variable:	Specify this default, or a value of your choice:
Xprofiler*GreyShades	16

The value 16 is equivalent to selecting the **16** button in the **Number of Grey Shades** field of the Screen Dump Options Dialog window. You access the Screen Dump Options Dialog window by selecting **Screen Dump** and then **Set Option** from the File menu.

To specify the number of seconds that Xprofiler waits before capturing a screen image:

Use this resource variable:	Specify this default, or a value of your choice:
Xprofiler*GrabDelay	1

The value 1 is the default for the **Delay Before Grab** option of the Screen Dump Options Dialog window, but you can specify a longer interval by entering a value here. You access the Screen Dump Options Dialog window by selecting **Screen Dump** and then **Set Option** from the File menu.

To set the maximum number of seconds that can be specified with the slider of the **Delay Before Grab** option:

Use this resource variable:	Specify this default, or a value of your choice:
Xprofiler*grabDelayScale.maximum	30

The value 30 is the maximum for the **Delay Before Grab** option of the Screen Dump Options Dialog window. This means that users cannot set the slider scale to a value greater than 30. You access the Screen Dump Options Dialog window by selecting **Screen Dump** and then **Set Option** from the File menu.

To specify whether the screen dump is created in landscape or portrait format:

Use this resource variable:	Specify this default, or a value of your choice:
Xprofiler*Landscape	False

The value True is the default for the **Enable Landscape** option of the Screen Dump Options Dialog window. You access the Screen Dump Options Dialog window by selecting **Screen Dump** and then **Set Option** from the File menu.

To specify whether you would like information about how the image was created to be added to the PostScript screen dump:

Use this resource variable:	Specify this default, or a value of your choice:
Xprofiler*Annotate	False

The value False is the default for the **Annotate Output** option of the Screen Dump Options Dialog window. You access the Screen Dump Options Dialog window by selecting **Screen Dump** and then **Set Option** from the File menu.

To specify the directory that will store the screen dump file (if you selected **File** in the **Output To** field):

Use this resource variable:	Specify this default, or a value of your choice:
Xprofiler*PrintFileName	/tmp/Xprofiler_screenDump.ps.0

The value you specify is equivalent to the file name you would designate in the **File Name** field of the Screen Dump Dialog window. You access the Screen Dump Options Dialog window by selecting **Screen Dump** and then **Set Option** from the File menu.

To specify the printer destination of the screen dump (if you selected **Printer** in the **Output To** field):

Use this resource variable:	Specify this default, or a value of your choice:
Xprofiler*PrintCommand	qprt -B ga -c -Pps

The value qprt -B ga -c -Pps is the default print command, but you can supply a different one.

Controlling Variables Related to the View Menu

To specify the size of the **Overview** window:

Use this resource variable:	Specify this default, or a value of your choice:
Xprofiler*overviewMain.height	300
Xprofiler*overviewMain.width	300

To specify the color of the highlight area of the **Overview** window:

Use this resource variable:	Specify this default, or a value of your choice:
Xprofiler*overviewGraph*defaultHighlightColor	sky blue

To specify whether the function call tree is updated as the highlight area is moved (immediate) or only when it is stopped and the mouse button released (delayed):

Use this resource variable:	Specify this default, or a value of your choice:
Xprofiler*TrackImmed	True

The value True is equivalent to selecting the **Immediate Update** option from the Utility menu of the Overview window. You access the Overview window by selecting the **Overview** option from the View menu.

To specify whether the function boxes in the function call tree appear in two-dimensional or three-dimensional format:

Use this resource variable:	Specify this default, or a value of your choice:
Xprofiler*Shape2D	True

The value True is equivalent to selecting the **2-D Image** option from the View menu.

To specify whether the function call tree appears in top-to-bottom or left-to-right format:

Use this resource variable:	Specify this default, or a value of your choice:
Xprofiler*LayoutTopDown	True

The value True is equivalent to selecting the **Layout: Top** and **Bottom** option from the View menu.

Controlling Variables Related to the Filter Menu

To specify whether the function boxes of the function call tree are clustered or unclustered when the Xprofiler main window is first opened:

Use this resource variable:	Specify this default, or a value of your choice:
Xprofiler*ClusterNode	True

The value True is equivalent to selecting the **Cluster Functions by Library** option from the Filter menu.

To specify whether the call arcs of the function call tree are collapsed or expanded when the Xprofiler main window is first opened:

Use this resource variable:	Specify this default, or a value of your choice:
Xprofiler*ClusterArc	True

The value True is equivalent to selecting the **Collapse Library Arcs** option from the Filter menu.

Chapter 3. CPU Utilization Reporting Tool (curt)

The CPU Utilization Reporting Tool (**curt**) command converts an AIX trace file into a number of statistics related to CPU utilization and either process, thread or pthread activity. These statistics ease the tracking of specific application activity. The **curt** command works with both uniprocessor and multiprocessor AIX Version 4 and AIX Version 5 traces.

Syntax for the curt Command

The syntax for the **curt** command is as follows:

```
curt -i inputfile [-o outputfile] [-n gensymsfile] [-m trcnmfile] [-a pidnamefile] [-f timestamp] [-l timestamp] [-r PURR][-ehpstP]
```

Flags

-i <i>inputfile</i>	Specifies the input AIX trace file to be analyzed.
-o <i>outputfile</i>	Specifies an output file (default is stdout).
-n <i>gensymsfile</i>	Specifies a names file produced by gensyms .
-m <i>trcnmfile</i>	Specifies a names file produced by trcnm .
-a <i>pidnamefile</i>	Specifies a PID-to-process name mapping file.
-f <i>timestamp</i>	Starts processing trace at <i>timestamp</i> seconds.
-l <i>timestamp</i>	Stops processing trace at <i>timestamp</i> seconds.
-r <i>PURR</i>	Uses the PURR register to calculate CPU times.
-e	Outputs elapsed time information for system calls.
-h	Displays usage text (this information).
-p	Outputs detailed process information.
-s	Outputs information about errors returned by system calls.
-t	Outputs detailed thread information.
-P	Outputs detailed pthread information.

Parameters

gensymsfile	The names file as produced by the gensyms command.
inputfile	The AIX trace file to be processed by the curt command.
outputfile	The name of the output file created by the curt command.
pidnamefile	If the trace process name table is not accurate, or if more descriptive names are desired, use the -a flag to specify a PID to process name mapping file. This is a file with lines consisting of a process ID (in decimal) followed by a space, then an ASCII string to use as the name for that process.
timestamp	The time in seconds at which to start and stop the trace file processing.
trcnmfile	The names file as produced by the trcnm command.
PURR	The name of the register that is used to calculate CPU times.

Measurement and Sampling

A *raw*, or unformatted, system trace is read by the **curlt** command to produce CPU utilization summaries. The summary information is useful for determining which application, system call, NFS operation, hypervisor call, pthread call, or interrupt handler is using most of the CPU time and is a candidate for optimization to improve system performance.

The following table lists the minimum trace hooks required for the **curlt** command. Using only these trace hooks will limit the size of the trace file. However, other events on the system may not be captured in this case. This is significant if you intend to analyze the trace in more detail.

Hook ID	Event Name	Event Explanation
100	HKWD_KERN_FLIH	Occurrence of a first level interrupt, such as an I/O interrupt, a data access page fault, or a timer interrupt (scheduler).
101	HKWD_KERN_SVC	A thread has issued a system call.
102	HKWD_KERN_SLIH	Occurrence of a second level interrupt, that is, first level I/O interrupts are being passed on to the second level interrupt handler which then is working directly with the device driver.
103	HKWD_KERN_SLIHRET	Return from a second level interrupt to the caller (usually a first level interrupt handler).
104	HKWD_KERN_SYSCRET	Return from a system call to the caller (usually a thread).
106	HKWD_KERN_DISPATCH	A thread has been dispatched from the run queue to a CPU.
10C	HKWD_KERN_IDLE	The idle process has been dispatched.
119	HKWD_KERN_PIDSIG	A signal has been sent to a process.
134	HKWD_SYSC_EXECVE	An exec supervisor call (SVC) has been issued by a (forked) process.
135	HKWD_SYSC__EXIT	An exit supervisor call (SVC) has been issued by a process.
139	HKWD_SYSC_FORK	A fork SVC has been issued by a process.
200	HKWD_KERN_RESUME	A dispatched thread is being resumed on the CPU.
210	HKWD_KERN_INITP	A kernel process has been created.
215	HKWD_NFS_DISPATCH	An entry or exit NFS operation has been issued by a process.
38F	HKWD_DR	A processor has been added/removed.
419	HKWD_CPU_PREEMPT	A processor has been preempted.
465	HKWD_SYSC_CRTTHREAD	A thread_create SVC has been issued by a process.
47F	HKWD_KERN_PHANTOM_EXTINT	A phantom interrupt has occurred.
492	HKWD_KERN_HCALL	A hypervisor call has been issued by the kernel.
605	HKWD_PTHREAD_VPSLEEP	A pthread vp_sleep operation has been done by a pthread.
609	HKWD_PTHREAD_GENERAL	A general pthread operation has been done by a pthread.

Trace hooks 119 and 135 are used to report on the time spent in the **exit** system call. Trace hooks 134, 139, 210, and 465 are used to keep track of TIDs, PIDs and process names.

Trace hook 492 is used to report on the time spent in the hypervisor.

Trace hooks 605 and 609 are used to report on the time spent in the pthreads library.

To get the PTHREAD hooks in the trace, you must execute your pthread application using the instrumented **libpthreads.a** library.

Examples of the `curl` command

Preparing the `curl` command input is a three-stage process.

Trace and name files are generated using the following process:

1. **Build the raw trace.**

On a 4-way machine, this will create files as listed in the example code below. One raw trace file per CPU is produced. The files are named `trace.raw-0`, `trace.raw-1`, and so forth for each CPU. An additional file named `trace.raw` is also generated. This is a master file that has information that ties together the other CPU-specific traces.

Note: If you want pthread information in the `curl` report, you must add the instrumented `libpthread` directory to the library path, `LIBPATH`, when you build the trace. Otherwise, the `export LIBPATH` statement in the example below is unnecessary.

2. **Merge the trace files.**

To merge the individual CPU raw trace files to form one trace file, run the `trcrpt` command. If you are tracing a uniprocessor machine, this step is not necessary.

3. **Create the supporting `gensymsfile` and `trcnmfile` files by running the `gensyms` and `trcnm` commands.**

Neither the `gensymsfile` nor the `trcnmfile` file are necessary for the `curl` command to run. However, if you provide one or both of these files, or if you use the `trace` command with the `-n` option, the `curl` command outputs names for system calls and interrupt handlers instead of just addresses. The `gensyms` command output includes more information than the `trcnm` command output, and so, while the `trcnmfile` file will contain most of the important address to name mapping data, a `gensymsfile` file will enable the `curl` command to output more names, and is the preferred address to name mapping data collection command.

The following is an example of how to generate input files for the `curl` command:

```
# HOOKS="100,101,102,103,104,106,10C,119,134,135,139,200,210,215,38F,419,465,47F,492,605,609"
# SIZE="1000000"
# export HOOKS SIZE
# trace -n -C all -d -j $HOOKS -L $SIZE -T $SIZE -afo trace.raw
# export LIBPATH=/usr/ccs/lib/perf:$LIBPATH
# trcon ; pthread.app ; trcstop
# unset HOOKS SIZE
# ls trace.raw*
trace.raw  trace.raw-0  trace.raw-1  trace.raw-2  trace.raw-3
# trcrpt -C all -r trace.raw > trace.r
# rm trace.raw*
# ls trace*
trace.r
# gensyms > gensyms.out
# trcnm > trace.nm
```

Overview of Information Generated by the `curl` Command

The following is an overview of the content of the report that the `curl` command generates:

- A report header, including the trace file name, the trace size, and the date and time the trace was taken. The header also includes the command that was used when the trace was run. If the `PURR` register was used to calculate CPU times, this information is also included in the report header.
- For each CPU (and a summary of all the CPUs), processing time expressed in milliseconds and as a percentage (idle and non-idle percentages are included) for various CPU usage categories.
- For each CPU (and a summary of all the CPUs), processing time expressed in milliseconds and as a percentage for CPU usage in application mode for various application usage categories.
- Average thread affinity across all CPUs and for each individual CPU.
- For each CPU (and for all the CPUs), the Physical CPU time spent and the percentage of total time this represents.

- Average physical CPU affinity across all CPUs and for each individual CPU.
- The physical CPU dispatch histogram of each CPU.
- The number of preemptions, and the number of **H_CEDE** and **H_CONFER** hypervisor calls for each individual CPU.
- The total number of idle and non-idle process dispatches for each individual CPU.
- Average pthread affinity across all CPUs and for each individual CPU.
- The total number of idle and non-idle pthread dispatches for each individual CPU.
- Information on the amount of CPU time spent in application and system call (**syscall**) mode expressed in milliseconds and as a percentage by thread, process, and process type. Also included are the number of threads per process and per process type.
- Information on the amount of CPU time spent executing each kernel process, including the idle process, expressed in milliseconds and as a percentage of the total CPU time.
- Information on the amount of CPU time spent executing calls to **libpthread**, expressed in milliseconds and as percentages of the total time and the total application time.
- Information on completed system calls that includes the name and address of the system call, the number of times the system call was executed, and the total CPU time expressed in milliseconds and as a percentage with average, minimum, and maximum time the system call was running.
- Information on pending system calls, that is, system calls for which the system call return has not occurred at the end of the trace. The information includes the name and address of the system call, the thread or process which made the system call, and the accumulated CPU time the system call was running expressed in milliseconds.
- Information on completed hypervisor calls that includes the name and address of the hypervisor call, the number of times the hypervisor call was executed, and the total CPU time expressed in milliseconds and as a percentage with average, minimum, and maximum time the hypervisor call was running.
- Information on pending hypervisor calls, which are hypervisor calls that were not completed by the end of the trace. The information includes the name and address of the hypervisor call, the thread or process which made the hypervisor call, and the accumulated CPU time the hypervisor call was running, expressed in milliseconds.
- Information on completed pthread calls that includes the name of the pthread call routine, the number of times the pthread call was executed, and the total CPU time expressed in milliseconds and the average, minimum, and maximum time the pthread call was running.
- Information on pending pthread calls, that is, pthread calls for which the pthread call return has not occurred at the end of the trace. The information includes the name of the pthread call, the process, the thread and the pthread which made the pthread call, and the accumulated CPU time the pthread call was running expressed in milliseconds.
- Information on completed NFS operations that includes the name of the NFS operation, the number of times the NFS operation was executed, and the total CPU time, expressed in milliseconds, and as a percentage with average, minimum, and maximum time the NFS operation call was running.
- Information on pending NFS operations, where the NFS operations did not complete before the end of the trace. The information includes the sequence number, the thread or process which made the NFS operation and the accumulated CPU time the NFS operation was running. expressed in milliseconds.
- Information on the first level interrupt handlers (FLIHs) that includes the type of interrupt, the number of times the interrupt occurred, and the total CPU time spent handling the interrupt with average, minimum, and maximum time. This information is given for all CPUs and for each individual CPU. If there are any pending FLIHs (FLIHs for which the resume has not occurred at the end of the trace), for each CPU the accumulated time and the pending FLIH type is reported.
- Information on the second level interrupt handlers (SLIHs), which includes the interrupt handler name and address, the number of times the interrupt handler was called, and the total CPU time spent handling the interrupt with average, minimum, and maximum time. This information is given for all CPUs

and for each individual CPU. If there are any pending SLIHs (SLIHs for which the return has not occurred at the end of the trace), the accumulated time and the pending SLIH name and address is reported for each CPU.

To create additional, specialized reports, run the **curl** command using the following flags:

- e** Produces reports containing statistics and additional information on the System Calls Summary Report, Pending System Calls Summary Report, Hypervisor™ Calls Summary Report, Pending Hypervisor Calls Summary Report, System NFS Calls Summary Report, Pending NFS Calls Summary, Pthread Calls Summary, and the Pending Pthread Calls Summary. The additional information pertains to the total, average, maximum, and minimum elapsed times that a system call was running.
- s** Produces a report containing a list of errors returned by system calls.
- t** Produces a report containing a detailed report on thread status that includes the amount of CPU time the thread was in application and system call mode, what system calls the thread made, processor affinity, the number of times the thread was dispatched, and to which CPU(s) it was dispatched. The report also includes dispatch wait time and details of interrupts.
- p** Produces a report containing a detailed report on process status that includes the amount of CPU time the process was in application and system call mode, application time details, threads that were in the process, pthreads that were in the process, pthread calls that the process made and system calls that the process made.
- P** Produces a report containing a detailed report on pthread status that includes the amount of CPU time the pthread was in application and system call mode, system calls made by the pthread, pthread calls made by the pthread, processor affinity, the number of times the pthread was dispatched and to which CPU(s) it was dispatched, thread affinity, and the number of times the pthread was dispatched and to which kernel thread(s) it was dispatched. The report also includes dispatch wait time and details of interrupts.

Default Report Generated by the curl Command

This section explains the default report created by the **curl** command, as follows:

```
# curl -i trace.r -n gensyms.out -o curl.out
```

The **curl** command output always includes this default report in its output, even if one of the flags described in the previous section is used.

The report is divided into the following sections:

- General Information
- System Summary
- System Application Summary
- Processor Summary
- Processor Application Summary
- Application Summary by TID
- Application Summary by PID
- Application Summary by Process Type
- Kproc Summary
- Application Pthread Summary by PID
- System Calls Summary
- Pending System Calls Summary
- Hypervisor Calls Summary
- Pending Hypervisor Calls Summary
- System NFS Calls Summary
- Pending NFS System Calls Summary

- Pthread Calls Summary
- Pending Pthread Calls Summary
- FLIH Summary
- SLIH Summary

General Information

The General Information section begins with the time and date when the report was generated. It is followed by the syntax of the **curl** command line that was used to produce the report.

This section also contains some information about the AIX **trace** file that was processed by the **curl** command. This information consists of the **trace** file's name, size, and its creation date. The command used to invoke the AIX trace facility and gather the trace file is displayed at the end of the report.

The following is a sample of the general information section:

```
Run on Fri May 25 11:08:46 2001
Command line was:
curl -i trace.r -n gensyms.out -o curt.out
-----
AIX trace file name = trace.r
AIX trace file size = 1632496
AIX trace file created = Fri May 25 11:04:33 2001
```

```
Command used to gather AIX trace was:
trace -n -C all -d -j 100,101,102,103,104,106,10C,134,139,200,215,419,465,47F,492, 605,609 -L 1000000 -T 1000000 -afo trace.raw
```

System Summary

The next section of the default report is the System Summary produced by the **curl** command. The following is a sample of the System Summary:

System Summary			
processing total time (msec)	percent total time (incl. idle)	percent busy time (excl. idle)	processing category
4998.65	45.94	75.21	APPLICATION
591.59	5.44	8.90	SYSCALL
110.40	1.02	1.66	HCALL
48.33	0.44	0.73	KPROC (excluding IDLE and NFS)
352.23	3.24	5.30	NFS
486.19	4.47	7.32	FLIH
49.10	0.45	0.74	SLIH
8.83	0.08	0.13	DISPATCH (all procs. incl. IDLE)
1.04	0.01	0.02	IDLE DISPATCH (only IDLE proc.)
-----	-----	-----	
6646.36	61.08	100.00	CPU(s) busy time
4234.76	38.92		IDLE
-----	-----		
10881.12			TOTAL

Avg. Thread Affinity = 0.99

Total Physical CPU time (msec) = 20417.45

Physical CPU percentage = 100.00%

This portion of the report describes the time spent by the whole system (all CPUs) in various execution modes.

The System Summary has the following fields:

processing total time Total time in milliseconds for the corresponding processing category.

percent total time	Time from the first column as a percentage of the sum of total trace elapsed time for all processors. This includes whatever amount of time each processor spent running the IDLE process.
percent busy time	Time from the first column as a percentage of the sum of total trace elapsed time for all processors without including the time each processor spent executing the IDLE process.
Avg. Thread Affinity	Probability that a thread was dispatched to the same processor on which it last executed.
Total Physical CPU time	The real time that the virtual processor was running and not preempted.
Physical CPU percentage	Gives the Physical CPU Time as a percentage of total time.

The possible execution modes or processing categories are interpreted as follows:

APPLICATION	The sum of times spent by all processors in User (that is, non-privileged) mode.
SYSCALL	The sum of times spent by all processors doing System Calls. This is the portion of time that a processor spends executing in the kernel code providing services directly requested by a user process.
HCALL	The sum of times spent by all processors doing Hypervisor Calls. This is the portion of time that a processor spends executing in the hypervisor code providing services directly requested by the kernel.
KPROC	The sum of times spent by all processors executing kernel processes other than IDLE and NFS processes. This is the portion of time that a processor spends executing specially created dispatchable processes that only execute kernel code.
NFS	The sum of times spent by all processors executing NFS operations. This is the portion of time that a processor spends executing in the kernel code providing NFS services directly requested by a kernel process.
FLIH	The sum of times spent by all processors executing FLIHs.
SLIH	The sum of times spent by all processors executing SLIHs.
DISPATCH	The sum of times spent by all processors executing the AIX dispatch code. This sum includes the time spent dispatching all threads (that is, it includes dispatches of the IDLE process).
IDLE DISPATCH	The sum of times spent by all processors executing the AIX dispatch code where the process being dispatched was the IDLE process. Because the DISPATCH category includes the IDLE DISPATCH category's time, the IDLE DISPATCH category's time is not separately added to calculate either CPU(s) busy time or TOTAL (see below).
CPU(s) busy time	The sum of times spent by all processors executing in APPLICATION, SYSCALL, KPROC, FLIH, SLIH, and DISPATCH modes.
IDLE	The sum of times spent by all processors executing the IDLE process.
TOTAL	The sum of CPU(s) busy time and IDLE.

The System Summary example indicates that the CPU is spending most of its time in application mode. There is still 4234.76 ms of IDLE time so there is enough CPU to run applications. If there is insufficient CPU power, do not expect to see any IDLE time. The Avg. Thread Affinity value is 0.99 showing good processor affinity; that is, threads returning to the same processor when they are ready to be run again.

System Application Summary

The next part of the default report is the System Application Summary produced by the **curt** command. The following is a sample of the System Application Summary:

```

                System Application Summary
                -----
processing    percent    percent

```

total time (msec)	total time (incl. idle)	application time	processing category
3.95	0.42	0.07	PTHREAD
4.69	0.49	0.09	PDISPATCH
0.13	0.01	0.00	PIDLE
5356.99	563.18	99.84	OTHER
5365.77	564.11	100.00	APPLICATION

Avg. Pthread Affinity = 0.84

This portion of the report describes the time spent by the system as a whole (all CPUs) in various execution modes. The System Application Summary has the following fields:

- processing total time** Total time in milliseconds for the corresponding processing category.
- percent total time** Time from the first column as a percentage of the sum of total trace elapsed time for all processors. This includes whatever amount of time each processor spent running the IDLE process.
- percent application time** Time from the first column as a percentage of the sum of total trace elapsed application time for all processors
- Avg. Pthread Affinity** Probability that a pthread was dispatched on the same kernel thread on which it last executed.

The possible execution modes or processing categories are interpreted as follows:

- PTHREAD** The sum of times spent by all pthreads on all processors in traced pthread library calls.
- PDISPATCH** The sum of times spent by all pthreads on all processors executing the libpthreads dispatch code.
- PIDLE** The sum of times spent by all kernel threads on all processors executing the **libpthreads vp_sleep** code.
- OTHER** The sum of times spent by all pthreads on all processors in non-traced user mode.
- APPLICATION** The sum of times spent by all processors in User (that is, non-privileged) mode.

Processor Summary and Processor Application Summary

This part of the **curlt** command output follows the System Summary and System Application Summary and is essentially the same information but presented on a processor-by-processor basis. The same description that was given for the System Summary and System Application Summary applies here, except that this report covers each processor rather than the whole system.

Below is a sample of this output:

Processor Summary processor number 0			
processing total time (msec)	percent total time (incl. idle)	percent busy time (excl. idle)	processing category
45.07	0.88	5.16	APPLICATION
591.39	11.58	67.71	SYSCALL
0.00	0.00	0.00	HCALL
47.83	0.94	5.48	KPROC (excluding IDLE and NFS)
0.00	0.00	0.00	NFS
173.78	3.40	19.90	FLIH
9.27	0.18	1.06	SLIH
6.07	0.12	0.70	DISPATCH (all procs. incl. IDLE)
1.04	0.02	0.12	IDLE DISPATCH (only IDLE proc.)

```

-----
      873.42      17.10      100.00 CPU(s) busy time
      4232.92      82.90
-----
      5106.34
-----
TOTAL

```

Avg. Thread Affinity = 0.98

Total number of process dispatches = 1620

Total number of idle dispatches = 782

Total Physical CPU time (msec) = 3246.25

Physical CPU percentage = 63.57%

Physical processor affinity = 0.50

Dispatch Histogram for processor (PHYSICAL CPUid : times_dispatched).

PROC 0 : 15

PROC 24 : 15

Total number of preemptions = 30

Total number of H_CEDE = 6 with preemption = 3

Total number of H_CONFER = 3 with preemption = 2

Processor Application Summary processor 0

```

-----
processing      percent      percent
total time      total time  application
(msec) (incl. idle)  time  processing category
=====
      1.66      0.04      0.06 PTHREAD
      2.61      0.05      0.10 PDISPATCH
      0.00      0.00      0.00 PIDLE
      2685.12      56.67      99.84 OTHER
-----
      2689.39      56.76      100.00 APPLICATION
-----

```

Avg. Pthread Affinity = 0.78

Total number of pthread dispatches = 104

Total number of pthread idle dispatches = 0

Processor Summary processor number 1

```

-----
processing      percent      percent
total time      total time  busy time
(msec) (incl. idle) (excl. idle) processing category
=====
      4985.81      97.70      97.70 APPLICATION
      0.09      0.00      0.00 SYSCALL
      0.00      0.00      0.00 HCALL
      0.00      0.00      0.00 KPROC (excluding IDLE and NFS)
      0.00      0.00      0.00 NFS
      103.86      2.04      2.04 FLIH
      12.54      0.25      0.25 SLIH
      0.97      0.02      0.02 DISPATCH (all procs. incl. IDLE)
      0.00      0.00      0.00 IDLE DISPATCH (only IDLE proc.)
-----
      5103.26      100.00      100.00 CPU(s) busy time
      0.00      0.00
-----
      5103.26
-----
TOTAL

```

Avg. Thread Affinity = 0.99

Total number of process dispatches = 516

Total number of idle dispatches = 0

```

Total Physical CPU time (msec) = 5103.26
Physical CPU percentage       = 100.00%
Physical processor affinity   = 1.00
Dispatch Histogram for processor (PHYSICAL CPUid : times_dispatched).
Total number of preemptions = 0
Total number of H_CEDE      = 0      with preemption = 0
Total number of H_CONFER    = 0      with preemption = 0

```

```

Processor Application Summary processor 1
-----
processing      percent      percent
total time     total time  application
(msec)         (incl. idle) time      processing category
=====
2.29           0.05        0.09      PTHREAD
2.09           0.04        0.08      PDISPATCH
0.13           0.00        0.00      PIDLE
2671.86        56.40       99.83     OTHER
-----
2676.38        56.49       100.00    APPLICATION

```

Avg. Pthread Affinity = 0.83

```

Total number of pthread dispatches = 91
Total number of pthread idle dispatches = 5

```

The following terms are referred to in the example above:

Total number of process dispatches

The number of times AIX dispatched any non-IDLE process on the processor.

Total number of idle dispatches

The number of IDLE process dispatches.

Total number of pthread dispatches

The number of times the libpthreads dispatcher was executed on the processor.

Total number of pthread idle dispatches

The number of **vp_sleep** calls.

Application Summary by Thread ID (Tid)

The Application Summary, by Tid, shows an output of all the threads that were running on the system during the time of trace collection and their CPU consumption. The thread that consumed the most CPU time during the time of the trace collection is at the top of the list.

```

Application Summary (by Tid)
-----
-- processing total (msec) -- -- percent of total processing time --
combined application syscall combined application syscall name (Pid Tid)
=====
4986.2355 4986.2355 0.0000 24.4214 24.4214 0.0000 cpu(18418 32437)
4985.8051 4985.8051 0.0000 24.4193 24.4193 0.0000 cpu(19128 33557)
4982.0331 4982.0331 0.0000 24.4009 24.4009 0.0000 cpu(18894 28671)
83.8436 2.5062 81.3374 0.4106 0.0123 0.3984 disp+work(20390 28397)
72.5809 2.7269 69.8540 0.3555 0.0134 0.3421 disp+work(18584 32777)
69.8023 2.5351 67.2672 0.3419 0.0124 0.3295 disp+work(19916 33033)
63.6399 2.5032 61.1368 0.3117 0.0123 0.2994 disp+work(17580 30199)
63.5906 2.2187 61.3719 0.3115 0.0109 0.3006 disp+work(20154 34321)
62.1134 3.3125 58.8009 0.3042 0.0162 0.2880 disp+work(21424 31493)
60.0789 2.0590 58.0199 0.2943 0.0101 0.2842 disp+work(21992 32539)

```

...(lines omitted)...

The output is divided into two main sections:

- The total processing time of the thread in milliseconds (processing total (msec))
- The CPU time that the thread has consumed, expressed as a percentage of the total CPU time (percent of total processing time)

The Application Summary (by Tid) has the following fields:

name (Pid Tid) The name of the process associated with the thread, its process id, and its thread id.

processing total (msec)

combined The total amount of CPU time, expressed in milliseconds, that the thread was running in either application mode or system call mode.

application The amount of CPU time, expressed in milliseconds, that the thread spent in application mode.

syscall The amount of CPU time, expressed in milliseconds, that the thread spent in system call mode.

percent of total processing time

combined The amount of CPU time that the thread was running, expressed as percentage of the total processing time.

application The amount of CPU time that the thread the thread spent in application mode, expressed as percentage of the total processing time.

syscall The amount of CPU time that the thread spent in system call mode, expressed as percentage of the total processing time.

In the example above, we can investigate why the system is spending so much time in application mode by looking at the Application Summary (by Tid), where we can see the top three processes of the report are named **cpu**, a test program that uses a great deal of CPU time. The report shows again that the CPU spent most of its time in application mode running the **cpu** process. Therefore the **cpu** process is a candidate to be optimized to improve system performance.

Application Summary by Process ID (Pid)

The Application Summary, by Pid, has the same content as the Application Summary, by Tid, except that the threads that belong to each process are consolidated and the process that consumed the most CPU time during the monitoring period is at the beginning of the list.

The name (PID) (Thread Count) column shows the process name, its process ID, and the number of threads that belong to this process and that have been accumulated for this line of data.

```

Application Summary (by Pid)
-----
-- processing total (msec) --   -- percent of total processing time --
combined  application  syscall  combined  application  syscall  name (Pid)(Thread Count)
=====  =====  =====  =====  =====  =====  =====
4986.2355  4986.2355  0.0000  24.4214   24.4214   0.0000  cpu(18418) (1)
4985.8051  4985.8051  0.0000  24.4193   24.4193   0.0000  cpu(19128) (1)
4982.0331  4982.0331  0.0000  24.4009   24.4009   0.0000  cpu(18894) (1)
 83.8436   2.5062  81.3374   0.4106    0.0123   0.3984  disp+work(20390) (1)
 72.5809   2.7269  69.8540   0.3555    0.0134   0.3421  disp+work(18584) (1)
 69.8023   2.5351  67.2672   0.3419    0.0124   0.3295  disp+work(19916) (1)
 63.6399   2.5032  61.1368   0.3117    0.0123   0.2994  disp+work(17580) (1)
 63.5906   2.2187  61.3719   0.3115    0.0109   0.3006  disp+work(20154) (1)

```

```

62.1134      3.3125 58.8009   0.3042      0.0162  0.2880 disp+work(21424) (1)
60.0789      2.0590 58.0199   0.2943      0.0101  0.2842 disp+work(21992) (1)

```

...(lines omitted)...

Application Summary (by process type)

The Application Summary (by process type) consolidates all processes of the same name and sorts them in descending order of combined processing time.

The name (thread count) column shows the name of the process, and the number of threads that belong to this process name (type) and were running on the system during the monitoring period.

Application Summary (by process type)

```

-----
-- processing total (msec) --      -- percent of total processing time --
combined application syscall  combined application syscall  name (thread count)
-----
14954.0738  14954.0738  0.0000  73.2416  73.2416  0.0000  cpu(3)
573.9466    21.2609    552.6857  2.8111   0.1041   2.7069  disp+work(9)
20.9568     5.5820    15.3748  0.1026   0.0273   0.0753  trcstop(1)
10.6151     2.4241     8.1909   0.0520   0.0119   0.0401  i4llmd(1)
8.7146      5.3062     3.4084   0.0427   0.0260   0.0167  dtgreet(1)
7.6063      1.4893     6.1171   0.0373   0.0073   0.0300  sleep(1)

```

...(lines omitted)...

Kproc Summary by Thread ID (Tid)

The Kproc Summary, by Tid, shows an output of all the kernel process threads that were running on the system during the time of trace collection and their CPU consumption. The thread that consumed the most CPU time during the time of the trace collection is at the beginning of the list.

Kproc Summary (by Tid)

```

-----
-- processing total (msec) --      -- percent of total time --
combined kernel operation  combined kernel operation  name (Pid Tid Type)
-----
1930.9312  1930.9312  0.0000  13.6525  13.6525  0.0000  wait(8196 8197 W)
2.1674     2.1674     0.0000  0.0153  0.0153  0.0000  .WSMRefreshServe(0 3 -)
1.9034     1.9034     1.8020  0.0135  0.0135  0.0128  nfsd(36882 49177 N)

```

...(lines omitted)...

Kproc Types

```

-----
Type Function                               Operation
-----
W  idle thread                               -
N  NFS daemon                                NFS Remote Procedure Calls

```

The Kproc Summary has the following fields:

name (Pid Tid Type) The name of the kernel process associated with the thread, its process ID, its thread ID, and its type. The **kproc** type is defined in the Kproc Types listing following the Kproc Summary.

processing total (msec)

combined The total amount of CPU time, expressed in milliseconds, that the thread was running in either operation or kernel mode.

kernel The amount of CPU time, expressed in milliseconds, that the thread spent in unidentified kernel mode.

operation The amount of CPU time, expressed in milliseconds, that the thread spent in traced operations.

percent of total time

combined The amount of CPU time that the thread was running, expressed as percentage of the total processing time.

kernel The amount of CPU time that the thread spent in unidentified kernel mode, expressed as percentage of the total processing time.

operation The amount of CPU time that the thread spent in traced operations, expressed as percentage of the total processing time.

Kproc Types

Type A single letter to be used as an index into this listing.

Function A description of the nominal function of this type of kernel process.

Operation A description of the traced operations for this type of kernel process.

Application Pthread Summary by process ID (Pid)

The Application Pthread Summary, by PID, shows an output of all the multi-threaded processes that were running on the system during trace collection and their CPU consumption, and that have spent time making pthread calls. The process that consumed the most CPU time during the trace collection is at the beginning of the list.

```
Application Pthread Summary (by Pid)
-----
-- processing total (msec) --  -- percent of total application time --
application  other  pthread  application  other  pthread  name (Pid)(Pthread Count)
-----  -----  -----  -----  -----  -----  -----
1277.6602  1274.9354  2.7249  23.8113  23.7605  0.0508  ./pth(245964)(52)
802.6445  801.4162  1.2283  14.9586  14.9357  0.0229  ./pth32(245962)(12)
```

...(lines omitted)...

The output is divided into two main sections:

- The total processing time of the process in milliseconds (processing total (msec))
- The CPU time that the process has consumed, expressed as a percentage of the total application time

The Application Pthread Summary has the following fields:

name (Pid) (Pthread Count) The name of the process associated with the process ID, and the number of pthreads of this process.

processing total (msec)

application The total amount of CPU time, expressed in milliseconds, that the process was running in user mode.

pthread The amount of CPU time, expressed in milliseconds, that the process spent in traced call to the pthreads library.

other The amount of CPU time, expressed in milliseconds, that the process spent in non traced user mode.

percent of total application time

application	The amount of CPU time that the process was running in user mode, expressed as percentage of the total application time.
pthread	The amount of CPU time that the process spent in calls to the pthreads library, expressed as percentage of the total application time.
other	The amount of CPU time that the process spent in non traced user mode, expressed as percentage of the total application time.

System Calls Summary

The System Calls Summary provides a list of all the system calls that have completed execution on the system during the monitoring period. The list is sorted by the total CPU time in milliseconds consumed by each type of system call.

System Calls Summary						
Count	Total Time (msec)	% sys time	Avg Time (msec)	Min Time (msec)	Max Time (msec)	SVC (Address)
605	355.4475	1.74%	0.5875	0.0482	4.5626	kwrite(4259c4)
733	196.3752	0.96%	0.2679	0.0042	2.9948	kread(4259e8)
3	9.2217	0.05%	3.0739	2.8888	3.3418	execve(1c95d8)
38	7.6013	0.04%	0.2000	0.0051	1.6137	_loadx(1c9608)
1244	4.4574	0.02%	0.0036	0.0010	0.0143	lseek(425a60)
45	4.3917	0.02%	0.0976	0.0248	0.1810	access(507860)
63	3.3929	0.02%	0.0539	0.0294	0.0719	_select(4e0ee4)
2	2.6761	0.01%	1.3380	1.3338	1.3423	kfork(1c95c8)
207	2.3958	0.01%	0.0116	0.0030	0.1135	_poll(4e0ecc)
228	1.1583	0.01%	0.0051	0.0011	0.2436	kiocntl(4e07ac)
9	0.8136	0.00%	0.0904	0.0842	0.0988	.smtcheckinit(1b245a8)
5	0.5437	0.00%	0.1087	0.0696	0.1777	open(4e08d8)
15	0.3553	0.00%	0.0237	0.0120	0.0322	.smtcheckinit(1b245cc)
2	0.2692	0.00%	0.1346	0.1339	0.1353	statx(4e0950)
33	0.2350	0.00%	0.0071	0.0009	0.0210	_sigaction(1cada4)
1	0.1999	0.00%	0.1999	0.1999	0.1999	kwaitpid(1cab64)
102	0.1954	0.00%	0.0019	0.0013	0.0178	klseek(425a48)

...(lines omitted)...

The System Calls Summary has the following fields:

Count	The number of times that a system call of a certain type (see SVC (Address)) has been called during the monitoring period.
Total Time (msec)	The total CPU time that the system spent processing these system calls, expressed in milliseconds.
% sys time	The total CPU time that the system spent processing these system calls, expressed as a percentage of the total processing time.
Avg Time (msec)	The average CPU time that the system spent processing one system call of this type, expressed in milliseconds.
Min Time (msec)	The minimum CPU time that the system needed to process one system call of this type, expressed in milliseconds.
Max Time (msec)	The maximum CPU time that the system needed to process one system call of this type, expressed in milliseconds.
SVC (Address)	The name of the system call and its kernel address.

Pending System Calls Summary

The Pending System Calls Summary provides a list of all the system calls that have been executed on the system during the monitoring period but have not completed. The list is sorted by Tid.

Pending System Calls Summary

```

-----
Accumulated   SVC (Address)                Procname (Pid Tid)
Time (msec)
=====
0.0656        _select(4e0ee4)             sendmail(7844 5001)
0.0452        _select(4e0ee4)             syslogd(7514 8591)
0.0712        _select(4e0ee4)             snmpd(5426 9293)
0.0156        kiocntl(4e07ac)             trcstop(47210 18379)
0.0274        kwaitpid(1cab64)            ksh(20276 44359)
0.0567        kread4259e8)                ksh(23342 50873)

```

...(lines omitted)...

The Pending System Calls Summary has the following fields:

- Accumulated Time (msec)** The accumulated CPU time that the system spent processing the pending system call, expressed in milliseconds.
- SVC (Address)** The name of the system call and its kernel address.
- Procname (Pid Tid)** The name of the process associated with the thread that made the system call, its process ID, and the thread ID.

Hypervisor Calls Summary

The Hypervisor Calls Summary provides a list of all the hypervisor calls that have completed execution on the system during the monitoring period. The list is sorted by the total CPU time, in milliseconds, consumed by each type of hypervisor call.

Hypervisor Calls Summary

```

-----
Count   Total Time   % sys   Avg Time   Min Time   Max Time   HCALL (Address)
        (msec)      time    (msec)    (msec)    (msec)
=====
4        0.0077       0.00%   0.0019    0.0014    0.0025    H_XIRR(3ada19c)
4        0.0070       0.00%   0.0017    0.0015    0.0021    H_EOI(3ad6564)

```

The Hypervisor Calls Summary has the following fields:

Count	The number of times that a hypervisor call of a certain type has been called during the monitoring period.
Total Time (msec)	The total CPU time that the system spent processing hypervisor calls of this type, expressed in milliseconds.
% sys Time	The total CPU time that the system spent processing the hypervisor calls of this type, expressed as a percentage of the total processing time.
Avg Time (msec)	The average CPU time that the system spent processing one hypervisor call of this type, expressed in milliseconds.
Min Time (msec)	The minimum CPU time that the system needed to process one hypervisor call of this type, expressed in milliseconds.
Max Time (msec)	The maximum CPU time that the system needed to process one hypervisor call of this type, expressed in milliseconds.
HCALL (address)	The name of the hypervisor call and the kernel address of its caller.

Pending Hypervisor Calls Summary

The Pending Hypervisor Calls Summary provides a list of all the hypervisor calls that have been executed on the system during the monitoring period but have not completed. The list is sorted by Tid.

Pending Hypervisor Calls Summary

```

-----
Accumulated   HCALL (Address)                Procname (Pid Tid)

```

```

Time (msec)
=====
0.0066  H_XIRR(3ada19c)          syncd(3916 5981)

```

The Pending Hypervisor Calls Summary has the following fields:

Accumulated Time (msec)	The accumulated CPU time that the system spent processing the pending hypervisor call, expressed in milliseconds.
HCALL (address)	The name of the hypervisor call and the kernel address of its caller.
Procname (Pid Tid)	The name of the process associated with the thread that made the hypervisor call, its process ID, and the thread ID.

System NFS Calls Summary

The System NFS Calls Summary provides a list of all the system NFS calls that have completed execution on the system during the monitoring period. The list is divided by NFS versions, and each list is sorted by the total CPU time, in milliseconds, consumed by each type of system NFS call.

System NFS Calls Summary							
Count	Total Time (msec)	Avg Time (msec)	Min Time (msec)	Max Time (msec)	% Tot Time	% Tot Count	Opcode
253	48.4115	0.1913	0.0952	1.0097	98.91	98.83	RFS2_READLINK
2	0.3959	0.1980	0.1750	0.2209	0.81	0.78	RFS2_LOOKUP
1	0.1373	0.1373	0.1373	0.1373	0.28	0.39	RFS2_NULL

256	48.9448	0.1912					NFS V2 TOTAL
3015	4086.9121	1.3555	0.1035	31.6976	40.45	17.12	RFS3_READ
145	2296.3158	15.8367	1.1177	42.9125	22.73	0.82	RFS3_WRITE
10525	2263.3336	0.2150	0.0547	2.9737	22.40	59.77	RFS3_LOOKUP
373	777.2854	2.0839	0.2839	17.5724	7.69	2.12	RFS3_READDIRPLUS
2058	385.9510	0.1875	0.0875	1.1993	3.82	11.69	RFS3_GETATTR
942	178.6442	0.1896	0.0554	1.2320	1.77	5.35	RFS3_ACCESS
515	97.0297	0.1884	0.0659	0.9774	0.96	2.92	RFS3_READLINK
25	11.3046	0.4522	0.2364	0.9712	0.11	0.14	RFS3_READDIR
3	2.8648	0.9549	0.8939	0.9936	0.03	0.02	RFS3_CREATE
3	2.8590	0.9530	0.5831	1.4095	0.03	0.02	RFS3_COMMIT
2	1.1824	0.5912	0.2796	0.9028	0.01	0.01	RFS3_FSSTAT
1	0.2773	0.2773	0.2773	0.2773	0.00	0.01	RFS3_SETATTR
1	0.2366	0.2366	0.2366	0.2366	0.00	0.01	RFS3_PATHCONF
1	0.1804	0.1804	0.1804	0.1804	0.00	0.01	RFS3_NULL

17609	10104.3769	0.5738					NFS V3 TOTAL

The System NFS Calls Summary has the following fields:

Count	The number of times that a certain type of system NFS call (see Opcode) has been called during the monitoring period.
Total Time (msec)	The total CPU time that the system spent processing system NFS calls of this type, expressed in milliseconds.
Avg Time (msec)	The average CPU time that the system spent processing one system NFS call of this type, expressed in milliseconds.
Min Time (msec)	The minimum CPU time that the system needed to process one system NFS call of this type, expressed in milliseconds.
Max Time (msec)	The maximum CPU time that the system needed to process one system NFS call of this type, expressed in milliseconds.
% Tot Time	The total CPU time that the system spent processing the system NFS calls of this type, expressed as a percentage of the total processing time.

% Tot Count	The number of times that a system NFS call of a certain type was made, expressed as a percentage of the total count.
Opcode	The name of the system NFS call.

Pending NFS Calls Summary

The Pending NFS Calls Summary provides a list of all the system NFS calls that have executed on the system during the monitoring period but have not completed. The list is sorted by the **Tid**.

Pending NFS Calls Summary

```
-----
Accumulated   Sequence Number  Procname (Pid  Tid)
Time (msec)
-----
0.0831  1038711932      nfsd(1007854 331969)
0.0833  1038897247      nfsd(1007854 352459)
0.0317  1038788652      nfsd(1007854 413931)
```

..(lines omitted)...

The Pending System NFS Calls Summary has the following fields:

Accumulated Time (msec)	The accumulated CPU time that the system spent processing the pending system NFS call, expressed in milliseconds.
Sequence Number	The sequence number represents the transaction identifier (XID) of an NFS operation. It is used to uniquely identify an operation and is used in the RPC call/reply messages. This number is provided instead of the operation name because the name of the operation is unknown until it completes.
Procname (Pid Tid)	The name of the process associated with the thread that made the system NFS call, its process ID, and the thread ID.

Pthread Calls Summary

The Pthread Calls Summary provides a list of all the pthread calls that have completed execution on the system during the monitoring period. The list is sorted by the total CPU time, in milliseconds, consumed by each type of pthread call.

```
-----
Pthread Calls Summary
-----
Count  Total Time  % sys  Avg Time  Min Time  Max Time  Pthread Routine
      (msec)  time    (msec)  (msec)    (msec)
-----
62     3.6226    0.04%  0.0584    0.0318    0.1833  pthread_create
10     0.1798    0.00%  0.0180    0.0119    0.0341  pthread_cancel
8      0.0725    0.00%  0.0091    0.0064    0.0205  pthread_join
1      0.0553    0.00%  0.0553    0.0553    0.0553  pthread_detach
1      0.0229    0.00%  0.0229    0.0229    0.0229  pthread_kill
```

The Pthread Calls Summary report has the following fields:

Count	The number of times that a pthread call of a certain type has been called during the monitoring period.
Total Time (msec)	The total CPU time that the system spent processing all pthread calls of this type, expressed in milliseconds.
% sys time	The total CPU time that the system spent processing all calls of this type, expressed as a percentage of the total processing time.
Avg Time (msec)	The average CPU time that the system spent processing one pthread call of this type, expressed in milliseconds.

Min Time (msec) The minimum CPU time the system used to process one pthread call of this type, expressed in milliseconds.

Pthread routine The name of the routine in the pthread library.

Pending Pthread Calls Summary

The Pending Pthread Calls Summary provides a list of all the pthread calls that have been executed on the system during the monitoring period but have not completed. The list is sorted by Pid-Ptid.

Pending Pthread Calls Summary

```

-----
Accumulated Pthread Routine Procname (Pid Tid Ptid)
Time (msec)
-----
1990.9400 pthread_join ./pth32(245962 1007759 1)

```

The Pending Pthread System Calls Summary has the following fields:

Accumulated Time (msec) The accumulated CPU time that the system spent processing the pending pthread call, expressed in milliseconds.

Pthread Routine The name of the pthread routine of the libpthreads library.

Procname (Pid Tid Ptid) The name of the process associated with the thread and the pthread which made the pthread call, its process ID, the thread ID and the pthread ID.

FLIH Summary

The FLIH (First Level Interrupt Handler) Summary lists all first level interrupt handlers that were called during the monitoring period.

The Global FLIH Summary lists the total of first level interrupts on the system, while the Per CPU FLIH Summary lists the first level interrupts per CPU.

Global Flih Summary

```

-----
Count Total Time Avg Time Min Time Max Time Flih Type
(msec) (msec) (msec) (msec) (msec)
-----
2183 203.5524 0.0932 0.0041 0.4576 31(DEC_R_INTR)
946 102.4195 0.1083 0.0063 0.6590 3(DATA_ACC_PG_FLT)
12 1.6720 0.1393 0.0828 0.3366 32(QUEUED_INTR)
1058 183.6655 0.1736 0.0039 0.7001 5(IO_INTR)

```

Per CPU Flih Summary

CPU Number 0:

```

-----
Count Total Time Avg Time Min Time Max Time Flih Type
(msec) (msec) (msec) (msec) (msec)
-----
635 39.8413 0.0627 0.0041 0.4576 31(DEC_R_INTR)
936 101.4960 0.1084 0.0063 0.6590 3(DATA_ACC_PG_FLT)
9 1.3946 0.1550 0.0851 0.3366 32(QUEUED_INTR)
266 33.4247 0.1257 0.0039 0.4319 5(IO_INTR)

```

CPU Number 1:

```

-----
Count Total Time Avg Time Min Time Max Time Flih Type
(msec) (msec) (msec) (msec) (msec)
-----
4 0.2405 0.0601 0.0517 0.0735 3(DATA_ACC_PG_FLT)
258 49.2098 0.1907 0.0060 0.5076 5(IO_INTR)
515 55.3714 0.1075 0.0080 0.3696 31(DEC_R_INTR)

```



```

Pending Flih Summary
-----
Accumulated Time (msec)  Flih Type
=====
0.0123                   5(IO_INTR)

```

...(lines omitted)...

The FLIH Summary report has the following fields:

- Count** The number of times that a first level interrupt of a certain type (see Flih Type) occurred during the monitoring period.
- Total Time (msec)** The total CPU time that the system spent processing these first level interrupts, expressed in milliseconds.
- Avg Time (msec)** The average CPU time that the system spent processing one first level interrupt of this type, expressed in milliseconds.
- Min Time (msec)** The minimum CPU time that the system needed to process one first level interrupt of this type, expressed in milliseconds.
- Max Time (msec)** The maximum CPU time that the system needed to process one first level interrupt of this type, expressed in milliseconds.
- Flih Type** The number and name of the first level interrupt.
- Accumulated Time (msec)** The accumulated CPU time that the system spent processing the pending first level interrupt, expressed in milliseconds.

FLIH types in the example

The following are FLIH types that were depicted in the above example:

- DATA_ACC_PG_FLT** Data access page fault
- QUEUED_INTR** Queued interrupt
- DECR_INTR** Decrementer interrupt
- IO_INTR** I/O interrupt

SLIH Summary

The Second level interrupt handler (SLIH) Summary lists all second level interrupt handlers that were called during the monitoring period.

The Global Slih Summary lists the total of second level interrupts on the system, while the Per CPU Slih Summary lists the second level interrupts per CPU.

```

Global Slih Summary
-----
Count  Total Time  Avg Time  Min Time  Max Time  Slih Name(Address)
-----  -----  -----  -----  -----  -----
43     7.0434    0.1638   0.0284   0.3763   s_scsiddpin(1a99104)
1015   42.0601   0.0414   0.0096   0.0913   ssapin(1990490)

```

```

Per CPU Slih Summary
-----
CPU Number 0:
Count  Total Time  Avg Time  Min Time  Max Time  Slih Name(Address)
-----  -----  -----  -----  -----  -----
8      1.3500    0.1688   0.0289   0.3087   s_scsiddpin(1a99104)
258    7.9232    0.0307   0.0096   0.0733   ssapin(1990490)
CPU Number 1:

```

Count	Total Time (msec)	Avg Time (msec)	Min Time (msec)	Max Time (msec)	Slih Name(Address)
10	1.2685	0.1268	0.0579	0.2818	s_scsiddpin(1a99104)
248	11.2759	0.0455	0.0138	0.0641	ssapin(1990490)

...(lines omitted)...

The SLIH Summary report has the following fields:

- Count** The number of times that each second level interrupt handler was called during the monitoring period.
- Total Time (msec)** The total CPU time that the system spent processing these second level interrupts, expressed in milliseconds.
- Avg Time (msec)** The average CPU time that the system spent processing one second level interrupt of this type, expressed in milliseconds.
- Min Time (msec)** The minimum CPU time that the system needed to process one second level interrupt of this type, expressed in milliseconds.
- Max Time (msec)** The maximum CPU time that the system needed to process one second level interrupt of this type, expressed in milliseconds.
- Slih Name (Address)** The module name and kernel address of the second level interrupt.

Reports Generated with the -e Flag

The report generated with the **-e** flag includes the data shown in the default report, and also includes additional information in the System Calls Summary, the Pending System Calls Summary, the Hypervisor Calls Summary, the Pending Hypervisor Calls Summary, the System NFS Calls Summary, the Pending NFS Calls Summary, the Pthread Calls Summary and the Pending Pthread Calls Summary.

The additional information in the System Calls Summary, Hypervisor Calls Summary, System NFS Calls Summary, and the Pthread Calls Summary includes the total, average, maximum, and minimum elapsed time that a call was running. The additional information in the Pending System Calls Summary, Pending Hypervisor Calls Summary, Pending NFS Calls Summary, and the Pending Pthread Calls Summary is the accumulated elapsed time for the pending calls. This additional information is present in all the system call, hypervisor call, NFS call, and pthread call reports: globally, in the process detailed report (-p), the thread detailed report (-t), and the pthread detailed report (-P).

The following is an example of the additional information reported by using the **-e** flag:

```
# curt -e -i trace.r -m trace.nm -n gensyms.out -o curt.out
# cat curt.out
```

...(lines omitted)...

System Calls Summary										
Count	Total Time (msec)	% sys time	Avg Time (msec)	Min Time (msec)	Max Time (msec)	Tot ETime (msec)	Avg ETime (msec)	Min ETime (msec)	Max ETime (msec)	SVC (Address)
605	355.4475	1.74%	0.5875	0.0482	4.5626	31172.7658	51.5252	0.0482	422.2323	kwrite(4259c4)
733	196.3752	0.96%	0.2679	0.0042	2.9948	12967.9407	17.6916	0.0042	265.1204	kread(4259e8)
3	9.2217	0.05%	3.0739	2.8888	3.3418	57.2051	19.0684	4.5475	40.0557	execve(1c95d8)
38	7.6013	0.04%	0.2000	0.0051	1.6137	12.5002	0.3290	0.0051	3.3120	_loadx(1c9608)
1244	4.4574	0.02%	0.0036	0.0010	0.0143	4.4574	0.0036	0.0010	0.0143	lseek(425a60)
45	4.3917	0.02%	0.0976	0.0248	0.1810	4.6636	0.1036	0.0248	0.3037	access(507860)
63	3.3929	0.02%	0.0539	0.0294	0.0719	5006.0887	79.4617	0.0294	100.4802	_select(4e0ee4)
2	2.6761	0.01%	1.3380	1.3338	1.3423	45.5026	22.7513	7.5745	37.9281	kfork(1c95c8)
207	2.3958	0.01%	0.0116	0.0030	0.1135	4494.9249	21.7146	0.0030	499.1363	_poll(4e0ecc)
228	1.1583	0.01%	0.0051	0.0011	0.2436	1.1583	0.0051	0.0011	0.2436	kiocntl(4e07ac)
9	0.8136	0.00%	0.0904	0.0042	0.0988	4498.7472	499.8608	499.8052	499.8898	.smtcheckinit(1b245a8)
5	0.5437	0.00%	0.1087	0.0696	0.1777	0.5437	0.1087	0.0696	0.1777	open(4e08d8)
15	0.3553	0.00%	0.0237	0.0120	0.0322	0.3553	0.0237	0.0120	0.0322	.smtcheckinit(1b245cc)
2	0.2692	0.00%	0.1346	0.1339	0.1353	0.2692	0.1346	0.1339	0.1353	statx(4e0950)
33	0.2350	0.00%	0.0071	0.0009	0.0210	0.2350	0.0071	0.0009	0.0210	_sigaction(1cada4)
1	0.1999	0.00%	0.1999	0.1999	0.1999	5019.0588	5019.0588	5019.0588	5019.0588	kwaitpid(1cab64)

```

102  0.1954 0.00% 0.0019 0.0013 0.0178    0.5427  0.0053  0.0013  0.3650 k1seek(425a48)
...(lines omitted)...

```

Pending System Calls Summary

Accumulated Time (msec)	Accumulated ETime (msec)	SVC (Address)	Procname (Pid Tid)
0.0855	93.6498	kread(4259e8)	oracle(143984 48841)

...(lines omitted)...

Hypervisor Calls Summary

Count	Total Time (msec)	% sys time	Avg Time (msec)	Min Time (msec)	Max Time (msec)	Tot ETime (msec)	Avg ETime (msec)	Min ETime (msec)	Max ETime (msec)	HCALL (Address)
4	0.0077	0.00%	0.0019	0.0014	0.0025	0.0077	0.0019	0.0014	0.0025	H_XIRR(3ada19c)
4	0.0070	0.00%	0.0017	0.0015	0.0021	0.0070	0.0017	0.0015	0.0021	H_EOI(3ad6564)

Pending Hypervisor Calls Summary

Accumulated Time (msec)	Accumulated ETime (msec)	HCALL (Address)	Procname (Pid Tid)
0.0855	93.6498	H_XIRR(3ada19c)	syncd(3916 5981)

System NFS Calls Summary

Count	Total Time (msec)	Avg Time (msec)	Min Time (msec)	Max Time (msec)	% Tot Time	Total ETime (msec)	Avg ETime (msec)	Min ETime (msec)	Max ETime (msec)	% Tot ETime	% Tot Count	Opcode
6647	456.1029	0.0686	0.0376	0.6267	15.83	9267.7256	1.3943	0.0376	304.9501	14.63	27.88	RFS3_LOOKUP
2694	147.1680	0.0546	0.0348	0.5517	5.11	1474.4267	0.5473	0.0348	25.9402	2.33	11.30	RFS3_GETATTR
1702	85.8328	0.0504	0.0339	0.5793	2.98	146.4281	0.0860	0.0339	5.7539	0.23	7.14	RFS3_READLINK
1552	78.1015	0.0503	0.0367	0.5513	2.71	153.5844	0.0990	0.0367	7.5125	0.24	6.51	RFS3_ACCESS
235	33.3158	0.1418	0.0890	0.3312	1.16	1579.4557	6.7211	0.0890	56.0876	2.49	0.99	RFS3_SETATTR

...(line omitted)...

Pending NFS Calls Summary

Accumulated Time (msec)	Accumulated ETime (msec)	Sequence Number	Procname (Pid Tid)
0.0831	15.1581	1038711932	nfsd(1007854 331969)
0.0833	13.8889	1038897247	nfsd(1007854 352459)

...(line omitted)...

Pthread Calls Summary

Count	Total Time (msec)	% sys time	Avg Time (msec)	Min Time (msec)	Max Time (msec)	Tot ETime (msec)	Avg ETime (msec)	Min ETime (msec)	Max ETime (msec)	Pthread Routine
72	2.0126	0.01%	0.0280	0.0173	0.1222	13.7738	0.1913	0.0975	0.6147	pthread_create
2	0.6948	0.00%	0.3474	0.0740	0.6208	92.3033	46.1517	9.9445	82.3588	pthread_kill
12	0.3087	0.00%	0.0257	0.0058	0.0779	25.0506	2.0876	0.0168	10.0605	pthread_cancel
22	0.0613	0.00%	0.0028	0.0017	0.0104	2329.0179	105.8644	0.0044	1908.3402	pthread_join
2	0.0128	0.00%	0.0064	0.0062	0.0065	0.1528	0.0764	0.0637	0.0891	pthread_detach

Pending Pthread Calls Summary

Accumulated Time (msec)	Accumulated ETime (msec)	Pthread Routine	Procname (pid tid ptid)
3.3102	4946.5433	pthread_join	./pth32(282718 700515 1)
0.0025	544.4914	pthread_join	./pth(282720 - 1)

The system call, hypervisor call, NFS call, and pthread call reports in the preceding example have the following fields in addition to the default System Calls Summary, Hypervisor Calls Summary, System NFS Calls Summary, and Pthread Calls Summary :

Tot ETime (msec)	The total amount of time from when each instance of the call was started until it completed. This time will include any time spent servicing interrupts, running other processes, and so forth.
Avg ETime (msec)	The average amount of time from when the call was started until it completed. This time will include any time spent servicing interrupts, running other processes, and so forth.
Min ETime (msec)	The minimum amount of time from when the call was started until it completed. This time will include any time spent servicing interrupts, running other processes, and so forth.
Max ETime (msec)	The maximum amount of time from when the call was started until it completed. This time will include any time spent servicing interrupts, running other processes, and so forth.
Accumulated ETime (msec)	The total amount of time from when the pending call was started until the end of the trace. This time will include any time spent servicing interrupts, running other processes, and so forth.

The preceding example report shows that the maximum elapsed time for the **kwrite** system call was 422.2323 msec, but the maximum CPU time was 4.5626 msec. If this amount of overhead time is unusual for the device being written to, further analysis is needed.

Reports Generated with the -s Flag

The report generated with the **-s** flag includes the data shown in the default report, and also includes data on errors returned by system calls as shown by the following:

```
# curt -s -i trace.r -m trace.nm -n gensyms.out -o curt.out
# cat curt.out
```

...(lines omitted)...

Errors Returned by System Calls

```
-----
Errors (errno : count : description) returned for System Call: kiocntl(4e07ac)
  25 :      15 : "Not a typewriter"
Errors (errno : count : description) returned for System Call: execve(1c95d8)
   2 :       2 : "No such file or directory"
```

...(lines omitted)...

If a large number of errors of a specific type or on a specific system call point to a system or application problem, other debug measures can be used to determine and fix the problem.

Reports Generated with the -t Flag

The report generated with the **-t** flag includes the data shown in the default report, and also includes a detailed report on thread status that includes the amount of time the thread was in application and system call mode, what system calls the thread made, processor affinity, the number of times the thread was dispatched, and to which CPU(s) it was dispatched. The report also includes dispatch wait time and details of interrupts:

...(lines omitted)...

```
-----
Report for Thread Id: 48841 (hex bec9) Pid: 143984 (hex 23270)
Process Name: oracle
```

```
-----
Total Application Time (ms):    70.324465
Total System Call Time (ms):    53.014910
Total Hypervisor Call Time (ms): 0.077000
```

Thread System Call Summary

Count	Total Time (msec)	Avg Time (msec)	Min Time (msec)	Max Time (msec)	SVC (Address)
=====	=====	=====	=====	=====	=====
69	34.0819	0.4939	0.1666	1.2762	kwrite(169ff8)

77	12.0026	0.1559	0.0474	0.2889	kread(16a01c)
510	4.9743	0.0098	0.0029	0.0467	times(f1e14)
73	1.2045	0.0165	0.0105	0.0306	select(1d1704)
68	0.6000	0.0088	0.0023	0.0445	lseek(16a094)
12	0.1516	0.0126	0.0071	0.0241	getrusage(f1be0)

No Errors Returned by System Calls

Pending System Calls Summary

```
-----
Accumulated SVC (Address)
Time (msec)
=====
0.1420 kread(16a01c)
```

Thread Hypervisor Calls Summary

```
-----
Count Total Time % sys Avg Time Min Time Max Time HCALL (Address)
      (msec) time (msec) (msec) (msec)
=====
4      0.0077 0.00% 0.0019 0.0014 0.0025 H_XIRR(3ada19c)
```

Pending Hypervisor Calls Summary

```
-----
Accumulated HCALL (Address)
Time (msec)
=====
0.0066 H_XIRR(3ada19c)
```

processor affinity: 0.583333

Dispatch Histogram for thread (CPUid : times_dispatched).

```
CPU 0 : 23
CPU 1 : 23
CPU 2 : 9
CPU 3 : 9
CPU 4 : 8
CPU 5 : 14
CPU 6 : 17
CPU 7 : 19
CPU 8 : 1
CPU 9 : 4
CPU 10 : 1
CPU 11 : 4
```

```
total number of dispatches: 131
total number of redispaches due to interupts being disabled: 1
avg. dispatch wait time (ms): 8.273515
```

Data on Interrupts that Occurred while Thread was Running

```
-----
Type of Interrupt Count
=====
Data Access Page Faults (DSI): 115
Instr. Fetch Page Faults (ISI): 0
Align. Error Interrupts: 0
IO (external) Interrupts: 0
Program Check Interrupts: 0
FP Unavailable Interrupts: 0
FP Imprecise Interrupts: 0
RunMode Interrupts: 0
Decrementer Interrupts: 18
Queued (Soft level) Interrupts: 15
```

...(lines omitted)...

If the thread belongs to an NFS kernel process, the report will include information on NFS operations instead of System calls:

Report for Thread Id: 1966273 (hex 1e00c1) Pid: 1007854 (hex f60ee)
 Process Name: nfsd

 Total Kernel Time (ms): 3.198998
 Total Operation Time (ms): 28.839927
 Total Hypervisor Call Time (ms): 0.000000

Thread NFS Call Summary

Count	Total Time (msec)	Avg Time (msec)	Min Time (msec)	Max Time (msec)	% Tot Time	Total ETime (msec)	Avg ETime (msec)	Min ETime (msec)	Max ETime (msec)	% Tot ETime	% Tot Count	Opcode
28	12.2661	0.4381	0.3815	0.4841	42.73	32.0893	1.1460	0.4391	16.6283	11.46	11.52	RFS3_READDIRPLUS
63	3.8953	0.0618	0.0405	0.1288	13.57	23.1031	0.3667	0.0405	7.0886	8.25	25.93	RFS3_LOOKUP
49	3.2795	0.0669	0.0527	0.0960	11.42	103.8431	2.1192	0.0534	35.3617	37.09	20.16	RFS3_READ
18	2.8464	0.1581	0.1099	0.2264	9.91	7.9129	0.4396	0.1258	4.3503	2.83	7.41	RFS3_WRITE
29	1.3331	0.0460	0.0348	0.0620	4.64	1.4953	0.0516	0.0348	0.0940	0.53	11.93	RFS3_GETATTR
5	1.2763	0.2553	0.2374	0.3036	4.45	45.0798	9.0160	0.9015	21.7257	16.10	2.06	RFS3_REMOVE
8	1.1001	0.1375	0.1180	0.1719	3.83	53.6532	6.7067	1.4293	19.9199	19.17	3.29	RFS3_COMMIT
20	0.9262	0.0463	0.0367	0.0507	3.23	1.2060	0.0603	0.0367	0.1314	0.43	8.23	RFS3_READLINK
15	0.6798	0.0453	0.0386	0.0519	2.37	0.8015	0.0534	0.0386	0.0788	0.29	6.17	RFS3_ACCESS
2	0.4033	0.2017	0.1982	0.2051	1.40	0.5355	0.2677	0.2677	0.2677	0.19	0.82	RFS3_READDIR
1	0.3015	0.3015	0.3015	0.3015	1.05	6.2614	6.2614	6.2614	6.2614	2.24	0.41	RFS3_CREATE
2	0.2531	0.1265	0.1000	0.1531	0.88	3.7756	1.8878	0.1000	3.6756	1.35	0.82	RFS3_SETATTR
2	0.0853	0.0426	0.0413	0.0440	0.30	0.1333	0.0667	0.0532	0.0802	0.05	0.82	RFS3_FSINFO
1	0.0634	0.0634	0.0634	0.0634	0.22	0.0634	0.0634	0.0634	0.0634	0.02	0.41	RFS3_FSSTAT
243	28.7094	0.1181				279.9534	1.1521					NFS V3 TOTAL

Pending NFS Calls Summary

Accumulated Time (msec)	Accumulated ETime (msec)	Sequence Number
0.1305	182.6903	1038932778

The information in the threads summary includes the following:

- Thread ID** The Thread ID of the thread.
- Process ID** The Process ID that the thread belongs to.
- Process Name** The process name, if known, that the thread belongs to.
- Total Application Time (ms)** The amount of time, expressed in milliseconds, that the thread spent in application mode.
- Total System Call Time (ms)** The amount of time, expressed in milliseconds, that the thread spent in system call mode.
- Thread System Call Summary** A system call summary for the thread; this has the same fields as the global System Calls Summary. It also includes elapsed time if the **-e** flag is specified and error information if the **-s** flag is specified.
- Pending System Calls Summary** If the thread was executing a system call at the end of the trace, a pending system call summary will be printed. This has the Accumulated Time and Supervisor Call (SVC Address) fields. It also includes elapsed time if the **-e** flag is specified.
- Thread Hypervisor Calls Summary** The hypervisor call summary for the thread; this has the same fields as the global Hypervisor Calls Summary. It also includes elapsed time if the **-e** flag is specified.
- Pending Hypervisor Calls Summary** If the thread was executing a hypervisor call at the end of the trace, a pending hypervisor call summary will be printed. This has the Accumulated Time and Hypervisor Call fields. It also includes elapsed time if the **-e** flag is specified.
- Thread NFS Calls Summary** An NFS call summary for the thread. This has the same fields as the global System NFS Call Summary. It also includes elapsed time if the **-e** flag is specified.
- Pending NFS Calls Summary** If the thread was executing an NFS call at the end of the trace, a pending NFS call summary will be printed. This has the **Accumulated Time** and **Sequence Number** fields. It also includes elapsed time if the **-e** flag is specified.

processor affinity	The process affinity, which is the probability that, for any dispatch of the thread, the thread was dispatched to the same processor on which it last executed.
Dispatch Histogram for thread	Shows the number of times the thread was dispatched to each CPU in the system.
total number of dispatches	The total number of times the thread was dispatched (not including redispaches).
total number of redispaches due to interrupts being disabled	The number of redispaches due to interrupts being disabled, which is when the dispatch code is forced to dispatch the same thread that is currently running on that particular CPU because the thread had disabled some interrupts. This total is only reported if the value is non-zero.
avg. dispatch wait time (ms)	The average dispatch wait time is the average elapsed time for the thread from being undispached and its next dispatch.
Data on Interrupts that occurred while Thread was Running	Count of how many times each type of FLIH occurred while this thread was executing.

Reports Generated with the -p Flag

The report generated with the **-p** flag includes the data shown in the default report and also includes a detailed report for each process that includes the Process ID and name, a count and list of the thread IDs, and the count and list of the pthread IDs belonging to the process. The total application time, the system call time, and the application time details for all the threads of the process are given. Lastly, it includes summary reports of all the completed and pending system calls, and pthread calls for the threads of the process.

The following example shows the report generated for the router process (PID 129190):

Process Details for Pid: 129190

Process Name: router

7 Tids for this Pid: 245889 245631 244599 82843 78701 75347 28941
 9 Ptds for this Pid: 2057 1800 1543 1286 1029 772 515 258 1

Total Application Time (ms): 124.023749
 Total System Call Time (ms): 8.948695
 Total Hypervisor Time (ms): 0.000000

Application time details:

Total Pthread Call Time (ms): 1.228271
 Total Pthread Dispatch Time (ms): 2.760476
 Total Pthread Idle Dispatch Time (ms): 0.110307
 Total Other Time (ms): 798.545446
 Total number of pthread dispatches: 53
 Total number of pthread idle dispatches: 3

Process System Calls Summary

Count	Total Time (msec)	% sys time	Avg Time (msec)	Min Time (msec)	Max Time (msec)	SVC (Address)
93	3.6829	0.05%	0.0396	0.0060	0.3077	kread(19731c)
23	2.2395	0.03%	0.0974	0.0090	0.4537	kwrite(1972f8)
30	0.8885	0.01%	0.0296	0.0073	0.0460	select(208c5c)
1	0.5933	0.01%	0.5933	0.5933	0.5933	fsync(1972a4)
106	0.4902	0.01%	0.0046	0.0035	0.0105	klseek(19737c)
13	0.3285	0.00%	0.0253	0.0130	0.0387	semctl(2089e0)
6	0.2513	0.00%	0.0419	0.0238	0.0650	semop(2089c8)
3	0.1223	0.00%	0.0408	0.0127	0.0730	statx(2086d4)

1	0.0793	0.00%	0.0793	0.0793	0.0793	send(11e1ec)
9	0.0679	0.00%	0.0075	0.0053	0.0147	fstatx(2086c8)
4	0.0524	0.00%	0.0131	0.0023	0.0348	kfcntl(22aa14)
5	0.0448	0.00%	0.0090	0.0086	0.0096	yield(11dbec)
3	0.0444	0.00%	0.0148	0.0049	0.0219	recv(11e1b0)
1	0.0355	0.00%	0.0355	0.0355	0.0355	open(208674)
1	0.0281	0.00%	0.0281	0.0281	0.0281	close(19728c)

Pending System Calls Summary

Accumulated Time (msec)	SVC (Address)	Tid
0.0452	select(208c5c)	245889
0.0425	select(208c5c)	78701
0.0285	select(208c5c)	82843
0.0284	select(208c5c)	245631
0.0274	select(208c5c)	244599
0.0179	select(208c5c)	75347

...(omitted lines)...

Pthread Calls Summary

Count	Total Time (msec)	% sys time	Avg Time (msec)	Min Time (msec)	Max Time (msec)	Pthread Routine
19	0.0477	0.00%	0.0025	0.0017	0.0104	pthread_join
1	0.0065	0.00%	0.0065	0.0065	0.0065	pthread_detach
1	0.6208	0.00%	0.6208	0.6208	0.6208	pthread_kill
6	0.1261	0.00%	0.0210	0.0077	0.0779	pthread_cancel
21	0.7080	0.01%	0.0337	0.0226	0.1222	pthread_create

Pending Pthread Calls Summary

Accumulated Time (msec)	Pthread Routine	Tid	Ptid
3.3102	pthread_join	78701	1

If the process is an NFS kernel process, the report will include information on NFS operations instead of System and Pthread calls:

Process Details for Pid: 1007854

Process Name: nfsd
 252 Tids for this Pid: 2089213 2085115 2081017 2076919 2072821 2068723
 2040037 2035939 2031841 2027743 2023645 2019547
 2015449 2011351 2007253 2003155 1999057 1994959
 ...(lines omitted)...
 454909 434421 413931 397359 364797 352459
 340185 331969 315411 303283 299237 266405

Total Kernel Time (ms): 380.237018
 Total Operation Time (ms): 2891.971209

Process NFS Calls Summary

Count	Total Time (msec)	Avg Time (msec)	Min Time (msec)	Max Time (msec)	% Tot Time	Total ETime (msec)	Avg ETime (msec)	Min ETime (msec)	Max ETime (msec)	% Tot ETime	% Tot Count	Opcode
2254	1018.3621	0.4518	0.3639	0.9966	35.34	1800.5708	0.7988	0.4204	16.6283	2.84	9.45	RFS3_READDIRPLUS
6647	456.1029	0.0686	0.0376	0.6267	15.83	9267.7256	1.3943	0.0376	304.9501	14.63	27.88	RFS3_LOOKUP
1993	321.4973	0.1613	0.0781	0.6428	11.16	3006.1774	1.5084	0.0781	121.8822	4.75	8.36	RFS3_WRITE
4409	314.3122	0.0713	0.0425	0.6139	10.91	14052.7567	3.1873	0.0425	313.2698	22.19	18.49	RFS3_READ
1001	177.9891	0.1778	0.0903	8.7271	6.18	23187.1693	23.1640	0.7657	298.0521	36.61	4.20	RFS3_COMMIT
2694	147.1680	0.0546	0.0348	0.5517	5.11	1474.4267	0.5473	0.0348	25.9402	2.33	11.30	RFS3_GETATTR
495	102.0142	0.2061	0.1837	0.7000	3.54	185.8549	0.3755	0.1895	6.1340	0.29	2.08	RFS3_READDIR
1702	85.8328	0.0504	0.0339	0.5793	2.98	146.4281	0.0860	0.0339	5.7539	0.23	7.14	RFS3_READLINK
1552	78.1015	0.0503	0.0367	0.5513	2.71	153.5844	0.0990	0.0367	7.5125	0.24	6.51	RFS3_ACCESS

186	64.4498	0.3465	0.2194	0.7895	2.24	4201.0235	22.5861	1.0235	117.5351	6.63	0.78	RFS3_CREATE
208	56.8876	0.2735	0.1928	0.7351	1.97	4245.4378	20.4108	0.9015	181.0121	6.70	0.87	RFS3_REMOVE
235	33.3158	0.1418	0.0890	0.3312	1.16	1579.4557	6.7211	0.0890	56.0876	2.49	0.99	RFS3_SETATTR
190	13.3856	0.0705	0.0473	0.5495	0.46	19.3971	0.1021	0.0473	0.6827	0.03	0.80	RFS3_FSSTAT
275	12.4504	0.0453	0.0343	0.0561	0.43	16.6542	0.0606	0.0343	0.2357	0.03	1.15	RFS3_FSINFO

IT

23841	2881.8692	0.1209				63336.6621	2.6566					NFS V3 TOTAL
-------	-----------	--------	--	--	--	------------	--------	--	--	--	--	--------------

Pending NFS Calls Summary

Accumulated Time (msec)	Accumulated ETime (msec)	Sequence Number	Tid
0.1812	48.1456	1039026977	2089213
0.0188	14.8878	1038285324	2085115
0.0484	2.7123	1039220089	2081017
0.1070	49.5471	1039103658	2072821
0.0953	58.8009	1038453491	2035939
0.0533	62.9266	1039037391	2031841
0.1195	14.6817	1038686320	2019547
0.2063	37.1826	1039164331	2015449
0.0140	6.0718	1039260848	2011351

...(lines omitted)...

The information in the process detailed report includes the following:

- Total Application Time (ms)** The amount of time, expressed in milliseconds, that the process spent in application mode.
- Total System Call Time (ms)** The amount of time, expressed in milliseconds, that the process spent in system call mode.

The information in the application time details report includes the following:

- Total Pthread Call Time** The amount of time, expressed in milliseconds, that the process spent in traced pthread library calls.
- Total Pthread Dispatch Time** The amount of time, expressed in milliseconds, that the process spent in libpthreads dispatch code.
- Total Pthread Idle Dispatch Time** The amount of time, expressed in milliseconds, that the process spent in libpthreads **vp_sleep** code.
- Total Other Time** The amount of time, expressed in milliseconds, that the process spent in non-traced user mode code.
- Total number of pthread dispatches** The total number of times a pthread belonging to the process was dispatched by the libpthreads dispatcher.
- Total number of pthread idle dispatches** The total number of times a thread belonging to the process was in the libpthreads **vp_sleep** code.

The summary information in the report includes the following:

- Process System Calls Summary** A system call summary for the process; this has the same fields as the global System Call Summary. It also includes elapsed time information if the **-e** flag is specified and error information if the **-s** flag is specified.
- Pending System Calls Summary** If the process was executing a system call at the end of the trace, a pending system call summary will be printed. This has the Accumulated Time and Supervisor Call (SVC Address) fields. It also includes elapsed time information if the **-e** flag is specified.
- Process Hypervisor Calls Summary** A summary of the hypervisor calls for the process; this has the same fields as the global Hypervisor Calls Summary. It also includes elapsed time information if the **-e** flag is specified.

- Pending Hypervisor Calls Summary** If the process was executing a hypervisor call at the end of the trace, a pending hypervisor call summary will be printed. This has the Accumulated Time and Hypervisor Call fields. It also includes elapsed time information if the **-e** flag is specified.
- Process NFS Calls Summary** An NFS call summary for the process. This has the same fields as the global System NFS Call Summary. It also includes elapsed time information if the **-e** flag is specified.
- Pending NFS Calls Summary** If the process was executing an NFS call at the end of the trace, a pending NFS call summary will be printed. This has the **Accumulated Time** and **Sequence Number** fields. It also includes elapsed time information if the **-e** flag is specified.
- Pthread Calls Summary** A summary of the pthread calls for the process. This has the same fields as the global pthread Calls Summary. It also includes elapsed time information if the **-e** flag is specified.
- Pending Pthread Calls Summary** If the process was executing pthread library calls at the end of the trace, a pending pthread call summary will be printed. This has the Accumulated Time and Pthread Routine fields. It also includes elapsed time information if the **-e** flag is specified.

Reports Generated with the -P Flag

The report generated with the **-P** flag includes the data shown in the default report and also includes a detailed report on pthread status that includes the following:

- The amount of time the pthread was in application and system call mode
- The application time details
- The system calls and pthread calls that the pthread made
- The system calls and pthread calls that were pending at the end of the trace
- The processor affinity
- The number of times the pthread was dispatched
- To which CPU(s) the thread was dispatched
- The thread affinity
- The number of times that the pthread was dispatched
- To which kernel thread(s) the pthread was dispatched

The report also includes dispatch wait time and details of interrupts.

The following is an example of a report generated with the **-P** flag:

```
Report for Pthread Id: 1 (hex 1) Pid: 245962 (hex 3c0ca)
Process Name: ./pth32
```

```
-----
Total Application Time      (ms): 3.919091
Total System Call Time     (ms): 8.303156
Total Hypervisor Call Time (ms): 0.000000
```

```
Application time details:
Total Pthread Call Time (ms): 1.139372
Total Pthread Dispatch Time (ms): 0.115822
Total Pthread Idle Dispatch Time (ms): 0.036630
Total Other Time (ms): 2.627266
```

Pthread System Calls Summary

```
-----
```

Count	Total Time (msec)	Avg Time (msec)	Min Time (msec)	Max Time (msec)	SVC (Address)
1	3.3898	3.3898	3.3898	3.3898	_exit(409e50)
61	0.8138	0.0133	0.0089	0.0254	kread(5ffd78)
11	0.4616	0.0420	0.0262	0.0835	thread_create(407360)
22	0.2570	0.0117	0.0062	0.0373	mprotect(6d5bd8)

```

12      0.2126   0.0177   0.0100   0.0324  thread_setstate(40a660)
115     0.1875   0.0016   0.0012   0.0037  klseek(5ffe38)
12      0.1061   0.0088   0.0032   0.0134  sbrk(6d4f90)
23      0.0803   0.0035   0.0018   0.0072  trcgent(4078d8)

```

...(lines omitted)...

Pending System Calls Summary

```

-----
Accumulated SVC (Address)
Time (msec)
=====
0.0141  thread_tsleep(40a4f8)

```

Pthread Calls Summary

```

-----
Count   Total Time   % sys   Avg Time   Min Time   Max Time   Pthread Routine
      (msec)   time   (msec)   (msec)   (msec)
=====
11      0.9545   0.01%   0.0868   0.0457   0.1833  pthread_create
8       0.0725   0.00%   0.0091   0.0064   0.0205  pthread_join
1       0.0553   0.00%   0.0553   0.0553   0.0553  pthread_detach
1       0.0341   0.00%   0.0341   0.0341   0.0341  pthread_cancel
1       0.0229   0.00%   0.0229   0.0229   0.0229  pthread_kill

```

Pending Pthread Calls Summary

```

-----
Accumulated Pthread Routine
Time (msec)
=====
0.0025  pthread_join

```

processor affinity: 0.600000

Processor Dispatch Histogram for pthread (CPUid : times_dispatched):

```

CPU 0 : 4
CPU 1 : 1

```

total number of dispatches : 5
avg. dispatch wait time (ms): 798.449725

Thread affinity: 0.333333

Thread Dispatch Histogram for pthread (thread id : number dispatches):

```

Thread id 688279 : 1
Thread id 856237 : 1
Thread id 1007759 : 1

```

total number of pthread dispatches: 3
avg. dispatch wait time (ms): 1330.749542

Data on Interrupts that Occurred while Pthread was Running

```

Type of Interrupt      Count
=====
Data Access Page Faults (DSI): 452
Instr. Fetch Page Faults (ISI): 0
Align. Error Interrupts: 0
IO (external) Interrupts: 0
Program Check Interrupts: 0
FP Unavailable Interrupts: 0
FP Imprecise Interrupts: 0
RunMode Interrupts: 0
Decrementer Interrupts: 2
Queued (Soft level) Interrupts: 0

```

The information in the pthreads summary report includes the following:

Pthread ID	The Pthread ID of the thread.
Process ID	The Process ID that the pthread belongs to.
Process Name	The process name, if known, that the pthread belongs to.
Total Application Time (ms)	The amount of time, expressed in milliseconds, that the pthread spent in application mode.
Total System Call Time (ms)	The amount of time, expressed in milliseconds, that the pthread spent in system call mode.

The information in the application time details report includes the following:

Total Pthread Call Time	The amount of time, expressed in milliseconds, that the pthread spent in traced pthread library calls.
Total Pthread Dispatch Time	The amount of time, expressed in milliseconds, that the pthread spent in libpthreads dispatch code.
Total Pthread Idle Dispatch Time	The amount of time, expressed in milliseconds, that the pthread spent in libpthreads vp_sleep code.
Total Other Time	The amount of time, expressed in milliseconds, that the pthread spent in non-traced user mode code.
Total number of pthread dispatches	The total number of times a pthread belonging to the process was dispatched by the libpthreads dispatcher.
Total number of pthread idle dispatches	The total number of times a thread belonging to the process was in the libpthreads vp_sleep code.

The summary information in the report includes the following:

Pthread System Calls Summary	A system call summary for the pthread; this has the same fields as the global System Call Summary. It also includes elapsed time information if the -e flag is specified and error information if the -s flag is specified.
Pending System Calls Summary	If the pthread was executing a system call at the end of the trace, a pending system call summary will be printed. This has the Accumulated Time and Supervisor Call (SVC Address) fields. It also includes elapsed time information if the -e flag is specified.
Pthread Hypervisor Calls Summary	A summary of the hypervisor calls for the pthread. This has the same fields as the global hypervisor calls summary. It also includes elapsed time information if the -e flag is specified.
Pending Hypervisor Calls Summary	If the pthread was executing a hypervisor call at the end of the trace, a pending hypervisor calls summary will be printed. This has the Accumulated Time and Hypervisor Call fields. It also includes elapsed time information if the -e flag is specified.
Pthread Calls Summary	A summary of the pthread library calls for the pthread. This has the same fields as the global pthread Calls Summary. It also includes elapsed time information if the -e flag is specified.
Pending Pthread Calls Summary	If the pthread was executing a pthread library call at the end of the trace, a pending pthread call summary will be printed. This has the Accumulated Time and Pthread Routine fields. It also includes elapsed time information if the -e flag is specified.

The pthreads summary report also includes the following information:

processor affinity	Probability that for any dispatch of the pthread, the pthread was dispatched to the same processor on which it last executed.
Processor Dispatch Histogram for pthread	The number of times that the pthread was dispatched to each CPU in the system.

avg. dispatch wait time	The average elapsed time for the pthread from being undispached and its next dispatch.
Thread affinity	The probability that for any dispatch of the pthread, the pthread was dispatched to the same kernel thread on which it last executed
Thread Dispatch Histogram for pthread	The number of times that the pthread was dispatched to each kernel thread in the process.
total number of pthread dispatches	The total number of times the pthread was dispatched by the libpthreads dispatcher.
Data on Interrupts that occurred while Pthread was Running	The number of times each type of FLIH occurred while the pthread was executing.

Chapter 4. Simple Performance Lock Analysis Tool (splat)

The Simple Performance Lock Analysis Tool (splat) is a software tool that generates reports on the use of synchronization locks. These include the simple and complex locks provided by the AIX kernel, as well as user-level mutexes, read and write locks, and condition variables provided by the **PThread** library. The **splat** tool is not currently equipped to analyze the behavior of the Virtual Memory Manager (VMM) and PMAP locks used in the AIX kernel.

splat Command Syntax

The syntax for the **splat** command is as follows:

```
splat [-i file] [-n file] [-o file] [-d [bfta]] [-l address][-c class] [-s [acelmsS]] [-C#] [-S#] [-t start] [-T stop] [-p]
```

```
splat -h [topic]
```

```
splat -j
```

Flags

-i <i>inputfile</i>	Specifies the AIX trace log file input.
-n <i>namefile</i>	Specifies the file containing output of the gensyms command.
-o <i>outputfile</i>	Specifies an output file (default is stdout).
-d <i>detail</i>	Specifies the level of detail of the report.
-c <i>class</i>	Specifies class of locks to be reported.
-l <i>address</i>	Specifies the address for which activity on the lock will be reported.
-s <i>criteria</i>	Specifies the sort order of the lock, function, and thread.
-C <i>CPUs</i>	Specifies the number of processors on the MP system that the trace was drawn from. The default is 1. This value is overridden if more processors are observed to be reported in the trace.
-S <i>count</i>	Specifies the number of items to report on for each section. The default is 10. This gives the number of locks to report in the Lock Summary and Lock Detail reports, as well as the number of functions to report in the Function Detail and threads to report in the Thread detail (the -s option specifies how the most significant locks, threads, and functions are selected).
-t <i>starttime</i>	Overrides the start time from the first event recorded in the trace. This flag forces the analysis to begin an event that occurs <i>starttime</i> seconds after the first event in the trace.
-T <i>stoptime</i>	Overrides the stop time from the last event recorded in the trace. This flag forces the analysis to end with an event that occurs <i>stoptime</i> seconds after the first event in the trace.
-j	Prints the list of IDs of the trace hooks used by the splat command.
-h <i>topic</i>	Prints a help message on usage or a specific topic.
-p	Specifies the use of the PURR register to calculate CPU times.

Parameters

inputfile	The AIX trace log file input. This file can be a merge trace file generated using the trcrpt -r command.
namefile	File containing output of the gensyms command.
outputfile	File to write reports to.

detail The detail level of the report, it can be one of the following:

- basic** Lock summary plus lock detail (the default)
- function** Basic plus function detail
- thread** Basic plus thread detail
- all** Basic plus function plus thread detail

class Activity classes, which is a decimal value found in the `/usr/include/sys/lockname.h` file.

address The address to be reported, given in hexadecimal.

criteria Order the lock, function, and thread reports by the following criteria:

- a** Acquisitions
- c** Percent processor time held
- e** Percent elapsed time held
- l** Lock address, function address, or thread ID
- m** Miss rate
- s** Spin count
- S** Percent processor spin hold time (the default)

CPUs The number of processors on the MP system that the trace was drawn from. The default is 1. This value is overridden if more processors are observed to be reported in the trace.

count The number of locks to report in the Lock Summary and Lock Detail reports, as well as the number of functions to report in the Function Detail and threads to report in the Thread detail. (The **-s** option specifies how the most significant locks, threads, and functions are selected).

starttime The number of seconds after the first event recorded in the trace that the reporting starts.

stoptime The number of seconds after the first event recorded in the trace that the reporting stops.

topic Help topics, which are:

- all
- overview
- input
- names
- reports
- sorting

Measurement and Sampling

The **splat** tool takes as input an AIX trace log file or (for an SMP trace) a set of log files, and preferably a **names** file produced by the **gensyms** or **gennames** command. The procedure for generating these files is shown in the **trace** section. When you run **trace**, you will usually use the flag **-J splat** to capture the events analyzed by **splat** (or without the **-J** flag, to capture all events). The significant trace hooks are shown in the following table:

Hook ID	Event name	Event explanation
106	HKWD_KERN_DISPATCH	The thread is dispatched from the run queue to a processor.
10C	HKWD_KERN_IDLE	The idle process is been dispatched.
10E	HKWD_KERN_RELOCK	One thread is suspended while another is dispatched; the ownership of a RunQ lock is transferred from the first to the second.

Hook ID	Event name	Event explanation
112	HKWD_KERN_LOCK	The thread attempts to secure a kernel lock; the sub-hook shows what happened.
113	HKWD_KERN_UNLOCK	A kernel lock is released.
134	HKWD_SYSC_EXECVE	An exec supervisor call (SVC) has been issued by a (forked) process.
139	HKWD_SYSC_FORK	A fork SVC has been issued by a process.
419	HKWD_CPU_PREEMPT	A process has been preempted.
465	HKWD_SYSC_CRTHREAD	A thread_create SVC has been issued by a process.
46D	HKWD_KERN_WAITLOCK	The thread is enqueued to wait on a kernel lock.
46E	HKWD_KERN_WAKEUPLOCK	A thread has been awakened.
606	HKWD_PTHREAD_COND	Operations on a Condition Variable.
607	HKWD_PTHREAD_MUTEX	Operations on a Mutex.
608	HKWD_PTHREAD_RWLOCK	Operations on a Read/Write Lock.
609	HKWD_PTHREAD_GENERAL	Operations on a PThread .

Execution, Trace, and Analysis Intervals

In some cases, you can use the **trace** tool to capture the entire execution of a workload, while in other cases you will capture only an interval of the execution. The *execution interval* is the entire time that a workload runs. This interval is arbitrarily long for server workloads that run continuously. The *trace interval* is the time actually captured in the trace log file by **trace**. The length of this trace interval is limited by how large a trace log file will fit on the file system.

In contrast, the analysis interval is the portion of the trace interval that is analyzed by the **splat** command. The **-t** and **-T** flags indicate to the **splat** command to start and finish analysis some number of seconds after the first event in the trace. By default, the **splat** command analyzes the entire trace, so this analysis interval is the same as the trace interval.

Note: As an optimization, the **splat** command stops reading the trace when it finishes its analysis, so it indicates that the trace and analysis intervals end at the same time even if they do not.

To most accurately estimate the effect of lock activity on the computation, you will usually want to capture the longest trace interval that you can, and analyze that entire interval with the **splat** command. The **-t** and **-T** flags are usually used for debugging purposes to study the behavior of the **splat** command across a few events in the trace.

As a rule, either use large buffers when collecting a trace, or limit the captured events to the ones you need to run the **splat** command.

Trace Discontinuities

The **splat** command uses the events in the trace to reconstruct the activities of threads and locks in the original system. If part of the trace is missing, it is because one of the following situations exists:

- Tracing was stopped at one point and restarted at a later point.
- One processor fills its trace buffer and stops tracing, while other processors continue tracing.
- Event records in the trace buffer were overwritten before they could be copied into the trace log file.

In any of the above cases, the **splat** command will not be able to correctly analyze all the events across the trace interval. The policy of **splat** is to finish its analysis at the first point of discontinuity in the trace, issue a warning message, and generate its report. In the first two cases, the message is as follows:

TRACE OFF record read at 0.567201 seconds. One or more of the CPUs has stopped tracing. You may want to generate a longer trace using larger buffers and re-run splat.

In the third case, the message is as follows:

TRACEBUFFER WRAPAROUND record read at 0.567201 seconds. The input trace has some records missing; splat finishes analyzing at this point. You may want to re-generate the trace using larger buffers and re-run splat.

Some versions of the AIX kernel or **PThread** library may be incompletely instrumented, so the traces will be missing events. The **splat** command may not provide correct results in this case.

Address-to-Name Resolution in the splat Command

The lock instrumentation in the kernel and **PThread** library is what captures the information for each lock event. Data addresses are used to identify locks; instruction addresses are used to identify the point of execution. These addresses are captured in the event records in the trace, and used by the **splat** command to identify the locks and the functions that operate on them.

However, these addresses are not of much use to the programmer, who would rather know the names of the lock and function declarations so that they can be located in the program source files. The conversion of names to addresses is determined by the compiler and loader, and can be captured in a file using the **gensyms** command. The **gensyms** command also captures the contents of the **/usr/include/sys/lockname.h** file, which declares classes of kernel locks.

The **gensyms** output file is passed to the **splat** command with the **-n** flag. When **splat** reports on a kernel lock, it provides the best identification that it can.

Kernel locks that are declared are resolved by name. Locks that are created dynamically are identified by class if their class name is given when they are created. The **libpthreads.a** instrumentation is not equipped to capture names or classes of **PThread** synchronizers, so they are always identified by address only.

Examples of Generated Reports

The report generated by the **splat** command consists of an execution summary, a gross lock summary, and a per-lock summary, followed by a list of lock detail reports that optionally includes a function detail or a thread detail report.

Execution Summary

The following example shows a sample of the Execution summary. This report is generated by default when using the **splat** command.

```
*****
splat Cmd: splat -p -sa -da -S100 -i trace.cooked -n gensyms -o splat.out

Trace Cmd:  trace -C all -aj 600,603,605,606,607,608,609 -T 20000000 -L 200000000 -o CONDVAR.raw
Trace Host:  darkwing (0054451E4C00) AIX 5.2
Trace Date:  Thu Sep 27 11:26:16 2002
```

PURR was used to calculate CPU times.

```
Elapsed Real Time:      0.098167
Number of CPUs Traced: 1          (Observed):0
Cumulative CPU Time:   0.098167
```

```
----- start ----- stop -----
```

```

trace interval      (absolute tics)          967436752          969072535
                   (relative tics)              0                  1635783
                   (absolute secs)             58.057947         58.156114
                   (relative secs)             0.000000          0.098167
analysis interval  (absolute tics)          967436752          969072535
                   (trace-relative tics)       0                  1635783
                   (self-relative tics)        0                  1635783
                   (absolute secs)             58.057947         58.156114
                   (trace-relative secs)       0.000000          0.098167
                   (self-relative secs)        0.000000          0.098167
*****

```

From the example above, you can see that the execution summary consists of the following elements:

- The **splat** version and build information, disclaimer, and copyright notice.
- The command used to run **splat**.
- The **trace** command used to collect the trace.
- The host on which the trace was taken.
- The date that the trace was taken.
- A sentence specifying whether the PURR register was used to calculate CPU times.
- The real-time duration of the trace, expressed in seconds.
- The maximum number of processors that were observed in the trace (the number specified in the trace conditions information, and the number specified on the **splat** command line).
- The cumulative processor time, equal to the duration of the trace in seconds times the number of processors that represents the total number of seconds of processor time consumed.
- A table containing the start and stop times of the trace interval, measured in tics and seconds, as absolute timestamps, from the trace records, as well as relative to the first event in the trace
- The start and stop times of the analysis interval, measured in tics and seconds, as absolute timestamps, as well as relative to the beginning of the trace interval and the beginning of the analysis interval.

Gross Lock Summary

The following example shows a sample of the gross lock summary report. This report is generated by default when using the **splat** command.

```

*****
                Unique   Acquisitions   Acq. or Passes   Total System
                Total   Addresses   (or Passes)   per Second   Spin Time
                -----
AIX (all) Locks:   523     523     1323045     72175.7768     0.003986
                RunQ:    2         2       487178     26576.9121     0.000000
                Simple:  480     480     824898     45000.4754     0.003986
                Transformed:  22     18       234       352.3452
                Krlock:   50     21       76876     32.6548       0.000458
                Complex:  41     41       10969     598.3894     0.000000
PThread CondVar:  7         6      160623     8762.4305     0.000000
                Mutex:   128    116     1927771    105165.2585    10.280745 *
                RWLock:   0         0         0         0.0000       0.000000

( spin time goal )
*****

```

The gross lock summary report table consists of the following columns:

- Total** The number of AIX Kernel locks, followed by the number of each type of AIX Kernel lock; RunQ, Simple, and Complex. Under some conditions, this will be larger than the sum of the numbers of RunQ, Simple, and Complex locks because we may not observe enough activity on a lock to differentiate its type. This is followed by the number of PThread condition-variables, the number of PThread Mutexes, and the number of PThread Read/Write. The Transformed value represents the number of different simple locks responsible for the allocation (and liberation) of at least one Klock. In this case, two simple locks will be different if they are not created at the same time or they do not have the same address.
- Unique Addresses** The number of unique addresses observed for each synchronizer type. Under some conditions, a lock will be destroyed and re-created at the same address; the **splat** command produces a separate lock detail report for each instance because the usage might be different. The Transformed value represents the number of different simple locks responsible for the allocation (and liberation) of at least one Klock. In this case, simple locks created at different times but with the same address increment the counter only once.
- Acquisitions (or Passes)** For locks, the total number of times acquired during the analysis interval; for PThread condition-variables, the total number of times the condition passed during the analysis interval. The Transformed value represents the number of acquisitions made by a thread holding the corresponding Klock.
- Acq. or Passes (per Second)** Acquisitions or passes per second, which is the total number of acquisitions or passes divided by the elapsed real time of the trace. The Transformed value represents the acquisition rate for the acquisitions made by threads holding the corresponding klock.
- % Total System spin Time** The cumulative time spent spinning on each synchronizer type, divided by the cumulative processor time, times 100 percent. The general goal is to spin for less than 10 percent of the processor time; a message to this effect is printed at the bottom of the table. If any of the entries in this column exceed 10 percent, they are marked with an asterisk (*). For simple locks, the spin time of the Klocks is included.

Per-lock Summary

The following example shows a sample of the per-lock summary report. This report is generated by default when using the **splat** command.

```
*****
100 max entries, Summary sorted by Acquisitions:

Lock Names,          T Acqui-      Wait
Class, or Address   y sitions   or
                   p or       Trans-
                   e Passes Spins form
*****
PROC_INT_CLASS.0003 Q 486490 0    0
THREAD_LOCK_CLASS.0012 S 323277 0    9468
THREAD_LOCK_CLASS.0118 D 323094 0    4568
ELIST_CLASS.003C    S 80453 0    201
ELIST_CLASS.0044    S 80419 0    110
tod_lock            C 10229 0    0
LDATA_CONTROL_LOCK.0000 D 1833 0    10
U_TIMER_CLASS.0014 S 1514 0    23

( ... lines omitted ... )

000000002FF22B70    L 368838 0    N/A
00000000F00C3D74    M 160625 0    0
00000000200017E8    M 160625 175 0
0000000020001820    V 160623 0    624
00000000F00C3750    M 37 0    0
00000000F00C3800    M 30 0    0

( ... lines omitted ... )
*****
```

The first line indicates the maximum number of locks to report (100 in this case, but we show only 14 of the entries here) as specified by the **-S 100** flag. The report also indicates that the entries are sorted by

the total number of acquisitions or passes, as specified by the **-sa** flag. The various Kernel locks and **PThread** synchronizers are treated as two separate lists in this report, so the report would produce the top 100 Kernel locks sorted by acquisitions, followed by the top 100 **PThread** synchronizers sorted by acquisitions or passes.

The per-lock summary table consists of the following columns:

Lock Names, Class, or Address	The name, class, or address of the lock, depending on whether the splat command could map the address from a name file.
Type	The type of the lock, identified by one of the following letters: <ul style="list-style-type: none"> Q A RunQ lock S An enabled simple kernel lock D A disabled simple kernel lock C A complex kernel lock M A PThread mutex V A PThread condition-variable L A PThread read/write lock
Acquisitions or Passes	The number of times that the lock was acquired or the condition passed, during the analysis interval.
Spins	The number of times that the lock (or condition-variable) was spun on during the analysis interval.
Wait or Transform	The number of times that a thread was driven into a wait state for that lock or condition-variable during the analysis interval. When Krllocks are enabled, a simple lock never enters the wait state and this value represents the number of Krllocks that the simple lock has allocated, which is the transform count of simple locks.
%Miss	The percentage of access attempts that resulted in a spin as opposed to a successful acquisition or pass.
%Total	The percentage of all acquisitions that were made to this lock, out of all acquisitions to all locks of this type. All AIX locks (RunQ, simple, and complex) are treated as being the same type for this calculation. The PThread synchronizers mutex, condition-variable, and read/write lock are all distinct types.
Locks or Passes / CSec	The number of times that the lock (or condition-variable) was acquired (or passed) divided by the cumulative processor time. This is a measure of the acquisition frequency of the lock.
Percent Holdtime	
Real CPU	The percentage of the cumulative processor time that the lock was held by any thread at all, whether running or suspended. Note that this definition is not applicable to condition-variables because they are not held.
Real Elapse	The percentage of the elapsed real time that the lock was held by any thread at all, whether running or suspended. Note that this definition is not applicable to condition-variables because they are not held.
Comb Spin	The percentage of the cumulative processor time that executing threads spent spinning on the lock. The PThreads library uses waiting for condition-variables, so there is no time actually spent spinning.

AIX Kernel Lock Details

By default, the **splat** command prints a lock detail report for each entry in the summary report. The AIX Kernel locks can be either simple or complex.

The RunQ lock is a special case of the simple lock, although its pattern of usage will differ markedly from other lock types. The **splat** command distinguishes it from the other simple locks to ease its analysis.

Disabled Simple and RunQ Lock Details

In an AIX SIMPLE Lock report, the first line starts with either [AIX SIMPLE Lock] or [AIX RunQ lock]. If the **gennames** or **gensyms** output file allows, the ADDRESS is also converted into a lock NAME and CLASS, and the containing kernel extension (KEX) is identified as well. The CLASS is printed with an eight hex-digit extension indicating how many locks of this class were allocated prior to it.

```
[AIX SIMPLE Lock]                ADDRESS: 0000000020000D60        KEX: unknown
=====
Type:                               Trans-
Disabled | Miss Spin | form Busy | Secs Held | Percent Held ( 35.568534s )
          | Rate Count | Count Count | CPU Elapsed | Real Real Comb Real
          | 100.000 1 | 2658 0 | 0.000000 0.000000 | 0.00 0.00 0.00 29.62
-----
Total Acquisitions: 12945 | SpinQ Min Max Avg | Krlocks SpinQ Min Max Avg
Acq. holding krlock: 2498 | Depth 0 1 0 | Depth 0 1 0
-----
PROD | CONFER | HANDOFF
0 | SELF: 0 TARGET: 0 ALL: 0 | 0
  | w/ preemption: 0 w/ preemption: 0 |
-----
```

Lock Activity (mSecs) - Interrupts Disabled

SIMPLE	Count	Minimum	Maximum	Average	Total
++++++	++++++	+++++	+++++	+++++	+++++
LOCK	0	0.000000	0.000000	0.000000	0.000000
w/ KRLOCK	0	0.000000	0.000000	0.000000	0.000000
SPIN	0	0.000000	0.000000	0.000000	0.000000
KRLOCK LOCK	0	0.000000	0.000000	0.000000	0.000000
KRLOCK SPIN	0	0.000000	0.000000	0.000000	0.000000
TRANSFORM	0	0.000000	0.000000	0.000000	0.000000

Function Name	Acqui- sitions	Miss Rate	Spin Count	Transf. Count	Busy Count	Percent Held of CPU	Elapse Time	Spin Time	Transf. Time	Return Address	Start Address	Offset
.dispatch	3177	0.63	20	0	0	0.00	0.02	0.00	0.00	000000000039CF4	0000000000000000	00039CF4
.dispatch	6053	0.31	19	0	0	0.03	0.07	0.00	0.00	0000000000398E4	0000000000000000	000398E4
.setrq	3160	0.19	6	0	0	0.01	0.02	0.00	0.00	000000000038E60	0000000000000000	00038E60
.steal_threads	1	0.00	0	0	0	0.00	0.00	0.00	0.00	000000000066A68	0000000000000000	00066A68
.steal_threads	6	0.00	0	0	0	0.00	0.00	0.00	0.00	000000000066CE0	0000000000000000	00066CE0
.dispatch	535	2.19	12	0	12	0.01	0.02	0.00	0.00	000000000039D88	0000000000000000	00039D88
.dispatch	2	0.00	0	0	0	0.00	0.00	0.00	0.00	000000000039D14	0000000000000000	00039D14
.prio_requeue	7	0.00	0	0	0	0.00	0.00	0.00	0.00	00000000003B2A4	0000000000000000	0003B2A4
.setnewrq	4	0.00	0	0	0	0.00	0.00	0.00	0.00	000000000038980	0000000000000000	00038980

ThreadID	Acqui- sitions	Miss Rate	Spin Count	Transf. Count	Busy Count	Percent Held of CPU	Elapse Time	Spin Time	Transf. Time	ProcessID	Process Name
775	11548	0.34	39	0	0	0.06	0.10	0.00	0.00	774	wait
35619	3	25.00	1	0	0	0.00	0.00	0.00	0.00	18392	sleep
31339	21	4.55	1	0	0	0.00	0.00	0.00	0.00	7364	java
35621	2	0.00	0	0	0	0.00	0.00	0.00	0.00	18394	locktrace

(... lines omitted ...)

The SIMPLE lock report fields are as follows:

- Type** If the simple lock was used with interrupts, this field is enabled. Otherwise, this field is disabled.
- Miss Rate** The percentage of attempts that failed to acquire the lock.
- Spin Count** The number of unsuccessful attempts to acquire the lock.
- Busy Count** The number of **simple_lock_try** calls that returned busy.

Seconds Held	This field contains the following sub-fields: CPU The total number of processor seconds that the lock was held by an executing thread. Elapsed The total number of elapsed seconds that the lock was held by any thread, whether running or suspended.
Percent Held	This field contains the following sub-fields: Real CPU The percentage of the cumulative processor time that the lock was held by an executing thread. Real Elapsed The percentage of the elapsed real time that the lock was held by any thread at all, either running or suspended. Comb(ined) Spin The percentage of the cumulative processor time that running threads spent spinning while trying to acquire this lock. Real Wait The percentage of elapsed real time that any thread was waiting to acquire this lock. If two or more threads are waiting simultaneously, this wait time will only be charged once. To determine how many threads were waiting simultaneously, look at the WaitQ Depth statistics.
Total Acquisitions	The number of times that the lock was acquired in the analysis interval. This includes successful simple_lock_try calls.
Acq. holding krlock	The number of acquisitions made by threads holding a Krlock.
Transform count	The number of Krlocks that have been used (allocated and freed) by the simple lock.
SpinQ	The minimum, maximum, and average number of threads spinning on the lock, whether executing or suspended, across the analysis interval.
Krlocks SpinQ	The minimum, maximum, and average number of threads spinning on a Krlock allocated by the simple lock, across the analysis interval.
PROD	The associated Krlocks prod calls count.
CONFER SELF	The confer to self calls count for the simple lock and the associated Krlocks.
CONFER TARGET	The confer to target calls count for the simple lock and the associated Krlocks.
CONFER ALL	The confer to all calls count for the simple lock and the associated Krlocks.
HANDOFF	The associated Krlocks handoff calls count.

The Lock Activity with Interrupts Enabled (milliseconds) and Lock Activity with Interrupts Disabled (milliseconds) sections contain information on the time that each lock state is used by the locks.

The states that a thread can be in (with respect to a given simple or complex lock) are as follows:

(no lock reference)	The thread is running, does not hold this lock, and is not attempting to acquire this lock.
LOCK	The thread has successfully acquired the lock and is currently executing.
LOCK with KRLOCK	The thread has successfully acquired the lock, while holding the associated Krlock, and is currently executing.
SPIN	The thread is executing and unsuccessfully attempting to acquire the lock.
KRLOCK LOCK	The thread has successfully acquired the associated Krlock and is currently executing.
KRLOCK SPIN	The thread is executing and unsuccessfully attempting to acquire the associated Krlock.
TRANSFORM	The thread has successfully allocated a Krlock that it associates itself to and is executing.

The Lock Activity sections of the report measure the intervals of time (in milliseconds) that each thread spends in each of the states for this lock. The columns report the number of times that a thread entered the given state, followed by the maximum, minimum, and average time that a thread spent in the state once entered, followed by the total time that all threads spent in that state. These sections distinguish whether interrupts were enabled or disabled at the time that the thread was in the given state.

A thread can acquire a lock prior to the beginning of the analysis interval and release the lock during the analysis interval. When the **splat** command observes the lock being released, it recognizes that the lock had been held during the analysis interval up to that point and counts the time as part of the state-machine statistics. For this reason, the state-machine statistics can report that the number of times that the lock state was entered may actually be larger than the number of acquisitions of the lock that were observed in the analysis interval.

RunQ locks are used to protect resources in the thread management logic. These locks are acquired a large number of times and are only held briefly each time. A thread need not be executing to acquire or release a RunQ lock. Further, a thread may spin on a RunQ lock, but it will not go into an UNDISP or WAIT state on the lock. You will see a dramatic difference between the statistics for RunQ versus other simple locks.

Enabled Simple Lock Details

The following example is an enabled simple lock detail report:

```
[AIX SIMPLE Lock]          CLASS:      PROC_INT_CLASS.00000004
ADDRESS: 00000000200786C
-----
Type      Miss Spin Wait Busy      Secs Held      Percent Held ( 26.235284s )
Enabled   Rate Count Count Count CPU Elapsed      Real Real Comb Real
| 0.438 57 2658 12 |0.022852 0.032960 | 0.04 0.13 0.00 0.00
-----
Total Acquisitions: 2498 |SpinQ Min Max Avg |WaitQ Min Max Avg
                        |Depth 0 1 0 |Depth 0 0 0
-----
```

Lock Activity (mSecs) - Interrupts Enabled

SIMPLE	Count	Minimum	Maximum	Average	Total
LOCK	8027	0.000597	0.022486	0.002847	22.852000
SPIN	45	0.001376	0.008960	0.004738	0.213212
UNDISP	0	0.000000	0.000000	0.000000	0.000000
WAIT	0	0.000000	0.000000	0.000000	0.000000
PREEMPT	4918	0.000811	0.009728	0.001955	9.615807

Function Name	Acqui- sitions	Miss Rate	Spin Count	Wait Count	Busy Count	Percent Held of Total CPU	Elapse	Spin	Wait	Return Address	Start Address	Offset
.dispatch	3177	0.63	20	0	0	0.00	0.02	0.00	0.00	000000000039CF4	000000000000000	00039CF4
.dispatch	6053	0.31	19	0	0	0.03	0.07	0.00	0.00	0000000000398E4	000000000000000	000398E4
.setrq	3160	0.19	6	0	0	0.01	0.02	0.00	0.00	000000000038E60	000000000000000	00038E60
.steal_threads	1	0.00	0	0	0	0.00	0.00	0.00	0.00	000000000066A68	000000000000000	00066A68
.steal_threads	6	0.00	0	0	0	0.00	0.00	0.00	0.00	000000000066CE0	000000000000000	00066CE0
.dispatch	535	2.19	12	0	12	0.01	0.02	0.00	0.00	000000000039D88	000000000000000	00039D88
.dispatch	2	0.00	0	0	0	0.00	0.00	0.00	0.00	000000000039D14	000000000000000	00039D14
.prio_requeue	7	0.00	0	0	0	0.00	0.00	0.00	0.00	00000000003B2A4	000000000000000	0003B2A4
.setnewrq	4	0.00	0	0	0	0.00	0.00	0.00	0.00	00000000003B980	000000000000000	0003B980

ThreadID	Acqui- sitions	Miss Rate	Spin Count	Wait Count	Busy Count	Percent Held of Total CPU	Elapse	Spin	Wait	ProcessID	Process Name
775	11548	0.34	39	0	0	0.06	0.10	0.00	0.00	774	wait
35619	3	25.00	1	0	0	0.00	0.00	0.00	0.00	18392	sleep
31339	21	4.55	1	0	0	0.00	0.00	0.00	0.00	7364	java
35621	2	0.00	0	0	0	0.00	0.00	0.00	0.00	18394	locktrace

(... lines omitted ...)

The SIMPLE lock report fields are as follows:

Type	If the simple lock was used with interrupts, this field is enabled. Otherwise, this field is disabled.
Total Acquisitions	The number of times that the lock was acquired in the analysis interval. This includes successful simple_lock_try calls.
Miss Rate	The percentage of attempts that failed to acquire the lock.
Spin Count	The number of unsuccessful attempts to acquire the lock.
Wait Count	The number of times that a thread was forced into a suspended wait state, waiting for the lock to come available.
Busy Count	The number of simple_lock_try calls that returned busy.
Seconds Held	This field contains the following sub-fields: CPU The total number of processor seconds that the lock was held by an executing thread. Elapsed The total number of elapsed seconds that the lock was held by any thread, whether running or suspended.
Percent Held	This field contains the following sub-fields: Real CPU The percentage of the cumulative processor time that the lock was held by an executing thread. Real Elapsed The percentage of the elapsed real time that the lock was held by any thread at all, either running or suspended. Comb(ined) Spin The percentage of the cumulative processor time that running threads spent spinning while trying to acquire this lock. Real Wait The percentage of elapsed real time that any thread was waiting to acquire this lock. If two or more threads are waiting simultaneously, this wait time will only be charged once. To determine how many threads were waiting simultaneously, look at the WaitQ Depth statistics.
SpinQ	The minimum, maximum, and average number of threads spinning on the lock, whether executing or suspended, across the analysis interval.
WaitQ	The minimum, maximum, and average number of threads waiting on the lock, across the analysis interval.

The Lock Activity with Interrupts Enabled (milliseconds) and Lock Activity with Interrupts Disabled (milliseconds) sections contain information on the time that each lock state is used by the locks.

The states that a thread can be in (with respect to a given simple or complex lock) are as follows:

(no lock reference)	The thread is running, does not hold this lock, and is not attempting to acquire this lock.
LOCK	The thread has successfully acquired the lock and is currently executing.
SPIN	The thread is executing and unsuccessfully attempting to acquire the lock.
UNDISP	The thread has become undispached while unsuccessfully attempting to acquire the lock.
WAIT	The thread has been suspended until the lock comes available. It does not necessarily acquire the lock at that time, but instead returns to a SPIN state.
PREEMPT	The thread is holding this lock and has become undispached.

The Lock Activity sections of the report measure the intervals of time (in milliseconds) that each thread spends in each of the states for this lock. The columns report the number of times that a thread entered the given state, followed by the maximum, minimum, and average time that a thread spent in the state once entered, followed by the total time that all threads spent in that state. These sections distinguish whether interrupts were enabled or disabled at the time that the thread was in the given state.

A thread can acquire a lock prior to the beginning of the analysis interval and release the lock during the analysis interval. When the **splat** command observes the lock being released, it recognizes that the lock had been held during the analysis interval up to that point and counts the time as part of the state-machine statistics. For this reason, the state-machine statistics can report that the number of times that the lock state was entered may actually be larger than the number of acquisitions of the lock that were observed in the analysis interval.

RunQ locks are used to protect resources in the thread management logic. These locks are acquired a large number of times and are only held briefly each time. A thread need not be executing to acquire or release a RunQ lock. Further, a thread may spin on a RunQ lock, but it will not go into an UNDISP or WAIT state on the lock. You will see a dramatic difference between the statistics for RunQ versus other simple locks.

Function Detail

The function detail report is obtained by using the **-df** or **-da** options of **splat**.

The columns are defined as follows:

Function Name	The name of the function that acquired or attempted to acquire this lock, if it could be resolved.
Acquisitions	The number of times that the function was able to acquire this lock. For complex lock and read/write, there is a distinction between acquisition for writing, Acquisition Write , and for reading, Acquisition Read .
Miss Rate	The percentage of acquisition attempts that failed.
Spin Count	The number of unsuccessful attempts by the function to acquire this lock. For complex lock and read/write there is a distinction between spin count for writing, Spin Count Write , and for reading, Spin Count Read .
Transf. Count	The number of times that a simple lock has allocated a Klock, while a thread was trying to acquire the simple lock.
Busy Count	The number of times simple_lock_try calls returned busy.
Percent Held of Total Time	Contains the following sub-fields: <ul style="list-style-type: none"> CPU Percentage of the cumulative processor time that the lock was held by an executing thread that had acquired the lock through a call to this function. EIapse(d) The percentage of the elapsed real time that the lock was held by any thread at all, whether running or suspended, that had acquired the lock through a call to this function. Spin The percentage of cumulative processor time that executing threads spent spinning on the lock while trying to acquire the lock through a call to this function. Wait The percentage of elapsed real time that executing threads spent waiting for the lock while trying to acquire the lock through a call to this function.
Return Address	The return address to this calling function, in hexadecimal.
Start Address	The start address to this calling function, in hexadecimal.
Offset	The offset from the function start address to the return address, in hexadecimal.

The functions are ordered by the same sorting criterion as the locks, controlled by the **-s** option of **splat**. Further, the number of functions listed is controlled by the **-S** parameter. The default is the top ten functions.

Thread Detail

The Thread Detail report is obtained by using the **-dt** or **-da** options of **splat**.

At any point in time, a single thread is either running or it is not. When a single thread runs, it only runs on one processor. Some of the composite statistics are measured relative to the cumulative processor time when they measure activities that can happen simultaneously on more than one processor, and the magnitude of the measurements can be proportional to the number of processors in the system. In contrast, the thread statistics are generally measured relative to the elapsed real time, which is the amount of time that a single processor spends processing and the amount of time that a single thread spends in an executing or suspended state.

The Thread Detail report columns are defined as follows:

ThreadID	The thread identifier.
Acquisitions	The number of times that this thread acquired the lock.
Miss Rate	The percentage of acquisition attempts by the thread that failed to secure the lock.
Spin Count	The number of unsuccessful attempts by this thread to secure the lock.
Transf. Count	The number of times that a simple lock has allocated a Krlock, while a thread was trying to acquire the simple lock.
Wait Count	The number of times that this thread was forced to wait until the lock came available.
Busy Count	The number of simple_lock_try() calls that returned busy.
Percent Held of Total Time	Consists of the following sub-fields: <ul style="list-style-type: none"> CPU The percentage of the elapsed real time that this thread executed while holding the lock. Elapse(d) The percentage of the elapsed real time that this thread held the lock while running or suspended. Spin The percentage of elapsed real time that this thread executed while spinning on the lock. Wait The percentage of elapsed real time that this thread spent waiting on the lock.
Process ID	The Process identifier (only for simple and complex lock report).
Process Name	Name of the process using the lock (only for simple and complex lock report).

Complex-Lock Report

AIX Complex lock supports recursive locking, where a thread can acquire the lock more than once before releasing it, as well as differentiating between write-locking, which is exclusive, from read-locking, which is not exclusive.

This report begins with [AIX COMPLEX Lock]. Most of the entries are identical to the simple lock report, while some of them are differentiated by read/write/upgrade. For example, the SpinQ and WaitQ statistics include the minimum, maximum, and average number of threads spinning or waiting on the lock. They also include the minimum, maximum, and average number of threads attempting to acquire the lock for reading versus writing. Because an arbitrary number of threads can hold the lock for reading, the report includes the minimum, maximum, and average number of readers in the LockQ that holds the lock.

A thread may hold a lock for writing; this is exclusive and prevents any other thread from securing the lock for reading or for writing. The thread downgrades the lock by simultaneously releasing it for writing and acquiring it for reading; this allows other threads to also acquire the lock for reading. The reverse of this

operation is an upgrade; if the thread holds the lock for reading and no other thread holds it as well, the thread simultaneously releases the lock for reading and acquires it for writing. The upgrade operation may require that the thread wait until other threads release their read-locks. The downgrade operation does not.

A thread may acquire the lock to some recursive depth; it must release the lock the same number of times to free it. This is useful in library code where a lock must be secured at each entry-point to the library; a thread will secure the lock once as it enters the library, and internal calls to the library entry-points simply re-secure the lock, and release it when returning from the call. The minimum, maximum, and average recursion depths of any thread holding this lock are reported in the table.

A thread holding a recursive write-lock is not allowed to downgrade it because the downgrade is intended to apply to only the last write-acquisition of the lock, and the prior acquisitions had a real reason to keep the acquisition exclusive. Instead, the lock is marked as being in the downgraded state, which is erased when the this latest acquisition is released or upgraded. A thread holding a recursive read-lock can only upgrade the latest acquisition of the lock, in which case the lock is marked as being upgraded. The thread will have to wait until the lock is released by any other threads holding it for reading. The minimum, maximum, and average recursion-depths of any thread holding this lock in an upgraded or downgraded state are reported in the table.

The Lock Activity report also breaks down the time based on what task the lock is being secured for (reading, writing, or upgrading).

No time is reported to perform a downgrade because this is performed without any contention. The upgrade state is only reported for the case where a recursive read-lock is upgraded. Otherwise, the thread activity is measured as releasing a read-lock and acquiring a write-lock.

The function and thread details also break down the acquisition, spin, and wait counts by whether the lock is to be acquired for reading or writing.

PThread Synchronizer Reports

By default, the **splat** command prints a detailed report for each **PThread** entry in the summary report. The **PThread** synchronizers are of the following types: mutex, read/write lock, and condition-variable. The mutex and read/write lock are related to the AIX complex lock. You can view the similarities in the lock detail reports. The condition-variable differs significantly from a lock, and this is reflected in the report details.

The **PThread** library instrumentation does not provide names or classes of synchronizers, so the addresses are the only way we have to identify them. Under certain conditions, the instrumentation can capture the return addresses of the function call stack, and these addresses are used with the **gensyms** output to identify the call chains when these synchronizers are created. The creation and deletion times of the synchronizer can sometimes be determined as well, along with the ID of the **PThread** that created them.

Mutex Reports

The **PThread** mutex is similar to an AIX simple lock in that only one thread can acquire the lock, and is like an AIX complex lock in that it can be held recursively.

```
[PThread MUTEX] ADDRESS: 00000000F0154CD0
Parent Thread: 0000000000000001 creation time: 26.232305
Pid: 18396 Process Name: trcstop
Creation call-chain =====
0000000D268606C .pthread_mutex_lock
0000000D268EB88 .pthread_once
0000000D01FE588 ._libs_init
0000000D01EB2FC ._libc_inline_callbacks
0000000D01EB280 ._libc_declare_data_functions
0000000D269F960 ._pth_init_libc
0000000D268A2B4 .pthread_init
0000000D01EAC08 ._modinit
00000001000014C ._start
=====
```

Acqui- sitions	Miss Rate	Spin Count	Wait Count	Busy Count	Secs Held		Percent Held (26.235284s)			
					CPU	Elapsed	Real CPU	Real Elapsed	Comb Spin	Real Wait
1	0.000	0	0	0	0.000006	0.000006	0.00	0.00	0.00	0.00

Depth	Min	Max	Avg
SpinQ	0	0	0
WaitQ	0	0	0
Recursion	0	1	0

PThreadID	Acqui- sitions	Miss Rate	Spin Count	Wait Count	Busy Count	Percent Held of Total Time			
						CPU	Elapse	Spin	Wait
1	1	0.00	0	0	0	0.00	0.00	0.00	0.00

Function Name	Acqui- sitions	Miss Rate	Spin Count	Wait Count	Busy Count	Percent Held of Total Time				Return Address	Start Address	Offset
						CPU	Elapse	Spin	Wait			
.pthread_once	0	0.00	0	0	0	99.99	99.99	0.00	0.00	00000000D268EC98	00000000D2684180	0000AB18
.pthread_once	1	0.00	0	0	0	0.01	0.01	0.00	0.00	00000000D268EB88	00000000D2684180	0000AA08

In addition to the common header information and the **[PThread MUTEX]** identifier, this report lists the following lock details:

- Parent Thread** Pthread id of the parent pthread.
- creation time** Elapsed time in seconds after the first event recorded in trace (if available).
- deletion time** Elapsed time in seconds after the first event recorded in trace (if available).
- PID** Process identifier.
- Process Name** Name of the process using the lock.
- Call-chain** Stack of called methods (if available).
- Acquisitions** The number of times that the lock was acquired in the analysis interval.
- Miss Rate** The percentage of attempts that failed to acquire the lock.
- Spin Count** The number of unsuccessful attempts to acquire the lock.
- Wait Count** The number of times that a thread was forced into a suspended wait state waiting for the lock to come available.
- Busy Count** The number of **trylock** calls that returned busy.
- Seconds Held** This field contains the following sub-fields:
 - CPU** The total number of processor seconds that the lock was held by an executing thread.
 - Elapse(d)** The total number of elapsed seconds that the lock was held, whether the thread was running or suspended.
- Percent Held** This field contains the following sub-fields:
 - Real CPU** The percentage of the cumulative processor time that the lock was held by an executing thread.
 - Real Elapsed** The percentage of the elapsed real time that the lock was held by any thread, either running or suspended.
 - Comb(ined) Spin** The percentage of the cumulative processor time that running threads spent spinning while trying to acquire this lock.
 - Real Wait** The percentage of elapsed real time that any thread was waiting to acquire this lock. If two or more threads are waiting simultaneously, this wait time will only be charged once. To learn how many threads were waiting simultaneously, look at the WaitQ Depth statistics.

Depth

This field contains the following sub-fields:

SpinQ The minimum, maximum, and average number of threads spinning on the lock, whether executing or suspended, across the analysis interval.

WaitQ The minimum, maximum, and average number of threads waiting on the lock, across the analysis interval.

Recursion

The minimum, maximum, and average recursion depth to which each thread held the lock.

Mutex Pthread Detail

If the **-dt** or **-da** options are used, the **splat** command reports the pthread detail as described below:

PThreadID	The PThread identifier.
Acquisitions	The number of times that this pthread acquired the mutex.
Miss Rate	The percentage of acquisition attempts by the pthread that failed to secure the mutex.
Spin Count	The number of unsuccessful attempts by this pthread to secure the mutex.
Wait Count	The number of times that this pthread was forced to wait until the mutex came available.
Busy Count	The number of trylock calls that returned busy.
Percent Held of Total Time	This field contains the following sub-fields: <ul style="list-style-type: none">CPU The percentage of the elapsed real time that this pthread executed while holding the mutex.Elapse(d) The percentage of the elapsed real time that this pthread held the mutex while running or suspended.Spin The percentage of elapsed real time that this pthread executed while spinning on the mutex.Wait The percentage of elapsed real time that this pthread spent waiting on the mutex.

Mutex Function Detail

If the **-df** or **-da** options are used, the **splat** command reports the function detail as described below:

PThreadID	The PThread identifier.
Acquisitions	The number of times that this function acquired the mutex.
Miss Rate	The percentage of acquisition attempts by the function that failed to secure the mutex.
Spin Count	The number of unsuccessful attempts by this function to secure the mutex.
Wait Count	The number of times that this function was forced to wait until the mutex came available.
Busy Count	The number of trylock calls that returned busy.

Percent Held of Total Time

This field contains the following sub-fields:

CPU The percentage of the elapsed real time that this function executed while holding the mutex.

EIapse(d)

The percentage of the elapsed real time that this function held the mutex while running or suspended.

Spin The percentage of elapsed real time that this function executed while spinning on the mutex.

Wait The percentage of elapsed real time that this function spent waiting for the mutex.

Return Address

The return address to this calling function, in hexadecimal.

Start Address

The start address to this calling function, in hexadecimal.

Offset

The offset from the function start address to the return address, in hexadecimal.

Read/Write Lock Reports

The **PThread** read/write lock is similar to an AIX complex lock in that it can be acquired for reading or writing; writing is exclusive in that a single thread can only acquire the lock for writing, and no other thread can hold the lock for reading or writing at that point. Reading is not exclusive, so more than one thread can hold the lock for reading. Reading is recursive in that a single thread can hold multiple read-acquisitions on the lock. Writing is not recursive.

[PThread RWLock] ADDRESS: 00000000FF228E0
Parent Thread: 000000000000001 creation time: 5.236585 deletion time: 6.090511
Pid: 7362 Process Name: /home/testrwlock

Creation call-chain =====
0000000010000458 .main
00000000100001DC ._start
=====

Acqui- sitions	Miss Rate	Spin Count	Wait Count	Secs Held		Percent Held (26.235284s)			
				CPU	Elapsed	Real CPU	Real Elapsed	Comb Spin	Real Wait
1150	40.568	785	0	21.037942	12.0346	80.19	99.22	30.45	46.29

Depth	Readers			Writers			Total		
	Min	Max	Avg	Min	Max	Avg	Min	Max	Avg
LockQ	0	2	0	0	1	0	0	2	0
SpinQ	0	768	601	0	15	11	0	782	612
WaitQ	0	769	166	0	15	3	0	783	169

PthreadID	Acquisitions		Miss Rate	Spin Write	Count Read	Wait Write	Count Read	Busy Count	Percent Held of Total Time			
	Write	Read							CPU	Elapse	Spin	Wait
772	0	207	78.70	0	765	0	796	0	11.58	15.13	29.69	23.21
515	765	0	1.80	14	0	14	0	0	80.10	80.19	49.76	23.08
258	0	178	3.26	0	6	0	5	0	12.56	17.10	10.00	20.02

Function Name	Acquisitions		Miss Rate	Spin Write	Count Read	Wait Write	Count Read	Busy Count	Percent Held of Total Time				Return Address	Start Address	Offset
	Write	Read							CPU	Elapse	Spin	Wait			
._pthread_body	765	385	40.57	14	771	0	0	0	1.55	3.10	1.63	0.00	00000000D268944C	00000000D2684180	000052CC

In addition to the common header information and the **[PThread RWLock]** identifier, this report lists the following lock details:

- Parent Thread** Pthread id of the parent pthread.
- creation time** Elapsed time in seconds after the first event recorded in trace (if available).
- deletion time** Elapsed time in seconds after the first event recorded in trace (if available).
- PID** Process identifier.
- Process Name** Name of the process using the lock.
- Call-chain** Stack of called methods (if available).
- Acquisitions** The number of times that the lock was acquired in the analysis interval.

Miss Rate	The percentage of attempts that failed to acquire the lock.
Spin Count	The number of unsuccessful attempts to acquire the lock.
Wait Count	The current PThread implementation does not force pthreads to wait for read/write locks. This reports the number of times a thread, spinning on this lock, is undispatched.
Seconds Held	This field contains the following sub-fields: <ul style="list-style-type: none"> CPU The total number of processor seconds that the lock was held by an executing pthread. If the lock is held multiple times by the same pthread, only one hold interval is counted. Elapse(d) The total number of elapsed seconds that the lock was held by any pthread, whether the pthread was running or suspended.
Percent Held	This field contains the following sub-fields: <ul style="list-style-type: none"> Real CPU The percentage of the cumulative processor time that the lock was held by any executing pthread. Real Elapsed The percentage of the elapsed real time that the lock was held by any pthread, either running or suspended. Comb(ined) Spin The percentage of the cumulative processor time that running pthreads spent spinning while trying to acquire this lock. Real Wait The percentage of elapsed real time that any pthread was waiting to acquire this lock. If two or more threads are waiting simultaneously, this wait time will only be charged once. To learn how many pthreads were waiting simultaneously, look at the WaitQ Depth statistics.
Depth	This field contains the following sub-fields: <ul style="list-style-type: none"> LockQ The minimum, maximum, and average number of pthreads holding the lock, whether executing or suspended, across the analysis interval. This is broken down by read-acquisitions, write-acquisitions, and total acquisitions. SpinQ The minimum, maximum, and average number of pthreads spinning on the lock, whether executing or suspended, across the analysis interval. This is broken down by read-acquisitions, write-acquisitions, and total acquisitions. WaitQ The minimum, maximum, and average number of pthreads in a timed-wait state for the lock, across the analysis interval. This is broken down by read-acquisitions, write-acquisitions, and and total acquisitions.

Note: The pthread and function details for read/write locks are similar to the mutex detail reports, except that they break down the acquisition, spin, and wait counts by whether the lock is to be acquired for reading or writing.

Condition-Variable Report

The **PThread** condition-variable is a synchronizer, but not a lock. A **PThread** is suspended until a signal indicates that the condition now holds.

```
[PThread CondVar] ADDRESS: 0000000020000A18
Parent Thread: 0000000000000001 creation time: 0.216301
Pid: 7360 Process Name: /home/splat/test/condition
Creation call-chain =====
00000000D26A0EE8 .pthread_cond_timedwait
0000000010000510 .main
00000000100001DC .__start
=====
| Spin / Wait Time ( 26.235284s )
```

Passes	Fail Rate	Spin Count	Wait Count	Comb Spin	Comb Wait
1	50.0000	1	0	26.02	0.00

Depth	Min	Max	Avg
SpinQ	0	1	1
WaitQ	0	0	0

PThreadID	Passes	Fail Rate	Spin Count	Wait Count	% Total Time Spin	% Total Time Wait
1	1	50.0000	1	0	99.1755	0.0000

Function Name	Passes	Fail Rate	Spin Count	Wait Count	% Total Time Spin	% Total Time Wait	Return Address	Start Address	Offset
._start	1	50.0000	1	0	99.1755	0.0000	00000000100001DC	0000000010000000	000001DC

In addition to the common header information and the **[PThread CondVar]** identifier, this report lists the following details:

- Passes** The number of times that the condition was signaled to hold during the analysis interval.
- Fail Rate** The percentage of times that the condition was tested and was not found to be true.
- Spin Count** The number of times that the condition was tested and was not found to be true.
- Wait Count** The number of times that a pthread was forced into a suspended wait state waiting for the condition to be signaled.
- Spin / Wait Time** This field contains the following sub-fields:
 - Comb Spin** The total number of processor seconds that pthreads spun while waiting for the condition.
 - Comb Wait** The total number of elapsed seconds that pthreads spent in a wait state for the condition.
- Depth** This field contains the following sub-fields:
 - SpinQ** The minimum, maximum, and average number of pthreads spinning while waiting for the condition, across the analysis interval.
 - WaitQ** The minimum, maximum, and average number of pthreads waiting for the condition, across the analysis interval.

Condition-Variable Pthread Detail

If the **-dt** or **-da** options are used, the **splat** command reports the pthread detail as described below:

- PThreadID** The **PThread** identifier.
- Passes** The number of times that this pthread was notified that the condition passed.
- Fail Rate** The percentage of times that the pthread checked the condition and did not find it to be true.
- Spin Count** The number of times that the pthread checked the condition and did not find it to be true.
- Wait Count** The number of times that this pthread was forced to wait until the condition became true.
- Percent Total Time** This field contains the following sub-fields:
 - Spin** The percentage of elapsed real time that this pthread spun while testing the condition.
 - Wait** The percentage of elapsed real time that this pthread spent waiting for the condition to hold.

Condition-Variable Function Detail

If the **-df** or **-da** options are used, the **splat** command reports the function detail as described below:

Function Name	The name of the function that passed or attempted to pass this condition.
Passes	The number of times that this function was notified that the condition passed.
Fail Rate	The percentage of times that the function checked the condition and did not find it to be true.
Spin Count	The number of times that the function checked the condition and did not find it to be true.
Wait Count	The number of times that this function was forced to wait until the condition became true.
Percent Total Time	This field contains the following sub-fields: Spin The percentage of elapsed real time that this function spun while testing the condition. Wait The percentage of elapsed real time that this function spent waiting for the condition to hold.
Return Address	The return address to this calling function, in hexadecimal.
Start Address	The start address to this calling function, in hexadecimal.
Offset	The offset from the function start address to the return address, in hexadecimal.

Chapter 5. Hardware Performance Monitor APIs and tools

The **bos.pmapi** fileset contains libraries and tools that are designed to provide access to some of the counting facilities of the Performance Monitor feature included in select IBM microprocessors. They include the following:

- The **pmapi** library, which contains a set of low-level application programming interfaces, APIs, includes the following:
 - A set of system-level APIs to allow counting of the activity of a whole machine or of a set of processes with a common ancestor.
 - A set of first party kernel-thread-level APIs to allow threads to count their own activity.
 - A set of third party kernel-thread-level APIs to allow a debug program to count the activity of target threads.
- The **pmcycle** command, which returns the processor clock and decremter speeds.
- The **pmlist** command, which displays information about processors, events, event groups and sets, and derived metrics supported.
- The **hpm** and **hpm_r** libraries, which contain a set of high-level APIs that allow the following:
 - Nested instrumentation of sections of code
 - Automatic calculation of derived metrics, and gathering of operating system resource-consumption metrics in addition to the raw hardware counter values
- The **hpmstat** command, which collects the hardware performance monitor raw and derived metrics concerning total system activity of a machine.
- The **hpmcount** command, which executes applications and provides the applications' execution wall clock time, the raw and derived hardware performance monitor metrics and the operating system resource-utilization statistics.

Note: The APIs and the events available on each of the supported processors have been completely separated by design. The events available, their descriptions, and their current testing status (which are different on each processor) are in separately installable tables, and are not described here because none of the API calls depend on the availability or status of any of the events.

The status of an event, as returned by the **pm_initialize** API initialization routine, can be *verified*, *unverified*, *caveat*, *broken*, *group-only*, *thresholdable*, or *shared* (see "Performance Monitor accuracy" about testing status and event accuracy).

An event filter (which is any combination of the status bits) must be passed to the **pm_initialize** routine to force the return of events with status matching the filter. If no filter is passed to the **pm_initialize** routine, no events will be returned.

The following topics discuss programming the Performance Monitor API:

- "Performance Monitor accuracy"
- "Performance Monitor context and state" on page 116
- "Thread accumulation and thread group accumulation" on page 117
- "Security considerations" on page 117
- "The pmapi library" on page 117
- "The hpm library and associated tools" on page 125

Performance Monitor accuracy

Only events marked *verified* have gone through full verification. Events marked *caveat* have been verified within the limitations documented in the event description returned by the **pm_initialize** routine.

Events marked *unverified* have undefined accuracy. Use caution with *unverified* events. The Performance Monitor API is essentially providing a service to read hardware registers that may not have any meaningful content.

Users may experiment with *unverified* event counters and determine for themselves if they can be used for specific tuning situations.

Performance Monitor context and state

To provide Performance Monitor data access at various levels, the AIX operating system supports optional performance monitoring contexts. These contexts are an extension to the regular processor and thread contexts and include one 64-bit counter per hardware counter and a set of control words. The control words define which events are counted and when counting is on or off.

System-level context and accumulation

For the system-level APIs, optional Performance Monitor contexts can be associated with each of the processors. When installed, the Performance Monitor kernel extension automatically handles 32-bit Performance Monitor hardware counter overflows. It also maintains per-processor sets of 64-bit accumulation counters (one per 32-bit hardware Performance Monitor counter).

Thread context

Optional Performance Monitor contexts can also be associated with each thread. The AIX operating system and the Performance Monitor kernel extension automatically maintain sets of 64-bit counters for each of these contexts.

Thread counting-group and process context

The concept of thread counting-group is optionally supported by the thread-level APIs. All the threads within a group, in addition to their own Performance Monitor context, share a group accumulation context. A thread group is defined as all the threads created by a common ancestor thread. By definition, all the threads in a thread group count the same set of events, and, with one exception described below, the group must be created before any of the descendant threads are created. This restriction is due to the fact that, after descendant threads are created, it is impossible to determine a list of threads with a common ancestor.

One special case of a group is the collection of all the threads belonging to a process. Such a group can be created at any time regardless of when the descendant threads are created, because a list of threads belonging to a process can be generated. Multiple groups can coexist within a process, but each thread can be a member of only one Performance Monitor counting-group. Because all the threads within a group must be counting the same events, a process group creation will fail if any thread within the process already has a context.

Performance Monitor state inheritance

The PM state is defined as the combination of the Performance Monitor programming (the events being counted), the counting state (on or off), and the optional thread group membership. A counting state is associated with each group. When the group is created, its counting state is inherited from the initial thread in the group. For thread members of a group, the effective counting state is the result of AND-ing their own counting state with the group counting state. This provides a way to effectively control the counting state for all threads in a group. Simply manipulating the group-counting state will affect the effective counting state of all the threads in the group. Threads inherit their complete Performance Monitor state from their parents when the thread is created. A thread Performance Monitor context data (the value of the 64-bit counters) is not inherited, that is, newly created threads start with counters set to zero.

Thread accumulation and thread group accumulation

When a thread gets suspended (or redispached), its 64-bit accumulation counters are updated. If the thread is member of a group, the group accumulation counters are updated at the same time.

Similarly, when a thread stops counting or reads its Performance Monitor data, its 64 bit accumulation counters are also updated by adding the current value of the Performance Monitor hardware counters to them. Again, if the thread is a member of a group, the group accumulation counters are also updated, regardless of whether the counter read or stop was for the thread or for the thread group.

The group-level accumulation data is kept consistent with the individual Performance Monitor data for the thread members of the group, whenever possible. When a thread voluntarily leaves a group, that is, deletes its Performance Monitor context, its accumulated data is automatically subtracted from the group-level accumulated data. Similarly, when a thread member in a group resets its own data, the data in question is subtracted from the group level accumulated data. When a thread dies, no action is taken on the group-accumulated data.

The only situation where the group-level accumulation is not consistent with the sum of the data for each of its members is when the group-level accumulated data has been reset, and the group has more than one member. This situation is detected and marked by a bit returned when the group data is read.

Security considerations

The system-level APIs calls are only available from the root user except when the process tree option is used. In that case, a locking mechanism prevents calls being made from more than one process. This mechanism ensures ownership of the API and exclusive access by one process from the time that the system-level contexts are created until they are deleted.

Enabling the process tree option results in counting for only the calling process and its descendants; the default is to count all activities on each processor.

Because the system-level APIs would report bogus data if thread contexts were in use, system-level API calls are not allowed at the same time as thread-level API calls. The allocation of the first thread context will take the system-level API lock, which will not be released until the last context has been deallocated.

When using first party calls, a thread is only allowed to modify its own Performance Monitor context. The only exception to this rule is when making group level calls, which obviously affect the group context, but can also affect other threads' context. Deleting a group deletes all the contexts associated with the group, that is, the caller context, the group context, and all the contexts belonging to all the threads in the group.

Access to a Performance Monitor context not belonging to the calling thread or its group is available only from the target process's debugger program. The third party API calls are only allowed when the target process is either being **ptraced** by the API caller, that is, the caller is already attached to the target process, and the target process is stopped or the target process is stopped on a **/proc** file system event and the caller has the privilege required to open its control file.

The fact that the debugger program must already have been attached to the debugged thread before any third party call to the API can be made, ensures that the security level of the API will be the same as the one used between debugger programs and process being debugged.

The pmapi library

The following rules are common to the Performance Monitor APIs:

- The **pm_initialize** routine must be called before any other API call can be made, and only events returned by a given **pm_initialize** call with its associated filter setting can be used in subsequent **pm_set_program** calls.
- PM contexts cannot be reprogrammed or reused at any time. This means that none of the APIs support more than one call to a **pm_set_program** interface without a call to a **pm_delete_program** interface. This also means that when creating a process group, none of the threads in the process is allowed to already have a context.
- All the API calls return 0 when successful or a positive error code (which can be decoded using **pm_error**) otherwise.

The pm_init API initialization routine

The **pm_init** routine returns (in a structure of type **pm_info_t** pointed to by its second parameter) the processor name, the number of counters available, the list of available events for each counter, and the threshold multipliers supported. Some processors support two threshold multipliers, others none, meaning that thresholding is not supported at all. You can not use the **pm_init** routine with processors newer than POWER4. You must use the **pm_initialize** routine for newer processors.

For each event returned, in addition to the testing status, the **pm_init** routine also returns the identifier to be used in subsequent API calls, a short name, and a long name. The short name is a mnemonic name in the form PM_MNEMONIC. Events that are the same on different processors will have the same mnemonic name. For instance, PM_CYC and PM_INST_CMPL are respectively the number of processor cycles and instruction completed and should exist on all processors. For each event returned, a thresholdable flag is also returned. This flag indicates whether an event can be used with a threshold. If so, then specifying a threshold defers counting until a number of cycles equal to the threshold multiplied by the processor's selected threshold multiplier has been exceeded.

Beginning with AIX level 5.1.0.15, the Performance Monitoring API enables the specification of event groups instead of individual events. Event groups are predefined sets of events. Rather than each event being individually specified, a single group ID is specified. The interface to the **pm_init** routine has been enhanced to return the list of supported event groups in a structure of type **pm_groups_info_t** pointed to by a new optional third parameter. To preserve binary compatibility, the third parameter must be explicitly announced by OR-ing the PM_GET_GROUPS bitflag into the filter. Some events on some platforms can only be used from within a group. This is indicated in the threshold flag associated with each event returned. The following convention is used:

y	A thresholdable event
g	An event that can only be used in a group
G	A thresholdable event that can only be used in a group
n	A non-thresholdable event that is usable individually

On some platforms, use of event groups is required because all the events are marked **g** or **G**. Each of the event groups that are returned includes a short name, a long name, and a description similar to those associated with events, as well as a group identifier to be used in subsequent API calls and the events contained in the group (in the form of an array of event identifiers).

The testing status of a group is defined as the lowest common denominator among the testing status of the events that it includes. If at least one event has a testing status of *caveat*, the group testing status is at best *caveat*, and if at least one event has a status of *unverified*, then the group status is *unverified*. This is not returned as a group characteristic, but it is taken into account by the filter. Like events, only groups with status matching the filter are returned.

The `pm_initialize` API initialize routine

The `pm_initialize` routine returns the processor name in a structure of type `pm_info2_t` defined by its second parameter, its characteristics, the number of counters available, and the list of available events for each counter.

For each event a status is returned, indicating the event status: *validated*, *unvalidated*, or *validated with caveat*. The status also indicates if the event can be used in a group or not, if it is a thresholdable event and if it is a shared event.

Some events on some platforms can be used only within a group. In the case where an event group is specified instead of individual events, the events are defined as *grouped only* events.

For each returned event, a thresholdable state is also returned. It indicates whether an event can be used with a threshold. If so, specifying a threshold defers counting until it exceeds a number of cycles equal to the threshold multiplied by the selected processor threshold multiplier.

Some processors support two hardware threads per physical processing unit. Each thread implements a set of counters, but some events defined for those processors are shared events. A shared event, is controlled by a signal not specific to a particular thread's activity and sent simultaneously to both sets of hardware counters, one for each thread. Those events are marked by the *shared* status.

For each returned event, in addition to the testing status, the `pm_initialize` routine returns the identifier to be used in subsequent API calls, as a short name and a long name. The short name is a mnemonic name in the form `PM_MNEMONIC`. The same events on different processors will have the same mnemonic name. For instance, `PM_CYC` and `PM_INST_CMPL` are respectively the number of processor cycles and the number of completed instructions, and should exist on all processors.

The Performance Monitoring API allows the specification of event groups instead of individual events. Event groups are predefined sets of events. Rather than to specify individually each event, a single group ID can be specified. The interface to the `pm_initialize` routine returns the list of supported event groups in a structure of type `pm_groups_info_t` whose address is returned in the third parameter.

On some platforms, the use of event groups is required because all events are marked as group-only. Each event group that is returned includes a short name, a long name, and a description similar to those associated with events, as well as a group identifier to be used in subsequent API calls and the events contained in the group (in the form of an array of event identifiers).

The testing status of a group is defined as the lowest common denominator among the testing status of the events that it includes. If the testing status of at least one event is *caveat*, then the group testing status is at best *caveat*, and if the status of at least one event is *unverified*, then the group status is *unverified*. This is not returned as a group characteristic, but it is taken into account by the filter. Like events, only groups whose status match the filter are returned.

If the `proctype` parameter is not set to `PM_CURRENT`, the Performance Monitor APIs library is not initialized and the subroutine only returns information about the specified processor in its parameters, `pm_info2_t` and `pm_groups_info_t`, taking into account the filter. If the `proctype` parameter is set to `PM_CURRENT`, in addition to returning the information described, the Performance Monitor APIs library is initialized and ready to accept other calls.

Basic `pmapi` library calls

Each of the sections below describes a system-wide API call that has variations for first-party kernel thread or group counting, and third-party kernel thread or group counting. Variations are indicated by suffixes to the function call names, such as `pm_set_program`, `pm_set_program_mythread`, and `pm_set_program_group`.

pm_set_program

Sets the counting configuration. Use this call to specify the events (as a list of event identifiers, one per counter, or as a single event-group identifier) to be counted, and a mode in which to count. The list of events to choose from is returned by the **pm_init** routine. If the list includes a thresholdable event, you can also use this call to specify a threshold, and a threshold multiplier.

The mode in which to count can include user-mode and kernel-mode counting, and whether to start counting immediately. For the system-wide API call, the mode also includes whether to turn counting on only for a process and its descendants or for the whole system. For counting group API calls, the mode includes the type of counting group to create, that is, a group containing the initial thread and its future descendants, or a process-level group, which includes all the threads in a process.

pm_get_program

Retrieves the current Performance Monitor settings. This includes mode information and the list of events (or the event group) being counted. If the list includes a thresholdable event, this call also returns a threshold and the multiplier used.

pm_delete_program

Deletes the Performance Monitor configuration. Use this call to undo **pm_set_program**.

pm_start

Starts Performance Monitor counting.

pm_stop

Stops Performance Monitor counting.

pm_get_data

Returns Performance Monitor counting data. The data is a set of 64-bit values, one per hardware counter. For the counting group API calls, the group information is also returned. (See “Thread counting-group information.”)

The **pm_get_data_cpu** interface returns the Performance Monitor counting data for a single processor.

pm_get_tdata

Same as **pm_get_data**, but includes a timestamp that indicates the last time that the hardware Performance Monitoring counters were read. This is a timebase value that can be converted to time by using **time_base_to_time**.

The **pm_get_tdata_cpu** interface returns the Performance Monitor counting data for a single processor accompanied with a timestamp.

pm_reset_data

Resets Performance Monitor counting data. All values are set to 0.

Thread counting-group information

The following information is associated with each thread counting-group:

member count

The number of threads that are members of the group. This includes deceased threads that were members of the group when running.

If the consistency flag is on, the count will be the number of threads that have contributed to the group-level data.

process flag

Indicates that the group includes all the threads in the process.

consistency flag

Indicates that the group PM data is consistent with the sum of the individual PM data for the thread members.

This information is returned by the `pm_get_data_mygroup` and `pm_get_data_pgroup` interfaces in a `pm_groupinfo_t` structure.

Examples of pmapi library usage

The following examples demonstrate the use of Performance Monitor APIs in pseudo-code:

- “Simple single-threaded program example”
- “Initialization example using an event group”
- “Get information about an event group processor example” on page 122
- “Debugger program example for initialization program” on page 122
- “Simple multi-threaded example” on page 123
- “Simple thread counting-group example” on page 123
- “Thread counting example with reset” on page 124

Functional sample code is available in the `/usr/samples/pmapi` directory.

Simple single-threaded program example

```
# include <pmapi.h>
main()
{
    pm_info_t pminfo;
    pm_prog_t prog;
    pm_data_t data;
    int filter = PM_VERIFIED; /* use only verified events */

    pm_init(filter, &pminfo)

    prog.mode.w      = 0; /* start with clean mode */
    prog.mode.b.user = 1; /* count only user mode */

    for (i = 0; i < pminfo.maxpmcs; i++)
        prog.events[i] = COUNT_NOTHING;

    prog.events[0]   = 1; /* count event 1 in first counter */
    prog.events[1]   = 2; /* count event 2 in second counter */

    pm_program_mythread(&prog);
    pm_start_mythread();

(1)  ... usefull work ....

    pm_stop_mythread();
    pm_get_data_mythread(&data);

    ... print results ...
}
```

Initialization example using an event group

```
# include <pmapi.h>
main()
{
    pm_info2_t      pminfo;
    pm_prog_t       prog;
    pm_groups_info_t pmginfo;

    int filter = PM_VERIFIED; /* get list of verified events */

    pm_initialize(filter, &pminfo, &pmginfo, PM_CURRENT )

    prog.mode.w      = 0; /* start with clean mode */
    prog.mode.b.user = 1; /* count only user mode */
    prog.mode.b.is_group = 1; /* specify event group */
}
```

```

    for (i = 0; i < pminfo.maxpmcs; i++)
        prog.events[i] = COUNT_NOTHING;

    prog.events[0] = 1; /* count events in group 1 */
    .....
}

```

Get information about an event group processor example

```

#include <pmapi.h>
main()
{
    pm_events2_t *evp;

    int rc, counter, event;
    pm_info2_t    pminfo;
    pm_prog_t     prog;
    pm_groups_info_t pmginfo;
    int filter = PM_VERIFIED; /* get list of verified events */

    if ((rc = pm_initialize(filter, &pminfo, &pmginfo, PM_POWER4) != 0) {
        pm_error("pm_initialize", rc);
        exit(-1);
    }

    printf ("Group #%d: %s\n", i, pmginfo.event_groups[i].short_name);
    printf ("Group name: %s\n", pmginfo.event_groups[i].long_name);
    printf ("Group description: %s\n", pmginfo.event_groups[i].long_name);
    printf ("Group members:\n");
    for (counter = 0; counter < pminfo.maxpmcs; counter++) {

        printf("Counter %2d, ", counter+1);
        /* get the event id from the list */
        event = pmginfo.event_groups[i].events[counter];
        if ((event == COUNT_NOTHING) || (pminfo.maxevents[counter] == 0))
            printf("event %2d: No event\n", event);
        else {
            /* find pointer to the event */
            for (j = 0; j < pminfo.maxevents[counter]; j++) {
                evp = pminfo.list_events[counter]+j;
                if (event == evp->event_id) {
                    break;
                }
            }
            printf("event %2d: %s", event, evp->short_name);
            printf(" : %s\n", evp->long_name);
        }
    } /* for (counter = 0; ... */
    .....
}

```

Debugger program example for initialization program

The following example illustrates how to look at the Performance Monitor data while the program is executing:

from a debugger at breakpoint (1)

```

(2) pm_initialize(filter);
    pm_get_program_thread(pid, tid, ptid, &prog);
    ... display PM programming ...

(3) pm_get_data_thread(pid, tid, ptid);
    ... display PM data ...

    pm_delete_program_thread(pid, tid, ptid);

```

```

    prog.events[0] = 2; /* change counter 1 to count event number 2 */
    pm_set_program_pthread(pid, tid, ptid, &prog);

```

continue program

The preceding scenario would also work if the program being executed under the debugger did not have any embedded Performance Monitor API calls. The only difference would be that the calls at (2) and (3) would fail, and that when the program continues, it will be counting only event number 2 in counter 1, and nothing in other counters.

Simple multi-threaded example

The following is a simple multi-threaded example with independent threads counting the same set of events.

```

#include <pmapi.h>
pm_data_t data2;

void *
doit(void *)
{
    (1)    pm_start_mythread();

        ... usefull work ....

        pm_stop_mythread();
        pm_get_data_mythread(&data2);
}

main()
{
    pthread_t threadid;
    pthread_attr_t attr;
    pthread_addr_t status;

    ... same initialization as in previous example ...

    pm_program_mythread(&prog);

    /* setup 1:1 mode */
    pthread_attr_init(&attr);
    pthread_attr_setscope(&attr, PTHREAD_SCOPE_SYSTEM);
    pthread_create(&threadid, &attr, doit, NULL);

    (2)    pm_start_mythread();

        ... usefull work ....

        pm_stop_mythread();
        pm_get_data_mythread(&data);

        ... print main thread results (data )...

        pthread_join(threadid, &status);

        ... print auxiliary thread results (data2) ...
}

```

In the preceding example, counting starts at (1) and (2) for the main and auxiliary threads respectively because the initial counting state was off and it was inherited by the auxiliary thread from its creator.

Simple thread counting-group example

The following example has two threads in a counting-group. The body of the auxiliary thread's initialization routine is the same as in the previous example.

```

main()
{
    ... same initialization as in previous example ...

    pm_program_mygroup(&prog); /* create counting group */
(1) pm_start_mygroup()

    pthread_create(&threadid, &attr, doit, NULL)

(2) pm_start_mythread();
    ... usefull work ....

    pm_stop_mythread();
    pm_get_data_mythread(&data)

    ... print main thread results ...

    pthread_join(threadid, &status);
    ... print auxiliary thread results ...

    pm_get_data_mygroup(&data)

    ... print group results ...
}

```

In the preceding example, the call in (2) is necessary because the call in (1) only turns on counting for the group, not the individual threads in it. At the end, the group results are the sum of both threads results.

Thread counting example with reset

The following example with a reset call illustrates the impact on the group data. The body of the auxiliary thread is the same as before, except for the **pm_start_mythread** call, which is not necessary in this case.

```

main()
{
    ... same initialization as in previous example...

    prog.mode.b.count = 1; /* start counting immediately */
    pm_program_mygroup(&prog);

    pthread_create(&threadid, pthread_attr_default, doit, NULL)

    ... usefull work ....

    pm_stop_mythread()
    pm_reset_data_mythread()

    pthread_join(threadid, &status);

    ...print auxiliary thread results...

    pm_get_data_mygroup(&data)

    ...print group results...
}

```

In the preceding example, the main thread and the group counting state are both on before the auxiliary thread is created, so the auxiliary thread will inherit that state and start counting immediately.

At the end, **data1** is equal to **data** because the **pm_reset_data_mythread** automatically subtracted the main thread data from the group data to keep it consistent. In fact, the group data remains equal to the sum of the auxiliary and the main thread data, but in this case, the main thread data is null.

The hpm library and associated tools

The hpm libraries are higher-level instrumentation libraries based on the pmapi library. They support multiple instrumentation sections, nested instrumentation, and each instrumented section can be called multiple times. When nested instrumentation is used, exclusive duration is generated for the outer sections. Average and standard deviation is provided when an instrumented section is activated multiple times.

The libraries support OpenMP and threaded applications, which requires linking with the thread-safe version of the library, **libhpm_r**. Both 32-bit and 64-bit library modules are provided.

The libraries collect information and hardware Performance Monitor summarization during run-time. So, there could be considerable overhead if instrumentation sections are inserted inside inner loops.

Compiling and linking

The functionality of the **libhpm_r** library depends upon the corresponding functions in the **libpmapi** and **libm** libraries. Therefore, the **lpmapi -lm** flag must be specified when compiling applications using the hpm libraries.

By default, argument passing from Fortran applications to the hpm libraries is done by reference, or pointer, not by value. Also, there is an extra length argument following character strings. You can modify the default argument passing method by using the **%VAL** and **%REF** built-in functions.

Overhead and measurement error issues

It is expected for any software instrumentation to incur some overhead. Since it is not possible to eliminate the overhead, the goal is to minimize it. In the hpm library, most of the overhead is due to time measurement, which tends to be an expensive operation in most systems. A second source of overhead is due to run-time accumulation and storage of performance data. The hpm libraries collect information and perform summarization during run-time. Hence, there could be a considerable amount of overhead if instrumentation sections are inserted inside inner loops.

The hpm library uses hardware counters during the initialization and finalization of the library, retaining the minimum of the two for each counter as an estimate of the cost of one call to the start and stop functions. The estimated overhead is subtracted from the values obtained on each instrumented code section, which ensures that the measurement of error becomes close to zero. However, since this is a statistical approximation, in some situations where estimated overhead is larger than a measured count for the application, the approach fails. When the approach fails, you might get the following error message, which indicates that the estimated overhead was not subtracted from the measured values:

```
WARNING: Measurement error for <event name> not removed
```

You can deactivate the procedure that attempts to remove measurement errors by setting the **HPM_WITH_MEASUREMENT_ERROR** environment variable to TRUE (1).

Common hpm library rules

The following rules are common to the hpm library APIs:

- The **hpmInit()** or **f_hpmInit()** function must be called before any other function in the API.
- The initialization function can only be called once in an application.
- Performance Monitor contexts, like the event set, event group, or counter/event pairs, cannot be reprogrammed at any time.

- All functions of the API are specified as void and return no value or status.

Overview of the hpm library API calls

The following table lists the hpm library API calls:

API Call	Purpose
hpmInit or f_hpmInit	Performs initialization for a specified node ID and program name.
hpmStart or f_hpmstart	Indicates the beginning of an instrumented code segment, which is identified by an instrumentation identifier, InstID.
hpmStop or f_hpmstop	Indicates the end of an instrumented code segment. For each call to the hpmStart() or f_hpmstart() function, there should be a corresponding call to the hpmStop() or f_hpmstop() function with the matching instrumentation identifier.
hpmTstart or f_hpmtstart	Performs the same function as the hpmStart() and f_hpmstart() functions, but they are used in threaded applications.
hpmTstop or f_hpmtstop	Performs the same function as the hpmStop() and f_hpmstop() functions, but they are used in threaded applications.
hpmGetTimeAndCounters or f_hpmgettimeandcounters	Returns the time, in seconds, and the accumulated counts since the call to the hpmInit() or f_hpmInit() initialization function.
hpmGetCounters or f_hpmgetcounter	Returns all the accumulated counts since the call to the hpmInit() or f_hpmInit() initialization function.
hpmTerminate or f_hpmterminate	Performs termination and generates output. If an application exits without calling the hpmTerminate() or f_hpmterminate() function, no performance information is generated.

Threaded applications

The **T/tstart** and **T/tstop** functions respectively start and stop the counters independently on each thread. If two distinct threads use the same **instID** parameter, the output indicates multiple calls. However, the counts are accumulated.

The **instID** parameter is always a constant variable or integer. It cannot be an expression because the declarations in the **libhpm.h**, **f_hpm.h**, and **f_hpm_i8.h** header files that contain **#define** statements are evaluated during the compiler pre-processing phase, which permits the collection of line numbers and source file names.

Selecting events when using the hpm libraries and tools

The hpm libraries use the same set of hardware counters and events used by the **hpmcount** and **hpmstat** tools. The events are selected by sets. Sets are specially marked event groups for whichever derived metrics are available. For the hpm libraries, you can select the event set to be used by any of the following methods:

- The **HPM_EVENT_SET** environment variable, which is either explicitly set in the environment or specified in the **HPM_flags.env** file.
- The content of the **libHPMevents** file.

For the **hpmcount** and **hpmstat** commands, you can specify which event types you want to be monitored and the associated hardware performance counters by any of the following methods:

- Using the **-s** option
- The **HPM_EVENT_SET** environment variable, which you can set directly or define in the **HPM_flags.env** file
- The content of the **libHPM_events** file

In all cases, the **HPM_flags.env** file takes precedence over the explicit setting of the **HPM_EVENT_SET** environment variable and the content of the **libHPMevents** or **libHPM_events** file takes precedence over the **HPM_EVENT_SET** environment variable.

The libHPMevents and libHPM_events files

The libHPMevents and libHPM_events files are both supplied by the user and have the same format.

For POWER3 or PowerPC 604 RISC Microprocessor systems, the file contains the counter number and the event name, like in the following example:

```
0 PM_LD_MISS_L2HIT
1 PM_TAG_BURSTRD_L2MISS
2 PM_TAG_ST_MISS_L2
3 PM_FPU0_DENORM
4 PM_LSU_IDLE
5 PM_LQ_FULL
6 PM_FPU_FMA
7 PM_FPU_IDLE
```

For POWER4 and later systems, the file contains the event group name, like in the following example:

```
pm_hpmcount1
```

The HPM_flags.env file

The **HPM_flags.env** file contains environment variables that are used to specify the event set and for the computation of derived metrics, like in the following example:

```
HPM_L2_LATENCY 12
HPM_EVENT_SET 5
```

Output files of the hpm library

When the **hpmTerminate** function is called, a summary report is written to the **<progName>_<pid>_<taskID>.hpm** file, by default. The taskID and progName values are the first and second parameters of the **hpmlnit()** function, respectively.

You can define the name of the output file with the **HPM_OUTPUT_NAME** environment variable. The hpm libraries always add the **_<taskID>.hpm** suffix to the specified value. You can also include the date and time in the file name using the **HPM_OUTPUT_NAME** environment variable. For example, if you use the following code:

```
MYDATE=$(date +"%Y%m%d:%H%M%S")
export HPM_OUTPUT_NAME=myprogram_${MYDATE}
```

the output file for task 27 is named **myprogram_yyyymmdd:HHMMSS_0027.hpm**.

You can also generate an XML output file by setting the **HPM_VIZ_OUTPUT=TRUE** environment variable. The generated output files are named either **<progName>_<pid>_<taskID>.viz** or **HPM_OUTPUT_NAME_<taskID>.viz**.

Output files of the hpmcount command

Depending on the environment variables set and the execution environment, the following files are created when you run the **hpmcount** command:

File name

Description

file_<myID>.<pid>

The value for *file* is specified with the **-o** option and the *myID* value is assigned the value of the **MP_CHILD** environment variable, which has a default value of 0000.

HPM_LOG_DIR/hpm_log.<pid>

When the HPM_LOG_DIR environment variable is set to an existing directory, results are additionally written to the **hpm_log.<pid>** file.

HPM_LOG_DIR/hpm_log.MP_PARTITION

The MP_PARTITION environment variable is provided in POE environments. The **hpm_log.MP_PARTITION** file contains the aggregate counts.

Derived metrics and related environment variables

In relation to the hardware events that are selected to be counted and the hardware platform that is used, the output for the hpm library tools and the **hpmterminate** function includes derived metrics. You can list the globally supported metrics for a given processor with the **pmlist -D -1 [-p Processor_name]** command.

You can supply the following environment variables to specify estimations of memory, cache, and TLB miss latencies for the computation of related derived metrics:

- HPM_MEM_LATENCY
- HPM_L3_LATENCY
- HPM_L35_LATENCY,
- HPM_AVG_L3_LATENCY
- HPM_AVG_L2_LATENCY
- HPM_L2_LATENCY
- HPM_L25_LATENCY
- HPM_L275_LATENCY
- HPM_L1_LATENCY
- HPM_TLB_LATENCY

Precedence is given to variables that are defined in the **HPM_flags.env** file.

You can use the **HPM_DIV_WEIGHT** environment variable to compute the weighted flips on systems that are POWER4 and later.

Examples of the hpm tools

The examples in this section demonstrate the usage of the following hpm library commands:

- “The pmlist command”
- “The hpmcount command” on page 129
- “The hpmstat command” on page 130

The pmlist command

The following is an example of the **pmlist** command:

```
# pmlist -s

POWER5 supports 6 counters

Number of groups          : 144
Number of sets           : 8

Threshold multiplier (lower): 1
Threshold multiplier (upper): 32
Threshold multiplier (hyper): 64
Hypervisor counting mode is supported
Runlatch counting mode is supported
```

The following is another example of the **pmlist** command:

```

# pmlist -D -1 -p POWER5
Derived metrics supported:
PMD_UTI_RATE           Utilization rate
PMD_MIPS               MIPS
PMD_INST_PER_CYC      Instructions per cycle
PMD_HW_FP_PER_CYC     HW floating point instructions per Cycle
PMD_HW_FP_PER_UTIME   HW floating point instructions / user time
PMD_HW_FP_RATE        HW floating point rate
PMD_FX                Total Fixed point operations
PMD_FX_PER_CYC        Fixed point operations per Cycle
PMD_FP_LD_ST          Floating point load and store operations
PMD_INST_PER_FP_LD_ST Instructions per floating point load/store
PMD_PRC_INST_DISP_CMPL % Instructions dispatched that completed
PMD_DATA_L2           Total L2 data cache accesses
PMD_PRC_L2_ACCESS     % accesses from L2 per cycle
PMD_L2_TRAF           L2 traffic
PMD_L2_BDW            L2 bandwidth per processor
PMD_L2_LD_EST_LAT_AVG Estimated latency from loads from L2 (Average)
PMD_UTI_RATE_RC       Utilization rate (versus run cycles)
PMD_INST_PER_CYC_RC   Instructions per run cycle
PMD_LD_ST             Total load and store operations
PMD_INST_PER_LD_ST    Instructions per load/store
PMD_LD_PER_LD_MISS    Number of loads per load miss
PMD_LD_PER_DTLB       Number of loads per DTLB miss
PMD_ST_PER_ST_MISS    Number of stores per store miss
PMD_LD_PER_TLB        Number of loads per TLB miss
PMD_LD_ST_PER_TLB     Number of load/store per TLB miss
PMD_TLB_EST_LAT       Estimated latency from TLB miss
PMD_MEM_LD_TRAF       Memory load traffic
PMD_MEM_BDW           Memory bandwidth per processor
PMD_MEM_LD_EST_LAT    Estimated latency from loads from memory
PMD_LD_LMEM_PER_LD_RMEM Number of loads from local memory per loads from remote memory
PMD_PRC_MEM_LD_RC     % loads from memory per run cycle

```

The hpmcount command

The following is an example of the **hpmcount** command:

```

# hpmcount -s 1 ls
bar          foo
Execution time (wall clock time): 0.004222 seconds

##### Resource Usage Statistics #####

Total amount of time in user mode      : 0.001783 seconds
Total amount of time in system mode    : 0.000378 seconds
Maximum resident set size              : 220 Kbytes
Average shared memory use in text segment : 0 Kbytes*sec
Average unshared memory use in data segment : 0 Kbytes*sec
Number of page faults without I/O activity : 63
Number of page faults with I/O activity  : 0
Number of times process was swapped out : 0
Number of times file system performed INPUT : 0
Number of times file system performed OUTPUT : 0
Number of IPC messages sent            : 0
Number of IPC messages received         : 0
Number of signals delivered             : 0
Number of voluntary context switches    : 0
Number of involuntary context switches   : 0

##### End of Resource Statistics #####

PM_CYC (Processor cycles)      :          211939
PM_FXU_FIN (FXU produced a result) :              0
PM_CYC (Processor cycles)      :          211939
PM_FPU_FIN (FPU produced a result) :             12
PM_INST_CMPL (Instructions completed) :          55549
PM_RUN_CYC (Run cycles)         :          212012

```

Utilization rate	:	3.031 %
MIPS	:	13.157
Instructions per cycle	:	0.262
HW Float point instructions per Cycle	:	0.000
HW floating point / user time	:	0.094 M HWflop/sec
HW floating point rate (HW Flops / WCT)	:	0.003 M HWflops/sec

The hpmstat command

The following is an example of the **hpmstat** command:

```
# hpmstat -s 7
Execution time (wall clock time): 1.003946 seconds

PM_TLB_MISS (TLB misses)           :          260847
PM_CYC (Processor cycles)          :      3013964331
PM_ST_REF_L1 (L1 D cache store references) :      161377371
PM_LD_REF_L1 (L1 D cache load references)  :      255317480
PM_INST_CMPL (Instructions completed)     :      1027391919
PM_RUN_CYC (Run cycles)              :      1495147343

Utilization rate                    :          181.243 %
Total load and store operations      :          416.695 M
Instructions per load/store          :           2.466
MIPS                                 :          1023.354
Instructions per cycle               :           0.341
```

Examples of hpm library usage

The following are examples of hpm library usage:

- “A C programming language example”
- “A Fortran programming language example” on page 131
- “Multithreaded application instrumentation example” on page 131

A C programming language example

The following C program contains two instrumented sections which perform a trivial floating point operation, print the results, and then launch the command interpreter to execute the **ls -R / 2>&1 >/dev/null** command:

```
#include <sys/wait.h>
#include <unistd.h>
#include <stdio.h>
#include <libhpm.h>

void
do_work()
{
    pid_t p, wpid;
    int i, status;
    float f1 = 9.7641, f2 = 2.441, f3 = 0.0;

    f3 = f1 / f2;
    printf("f3=%f\n", f3);

    p = fork();

    if (p == -1) {
        perror("Mike fork error");
        exit(1);
    }

    if (p == 0) {
        i = execl("/usr/bin/sh", "sh", "-c", "ls -R / 2>&1 >/dev/null", 0);
        perror("Mike execl error");
        exit(2);
    }
}
```

```

    }
    else
        wpid = waitpid(p, &status, WUNTRACED | WCONTINUED);

    if (wpid == -1) {
        perror("Mike waitpid error");
        exit(3);
    }

    return;
}

main(int argc, char **argv)
{
    int taskID = 999;

    hpmInit(taskID, "my_program");
    hpmStart(1, "outer call");
    do_work();
    hpmStart(2, "inner call");
    do_work();
    hpmStop(2);
    hpmStop(1);
    hpmTerminate(taskID);
}

```

A Fortran programming language example

The following declaration is required on all source files that have instrumentation calls:

```
#include "f_hpm.h"
```

Fortran programs call functions that include the `f_` prefix, as you can see in the following example:

```

call f_hpminit( taskID, "my_program" )
call f_hpmstart( 1, "Do Loop" )
do ...
    call do_work()
    call f_hpmstart( 5, "computing meaning of life" );
    call do_more_work();
    call f_hpmstop( 5 );
end do
call f_hpmstop( 1 )
call f_hpmterminate( taskID )

```

Multithreaded application instrumentation example

When placing instrumentation inside of parallel regions, you should use a different id for each thread, as shown in the following Fortran example:

```

!$OMP PARALLEL
!$OMP&PRIVATE (instID)
    instID = 30+omp_get_thread_num()
    call f_hpmtstart( instID, "computing meaning of life" )
!$OMP DO
    do ...
        do_work()
    end do
    call f_hpmtstop( instID )
!$OMP END PARALLEL

```

The library accepts the use of the same `instID` for different threads, but the counters are accumulated for all instances with the same `instID`.

Chapter 6. Perfstat API Programming

The **perfstat** application programming interface (API) is a collection of C programming language subroutines that execute in user space and uses the **perfstat** kernel extension to extract various AIX performance metrics. System component information is also retrieved from the Object Data Manager (ODM) and returned with the performance metrics.

The **perfstat** API is both a 32-bit and a 64-bit API, is thread–safe, and does not require root authority.

The API supports extensions so binary compatibility is maintained across all releases of AIX. This is accomplished by using one of the parameters in all the API calls to specify the size of the data structure to be returned. This allows the library to easily determine which version is in use, as long as the structures are only growing, which is guaranteed. This releases the user from version dependencies. For the list of extensions made in earlier versions of AIX, see the Change History section.

The **perfstat** API subroutines reside in the **libperfstat.a** library and are part of the **bos.perf.libperfstat** fileset, which is installable from the AIX base installation media and requires that the **bos.perf.perfstat** fileset is installed. The latter contains the kernel extension and is automatically installed with AIX.

The **/usr/include/libperfstat.h** file contains the interface declarations and type definitions of the data structures to use when calling the interfaces. This **include** file is also part of the **bos.perf.libperfstat** fileset. Sample source code is provided with **bos.perf.libperfstat** and resides in the **/usr/samples/libperfstat** directory. Detailed information for the individual interfaces and the data structures used can be found in the **libperfstat.h** file in the *AIX 5L Version 5.3 Files Reference*.

API Characteristics

Two types of APIs are available. Global types return global metrics related to a set of components, while individual types return metrics related to individual components. Both types of interfaces have similar signatures, but slightly different behavior.

All the interfaces return raw data; that is, values of running counters. Multiple calls must be made at regular intervals to calculate rates.

Several interfaces return data retrieved from the ODM (object data manager) database. This information is automatically cached into a dictionary that is assumed to be "frozen" after it is loaded. The **perfstat_reset** subroutine must be called to clear the dictionary whenever the machine configuration has changed. In order to do a more selective reset, you can use the **perfstat_partial_reset** function. For more details, see the "Cached metrics interfaces" on page 157 section.

Most types returned are unsigned long long; that is, unsigned 64-bit data. This provides complete kernel independence. Some kernel internal metrics are in fact 32-bit wide in the 32-bit kernel, and 64-bit wide in the 64-bit kernel. The corresponding **libperfstat** APIs data type is always unsigned 64-bit.

All of the examples presented in this chapter can be compiled in AIX 5.3 and later using the **cc** command with **-lperfstat**.

Global Interfaces

Global interfaces report metrics related to a set of components on a system (such as processors, disks, or memory).

All of the following AIX 5.2 interfaces use the naming convention **perfstat_subsystem_total**, and use a common signature:

perfstat_cpu_total	Retrieves global CPU usage metrics
perfstat_memory_total	Retrieves global memory usage metrics
perfstat_disk_total	Retrieves global disk usage metrics
perfstat_netinterface_total	Retrieves global network interfaces metrics
perfstat_partition_total	Retrieves global partition metrics

The common signature used by all of the global interfaces is as follows:

```
int perfstat_subsystem_total(perfstat_id_t *name,
                           perfstat_subsystem_total_t *userbuff,
                           int sizeof_struct,
                           int desired_number);
```

The usage of the parameters for all of the interfaces is as follows:

perfstat_id_t *name	Reserved for future use, should be NULL
perfstat_subsystem_total_t *userbuff	A pointer to a memory area with enough space for the returned structure
int sizeof_struct	Should be set to sizeof(perfstat_subsystem_t)
int desired_number	Reserved for future use, must be set to 0 or 1

The return value will be -1 in case of errors. Otherwise, the number of structures copied is returned. This is always 1.

An exception to this scheme is: when **name=NULL**, **userbuff=NULL** and **desired_number=0**, the total number of structures available is returned. This is always 1.

The following sections provide examples of the type of data returned and code using each of the interfaces.

perfstat_cpu_total Interface

The **perfstat_cpu_total** function returns a **perfstat_cpu_total_t** structure, which is defined in the **libperfstat.h** file. Selected fields from the **perfstat_cpu_total_t** structure include:

processorHz	Processor speed in Hertz (from ODM)
description	Processor type (from ODM)
ncpus	Current number of active CPUs
ncpus_cfg	Number of configured CPUs; that is, the maximum number of processors that this copy of AIX can handle simultaneously
ncpus_high	Maximum number of active CPUs; that is, the maximum number of active processors since the last reboot
user	Total number of clock ticks spent in user mode
sys	Total number of clock ticks spent in system (kernel) mode
idle	Total number of clock ticks spent idle with no I/O pending
wait	Total number of clock ticks spent idle with I/O pending

Several other processor-related counters (such as number of system calls, number of reads, write, forks, execs, and load average) are also returned. For a complete list, see the **perfstat_cpu_total_t** section of the **libperfstat.h** header file in *AIX 5L Version 5.3 Files Reference*.

The following code shows an example of how **perfstat_cpu_total** is used:

```

#include <stdio.h>
#include <sys/time.h>
#include <libperfstat.h>

unsigned long long last_tot, last_user, last_sys, last_idle, last_wait;

int
main(int argc, char *argv[]) {
    perfstat_cpu_total_t cpu_total_buffer;
    unsigned long long cur_tot;
    unsigned long long delt_tot, delt_user, delt_sys, delt_idle, delt_wait;

    /* get initial set of data */
    perfstat_cpu_total(NULL, &cpu_total_buffer, sizeof(perfstat_cpu_total_t), 1);

    /* print general processor information */
    printf("Processors: (%d:%d) %s running at %llu MHz\n",
           cpu_total_buffer.ncpus, cpu_total_buffer.ncpus_cfg,
           cpu_total_buffer.description, cpu_total_buffer.processorHZ/1000000);

    /* save values for delta calculations */
    last_tot = cpu_total_buffer.user + cpu_total_buffer.sys +
               cpu_total_buffer.idle + cpu_total_buffer.wait;

    last_user = cpu_total_buffer.user;
    last_sys = cpu_total_buffer.sys;
    last_idle = cpu_total_buffer.idle;
    last_wait = cpu_total_buffer.wait;

    printf("\n User   Sys   Idle   Wait   Total   Rate\n");

    while(1 == 1) {
        sleep(1);

        /* get new values after one second */
        perfstat_cpu_total(NULL, &cpu_total_buffer, sizeof(perfstat_cpu_total_t), 1);

        /* calculate current total number of ticks */
        cur_tot = cpu_total_buffer.user + cpu_total_buffer.sys +
                  cpu_total_buffer.idle + cpu_total_buffer.wait;

        delt_user = cpu_total_buffer.user - last_user;
        delt_sys = cpu_total_buffer.sys - last_sys;
        delt_idle = cpu_total_buffer.idle - last_idle;
        delt_wait = cpu_total_buffer.wait - last_wait;
        delt_tot = cur_tot - last_tot;

        /* print percentages, total delta ticks and tick rate per cpu per sec */
        printf("%#5.1f %#5.1f %#5.1f %#5.1f %-5llu %llu\n",
               100.0 * (double) delt_user / (double) delt_tot,
               100.0 * (double) delt_sys / (double) delt_tot,
               100.0 * (double) delt_idle / (double) delt_tot,
               100.0 * (double) delt_wait / (double) delt_tot,
               delt_tot, delt_tot/cpu_total_buffer.ncpus);

        /* save current value for next time */
        last_tot = cur_tot;
        last_user = cpu_total_buffer.user;
        last_sys = cpu_total_buffer.sys;
        last_idle = cpu_total_buffer.idle;
        last_wait = cpu_total_buffer.wait;
    }
}

```

The preceding program produces (on a single PowerPc 604e microprocessor-based machine) output similar to the following:

Processors: (1:1) PowerPC_604e running at 375 MHz

User	Sys	Idle	Wait	Total	Rate
19.0	31.0	1.0	49.0	100	100
20.8	34.7	0.0	44.6	101	101
35.0	30.0	0.0	35.0	100	100
12.0	20.0	0.0	68.0	100	100
19.0	33.0	0.0	48.0	100	100
29.0	43.0	11.0	17.0	100	100
23.0	30.0	25.0	22.0	100	100
24.0	25.0	15.0	36.0	100	100
26.0	27.0	25.0	22.0	100	100
20.0	32.0	37.0	11.0	100	100
16.0	22.0	49.0	13.0	100	100
16.0	33.0	18.0	33.0	100	100

perfstat_memory_total Interface

The `perfstat_memory_total` function returns a `perfstat_memory_total_t` structure, which is defined in the `libperfstat.h` file. Selected fields from the `perfstat_memory_total_t` structure include:

virt_total	Amount of virtual memory (in units of 4 KB pages)
real_total	Amount of real memory (in units of 4 KB pages)
real_free	Amount of free real memory (in units of 4 KB pages)
real_pinned	Amount of pinned memory (in units of 4 KB pages)
pgins	Number of pages paged in
pgouts	Number of pages paged out
pgsp_total	Total amount of paging space (in units of 4 KB pages)
pgsp_free	Amount of free paging space (in units of 4 KB pages)
pgsp_rsvd	Amount of reserved paging space (in units of 4 KB pages)

Several other memory-related metrics (such as amount of paging space paged in and out, and amount of system memory) are also returned. For a complete list, see the `perfstat_memory_total_t` section of the `libperfstat.h` header file in *AIX 5L Version 5.3 Files Reference*.

The following code shows an example of how `perfstat_memory_total` is used:

```
#include <stdio.h>
#include <libperfstat.h>

int main(int argc, char* argv[]) {
    perfstat_memory_total_t minfo;

    perfstat_memory_total(NULL, &minfo, sizeof(perfstat_memory_total_t), 1);

    printf("Memory statistics\n");
    printf("-----\n");
    printf("real memory size           : %llu MB\n",
           minfo.real_total*4096/1024/1024);
    printf("reserved paging space      : %llu MB\n",minfo.pgsp_rsvd);
    printf("virtual memory size        : %llu MB\n",
           minfo.virt_total*4096/1024/1024);
    printf("number of free pages       : %llu\n",minfo.real_free);
    printf("number of pinned pages     : %llu\n",minfo.real_pinned);
    printf("number of pages in file cache : %llu\n",minfo.numperm);
    printf("total paging space pages   : %llu\n",minfo.pgsp_total);
    printf("free paging space pages    : %llu\n", minfo.pgsp_free);
    printf("used paging space          : %3.2f%\n",
```



```

        (float)(minfo.pgsp_total-minfo.pgsp_free)*100.0/
        (float)minfo.pgsp_total);
    printf("number of paging space page ins : %llu\n",minfo.pgspins);
    printf("number of paging space page outs : %llu\n",minfo.pgspouts);
    printf("number of page ins : %llu\n",minfo.pgins);
    printf("number of page outs : %llu\n",minfo.pgouts);
}

```

The preceding program produces output similar to the following:

```

Memory statistics
-----
real memory size           : 256 MB
reserved paging space     : 512 MB
virtual memory size       : 768 MB
number of free pages      : 32304
number of pinned pages    : 6546
number of pages in file cache : 12881
total paging space pages  : 131072
free paging space pages   : 129932
used paging space         : 0.87%
number of paging space page ins : 0
number of paging space page outs : 0
number of page ins       : 20574
number of page outs      : 92508

```

perfstat_disk_total Interface

The `perfstat_disk_total` function returns a `perfstat_disk_total_t` structure, which is defined in the `libperfstat.h` file. Selected fields from the `perfstat_disk_total_t` structure include:

number	Number of disks
size	Total disk size (in MB)
free	Total free disk space (in MB)
xfers	Total transfers to and from disk (in KB)

Several other disk-related metrics, such as number of blocks read from and written to disk, are also returned. For a complete list, see the `perfstat_disk_total_t` section in the `libperfstat.h` header file in *AIX 5L Version 5.3 Files Reference*.

The following code shows an example of how `perfstat_disk_total` is used:

```

#include <stdio.h>
#include <libperfstat.h>

int main(int argc, char* argv[]) {
    perfstat_disk_total_t dinfo;

    perfstat_disk_total(NULL, &dinfo, sizeof(perfstat_disk_total_t), 1);

    printf("Total disk statistics\n");
    printf("-----\n");
    printf("number of disks      : %d\n",    dinfo.number);
    printf("total disk space    : %llu\n",  dinfo.size);
    printf("total free space     : %llu\n",  dinfo.free);
    printf("number of transfers  : %llu\n",  dinfo.xfers);
    printf("number of blocks written : %llu\n", dinfo.wblks);
    printf("number of blocks read  : %llu\n", dinfo.rblks);
}

```

This program produces output similar to the following:

```

Total disk statistics
-----
number of disks      : 3
total disk space    : 4296
total free space    : 2912
number of transfers  : 77759
number of blocks written : 738016
number of blocks read  : 363120

```

perfstat_netinterface_total Interface

The `perfstat_netinterface_total` function returns a `perfstat_netinterface_total_t` structure, which is defined in the `libperfstat.h` file. Selected fields from the `perfstat_netinterface_total_t` structure include:

number	Number of network interfaces
ipackets	Total number of input packets received on all network interfaces
opackets	Total number of output packets sent on all network interfaces
ierror	Total number of input errors on all network interfaces
oerror	Total number of output errors on all network interfaces

Several other network interface related metrics (such as number of bytes sent and received). For a complete list, see the `perfstat_netinterface_total_t` section in the `libperfstat.h` header file in *AIX 5L Version 5.3 Files Reference*.

The following code shows an example of how `perfstat_netinterface_total` is used:

```

#include <stdio.h>
#include <libperfstat.h>

int main(int argc, char* argv[]) {
    perfstat_netinterface_total_t ninfo;

    perfstat_netinterface_total(NULL, &ninfo, sizeof(perfstat_netinterface_total_t), 1);

    printf("Network interfaces statistics\n");
    printf("-----\n");
    printf("number of interfaces : %d\n", ninfo.number);
    printf("\ninput statistics:\n");
    printf("number of packets   : %llu\n", ninfo.ipackets);
    printf("number of errors    : %llu\n", ninfo.ierrors);
    printf("number of bytes     : %llu\n", ninfo.ibytes);
    printf("\noutput statistics:\n");
    printf("number of packets   : %llu\n", ninfo.opackets);
    printf("number of bytes     : %llu\n", ninfo.obytes);
    printf("number of errors    : %llu\n", ninfo.oerrors);
}

```

The program above produces output similar to this:

```

Network interfaces statistics
-----
number of interfaces : 2

input statistics:
number of packets   : 306688
number of errors    : 0
number of bytes     : 24852688

output statistics:
number of packets   : 63005
number of bytes     : 11518591
number of errors    : 0

```

perfstat_partition_total Interface

The `perfstat_partition_total` function returns a `perfstat_partition_total_t` structure, which is defined in the `libperfstat.h` file. Selected fields from the `perfstat_partition_total_t` structure include:

type	Partition type
online_cpus	Number of virtual CPUs currently allocated to the partition
online_memory	Amount of memory currently allocated to the partition

For a complete list, see the `perfstat_partition_total_t` section in the `libperfstat.h` header file in *AIX 5L Version 5.3 Files Reference*.

The following code shows examples of how to use the `perfstat_partition_total` function.

The first example demonstrates how to emulate the `lpartstat -i` command:

```
#include <stdio.h>
#include <stdlib.h>
#include <libperfstat.h>

int main(int argc, char* argv[])
{
    perfstat_partition_total_t pinfo;
    int rc;

    rc = perfstat_partition_total(NULL, &pinfo, sizeof(perfstat_partition_total_t), 1);
    if (rc != 1) {
        perror("Error in perfstat_partition_total");
        exit(-1);
    }
    printf("Partition Name           : %s\n", pinfo.name);
    printf("Partition Number          : %u\n", pinfo.lpar_id);
    printf("Type                       : %s\n", pinfo.type.b.shared_enabled ? "Shared" : "Dedicated");
    printf("Mode                       : %s\n", pinfo.type.b.capped ? "Capped" : "Uncapped");
    printf("Entitled Capacity          : %u\n", pinfo.entitled_proc_capacity);
    printf("Partition Group-ID         : %u\n", pinfo.group_id);
    printf("Shared Pool ID             : %u\n", pinfo.pool_id);
    printf("Online Virtual CPUs        : %u\n", pinfo.online_cpus);
    printf("Maximum Virtual CPUs       : %u\n", pinfo.max_cpus);
    printf("Minimum Virtual CPUs       : %u\n", pinfo.min_cpus);
    printf("Online Memory               : %llu MB\n", pinfo.online_memory);
    printf("Maximum Memory             : %llu MB\n", pinfo.max_memory);
    printf("Minimum Memory             : %llu MB\n", pinfo.min_memory);
    printf("Variable Capacity Weight   : %u\n", pinfo.var_proc_capacity_weight);
    printf("Minimum Capacity          : %u\n", pinfo.min_proc_capacity);
    printf("Maximum Capacity          : %u\n", pinfo.max_proc_capacity);
    printf("Capacity Increment        : %u\n", pinfo.proc_capacity_increment);
    printf("Maximum Physical CPUs in system: %u\n", pinfo.max_phys_cpus_sys);
    printf("Active Physical CPUs in system : %u\n", pinfo.online_phys_cpus_sys);
    printf("Active CPUs in Pool        : %u\n", pinfo.phys_cpus_pool);
    printf("Unallocated Capacity      : %u\n", pinfo.unalloc_proc_capacity);
    printf("Physical CPU Percentage    : %4.2f%%\n",
        (double)pinfo.entitled_proc_capacity / (double)pinfo.online_cpus);
    printf("Unallocated Weight        : %u\n", pinfo.unalloc_var_proc_capacity_weight);
}
```

The program above produces output similar to the following:

```
Partition Name           : aixlpar
Partition Number          : 21
Type                       : Dedicated
Mode                       : Uncapped
Entitled Capacity          : 35
Partition Group-ID         : 43
Shared Pool ID             : 93
```

```

Online Virtual CPUs      : 8
Maximum Virtual CPUs    : 12
Minimum Virtual CPUs     : 6
Online Memory           : 256 MB
Maximum Memory          : 512 MB
Minimum Memory          : 123 MB
Variable Capacity Weight : 5
Minimum Capacity        : 1.5
Maximum Capacity        : 3.5
Capacity Increment      : 83
Maximum Physical CPUs in system: 11
Active Physical CPUs in system : 8
Physical CPUs in Pool   : 9
Unallocated Capacity    : 4.5
Physical CPU Percentage  : 84.34
Unallocated Weight      : 6

```

The second example demonstrates how to emulate the **lparstat** command in default mode:

```

#include <stdio.h>
#include <stdlib.h>
#include <unistd.h>
#include <libperfstat.h>
#include <sys/systemcfg.h>

#define XINTFRAC ((double)(_system_configuration.Xint)/((double)(_system_configuration.Xfrac))
#define HTIC2SEC(x) ((double)x * XINTFRAC)/((double)1000000000.0)

static int disp_util_header = 1;
static u_longlong_t last_time_base;
static u_longlong_t last_pcpu_user, last_pcpu_sys, last_pcpu_idle, last_pcpu_wait;
static u_longlong_t last_lcpu_user, last_lcpu_sys, last_lcpu_idle, last_lcpu_wait;
static u_longlong_t last_phint = 0, last_vcsw = 0, last_pit = 0;

void display_lpar_util(void);

int main(int argc, char* argv[])
{
    while (1) {
        display_lpar_util();
        sleep(atoi(argv[1]));
    }
    return(0);
}

/* Save the current values for the next iteration */
void save_last_values(perfstat_cpu_total_t *cpustats, perfstat_partition_total_t *lparstats)
{
    last_vcsw      = lparstats->vol_virt_cswitch + lparstats->invol_virt_cswitch;
    last_time_base = lparstats->timebase_last;
    last_phint     = lparstats->phantintrs;
    last_pit       = lparstats->pool_idle_time;

    last_pcpu_user = lparstats->puser;
    last_pcpu_sys  = lparstats->psys;
    last_pcpu_idle = lparstats->pidle;
    last_pcpu_wait = lparstats->pwait;

    last_lcpu_user = cpustats->user;
    last_lcpu_sys  = cpustats->sys;
    last_lcpu_idle = cpustats->idle;
    last_lcpu_wait = cpustats->wait;
}

/* Gather and display lpar utilization metrics */
void display_lpar_util()

```

```

{
    u_longlong_t dlt_pcpu_user, dlt_pcpu_sys, dlt_pcpu_idle, dlt_pcpu_wait;
    u_longlong_t dlt_lcpu_user, dlt_lcpu_sys, dlt_lcpu_idle, dlt_lcpu_wait;
    u_longlong_t vcsw, lcpu_time, pcpu_time;
    u_longlong_t entitled_purr, unused_purr;
    u_longlong_t delta_purr, delta_time_base;
    double phys_proc_consumed, entitlement, percent_ent, delta_sec;
    perfstat_partition_total_t lparstats;
    perfstat_cpu_total_t cpustats;

    /* retrieve the metrics */
    if (!perfstat_partition_total(NULL, &lparstats, sizeof(perfstat_partition_total_t), 1)) {
        perror("perfstat_partition_total");
        exit(-1);
    }

    if (!perfstat_cpu_total(NULL, &cpustats, sizeof(perfstat_cpu_total_t), 1)) {
        perror("perfstat_cpu_total");
        exit(-1);
    }

    /* Print the header for utilization metrics (only once) */
    if (disp_util_header) {
        if (lparstats.type.b.shared_enabled) {
            if (lparstats.type.b.pool_util_authority) {
                fprintf(stdout, "\n%5s %5s %6s %6s %5s %5s %5s %5s %4s %5s",
                    "%user", "%sys", "%wait", "%idle", "physc", "%entc", "lbusy", "app", "vcsw", "phint");

                fprintf(stdout, "\n%5s %5s %6s %6s %5s %5s %5s %5s %4s %5s",
                    "-----", "-----", "-----", "-----", "-----", "-----", "-----", "-----", "-----");
            } else {
                fprintf(stdout, "\n%5s %5s %6s %6s %5s %5s %5s %4s %5s",
                    "%user", "%sys", "%wait", "%idle", "physc", "%entc", "lbusy", "vcsw", "phint");

                fprintf(stdout, "\n%5s %5s %6s %6s %5s %5s %5s %4s %5s",
                    "-----", "-----", "-----", "-----", "-----", "-----", "-----", "-----", "-----");
            }
        } else {
            fprintf(stdout, "\n%5s %5s %6s %6s", "%user", "%sys", "%wait", "%idle");
            fprintf(stdout, "\n%5s %5s %6s %6s", "-----", "-----", "-----", "-----");
        }
        fprintf(stdout, "\n");
        disp_util_header = 0;

        /* first iteration, we only read the data, print the header and save the data */
        save_last_values(&cpustats, &lparstats);
        return;
    }

    dlt_pcpu_user = lparstats.puser - last_pcpu_user;
    dlt_pcpu_sys = lparstats.psys - last_pcpu_sys;
    dlt_pcpu_idle = lparstats.pidle - last_pcpu_idle;
    dlt_pcpu_wait = lparstats.pwait - last_pcpu_wait;

    delta_purr = pcpu_time - last_pcpu_time;

    dlt_lcpu_user = cpustats.user - last_lcpu_user;
    dlt_lcpu_sys = cpustats.sys - last_lcpu_sys;
    dlt_lcpu_idle = cpustats.idle - last_lcpu_idle;
    dlt_lcpu_wait = cpustats.wait - last_lcpu_wait;

    lcpu_time = dlt_lcpu_user + dlt_lcpu_sys + dlt_lcpu_idle + dlt_lcpu_wait;

    entitlement = (double)lparstats.entitled_proc_capacity / 100.0 ;

    delta_time_base = lparstats.timebase_last - last_time_base;
}

```

```

if (lparstats.type.b.shared_enabled) {
    entitled_purr = delta_time_base * entitlement;
    if (entitled_purr < delta_purr) {
        /* when above entitlement, use consumption in percentages */
        entitled_purr = delta_purr;
    }
    unused_purr = entitled_purr - delta_purr;

    /* distributed unused purr in wait and idle proportionally to logical wait and idle */
    dlt_pcpu_wait += unused_purr * ((double)dlt_lcpu_wait / (double)(dlt_lcpu_wait + dlt_lcpu_idle));
    dlt_pcpu_idle += unused_purr * ((double)dlt_lcpu_idle / (double)(dlt_lcpu_wait + dlt_lcpu_idle));

    pcpu_time = entitled_purr;
}

/* Physical Processor Utilization */
printf("%5.1f ", (double)dlt_pcpu_user * 100.0 / (double)pcpu_time);
printf("%5.1f ", (double)dlt_pcpu_sys * 100.0 / (double)pcpu_time);
printf("%6.1f ", (double)dlt_pcpu_wait * 100.0 / (double)pcpu_time);
printf("%6.1f ", (double)dlt_pcpu_idle * 100.0 / (double)pcpu_time);

if (lparstats.type.b.shared_enabled) {
    /* Physical Processor Consumed */
    phys_proc_consumed = (double)delta_purr / (double)delta_time_base;
    printf("%5.2f ", (double)phys_proc_consumed);

    /* Percentage of Entitlement Consumed */
    percent_ent = (double)((phys_proc_consumed / entitlement) * 100);
    printf("%5.1f ", percent_ent);

    /* Logical Processor Utilization */
    printf("%5.1f ", (double)(dlt_lcpu_user+dlt_lcpu_sys) * 100.0 / (double)lcpu_time);

    if (lparstats.type.b.pool_util_authority) {
        /* Available Pool Processor (app) */
        printf("%5.2f ", (double)(lparstats.pool_idle_time - last_pit) /
            XINTFRAC*(double)delta_time_base);
    }

    /* Virtual CPU Context Switches per second */
    vcs_w = lparstats.vol_virt_cswitch + lparstats.invol_virt_cswitch;
    delta_sec = HTIC2SEC(delta_time_base);
    printf("%4.0f ", (double)(vcs_w - last_vcs_w) / delta_sec);

    /* Phantom Interrupts per second */
    printf("%5.0f", (double)(lparstats.phantintrs - last_phintr) / delta_sec);
}
printf("\n");

save_last_values(&cpustats, &lparstats);
}

```

If the program above runs in dedicated mode, the program produces output similar to the following:

```

%user  %sys  %wait  %idle
-----
0.0    0.0    0.0    100.0
0.5    0.5    0.0    99.0
0.0    0.5    0.0    99.5
0.0    0.5    0.0    99.5
0.0    0.0    0.0    100.0
0.0    1.0    0.0    99.0
0.5    0.0    0.0    99.5

```

If the program above runs in shared mode, the program produces output similar to the following:

%user	%sys	%wait	%idle	physc	%entc	lbusy	app	vcsw	pint
50.00	5.00	5.00	30.00	2.5	30.00	65.00	1.1	25	10
50.00	5.00	5.00	30.00	2.5	30.00	65.00	1.1	25	10
50.00	5.00	5.00	30.00	2.5	30.00	65.00	1.1	25	10
50.00	5.00	5.00	30.00	2.5	30.00	65.00	1.1	25	10
50.00	5.00	5.00	30.00	2.5	30.00	65.00	1.1	25	10

Component-Specific Interfaces

Component-specific interfaces report metrics related to individual components on a system (such as a processor, disk, network interface, or paging space).

All of the following AIX interfaces use the naming convention **perfstat_subsystem**, and use a common signature:

perfstat_cpu	Retrieves individual CPU usage metrics
perfstat_disk	Retrieves individual disk usage metrics
perfstat_diskpath	Retrieves individual disk path metrics
perfstat_diskadapter	Retrieves individual disk adapter metrics
perfstat_netinterface	Retrieves individual network interfaces metrics
perfstat_protocol	Retrieves individual network protocol related metrics
perfstat_netbuffer	Retrieves individual network buffer allocation metrics
perfstat_paging space	Retrieves individual paging space metrics

The common signature used by all the component interfaces is as follows:

```
int perfstat_subsystem(perfstat_id *name,
                      perfstat_subsystem_t * userbuff,
                      int sizeof_struct,
                      int desired_number);
```

The usage of the parameters for all of the interfaces is as follows:

perfstat_id_t *name	The name of the first component (for example hdisk2 for perfstat_disk()) for which statistics are desired. A structure containing a char * field is used instead of directly passing a char * argument to the function to avoid allocation errors and to prevent the user from giving a constant string as parameter. To start from the first component of a subsystem, set the char* field of the name parameter to "" (empty string). You can also use the macros such as FIRST_SUBSYSTEM (for example, FIRST_CPU) defined in the libperfstat.h file.
perfstat_subsystem_total_t *userbuff	A pointer to a memory area with enough space for the returned structure(s).
int sizeof_struct	Should be set to sizeof(perfstat_subsystem_t) .
int desired_number	The number of structures of type perfstat_subsystem_t to return in userbuff.

The return value will be -1 in case of error. Otherwise, the number of structures copied is returned. The field name is either set to NULL or to the name of the next structure available.

An exception to this scheme is when **name=NULL**, **userbuff=NULL** and **desired_number=0**, the total number of structures available is returned.

To retrieve all structures of a given type, either ask first for their number, allocate enough memory to hold them all at once, then call the appropriate API to retrieve them all in one call. Otherwise, allocate a fixed set of structures and repeatedly call the API to get the next such number of structures, each time passing

the name returned by the previous call. Start the process with the name set to "" or **FIRST_SUBSYSTEM**, and repeat the process until the name returned is equal to "".

Minimizing the number of API calls, and therefore the number of system calls, will always lead to more efficient code, so the two-call approach should be preferred. Some of the examples shown in the following sections illustrate the API usage using the two-call approach. Because the two-call approach can lead to a lot of memory being allocated, the multiple-call approach must sometimes be used and is illustrated in the following examples.

The following sections provide examples of the type of data returned and code using each of the interfaces.

perfstat_cpu interface

The **perfstat_cpu** function returns a set of structures of type **perfstat_cpu_t**, which is defined in the **libperfstat.h** file. Selected fields from the **perfstat_cpu_t** structure include:

name	Logical CPU name (cpu0, cpu1, ...)
user	Number of clock ticks spent in user mode
sys	Number of clock ticks spent in system (kernel) mode
idle	Number of clock ticks spent idle with no I/O pending
wait	Number of clock ticks spent idle with I/O pending
syscall	Number of system call executed

Several other CPU related metrics (such as number of forks, read, write, and execs) are also returned. For a complete list, see the **perfstat_cpu_t** section in the **libperfstat.h** header file in *AIX 5L Version 5.3 Files Reference*.

The following code shows an example of how **perfstat_cpu** is used:

```
#include <stdio.h>
#include <stdlib.h>
#include <libperfstat.h>

int main(int argc, char *argv[]) {
    int i, retcode, cputotal;
    perfstat_id_t firstcpu;
    perfstat_cpu_t *statp;

    /* check how many perfstat_cpu_t structures are available */
    cputotal = perfstat_cpu(NULL, NULL, sizeof(perfstat_cpu_t), 0);

    printf("number of perfstat_cpu_t available : %d\n", cputotal);

    /* allocate enough memory for all the structures */
    statp = calloc(cputotal, sizeof(perfstat_cpu_t));

    /* set name to first cpu */
    strcpy(firstcpu.name, FIRST_CPU);

    /* ask to get all the structures available in one call */
    retcode = perfstat_cpu(&firstcpu, statp, sizeof(perfstat_cpu_t), cputotal);

    /* return code is number of structures returned */
    printf("number of perfstat_cpu_t returned : %d\n", retcode);

    for (i = 0; i < retcode; i++) {
        printf("\nStatistics for CPU : %s\n", statp[i].name);
        printf("-----\n");
        printf("CPU user time (raw ticks) : %llu\n", statp[i].user);
        printf("CPU sys time (raw ticks) : %llu\n", statp[i].sys);
    }
}
```



```

printf("CPU idle time (raw ticks) : %llu\n", statp[i].idle);
printf("CPU wait time (raw ticks) : %llu\n", statp[i].wait);
printf("number of syscalls      : %llu\n", statp[i].syscall);
printf("number of readings     : %llu\n", statp[i].sysread);
printf("number of writings     : %llu\n", statp[i].syswrite);
printf("number of forks        : %llu\n", statp[i].sysfork);
printf("number of execs        : %llu\n", statp[i].sysexec);
printf("number of char read    : %llu\n", statp[i].readch);
printf("number of char written  : %llu\n", statp[i].writech);
}
}

```

On a single processor machine, the preceding program produces output similar to the following:

```

number of perfstat_cpu_t available : 1
number of perfstat_cpu_t returned  : 1

```

Statistics for CPU : cpu0

```

-----
CPU user time (raw ticks) : 1336297
CPU sys time (raw ticks) : 111958
CPU idle time (raw ticks) : 57069585
CPU wait time (raw ticks) : 19545
number of syscalls      : 4734311
number of readings     : 562121
number of writings     : 323367
number of forks        : 6839
number of execs        : 7257
number of char read    : 753568874
number of char written  : 132494990

```

In an environment where dynamic logical partitioning is used, the number of **perfstat_cpu_t** structures available will always be equal to the **ncpus_high** field in the **perfstat_cpu_total_t**. This number represents the highest index of any active processor since the last reboot. Kernel data structures holding performance metrics for processors are not deallocated when processors are turned offline or moved to a different partition. They simply stop being updated. The **ncpus** field of the **perfstat_cpu_total_t** structure always represents the number of active processors, but the **perfstat_cpu** interface will always return **ncpus_high** structures.

Applications can detect offline or moved processors by checking clock-tick increments. If the sum of the user, sys, idle and wait fields is identical for a given processor between two **perfstat_cpu** calls, that processor has been offline for the complete interval. If the sum multiplied by 10 ms (the value of a clock tick) does not match the time interval, the processor has not been online for the complete interval.

perfstat_disk Interface

The **perfstat_disk** function returns a set of structures of type **perfstat_disk_t**, which is defined in the **libperfstat.h** file. Selected fields from the **perfstat_disk_t** structure include:

name	Disk name (from ODM)
description	Disk description (from ODM)
vgname	Volume group name (from ODM)
size	Disk size (in MB)
free	Free space (in MB)
xfers	Transfers to/from disk (in KB)

Several other disk related metrics (such as number of blocks read from and written to disk, and adapter names) are also returned. For a complete list, see the **perfstat_disk_t** section in the **libperfstat.h** header file in *AIX 5L Version 5.3 Files Reference*.

The following code shows an example of how `perfstat_disk` is used:

```
#include <stdio.h>
#include <stdlib.h>
#include <libperfstat.h>

int main(int argc, char* argv[]) {
    int i, ret, tot;
    perfstat_disk_t *statp;
    perfstat_id_t first;

    /* check how many perfstat_disk_t structures are available */
    tot = perfstat_disk(NULL, NULL, sizeof(perfstat_disk_t), 0);

    /* allocate enough memory for all the structures */
    statp = calloc(tot, sizeof(perfstat_disk_t));

    /* set name to first interface */
    strcpy(first.name, FIRST_DISK);

    /* ask to get all the structures available in one call */
    /* return code is number of structures returned */
    ret = perfstat_disk(&first, statp,
                       sizeof(perfstat_disk_t), tot);

    /* print statistics for each of the disks */
    for (i = 0; i < ret; i++) {
        printf("\nStatistics for disk : %s\n", statp[i].name);
        printf("-----\n");
        printf("description           : %s\n", statp[i].description);
        printf("volume group name       : %s\n", statp[i].vgname);
        printf("adapter name            : %s\n", statp[i].adapter);
        printf("size                     : %llu MB\n", statp[i].size);
        printf("free space               : %llu MB\n", statp[i].free);
        printf("number of blocks read   : %llu blocks of %llu bytes\n", statp[i].rblks, statp[i].bsize);
        printf("number of blocks written : %llu blocks of %llu bytes\n", statp[i].wblks, statp[i].bsize);
    }
}
```

The preceding program produces output similar to the following:

```
Statistics for disk : hdisk1
-----
description           : 16 Bit SCSI Disk Drive
volume group name     : rootvg
adapter name          : scsi0
size                  : 4296 MB
free space            : 2912 MB
number of blocks read : 403946 blocks of 512 bytes
number of blocks written : 768176 blocks of 512 bytes

Statistics for disk : hdisk0
-----
description           : 16 Bit SCSI Disk Drive
volume group name     : None
adapter name          : scsi0
size                  : 0 MB
free space            : 0 MB
number of blocks read : 0 blocks of 512 bytes
number of blocks written : 0 blocks of 512 bytes

Statistics for disk : cd0
-----
description           : SCSI Multimedia CD-ROM Drive
volume group name     : not available
```

```

adapter name      : scsi0
size              : 0 MB
free space        : 0 MB
number of blocks read  : 3128 blocks of 2048 bytes
number of blocks written : 0 blocks of 2048 bytes

```

perfstat_diskpath Interface

The **perfstat_diskpath** function returns a set of structures of type **perfstat_diskpath_t**, which is defined in the **libperfstat.h** file. Selected fields from the **perfstat_diskadapter_t** structure include:

```

name           Path name (<disk_name>_Path<path_id>)
xfers         Total transfers via this path (in KB)
adapter       Name of the adapter linked to the path

```

Several other disk path-related metrics (such as the number of blocks read from and written via the path) are also returned. For a complete list, see the **perfstat_diskpath_t** section in the **libperfstat.h** header file in *AIX 5L Version 5.3 Files Reference*.

The following code shows an example of how **perfstat_diskpath** is used:

```

#include <stdio.h>
#include <stdlib.h>
#include <libperfstat.h>

int main(int argc, char* argv[]) {
    int i, ret, tot;
    perfstat_diskpath_t *statp;
    perfstat_disk_t dstat;
    perfstat_id_t first;
    char *substring;

    /* check how many perfstat_diskpath_t structures are available */
    tot = perfstat_diskpath(NULL, NULL, sizeof(perfstat_diskadapter_t), 0);

    /* allocate enough memory for all the structures */
    statp = calloc(tot, sizeof(perfstat_diskpath_t));

    /* set name to first interface */
    strcpy(first.name, FIRST_DISKPATH);

    /* ask to get all the structures available in one call */
    /* return code is number of structures returned */
    ret = perfstat_diskpath(&first, statp, sizeof(perfstat_diskpath_t), tot);

    /* print statistics for each of the disk paths */
    for (i = 0; i < ret; i++) {
        printf("\nStatistics for disk path : %s\n", statp[i].name);
        printf("-----\n");
        printf("number of blocks read      : %llu\n", statp[i].rblks);
        printf("number of blocks written   : %llu\n", statp[i].wblks);
        printf("adapter name                : %s\n", statp[i].adapter);
    }

    /* retrieve paths for last disk if any */
    if (ret > 0) {
        /* extract the disk name from the last disk path name */
        substring = strstr(statp[ret - 1].name, "_Path");
        if (substring == NULL) {
            return (-1);
        }
        substring[0] = '\0';

        /* set name to the disk name */

```

```

strcpy(first.name, statp[ret-1]);

/* retrieve info about disk */
ret = perfstat_disk(&first, &dstat, sizeof(perfstat_disk_t),1);
printf("\nPaths for disk path : %s (%d)\n", dstat.name, dstat.paths_count);
printf("-----\n");

/* retrieve all paths for this disk */
ret = perfstat_diskpath(&first, statp, sizeof(perfstat_diskpath_t), dstat.paths_count);

/* print statistics for each of the paths */
for (i = 0; i < ret; i++) {
    printf("\nStatistics for disk path : %s\n", statp[i].name);
    printf("-----\n");
    printf("number of blocks read      : %llu\n", statp[i].rblks);
    printf("number of blocks written   : %llu\n", statp[i].wblks);
    printf("adapter name                : %s\n", statp[i].adapter);
}
}

```

The preceding program produces output similar to the following:

```

Statistics for disk path : hdisk1_Path0
-----
number of blocks read      : 253612
number of blocks written   : 537132
adapter name              : scsi0

Statistics for disk path : hdisk2_Path0
-----
number of blocks read      : 0
number of blocks written   : 0
adapter name              : scsi0

Statistics for disk path : hdisk2_Path1
-----
number of blocks read      : 26457
number of blocks written   : 43658
adapter name              : scsi2

Paths for disk : hdisk2 (2)
=====

Statistics for disk path : hdisk2_Path0
-----
number of blocks read      : 0
number of blocks written   : 0
adapter name              : scsi0

Statistics for disk path : hdisk2_Path1
-----
number of blocks read      : 26457
number of blocks written   : 43658
adapter name              : scsi2

```

perfstat_diskadapter Interface

The **perfstat_diskadapter** function returns a set of structures of type **perfstat_diskadapter_t**, which is defined in the **libperfstat.h** file. Selected fields from the **perfstat_diskadapter_t** structure include:

name Adapter name (from ODM)

description	Adapter description (from ODM)
size	Total disk size connected to this adapter (in MB)
free	Total free space on disks connected to this adapter (in MB)
xfers	Total transfers to/from this adapter (in KB)

Several other disk adapter related metrics (such as the number of blocks read from and written to the adapter) are also returned. For a complete list, see the **perfstat_diskadapter_t** section in the **libperfstat.h** header file in *AIX 5L Version 5.3 Files Reference*.

The following code shows an example of how **perfstat_diskadapter** is used:

```
#include <stdio.h>
#include <stdlib.h>
#include <libperfstat.h>

int main(int argc, char* argv[]) {
    int i, ret, tot;
    perfstat_diskadapter_t *statp;
    perfstat_id_t first;

    /* check how many perfstat_diskadapter_t structures are available */
    tot = perfstat_diskadapter(NULL, NULL, sizeof(perfstat_diskadapter_t), 0);

    /* allocate enough memory for all the structures */
    statp = calloc(tot, sizeof(perfstat_diskadapter_t));

    /* set name to first interface */
    strcpy(first.name, FIRST_DISK);

    /* ask to get all the structures available in one call */
    /* return code is number of structures returned */
    ret = perfstat_diskadapter(&first, statp, sizeof(perfstat_diskadapter_t), tot);

    /* print statistics for each of the disk adapters */
    for (i = 0; i < ret; i++) {
        printf("\nStatistics for adapter : %s\n", statp[i].name);
        printf("-----\n");
        printf("description          : %s\n", statp[i].description);
        printf("number of disks connected : %d\n", statp[i].number);
        printf("total disk size         : %llu MB\n", statp[i].size);
        printf("total disk free space   : %llu MB\n", statp[i].free);
        printf("number of blocks read   : %llu\n", statp[i].rblks);
        printf("number of blocks written : %llu\n", statp[i].wblks);
    }
}
}
```

The preceding program produces output similar to the following:

```
Statistics for adapter : scsi0
-----
description          : Wide/Fast-20 SCSI I/O Controller
number of disks connected : 3
total disk size         : 4296 MB
total disk free space   : 2912 MB
number of blocks read   : 411284
number of blocks written : 768256
```

perfstat_netinterface Interface

The **perfstat_netinterface** function returns a set of structures of type **perfstat_netinterface_t**, which is defined in the **libperfstat.h** file. Selected fields from the **perfstat_netinterface_t** structure include:

name	Interface name (from ODM)
description	Interface description (from ODM)
ipackets	Total number of input packets received on this network interface
opackets	Total number of output packets sent on this network interface
ierror	Total number of input errors on this network interface
oerror	Total number of output errors on this network interface

Several other network interface related metrics (such as number of bytes sent and received, type, and bitrate) are also returned. For a complete list, see the **perfstat_netinterface_t** section in the **libperfstat.h** header file in *AIX 5L Version 5.3 Files Reference*.

The following code shows an example of how **perfstat_netinterface** is used:

```
#include <stdio.h>
#include <stdlib.h>
#include <libperfstat.h>
#include <net/if_types.h>

char *
decode(uchar type) {
    switch(type) {
        case IFT_LOOP:
            return("loopback");

        case IFT_IS088025:
            return("token-ring");

        case IFT_ETHER:
            return("ethernet");
    }

    return("other");
}

int main(int argc, char* argv[]) {
    int i, ret, tot;
    perfstat_netinterface_t *statp;
    perfstat_id_t first;

    /* check how many perfstat_netinterface_t structures are available */
    tot = perfstat_netinterface(NULL, NULL, sizeof(perfstat_netinterface_t), 0);

    /* allocate enough memory for all the structures */
    statp = calloc(tot, sizeof(perfstat_netinterface_t));

    /* set name to first interface */
    strcpy(first.name, FIRST_NETINTERFACE);

    /* ask to get all the structures available in one call */
    /* return code is number of structures returned */
    ret = perfstat_netinterface(&first, statp, sizeof(perfstat_netinterface_t), tot);

    /* print statistics for each of the interfaces */
    for (i = 0; i < ret; i++) {
        printf("\nStatistics for interface : %s\n", statp[i].name);
        printf("-----\n");
        printf("type : %s\n", decode(statp[i].type));
        printf("\ninput statistics:\n");
        printf("number of packets : %llu\n", statp[i].ipackets);
        printf("number of errors : %llu\n", statp[i].ierrors);
        printf("number of bytes : %llu\n", statp[i].ibytes);
        printf("\noutput statistics:\n");
    }
}
```

```

        printf("number of packets : %llu\n", statp[i].opackets);
        printf("number of bytes   : %llu\n", statp[i].obytes);
        printf("number of errors  : %llu\n", statp[i].oerrors);
    }
}

```

The preceding program produces output similar to the following:

```
Statistics for interface : tr0
```

```
-----
```

```
type : token-ring
```

```
input statistics:
```

```
number of packets : 306352
```

```
number of errors  : 0
```

```
number of bytes   : 24831776
```

```
output statistics:
```

```
number of packets : 62669
```

```
number of bytes   : 11497679
```

```
number of errors  : 0
```

```
Statistics for interface : lo0
```

```
-----
```

```
type : loopback
```

```
input statistics:
```

```
number of packets : 336
```

```
number of errors  : 0
```

```
number of bytes   : 20912
```

```
output statistics:
```

```
number of packets : 336
```

```
number of bytes   : 20912
```

```
number of errors  : 0
```

perfstat_protocol Interface

The **perfstat_protocol** function returns a set of structures of type **perfstat_protocol_t**, which consists of a set of unions to accommodate the different sets of fields needed for each protocol, as defined in the **libperfstat.h** file. Selected fields from the **perfstat_protocol_t** structure include:

name protocol name: **ip**, **ip6**, **icmp**, **icmp6**, **udp**, **tcp**, **rpc**, **nfs**, **nfsv2** or **nfsv3**.

ipackets Number of input packets received using this protocol. This field exists only for protocols **ip**, **ip6**, **udp**, and **tcp**.

opackets Number of output packets sent using this protocol. This field exists only for protocols **ip**, **ip6**, **udp**, and **tcp**.

received Number of packets received using this protocol. This field exists only for protocols **icmp** and **icmp6**.

calls Number of calls made to this protocol. This field exists only for protocols **rpc**, **nfs**, **nfsv2**, and **nfsv3**.

Many other network protocol related metrics are also returned. The complete set of metrics printed by **nfsstat** is returned for instance. For a complete list, see the **perfstat_protocol_t** section in the **libperfstat.h** header file in *AIX 5L Version 5.3 Files Reference*.

The following code shows an example of how **perfstat_protocol** is used:

```

#include <stdio.h>
#include <string.h>
#include <libperfstat.h>

int main(int argc, char* argv[]) {
    int ret, tot, retrieved = 0;
    perfstat_protocol_t pinfo;

```

```

perfstat_id_t protid;

/* check how many perfstat_protocol_t structures are available */
tot = perfstat_protocol(NULL, NULL, sizeof(perfstat_protocol_t), 0);

printf("number of protocol usage structures available : %d\n", tot);

/* set name to first protocol */
strcpy(protid.name, FIRST_PROTOCOL);

/* retrieve first protocol usage information */
ret = perfstat_protocol(&protid, &pinfo, sizeof(perfstat_protocol_t), 1);
retrieved += ret;

do {
    printf("\nStatistics for protocol : %s\n", pinfo.name);
    printf("-----\n");

    if (!strcmp(pinfo.name,"ip")) {
        printf("number of input packets : %llu\n", pinfo.ip.ipackets);
        printf("number of input errors : %llu\n", pinfo.ip.ierrors);
        printf("number of output packets : %llu\n", pinfo.ip.opackets);
        printf("number of output errors : %llu\n", pinfo.ip.oerrors);
    } else if (!strcmp(pinfo.name,"ipv6")) {
        printf("number of input packets : %llu\n", pinfo.ipv6.ipackets);
        printf("number of input errors : %llu\n", pinfo.ipv6.ierrors);
        printf("number of output packets : %llu\n", pinfo.ipv6.opackets);
        printf("number of output errors : %llu\n", pinfo.ipv6.oerrors);
    } else if (!strcmp(pinfo.name,"icmp")) {
        printf("number of packets received : %llu\n", pinfo.icmp.received);
        printf("number of packets sent : %llu\n", pinfo.icmp.sent);
        printf("number of errors : %llu\n", pinfo.icmp.errors);
    } else if (!strcmp(pinfo.name,"icmpv6")) {
        printf("number of packets received : %llu\n", pinfo.icmpv6.received);
        printf("number of packets sent : %llu\n", pinfo.icmpv6.sent);
        printf("number of errors : %llu\n", pinfo.icmpv6.errors);
    } else if (!strcmp(pinfo.name,"udp")) {
        printf("number of input packets : %llu\n", pinfo.udp.ipackets);
        printf("number of input errors : %llu\n", pinfo.udp.ierrors);
        printf("number of output packets : %llu\n", pinfo.udp.opackets);
    } else if (!strcmp(pinfo.name,"tcp")) {
        printf("number of input packets : %llu\n", pinfo.tcp.ipackets);
        printf("number of input errors : %llu\n", pinfo.tcp.ierrors);
        printf("number of output packets : %llu\n", pinfo.tcp.opackets);
    } else if (!strcmp(pinfo.name,"rpc")) {
        printf("client statistics:\n");
        printf("number of connection-oriented RPC requests : %llu\n",
            pinfo.rpc.client.stream.calls);
        printf("number of rejected connection-oriented RPCs : %llu\n",
            pinfo.rpc.client.stream.badcalls);
        printf("number of connectionless RPC requests : %llu\n",
            pinfo.rpc.client.dgram.calls);
        printf("number of rejected connectionless RPCs : %llu\n",
            pinfo.rpc.client.dgram.badcalls);
        printf("\nserver statistics:\n");
        printf("number of connection-oriented RPC requests : %llu\n",
            pinfo.rpc.server.stream.calls);
        printf("number of rejected connection-oriented RPCs : %llu\n",
            pinfo.rpc.server.stream.badcalls);
        printf("number of connectionless RPC requests : %llu\n",
            pinfo.rpc.server.dgram.calls);
        printf("number of rejected connectionless RPCs : %llu\n",
            pinfo.rpc.server.dgram.badcalls);
    } else if (!strcmp(pinfo.name,"nfs")) {
        printf("total number of NFS client requests : %llu\n",
            pinfo.nfs.client.calls);
        printf("total number of NFS client failed calls : %llu\n",

```



```

        pinfo.nfs.client.badcalls);
    printf("total number of NFS server requests      : %llu\n",
        pinfo.nfs.server.calls);
    printf("total number of NFS server failed calls   : %llu\n",
        pinfo.nfs.server.badcalls);
    printf("total number of NFS version 2 server calls : %llu\n",
        pinfo.nfs.server.public_v2);
    printf("total number of NFS version 3 server calls : %llu\n",
        pinfo.nfs.server.public_v3);
} else if (!strcmp(pinfo.name,"nfsv2")) {
    printf("number of NFS V2 client requests : %llu\n",
        pinfo.nfsv2.client.calls);
    printf("number of NFS V2 server requests : %llu\n",
        pinfo.nfsv2.server.calls);
} else if (!strcmp(pinfo.name,"nfsv3")) {
    printf("number of NFS V3 client requests : %llu\n",
        pinfo.nfsv3.client.calls);
    printf("number of NFS V3 server requests : %llu\n",
        pinfo.nfsv3.server.calls);
}

/* make sure we stop after the last protocol */
if (ret = strcmp(protid.name, "")) {
    printf("\nnext protocol name : %s\n", protid.name);

    /* retrieve information for next protocol */
    ret = perfstat_protocol(&protid, &pinfo, sizeof(perfstat_protocol_t), 1);
    retrieved += ret;
}
} while (ret == 1);

printf("\nnumber of protocol usage structures retrieved : %d\n", retrieved);
}

```

The preceding program produces output similar to the following:

```
number of protocol usage structures available : 10
```

```
Statistics for protocol : ip
```

```
-----
number of input packets : 142839
number of input errors  : 54665
number of output packets : 63974
number of output errors : 55878
```

```
next protocol name : ipv6
```

```
Statistics for protocol : ipv6
```

```
-----
number of input packets : 0
number of input errors  : 0
number of output packets : 0
number of output errors : 0
```

```
next protocol name : icmp
```

```
Statistics for protocol : icmp
```

```
-----
number of packets received : 35
number of packets sent    : 1217
number of errors          : 0
```

```
next protocol name : icmpv6
```

```
Statistics for protocol : icmpv6
```

```
-----
number of packets received : 0
```

```

number of packets sent      : 0
number of errors           : 0

next protocol name : udp

Statistics for protocol : udp
-----
number of input packets   : 4316
number of input errors    : 0
number of output packets  : 308

next protocol name : tcp

Statistics for protocol : tcp
-----
number of input packets   : 82604
number of input errors    : 0
number of output packets  : 62250

next protocol name : rpc

Statistics for protocol : rpc
-----
client statistics:
number of connection-oriented RPC requests : 375
number of rejected connection-oriented RPCs : 0
number of connectionless RPC requests      : 20
number of rejected connectionless RPCs     : 0

server statistics:
number of connection-oriented RPC requests : 32
number of rejected connection-oriented RPCs : 0
number of connectionless RPC requests      : 0
number of rejected connectionless RPCs     : 0

next protocol name : nfs

Statistics for protocol : nfs
-----
total number of NFS client requests      : 375
total number of NFS client failed calls  : 0
total number of NFS server requests      : 32
total number of NFS server failed calls   : 0
total number of NFS version 2 server calls : 0
total number of NFS version 3 server calls : 0

next protocol name : nfsv2

Statistics for protocol : nfsv2
-----
number of NFS V2 client requests : 0
number of NFS V2 server requests : 0

next protocol name : nfsv3

Statistics for protocol : nfsv3
-----
number of NFS V3 client requests : 375
number of NFS V3 server requests : 32

number of protocol usage structures retrieved : 10

```

perfstat_netbuffer Interface

The `perfstat_netbuffer` function returns a set of structures of type `perfstat_netbuffer_t`, which is defined in the `libperfstat.h` file. Selected fields from the `perfstat_netbuffer_t` structure include:

size Size of the allocation (string expressing size in bytes)
inuse Current allocation of this size
failed Failed allocation of this size
free Free list for this size

Several other allocation related metrics (such as high-water mark and freed) are also returned. For a complete list, see the **perfstat_netbuffer_t** section in the **libperfstat.h** header file in *AIX 5L Version 5.3 Files Reference*.

The following code shows an example of how **perfstat_netbuffer** is used:

```
#include <stdio.h>
#include <stdlib.h>
#include <libperfstat.h>

int main(int argc, char* argv[]) {
    int i, ret, tot;
    perfstat_netbuffer_t *statp;
    perfstat_id_t first;

    /* check how many perfstat_netbuffer_t structures are available */
    tot = perfstat_netbuffer(NULL, NULL, sizeof(perfstat_netbuffer_t), 0);

    /* allocate enough memory for all the structures */
    statp = calloc(tot, sizeof(perfstat_netbuffer_t));

    /* set name to first interface */
    strcpy(first.name, FIRST_NETBUFFER);

    /* ask to get all the structures available in one call */
    /* return code is number of structures returned */
    ret = perfstat_netbuffer(&first, statp,
        sizeof(perfstat_netbuffer_t), tot);

    /* print info in netstat -m format */
    printf("%-12s %10s %9s %6s %9s %7s %7s %7s\n",
        "By size", "inuse", "calls", "failed",
        "delayed", "free", "hiwat", "freed");
    for (i = 0; i < ret; i++) {
        printf("%-12s %10llu %9llu %6llu %9llu %7llu %7llu %7llu\n",
            statp[i].name,
            statp[i].inuse,
            statp[i].calls,
            statp[i].delayed,
            statp[i].free,
            statp[i].failed,
            statp[i].highwatermark,
            statp[i].freed);
    }
}
```

The preceding program produces output similar to the following:

By size	inuse	calls	failed	delayed	free	hiwat	freed
32	199	4798	0	57	0	826	0
64	96	8121	0	32	0	413	0
128	110	50156	0	146	0	206	2
256	279	20313587	0	361	0	496	0
512	156	5298	0	12	0	51	0
1024	38	1038	0	6	0	129	0
2048	1	6946	0	129	0	129	1024
4096	67	276102	0	132	0	155	0

8192	4	123	0	4	0	12	0
16384	1	1	0	15	0	31	0
65536	1	1	0	0	0	512	0

perfstat_pagingspace Interface

The **perfstat_pagingspace** function returns a set of structures of type **perfstat_pagingspace_t**, which is defined in the **libperfstat.h** file. Selected fields from the **perfstat_pagingspace_t** structure include:

mb_size	Size of the paging space in MB
lp_size	Size of the paging space in logical partitions
mb_used	Portion of the paging space used in MB

Several other paging space related metrics (such as name, type, and active) are also returned. For a complete list, see the **perfstat_pagingspace_t** section in the **libperfstat.h** header file in *AIX 5L Version 5.3 Files Reference*.

The following code shows an example of how **perfstat_pagingspace** is used:

```
#include <stdio.h>
#include <stdlib.h>
#include <libperfstat.h>

int main(int argc, char agrv[]) {
    int i, ret, tot;
    perfstat_id_t first;
    perfstat_pagingspace_t *pinfo;

    tot = perfstat_pagingspace(NULL, NULL, sizeof(perfstat_pagingspace_t), 0);

    pinfo = calloc(tot, sizeof(perfstat_pagingspace_t));

    strcpy(first.name, FIRST_PAGINGSPACE);

    ret = perfstat_pagingspace(&first, pinfo, sizeof(perfstat_pagingspace_t), tot);
    for (i = 0; i < ret; i++) {
        printf("\nStatistics for paging space : %s\n", pinfo[i].name);
        printf("-----\n");
        printf("type           : %s\n",
            pinfo[i].type == LV_PAGING ? "logical volume" : "NFS file");
        if (pinfo[i].type == LV_PAGING) {
            printf("volume group : %s\n", pinfo[i].lv_paging.vgname);
        }
        else {
            printf("hostname   : %s\n", pinfo[i].nfs_paging.hostname);
            printf("filename   : %s\n", pinfo[i].nfs_paging.filename);
        }
        printf("size (in LP) : %llu\n", pinfo[i].lp_size);
        printf("size (in MB) : %llu\n", pinfo[i].mb_size);
        printf("used (in MB) : %llu\n", pinfo[i].mb_used);
    }
}
```

The preceding program produces output similar to the following:

```
Statistics for paging space : hd6
-----
type           : logical volume
volume group   : rootvg
size (in LP)   : 64
size (in MB)   : 512
used (in MB)   : 4
```

Cached metrics interfaces

Cached metrics interfaces are used when the system configuration changes to inform the **libperfstat** API that it should reset cached metrics, which consist of values that seldom change such as disk size or CPU description.

The following table lists the metrics that are cached:

Object	Content	Sample value
perfstat_cpu_total	char cpu_description [IDENTIFIER_LENGTH] u_longlong_t processorHZ	PowerPC_POWER3 375000000
perfstat_diskadapter	The list of disk adapters The number of disk adapters u_longlong_t size u_longlong_t free char description [IDENTIFIER_LENGTH]	scsi0, scsi1, ide0 3 17344 15296 Wide/Ultra-3 SCSI I/O Controller
perfstat_pagingspace	The list of paging spaces The number of paging spaces char automatic char type longlong_t lpsize longlong_t mbsize char hostname [IDENTIFIER_LENGTH] char filename [IDENTIFIER_LENGTH]	hd6 1 1 NFS_PAGING 16 512 pompei or rootvg /var/tmp/nfsswap/swapfile1
perfstat_disk	char adapter [IDENTIFIER_LENGTH] char description [IDENTIFIER_LENGTH] char vgname [IDENTIFIER_LENGTH] u_longlong_t size u_longlong_t free	scsi0 16 Bit LVD SCSI Disk Drive rootvg 17344 15296
perfstat_diskpath	char adapter [IDENTIFIER_LENGTH]	scsi0
perfstat_netinterface	char description [IDENTIFIER_LENGTH]	Standard Ethernet Network Interface

You can use the following AIX interfaces to refresh the cached metrics:

Interface	Purpose	Definition of interface
perfstat_reset	Resets every cached metric	void perfstat_reset (void);
perfstat_partial_reset	Resets selected cached metrics or resets the system's minimum and maximum counters for disks	void perfstat_partial_reset (char * name, u_longlong_t resetmask);

The usage of the parameters for all of the interfaces is as follows:

Parameter	Usage
char *name	Identifies the name of the component of the cached metric that should be reset from the libperfstat API cache. If the value of the parameter is NULL, this signifies all of the components.

Parameter	Usage
u_longlong_t resetmask	<p>Identifies the category of the component if the value of the name parameter is not NULL. The possible values are:</p> <ul style="list-style-type: none"> • FLUSH_CPUTOTAL • FLUSH_DISK • RESET_DISK_MINMAX • FLUSH_DISKADAPTER • FLUSH_DISKPATH • FLUSH_NETINTERFACE • FLUSH_PAGINGSPEACE <p>If the value of the name parameter is NULL, the resetmask parameter value consists of a combination of values. For example: RESET_DISK_MINMAX FLUSH_CPUTOTAL FLUSH_DISK</p>

The perfstat_reset interface

The **perfstat_reset** interface resets every cached metric that is stored by the **libperfstat** API. It also resets the system's minimum and maximum counters related to disks and paths. To be more selective, it is advised to use the **perfstat_partial_reset** interface.

The perfstat_partial_reset interface

The **perfstat_partial_reset** interface resets the specified cached metrics that are stored by the **libperfstat** API. The **perfstat_partial_reset** interface can also reset the system's minimum and maximum counters related to disks and paths. The following table summarizes the various actions of the **perfstat_partial_reset** interface:

The resetmask value	Action taken when the value of name is NULL	Action taken when the value of name is not NULL and a single resetmask value is set
FLUSH_CPUTOTAL	Flushes the speed and description values in the perfstat_cputotal_t structure.	Error. The value of errno is set to EINVAL.
FLUSH_DISK	Flushes the description, adapter, size, free, and vname values in every perfstat_disk_t structure. Flushes the list of disk adapters. Flushes the size, free, and description values in every perfstat_diskadapter_t structure.	Flushes the description, adapter, size, free, and vname values in the specified perfstat_disk_t structure. Flushes the adapter value in every perfstat_diskpath_t structure that matches the disk name that is followed by the _Path identifier. Flushes the size, free, and description values of each perfstat_diskadapter_t structure that is linked to a path leading to the disk or to the disk itself.
RESET_DISK_MINMAX	Resets the following values in every perfstat_diskadapter_t structure: <ul style="list-style-type: none"> • wq_min_time • wq_max_time • min_rserv • max_rserv • min_wserv • max_wserv 	Error. The value of errno is set to ENOTSUP.

The resetmask value	Action taken when the value of name is NULL	Action taken when the value of name is not NULL and a single resetmask value is set
FLUSH_DISKADAPTER	Flushes the list of disk adapters. Flushes the size, free, and description values in every perfstat_diskadapter_t structure. Flushes the adapter value in every perfstat_diskpath_t structure. Flushes the description and adapter values in every perfstat_disk_t structure.	Flushes the list of disk adapters. Flushes the size, free, and description values in every perfstat_diskadapter_t structure. Flushes the adapter value in every perfstat_diskpath_t structure. Flushes the description and adapter values in every perfstat_disk_t structure.
FLUSH_DISKPATH	Flushes the adapter value in every perfstat_diskpath_t structure.	Flushes the adapter value in the specified perfstat_diskpath_t structure.
FLUSH_PAGINGSAPCE	Flushes the list of paging spaces. Flushes the automatic, type, lpsize, mbsize, hostname, filename, and vname values in every perfstat_pagingspace_t structure.	Flushes the list of paging spaces. Flushes the automatic, type, lpsize, mbsize, hostname, filename, and vname values in the specified perfstat_pagingspace_t structure.
FLUSH_NETINTERFACE	Flushes the description value in every perfstat_netinterface_t structure.	Flushes the description value in the specified perfstat_netinterface_t structure.

You can see how to use the **perfstat_partial_reset** interface in the following example code:

```
#include <stdio.h>
#include <stdlib.h>
#include <libperfstat.h>

int main(int argc, char *argv[]) {
    int i, retcode;
    perfstat_id_t diskname;
    perfstat_disk_t *statp;

    /* set name of the disk */
    strcpy(diskname.name, "hdisk0");

    /* we will now reset global system min/max metrics
     * Be careful as this could interact with other programs.
     */
    perfstat_partial_reset(NULL, RESET_DISK_MINMAX);

    /* min/max values are now reset.
     * We can now wait for some time before checking the variation range.
     */
    sleep(60);

    /* get disk metrics - min/max counters illustrate variations during the
     * last 60 seconds unless someone else reset these
     * values in the meantime.
     */
    retcode = perfstat_disk(&diskname, statp, sizeof(perfstat_disk_t), 1);

    /* At this point, we assume the disk free part changes due to chfs for example */

    /* if we get disk metrics here, the free field will be wrong as it was
     * cached by the libperfstat.
     */

    /* That is why we reset cached metrics */
    perfstat_partial_reset("hdisk0", FLUSH_DISK);
}
```

```

/* we can now get updated disk metrics */
retcode = perfstat_disk(&diskname, statp, sizeof(perfstat_disk_t), 1);
}

```

Change History of the perfstat API

The following changes and additions have been made to the perfstat APIs:

Interface Changes

Beginning with the following filesets:

- **bos.perf.libperfstat 4.3.3.4**
- **bos.perf.libperfstat 5.1.0.50**
- **bos.perf.libperfstat 5.2.0.10**

the **rblks** and **wblks** fields of **libperfstat** are represented by blocks of 512 bytes in the **perfstat_disk_total_t**, **perfstat_diskadapter_t** and **perfstat_diskpath_t** structures, regardless of the actual block size used by the device for which metrics are being retrieved.

Interface Additions

The following interfaces were added in the **bos.perf.libperfstat 5.2.0** fileset :

- **perfstat_netbuffer**
- **perfstat_protocol**
- **perfstat_pagingspace**
- **perfstat_diskadapter**
- **perfstat_reset**

The **perfstat_diskpath** interface was added in the **bos.perf.libperfstat 5.2.0.10** fileset.

The **perfstat_partition_total** interface was added in the **bos.perf.libperfstat 5.3.0.0** fileset.

The **perfstat_partial_reset** interface was added in the **bos.perf.libperfstat 5.3.0.10** fileset.

Field Additions

The following additions have been made to the specified fileset levels:

The **bos.perf.libperfstat 5.1.0.15** fileset

The following fields were added to **perfstat_cpu_total_t**:

```

u_longlong_t bread
u_longlong_t bwrite
u_longlong_t lread
u_longlong_t lwrite
u_longlong_t phread
u_longlong_t phwrite

```

Support for C++ was added in this fileset level.

Note that the version of **libperfstat** for AIX 4.3 is synchronized with this level. No binary or source compatibility is provided between the 4.3.3.4 version and any 5.1 version prior to 5.1.0.15.

The **bos.perf.libperfstat 5.1.0.25** fileset

The following fields were added to **perfstat_cpu_t**:

```
u_longlong_t bread
u_longlong_t bwrite
u_longlong_t lread
u_longlong_t lwrite
u_longlong_t phread
u_longlong_t phwrite
```

The **bos.perf.libperfstat 5.2.0** fileset

The following fields were added to **perfstat_cpu_t**:

```
u_longlong_t iget
u_longlong_t namei
u_longlong_t dirblk
u_longlong_t msg
u_longlong_t sema
```

The **name** field which returns the logical processor name is now of the form *cpu0*, *cpu1*, ... instead of *proc0*, *proc1*, ... as it was in previous releases.

The following fields were added to **perfstat_cpu_total_t**:

```
u_longlong_t runocc
u_longlong_t swpocc
u_longlong_t iget
u_longlong_t namei
u_longlong_t dirblk
u_longlong_t msg
u_longlong_t sema
u_longlong_t rcvint
u_longlong_t xmtint
u_longlong_t mdmint
u_longlong_t tty_rawinch
u_longlong_t tty_caninch
u_longlong_t tty_rawoutch
u_longlong_t ksched
u_longlong_t koverf
u_longlong_t kexit
u_longlong_t rbread
u_longlong_t rcread
u_longlong_t rbwrt
u_longlong_t rcwrt
u_longlong_t traps
int ncpus_high
```

The following field was added to **perfstat_disk_t**:

```
char adapter[IDENTIFIER_LENGTH]
```

The following field was added to **perfstat_netinterface_t**:

```
u_longlong_t bitrate
```

The following fields were added to **perfstat_memory_total_t**:

```
u_longlong_t real_system
u_longlong_t real_user
u_longlong_t real_process
```

The following defines were added to **libperfstat.h**:

```
#define FIRST_CPU          ""
#define FIRST_DISK        ""
#define FIRST_DISKADAPTER ""
#define FIRST_NETINTERFACE ""
```

```
#define FIRST_PAGINGSPACE ""
#define FIRST_PROTOCOL ""
#define FIRST_ALLOC ""
```

The **bos.perf.libperfstat 5.2.0.10** fileset

The following field was added to the **perfstat_disk_t** interface:

```
uint paths_count
```

The following define was added to **libperfstat.h**:

```
#define FIRST_DISKPATH ""
```

The **bos.perf.libperfstat 5.3.0.0** fileset

The following fields were added to the **perfstat_cpu_t** interface:

```
u_longlong_t puser
u_longlong_t psyss
u_longlong_t pidle
u_longlong_t pwait
u_longlong_t redisp_sd0
u_longlong_t redisp_sd1
u_longlong_t redisp_sd2
u_longlong_t redisp_sd3
u_longlong_t redisp_sd4
u_longlong_t redisp_sd5
u_longlong_t migration_push
u_longlong_t migration_S3grq
u_longlong_t migration_S3pul
u_longlong_t invol_cswitch
u_longlong_t vol_cswitch
u_longlong_t runque
u_longlong_t bound
u_longlong_t decrintrs
u_longlong_t mpcrintrs
u_longlong_t mpcsintrs
u_longlong_t devintrs
u_longlong_t softintrs
u_longlong_t phantintrs
```

The following fields were added to the **perfstat_cpu_total_t** interface:

```
u_longlong_t puser
u_longlong_t psys
u_longlong_t pidle
u_longlong_t pwait
u_longlong_t decrintrs
u_longlong_t mpcrintrs
u_longlong_t mpcsintrs
u_longlong_t phantintrs
```

The **bos.perf.libperfstat 5.3.0.10** fileset

The following fields were added to both the **perfstat_disk_t** and **perfstat_diskpath_t** interfaces:

```
u_longlong_t q_full
u_longlong_t rserv
u_longlong_t rtimeout
u_longlong_t rfailed
u_longlong_t min_rserv
u_longlong_t max_rserv
u_longlong_t wserv
u_longlong_t wtimeout
u_longlong_t wfailed
u_longlong_t min_wserv
u_longlong_t max_wserv
u_longlong_t wq_depth
u_longlong_t wq_sampled
```

```
u_longlong_t wq_time
u_longlong_t wq_min_time
u_longlong_t wq_max_time
u_longlong_t q_sampled
```

In addition, the `xrate` field in the following data structures has been renamed to `_rxfers` and contains the number of read transactions when used with selected device drivers or zero:

```
perfstat_disk_t
perfstat_disk_total_t
perfstat_diskadapter_t
perfstat_diskpath_t
```

The following definitions were added to the **libperfstat.h** header file:

```
#define FLUSH_CPU TOTAL
#define FLUSH_DISK
#define RESET_DISK_MINMAX
#define FLUSH_DISKADAPTER
#define FLUSH_DISKPATH
#define FLUSH_PAGINGSPACE
#define FLUSH_NETINTERFACE
```

Related Information

The `libperfstat.h` file.

Chapter 7. Kernel Tuning

Beginning with AIX 5.2, you can make permanent kernel-tuning changes without having to edit any **rc** files. This is achieved by centralizing the reboot values for all tunable parameters in the **/etc/tunables/nextboot** stanza file. When a system is rebooted, the values in the **/etc/tunables/nextboot** file are automatically applied.

The following commands are used to manipulate the **nextboot** file and other files containing a set of tunable parameter values:

- The **tunchange** command is used to change values in a stanza file.
- The **tunsave** command is used to save values to a stanza file.
- The **tunrestore** is used to apply a file; that is, to change all tunables parameter values to those listed in a file.
- The **tuncheck** command must be used to validate a file created manually.
- The **tundefault** is available to reset tunable parameters to their default values.

The preceding commands work on both current and reboot values.

All five tuning commands (**no**, **nfso**, **vmo**, **ioo**, and **schedo**) use a common syntax and are available to directly manipulate the tunable parameter values. Available options include making permanent changes and displaying detailed help on each of the parameters that the command manages.

SMIT panels and Web-based System Manager plug-ins are also available to manipulate current and reboot values for all tuning parameters, as well as the files in the **/etc/tunables** directory.

The following topics are covered in this chapter:

- “Migration and Compatibility”
- “Tunables File Directory” on page 166
- “Tunable Parameters Type” on page 167
- “Common Syntax for Tuning Commands” on page 167
- “Tunable File-Manipulation Commands” on page 169
- “Initial setup” on page 172
- “Reboot Tuning Procedure” on page 173
- “Recovery Procedure” on page 173
- “Kernel Tuning Using the SMIT Interface” on page 173
- “Kernel Tuning using the Performance Plug-In for Web-based System Manager” on page 179
- “Files” on page 189
- “Related Information” on page 189

Migration and Compatibility

When machines are migrated to AIX 5.2 from a previous release of AIX, the tuning commands are automatically set to run in compatibility mode. Most of the information in this section does not apply to compatibility mode. For more information, see Performance tuning enhancements for AIX 5.2 in the *AIX 5L Version 5.3 Performance Management Guide*.

When a machine is initially installed with AIX 5.2, it is automatically set to run in AIX 5.2 tuning mode, which is described in this chapter. The tuning mode is controlled by the **sys0** attribute called **pre520tune**, which can be set to enable to run in compatibility mode and disable to run in AIX 5.2 mode.

To retrieve the current setting of the **pre520tune** attribute, run the following command:

```
lsattr -E -l sys0
```

To change the current setting of the **pre520tune** attribute, run the following command:

```
chdev -l sys0 -a pre520tune=enable
```

OR

use SMIT or Web-based System Manager.

Tunables File Directory

Information about tunable parameter values is located in the **/etc/tunables** directory. Except for a log file created during each reboot, this directory only contains ASCII stanza files with sets of tunable parameters. These files contain **parameter=value** pairs specifying tunable parameter changes, classified in five stanzas corresponding to the five tuning commands : **schedo**, **vmo**, **ioo**, **no**, and **nfso**. Additional information about the level of AIX, when the file was created, and a user-provided description of file usage is stored in a special stanza in the file. For detailed information on the file's format, see the **tunables** file.

The main file in the tunables directory is called **nextboot**. It contains all the tunable parameter values to be applied at the next reboot. The **lastboot** file in the tunables directory contains all the tunable values that were set at the last machine reboot, a *timestamp* for the last reboot, and *checksum* information about the matching **lastboot.log** file, which is used to log any changes made, or any error messages encountered, during the last rebooting. The **lastboot** and **lastboot.log** files are set to be read-only and are owned by the root user, as are the directory and all of the other files.

Users can create as many **/etc/tunables** files as needed, but only the **nextboot** file is ever automatically applied. Manually created files must be validated using the **tuncheck** command. Parameters and stanzas can be missing from a file. Only tunable parameters present in the file will be changed when the file is applied with the **tunrestore** command. Missing tunables will simply be left at their current or default values. To force resetting of a tunable to its default value with **tunrestore** (presumably to force other tunables to known values, otherwise **tundefault**, which sets all parameters to their default value, could have been used), **DEFAULT** can be specified. Specifying **DEFAULT** for a tunable in the **nextboot** file is the same as not having it listed in the file at all because the reboot tuning procedure enforces default values for missing parameters. This will guarantee to have all tunables parameters set to the values specified in the **nextboot** file after each reboot.

Tunable files can have a special stanza named **info** containing the parameters **AIX_level**, **Kernel_type** and **Last_validation**. Those parameters are automatically set to the level of AIX and to the type of kernel (UP, MP, or MP64) running when the **tuncheck** or **tunsave** is run on the file. Both commands automatically update those fields. However, the **tuncheck** command will only update if no error was detected.

The **lastboot** file always contains values for every tunable parameters. Tunables set to their default value will be marked with the comment **DEFAULT VALUE**. The **Logfile_checksum** parameter only exists in that file and is set by the tuning reboot process (which also sets the rest of the info stanza) after closing the log file.

Tunable files can be created and modified using one of the following options:

- Using SMIT or Web-based System Manager, to modify the next reboot value for tunable parameters, or to ask to save all current values for next boot, or to ask to use an existing tunable file at the next reboot. All those actions will update the **/etc/tunables/nextboot** file. A new file in the **/etc/tunables** directory can also be created to save all current or all **nextboot** values.
- Using the tuning commands (**ioo**, **vmo**, **schedo**, **no** or **nfso**) with the **-p** or **-r** options, which will update the **/etc/tunables/nexboot** file.

- A new file can also be created directly with an editor or copied from another machine. Running **tuncheck [-r | -p] -f** must then be done on that file.
- Using the **tunsave** command to create or overwrite files in the **/etc/tunables** directory
- Using the **tunrestore -r** command to update the **nextboot** file.

Tunable Parameters Type

All the tunable parameters manipulated by the tuning commands (**no**, **nfso**, **vmo**, **ioo**, and **schedo**) have been classified into the following categories:

- **Dynamic**: if the parameter can be changed at any time
- **Static**: if the parameter can never be changed
- **Reboot**: if the parameter can only be changed during reboot
- **Bosboot**: if the parameter can only be changed by running **bosboot** and rebooting the machine
- **Mount**: if changes to the parameter are only effective for future file systems or directory mounts
- **Incremental**: if the parameter can only be incremented, except at boot time
- **Connect**: if changes to the parameter are only effective for future socket connections
- **Deprecated**: if changing this parameter is no longer supported by the current release of AIX

The manual page for each of the five tuning commands contains the complete list of all the parameter manipulated by each of the commands and for each parameter, its type, range, default value, and any dependencies on other parameters.

For parameters of type Bosboot, whenever a change is performed, the tuning commands automatically prompt the user to ask if they want to execute the **bosboot** command. For parameters of type Connect, the tuning commands automatically restart the **inetd** daemon.

Common Syntax for Tuning Commands

The **no**, **nfso**, **vmo**, **ioo**, and **schedo** tuning commands all support the following syntax:

```
command [-p|-r] {-o tunable[=newvalue]}
command [-p|-r] {-d tunable}
command [-p|-r] -D
command [-p|-r] -a
command -h [tunable]
command -L [tunable]
command -x [tunable]
```

- a** Displays current, reboot (when used in conjunction with **-r**) or permanent (when used in conjunction with **-p**) value for all tunable parameters, one per line in pairs `tunable = value`. For the permanent options, a value is displayed for a parameter only if its reboot and current values are equal. Otherwise, NONE is displayed as the value. If a tunable is not supported by the running kernel or the current platform, "n/a" is displayed as the value.
- d tunable** Resets tunable to default value. If a tunable needs to be changed (that is, it is currently not set to its default value) and is of type **Bosboot** or **Reboot**, or if it is of type Incremental and has been changed from its default value, and **-r** is not used in combination, it is not changed, but a message displays instead.
- D** Resets all tunables to their default value. If tunables needing to be changed are of type **Bosboot** or **Reboot**, or are of type Incremental and have been changed from their default value, and **-r** is not used in combination, they are not changed, but a message displays instead.
- h [tunable]** Displays help about tunable parameter. Otherwise, displays the command usage statement.

-o `tunable[=newvalue]` Displays the value or sets tunable to *newvalue*. If a tunable needs to be changed (the specified value is different than current value), and is of type **Bosboot** or **Reboot**, or if it is of type Incremental and its current value is bigger than the specified value, and **-r** is not used in combination, it is not changed, but a message displays instead.

When **-r** is used in combination without a new value, the **nextboot** value for tunable is displayed. When **-p** is used in combination without a new value, a value is displayed only if the current and next boot values for tunable are the same. Otherwise, NONE is displayed as the value. If a tunable is not supported by the running kernel or the current platform, "n/a" is displayed as the value.

-p When used in combination with **-o**, **-d** or **-D**, makes changes apply to both current and reboot values; that is, turns on the updating of the `/etc/tunables/nextboot` file in addition to the updating of the current value. This flag cannot be used on **Reboot** and **Bosboot** type parameters because their current value cannot be changed.

When used with **-a** or **-o** flag without specifying a new value, values are displayed only if the current and next boot values for a parameter are the same. Otherwise, NONE is displayed as the value.

-r When used in combination with **-o**, **-d** or **-D** flags, makes changes apply to reboot values only; that is, turns on the updating of the `/etc/tunables/nextboot` file. If any parameter of type **Bosboot** is changed, the user will be prompted to run **bosboot**.

When used with **-a** or **-o** without specifying a new value, next boot values for tunables are displayed instead of current values.

-x [*tunable*] Lists the characteristics of one or all tunables, one per line, using the following format:
tunable,current,default,reboot, min,max,unit,type,{dtunable }

where:

current = current value
default = default value
reboot = reboot value
min = minimal value
max = maximum value
unit = tunable unit of measure
type = parameter type: D(for Dynamic), S(for Static),
R(for Reboot), B(for Bosboot), M(for Mount),
I(for Incremental), C (for Connect), and d (for Deprecated)
dtunable = space separated list of dependent tunable parameters

-L [*tunable*] Lists the characteristics of one or all tunables, one per line, using the following format:

NAME	CUR	DEF	BOOT	MIN	MAX	UNIT	TYPE
DEPENDENCIES							

memory_frames	128K	128K				4KB pages	S

maxfree	128	128	128	16	200K	4KB pages	D
minfree							
memory_frames							

where:

CUR = current value
 DEF = default value
 BOOT = reboot value
 MIN = minimal value
 MAX = maximum value
 UNIT = tunable unit of measure
 TYPE = parameter type: D (for Dynamic), S (for Static),
 R (for Reboot), B (for Bosboot),
 M (for Mount), I (for Incremental),
 C (for Connect), and d (for Deprecated)
 DEPENDENCIES = list of dependent tunable parameters, one per line

Any change (with **-o**, **-d** or **-D** flags) to a parameter of type **Mount** will result in a message displays to warn the user that the change is only effective for future mountings.

Any change (with **-o**, **-d** or **-D** flags) to a parameter of type **Connect** will result in the **inetd** daemon being restarted, and a message will display to warn the user that the change is only effective for socket connections.

Any attempt to change (with **-o**, **-d** or **-D** flags) a parameter of type **Bosboot** or **Reboot** without **-r**, will result in an error message.

Any attempt to change (with **-o**, **-d** or **-D** flags but without **-r**) the current value of a parameter of type **Incremental** with a new value smaller than the current value, will result in an error message.

Tunable File-Manipulation Commands

The following commands normally manipulate files in the **/etc/tunables** directory, but the files can be located anywhere. Therefore, as long as the file name does not contain a forward slash (/), all the file names specified are expanded to **/etc/tunables/filename**. To guarantee the consistency of their content, all the files are locked before any updates are made. The commands **tunsave**, **tuncheck** (only if successful), and **tundefault -r** all update the info stanza.

tunchange Command

The **tunchange** command is used to update one or more tunable stanzas in a file. Its syntax is as follows:

```
tunchange -f filename ( -t stanza ( {-o parameter [=value]} | -D ) | -m filename2 )
```

where stanza is **schedo**, **vmo**, **ioo**, **no**, or **nfso**.

The following is an example of how to update the **pacefork** parameter in the **/etc/tunables/mytunable** directory:

```
tunchange -f mytunable -t schedo -o pacefork=10
```

The following is an example of how to unconditionally update the **pacefork** parameter in the **/etc/tunables/nextboot** directory. This should be done with caution because no warning will be printed if a parameter of type **bosboot** was changed.

```
tunchange -f nextboot -t schedo -o pacefork=10
```

The following is an example of how to clear the **schedo** stanza in the **nextboot** file.

```
tunchange -f nextboot -t schedo -D
```

The following is an example of how to merge the **/home/admin/schedo_conf** file with the current **nextboot** file. If the file to merge contains multiple entries for a parameter, only the first entry will be applied. If both files contain an entry for the same tunable, the entry from the file to merge will replace the current **nextboot** file's value.

```
tunchange -f nextboot -m /home/admin/schedo_conf
```

The **tunchange** command is called by the tuning commands to implement the **-p** and **-r** flags using **-f nextboot**.

tuncheck Command

The **tuncheck** command is used to validate a file. Its syntax is as follows:

```
tuncheck [-r|-p] -f filename
```

The following is an example of how to validate the **/etc/tunables/mytunable** file for usage on current values.

```
tuncheck -f mytunable
```

The following is an example of how to validate the **/etc/tunables/nextboot** file or **my_nextboot** file for usage during reboot. Note that the **-r** flag is the only valid option when the file to check is the **nextboot** file.

```
tuncheck -r -f nextboot
```

```
tuncheck -r -f /home/bill/my_nextboot
```

All parameters in the **nextboot** or **my_nextboot** file are checked for range, and dependencies, and if a problem is detected, a message similar to: "Parameter X is out of range" or "Dependency problem between parameter A and B" is issued. The **-r** and **-p** options control the values used in dependency checking for parameters not listed in the file and the handling of proposed changes to parameters of type **Incremental**, **Bosboot**, and **Reboot**.

Except when used with the **-r** option, checking is performed on parameter of type **Incremental** to make sure the value in the file is not less than the current value. If one or more parameters of type **Bosboot** are listed in the file with a different value than its current value, the user will either be prompted to run **bosboot** (when **-r** is used) or an error message will display.

Parameters having dependencies are checked for compatible values. When one or more parameters in a set of interdependent parameters is not listed in the file being checked, their values are assumed to either be set at their current value (when the **tuncheck** command is called without **-p** or **-r**), or their default value. This is because when called without **-r**, the file is validated to be applicable on the current values, while with **-r**, it is validated to be used during reboot when parameters not listed in the file will be left at their default value. Calling this command with **-p** is the same as calling it twice; once with no argument, and once with the **-r** flag. This checks whether a file can be used both immediately, and at reboot time.

Note: Users creating a file with an editor, or copying a file from another machine, must run the **tuncheck** command to validate their file.

tunrestore Command

The **tunrestore** command is used to restore all the parameters from a file. Its syntax is as follows:

```
tunrestore -R | [-r] -f filename
```

For example, the following will change the current values for all tunable parameters present in the file if ranges, dependencies, and incremental parameter rules are all satisfied.

```
tunrestore -f mytunable
```

```
tunrestore -f /etc/tunables/mytunable
```

In case of problems, only the changes possible will be made.

For example, the following will change the **reboot** values for all tunable parameters present in the file if ranges and dependencies rules are all satisfied. In other words, they will be copied to the **/etc/tunables/nextboot** file.

```
tunrestore -r -f mytunable
```

If changes to parameters of type **Bosboot** are detected, the user will be prompted to run the **bosboot** command.

The following command can only be called from the **/etc/inittab** file and changes tunable parameters to values from the **/etc/tunables/nextboot** file.

```
tunrestore -R
```

Any problem found or change made is logged in the **/etc/tunables/lastboot.log** file. A new **/etc/tunables/lastboot** file is always created with the list of current values for all parameters.

If *filename* does not exist, an error message displays. If the **nextboot** file does not exist, an error message displays if **-r** was used. If **-R** was used, all the tuning parameters of a type other than **Bosboot** will be set to their default value, and a **nextboot** file containing only an info stanza will be created. A warning will also be logged in the **lastboot.log** file.

Except when **-r** is used, parameters requiring a call to **bosboot** and a **reboot** are not changed, but an error message is displayed to indicate they could not be changed. When **-r** is used, if any parameter of type **Bosboot** needs to be changed, the user will be prompted to run **bosboot**. Parameters missing from the file are simply left unchanged, except when **-R** is used, in which case missing parameters are set to their default values. If the file contains multiple entries for a parameter, only the first entry will be applied, and a warning will be displayed or logged (if called with **-R**).

tunsave Command

The **tunsave** command is used to save current tunable parameter values into a file. Its syntax is as follows:

```
tunsave [-a|-A] -f|-F filename
```

For example, the following saves all of the current tunable parameter values that are different from their default into the **/etc/tunables/mytunable** file.

```
tunsave -f mytunable
```

If the file already exists, an error message is printed instead. The **-F** flag must be used to overwrite an existing file.

For example, the following saves all of the current tunable parameter values different from their default into the **/etc/tunables/nextboot** file.

```
tunsave -f nextboot
```

If necessary, the **tunsave** command will prompt the user to run **bosboot**.

For example, the following saves all of the current tunable parameter values (including parameters for which default is their value) into the **mytunable** file.

```
tunsave -A -f mytunable
```

This allows you to save the current setting. This setting can be reproduced at a later time, even if the default values have changed (default values can change when the file is used on another machine or when running another version of AIX).

For example, the following saves all current tunable parameter values into the **/etc/tunables/mytunable** file or the **mytunable** file in the current directory.

```
tunsave -a -f mytunable
```

```
tunsave -a -f ./mytunable
```

For the parameters that are set to default values, a line using the keyword **DEFAULT** will be put in the file. This essentially saves only the current changed values, while forcing all the other parameters to their default values. This allows you to return to a known setup later using the **tunrestore** command.

tundefault Command

The **tundefault** command is used to force all tuning parameters to be reset to their default value. The **-p** flag makes changes permanent, while the **-r** flag defers changes until the next reboot. The command syntax is as follows:

```
tundefault [-p|-r]
```

For example, the following example resets all tunable parameters to their default value, except the parameters of type **Bosboot** and **Reboot**, and parameters of type **Incremental** set at values bigger than their default value.

```
tundefault
```

Error messages will be displayed for any parameter change that is not permitted.

For example, the following example resets all the tunable parameters to their default value. It also updates the **/etc/tunables/nextboot** file, and if necessary, offers to run **bosboot**, and displays a message warning that rebooting is needed for all the changes to be effective.

```
tundefault -p
```

This command permanently resets *all* tunable parameters to their default values, returning the system to a consistent state and making sure the state is preserved after the next reboot.

For example, the following example clears all the command stanzas in the **/etc/tunables/nextboot** file, and proposes **bosboot** if necessary.

```
tundefault -r
```

Initial setup

Installing the **bos.perf.tune** fileset automatically creates an initial **/etc/tunables/nextboot** file and adds the following line at the beginning of the **/etc/inittab** file:

```
tunable:23456789:wait:/usr/bin/tunrestore -R > /dev/console 2>&1
```

This entry sets the **reboot** value of all tunable parameters to their default. For more information about migration from a previous version of AIX and the compatibility mode automatically setup in case of migration, read "Introduction to AIX 5.2 Tunable Parameter Settings" in the *AIX 5L Version 5.3 Performance Management Guide*.

Reboot Tuning Procedure

Parameters of type **Bosboot** are set by the **bosboot** command, which retrieves their values from the **nextboot** file when creating a new boot image. Parameters of type **Reboot** are set during the reboot process by the appropriate configuration methods, which also retrieve the necessary values from the **nextboot** file. In both cases, if there is no **nextboot** file, the parameters will be set to their default values. All other parameters are set using the following process:

1. When **tunrestore -R** is called, any tunable changed from its default value is logged in the **lastboot.log** file. The parameters of type **Reboot** and **Bosboot** present in the **nextboot** file, and which should already have been changed by the time **tunrestore -R** is called, will be checked against the value in the file, and any difference will also be logged.
2. The **lastboot** file will record all the tunable parameter settings, including default values, which will be flagged using # **DEFAULT VALUE**, and the **AIX_level**, **Kernel_type**, **Last_validation**, and **Logfile_checksum** fields will be set appropriately.
3. If there is no **/etc/tunables/nextboot** file, all tunable parameters, except those of type **Bosboot**, will be set to their default value, a **nextboot** file with only an info stanza will be created, and the following warning: "cannot access the **/etc/tunables/nextboot** file" will be printed in the log file. The **lastboot** file will be created as described in step 2.
4. If the desired value for a parameter is found to be out of range, the parameter will be left to its default value, and a message similar to the following: "Parameter A could not be set to X, which is out of range, and was left to its current value (Y) instead" will be printed in the log file. Similarly, if a set of interdependent parameters have values incompatible with each other, they will all be left at their default values and a message similar to the following: "Dependent parameter A, B and C could not be set to X, Y and Z because those values are incompatible with each other. Instead, they were left to their current values (T, U and V)" will be printed in the log file.

All of these error conditions could exist if a user modified the **/etc/tunables/nextboot** file with an editor or copied it from another machine, possibly running a different version of AIX with different valid ranges, and did not run **tuncheck -r -f** on the file. Alternatively, **tuncheck -r -f** prompted the user to run **bosboot**, but this was not done.

Recovery Procedure

If the machine becomes unstable with a given **nextboot** file, users should put the system into maintenance mode, make sure the **sys0 pre520tune** attribute is set to disable, delete the **nextboot** file, run the **bosboot** command and reboot. This action will guarantee that all tunables are set to their default value.

Kernel Tuning Using the SMIT Interface

To start the SMIT panels that manage AIX kernel tuning parameters, use the SMIT fast path **smitty tuning**. The following is a view of the tuning panel:

Tuning Kernel Parameters

```
Save/Restore All Kernel & Network Parameters
Tuning Scheduler and Memory Load Control Parameters
Tuning Virtual Memory Manager Parameters
Tuning Network Parameters
Tuning NFS Parameters
Tuning I/O Parameters
```

Select **Save/Restore All Kernel & Network Parameters** to manipulate all tuning parameter values at the same time. To individually change tuning parameters managed by one of the tuning commands, select any of the other lines.

Global Manipulation of Tuning Parameters

The main panel to manipulate all tunable parameters by sets looks similar to the following:

```
Save/Restore All Kernel Tuning Parameters

View Last Boot Parameters
View Last Boot Log File

Save All Current Parameters for Next Boot
Save All Current Parameters
Restore All Current Parameters from Last Boot Values
Restore All Current Parameters from Saved Values
Reset All Current Parameters To Default Value

Save All Next Boot Parameters
Restore All Next Boot Parameters from Last Boot Values
Restore All Next Boot Parameters from Saved Values
Reset All Next Boot Parameters To Default Value
```

Each of the options in this panel are explained in the following sections.

1. **View Last Boot Parameters**
All last boot parameters are listed stanza by stanza, retrieved from the `/etc/tunables/lastboot` file.
2. **View Last Boot Log File**
Displays the content of the file `/etc/tunables/lastboot.log`.
3. **Save All Current Parameters for Next Boot**

```
Save All Current Kernel Tuning Parameters for Next Boot

ARE YOU SURE ?
```

After selecting **yes** and pressing **ENTER**, all the current tuning parameter values are saved in the `/etc/tunables/nextboot` file. **Bosboot** will be offered if necessary.

4. **Save All Current Parameters**

```
Save All Current Kernel Tuning Parameters

File name      []
Description    []
```

Type or select values for the two entry fields:

- **File name:** F4 will show the list of existing files. This is the list of all files in the `/etc/tunables` directory except the files `nextboot`, `lastboot` and `lastboot.log` which all have special purposes. File names entered cannot be any of the above three reserved names.
- **Description:** This field will be written in the info stanza of the selected file.

After pressing **ENTER**, all of the current tuning parameter values will be saved in the selected stanza file of the `/etc/tunables` directory.

5. **Restore All Current Parameters from Last Boot Values**

```
Restore All Current Parameters from Last Boot Values

ARE YOU SURE ?
```

After selecting **yes** and pressing **ENTER**, all the tuning parameters will be set to values from the **/etc/tunables/lastboot** file. Error messages will be displayed if any parameter of type **Bosboot** or **Reboot** would need to be changed, which can only be done when changing reboot values.

6. Restore All Current Parameters from Saved Values

```
Restore Saved Kernel Tuning Parameters

Move cursor to desired item and press Enter.

mytunablefile  Description field of mytunable file
tun1           Description field of lastweek file
```

A select menu shows existing files in the **/etc/tunables** directory, except the files **nextboot**, **lastboot** and **lastboot.log** which all have special purposes.

After pressing **ENTER**, the parameters present in the selected file in the **/etc/tunables** directory will be set to the value listed if possible. Error messages will be displayed if any parameter of type **Bosboot** or **Reboot** would need to be changed, which can't be done on the current values. Error messages will also be displayed for any parameter of type **Incremental** when the value in the file is smaller than the current value, and for out of range and incompatible values present in the file. All possible changes will be made.

7. Reset All Current Parameters To Default Value

```
Reset All Current Kernel Tuning Parameters To Default Value

ARE YOU SURE ?
```

After pressing **ENTER**, each tunable parameter will be reset to its default value. Parameters of type **Bosboot** and **Reboot**, are never changed, but error messages are displayed if they should have been changed to get back to their default values.

8. Save All Next Boot Parameters

```
Save All Next Boot Kernel Tuning Parameters

File name [ ]
```

Type or a select values for the entry field. Pressing **F4** displays a list of existing files. This is the list of all files in the **/etc/tunables** directory except the files **nextboot**, **lastboot** and **lastboot.log** which all have special purposes. File names entered cannot be any of those three reserved names.

After pressing **ENTER**, the **nextboot** file, is copied to the specified **/etc/tunables** file if it can be successfully **tunchecked**.

9. Restore All Next Boot Parameters from Last Boot Values

```
Restore All Next Boot Kernel Tuning Parameters from Last Boot Values

ARE YOU SURE ?
```

After selecting **yes** and pressing **ENTER**, all values from the **lastboot** file will be copied to the **nextboot** file. If necessary, the user will be prompted to run **bosboot**, and warned that for all the changes to be effective, the machine must be rebooted.

10. Restore All Next Boot Parameters from Saved Values

Restore All Next Boot Kernel Tuning Parameters from Saved Values

Move cursor to desired item and press Enter.

```
mytunablefile  Description field of mytunablefile file
tun1           Description field of tun1 file
```

A select menu shows existing files in the `/etc/tunables` directory, except the files `nextboot`, `lastboot` and `lastboot.log` which all have special purposes.

After selecting a file and pressing **ENTER**, all values from the selected file will be copied to the `nextboot` file, if the file was successfully **tunchecked** first. If necessary, the user will be prompted to run **bosboot**, and warned that for all the changes to be effective, rebooting the machine is necessary.

11. Reset All Next Boot Parameters To Default Value

Reset All Next Boot Kernel Tuning Parameters To Default Value

ARE YOU SURE ?

After hitting **ENTER**, the `/etc/tunables/nextboot` file will be cleared. If necessary **bosboot** will be proposed and a message indicating that a reboot is needed will be displayed.

Changing individual parameters managed by a tuning command

All the panels for all five commands behave the same way. In the following sections, we will use the example of the Scheduler and Memory Load Control (i.e. **schedo**) panels to explain the behavior. Here is the main panel to manipulate parameters managed by the **schedo** command:

Tuning Scheduler and Memory Load Control Parameters

```
List All Characteristics of Current Parameters
Change / Show Current Parameters
Change / Show Parameters for next boot
Save Current Parameters for Next Boot
Reset Current Parameters to Default value
Reset Next Boot Parameters To Default Value
```

Interaction between parameter types and the different SMIT sub-panels

The following table shows the interaction between parameter types and the different SMIT sub-panels:

Sub-panel name	Action
List All Characteristics of Current Parameters	Lists current, default, reboot, limit values, unit, type and dependencies. This is the output of a tuning command called with the -L option.
Change / Show Current Parameters	Displays and changes current parameter value, except for parameter of type Static, Bosboot and Reboot which are displayed without surrounding square brackets to indicate that they cannot be changed.
Change / Show Parameters for Next Boot	Displays values from and rewrite updated values to the nextboot file. If necessary, bosboot will be proposed. Only parameters of type Static cannot be changed (no brackets around their value).
Save Current Parameters for Next Boot	Writes current parameters in the nextboot file, bosboot will be proposed if any parameter of type Bosboot was changed.

Reset Current Parameters to Default value	Resets current parameters to default values, except those which need a bosboot plus reboot or a reboot (bosboot and reboot type).
Reset Next Boot Parameters to Default value	Clears values in the nextboot file, and propose bosboot if any parameter of type Bosboot was different from its default value.

Each of the sub-panels behavior is explained in the following sections using examples of the scheduler and memory load control sub-panels:

1. List All Characteristics of Tuning Parameters
The output of **schedo -L** is displayed.
2. Change/Show Current Scheduler and Memory Load Control Parameters

```

Change / Show Current Scheduler and Memory Load Control Parameters

                                [Entry Field]

affinity_lim                    [7]
idle_migration_barrier          [4]
fixed_pri_global                [0]
maxspin                         [1]
pacefork                       [10]
sched_D                        [16]
sched_R                        [16]
timeslice                      [1]
%usDelta                       [100]
v_exempt_secs                  [2]
v_min_process                  [2]
v_repage_hi                    [2]
v_repage_proc                  [6]
v_sec_wait                     [4]

```

This panel is initialized with the current **schedo** values (output from the **schedo -a** command). Any parameter of type **Bosboot**, **Reboot** or **Static** is displayed with no surrounding square bracket indicating that it cannot be changed.

From the F4 list, type or select values for the entry fields corresponding to parameters to be changed. Clearing a value results in resetting the parameter to its default value. The F4 list also shows minimum, maximum, and default values, the unit of the parameter and its type. Selecting F1 displays the help associated with the selected parameter. The text displayed will be identical to what is displayed by the tuning commands when called with the **-h** option.

Press **ENTER** after making all the desired changes. Doing so will launch the **schedo** command to make the changes. Any error message generated by the command, for values out of range, incompatible values, or lower values for parameter of type **Incremental**, will be displayed to the user.

3. The following is an example of the Change / Show Scheduler and Memory Load Control Parameters for next boot panel.

Change / Show Scheduler and Memory Load Control Parameters for next boot

[Entry Field]

affinity_lim	[7]
idle_migration_barrier	[4]
fixed_pri_global	[0]
maxpin	[1]
pacefork	[10]
sched_D	[16]
sched_R	[16]
timeslice	[1]
%usDelta	[100]
v_exempt_secs	[2]
v_min_process	[2]
v_repage_hi	[2]
v_repage_proc	[6]
v_sec_wait	[4]

This panel is similar to the previous panel, in that, any parameter value can be changed except for parameters of type **Static**. It is initialized with the values listed in the `/etc/tunables/nextboot` file, completed with default values for the parameter not listed in the file.

Type or select (from the F4 list) values for the entry field corresponding to the parameters to be changed. Clearing a value results in resetting the parameter to its default value. The F4 list also shows minimum, maximum, and default values, the unit of the parameter and its type. Pressing F1 displays the help associated with the selected parameter. The text displayed will be identical to what is displayed by the tuning commands when called with the **-h** option.

Press **ENTER** after making all desired changes. Doing so will result in the `/etc/tunables/nextboot` file being updated with the values modified in the panel, except for out of range, and incompatible values for which an error message will be displayed instead. If necessary, the user will be prompted to run **bosboot**.

- The following is an example of the Save Current Scheduler and Memory Load Control Parameters for Next Boot panel.

Save Current Scheduler and Memory Load Control Parameters for Next Boot

ARE YOU SURE ?

After pressing **ENTER** on this panel, all the current **schedo** parameter values will be saved in the `/etc/tunables/nextboot` file . If any parameter of type **Bosboot** needs to be changed, the user will be prompted to run **bosboot**.

- The following is an example of the Reset Current Scheduler and Memory Load Control Parameters to Default Values

Reset Current Scheduler and Memory Load Control Parameters to Default Value

ARE YOU SURE ?

After selecting **yes** and pressing **ENTER** on this panel, all the tuning parameters managed by the **schedo** command will be reset to their default value. If any parameter of type **Incremental**, **Bosboot** or **Reboot** should have been changed, and error message will be displayed instead.

- The following is an example of the Reset Scheduler and Memory Load Control Next Boot Parameters To Default Values

Reset Next Boot Parameters To Default Value

ARE YOU SURE ?

After pressing **ENTER**, the **schedo** stanza in the **/etc/tunables/nextboot** file will be cleared. This will defer changes until next reboot. If necessary, **bosboot** will be proposed.

Kernel Tuning using the Performance Plug-In for Web-based System Manager

AIX kernel tuning parameters can be managed using the Web-based System Manager System Tuning Plug-in, which is a sub-plugin of the Web-based System Manager Performance plug-in. The Performance Plug-in is available from the Web-based System Manager main console which looks similar to the following:



Figure 28. Performance Plug-in shown in Web-based System Manager main console

The Performance plug-in is organized into the following sub-plugins:

- Performance Monitoring plug-in
- System Tuning plug-in

The Performance Monitoring sub-plugin gives access to a variety of performance-monitoring and report-generation tools. The System Tuning sub-plugin consists of CPU, Memory, Disk I/O, and Network I/O sub-plugins, which present tuning tables from which AIX tuning parameters can be visualized and changed.

The Navigation Area for the System Tuning plug-in contains three levels of sub-plugins as seen in the following:

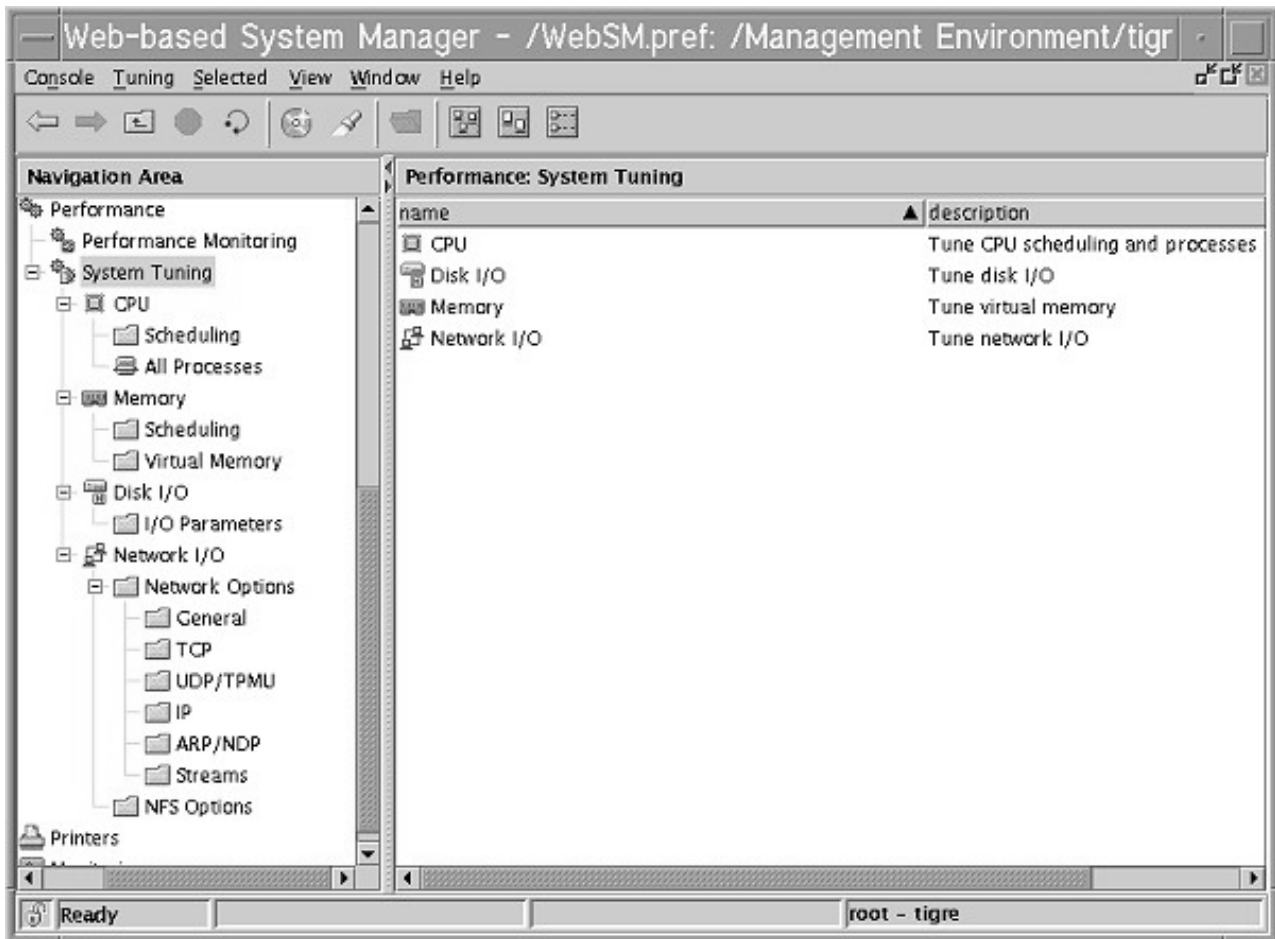

Figure 29. System Tuning plug-in Performance window

These intermediate levels represent tuning resources. They are further split into sub-plugins but have no specific actions associated with them and only exist to group access to tunable parameters in a logical way. Actions on tunable parameters can be applied at the following levels:

System-Tuning level

Global actions applicable to all tunable parameters are provided at this level.

Leaf Levels

Leaves are represented by a folder icon (see navigation area in Figure 29). When selecting a leaf, a tuning table is displayed in the content area. A table represents a logical group of tunable parameters, all managed by one of the tunable commands (**schedo**, **vmo**, **ioo**, **no**, and **nfso**). Specific actions provided at this level apply only to the tunable parameters displayed in the current table.

The **CPU/All Processes** sub-plugin is a link to the **All Processes** sub-plugin of the Processes application. Its purpose is not to manipulate tuning parameters and will not be discussed.

Global Actions on Tunable Parameters

Only the Web-based System Manager **Tuning** menu has specific actions associated with it. The specific actions available at this level are global, in that they apply to all the performance tunable

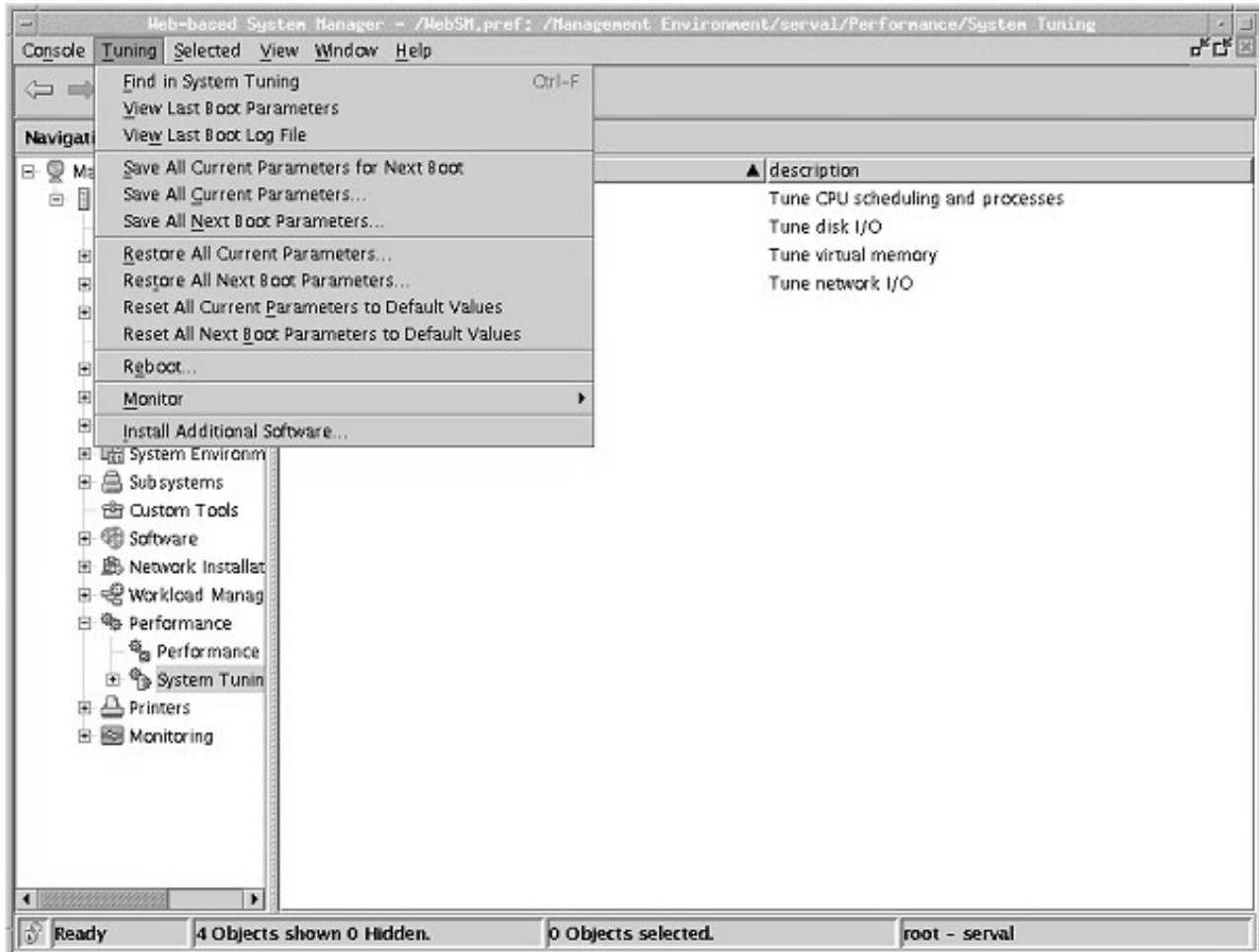

Figure 30. Web-based System Manager Tuning menu

parameters.

- 1. View Last Boot Parameters**
This action displays the `/etc/tunables/lastboot` file in an open working dialog.
- 2. View Last Boot Log File**
This action displays the `/etc/tunables/lastboot.log` file in an open working dialog.
- 3. Save All Current Parameters for Next Boot**
The Save All Current Parameters warning dialog is opened.

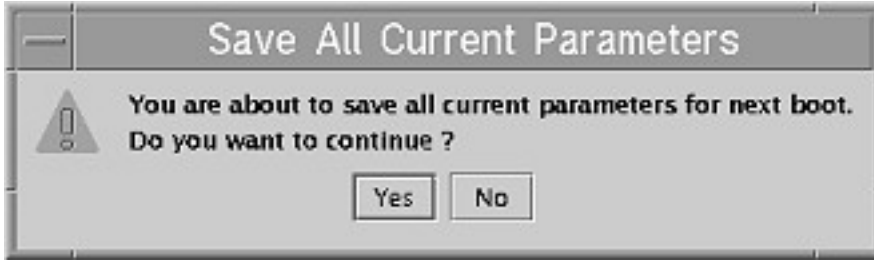

Figure 31. Save All Current Parameters for next boot dialog

After clicking **Yes**, all the current tuning parameter values will be saved in the `/etc/tunables/nextboot` file. **Bosboot** will be offered if necessary.

4. Save All Current Parameters

The Save All Current Parameters dialog with a Filename field and a Description field is opened.

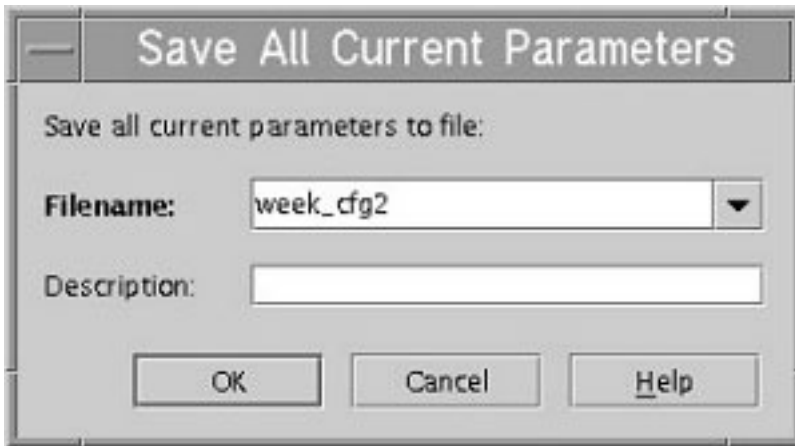

Figure 32. Save All Current Parameters to file dialog

The **Filename** editable combobox, lists all the tunable files present in the `/etc/tunables` directory, except the `nextboot`, `lastboot` and `lastboot.log` files, which all have special purposes. If no file is present, the combobox list is empty. The user can choose an existing file, or create a new file by entering a new name. File names entered cannot be any of the three reserved names. The **Description** field will be written in the info stanza of the selected file. After clicking **OK**, all the current tuning parameter values will be saved in the selected file in the `/etc/tunables` directory.

5. Save All Next Boot Parameters

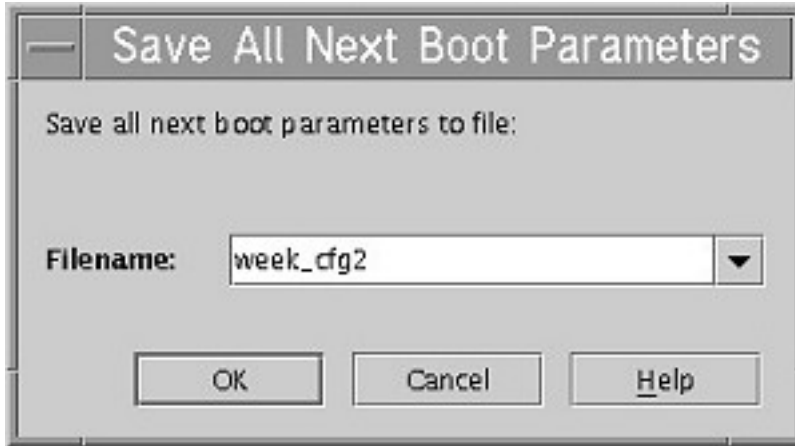

Figure 33. Save All Next Boot Parameters to file dialog

This action opens an editable combobox which lists all the tunable files present in the **/etc/tunables** directory, except the **nextboot**, **lastboot** and **lastboot.log** files, which all have special purposes. If no file is present, the combobox list is empty. The user can choose an existing file, or create a new file by entering a new name. File names entered cannot be any of the three reserved names. After clicking **OK**, the **nextboot** file, is copied to the specified **/etc/tunables** file it it can be successfully checked using the **tuncheck** command.

6. **Restore All Current Parameters**

This action opens an editable combobox showing the list of all existing files in the **/etc/tunables** directory, except the files **nextboot**, and **lastboot.log** which have special purposes.

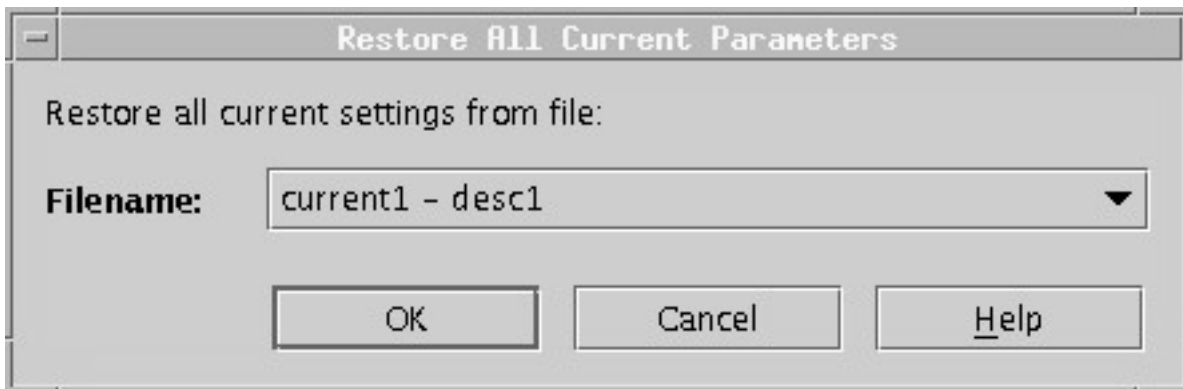

Figure 34. Restore All Current Parameters dialog

The user selects the file to use for restoring the current values of tuning parameters. The **lastboot** file is proposed as the default (first element of the combo list). Files can have a description which is displayed after the name in the combobox items, separated from the file name by a dash character. After clicking **OK**, the parameters present in the selected file in the **/etc/tunables** directory will be set to the value listed if possible. Error messages will be displayed if any parameter of type **Bosboot** or **Reboot** would need to be changed, which cannot be done on the current values. Error messages will also be displayed for any parameter of type **Incremental** when the value in the file is smaller than the current value, and for out of range and incompatible values present in the file. All possible changes will be made.

7. **Restore All Next Boot Parameters**

A combobox is opened to display the list of all existing files in the **/etc/tunables** directory, except the files **nextboot**, and **lastboot.log** which have special purposes.

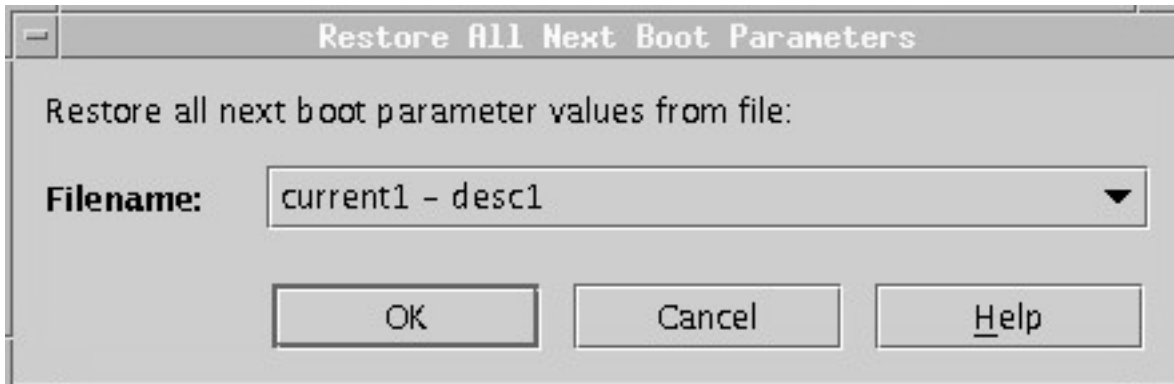

Figure 35. Restore All Next Boot Parameters dialog

The user selects the file to use for restoring the **nextboot** values of tuning parameters. The **lastboot** file is proposed as the default (first element of the combo list). Files can have a description which is displayed after the name in the combobox items, separated from the file name by a dash character. After clicking **OK**, all values from the selected file will be copied to the **/etc/tunables/nextboot** file. Incompatible dependent parameter values or out of range values will not be copied to the file (this could happen if the file selected was not previously **tunckecked**). Error messages will be displayed instead. If necessary, the user will be prompted to run **bosboot**, and warned that for all the changes to be effective, rebooting the machine is necessary.

8. **Reset All Current Parameters to Default Values**

A warning dialog is opened and after clicking **Yes**, a working dialog is displayed. Each tunable parameter is reset to its default value. Parameters of type **Incremental**, **Bosboot** and **Reboot**, are never changed, but error messages are displayed if they should have been changed to revert to default values.

9. **Reset All Next Boot Parameters to Default Values**

A warning dialog is opened and after clicking **Yes**, an interactive working dialog is displayed and the **/etc/tunables/nextboot** file is cleared. If necessary **bosboot** will be proposed and a message indicating that a reboot is needed will be displayed.

Using Tuning Tables to Change Individual Parameter Values

Each tuning table in the content area has the same structure. It allows all the characteristics of the tunable parameters to be viewed at a glance. The table has two editable columns, **Current Value** and **Next Boot Value**. Each cell in these two columns is an editable combobox, with only one predefined value of **Default**, for the capture of new value for a parameter. Data entered in these columns is validated when pressing **ENTER**.

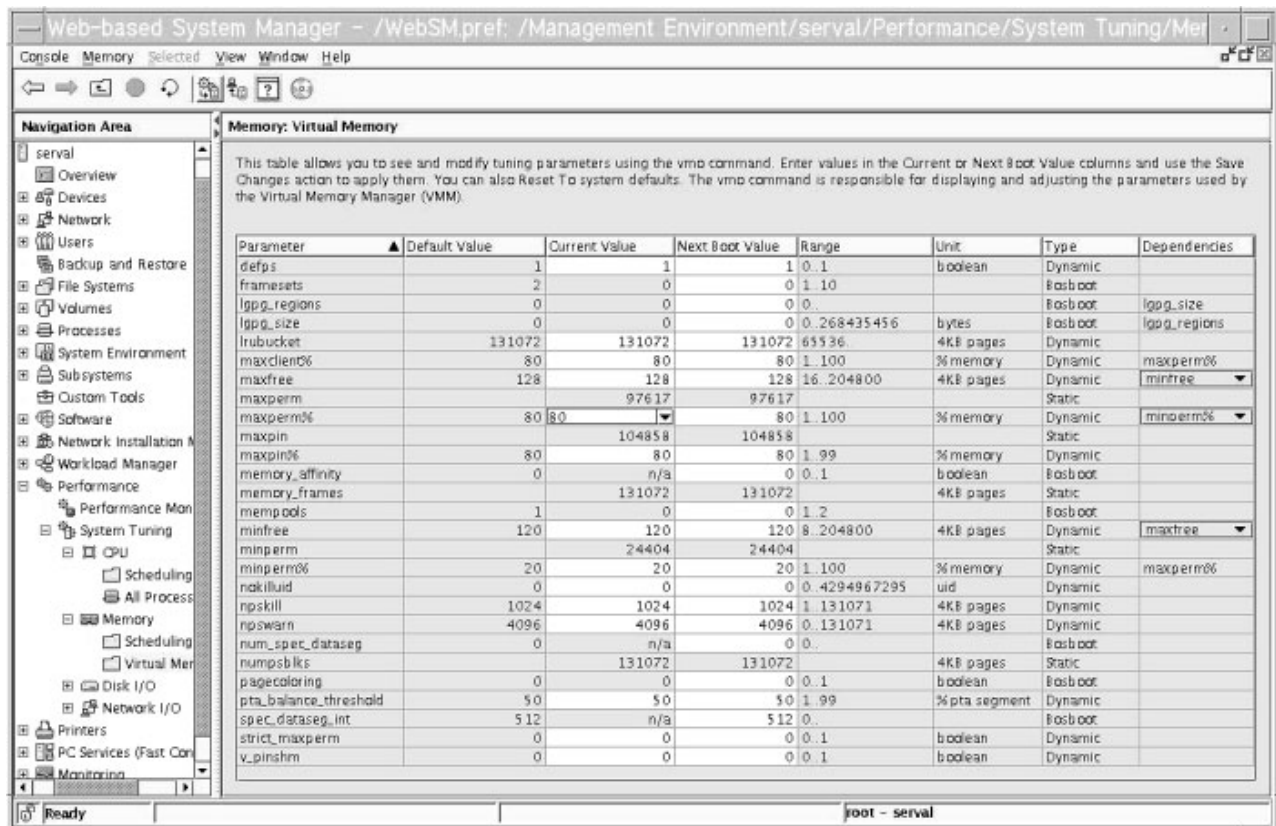

Figure 36. Memory VMM window

The parameters are grouped as they are in the SMIT panels with two small exceptions. First, the Network related parameters are all presented in one SMIT panel, but subdivided in six sections. The Web-based System Manager interface uses six separate tables instead.

Lastly, the parameters managed by the **schedo** command are available from two sub-plugins: CPU/scheduling and memory/scheduling.

Actions allowed vary according to parameter types:

- Static parameters do not have an editable cell.
- New values for Dynamic parameters can be applied now or saved for next boot.
- New values for **Reboot** parameters can only be saved for next boot.
- New values for **Bosboot** parameters can only be saved for next boot, and users are prompted to run bosboot.
- New values for **Mount** parameters can be applied now or saved for next boot, but when applied immediately, a warning will be displayed to tell the user that changes will only be effective for future file systems or directory mountings.
- New values for **Incremental** parameters can be applied now or saved for next boot. If applied now, they will only be accepted if the new value is bigger than the current value.

The following section explains in detail the behavior of the tables.

Tunable Tables Actions

The actions available for each tunable table are **Save Changes**, **Save Current Parameters for Next Boot**, **Reset Parameters to System Default**, **Parameter Details**, and **Monitor**. The **Monitor** action enables related monitoring tools to start from each of the plug-ins and is not discussed in this section.

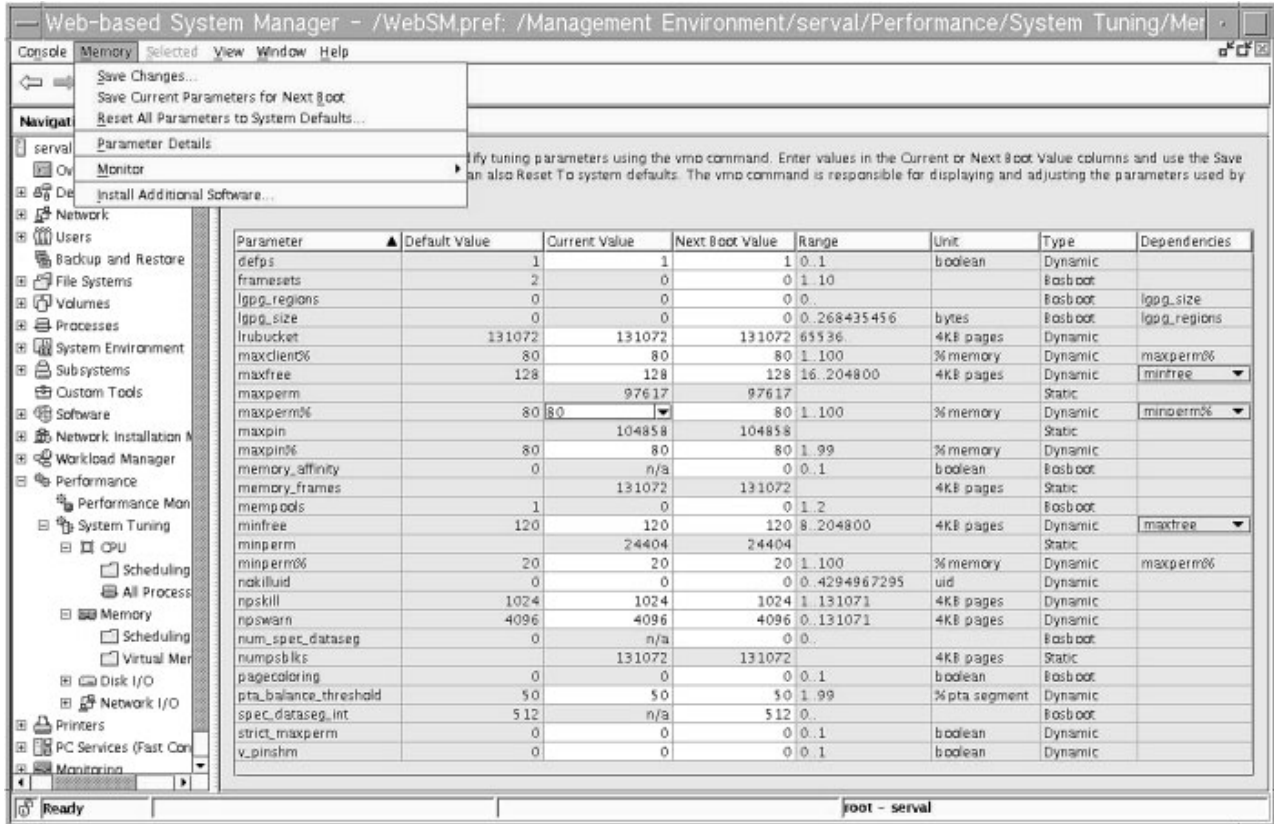

Figure 37. Tables Menus window

1. Save Changes

This option opens a dialog allowing the saving of new values for the parameters listed in the **Current Value** and **Next Boot Value** columns of the table. The two options are checked by default. They are:

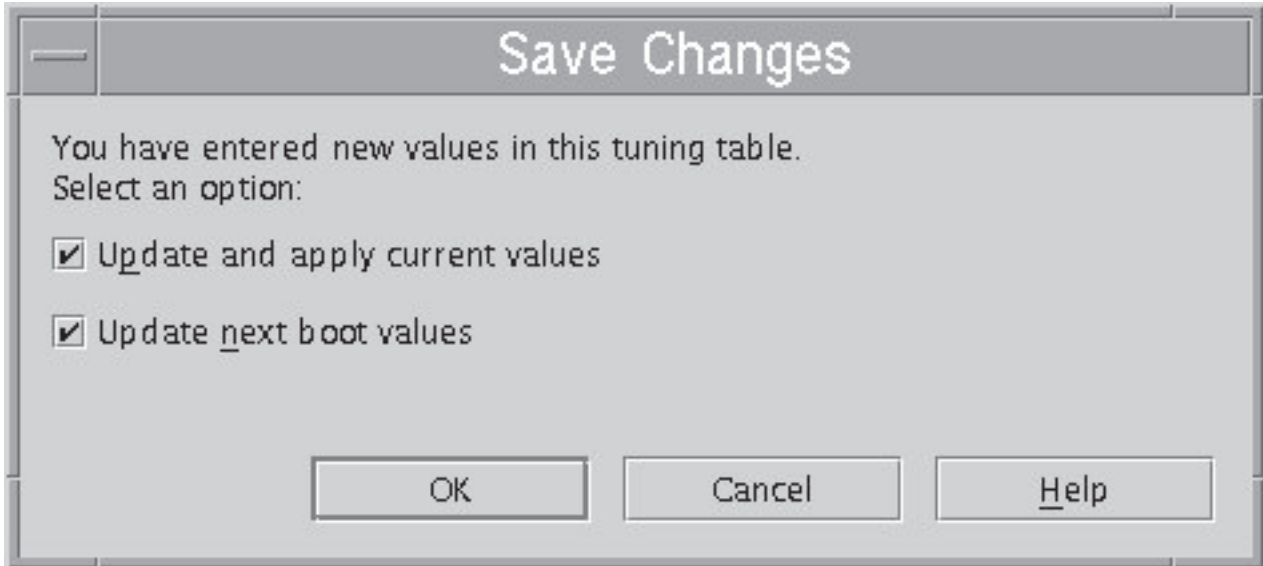

Figure 38. Save Changes dialog

- Selecting **Update and apply current values** and clicking **OK**, launches the tuning command corresponding to the parameters shown in the table to make all the desired changes. Selecting **Default** in the combobox as the new value resets the parameter to its default value. If a parameter of type **Incremental** has a new value smaller than its current value, an error message will be displayed. If incompatible dependent parameter values or out of range values have been entered, an error message will also be displayed. All the acceptable changes will be made.
- Selecting **Update next boot values** and clicking **OK**, writes the desired changes to the `/etc/tunables/nextboot` file. If necessary, the user will be prompted to run **bosboot**. If incompatible dependent parameter values or out of range values have been entered, an error message will be displayed, and those parameter values will not be copied to the **nextboot** file.
- Selecting both options makes all the desired changes now and for the next reboot.

2. **Save Current Parameters for Next Boot**

A warning dialog is opened.

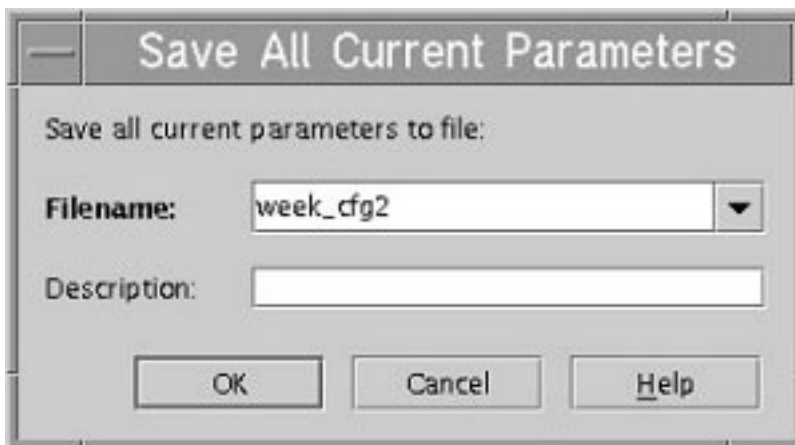

Figure 39. Save All Current Parameters to file dialog

After clicking **Yes**, all the current parameter values listed in the table will be saved in the `/etc/tunables/nextboot` file. If any parameter of type **Bosboot** needs to be changed, the user will be prompted to run **bosboot**.

3. Reset Parameters to System Default

This dialog allows resetting of current or next boot values for all the parameters listed in the table to their default value. Two options are available:

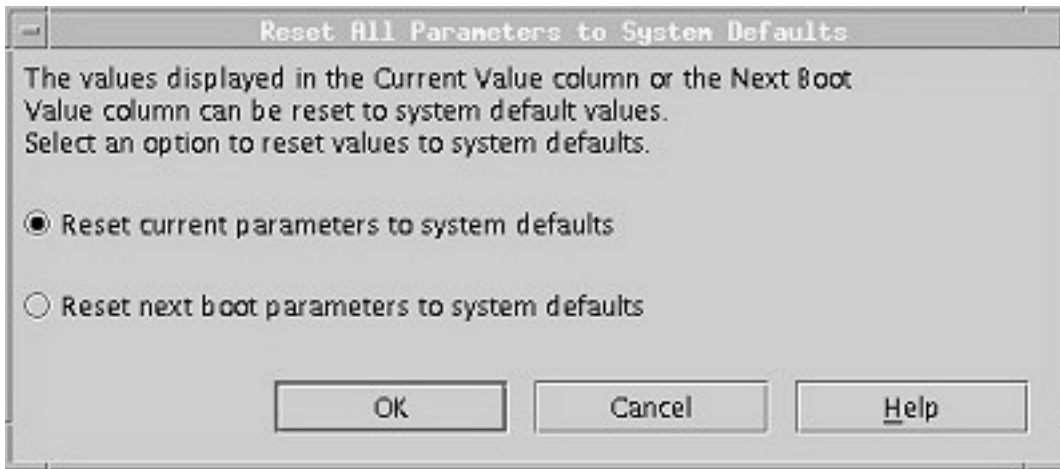

Figure 40. Reset All Parameters to System Defaults dialog

- Selecting **Reset current parameters to system default** and clicking **OK**, will reset all the tuning parameters listed in the table to their default value. If any parameter of type **Incremental**, **Bosboot** or **Reboot** should have been changed, an error message will be displayed and the parameter will not be changed.
- Selecting **Reset next boot parameters to system default** and clicking **OK** deletes the parameter listed in the table from the `/etc/tunables/nextboot` file. This action will defer changes until next reboot. If necessary, **bosboot** will be proposed.

Parameter Details

Clicking on **Parameter Details** in the toolbar or selecting the equivalent menu item, followed by a click on a parameter in the table will display the help information available in a help dialog..

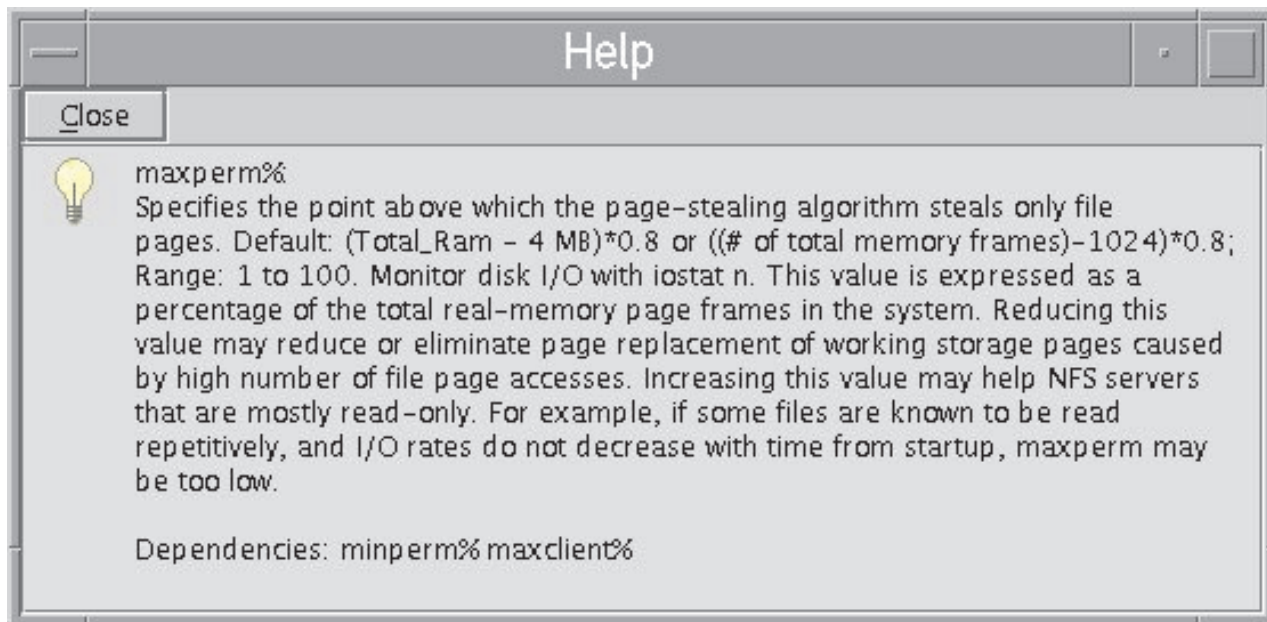

Figure 41. Help dialog

Files

<code>/etc/tunables/lastboot</code>	Contains tuning parameter stanzas from the last boot.
<code>/etc/tunables/lastboot.log</code>	Contains logging information from the last boot.
<code>/etc/tunables/nextboot</code>	Contains tuning parameter stanzas for the next system boot.

Related Information

The **bosboot**, **ioo**, **nfso**, **no**, **schedo**, **tunsave**, **tunrestore**, **tuncheck**, **tundefault**, and **vmo** commands.

The **tunables** file.

Chapter 8. The procmon tool

This topic provides detailed information about the **procmon** tool and contains the following sections:

- “Overview of the procmon tool”
- “Components of the procmon tool”
- “Filtering processes” on page 193
- “Performing AIX commands on processes” on page 194

Overview of the procmon tool

You can use the **procmon** tool on systems running AIX 5.3 or later. The **procmon** tool allows you to view and manage the processes running on a system. The **procmon** tool has a graphical interface and displays a table of process metrics that you can sort on the different fields that are provided. The default number of processes listed in the table is 20, but you can change the value in the **Table Properties** panel from the main menu. Only the top processes based on the sorting metric are displayed and the default sorting key is CPU consumption.

The default value of the refresh rate for the table of process metrics is 5 seconds, but you can change the refresh rate by either using the **Table Properties** panel in the main menu or by clicking on the **Refresh** button.

By default, the **procmon** tool displays the following:

- How long a process has been running
- How much CPU resource the processes are using
- Whether processes are being penalized by the system
- How much memory the processes are using
- How much I/O a process is performing
- The priority and nice values of a process
- Who has created a particular process

You can choose other metrics to display from the **Table Properties** panel in the main menu. For more information, see “The process table of the procmon tool” on page 192.

You can filter any of the processes that are displayed. For more information, see “Filtering processes” on page 193.

You can also perform certain AIX performance commands on these processes. For more information, see “Performing AIX commands on processes” on page 194.

The **procmon** tool is a Performance Workbench plugin, so you can only launch the **procmon** tool from within the Performance Workbench framework. You must install the **bos.perf.gtools** fileset by either using the **smitty** tool or the **installp** command. You can then access the Performance Workbench from the **/opt/perfwb** directory or run the **procmon** script from the **/opt/perfwb/procmon** directory.

Components of the procmon tool

The graphical interface of the **procmon** tool consists of the following components:

- “The global statistics area of the procmon tool” on page 192
- “The process table of the procmon tool” on page 192
- “The status line of the Performance Workbench” on page 193

The global statistics area of the procmon tool

The global statistics area is a table that is displayed at the top of the **procmon** tool window. The global statistics area displays the amount of CPU and memory that is being used by the system. You can refresh the statistics data by either clicking on the **Refresh** button in the menu bar or by activating the automatic refresh option through the menu bar. To save the statistics information, you can export the table to any of the following file formats:

- XML
- HTML
- CSV

The process table of the procmon tool

The process table is the main component of the **procmon** tool. The process table displays the various processes that are running on the system, ordered and filtered according to the user configuration. The default value of the number of processes listed in the process table is 20, but you can change this value from the **Table Properties** panel from the main menu.

The yellow arrow key in the column header indicates the sort key for the process table. The arrow points either up or down, depending on whether the sort order is ascending or descending, respectively. You can change the sort key by clicking on any of the column headers.

You can customize the process table, modify the information on the various processes, and run commands on the displayed processes. By default, the **procmon** tool displays the following columns:

PID	Process identifier
PPID	Parent process identifier
NICE	Nice value for the process
PRI	Priority of the process
COMMAND	Short name of the process launched
DRSS	Data resident set size
TRSS	Text resident set size
STARTTIME	Time when the command started
ELOGIN	Effective login of the process user
PRM	Percent real memory usage
CPUPER	Percentage of CPU used per process since the last refresh

You can choose to display other metrics, like the following:

EUID	Effective user identifier
RUID	Real user identifier
EGID	Effective group identifier
RGID	Real group identifier
THCOUNT	Number of threads used
CLASSID	Identifier of the class which pertains to the WLM process
CLASSNAME	Name of the class which pertains to the WLM process
TOTDISKIO	Disk I/O for that process
NVCSW	N voluntary context switches
NIVCSW	N involuntary context switches

MINFLT	Minor page faults
MAJFLT	Major page faults
INBLK	Input blocks
OUBLK	Output blocks
MSGSEND	Messages sent
MSGRECV	Messages received
EGROUP	Effective group name
RGROUP	Real group name

You can use either the table properties or preference to display the metrics you are interested in. If you choose to change the table properties, the new configuration values are set for the current session only. If you change the preferences, the new configuration values are set for the next session of the **procmon** tool.

There are two types of values listed in the process table:

- Real values
- Delta values

Real values are retrieved from the kernel and displayed in the process table. An example of a real value is the PID, PPID, or TTY.

Delta values are values that are computed from the last-stored measurements. An example of a delta value is the CPU percent for each process, which is computed using the values measured between refreshes.

Below the process table, there is another table that displays the sum of the values for each column of the process table. For example, this table might provide a good idea of the percentage of total CPU used by the top 20 CPU-consuming processes.

You can refresh the data by either clicking on the **Refresh** button in the menu bar or by activating the automatic refresh option through the menu bar. To save the statistics information, you can export the table to any of the following file formats:

- XML
- HTML
- CSV

The status line of the Performance Workbench

The Performance Workbench status line displays the date on which the information was retrieved, as well as the name of the system. The status line is hidden if you activate another view or perspective, but automatically reappears if you refresh the information.

Filtering processes

You can filter processes based on the various criteria that is displayed in the process table. To create a filter, select **Table Filters** from the menu bar. A new window opens and displays a list of filters.

Performing AIX commands on processes

You can run the following AIX commands on the processes you select in the process table:

- The **svmon** command
- The **renice** command
- The **kill** command
- The following **proctools** commands:
 - The **procfiles** command
 - The **proctree** command
 - The **procsig** command
 - The **procstack** command
 - The **procrun** command
 - The **procmmap** command
 - The **proclags** command
 - The **proccred** command
 - The **procldd** command

To run any of the above commands on one or more processes, select the processes in the process table and right click your mouse, and select either **Commands** or **Modify** and then select the command you want to run. A new window opens, which displays the command output while the command is running. You can interrupt the command by clicking on the **STOP** button.

Chapter 9. Profiling tools

You can use profiling tools to identify which portions of the program are executed most frequently or where most of the time is spent. Profiling tools are typically used after a basic tool, such as the **vmstat** or **iostat** commands, shows that a CPU bottleneck is causing a performance problem.

Before you begin locating hot spots in your program, you need a fully functional program and realistic data values.

The following is a list of the profiling tools you can use:

- Chapter 2, “X-Windows Performance Profiler (Xprofiler),” on page 3
- “The timing commands”
- “The prof command”
- “The gprof command” on page 197
- “The tprof command” on page 199

The timing commands

Use the timing commands discussed in Using the time command to measure CPU use for testing and debugging programs whose performance you are recording and trying to improve.

The output from the **time** command is in minutes and seconds, as follows:

```
real    0m26.72s
user    0m26.53s
sys     0m0.03s
```

The output from the **timex** command is in seconds, as follows:

```
real 26.70
user 26.55
sys  0.02
```

Comparing the user+sys CPU time to the real time will give you an idea if your application is CPU-bound or I/O-bound.

Note: Be careful when you do this on an SMP system. For more information, see time and timex Cautions).

The **timex** command is also available through the SMIT command on the Analysis Tools menu, found under Performance and Resource Scheduling. The **-p** and **-s** options of the **timex** command allow data from accounting (**-p**) and the sar command (**-s**) to be accessed and reported. The **-o** option reports on blocks read or written.

The prof command

The **prof** command displays a profile of CPU usage for each external symbol, or routine, of a specified program. In detail, it displays the following:

- The percentage of execution time spent between the address of that symbol and the address of the next
- The number of times that function was called
- The average number of milliseconds per call

The **prof** command interprets the profile data collected by the **monitor()** subroutine for the object file (**a.out** by default), reads the symbol table in the object file, and correlates it with the profile file (**mon.out** by default) generated by the **monitor()** subroutine. A usage report is sent to the terminal, or can be redirected to a file.

To use the **prof** command, use the **-p** option to compile a source program in C, FORTRAN, PASCAL, or COBOL. This inserts a special profiling startup function into the object file that calls the **monitor()** subroutine to track function calls. When the program is executed, the **monitor()** subroutine creates a **mon.out** file to track execution time. Therefore, only programs that explicitly exit or return from the main program cause the **mon.out** file to be produced. Also, the **-p** flag causes the compiler to insert a call to the **mcount()** subroutine into the object code generated for each recompiled function of your program. While the program runs, each time a parent calls a child function, the child calls the **mcount()** subroutine to increment a distinct counter for that parent-child pair. This counts the number of calls to a function.

Note: You cannot use the **prof** command for profiling optimized code.

By default, the displayed report is sorted by decreasing percentage of CPU time. This is the same as when specifying the **-t** option.

The **-c** option sorts by decreasing number of calls and the **-n** option sorts alphabetically by symbol name.

If the **-s** option is used, a summary file **mon.sum** is produced. This is useful when more than one profile file is specified with the **-m** option (the **-m** option specifies files containing monitor data).

The **-z** option includes all symbols, even if there are zero calls and time associated.

Other options are available and explained in the **prof** command in the *AIX 5L Version 5.3 Commands Reference*.

The following example shows the first part of the **prof** command output for a modified version of the Whetstone benchmark (Double Precision) program.

```
# cc -o cwhet -p -lm cwhet.c
# cwhet > cwhet.out
# prof
Name                %Time    Seconds    Cumsecs    #Calls    msec/call
.main                32.6      17.63      17.63      1          17630.
.__mcount            28.2      15.25      32.88
.mod8                 16.3      8.82       41.70     8990000    0.0010
.mod9                 9.9       5.38       47.08     6160000    0.0009
.cos                  2.9       1.57       48.65     1920000    0.0008
.exp                  2.4       1.32       49.97     930000     0.0014
.log                  2.4       1.31       51.28     930000     0.0014
.mod3                 1.9       1.01       52.29     140000     0.0072
.sin                  1.2       0.63       52.92     640000     0.0010
.sqrt                 1.1       0.59       53.51
.atan                 1.1       0.57       54.08     640000     0.0009
.pout                 0.0       0.00       54.08      10         0.0
.exit                 0.0       0.00       54.08      1          0.
.free                 0.0       0.00       54.08      2          0.
.free_y              0.0       0.00       54.08      2          0.
```

In this example, we see many calls to the **mod8()** and **mod9()** routines. As a starting point, examine the source code to see why they are used so much. Another starting point could be to investigate why a routine requires so much time.

Note: If the program you want to monitor uses a **fork()** system call, be aware that the parent and the child create the same file (**mon.out**). To avoid this problem, change the current directory of the child process.

The gprof command

The **gprof** command produces an execution profile of C, PASCAL, FORTRAN, or COBOL programs. The statistics of called subroutines are included in the profile of the calling program. The **gprof** command is useful in identifying how a program consumes CPU resources. It is roughly a superset of the **prof** command, giving additional information and providing more visibility to active sections of code.

Implementation of the gprof command

The source code must be compiled with the **-pg** option. This action links in versions of library routines compiled for profiling and reads the symbol table in the named object file (**a.out** by default), correlating it with the call graph profile file (**gmon.out** by default). This means that the compiler inserts a call to the **mcount()** function into the object code generated for each recompiled function of your program. The **mcount()** function counts each time a parent calls a child function. Also, the **monitor()** function is enabled to estimate the time spent in each routine.

The **gprof** command generates two useful reports:

- The call-graph profile, which shows the routines, in descending order by CPU time, plus their descendants. The profile allows you to understand which parent routines called a particular routine most frequently and which child routines were called by a particular routine most frequently.
- The flat profile of CPU usage, which shows the usage by routine and number of calls, similar to the **prof** output.

Each report section begins with an explanatory part describing the output columns. You can suppress these pages by using the **-b** option.

Use **-s** for summaries and **-z** to display routines with zero usage.

Where the program is executed, statistics are collected in the **gmon.out** file. These statistics include the following:

- The names of the executable program and shared library objects that were loaded
- The virtual memory addresses assigned to each program segment
- The **mcount()** data for each parent-child
- The number of milliseconds accumulated for each program segment

Later, when the **gprof** command is issued, it reads the **a.out** and **gmon.out** files to generate the two reports. The call-graph profile is generated first, followed by the flat profile. It is best to redirect the **gprof** output to a file, because browsing the flat profile first may answer most of your usage questions.

The following example shows the profiling for the **cwhet** benchmark program. This example is also used in “The prof command” on page 195:

```
# cc -o cwhet -pg -lm cwhet.c
# cwhet > cwhet.out
# gprof cwhet > cwhet.gprof
```

The call-graph profile

The call-graph profile is the first part of the **cwhet.gprof** file and looks similar to the following:

granularity: each sample hit covers 4 byte(s) Time: 62.85 seconds

index	%time	self	descendents	called/total	parents	index
				called+self called/total		
		19.44	21.18	1/1	._start	[2]
[1]	64.6	19.44	21.18	1	.main	[1]
		8.89	0.00	8990000/8990000	.mod8	[4]

```

5.64      0.00 6160000/6160000    .mod9 [5]
1.58      0.00 930000/930000      .exp [6]
1.53      0.00 1920000/1920000   .cos [7]
1.37      0.00 930000/930000      .log [8]
1.02      0.00 140000/140000     .mod3 [10]
0.63      0.00 640000/640000     .atan [12]
0.52      0.00 640000/640000     .sin [14]
0.00      0.00      10/10      .pout [27]

```

```

-----
[2]      64.6   0.00   40.62      <spontaneous>
          19.44  21.18      1/1      .__start [2]
          0.00   0.00      1/1      .main [1]
          .exit [37]
-----

```

Usually the call graph report begins with a description of each column of the report, but it has been deleted in this example. The column headings vary according to type of function (current, parent of current, or child of current function). The current function is indicated by an index in brackets at the beginning of the line. Functions are listed in decreasing order of CPU time used.

To read this report, look at the first index [1] in the left-hand column. The `.main` function is the current function. It was started by `.__start` (the parent function is on top of the current function), and it, in turn, calls `.mod8` and `.mod9` (the child functions are beneath the current function). All the accumulated time of `.main` is propagated to `.__start`. The `self` and `descendents` columns of the children of the current function add up to the `descendents` entry for the current function. The current function can have more than one parent. Execution time is allocated to the parent functions based on the number of times they are called.

Flat profile

The flat profile sample is the second part of the `cwhtet.gprof` file and looks similar to the following:

granularity: each sample hit covers 4 byte(s) Total time: 62.85 seconds

% time	cumulative seconds	self seconds	self calls	self ms/call	total ms/call	name
30.9	19.44	19.44	1	19440.00	40620.00	.main [1]
30.5	38.61	19.17				.__mcount [3]
14.1	47.50	8.89	8990000	0.00	0.00	.mod8 [4]
9.0	53.14	5.64	6160000	0.00	0.00	.mod9 [5]
2.5	54.72	1.58	930000	0.00	0.00	.exp [6]
2.4	56.25	1.53	1920000	0.00	0.00	.cos [7]
2.2	57.62	1.37	930000	0.00	0.00	.log [8]
2.0	58.88	1.26				.qincrement [9]
1.6	59.90	1.02	140000	0.01	0.01	.mod3 [10]
1.2	60.68	0.78				.__stack_pointer [11]
1.0	61.31	0.63	640000	0.00	0.00	.atan [12]
0.9	61.89	0.58				.qincrement1 [13]
0.8	62.41	0.52	640000	0.00	0.00	.sin [14]
0.7	62.85	0.44				.sqrt [15]
0.0	62.85	0.00	180	0.00	0.00	.fwrite [16]
0.0	62.85	0.00	180	0.00	0.00	.memchr [17]
0.0	62.85	0.00	90	0.00	0.00	.__f1sbuf [18]
0.0	62.85	0.00	90	0.00	0.00	._f1sbuf [19]

The flat profile is much less complex than the call-graph profile and very similar to the output of the `prof` command. The primary columns of interest are the `self seconds` and the `calls` columns. These reflect the CPU seconds spent in each function and the number of times each function was called. The next columns to look at are `self ms/call` (CPU time used by the body of the function itself) and `total ms/call` (time in the body of the function plus any descendent functions called).

Normally, the top functions on the list are candidates for optimization, but you should also consider how many calls are made to the function. Sometimes it can be easier to make slight improvements to a frequently called function than to make extensive changes to a piece of code that is called once.

A cross reference index is the last item produced and looks similar to the following:

Index by function name

[18] .__flsbuf	[37] .exit	[5] .mod9
[34] .__ioctl	[6] .exp	[43] .moncontrol
[20] .__mcount	[39] .expand_catname	[44] .monitor
[3] .__mcount	[32] .free	[22] .myecvt
[23] .__nl_langinfo_std	[33] .free_y	[28] .nl_langinfo
[11] .__stack_pointer	[16] .fwrite	[27] .pout
[24] .__doprnt	[40] .getenv	[29] .printf
[35] .__findbuf	[41] .ioctl	[9] .qincrement
[19] .__flsbuf	[42] .isatty	[13] .qincrement1
[36] .__wrtchk	[8] .log	[45] .saved_category_nam
[25] .__xflsbuf	[1] .main	[46] .setlocale
[26] .__xwrite	[17] .memchr	[14] .sin
[12] .atan	[21] .mf2x2	[31] .splay
[38] .catopen	[10] .mod3	[15] .sqrt
[7] .cos	[4] .mod8	[30] .write

Note: If the program you want to monitor uses a **fork()** system call, be aware that by default, the parent and the child create the same file, **gmon.out**. To avoid this problem, use the GPROF environment variable. You can also use the GPROF environment variable to profile multi-threaded applications.

The tprof command

The typical program execution is a variable combination of application code, library subroutines, and kernel services. Frequently, programs that have not been tuned expend most of their CPU cycles in certain statements or subroutines. You can determine which particular statements or subroutines to examine with the **tprof** command.

The **tprof** command is a versatile profiler that provides a detailed profile of CPU usage by every process ID and name. It further profiles at the application level, routine level, and even to the source statement level and provides both a global view and a detailed view. In addition, the **tprof** command can profile kernel extensions, stripped executable programs, and stripped libraries. It does subroutine-level profiling for most executable programs on which the **stripnm** command produces a symbols table. The **tprof** command can profile any program produced by any of the following compilers:

- C
- C++
- FORTRAN

The **tprof** command only profiles CPU activity. It does not profile other system resources, such as memory or disks

You can use the following types of profiling with the **tprof** command:

- “Time-based profiling”
- “Event-based profiling”

Time-based profiling

Time-based profiling is the default profiling mode and it is triggered by the decremter interrupt, which occurs every 10 milliseconds. With time-based profiling, the **tprof** command cannot determine the address of a routine when interrupts are disabled. While interrupts are disabled, all ticks are charged to the **unlock_enable()** routines.

Event-based profiling

Event-based profiling is triggered by any one of the software-based events or any Performance Monitor event that occurs on the processor. The primary advantages of event-based profiling over time-based profiling are the following:

- The routine addresses are visible when interrupts are disabled.
- The ability to vary the profiling event
- The ability to vary the sampling frequency

With event-based profiling, ticks that occur while interrupts are disabled are charged to the proper routines. Also, you can select the profiling event and sampling frequency. The profiling event determines the trigger for the interrupt and the sampling frequency determines how often the interrupt occurs. After the specified number of occurrences of the profiling event, an interrupt is generated and the executing instruction is recorded.

Note: Event-based profiling is not supported in manual offline mode.

The default type of profiling event is processor cycles. The various types of software-based events include the following:

- Emulation interrupts (EMULATION)
- Alignment interrupts (ALIGNMENT)
- Instruction Segment Lookaside Buffer misses (ISLBMISS)
- Data Segment Lookaside Buffer misses (DSLBMIS)

The sampling frequency for the software-based events is specified in milliseconds and the supported range is 1 to 500 milliseconds. The default sampling frequency is 10 milliseconds.

The following command generates an interrupt every 5 milliseconds and retrieves the record for the last emulation interrupt:

```
# tprof -E EMULATION -f 5
```

The following command generates an interrupt every 100 milliseconds and records the contents of the Sampled Instruction Address Register, or SIAR:

```
# tprof -E -f 100
```

The other types of profiling events, the Performance Monitor events, include the following:

- Completed instructions
- Cache misses

For a list of all the Performance Monitor events that are supported on the processors of the system, use the **pmlist** command. The sampling frequency for these events is specified in the number of occurrences of the event. The supported range is 10,000 to MAXINT occurrences. The default sampling frequency is 10,000 occurrences.

The following command generates an interrupt after the processor completes 50,000 instructions:

```
# tprof -E PM_INST_CMPL -f 50000
```

Event-based profiling uses the SIAR, which contains the address of an instruction close to the executing instruction. For example, if the profiling event is PM_FPU0_FIN, which means the floating point unit 0 produces a result, the SIAR might not contain that floating point instruction but might contain another instruction close to it. This is more relevant for profiling based on Performance Monitor events. In fact for the proximity reason, on systems based on POWER4 and later, it is recommended that the Performance Monitor profiling event be one of the marked events. Marked events have the **PM_MRK** prefix.

Certain combinations of profiling event, sampling frequency, and workload might cause interrupts to occur at such a rapid rate that the system spends most of its time in the interrupt handler. The **tprof** command detects this condition by keeping track of the number of completed instructions between two consecutive

interrupts. When the **tprof** command detects five occurrences of the count falling below the acceptable limit, the trace collection stops. Reports are still generated and an error message is displayed. The default threshold is 1,000 instructions.

Implementation of the tprof command

The **tprof** command uses the system trace facility. Since you can only execute the trace facility one user at a time, you can only execute one **tprof** command at a time.

You can obtain the raw data for the **tprof** command through the trace facility. For more information about the trace facility, see *Analyzing Performance with the Trace Facility in the AIX 5L Version 5.3 Performance Management Guide*.

When a program is profiled, the trace facility is activated and instructed to collect data from the trace hook with hook ID 234 that records the contents of the Instruction Address Register, or IAR, when a system-clock interrupt occurs (100 times a second per processor). Several other trace hooks are also activated to allow the **tprof** command to track process and dispatch activity. The trace records are not written to a disk file. They are written to a pipe that is read by a program that builds a table of the unique program addresses that have been encountered and the number of times each one occurred. When the workload being profiled is complete, the table of addresses and their occurrence counts are written to disk. The data-reduction component of the **tprof** command then correlates the instruction addresses that were encountered with the ranges of addresses occupied by the various programs and reports the distribution of address occurrences, or *ticks*, across the programs involved in the workload.

The distribution of ticks is roughly proportional to the CPU time spent in each program, which is 10 milliseconds per tick. After the high-use programs are identified, you can take action to restructure the hot spots or minimize their use.

An example of the tprof command

You can view the complete details of the **tprof** command in *AIX 5L Version 5.3 Commands Reference*.

The following example demonstrates how to collect a CPU tick profile of a program using the **tprof** command. The example was executed on a 4-way SMP system and since it is a fast-running system, the command completed in less than a second. To make this program run longer, the array size, or *Asize*, was changed to 4096 instead of 1024.

Upon running the following command, the **version1.prof** file is created in the current directory:

```
# tprof -z -u -p version1 -x version1
```

The **version1.prof** file reports how many CPU ticks for each of the programs that were running on the system while the **version1** program was running.

The following is an example of what the **version1.prof** file contains:

Process	Freq	Total	Kernel	User	Shared	Other
wait	4	5810	5810	0	0	0
./version1	1	1672	35	1637	0	0
/usr/bin/tprof	2	15	13	0	2	0
/etc/syncd	1	2	2	0	0	0
/usr/bin/sh	2	2	2	0	0	0
swapper	1	1	1	0	0	0
/usr/bin/trcstop	1	1	1	0	0	0
rmcd	1	1	1	0	0	0
Total	13	7504	5865	1637	2	0

Process	PID	TID	Total	Kernel	User	Shared	Other
====	===	===	=====	=====	=====	=====	=====

wait	16392	16393	1874	1874	0	0	0
wait	12294	12295	1873	1873	0	0	0
wait	20490	20491	1860	1860	0	0	0
./version1	245974	606263	1672	35	1637	0	0
wait	8196	8197	203	203	0	0	0
/usr/bin/tprof	291002	643291	13	13	0	0	0
/usr/bin/tprof	274580	610467	2	0	0	2	0
/etc/syncd	73824	110691	2	2	0	0	0
/usr/bin/sh	245974	606263	1	1	0	0	0
/usr/bin/sh	245976	606265	1	1	0	0	0
/usr/bin/trcstop	245976	606263	1	1	0	0	0
swapper	0	3	1	1	0	0	0
rmcd	155876	348337	1	1	0	0	0
=====	===	===	=====	=====	=====	=====	=====
Total			7504	5865	1637	2	0

Total Samples = 7504 Total Elapsed Time = 18.76s

Profile: ./version1

Total Ticks For All Processes (./version1) = 1637

Subroutine	Ticks	%	Source	Address	Bytes
=====	=====	=====	=====	=====	=====
.main	1637	21.82	version1.c	350	536

Profile: ./version1

Total Ticks For ./version1[245974] (./version1) = 1637

Subroutine	Ticks	%	Source	Address	Bytes
=====	=====	=====	=====	=====	=====
.main	1637	21.82	version1.c	350	536

The first section of the report summarizes the results by program, regardless of the process ID, or PID. It shows the number of different processes, or Freq, that ran each program at some point.

The second section of the report displays the number of ticks consumed by, or on behalf of, each process. In the example, the **version1** program used 1637 ticks itself and 35 ticks occurred in the kernel on behalf of the **version1** process.

The third section breaks down the user ticks associated with the executable program being profiled. It reports the number of ticks used by each function in the executable program and the percentage of the total run's CPU ticks (7504) that each function's ticks represent. Since the system's CPUs were mostly idle, most of the 7504 ticks are idle ticks.

To see what percentage of the busy time this program took, subtract the wait thread's CPU ticks, which are the idle CPU ticks, from the total and then divide the difference from the total number of ticks.

```
Total number of ticks / (Total - Idle CPU ticks) = % busy time of program
1637 / (7504 - 5810) =
1637 / 1694 = 0.97
```

So, the percentage of system busy ticks is 97%.

The raso tunables

As the root user, you can tune the sampling frequency with the following **raso** tunables:

- **tprof_cyc_mult**
- **tprof_evt_mult**

For example, for events based on processor cycles, setting the **tprof_cyc_mult** tunable to 50 and specifying the **-f** flag as 100 is equivalent to specifying a sampling frequency of 100/50 milliseconds.

For other Performance Monitor events, setting the **tprof_evt_mult** tunable to 100 and specifying the **-f** flag as 20,000 is equivalent to specifying a sampling frequency of 20,000/100 occurrences.

As the root user, you can tune the instruction threshold with the **tprof_inst_threshold** tunable of the **raso** command.

Manual offline processing with the tprof command

You can perform offline processing of trace files with the **tprof** command, but you must specify filenames with a *rootstring* name. Also, there are certain suffixes required for the input files that the **tprof** command uses. For example, the trace binary file must end in *.trc*. Also, you need to collect the **gensyms** command output and put it in a file called the **rootstring.syms** file.

If you name the *rootstring* file **trace1**, to collect a trace, you can use the **trace** command using all of the hooks or at least the following hooks:

```
# trace -af -T 1000000 -L 10000000 -o trace1.trc -j tprof
# workload
# trcoff
# gensyms > trace1.syms
# trcstop
# trcrpt -r trace1 -k -u -s -z
```

The example above creates a **trace1.prof** file, which gives you a CPU profile of the system while the **trace** command was running.

Index

A

- a.out file 6
- about this book v
- API calls
 - basic
 - pm_delete_program 119
 - pm_get_data 119
 - pm_get_program 119
 - pm_get_tdata 119
 - pm_reset_data 119
 - pm_set_program 119
 - pm_start 119
 - pm_stop 119
- applications
 - compiling for Xprofiler 4

B

- binary executable
 - specifying from Xprofiler GUI 12

C

- Call Graph Profile report 43
- calls between functions, how depicted 24
- clustering functions 33
- clusters, library 25
- code
 - disassembler
 - viewing 52
 - source
 - viewing 50
- command-line flags
 - specifying from Xprofiler GUI 14
 - Xprofiler 6
- commands
 - gprof 197
 - prof 195
 - tprof 199
- configuration files
 - saving 49
- configuration files
 - loading 50
- controlling how the display is updated 25
- CPU Utilization Reporting Tool
 - see curt 63
- curt 63
 - Application Pthread Summary (by PID) Report 75
 - Application Summary (by process type) Report 74
 - Application Summary by Process ID (PID) Report 73
 - Application Summary by Thread ID (Tid) Report 72
- default reports 67
- Event Explanation 64
- Event Name 64
- examples 65
- FILH Summary Report 80

- curt (*continued*)
 - flags 63
 - FLIH types 81
 - General Information 68
 - Global SLIH Summary Report 81
 - Hook ID 64
 - Kproc Summary (by Tid) Report 74
 - measurement and sampling 64
 - parameters
 - gensymsfile 63
 - inputfile 63
 - outputfile 63
 - pidnamefile 63
 - timestamp 63
 - trcnmfile 63
 - Pending Pthread Calls Summary Report 80
 - Pending System Calls Summary Report 76
 - Processor Summary Report 70
 - Pthread Calls Summary Report 79
 - report overview 65
 - sample report
 - e flag 82
 - p flag 87
 - P flag 90
 - s flag 84
 - t flag 84
 - syntax 63
 - System Calls Summary Report 76
 - System Summary Report 68
- customizable resources
 - Xprofiler 56

D

- data
 - basic 37
 - detailed 41
 - getting from reports 41
 - performance 37
- disassembler code
 - viewing 52
- disk space requirements 5
- display
 - Xprofiler 20

E

- examples
 - performance monitor APIs 121

F

- features
 - X-Windows
 - customizing 56

- file
 - binary executable
 - specifying from Xprofiler GUI 12
 - profile data
 - specifying from Xprofiler GUI 13
- files
 - loading from Xprofiler GUI 10
- filtering, function call tree 27
- finding objects in call tree 35
- flags
 - specifying from Xprofiler GUI 14
 - Xprofiler 6
- Flat Profile report 42
- function call tree
 - clustering 32
 - controlling graphic style 25
 - controlling orientation of 25
 - controlling representation of 26
 - displaying 28
 - excluding specific objects 28
 - filtering 27
 - including specific objects 28
 - restoring 27
- Function Index report 45
- functions, how depicted 22

G

- gennames utility 98
- Global Actions on Tunable Parameters 181
- gmon.out file 6
- gprof
 - and Xprofiler 4

I

- info stanza 166
- installp 5
- introduction 1
- iso 9000 v

K

- kernel tuning 165
 - attributes
 - pre520tune 165
 - commands 165
 - flags 167
 - tunchange 169
 - tuncheck 170
 - tundefault 172
 - tunrestore 171
 - tunsave 171
 - commands syntax 167
 - file manipulation commands 169
 - initial setup 172
 - introduction 165, 179
 - migration and compatibility 165
 - reboot tuning procedures 173
 - recovery procedure 173
 - SMIT interface 173

- kernel tuning (*continued*)
 - tunable parameters 165
 - tunables file directory 166
 - tunables parameters
 - type 167
 - Web-based System Manager 179

L

- lastboot 166
- lastboot.log 166
- library clusters 25
- Library Statistics report 47
- limitations
 - Xprofiler 3
- locating objects in call tree 35

N

- nextboot 166

O

- objects, locating in call tree 35

P

- parameter details 188
- performance data, getting 37
- performance monitor API
 - accuracy 115
 - common rules 117
 - context and state 116
 - state inheritance 116
 - system level context 116
 - thread context 116
 - thread counting-group and process context 116
 - programming 115
 - security considerations 117
 - thread accumulation 117
 - thread group accumulation 117
- performance monitor plug-in 179
- perfstat 133
 - characteristics 133
 - component-specific interfaces 143
 - global interfaces 133
 - perfstat_cpu interface 144
 - perfstat_cpu_total Interface 134
 - perfstat_disk interface 145
 - perfstat_disk_total Interface 137
 - perfstat_diskadapter interface 148
 - perfstat_diskpath interface 147
 - perfstat_memory_total Interface 136
 - perfstat_netbuffer interface 154
 - perfstat_netinterface interface 149
 - perfstat_netinterface_total Interface 138
 - perfstat_pagingspace interface 156
 - perfstat_partition_total Interface 139
 - perfstat_protocol interface 151

- perfstat API programming
 - see perfstat 133
- Plug-In for Web-based System Manager System
 - Tuning 179
- pm_delete_program 117
- pm_error 117
- pm_groups_info_t 118
- pm_info_t 118
- pm_init API initialization 118
- pm_initialize 117
- pm_initialize API initialization 119
- pm_set_program 117
- pmapi library 117
- procmon tool 191
- profile data files
 - specifying from Xprofiler GUI 13
- profiled data
 - saving screen images of 54
- profiling 195
- programs
 - compiling for Xprofiler 4

R

- reboot procedure 173
- recovery procedure 173
- related publications v
- release specific features 160
- reports
 - Call Graph Profile 43
 - Flat Profile 42
 - Function Index 45
 - getting data from 41
 - Library Statistics 47
 - saving to a file 48
- requirements
 - Xprofiler 3
- resource settings
 - Xprofiler 56
- resource variables
 - Xprofiler 57
- resources
 - Xprofiler
 - customizing 56
- resources, customizable
 - Xprofiler 56

S

- screen images
 - saving 54
- search file sequence
 - setting 19
- settings, resource
 - Xprofiler 56
- simple performance lock analysis tool (splat)
 - see splat 95
- SMIT Interface 173
- software requirements 5
- source code
 - viewing 50

- splat 95
 - address-to-name resolution 98
 - AIX kernel lock details 101
 - command syntax 95
 - flags 95
 - condition-variable report 112
 - event explanation 96
 - event name 96
 - execution, trace, and analysis intervals 97
 - hook ID 96
 - measurement and sampling 96
 - mutex function detail 110
 - mutex pthread detail 110
 - mutex reports 108
 - parameters 95
 - PThread synchronizer reports 108
 - read/write lock reports 111
 - reports 98
 - execution summary 98
 - gross lock summary 99
 - per-lock summary 100
 - simple and runQ lock details 102, 104
 - trace discontinuities 97

T

- text highlighting v
- thread counting-group information 120
 - consistency flag 120
 - member count 120
 - process flag 120
- timing commands 195
- tunable parameters
 - global actions 181
- tunables 166
- tuncheck 166
- tundefault 166
- tuning tables
 - actions 186
 - using 184
- tunrestore 166
- tunsave 166

U

- unclustering functions 34

V

- variables, resource
 - Xprofiler 57

X

- X-Windows
 - features
 - customizing 56
- X-Windows Performance Profiler (Xprofiler)
 - see Xprofiler 3
- Xprofiler 3

- Xprofiler (*continued*)
 - about 3
 - and gprof 4
 - before you begin 3
 - binary executable file
 - specifying 12
 - command-line flags 6
 - specifying from GUI 14
 - compiling applications for 4
 - controlling fonts 57
 - customizable resources 56
 - display 20
 - file menu
 - controlling variables 58
 - files and directories created 6
 - filter menu
 - controlling variables 60
 - hidden menus 22
 - how installation alters system 6
 - installing 5
 - using SMIT 5
 - limitations 3, 5
 - loading files from GUI 10
 - main menus 21
 - main window 20, 57
 - profile data files
 - specifying 13
 - requirements 3
 - resource settings 56
 - resource variables 57
 - resources
 - customizing 56
 - screen dump
 - controlling variables 58
 - setting search file sequence 19
 - starting 6
 - view menu
 - controlling variables 60
- Xprofiler installation information 4
- Xprofiler preinstallation information 5

Vos remarques sur ce document / Technical publication remark form

Titre / Title : Bull Performance Tools Guide and Reference

N° Référence / Reference N° : 86 A2 55EM 01

Daté / Dated : October 2005

ERREURS DETECTEES / ERRORS IN PUBLICATION

AMELIORATIONS SUGGEREES / SUGGESTIONS FOR IMPROVEMENT TO PUBLICATION

Vos remarques et suggestions seront examinées attentivement.

Si vous désirez une réponse écrite, veuillez indiquer ci-après votre adresse postale complète.

Your comments will be promptly investigated by qualified technical personnel and action will be taken as required.

If you require a written reply, please furnish your complete mailing address below.

NOM / NAME : _____ Date : _____

SOCIETE / COMPANY : _____

ADRESSE / ADDRESS : _____

Remettez cet imprimé à un responsable BULL ou envoyez-le directement à :

Please give this technical publication remark form to your BULL representative or mail to:

**BULL CEDOC
357 AVENUE PATTON
B.P.20845
49008 ANGERS CEDEX 01
FRANCE**

Technical Publications Ordering Form

Bon de Commande de Documents Techniques

To order additional publications, please fill up a copy of this form and send it via mail to:

Pour commander des documents techniques, remplissez une copie de ce formulaire et envoyez-la à :

BULL CEDOC

ATTN / Mr. L. CHERUBIN
357 AVENUE PATTON
B.P.20845
49008 ANGERS CEDEX 01
FRANCE

Phone / Téléphone : +33 (0) 2 41 73 63 96
FAX / Télécopie +33 (0) 2 41 73 60 19
E-Mail / Courrier Electronique : srv.Cedoc@franp.bull.fr

Or visit our web sites at: / Ou visitez nos sites web à:

<http://www.logistics.bull.net/cedoc>

<http://www-frec.bull.com> <http://www.bull.com>

CEDOC Reference # N° Référence CEDOC	Qty Qté	CEDOC Reference # N° Référence CEDOC	Qty Qté	CEDOC Reference # N° Référence CEDOC	Qty Qté
____ _ [__]		____ _ [__]		____ _ [__]	
____ _ [__]		____ _ [__]		____ _ [__]	
____ _ [__]		____ _ [__]		____ _ [__]	
____ _ [__]		____ _ [__]		____ _ [__]	
____ _ [__]		____ _ [__]		____ _ [__]	
____ _ [__]		____ _ [__]		____ _ [__]	
____ _ [__]		____ _ [__]		____ _ [__]	
[__] : no revision number means latest revision / pas de numéro de révision signifie révision la plus récente					

NOM / NAME : _____ Date : _____

SOCIETE / COMPANY : _____

ADRESSE / ADDRESS : _____

PHONE / TELEPHONE : _____ FAX : _____

E-MAIL : _____

For Bull Subsidiaries / Pour les Filiales Bull :

Identification: _____

For Bull Affiliated Customers / Pour les Clients Affiliés Bull :

Customer Code / Code Client : _____

For Bull Internal Customers / Pour les Clients Internes Bull :

Budgetary Section / Section Budgétaire : _____

For Others / Pour les Autres :

Please ask your Bull representative. / Merci de demander à votre contact Bull.

BULL CEDOC
357 AVENUE PATTON
B.P.20845
49008 ANGERS CEDEX 01
FRANCE

ORDER REFERENCE
86 A2 55EM 01