

# Site Preparation Guide

NOVASCALÉ



REFERENCE  
86 A1 87EF 10



# NOVASCALE

# Site Preparation Guide

## **Hardware**

January 2008

BULL CEDOC  
357 AVENUE PATTON  
B.P.20845  
49008 ANGERS CEDEX 01  
FRANCE

REFERENCE  
86 A1 87EF 10

The following copyright notice protects this book under Copyright laws which prohibit such actions as, but not limited to, copying, distributing, modifying, and making derivative works.

Copyright © Bull SAS 1992, 2008

Printed in France

Suggestions and criticisms concerning the form, content, and presentation of this book are invited. A form is provided at the end of this book for this purpose.

To order additional copies of this book or other Bull Technical Publications, you are invited to use the Ordering Form also provided at the end of this book.

### **Trademarks and Acknowledgements**

We acknowledge the rights of the proprietors of the trademarks mentioned in this manual.

All brand names and software and hardware product names are subject to trademark and/or patent protection.

Quoting of brand and product names is for information purposes only and does not represent trademark misuse.

*The information in this document is subject to change without notice. Bull will not be liable for errors contained herein, or for incidental or consequential damages in connection with the use of this material.*

---

# Preface

---

## Table of Contents

<b>Preface</b> .....	<b>iii</b>
Table of Contents .....	iii
List of Figures .....	v
List of Tables .....	vi
Intended Readers .....	vii
Definition of Safety Notices .....	vii
General Recommendations .....	viii
Regulatory Specifications and Disclaimers .....	ix
Environmental Standards .....	xi
<b>Chapter 1. General Requirements</b> .....	<b>1-1</b>
Server Cabinets .....	1-1
Delivery Conditions .....	1-2
Carry-In Route .....	1-2
Unpacking Requirements .....	1-3
<b>Chapter 2. Fitting out the Premises</b> .....	<b>2-1</b>
Data Processing Center Layout .....	2-1
Planning Installation .....	2-3
Cable Cut-outs .....	2-3
Power Cables .....	2-3
Network Cables .....	2-4
Service Clearance .....	2-5
Electrical / Electromagnetic Interference .....	2-7
Fire Protection .....	2-7
Fire Detection .....	2-7
Extinguishing Procedure .....	2-7
Extinguishing Agents .....	2-8
Alarms .....	2-8
Water Damage .....	2-8
Computer Room Floor .....	2-9
Primary Floor .....	2-9
Raised Floor .....	2-9
Computer Room Ceiling .....	2-10
Suspended Ceiling .....	2-10
Sound-Proofing .....	2-11
Protection from Sunlight .....	2-11
Cleaning .....	2-11
Media Storage Room .....	2-12
Paper Storage Room .....	2-12
Printing Room .....	2-12
Ancillary Equipment Room .....	2-12
<b>Chapter 3. Air-Conditioning</b> .....	<b>3-1</b>
Air-Conditioning System Features and Functions .....	3-1
Features .....	3-1

Functions .....	3-1
Air-Conditioning System Specifications .....	3-2
Air Renewal, Distribution, Circulation, Pollution, and Filtering .....	3-2
Checks and Alarms .....	3-5
<b>Chapter 4. Power Supply .....</b>	<b>4-1</b>
Power Supply .....	4-1
Cabling Requirements .....	4-2
Mounting Power Supply Cable Sockets .....	4-3
Grounding Circuit .....	4-5
Grounding the Raised Floor .....	4-5
Neutral Power System .....	4-6
Constructing a TN-S Neutral Point Connection System .....	4-6
Non-Computing Power Supply .....	4-8
<b>Appendix A. Specifications .....</b>	<b>A-1</b>
NovaScale Blade 2xxx Cabinet Specifications .....	A-2
NovaScale Blade Chassis (7U) Specifications .....	A-4
Bull Blade Chassis (9U) Specifications .....	A-5
NovaScale Blade 20xx Chassis Specifications .....	A-6
NovaScale Blade 2020 Server Specifications .....	A-7
NovaScale Blade 2021 Server Specifications .....	A-7
NovaScale Blade 2040 Server Specifications .....	A-7
NovaScale Blade 2320 Server Specifications .....	A-8
NovaScale B260 Server Specifications .....	A-8
NovaScale B260+ Server Specifications .....	A-8
NovaScale B280 Server Specifications .....	A-9
NovaScale 3005 Series Server Cabinet Specifications .....	A-10
Novascale 3025 Server CPU Drawer Specifications .....	A-12
NovaScale 3045 Server CPU Drawer Specifications .....	A-13
NovaScale 3045 COMPACT Server CPU Drawer Specifications .....	A-14
NovaScale 4020/4040 Server Cabinet Specifications .....	A-15
NovaScale 4020 Server CPU Drawer Specifications .....	A-17
NovaScale 4040 Server CPU Drawer Specifications .....	A-18
NovaScale R421 Server CPU Drawer Specifications .....	A-19
NovaScale R422 Server CPU Drawer Specifications .....	A-20
NovaScale Universal R421-E1 Server Drawer Specifications .....	A-21
NovaScale Universal R422-E1 /R422-INF-E1 Server Drawer Specifications .....	A-22
NovaScale Universal R423 Server Drawer Specifications .....	A-23
NovaScale Universal R425 Server Drawer Specifications .....	A-24
NovaScale 5080/5160/6080/6160 Specifications .....	A-25
NovaScale 5320/6320 Server Specifications .....	A-27
NovaScale 5085 Server Specifications .....	A-29
NovaScale 5165 Server Specifications .....	A-31
NovaScale 5245 Server Specifications .....	A-33
NovaScale 5325 Server Specifications .....	A-35
Smart UPS References .....	A-37
<b>Appendix B. Conversion Tables .....</b>	<b>B-1</b>
Imperial to Metric .....	B-1
Metric to Imperial .....	B-1
Celsius to Fahrenheit Conversion .....	B-1
Fahrenheit to Celsius Conversion .....	B-1
<b>Index .....</b>	<b>X-1</b>

---

## List of Figures

Figure 1.	Bull server cabinets .....	1-1
Figure 2.	Required unpacking area .....	1-3
Figure 3.	Recommended Data Processing Center layout .....	2-2
Figure 4.	Cabinet cable cut-outs .....	2-3
Figure 5.	Single cabinet service clearance .....	2-5
Figure 6.	Dual cabinet service clearance .....	2-5
Figure 7.	Layout grid .....	2-6
Figure 8.	Raised floor cross-section .....	2-9
Figure 9.	Raised floor structure .....	2-10
Figure 10.	Example of poor air distribution .....	3-3
Figure 11.	Example of obstacles that may obstruct air circulation .....	3-3
Figure 12.	Plug and socket .....	4-3
Figure 13.	US plug characteristics .....	4-3
Figure 14.	PDU/UPS Power socket .....	4-4
Figure 15.	Raised floor equipotentiality method .....	4-6
Figure 16.	Grounding circuit diagram for a TN-S neutral point connection .....	4-7

---

## List of Tables

Table 1.	NovaScale Blade 20xx cabinet specifications .....	A-3
Table 2.	NovaScale Blade Chassis 7U specifications .....	A-4
Table 3.	Bull Blade Chassis 9U specifications .....	A-5
Table 4.	NovaScale Blade 20xx Chassis specifications .....	A-6
Table 5.	NovaScale Blade 2020 Server specifications .....	A-7
Table 6.	NovaScale Blade 2021 Server specifications .....	A-7
Table 7.	NovaScale Blade 2040 Server specifications .....	A-7
Table 8.	NovaScale Blade 2320 Server specifications .....	A-8
Table 9.	NovaScale B260 Server specifications .....	A-8
Table 10.	NovaScale B260+ Server specifications .....	A-8
Table 11.	NovaScale B280 Server specifications .....	A-9
Table 12.	NovaScale 3005 Series Server Cabinet Specifications .....	A-11
Table 13.	NovaScale 3025 Server CPU drawer specifications .....	A-12
Table 14.	NovaScale 3045 Server CPU drawer specifications .....	A-13
Table 15.	NovaScale 3045 COMPACT Server CPU drawer specifications .....	A-14
Table 16.	NovaScale 4020/4040 Server cabinet specifications .....	A-16
Table 17.	NovaScale 4020 Server CPU drawer specifications .....	A-17
Table 18.	NovaScale 4040 Server CPU drawer specifications .....	A-18
Table 19.	NovaScale R421 Server CPU drawer specifications .....	A-19
Table 20.	NovaScale 422 Server CPU drawer specifications .....	A-20
Table 21.	NovaScale R421-E1 Server drawer specifications .....	A-21
Table 22.	NovaScale R422-E1 / R422-INF-E1 Server drawer specifications .....	A-22
Table 23.	NovaScale R423 Server drawer specifications .....	A-23
Table 24.	NovaScale R425 Server drawer specifications .....	A-24
Table 25.	NovaScale 5080/5160/6080/6160 Server specifications .....	A-26
Table 26.	NovaScale 5320/6320 Server specifications .....	A-28
Table 27.	NovaScale 5085 Server specifications .....	A-30
Table 28.	NovaScale 5165 Server specifications .....	A-32
Table 29.	NovaScale 5245 Server specifications .....	A-34
Table 30.	NovaScale 5325 Server specifications .....	A-36
Table 31.	Imperial to metric conversion table .....	B-1
Table 32.	Metric to imperial conversion table .....	B-1



---

## Intended Readers

This *Site Preparation Guide* explains how to prepare a Data Processing Center for Bull servers, in compliance with the standards in force. It is to be used by all personnel and trade representatives involved in the site preparation process.

- General Recommendations  
describes delivery requirements
- Chapter 2. Fitting out the Premises  
describes general site layout and requirements.
- Chapter 3. Air-Conditioning  
describes site air-conditioning requirements.
- Chapter 4. Power Supply  
describes site power supply requirements.
- Appendix A. Specifications
- Appendix B. Conversion Tables

---

## Definition of Safety Notices

Special attention is to be paid to the safety notices contained in this guide:



### **DANGER**

A *Danger* notice indicates the presence of a hazard that could result in death or serious personal injury.



### **CAUTION:**

A *Caution* notice indicates the presence of a hazard that could result in moderate or minor personal injury.



### **Warning:**

A *Warning* notice indicates an action that could cause damage to a program, device, system, or data.

---

## General Recommendations

It is mandatory to comply with the procedures, design requirements and recommendations set out in this guide. The construction of the Data Processing Center and the installation of ancillary facilities must comply with:

- the level of safety required by the standards and laws in force in the country where the server is to be installed,
- the Customer's requirements in terms of continuity of service.

All the standards referred to in this *Site Preparation Guide* are applicable in France. Equivalent standards must be applied and complied with in other countries.

Site preparation must take all the following aspects into account:

- safety of personnel,
- primary / raised floor,
- suspended ceiling,
- sound-proofing,
- protection from sunlight,
- access control,
- fire protection,
- water protection,
- air-conditioning,
- power supply.



**Warning:**

**The installation of an "on-line" Uninterruptible Power Supply (UPS) is strongly recommended to ensure continuity of service and to protect the system in the event of a mains failure.**

On request, our local Customer Service Department can supply you with a list of the services available for your server. These services include Data Processing Center site assessment and conformity inspections.

Site preparation must be completed by the pre-arranged delivery date. Any delay due to non-completion of the site by the pre-arranged date will be considered as the Customer's responsibility.

The Customer shall bear the cost of the works to be carried out to attain stipulated safety and continuity of operation requirements.

The following web site may be consulted for general site preparation information:

**<http://www.cs.bull.net/aise>**

---

## Regulatory Specifications and Disclaimers

### Declaration of the Manufacturer or Importer

We hereby certify that this product is in compliance with European Union EMC Directive 2004/108/CE, using standards EN55022 (Class A) and EN55024 and Low Voltage Directive 2006/95/CE, using standard EN60950. The product has been marked with the CE Mark to illustrate its compliance.

### Safety Compliance Statement

- UL 60950 (USA)
- IEC 60950 (International)
- CSA 60950 (Canada)

### European Community (EC) Council Directives

This product is in conformity with the protection requirements of the following EC Council Directives:

#### Electromagnetic Compatibility

- 2004/108/CE

#### Low Voltage

- 2006/95/CE

#### EC Conformity

- 93/68/EEC

#### Telecommunications Terminal Equipment

- 1999/5/EC

Neither the provider nor the manufacturer can accept responsibility for any failure to satisfy the protection requirements resulting from a non-recommended modification of the product.

Compliance with these directives requires:

- an EC declaration of conformity from the manufacturer
- an EC label on the product
- technical documentation

## Federal Communications Commission (FCC) Statement

### Note:

This equipment has been tested and found to comply with the limits for a Class A digital device, pursuant to Part 15 of the FCC Rules. These limits are designed to provide reasonable protection against harmful interference when the equipment is operated in a commercial environment. This equipment generates, uses, and can radiate radio frequency energy and, if not installed and used in accordance with the instruction manual, may cause harmful interference to radio communications. Operation of this equipment in a residential area is likely to cause harmful interference in which case the user will be required to correct the interference at his own expense.

Properly shielded and grounded cables and connectors must be used in order to meet FCC emission limits. Neither the provider nor the manufacturer are responsible for any radio or television interference caused by using other than recommended cables and connectors or by unauthorized changes or modifications to this equipment. Unauthorized changes or modifications could void the user's authority to operate the equipment.

Any changes or modifications not expressly approved by the grantee of this device could void the user's authority to operate the equipment. The customer is responsible for ensuring compliance of the modified product.

## FCC Declaration of Conformity

This device complies with Part 15 of the FCC Rules. Operation is subject to the following two conditions: (1) this device may not cause harmful interference, and (2) this device must accept any interference received, including interference that may cause undesired operation.

## Canadian Compliance Statement (Industry Canada)

This Class A digital apparatus meets all requirements of the Canadian Interference Causing Equipment Regulations.

Cet appareil numérique de la classe A est conforme à la norme NMB-003 du Canada.

This product is in conformity with the protection requirements of the following standards:

### Electromagnetic Compatibility

- ICES-003
- NMB-003

## Laser Compliance Notice

This product that uses laser technology complies with Class 1 laser requirements.

A CLASS 1 LASER PRODUCT label is located on the laser device.

<p><b>Class 1 Laser Product</b> <b>Luokan 1 Laserlaite</b> <b>Klasse 1 Laser Apparat</b> <b>Laser Klasse 1</b></p>
--

---

## Environmental Standards

### Climatic and Atmospheric Specifications

The servers comply with standards:

- IEC 60068.2.1  
IEC 60068.2.2  
IEC 60068.2.78  
IEC 60529  
IEC 60950  
ISO 7779

### Electrical Specifications

The servers comply with standards:

- IEC 60038  
IEC 60059  
IEC 60196  
IEC 60364  
IEC 61689

#### Mains Source Power

- 207-244 VAC, 49 - 61 Hz (single phase Ph / N + PE or Ph / Ph + PE),  
20/32/64A per PDU (see model specifications)

#### Voltage Sag

- 20 ms (IEC 1000-4-11)

### Electromagnetic Compatibility

The servers comply with standards:

Europe:	<p>EMC Directive, 89/336/EEC</p> <ul style="list-style-type: none"><li>• EN55022, Class A Limit, Radiated &amp; Conducted Emissions</li><li>• EN55024, ITE Specific Immunity Standard</li><li>• EN61000-4-2, ESD Immunity (Level 2 Contact Discharge, Level 3 Air Discharge)</li><li>• EN61000-4-3, Radiated Immunity (Level 2)</li><li>• EN61000-4-4, Electrical Fast Transient (Level 2)</li><li>• EN61000-4-5, AC Surge</li><li>• EN61000-4-6, Conducted RF</li><li>• EN61000-4-8, Power Frequency Magnetic Fields</li><li>• EN61000-4-11, Voltage Dips and Interrupts</li><li>• EN61000-3-2, Limit for Harmonic Current Emissions</li><li>• EN61000-3-3, Voltage Flicker</li></ul>
North America	<ul style="list-style-type: none"><li>• FCC Part 15 Class A</li><li>• ICES-003 Issue 3 Class A</li></ul>

#### Bull NovaScale Blade servers also comply with standards:

- Japan: IEC 1000-3-2
- Australia / New Zealand: IEC 60950
- Taiwan: BSMI Approval
- Korea: RRL Approval
- Russia: GOST Approved
- International: CISPR, Class A Limit

## Protection against Electrostatic Discharges

CMOS (Complementary Metal Oxide Semiconductor) technology is highly sensitive to electrostatic discharges. The use of conductive antistatic flooring is strongly recommended.

Maintenance personnel must wear wrist-straps before handling electronic equipment. A ground socket is provided in each cabinet.

## Shocks and Vibrations

The servers comply with standards:

- IEC 60068-1
- IEC 60068-2-6
- IEC 60068-2-27
- IEC 60068-2-31
- IEC 60068-2-47
- IEC 60068-2-64
- IEC 60050
- ISO 2041
- ISO 5348
- ISO 5344
- ISO 8626

### Operating Mode (on levelers)

- Sinusoidal vibrations:
  - Duration: 1 sweep, 1 octave/mn
  - 5 - 16 Hz range: 0.25 mm peak
  - 16 -200 Hz range: 0.25 g peak
- Random excitation:
  - Duration: 15 mn
  - Frequency: 5 - 200 Hz
  - Spectral density:  $1.5 \times 10^{-4}$  g /Hz
  - Root mean square acceleration: 0.17g RMS

### Non-operating Mode (on castors)

- Sweep sine:
  - Duration: 1 sweep, 1 octave/mn
  - 5 - 16 Hz range: 0.25 mm peak
  - 16 - 200 Hz range: 0.25 g peak
- Random excitation:
  - Duration: 15 mn
  - Frequency: 5 - 200 Hz
  - Spectral density:  $1.5 \times 10^{-3}$  g /Hz
  - Root mean square acceleration: 0.54g RMS

### Shock Tests:

- Duration: 11 ms
- Form: 1/2 sinusoidal
- Amplitude: 15 g

## Pollution Limits

The servers comply with standard:

- NFX44-101, Class 4 000 000

## Audio-Noise Limits

The servers comply with standards:

- ISO 7779
- ISO 11201
- ISO 7574
- ISO 4871
- ISO 9295
- ISO 9296
- IEC 61260
- IEC 60651 (Bull NovaScale 5xx5 Series & Bull NovaScale 5xx5 Series)
- IEC 61672-1 (Bull NovaScale 4000 Series)
- IEC 61672-2 (Bull NovaScale 4000 Series)

### Operating LwAd Acoustical Power

- 7.4 Bel

### Operating Lpa Acoustical Pressure

- 60 dBA

## Safety Specifications

The servers comply with national and international standards:

- IEC 60950
- EN 60950
- UL 60950
- CAN/CSA C22-2 N° 60950-00





---

## Chapter 1. General Requirements

This chapter explains delivery and unpacking requirements for the servers. It includes the following topics:

- Server Cabinet, on page 1-1
- Delivery Conditions, on page 1-2
- Carry-In Route, on page 1-2
- Unpacking Requirements, on page 1-3

---

### Server Cabinets

The servers are delivered rack-mounted and pre-cabled in one or two 19U / 40U cabinets, according to the version chosen.



Figure 1. Bull server cabinets

---

## Delivery Conditions

The server is delivered 24 hours in advance of the scheduled installation date. On arrival, the server must be placed, in its packing, in the Computer Room so that it reaches room temperature before powering up (optimum operating temperature =  $22^{\circ}\text{C} \pm 3^{\circ}\text{C}$ , hygrometry =  $50\% \pm 5\%$ ).



**Warning:**

**To avoid incorrect handling, the server must be removed from its packing by authorized Customer Service Engineers only.**

---

## Carry-In Route

The route from the unloading bay to the Computer Room must be checked to ensure that the server can be carried into the premises easily and that floors can support temporary overloads during delivery. See Appendix A *Specifications*.

The Sales Department or local Customer Service Department will draw up an Access Sheet to ensure correct delivery.



**CAUTION:**

**It is mandatory for the server to be transported vertically.  
The server is extremely heavy and requires the use of an elevator.  
The Data Processing Site manager must allocate enough personnel to ensure safe handling of the server.**

## Unpacking Requirements

The cabinet is delivered packed on a pallet with rails for easy unloading. The Data Processing Site manager must set aside the required working area for unpacking, as shown in the following figure. See Appendix A. *Specifications* for packing size.

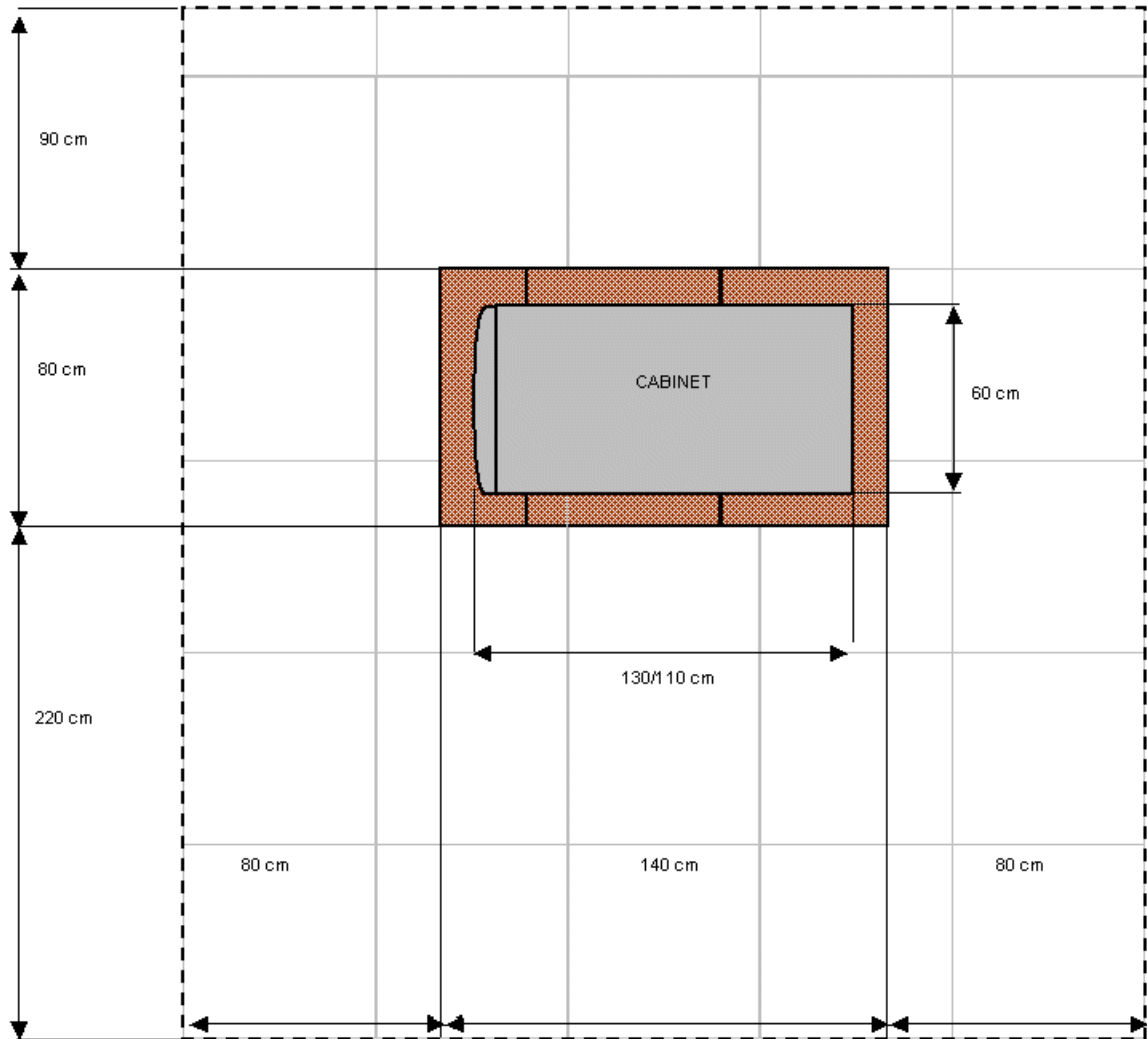

Figure 2. Required unpacking area



**Important:**

Cabinet depth varies according to server model (130 / 110 cm).

See Appendix A. *Specifications* for details.



---

## Chapter 2. Fitting out the Premises

This chapter explains how to plan and fit out your premises to receive your server. It includes the following topics:

- Data Processing Center Layout, on page 2-1
- Planning Installation, on page 2-3
- Power Cables, on page 2-3
- Network Cables, on page 2-4
- Electrical / Electromagnetic Interference, on page 2-7
- Fire Protection, on page 2-7
- Water Damage, on page 2-8
- Computer Room Floor, on page 2-9
- Computer Room Ceiling, on page 2-10
- Sound-proofing, on page 2-11
- Protection from Sunlight, on page 2-11
- Cleaning, on page 2-11
- Media Storage Room, on page 2-12
- Paper Storage Room, on page 2-12
- Printing Room, on page 2-12
- Ancillary Equipment Room, on page 2-12

---

### Data Processing Center Layout

Site layout must provide:

- sufficient clearance around the various units for easy access and addition of extensions,
- protection from direct sunlight.

Selection of the Computer Room must be based on the following criteria:

- resistance of primary floors,
- headroom,
- easy access,
- exposure and location of windows and doors,
- location of electrical and telephone sockets,
- location of pillars and radiators.

For optimum site safety and security, the following figure shows an example of recommended Data Processing Center layout.

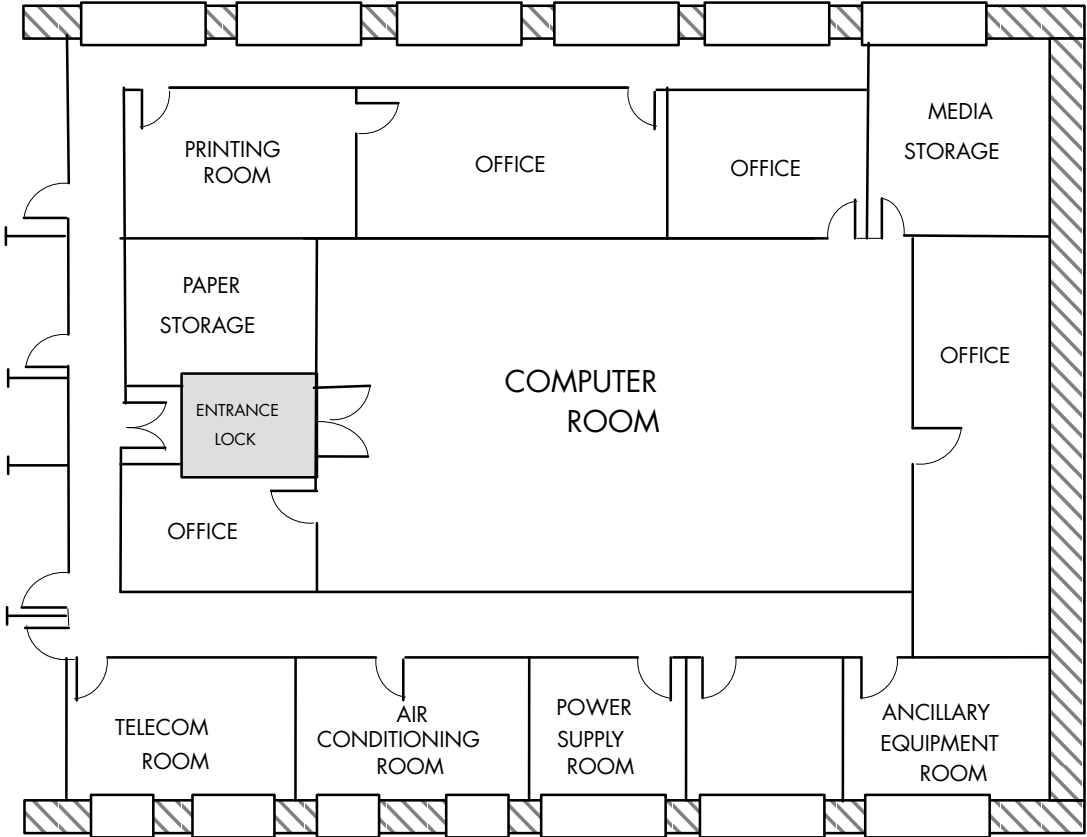

Figure 3. Recommended Data Processing Center layout



**Warning:**  
Wall and floor carpets must not be used in the Data Processing Center.



**Note:**  
It is recommended to provide for the removal of packing items in the Computer Room and ancillary premises.

## Planning Installation

Installation must be planned so that any changes and / or extensions may be implemented with minimum service disruption. Use the layout grid shown in Figure 7 to plan installation. Each square of the grid represents a standard raised floor panel.



### CAUTION:

**It is mandatory for Data Processing Center layout to take the safety of personnel into account. Access for stretchers must be provided around the server and peripherals.**

The following items must be located on the layout grid shown in Figure 7 *Layout grid*, on page 2-6:

- cableways,
- extension cables,
- power and telephone sockets,
- storage cabinets.

## Cable Cut-outs

A cable cut-out must be provided at the front or rear base of each cabinet.

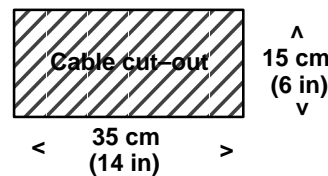

Server	Cable cut-out
NovaScale 20xx Servers	Rear
NovaScale 40x0 Servers	Rear
NovaScale 5xx0 Servers	Front (main cabinet)    Rear (I/O cabinet)
NovaScale 5xx5 SMP Servers	Rear
NovaScale 6xx0 Servers	Front (main cabinet)    Rear (I/O cabinet)
NovaScale 5xx5 Partitioned Servers	Rear

Figure 4. Cabinet cable cut-outs

## Power Cables

One power supply cable, per PDU and/or CSS Module, must be routed by the Customer to the cable cut-out at the base of each cabinet.



### Note:

For further details, see *Cabling Requirements*, on page 4-2

## Network Cables

The following table indicates the number of Ethernet and Modem cables to be routed to the cable cut-out at the base of each cabinet if the server is to be connected to the Customer's LAN (for remote operation, administration, or maintenance):

Server	Network Cable
NovaScale 20xx Servers	Production: 1 to 4 x 10/100/1000 Mb Ethernet cable per embedded Ethernet Switch. Management: 1 x 10/100 Mb Ethernet cable per Chassis Management Module.
NovaScale 40x0 Servers	1 x 10/100 Mb Ethernet cable or 1 Gigabit Ethernet cable per server CPU drawer
NovaScale 5x0 Servers NovaScale 6x0 Servers NovaScale 5x5 SMP Servers NovaScale 5x5 Partitioned Servers	1 x 10/100 Mb Ethernet cable for the integrated Platform Administration & Maintenance computer (PAP unit) 1 x 10/100 Mb Ethernet cable or 1 Gigabit Ethernet cable per Central Subsystem (CSS) module 1 x Modem cable equipped with an RJ11 connector (Remote Maintenance Modem)



**Note:**

Modem cable connectors differ from country to country.  
Customers are to provide the RJ11 adapter required to comply with national standards.  
For further details, please consult your Bull Sales Representative.



## Service Clearance

It is mandatory to comply with the service clearance requirements indicated in the following figures:

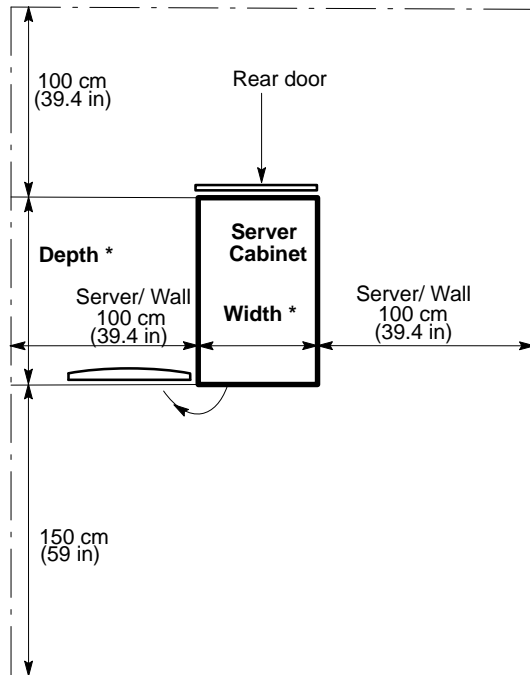

Figure 5. Single cabinet service clearance

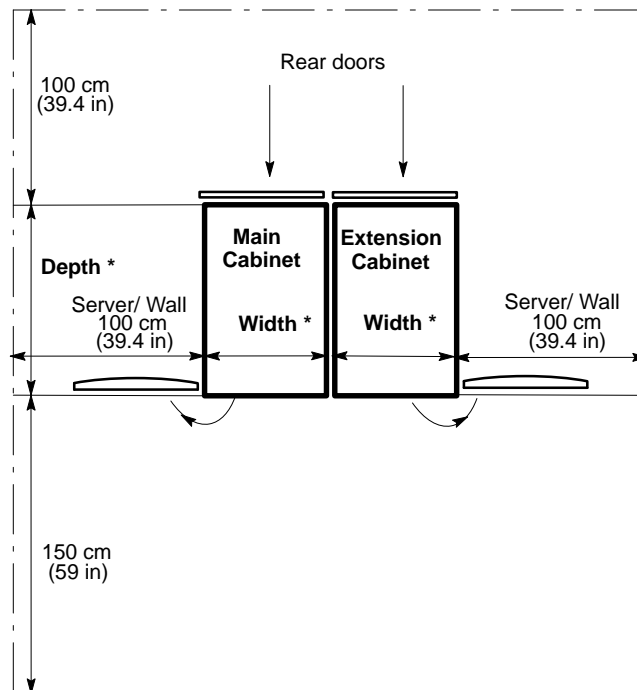

Figure 6. Dual cabinet service clearance

\* Depth (110 to 130 cm), Width (60 to 65 cm)



### Warning:

Full access to the cabinet is mandatory for maintenance.  
Customers are advised to plan ahead and to provide space for extensions.

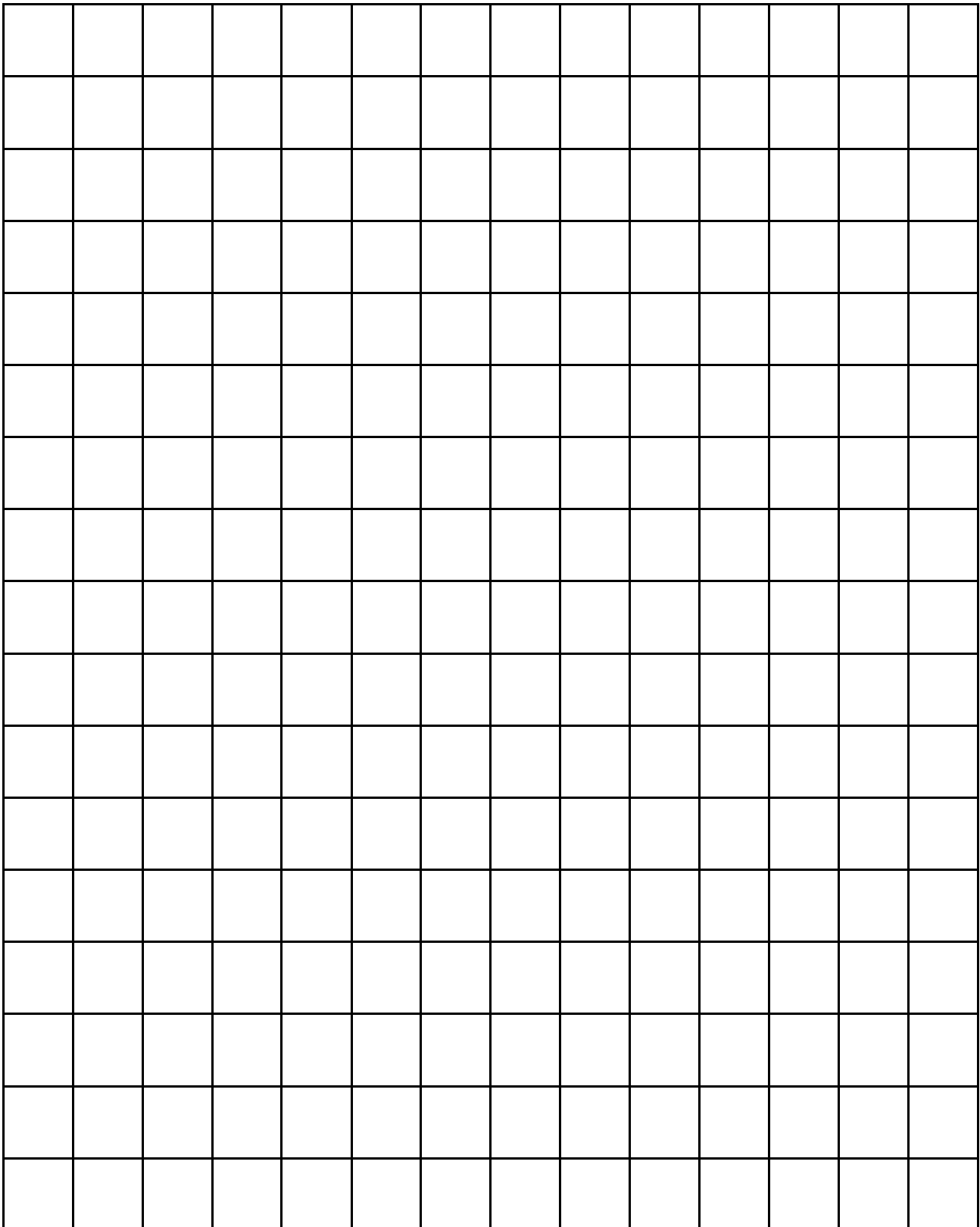

1 square = 60 x 60 cm

Figure 7. Layout grid

---

## Electrical / Electromagnetic Interference

Generators of electromagnetic interference may adversely affect server operation. The following sources of electrical and / or electromagnetic interference must not be located in the immediate vicinity of the Data Processing Center:

- high-voltage lines,
- radars,
- radios or other transmitters.

The server must not be subjected to electric / magnetic fields in excess of:

- electric field (E): **3 V/m**,
- magnetic field (H): **30 A/m**.



### Warning:

**The installation of an "on-line" Uninterruptible Power Supply (UPS) is strongly recommended to ensure continuity of service and to protect the system in the event of a mains failure. The UPS may be installed in the Computer Room or in an ancillary room.**

---

## Fire Protection

For effective fire protection, the fire detection and extinction system must be specially designed for the Data Processing Center, which must be located in a fire area surrounded by fire-protection walls, partitions and doors.

### Fire Detection

The Customer must ensure that the following areas are monitored:

- the raised floor plenum,
- the Computer Room environment,
- the suspended ceiling plenum (where applicable),
- adjacent and ancillary rooms.

Ionic, optic, thermovelokinetic type detectors are generally used for fire detection.

The detection circuit must comprise at least two independent loops, each of which must be equipped with different detectors.

### Extinguishing Procedure

The extinguishing procedure must delay the emission of the extinguishing agent in order to:

- warn (visual and audio signals) and evacuate personnel,
- give a visual alarm outside the premises as to the presence of extinguishing gases,
- cut off power (hardware, lighting, air conditioning) - except emergency lighting units.

It is recommended to install portable extinguishers in the Computer Room and ancillary rooms ("water sprays" in the vicinity of paper systems and storage) for use in the event of small, contained fires.



### Note:

If the server is installed in a room equipped with water sprinklers, water pipes must only be loaded subsequent to a primary detection.

## Extinguishing Agents

In compliance with APSAD R13.

Commonly used extinguishing agents are:

- inert gases such as ARGONITE (Argon-based) and INERGEN,
- water in the form of sprinklers or sprays (pending certification).



### CAUTION:

**It is strongly recommended not to use CO gas (hazard to personnel and to equipment). The use of HALON 1301 gas is prohibited as from January 1 2003.**

## Alarms

A round-the-clock alarm transfer system is recommended via:

- a watchroom,
- a dedicated in-house fire department,
- a remote monitoring center.

---

## Water Damage

It is recommended to install detection leads, connected to alarm or remote surveillance centers, under equipment or in high-risk zones.

Water damage in a data processing site is generally due to:

- extinguishing fires with water sprays,
- leaks in the air-conditioning system,
- leaks in water-pipes passing through the Computer Room,
- water rise following heavy rain.

## Computer Room Floor

### Primary Floor

The primary floor must be sloped and equipped with a drain.

Primary floor resistance must be  $> 600 \text{ daN/m}$ .

The primary floor and wall risers located at raised floor level must be coated with dustproof paint.

### Raised Floor



#### CAUTION:

**A raised floor compliant with Standard NF P67 103-1 and 103-2, dated April 1993 is mandatory for the Bull NovaScale Servers.**

A raised floor allows even distribution of the overall system load and provides a plenum space for cabling and air-conditioning.

The structure must be reinforced by intermediate crossbeams or T-beam section spars, according to slab cutouts and the hardware load.

The raised floor structure (at the actuator base) must be meshed with  $\geq 20\text{mm}$  section, flat, tin-plated copper braiding. See Figure 15 *Raised floor equipotentiality method*, on page 4-6.

The raised floor must be made of 60 cm x 60 cm, removable, interchangeable, square slabs supported by adjustable flat-head actuators (18 per silo), fitted with electrically conductive rubber pads.

#### Raised Floor Features:

- resistance:  $> 500 \text{ daN/m}^2$ ,
- temporary resistance:  $> 2.5 \text{ kN/m}^2$ ,
- slabs: galvanized steel or aluminium trays, inside which high density particle boards are bonded and covered with plastic laminate or vinyl flooring,
- volume resistivity:  $10^4 - 10^{10}$  ohms,
- plenum space:  $> 30 \text{ cm}$  to allow the correct circulation of conditioned air,
- slab surface flatness must be checked by laser.

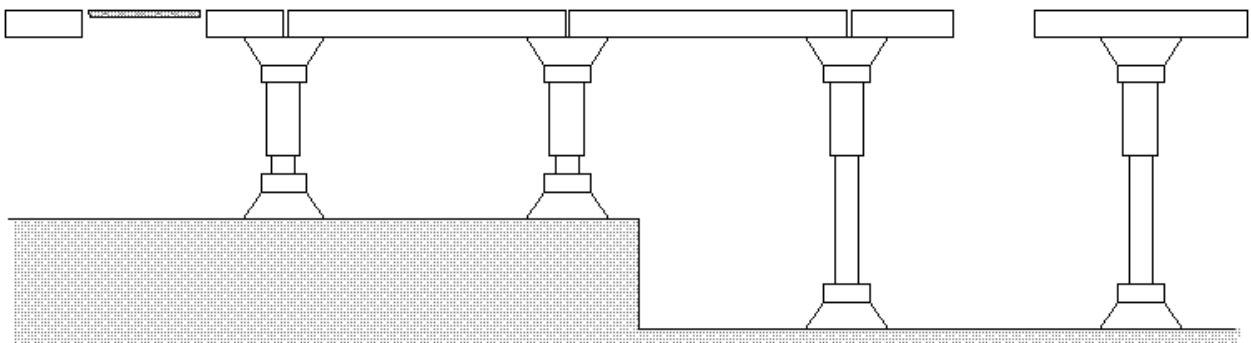

Figure 8. Raised floor cross-section

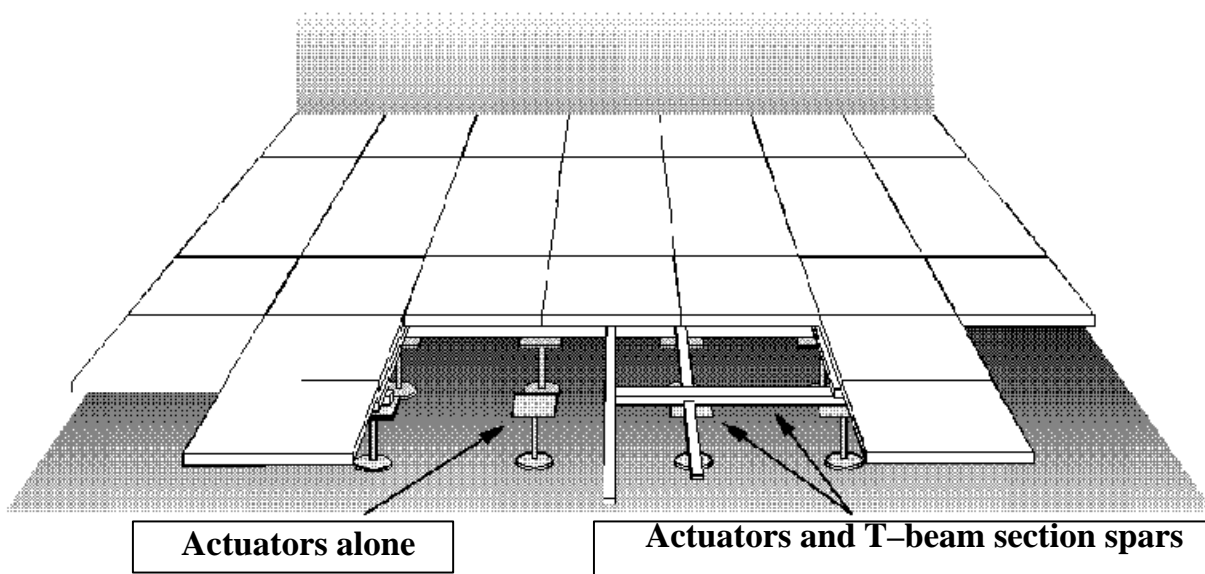

Figure 9. Raised floor structure



**CAUTION:**

If the air-conditioning unit(s) is (are) placed on brackets in the room, it is mandatory to electrically isolate these brackets from the raised floor slabs, crossbeams, and actuators.

## Computer Room Ceiling

It is extremely important to have sufficient ceiling height so that the premises may be air-conditioned without creating draughts. Optionally, a suspended ceiling may be installed.

Ceiling or suspended ceiling height must be at least 2.50 meters. Insufficient ceiling height may adversely affect the air-conditioning system and make personnel uncomfortable.

The primary ceiling and wall drops located at suspended ceiling level must be coated with dustproof paint.

## Suspended Ceiling

The suspended ceiling must be made of a non-pulverulent material (metal slabs or plates). To avoid slab disintegration and the generation of dust, it is strongly recommended not to use "mineral" type components.

### Suspended Ceiling Features:

- reduces the sound level in the room,
- improves the appearance of the room,
- allows light fittings to be flush-mounted,
- conceals pipes, ducts or channels,
- glass or rock wool can only be used if contained in a dust-proof bag or cushion,
- suspended ceiling height: > 2.50 m,
- plenum space: > 20 cm.

---

## Sound-Proofing

The sound level in the Computer Room may be relatively high due to room structure, air-conditioning and hardware ventilation systems.

The most effective means of attenuating noise are to:

- use dedicated rooms (Printing Room, Console Room, etc.),
- install a suspended ceiling,
- sound-proof walls and partitions.

---

## Protection from Sunlight

Large glass surfaces must be protected from sunlight. In no event may the Bull NovaScale Server be exposed to direct sunlight.

External protections only may be used (coating, canvas curtains or shutter blinds).



**Note:**

Venetian blinds may not be used inside the Computer Room.

---

## Cleaning

Dust has an adverse effect on the correct operation of data processing systems and their environment. Floors must be cleaned every day with a damp floor-cloth.



**Notes:** It is mandatory not to use polish and wax on floors as they may remove the anti-static qualities of the floor covering (raised floor slabs). Once a year, specialists must be called in to clean the raised floor, the suspended ceiling, and their plenums.

The Computer Room must comply with standard NF X44-101, dated May 1999 "Classification of contamination by solid particles", Class 4 000 000.

---

## Media Storage Room

Media may be stored in the Computer Room or in an adjacent room, in which case Computer Room environmental conditions are applicable.

The Media Storage Room floor must be designed to support loads of up to 10 kN/m<sup>2</sup>.

Media is sensitive to high-power electromagnetic fields. Media must not be stored in the vicinity of electric ducts, lightning rod chutes, transformers, etc.

---

## Paper Storage Room

The Paper Storage Room floor must be designed to support loads of up to 10 kN/m<sup>2</sup>.

Paper must be stored in a dry room with easy access to the Computer Room. It is not mandatory to air-condition the Paper Storage Room. However, hygrometry must be maintained at between 40 and 60 %.



**Note:**

Paper reams must be removed from their pallets prior to transfer to the Computer Room.

---

## Printing Room

It is strongly recommended to install all printers, including non-impact printers (laser, magnetographic printers, etc.), in a dedicated room with its own air-conditioning system.

A large volume of rapid printing generates more paper dust than a standard printer. Should it be impossible to install printers in a separate environment, the following conditions must be complied with in order to maintain maximum configuration availability:

- printers must be placed in the air flow, as far away as possible from disks and magnetic tapes,
- full account must be taken of the significant heat dissipation of this type of hardware,
- the room must be cleaned frequently:
  - the floor must be cleaned daily.
  - the raised floor plenum must be cleaned approximately every six months.

---

## Ancillary Equipment Room

Machining devices such as decollators and shredders generate dust and must not be installed in the Computer Room.

These devices must be powered from the same power network as the other ancillary equipment on the site. They must not be connected to the dedicated "data processing system" power supply.



---

## Chapter 3. Air-Conditioning

This chapter explains air-conditioning requirements for the servers. It includes the following topics:

- Air-Conditioning System Features and Functions, on page 3-1
- Air-Conditioning System Specifications, on page 3-2
- Checks and Alarms, see page 3-5



### CAUTION:

**An air-conditioning system, compliant with the requirements of NF X44-101, Class 4 000 000, dated June 1981 and with ISO 7730, is mandatory for the Bull NovaScale Server.**

---

## Air-Conditioning System Features and Functions

### Features

The Customer's air-conditioning specialist must select a fully automatic air-conditioning system specially designed for the Data Processing Center. Radiators, fitted with thermostatic valves, are acceptable in certain ancillary premises only.

The air-conditioning system must comprise at least two redundant assemblies, each providing at least 66% of the total cooling power, to ensure continuity of operation.



### Note:

The air-conditioning system will dry conditioned air. It is therefore mandatory for the air-conditioning system to include a steam generation humidifier.

### Functions

#### Temperature Control

Changes in temperature, in particular sudden changes in temperature, accelerate the ageing of components. It is therefore important for ambient temperature to be stable and to be maintained within the limits required for the system.

#### Hygrometry Control

A low level of hygrometry induces static electricity and a high level of hygrometry induces corrosion and mildew. It is therefore important to comply with hygrometry specifications.

#### Heat Dissipation

When assessing heat dissipation / balance (in kW), the Customer's air-conditioning specialist must take the following elements into account:

- servers and extensions,
- sunlight,
- radiation from outside walls,
- transmission of heat through walls separating the Computer Room from adjacent rooms,
- lighting,
- personnel,
- air renewal.

---

## Air-Conditioning System Specifications



### Warning:

If the air-conditioning system is shut down, "operational" conditions must be re-established, in compliance with temperature and hygrometry gradients, **AT LEAST ONE HOUR** before powering up the server.

To optimize the air duct network, air-conditioning cabinet(s) must be installed in the Computer Room or in an adjacent room. Filters must be easily accessible for regular checks and easy cleaning.

All materials liable to fragment, disintegrate, or crumble through ageing, handling or when subjected to conditioned air flows are prohibited. If the use of such materials cannot be avoided, they must be coated with anti-rust paint. Ventilation ducts must be made of a non-combustible, non-pulverulent material. Glass or mineral fibers must not be used in the conditioned air distribution or recycling circuit, unless packed in seal-tight bags.

The effectiveness of air-conditioning unit filters must comply with the "A.S.H.R.A.E" test,  $\geq 36\%$  (to be checked with manufacturers).

## Air Renewal, Distribution, Circulation, Pollution, and Filtering

### Renewal

A fresh air supply is mandatory for the comfort and health of personnel. The fresh air supply must be directly input at air-conditioning unit level and must be filtered in compliance with **local health authority regulations** (D.D.A.S.S. Regulations in France).

The Data Processing Center is over-pressurized via the fresh air supply which must be strictly limited to 1 - 1.5 times room air per hour. Over-pressurization presents the advantage of moving air outwards, thereby preventing dust from entering the premises.

### Distribution

Bull NovaScale Servers release high levels of heat and require the installation of a high airflow air-conditioning system.

Delivery of air through the raised floor plenum is the most appropriate solution. The air-conditioning specialist must define the number and location of the perforated and / or damper slabs required for correct air distribution.

Advantages:

- absence of constant draughts,
- airflow directed from the bottom up, from cold to hot,
- good air distribution through perforated or damper slabs,
- easy layout changes.



### Note:

It is mandatory not to install hardware or furniture on one or more perforated / damper slabs in the Computer Room.

### Circulation

The servers are cooled by taking air from inside the room. The following requirements are to be complied with for correct air circulation of air:

- raised floor height:  $\geq 30$  cm,
- the raised floor plenum must not be obstructed by oversize pipes or cableways,
- raised floor slabs must be correctly fitted.



#### Warning:

Do not place perforated / damper slabs in the immediate vicinity of one or more air-conditioning cabinets, as shown in the following figure.

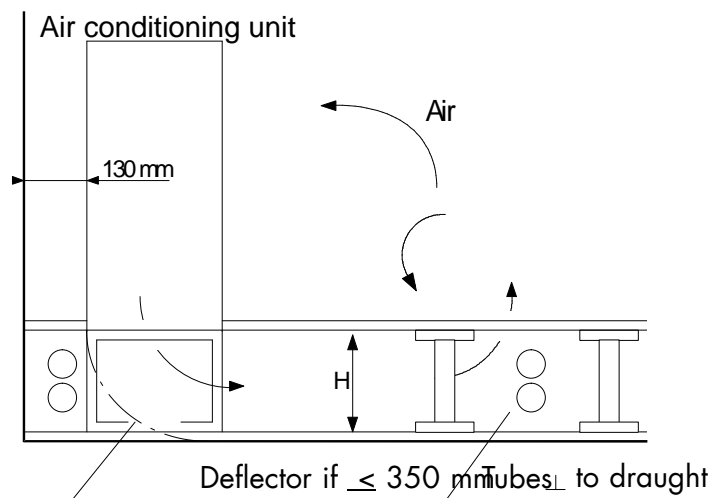

Figure 10. Example of poor air distribution

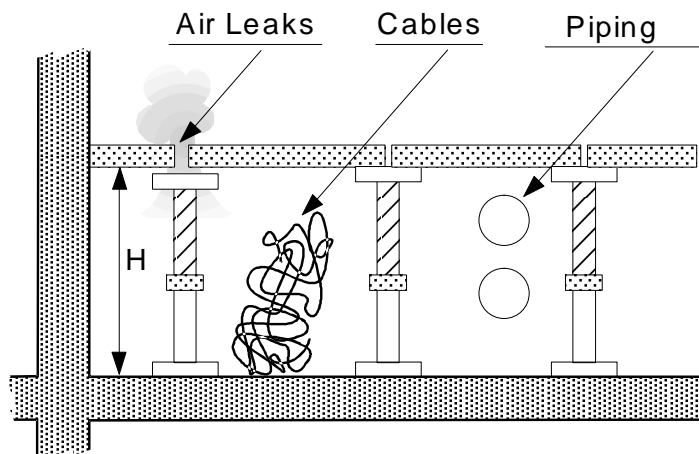

Figure 11. Example of obstacles that may obstruct air circulation

## Pollutants

There are three types of pollutants:

- liquids,
- solid particles,
- gases.

Damage varies according to pollutant type and interaction: corrosion, erosion, mildew, oxidation, etc.

Solid particles are abrasive, electrostatic, and absorbent. They generally originate from:

- surface crumbling of construction materials used to fit out the Data Processing Center,
- the formation of rust inside air conditioning units and on raised floor supports,
- systems (e.g. printers, ...),
- insufficient filtering of fresh air,
- personnel.

Polluted air results in:

- clogged filters and impaired thermal dissipation,
- damaged connections (contact points) = intermittent failures,
- deterioration of magnetic media,
- premature wear and tear of components and moving parts.



### Note:

The Computer Room and ancillary premises must be cleaned thoroughly at frequent intervals. See *Cleaning* on page 2-11 for further details.

Gas pollution is difficult to control. The known effects of gas pollution on equipment and hardware are corrosion and oxidation.



### CAUTION:

**In a standard data processing environment, gas concentration does not exceed an acceptable level. However, if there are chemical or industrial processing factories in the vicinity, if chemical odors are present, or if any other symptom or inherent problem is detected, the site must be analyzed immediately.**

---

## Checks and Alarms

The air-conditioning system is controlled automatically. Variations outside the specified temperature and hygrometry ranges must be transmitted to Customer Service Engineers.

Detectors must be installed at the air-conditioning cabinet air inlet and / or in the Computer Room. Alarms must indicate any variation outside the specified Computer Room climatic environment conditions.

A weekly thermo-hygrograph recording sheet must be displayed so that any disruptions in the air-conditioning system can be viewed and recorded. Thermo-hygrograph recording sheets must be archived for at least three months.



**Warning:**

**Do not install detectors on panels that are subject to climatic variations (e.g. outside walls, ...).**

**In order to avoid damage to or the destruction of electronic equipment, a dynamic safety device must automatically cut off the electric power supply to the system if ambient temperature exceeds 27° / 30° C.**



---

## Chapter 4. Power Supply

This chapter explains power supply requirements for Bull NovaScale Servers. It includes the following topics:

- Power Supply, on page 4-1
- Cabling Requirements, on page 4-2
- Grounding Circuit, on page 4-5
- Neutral Power System, on page 4-6
- Non-Computing Power Supply, on page 4-8



### **DANGER**

**A power supply compliant with Standard NFC 15.100, dated May 1991, is mandatory for the servers.**

---

## Power Supply

Inrush current on connecting the server to the main AC power supply may be significant. The Bull NovaScale Server CSS module is equipped with a switch-mode power supply that absorbs sinusoidal currents.

Each PDU is equipped with a switch-mode power supply that absorbs non-sinusoidal currents.

To ensure that interferences or faults generated by other systems and devices do not affect server operation, the CSS module and the PDU/UPS must be powered through an AC protection.

Electric and data cables must be laid in bulk on the primary slab, in the raised floor plenum. If cableways are required, electricity distribution cables must be separated from data transmission cables (separation of high and low currents) by at least 30 cm.

### **Prerequisites:**

- Provision of the power supply interface and the corresponding electrical installation in compliance with specifications.
- Provision and installation of the electric power supply panel (and required protections).
- Provision of power supply cables from the electricity distribution panel up to the hardware connection point.
- Grounded plug sockets for the connection of the system to the power supply.
- Provision and installation of an emergency shutdown system (lock system) and of a power supply cut-off device at general Data Processing Center circuit breaker level.
- Power factor requirement: > 90%.



### **Warning:**

**The installation of an "on-line" Uninterruptible Power Supply (UPS) is strongly recommended to ensure continuity of service and to protect the system in the event of a mains failure. The UPS may be installed in the rack, in the Computer Room or in an ancillary room.**



**DANGER**

- To ensure the protection of personnel and equipment, bipolar magneto-thermic circuit breakers must be installed on the phase and neutral wires, in compliance with the safety standards in force.
- Power must be exclusively conveyed by copper conductors from the source. Aluminium conductors are prohibited. It is mandatory to separate the power supply for the server from the non-computing power supply.

---

## Cabling Requirements

The Customer is responsible for providing the dedicated power supply to the base of the cabinet. As equipment in Data Processing Centers is moved frequently, standards require the use of flexible power cables.

One power supply cable, per PDU/UPS and/or CSS Module, must be routed by the Customer to the cable cut-out at the base of each cabinet, or for UPS 7.5 KVA & 10 KVA, into hard wire receptacle in the side.



**Important:**

**Each Power Distribution Unit (PDU) and the UPS require an extra cable length of 1.5 meters for connection inside the cabinet.**

**The Central Subsystem (CSS) Module cable length allows connection in the plenum space at the base of the cabinet.**



**Note:**

See Appendix A for details.



**CAUTION:**

**It is mandatory for power lines and terminal boxes to be located within the immediate vicinity of the system and to be easily accessible.**

**Each power line must be connected to a separate, independent electrical panel and bipolar circuit breaker.**

**France:**

**Power sockets and plugs must be compliant with Decree 88-1056 Article 20-IV, dated 14th November 1988.**



**Warning:**

**Cables must be correctly labeled at both ends with the following information:**

- the device to which each cable end is being connected,
- the physical location of the other end of the cable (ID: building, floor, column, ...),
- the length of the cable run.

The Customer is responsible for ensuring that the AC electricity supply is compliant with national and local recommendations, regulations, standards, and codes of practice.



## Mounting Power Supply Cable Sockets



**CAUTION:**  
To be performed by a certified electrician only.

### Tools Required

- Multimeter
- Phillips screwdriver
- Velcro fasteners

### Europe, Brazil

PDU/UPS power cables are equipped with ready-mounted IEC60309 plugs. The Customer is responsible for supplying and installing appropriate sockets for connection to the site power supply.

Except for UPS 7.5 & 10 KVA: Power Cables are hard wired directly in the UPS without plug.



Figure 12. Plug and socket

### United States of America

Server power cables are equipped with ready-mounted NEMA L6-30P plugs. The Customer is responsible for supplying and installing appropriate sockets for connection to the site power supply.



Figure 13. US plug characteristics

For PDU/UPS equipped with IEC 60309 plugs.

1. Check that the power supply cable is not live with the multimeter.
2. Carefully guide the power supply cable through the cable inlet at the base of the cabinet.
3. Check that the power supply cable is long enough.
4. Unscrew the base of the socket (A), insert the cable through the socket base (B), and wire to the socket head, as shown in Figure 14.



Figure 14. PDU/UPS Power socket

5. Screw the socket base back to the socket head (C).
6. Check for  $\leq 0.1$  ohm resistance between the grounding pin on the power cable plug and the metal frame with the multimeter.
7. Connect the power supply cable socket to the power cable plug.
8. Use velcro fasteners to secure the cable into place along the cabinet frame.

---

## Grounding Circuit

The electronic components inside the servers are sensitive to high-frequency electromagnetic interference. To ensure correct hardware operation, high-frequency interference must be limited via an equipotential ground circuit and metallic braid shielded cables.



### DANGER

**For the protection of personnel and hardware, it is mandatory for the grounding network to be compliant with Data Processing Center requirements and the standards in force. A single, equipotential grounding circuit dedicated to data processing systems is required. If the building has several, separate grounding shafts, it is mandatory for them to be interconnected to eliminate the occurrence of different transient potentials within the same unit.**

#### Electric protection wire characteristics (in compliance with Standard NFC 15.100):

- flexible,
- multi-strand,
- black, noise-free grounding wire,
- insulated along its entire length,
- cross-section: 25 mm<sup>2</sup> - 95 mm<sup>2</sup> according to Data Processing Center configuration.

## Grounding the Raised Floor



### CAUTION:

**The raised floor must be grounded in compliance with Standard EN 50174-2.**

An equipotentiality mesh must be laid under the raised floor structure. Raised floor actuators must be grounded with  $\geq 10$  mm x 2 mm flat, tin-plated braiding connected to the equipotentiality strap in the dedicated Data Processing Center electricity distribution cabinet.

- Raised floor slab: 60 cm x 60 cm.
- Meshing braid:  $\geq 10$  mm<sup>2</sup> cross-section tin-plated copper braid.



### Note:

At each strut, the meshing braid is attached to the actuator via a metal collar.

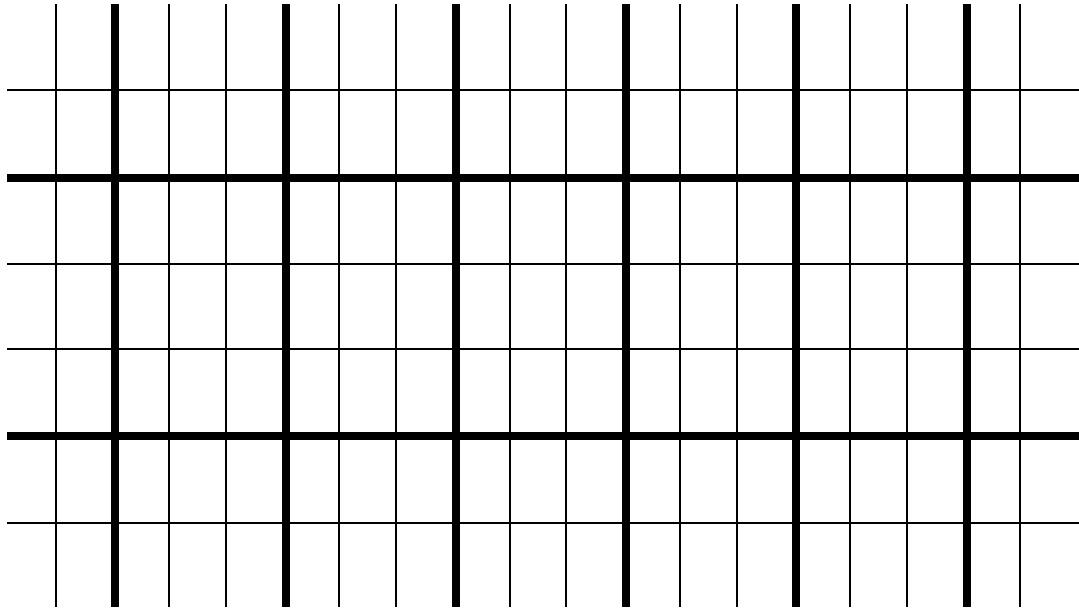

Figure 1.5. Raised floor equipotentiality method

---

## Neutral Power System

A TN-S neutral point connection system is mandatory for the servers.

### Constructing a TN-S Neutral Point Connection System

The servers are equipped with a high-leakage current switch-mode power supply.

The protective conductor (PE) is connected to the neutral conductor at the origin of the installation. As the Neutral and the PE wire are connected to the same output point of the source, the voltage measured between "Neutral" and "Ground" at any point in the installation must approach 0 Volt.

At the secondary winding of the power supply interface, the Neutral point is directly connected to the grounding shaft measurement strip, or to the nearest outlet. This connection is called the "Neutral reference wire".



#### **DANGER**

**When defining a neutral point connection, the output Neutral point of a power source or power supply interface must always be directly connected (referenced) to the nearest grounding shaft strip and never to a grounding point.**

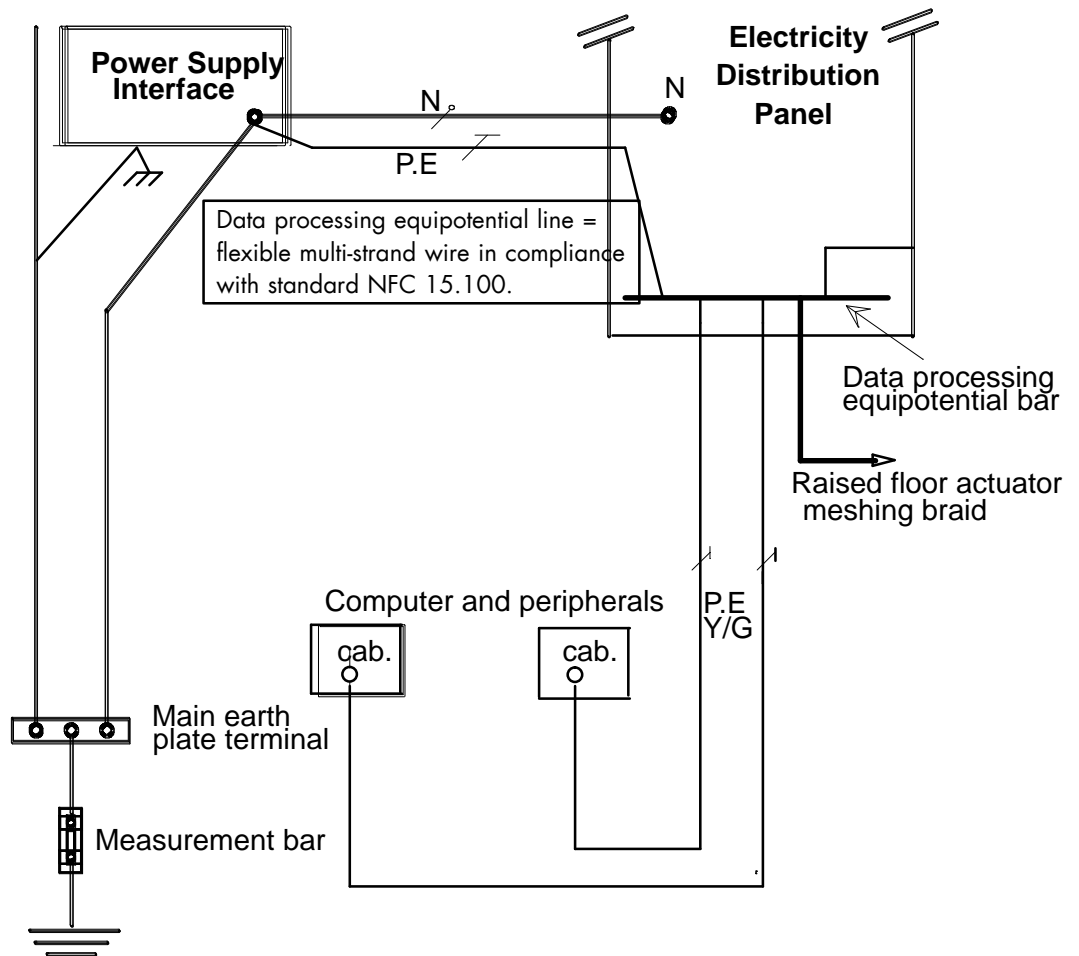

Figure 16. Grounding circuit diagram for a TN-S neutral point connection

---

## Non-Computing Power Supply

### Prerequisites

- Installation of current outlets around the edge of the computing room.
- The non-computing power supply (air-conditioners, lighting, etc.) must be separated from the data processing power supply by specific distribution cabinets.



### Note:

The Customer is responsible for supplying the complete electrical installation, from the power delivery station through to the cable outlets at the base of the server cabinet. The electrical installation must comply with the standards in force.

## Ambient Lighting

Lighting must be separated from the data processing power supply by a specific distribution cabinet. The position of lights must ensure homogeneous lighting. It is preferable to flush-mount lights in the suspended ceiling. Average lighting measured at 0.85 m from the ground must be 500 Lux (ISO 8995, future EN 12464-1).

Lighting options are:

- Instant-lighting tubes equipped with interference suppressors to limit electromagnetic wave interference.
- Halogen lamps without intensity regulators.

## Emergency Lighting

Autonomous emergency lighting units must be installed. If lighting in the Computer Room is accidentally turned off, the emergency lighting system must indicate the Emergency EXIT (green marking mandatory), for the safe evacuation of personnel.

---

## Appendix A. Specifications

- NovaScale Blade 20xx cabinet specifications, on page A-2
- NovaScale Blade chassis (7U) specifications, on page A-4
- Bull Blade chassis (9U) specifications, on page A-5
- NovaScale Blade 20xx chassis specifications, on page A-6
- NovaScale Blade 2020 server specifications, on page A-7
- NovaScale Blade 2021 server specifications, on page A-7
- NovaScale Blade 2040 server specifications, on page A-7
- NovaScale Blade 2320 server specifications, on page A-8
- NovaScale B260 server specifications, on page A-8
- NovaScale B260+ server specifications, on page A-8
- NovaScale B280 server specifications, on page A-9
- NovaScale 3005 series sever cabinet specifications, on page A-10
- NovaScale 3025 server CPU drawer specifications, on page A-12
- NovaScale 3045 server CPU drawer specifications, on page A-13
- NovaScale 3045 COMPACT server CPU drawer specifications, on page A-14
- NovaScale 4020/4040 server specifications, on page A-15
- NovaScale R421 server CPU drawer specifications, on page A-19
- NovaScale R422 server CPU drawer specifications, on page A-20
- NovaScale 5080/5160.6080/6160 server specifications, on page A-25
- NovaScale 5320/6320 server specifications, on page A-27
- NovaScale 5085 server specifications, on page A-29
- NovaScale 5165 server specifications, on page A-31
- NovaScale 5245 Server Specifications, on page A-33
- NovaScale 5325 Server Specifications, on page A-35
- UPS References, on page A-37

## NovaScale Blade 2xxx Cabinet Specifications

NovaScale Blade chassis are delivered rack-mounted in a 19U or 40U cabinet.

Cabinet Dimensions / Weight	
Unpacked	Packed
<b>1100H</b> Height: 195.5 cm (77.0 in) Width: 60.0 cm (23.6 in) Depth: 111.5 cm (43.9 in) Weight (empty): 205 kg (452 lbs) Weight (max): 600 kg (1330 lbs)	<b>1100H</b> Height: 200.0 cm (78.7 in) Width: 80.0 cm (31.5 in) Depth: 122.0 cm (48.0 in) Weight (empty): 235 kg (364 lb) Weight (max): 630 kg (2128 lb)
<b>1100L</b> Height: 103.5 cm (40.7 in) Width: 60.0 cm (23.6 in) Depth: 111.5 cm (43.9 in) Weight (empty): 143Kg (315 lbs) Weight (max): 400Kg (880 lbs)	<b>1100L</b> Height: 108.0 cm (42.5 in) Width: 80.0 cm (31.5 in) Depth: 122.0 cm (48.0 in) Weight (empty): 173 kg (382 lb) Weight (max): 430 kg (947 lb)
Service Clearance	
Front	150 cm (60 in)
Rear	100 cm (40 in)
Side (left and right)	100 cm (40 in)
Power cables	
PDU-2-4-M-32A (1100H/L cabinets)	
AC (32A)	1 per PDU
Cable type	3 x AWG10 ( 3 x 6 mm <sup>2</sup> / #10US)
Connector type	IEC60309-32A
PDU-0-7-M-32A (1100H/L cabinets)	
AC (32A)	1 per PDU
Cable type	3 x AWG10 ( 3 x 6 mm <sup>2</sup> / #10US)
Connector type	IEC60309-32A
PDU-4-2-M-63A (1100H/L cabinets)	
AC (63A)	1 per PDU
Cable type	3 x AWG06 ( 3 x 16 mm <sup>2</sup> / #06US)
Connector type	IEC60309-63A
<p><b>It is mandatory for power lines and terminal boxes to be located within the immediate vicinity of the system and to be easily accessible. Each power line must be connected to a separate, independent electrical panel and bipolar circuit breaker. PDUs require an extra cable length of 1.5 meters for connection inside the cabinet.</b></p> <p><b>PDU-4-2-M-63A:</b>  <b>Power sockets and plugs must be compliant with Decree 88-1056 Article 20-IV, dated 14th November 1988.</b></p>	



<b>Electrical Specifications</b> (power supplies are auto-sensing and auto-ranging)	
Power consumption	5000 VA (max. per chassis)
Thermal dissipation	4706 W / 16067 BTU (max. per chassis)
<b>Europe</b>	
Nominal voltage	230 VAC (Phase / Neutral)
Voltage range	207 - 244 VAC
Frequency	50 Hz 1%
<b>United States of America</b>	
Nominal voltage	208 VAC (Phase / Neutral)
Voltage range	182 - 229 VAC
Frequency	60 Hz 0,3%
<b>Japan</b>	
Nominal voltage	200 VAC (Phase / Neutral)
Voltage range	188 - 212 VAC
Frequency	60 Hz 0,2%
<b>Brazil</b>	
Nominal voltage	220 VAC (Phase / Neutral)
Voltage range	212 - 231 VAC
Frequency	60 Hz 2%
<b>Breaker Protection (Mains Power)</b>	
PDU-2-4-M-32A	32A Curve C
PDU-0-7-M-32A	32A Curve C
PDU-4-2-M-63A	63A Curve C
Maximum inrush current	210A / per quarter period

Table 1. NovaScale Blade 20xx cabinet specifications

## NovaScale Blade Chassis (7U) Specifications

<b>Dimensions / Weight</b>		
Height	30.42 cm (12 in, 7U)	
Width	44.4 cm (17.5 in)	
Depth	71.1 cm (28.0 in)	
Weight		
- Chassis + modules + Blades:	108.86 kg (240 lbs) maximum	
- Chassis + modules:	44.91 kg (99 lbs) maximum	
<b>Electrical</b>		
Voltage range (VAC)	200 VAC to 240 VAC	
Frequency	50 to 60 Hz 5% single phase	
<b>Thermal output</b>		
- Minimum configuration:	428 Watts (1461 Btu/hr)	
- Maximum configuration:	4x2000 Watt redundant power supplies 4706 Watts (16067 Btu/hr)	
<b>Temperature Requirements</b>		
Dry Bulb Temperature	<b>Operating Limit</b>	<b>Non-Operating</b>
	10 to 35 C (50 to 95 F)	-40 to 60 C (-40 to 140 F)
<b>Humidity Requirements</b>		
(noncondensing)	<b>Operating Limit</b>	<b>Non-Operating</b>
Gradient	8 to 80%	8 to 80%
Max. Wet Bulb Temperature	Not stated	Not stated
Moisture Content	Not stated	Not stated
<b>Noise Emissions</b>		
Sound Power (without acoustics module option)	<b>System Running</b>	<b>System Idle</b>
	7.4 bels maximum	7.4 bels maximum
Sound Power (with acoustics module option)	6.9 bels maximum	6.9 bels maximum
<b>Optimum Operational Reliability</b>		
Ambient Temperature	22 C+3 C/-3 C (72 F+5 F/-5 F)	
Hygrometry	50% + 10%/-10%	

Table 2. NovaScale Blade Chassis 7U specifications

## Bull Blade Chassis (9U) Specifications

<b>Dimensions / Weight</b>		
Height	40.0 cm (15.75 in, 9U)	
Width	48.2 cm (19 in)	
Depth	71.1 cm (28.0 in)	
Weight		
- Chassis + modules + Blades:	158.80 kg (350 lbs) maximum	
- Chassis + modules:	40.82 kg (90 lbs) maximum	
<b>Electrical</b>		
Voltage range (VAC)	200 VAC to 240 VAC	
Frequency	50 to 60 Hz 5% single phase	
<b>Thermal output</b>		
- Minimum configuration:	500 Watts (1705 Btu/hr)	
- Maximum configuration:	4x2900 Watt redundant power supplies 8000 Watts (27280 Btu/hr)	
<b>Temperature Requirements</b>		
Dry Bulb Temperature	<b>Operating Limit</b> 10 to 35 C (50 to 95 F)	<b>Non-Operating</b> -40 to 60 C (-40 to 140 F)
<b>Humidity Requirements</b>		
(noncondensing)	<b>Operating Limit</b> 8 to 80%	<b>Non-Operating</b> 8 to 80%
Gradient	Not stated	Not stated
Max. Wet Bulb Temperature	Not stated	Not stated
Moisture Content	Not stated	Not stated
<b>Noise Emissions</b>		
Sound Power	<b>System Running</b> 7.5 bels maximum	<b>System Idle</b> 7.5 bels maximum
<b>Optimum Operational Reliability</b>		
Ambient Temperature	22 C+3 C/-3 C (72 F+5 F/-5 F)	
Hygrometry	50% + 10%/-10%	

Table 3. Bull Blade Chassis 9U specifications

## NovaScale Blade 20xx Chassis Specifications

<b>Dimensions / Weight</b>		
Height	30.42 cm (12 in, 7U)	
Width	44.4 cm (17.5 in)	
Depth	71.1 cm (28.0 in)	
Weight		
- Chassis + modules + Blades:	108.86 kg (240 lbs) maximum	
- Chassis + modules:	44.91 kg (99 lbs) maximum	
<b>Electrical</b>		
Voltage range (VAC)	200 VAC to 240 VAC	
Frequency	50 to 60 Hz 5% single phase	
<b>Thermal output</b>		
- Minimum configuration:	428 Watts (1461 Btu/hr)	
- Maximum configuration:	4x2000 Watt redundant power supplies 4706 Watts (16067 Btu/hr)	
<b>Temperature Requirements</b>		
Dry Bulb Temperature	<b>Operating Limit</b>	<b>Non-Operating</b>
	10 to 35 C (50 to 95 F)	-40 to 60 C (-40 to 140 F)
<b>Humidity Requirements</b>		
(noncondensing)	<b>Operating Limit</b>	<b>Non-Operating</b>
Gradient	8 to 80%	8 to 80%
Max. Wet Bulb Temperature	Not stated	Not stated
Moisture Content	Not stated	Not stated
<b>Noise Emissions</b>		
Sound Power (without acoustics module option)	<b>System Running</b>	<b>System Idle</b>
	7.4 bels maximum	7.4 bels maximum
Sound Power (with acoustics module option)	6.9 bels maximum	6.9 bels maximum
<b>Optimum Operational Reliability</b>		
Ambient Temperature	22 C+3 C/-3 C (72 F+5 F/-5 F)	
Hygrometry	50% + 10%/-10%	

Table 4. NovaScale Blade 20xx Chassis specifications

---

## NovaScale Blade 2020 Server Specifications

<b>Dimensions / Weight</b>	
Height	24.5 cm (9.7 in)
Width	2.9 cm (1.14 in)
Depth	44.6 cm (17.6 in)
Maximum Weight	5.4 kg (12 lbs)
<b>Electrical</b>	
Power	Redundant 12 VDC (220 W max.)
Voltage range (VDC)	12 VDC

Table 5. NovaScale Blade 2020 Server specifications

---

## NovaScale Blade 2021 Server Specifications

<b>Dimensions / Weight</b>	
Height	24.5 cm (9.7 in)
Width	2.9 cm (1.14 in)
Depth	44.6 cm (17.6 in)
Maximum Weight	5.4 kg (12 lbs)
<b>Electrical</b>	
Power	Redundant 12 VDC (300W max.)
Voltage range (VDC)	12 VDC

Table 6. NovaScale Blade 2021 Server specifications

---

## NovaScale Blade 2040 Server Specifications

<b>Dimensions / Weight</b>	
Height	24.5 cm (9.7 in)
Width	5.9 cm (2.32 in)
Depth	44.6 cm (17.6 in)
Maximum Weight	7.5 kg (16.5 lbs)
<b>Electrical</b>	
Power	Dual redundant 12 VDC (400 W max.)
Voltage range (VDC)	12 VDC

Table 7. NovaScale Blade 2040 Server specifications

---

## NovaScale Blade 2320 Server Specifications

Dimensions / Weight	
Height	24.5 cm (9.7 in)
Width	2.9 cm (1.14 in)
Depth	44.6 cm (17.6 in)
Maximum Weight	5.4 kg (12 lbs)

Electrical	
Power	Dual redundant 12 VDC (400 W max.)
Voltage range (VDC)	12 VDC

Table 8. NovaScale Blade 2320 Server specifications

---

## NovaScale B260 Server Specifications

Dimensions / Weight	
Height	24.5 cm (9.7 in)
Width	2.9 cm (1.14 in)
Depth	44.6 cm (17.6 in)
Maximum Weight	5.4 kg (12 lbs)

Electrical	
Power	Dual redundant 12 VDC (400 W max.)
Voltage range (VDC)	12 VDC

Table 9. NovaScale B260 Server specifications

---

## NovaScale B260+ Server Specifications

Dimensions / Weight	
Height	24.5 cm (9.7 in)
Width	2.9 cm (1.14 in)
Depth	44.6 cm (17.6 in)
Maximum Weight	5.4 kg (12 lbs)

Electrical	
Power	Dual redundant 12 VDC (400 W max.)
Voltage range (VDC)	12 VDC

Table 10. NovaScale B260+ Server specifications

---

## NovaScale B280 Server Specifications

<b>Dimensions / Weight</b>	
Height	24.5 cm (9.7 in)
Width	5.8 cm (2.28 in)
Depth	44.6 cm (17.6 in)
Maximum Weight	9.0 kg (20 lbs)
<b>Electrical</b>	
Power	Dual redundant 12 VDC (400 W max.)
Voltage range (VDC)	12 VDC

Table 11. NovaScale B280 Server specifications

## NovaScale 3005 Series Server Cabinet Specifications

The Novascale 3005 Series are delivered rack-mounted in a 19U or 40U cabinet.

40U Cabinet Dimensions / Weight	
Unpacked	Packed
Height: 195.0 cm (77.0 in)	Height: 200.5 (80.7 in)
Width: 65.0 cm (25.6 in)	Width: 80.0 cm (31.5 in)
Depth: 113.6 cm (44.7 in)	Depth: 120.0 cm (47.2 in)
Weight (empty): 225 kg (496 lb)	Weight (empty): 255 kg (562 lb)
Weight (full): 680 kg (1280 lb)	Weight (full): 610 kg (1345 lb)
19U Cabinet Dimensions / Weight	
Unpacked	Packed
Height: 100.0 cm (39.4 in)	Height: 118.0 cm (46.49 in)
Width: 65.0 cm ( 25.6 in)	Width: 80.0 cm ( 31.5 in)
Depth: 113.6 cm (44.7 in)	Depth: 120.0 cm (47.2 in)
Weight (empty): 200 kg (440 lb)	Weight (empty): 230 kg (507 lb)
Weight (full): 390 kg (860 lb)	Weight (full): 420 kg (927 lb)
Service Clearance	
Front	150 cm
Rear	100 cm
Side (left and right)	100 cm
Power Cables	
AC (20A)	1 per PDU
Cable type	3 x 4 mm <sup>2</sup> / AWG # 12 (US)
Connector type	C22 Appliance Coupler
It is mandatory for power lines and terminal boxes to be located within the immediate vicinity of the system and to be easily accessible. Each power line must be connected to a separate, independent electrical panel and bipolar circuit breaker. The PDU requires an extra cable length of 1.5 meters for connection inside the cabinet	



<b>Electrical specifications</b> <b>(power supplies are auto-sensing and auto-ranging)</b>	
Current draw	24 A max. at 240 VAC input per PDU
Power consumption	8800 VA (max. 40U cabinet) 5500 VA (max. 19U cabinet) 5700 VA (max. per PDU)
Thermal dissipation	1500 VA / 5100 BTU (per Novascale 3045 CPU drawer)
<b>Europe</b>	
Nominal voltage	230 VAC (Phase / Neutral)
Voltage range	207 - 244 VAC
Frequency	50 Hz $\pm$ 1%
<b>United States of America</b>	
Nominal voltage	208 VAC (Phase / Neutral)
Voltage range	182 - 229 VAC
Frequency	60 Hz $\pm$ 0.3%
<b>Japan</b>	
Nominal voltage	200 VAC (Phase / Neutral)
Voltage range	188 - 212 VAC
Frequency	60 Hz $\pm$ 0.2%
<b>Brazil</b>	
Nominal voltage	220 VAC (Phase / Neutral)
Voltage range	212 - 231 VAC
Frequency	60 Hz $\pm$ 2%
<b>Breaker Protection</b>	
Mains power PDU	20A Curve C
Maximum inrush current	210A/per quarter period

Table 12. NovaScale 3005 Series Server Cabinet Specifications

## Novascale 3025 Server CPU Drawer Specifications

Dimensions/Weight		
Height:	17.6 cm (6.9 inches, 4U)	
Width:	44.1 cm (17.3 inches)	
Depth:	76.5 cm (30.1 inches)	
Weight (base model)	21 kg (46.3 lbs)	
Weight (max)	48 kg (105.8 lbs)	
Electrical		
Power	1760VA	
Voltage range (VAC)	200 VAC to 240 nominal, autoranging (+6% -10%)	
Frequency	50 to 60 Hz $\pm$ 5%	
Current	6.4 amps	
Thermal output (typical)	1090 VA	
Temperature Requirements		
	Operating	Non-operating
Dry Bulb Temperature	5 to 35 °C (41 to 95° F)	-10 to +43°C (14 to 109.4°F)
Gradient	Not stated	Not stated
Humidity Requirements		
	Operating	Non-operating
(non condensing)	20 to 80%	< 95 % at 25 to 35°C
Gradient	Not stated	Not stated
Max. wet Bulb temperature	Not stated	Not stated
Moisture Content	Not stated	Not stated
Noise emissions		
Acoustic test at room temperature of 28°C (82°F) without failure condition		
	Operating	Non-operating
Sound Power (Dome method)	7.0 BA	Not stated
Sound pressure (Bystander, floor-standing)	60 dBA	N/A

Table 13. NovaScale 3025 Server CPU drawer specifications

## NovaScale 3045 Server CPU Drawer Specifications

Dimensions/Weight		
Height:	17.6 cm (6.9 inches, 4U)	
Width:	44.1 cm (17.3 inches)	
Depth:	76.5 cm (30.1 inches)	
Weight (base model)	21 kg (46.3 lbs)	
Weight (max)	48 kg (105.8 lbs)	
Electrical		
Power	1760VA	
Voltage range (VAC)	200 VAC to 240 nominal, autoranging (+6% -10%)	
Frequency	50 to 60 Hz $\pm$ 5%	
Current	6.4 amps	
Thermal output (typical)	1760 VA	
Temperature Requirements		
	Operating	Non-operating
Dry Bulb Temperature	5 to 35 °C (41 to 95° F)	-10 to +43°C (14 to 109.4°F)
Gradient	Not stated	Not stated
Humidity Requirements		
	Operating	Non-operating
(non condensing)	20 to 80%	< 95 % at 25 to 35°C
Gradient	Not stated	Not stated
Max. wet Bulb temperature	Not stated	Not stated
Moisture Content	Not stated	Not stated
Noise emissions		
Acoustic test at room temperature of 28°C (82°F) without failure condition		
	Operating	Non-operating
Sound Power (Dome method)	7.0 BA	Not stated
Sound pressure (Bystander, floor-standing)	60 dBA	N/A

Table 14. NovaScale 3045 Server CPU drawer specifications

## NovaScale 3045 COMPACT Server CPU Drawer Specifications

<b>Dimensions/Weight</b>		
Height:	8.7 cm (3.4 inches, 2U)	
Width:	44.1 cm (17.3 inches)	
Depth:	76.5 cm (30.1 inches)	
Weight (base model)	21 kg (46.3 lbs)	
Weight (max)	33 kg (72.8 lbs)	
<b>Electrical</b>		
Power	1280VA	
Voltage range (VAC)	200 VAC to 240 nominal, autoranging (+6% -10%)	
Frequency	50 to 60 Hz $\pm$ 5%	
Current	6.4 amps	
Thermal output (typical)	1280 VA	
<b>Temperature Requirements</b>		
	<b>Operating</b>	<b>Non-operating</b>
Dry Bulb Temperature	5 to 35 °C (41 to 95° F)	-10 to +43°C (14 to 109.4°F)
Gradient	Not stated	Not stated
<b>Humidity Requirements</b>		
	<b>Operating</b>	<b>Non-operating</b>
(non condensing)	20 to 80%	< 95 % at 25 to 35°C
Gradient	Not stated	Not stated
Max. wet Bulb temperature	Not stated	Not stated
Moisture Content	Not stated	Not stated

Table 15. NovaScale 3045 COMPACT Server CPU drawer specifications

## NovaScale 4020/4040 Server Cabinet Specifications

NovaScale 4020 / 4040 servers are delivered rack-mounted in a 40U or 19U cabinet.

Cabinet Dimensions / Weight	
Unpacked	Packed
<b>1100H</b>	
Height: 195.5 cm (77.0 in)	Height: 200.0 cm (78.7 in)
Width: 60.0 cm (23.6 in)	Width: 80.0 cm (31.5 in)
Depth: 111.5 cm (43.9 in)	Depth: 122.0 cm (48.0 in)
Weight (empty): 135 kg (298 lb)	Weight (empty): 165 kg (364 lb)
Weight (max): 935 kg (2062 lb)	Weight (max): 965 kg (2128 lb)
<b>1100L</b>	
Height: 103.5 cm (40.7 in)	Height: 108.0 cm (42.5 in)
Width: 60.0 cm (23.6 in)	Width: 80.0 cm (31.5 in)
Depth: 111.5 cm (43.9 in)	Depth: 122.0 cm (48.0 in)
Weight (empty): 91 kg (201 lb)	Weight (empty): 121 kg (267 lb)
Weight (max): 471 kg (1038 lb)	Weight (max): 501 kg (1120 lb)
<b>Service Clearance</b>	
Front	150 cm (60 in)
Rear	100 cm (40 in)
Side (left and right)	100 cm (40 in)
<b>Power cables</b>	
<b>PDU-0-7-M-32A</b> (1100H/L & 1300H/L cabinets)	
AC (32A)	1 per PDU
Cable type	3 x AWG10 ( 3 x 6 mm <sup>2</sup> / #10US)
Connector type	IEC60309-32A
<b>It is mandatory for power lines and terminal boxes to be located within the immediate vicinity of the system and to be easily accessible. Each power line must be connected to a separate, independent electrical panel and bipolar circuit breaker. PDUs require an extra cable length of 1.5 meters for connection inside the cabinet.</b>	

<b>Electrical Specifications</b> (power supplies are auto-sensing and auto-ranging)	
Power consumption	8800 VA (max. 40U cabinet) 5500 VA (max. 19 U cabinet) 5700 VA (max. per PDU-20A) 7300 VA (max. per PDU-0-7-M-32A)
Thermal dissipation	1500 W/5100 BTU (per NovaScale 4040) 650 W/2300 BTU (per NovaScale 4020)
<b>Europe</b>	
Nominal voltage	230 VAC (Phase / Neutral)
Voltage range	207 - 244 VAC
Frequency	50 Hz 1%
<b>United States of America</b>	
Nominal voltage	208 VAC (Phase / Neutral)
Voltage range	182 - 229 VAC
Frequency	60 Hz 0,3%
<b>Japan</b>	
Nominal voltage	200 VAC (Phase / Neutral)
Voltage range	188 - 212 VAC
Frequency	60 Hz 0,2%
<b>Brazil</b>	
Nominal voltage	220 VAC (Phase / Neutral)
Voltage range	212 - 231 VAC
Frequency	60 Hz 2%
<b>Breaker Protection (Mains Power)</b>	
PDU-20A	20A Curve C
PDU-0-7-M-32A	32A Curve C
Maximum inrush current	210A / per quarter period

Table 16. NovaScale 4020/4040 Server cabinet specifications

## NovaScale 4020 Server CPU Drawer Specifications

<b>Dimensions / Weight</b>		
Height	8.77 cm (3.5 in, 2U)	
Width	44.9 cm (17.7 in)	
Depth	74.7 cm (29.4 in)	
Weight	30 kg (65 lb)	
<b>Electrical</b>		
Power	650 VA	
Voltage range (VAC)	200 VAC to 240 VAC nominal, autoranging +6%, -10%	
Frequency	50 to 60 Hz 5%	
Current	3 amps	
Thermal output (typical)	2300 Btu/hr	
<b>Temperature</b>		
Dry Bulb Temperature	<b>Operating</b> 10 to 35 C (50 to 95 F)	<b>Non-Operating</b> -40 to 70 C (-40 to 158 F)
Gradient	Not stated	Not stated
<b>Humidity</b>		
(non-condensing)	<b>Operating</b> Not stated	<b>Non-Operating</b> 95% RH, 25 to 30°C (77 to 86° F)
Gradient	Not stated	Not stated
Max. Wet Bulb Temperature	Not stated	Not stated
Moisture Content	Not stated	Not stated
<b>Noise Emissions (1)</b>		
Sound Power (Dome method)	<b>System Running</b> 6.7 BA	<b>System Idle</b> Not stated
Sound Pressure	55 dBA	N/A
(1) Acoustic tests at room temperature of 28° C (82° F) without failure condition.		

Table 17. NovaScale 4020 Server CPU drawer specifications

## NovaScale 4040 Server CPU Drawer Specifications

<b>Dimensions / Weight</b>		
Height	17.53 cm (6.9 in, 4U)	
Width	44.45 cm (17.5 in)	
Depth	71.12 cm (28.0 in)	
Weight	48.08 kg (106 lb)	
<b>Electrical</b>		
Power	1500 VA	
Voltage range (VAC)	200 VAC to 240 VAC nominal, autoranging +6%, -10%	
Frequency	50 to 60 Hz 5%	
Current	6.4 amps	
Thermal output (typical)	5100 Btu/hr	
<b>Temperature</b>		
Dry Bulb Temperature	<b>Operating</b> 10 to 35 C (50 to 95 F)	<b>Non-Operating</b> -40 to 70 C (-40 to 158 F)
Gradient	Not stated	Not stated
<b>Humidity</b>		
(non-condensing)	<b>Operating</b> Not stated	<b>Non-Operating</b> 95% RH, 25 to 30°C (77 to 86° F)
Gradient	Not stated	Not stated
Max. Wet Bulb Temperature	Not stated	Not stated
Moisture Content	Not stated	Not stated
<b>Noise Emissions (1)</b>		
Sound Power (Dome method)	<b>System Running</b> 7.0 BA	<b>System Idle</b> Not stated
Sound Pressure	60 dBA	N/A
(1) Acoustic tests at room temperature of 28° C (82° F) without failure condition.		

Table 18. NovaScale 4040 Server CPU drawer specifications



## NovaScale R421 Server CPU Drawer Specifications

<b>NovaScale R421 Dimensions / Weight</b>		
Height	4.35 cm (1.75 in, 1U)	
Width	42.7 cm (16.8 in)	
Depth	65.0 cm (25.7 in)	
Weight	15,4 kg (33 lb)	
<b>Electrical</b>		
Power (R421)	580 Watts w/PFC (+80% efficiency)	
Voltage range (VAC)	200 VAC to 240 VAC nominal, autoranging +6%, -10%	
Frequency	50 to 60 Hz 5%	
Current	R421 (3 amps) R422 (5 amps)	
Thermal output (typical)	2300 Btu/hr	
<b>Temperature</b>		
Dry Bulb Temperature	<b>Operating</b> 10 to 35 C (50 to 95 F)	<b>Non-Operating</b> -40 to 70 C (-40 to 158 F)
Gradient	Not stated	Not stated
<b>Humidity</b>		
(non-condensing)	<b>Operating</b> 8% to 90%	<b>Non-Operating</b> 8% to 95%
Gradient	Not stated	Not stated
Max. Wet Bulb Temperature	Not stated	Not stated
Moisture Content	Not stated	Not stated
<b>Noise Emissions (1)</b>		
Sound Power (Dome method)	<b>System Running</b> 6.7 BA	<b>System Idle</b> Not stated
Sound Pressure	55 dBA	N/A
(1) Acoustic tests at room temperature of 28° C (82° F) without failure condition.		

Table 19. NovaScale R421 Server CPU drawer specifications

## NovaScale R422 Server CPU Drawer Specifications

<b>NovaScale R422 Dimensions / Weight</b>		
Height	4.35 cm (1.75 in, 1U)	
Width	43.2 cm (17.0 in)	
Depth	70.4 cm (27.7 in)	
Weight	18,1 kg (39 lb)	
<b>Electrical</b>		
Power (R422)	980 Watts w/PFC (+92% efficiency)	
Voltage range (VAC)	200 VAC to 240 VAC nominal, autoranging +6%, -10%	
Frequency	50 to 60 Hz 5%	
Current	R421 (3 amps) R422 (5 amps)	
Thermal output (typical)	2300 Btu/hr	
<b>Temperature</b>		
Dry Bulb Temperature	<b>Operating</b> 10 to 35 C (50 to 95 F)	<b>Non-Operating</b> -40 to 70 C (-40 to 158 F)
Gradient	Not stated	Not stated
<b>Humidity</b>		
(non-condensing)	<b>Operating</b> 8% to 90%	<b>Non-Operating</b> 8% to 95%
Gradient	Not stated	Not stated
Max. Wet Bulb Temperature	Not stated	Not stated
Moisture Content	Not stated	Not stated
<b>Noise Emissions (1)</b>		
Sound Power (Dome method)	<b>System Running</b> 6.7 BA	<b>System Idle</b> Not stated
Sound Pressure	55 dBA	N/A
(1) Acoustic tests at room temperature of 28° C (82° F) without failure condition.		

Table 20. NovaScale 422 Server CPU drawer specifications

## NovaScale Universal R421-E1 Server Drawer Specifications

<b>NovaScale Universal R421-E1</b>		<b>Dimensions / Weight</b>	
Form factor		Rack mount 1U drawer	
Height		4.325 cm (1.703 in)	
Width without rails		43.0 cm (16.93 in)	
Width with rails		45.13 cm (17.77 in)	
Depth without CMA		69.2 cm (27.25 in)	
Depth with CMA		83.82 cm (33.00 in)	
Max. Weight (Fixed drive version)		13.38 kg (29.5 lb)	
Max. Weight (Hot-Swap drive version)		14.29 kg (35.5 lb)	
<b>Electrical</b>			
Power	600 Watts w/PFC (+80% efficiency)		
Voltage range (VAC)	110 VAC to 220 VAC		
Frequency	50 to 60 Hz		
Current	Not available		
Thermal output (typical)	Not available		
<b>Temperature</b>		<b>Operating</b>	<b>Non-Operating</b>
Dry Bulb Temperature	10 to 35 C (50 to 95 F)	-40 to 70 C (-40 to 158 F)	
Gradient	Not available	Not available	
<b>Humidity</b> (non-condensing)		<b>Operating</b>	<b>Non-Operating</b>
		Not available	non-operating 95% non-condensing at +28 C
<b>Noise Emissions (1)</b>		<b>System Running</b>	<b>System Idle</b>
Sound Power (Dome method)	6.7 BA	Not stated	
Sound Pressure	55 dBA	Not available	
(1) Acoustic tests at room temperature of 28° C (82° F) without failure condition.			

Table 21. NovaScale R421-E1 Server drawer specifications

## NovaScale Universal R422-E1 /R422-INF-E1 Server Drawer Specifications

<b>NovaScale Universal R422-E1 /R422-INF-E1</b>		<b>Dimensions / Weight</b>	
Form factor		Rack mount 1U drawer	
Height		4.3 cm (1.7 in)	
Width		43.7 cm (17.2 in)	
Depth		70.5 cm (27.75 in)	
Max. Weight (base model )		18.1 kg (40 lb)	
Max. Weight		20 kg (44 lb)	
<b>Electrical</b>			
Power	980 AC-DC power supply w//PFC		
Voltage range (VAC)	100 to 240 VAC		
Frequency	50 to 60 Hz		
Current	14.6		
Thermal output (typical)	Not available		
<b>Temperature</b>		<b>Operating</b>	<b>Non-Operating</b>
Dry Bulb Temperature		10 to 35 C (50 to 95 F)	-40 to 70 C (-40 to 158 F)
Gradient		Not available	Not available
<b>Humidity</b> (non-condensing)		<b>Operating</b>	<b>Non-Operating</b>
		8% to 90%	5% to 95%
<b>Noise Emissions (1)</b>		<b>System Running</b>	<b>System Idle</b>
Sound Power (Dome method)		Not available	Not available
Sound Pressure (Bystander, floor standing)		Not available	Not available
Acoustic tests at room temperature of 28° C (82° F) without failure condition.			

Table 22. NovaScale R422-E1 / R422-INF-E1 Server drawer specifications

## NovaScale Universal R423 Server Drawer Specifications

<b>NovaScale Universal R423</b>		<b>Dimensions / Weight</b>	
Form factor		Rack mount 2U drawer	
Height		8.9 cm (3.5 in)	
Width		43.7 cm (17.2 in)	
Depth		64.8 cm (25.5 in)	
Max. Weight		24.9 kg (55 lb)	
<b>Electrical</b>			
Power		700 (1 + 1 redundant)	
Voltage range (VAC)		100-120 to 200-240 VAC	
Frequency		50 to 60 Hz	
Current		10 Amp - 4 Amp	
Thermal output (typical)		Not available	
<b>Temperature</b>		<b>Operating</b>	<b>Non-Operating</b>
Dry Bulb Temperature		10 to 35 C (50 to 95 F)	-40 to 70 C (-40 to 158 F)
Gradient		Not available	Not available
<b>Humidity</b> (non-condensing)		<b>Operating</b>	<b>Non-Operating</b>
		8% to 90%	5% to 95%
<b>Noise Emissions (1)</b>		<b>System Running</b>	<b>System Idle</b>
Sound Power (Dome method)		Not available	Not available
Sound Pressure (Bystander, floor standing)		Not available	Not available
Acoustic tests at room temperature of 28° C (82° F) without failure condition.			

Table 23. NovaScale R423 Server drawer specifications

## NovaScale Universal R425 Server Drawer Specifications

<b>NovaScale Universal R425</b>		<b>Dimensions / Weight</b>	
Form factor		Rack mount 3U drawer	
Height		13.2 cm (5.2 in)	
Width		45.0 cm (17.7 in)	
Depth		65.0 cm (25.6 in)	
Max. Weight		34 kg (75 lb)	
<b>Electrical</b>			
Power		800 (1 + 1 redundant)	
Voltage range (VAC)		100-120 to 200-240 VAC	
Frequency		50 to 60 Hz	
Current		10 Amp - 4 Amp	
Thermal output (typical)		Not available	
<b>Temperature</b>			
Dry Bulb Temperature	<b>Operating</b>	<b>Non-Operating</b>	
	10 to 35 C (50 to 95 F)	-40 to 70 C (-40 to 158 F)	
Gradient	Not available	Not available	
<b>Humidity</b>			
(non-condensing)	<b>Operating</b>	<b>Non-Operating</b>	
	8% to 90%	5% to 95%	
<b>Noise Emissions (1)</b>			
Sound Power (Dome method)	<b>System Running</b>	<b>System Idle</b>	
	Not available	Not available	
Sound Pressure (Bystander, floor standing)	Not available	Not available	
Acoustic tests at room temperature of 28° C (82° F) without failure condition.			

Table 24. NovaScale R425 Server drawer specifications

## NovaScale 5080/5160/6080/6160 Specifications

NovaScale 5080/5160 Servers are delivered rack-mounted in 40U cabinets.

Cabinet Dimensions / Weight	
Unpacked	Packed
<b>1300H</b>	<b>1300H</b>
Height: 195.5 cm (77.0 in)	Height: 200.0 cm (78.7 in)
Width: 60.0 cm (23.6 in)	Width: 80.0 cm (31.5 in)
Depth: 129.5 cm (51.0 in)	Depth: 140.0 cm (55.1 in)
Weight (max.): 943 kg (2079 lb)	Weight (max.): 973 kg (2145 lb)
Service Clearance	
Front	150 cm
Rear	100 cm
Side (left and right)	100 cm
Operating Limits	
Dry bulb temperature range	+15°C to +30°C (+59°F to +86°F) Gradient 5°C/h (41°F/h)
Relative humidity (non-condensing)	35 to 60% (Gradient 5%/h)
Max. wet bulb temperature	+24°C (+75.2°F)
Moisture content	0.019 kg water/kg dry air
Pressure / Elevation	Sea level ≤ 2500 m
Optimum Operational Reliability	
Temperature	+ 22°C (± 3°C) (+ 72°F (± 5°F)
Hygrometry	50% (± 5%)
Non-Operating Limits	
Dry bulb temperature range	+5°C to +50°C (+41°F to +122°F) Gradient 25°C/h (77°F/h)
Relative humidity (non-condensing)	5 to 95% (Gradient 30%)
Max. wet bulb temperature	+28°C (+82.4°F)
Moisture content	0.024 kg water/kg dry air
Shipping Limits	
Dry bulb temperature range	-35°C to +65°C (-31°F to +149°F) Gradient 25°C/h (77°F/h)
Relative humidity (non-condensing)	5 to 95% Gradient 30%/h
Acoustic Power at Room Temperature +20° C (+68° F)	
System Running	System Idle
Lw(A) 6.3 Bels	Lw(A) 6.1 Bels

<b>Power Cables</b>	
<b>PDU-0-7-M-32A</b>	
AC (32A) Cable type Connector type	1 per PDU 3 x AWG10 ( 3 x 6 mm <sup>2</sup> / #10US) IEC60309-32A
<b>CSS Module</b>	
AC (20A) Cable type Connector type	1 per CSS Module 3 x AWG12 (3 x 4mm <sup>2</sup> / #12US) IEC60309-32A
<b>It is mandatory for power lines and terminal boxes to be located within the immediate vicinity of the system and to be easily accessible. Each power line must be connected to a separate, independent electrical panel and bipolar circuit breaker. PDUs require an extra cable length of 1.5 meters for connection inside the cabinet.</b>	
<b>Electrical Specifications</b> (power supplies are auto-sensing and auto-ranging)	
Current draw Power consumption Thermal dissipation	15 A max. at 200 VAC input 3000 VA (per full CSS module) 1500 VA (per PDU) 2700 W / 9250 BTU (per full CSS module) 1300 W / 4610 BTU (per PDU)
<b>Europe</b>	
Nominal voltage Voltage range Frequency	230 VAC (Phase / Neutral) 207 - 244 VAC 50 Hz 1%
<b>United States of America</b>	
Nominal voltage Voltage range Frequency	208 VAC (Phase / Neutral) 182 - 229 VAC 60 Hz 0.3%
<b>Japan</b>	
Nominal voltage Voltage range Frequency	200 VAC (Phase / Neutral) 188 - 212 VAC 60 Hz 0.2%
<b>Brazil</b>	
Nominal voltage Voltage range Frequency	220 VAC (Phase / Neutral) 212 - 231 VAC 60 Hz 2%
<b>Breaker Protection (Mains Power)</b>	
CSS module PDU-20A PDU-0-7-M-32A Maximum inrush current	20A Curve C 20A Curve C 32A Curve C 210A / per quarter period

Table 25. NovaScale 5080/5160/6080/6160 Server specifications



## NovaScale 5320/6320 Server Specifications

Cabinet Dimensions / Weight	
Unpacked	Packed
Height: 177.5 cm (70 in) Width: 65.0 cm (25.6 in) Depth: 113 cm (44.5 in) Weight: Main cabinet: 590 kg (1300 lb) I/O cabinet: 300 kg (661 lb)	Height: 202 cm (79.5 in) Width: 80.0 cm (31.5 in) Depth: 127.5 cm (50.2 in) Weight: Main cabinet: 630 kg (1390 lb) I/O cabinet: 340 kg (750 lb)
Service Clearance	
Front	150 cm
Rear	100 cm
Side (free side)	100 cm
Operating Limits	
Dry bulb temperature range	+15°C to +30°C (+59°F to +86°F) Gradient 5°C/h (41°F/h)
Relative humidity (non-condensing)	35 to 60% (Gradient 5%/h)
Max. wet bulb temperature	+24°C (+75.2°F)
Moisture content	0.019 kg water/kg dry air
Pressure / Elevation	Sea level ≤ 2500 m
Optimum Operational Reliability	
Temperature	+ 22°C (± 3°C) (+ 72°F (± 5°F)
Hygrometry	50% (± 5%)
Non-Operating Limits	
Dry bulb temperature range	+5°C to +50°C (+41°F to +122°F) Gradient 25°C/h (77°F/h)
Relative humidity (non-condensing)	5 to 95% (Gradient 30%)
Max. wet bulb temperature	+28°C (+75°F)
Moisture content	0.024 kg water/kg dry air
Shipping Limits	
Dry bulb temperature range	-35°C to +65°C (-31°F to +149°F) Gradient 25°C/h (77°F/h)
Relative humidity (non-condensing)	5 to 95% Gradient 30%/h
Acoustic Power at Room Temperature +20° C (+68° F)	
System Running	System Idle
Lw(A) 6.3 Bels	Lw(A) 6.1 Bels

<b>Power Cables</b>	
<b>PDU-0-7-M-32A</b>	
AC (32A) Cable type Connector type	1 per PDU 3 x AWG10 ( 3 x 6 mm <sup>2</sup> / #10US) IEC60309-32A
<b>CSS Module</b>	
AC (20A) Cable type Connector type	1 per CSS Module 3 x AWG12 (3 x 4mm <sup>2</sup> / #12US) IEC60309-32A
<p><b>It is mandatory for power lines and terminal boxes to be located within the immediate vicinity of the system and to be easily accessible. Each power line must be connected to a separate, independent electrical panel and bipolar circuit breaker.</b></p> <p><b>PDU's require an extra cable length of 1.5 meters for connection inside the cabinet.</b></p>	
<b>Electrical Specifications</b> (power supplies are auto-sensing and auto-ranging)	
Current draw Power consumption Thermal dissipation	29.5 A max. at 200 VAC input 3000 VA per full CSS module) 1500 VA (per PDU) 2700 W / 9250 BTU (per full CSS module) 1300 W / 4610 BTU (per PDU)
<b>Europe</b>	
Nominal voltage Voltage range Frequency	230 VAC (Phase / Neutral) 207 - 244 VAC 50 Hz 1%
<b>United States of America</b>	
Nominal voltage Voltage range Frequency	208 VAC (Phase / Neutral) 182 - 229 VAC 60 Hz 0.3%
<b>Japan</b>	
Nominal voltage Voltage range Frequency	200 VAC (Phase / Neutral) 188 - 212 VAC 60 Hz 0.2%
<b>Brazil</b>	
Nominal voltage Voltage range Frequency	220 VAC (Phase / Neutral) 212 - 231 VAC 60 Hz 2%
<b>Breaker Protection</b>	
Mains power CSS module Maximum inrush current Mains power PDU Maximum inrush current	20A Curve C 210A / per quarter period 20A Curve C 210A / per quarter period

Table 26. NovaScale 5320/6320 Server specifications

## NovaScale 5085 Server Specifications

NovaScale 5085 Servers are delivered rack-mounted in 40U or 19U cabinets.

Cabinet Dimensions / Weight	
Unpacked	Packed
<b>1300H</b>	
Height: 195.5 cm (77.0 in)	Height: 200.0 cm (78.7 in)
Width: 60.0 cm (23.6 in)	Width: 80.0 cm (31.5 in)
Depth: 129.5 cm (51.0 in)	Depth: 140.0 cm (55.1 in)
Weight (max): 340 kg (725 lb)	Weight (max): 370 kg (790 lb)
<b>1300L</b>	
Height: 103.5 cm (40.7 in)	Height: 108.0 cm (42.5 in)
Width: 60.0 cm (23.6 in)	Width: 80.0 cm (31.5 in)
Depth: 129.5 cm (51.0 in)	Depth: 140.0 cm (55.1 in)
Weight (max.): 290 kg (618 lb)	Weight (max.): 320 kg (682 lb)
Service Clearance	
Front	150 cm
Rear	100 cm
Side (free side)	100 cm
Operating Limits	
Dry bulb temperature range	+15°C to +30°C (+59°F to +86°F) Gradient 5°C/h (41°F/h)
Relative humidity (non-condensing)	35 to 60% (Gradient 5%/h)
Max. wet bulb temperature	+24°C (+75.2°F)
Moisture content	0.019 kg water/kg dry air
Pressure / Elevation	Sea level ≤ 2500 m
Optimum Operational Reliability	
Temperature	+ 22°C (± 3°C) (+ 72°F (± 5°F)
Hygrometry	50% (± 5%)
Non-Operating Limits	
Dry bulb temperature range	+5°C to +50°C (+41°F to +122°F) Gradient 25°C/h (77°F/h)
Relative humidity (non-condensing)	5 to 95% (Gradient 30%)
Max. wet bulb temperature	+28°C (+82.4°F)
Moisture content	0.024 kg water/kg dry air
Shipping Limits	
Dry bulb temperature range	-35°C to +65°C (-31°F to +149°F) Gradient 25°C/h (77°F/h)
Relative humidity (non-condensing)	5 to 95% Gradient 30%/h
Acoustic Power at Room Temperature +20° C (+68° F)	
System Running	System Idle
Lw(A) 6.3 Bels	Lw(A) 6.1 Bels

<b>Power Cables</b>	
<b>PDU-2-4-M-32A</b>	
AC (32A)	1 per PDU
Cable type	3 x AWG10 ( 3 x 6 mm <sup>2</sup> / #10US)
Connector type	IEC60309-32A
<b>It is mandatory for power lines and terminal boxes to be located within the immediate vicinity of the system and to be easily accessible. Each power line must be connected to a separate, independent electrical panel and bipolar circuit breaker. PDUs require an extra cable length of 1.5 meters for connection inside the cabinet.</b>	
<b>Electrical Specifications</b> (power supplies are auto-sensing and auto-ranging)	
Current draw	11 A max. at 200 VAC input
Power consumption	2400 VA per full CSS module
Thermal dissipation	2400 W / 8190 BTU per full CSS module
<b>Europe</b>	
Nominal voltage	230 VAC (Phase / Neutral)
Voltage range	207 - 244 VAC
Frequency	50 Hz 1%
<b>United States of America</b>	
Nominal voltage	208 VAC (Phase / Neutral)
Voltage range	182 - 229 VAC
Frequency	60 Hz 0.3%
<b>Japan</b>	
Nominal voltage	200 VAC (Phase / Neutral)
Voltage range	188 - 212 VAC
Frequency	60 Hz 0.2%
<b>Brazil</b>	
Nominal voltage	220 VAC (Phase / Neutral)
Voltage range	212 - 231 VAC
Frequency	60 Hz 2%
<b>Breaker Protection (Mains Power)</b>	
PDU-2-4-M-32A	32A Curve C
Maximum inrush current	210A / per quarter period

Table 27. NovaScale 5085 Server specifications

## NovaScale 5165 Server Specifications

NovaScale 5165 Servers are delivered rack-mounted in 40U or 19U cabinets.

Cabinet Dimensions / Weight	
Unpacked	Packed
<b>1300H</b>	<b>1300H</b>
Height: 195.5 cm (77.0 in)	Height: 200.0 cm (78.7 in)
Width: 60.0 cm (23.6 in)	Width: 80.0 cm (31.5 in)
Depth: 129.5 cm (51.0 in)	Depth: 140.0 cm (55.1 in)
Weight (max): 450 kg (959 lb)	Weight (max): 480 kg (1022 lb)
<b>1300L</b>	<b>1300L</b>
Height: 103.5 cm (40.7 in)	Height: 108.0 cm (42.5 in)
Width: 60.0 cm (23.6 in)	Width: 80.0 cm (31.5 in)
Depth: 129.5 cm (51.0 in)	Depth: 140.0 cm (55.1 in)
Weight (max.): 400 kg (852 lb)	Weight (max.): 430 kg (915 lb)
Service Clearance	
Front	150 cm
Rear	100 cm
Side (free side)	100 cm
Operating Limits	
Dry bulb temperature range	+15°C to +30°C (+59°F to +86°F) Gradient 5°C/h (41°F/h)
Relative humidity (non-condensing)	35 to 60% (Gradient 5%/h)
Max. wet bulb temperature	+24°C (+75.2°F)
Moisture content	0.019 kg water/kg dry air
Pressure / Elevation	Sea level ≤ 2500 m
Optimum Operational Reliability	
Temperature	+ 22°C (± 3°C) (+ 72°F (± 5°F)
Hygrometry	50% (± 5%)
Non-Operating Limits	
Dry bulb temperature range	+5°C to +50°C (+41°F to +122°F) Gradient 25°C/h (77°F/h)
Relative humidity (non-condensing)	5 to 95% (Gradient 30%)
Max. wet bulb temperature	+28°C (+82.4°F)
Moisture content	0.024 kg water/kg dry air
Shipping Limits	
Dry bulb temperature range	-35°C to +65°C (-31°F to +149°F) Gradient 25°C/h (77°F/h)
Relative humidity (non-condensing)	5 to 95% Gradient 30%/h

<b>Acoustic Power at Room Temperature +20° C (+68° F)</b>	
<b>System Running</b>	<b>System Idle</b>
Lw(A) 6.3 Bels	Lw(A) 6.1 Bels
<b>Power Cables</b>	
<b>PDU-2-4-M-32A</b>	
AC (32A)	1 per PDU
Cable type	3 x AWG10 (3 x 6 mm <sup>2</sup> / #10US)
Connector type	IEC60309-32A
<p><b>It is mandatory for power lines and terminal boxes to be located within the immediate vicinity of the system and to be easily accessible. Each power line must be connected to a separate, independent electrical panel and bipolar circuit breaker.</b></p> <p><b>PDU's require an extra cable length of 1.5 meters for connection inside the cabinet.</b></p>	
<b>Electrical Specifications</b> (power supplies are auto-sensing and auto-ranging)	
Current draw	11 A max. at 200 VAC input
Power consumption	2400 VA per full CSS module
Thermal dissipation	2400 W / 8190 BTU per full CSS module
<b>Europe</b>	
Nominal voltage	230 VAC (Phase / Neutral)
Voltage range	207 - 244 VAC
Frequency	50 Hz 1%
<b>United States of America</b>	
Nominal voltage	208 VAC (Phase / Neutral)
Voltage range	182 - 229 VAC
Frequency	60 Hz 0.3%
<b>Japan</b>	
Nominal voltage	200 VAC (Phase / Neutral)
Voltage range	188 - 212 VAC
Frequency	60 Hz 0.2%
<b>Brazil</b>	
Nominal voltage	220 VAC (Phase / Neutral)
Voltage range	212 - 231 VAC
Frequency	60 Hz 2%
<b>Breaker Protection (Mains Power)</b>	
PDU-2-4-M-32A	32A Curve C
Maximum inrush current	210A / per quarter period

Table 28. NovaScale 5165 Server specifications

## NovaScale 5245 Server Specifications

NovaScale 5245 Servers are delivered rack-mounted in 40U cabinets.

Cabinet Dimensions / Weight	
Unpacked	Packed
<b>1300H</b>	<b>1300H</b>
Height: 195.5 cm (77.0 in)	Height: 200.0 cm (78.7 in)
Width: 60.0 cm (23.6 in)	Width: 80.0 cm (31.5 in)
Depth: 129.5 cm (51.0 in)	Depth: 140.0 cm (55.1 in)
Weight (max): 560 kg (1193 lb)	Weight (max): 590 kg (1257 lb)
Service Clearance	
Front	150 cm
Rear	100 cm
Side (free side)	100 cm
Operating Limits	
Dry bulb temperature range	+15°C to +30°C (+59°F to +86°F) Gradient 5°C/h (41°F/h)
Relative humidity (non-condensing)	35 to 60% (Gradient 5%/h)
Max. wet bulb temperature	+24°C (+75.2°F)
Moisture content	0.019 kg water/kg dry air
Pressure / Elevation	Sea level ≤ 2500 m
Optimum Operational Reliability	
Temperature	+ 22°C (± 3°C) (+ 72°F (± 5°F)
Hygrometry	50% (± 5%)
Non-Operating Limits	
Dry bulb temperature range	+5°C to +50°C (+41°F to +122°F) Gradient 25°C/h (77°F/h)
Relative humidity (non-condensing)	5 to 95% (Gradient 30%)
Max. wet bulb temperature	+28°C (+82.4°F)
Moisture content	0.024 kg water/kg dry air
Shipping Limits	
Dry bulb temperature range	-35°C to +65°C (-31°F to +149°F) Gradient 25°C/h (77°F/h)
Relative humidity (non-condensing)	5 to 95% Gradient 30%/h
Acoustic Power at Room Temperature +20° C (+68° F)	
System Running	System Idle
Lw(A) 6.3 Bels	Lw(A) 6.1 Bels

<b>Power Cables</b>	
<b>PDU-2-4-M-32A</b>	
AC (32A)	1 per PDU
Cable type	3 x AWG10 (3 x 6 mm <sup>2</sup> / #10US)
Connector type	IEC60309-32A
<b>It is mandatory for power lines and terminal boxes to be located within the immediate vicinity of the system and to be easily accessible. Each power line must be connected to a separate, independent electrical panel and bipolar circuit breaker. PDUs require an extra cable length of 1.5 meters for connection inside the cabinet.</b>	
<b>Electrical Specifications</b> (power supplies are auto-sensing and auto-ranging)	
Current draw	11 A max. at 200 VAC input
Power consumption	2400 VA per full CSS module
Thermal dissipation	2400 W / 8190 BTU per full CSS module
<b>Europe</b>	
Nominal voltage	230 VAC (Phase / Neutral)
Voltage range	207 - 244 VAC
Frequency	50 Hz 1%
<b>United States of America</b>	
Nominal voltage	208 VAC (Phase / Neutral)
Voltage range	182 - 229 VAC
Frequency	60 Hz 0.3%
<b>Japan</b>	
Nominal voltage	200 VAC (Phase / Neutral)
Voltage range	188 - 212 VAC
Frequency	60 Hz 0.2%
<b>Brazil</b>	
Nominal voltage	220 VAC (Phase / Neutral)
Voltage range	212 - 231 VAC
Frequency	60 Hz 2%
<b>Breaker Protection (Mains Power)</b>	
PDU-2-4-M-32A	32A Curve C
Maximum inrush current	210A / per quarter period

Table 29. NovaScale 5245 Server specifications



## NovaScale 5325 Server Specifications

NovaScale 5325 Servers are delivered rack-mounted in 40U cabinets.

Cabinet Dimensions / Weight	
Unpacked	Packed
<b>1300H</b>	<b>1300H</b>
Height: 195.5 cm (77.0 in)	Height: 200.0 cm (78.7 in)
Width: 60.0 cm (23.6 in)	Width: 80.0 cm (31.5 in)
Depth: 129.5 cm (51.0 in)	Depth: 140.0 cm (55.1 in)
Weight (max): 670 kg (1427 lb)	Weight (max): 700 kg (1491 lb)
Service Clearance	
Front	150 cm
Rear	100 cm
Side (free side)	100 cm
Operating Limits	
Dry bulb temperature range	+15°C to +30°C (+59°F to +86°F) Gradient 5°C/h (41°F/h)
Relative humidity (non-condensing)	35 to 60% (Gradient 5%/h)
Max. wet bulb temperature	+24°C (+75.2°F)
Moisture content	0.019 kg water/kg dry air
Pressure / Elevation	Sea level ≤ 2500 m
Optimum Operational Reliability	
Temperature	+ 22°C (± 3°C) (+ 72°F (± 5°F)
Hygrometry	50% (± 5%)
Non-Operating Limits	
Dry bulb temperature range	+5°C to +50°C (+41°F to +122°F) Gradient 25°C/h (77°F/h)
Relative humidity (non-condensing)	5 to 95% (Gradient 30%)
Max. wet bulb temperature	+28°C (+82.4°F)
Moisture content	0.024 kg water/kg dry air
Shipping Limits	
Dry bulb temperature range	-35°C to +65°C (-31°F to +149°F) Gradient 25°C/h (77°F/h)
Relative humidity (non-condensing)	5 to 95% Gradient 30%/h
Acoustic Power at Room Temperature +20° C (+68° F)	
System Running	System Idle
Lw(A) 6.3 Bels	Lw(A) 6.1 Bels

<b>Power Cables</b>	
<b>PDU-2-4-M-32A</b>	
AC (32A)	1 per PDU
Cable type	3 x AWG10 (3 x 6 mm <sup>2</sup> / #10US)
Connector type	IEC60309-32A
<b>It is mandatory for power lines and terminal boxes to be located within the immediate vicinity of the system and to be easily accessible. Each power line must be connected to a separate, independent electrical panel and bipolar circuit breaker. PDUs require an extra cable length of 1.5 meters for connection inside the cabinet.</b>	
<b>Electrical Specifications</b> (power supplies are auto-sensing and auto-ranging)	
Current draw	11 A max. at 200 VAC input
Power consumption	2400 VA per full CSS module
Thermal dissipation	2400 W / 8190 BTU per full CSS module
<b>Europe</b>	
Nominal voltage	230 VAC (Phase / Neutral)
Voltage range	207 - 244 VAC
Frequency	50 Hz 1%
<b>United States of America</b>	
Nominal voltage	208 VAC (Phase / Neutral)
Voltage range	182 - 229 VAC
Frequency	60 Hz 0.3%
<b>Japan</b>	
Nominal voltage	200 VAC (Phase / Neutral)
Voltage range	188 - 212 VAC
Frequency	60 Hz 0.2%
<b>Brazil</b>	
Nominal voltage	220 VAC (Phase / Neutral)
Voltage range	212 - 231 VAC
Frequency	60 Hz 2%
<b>Breaker Protection (Mains Power)</b>	
PDU-2-4-M-32A	32A Curve C
Maximum inrush current	210A / per quarter period

Table 30. NovaScale 5325 Server specifications

## Smart UPS References

UPS Type	3KVA	5KVA	7.5KVA	10KVA
<b>Dimensions/Weight</b>				
Height	8.9cm (3.5in)	13cm (3.5in)	26cm (10in)	26cm (10in)
Width	48.3cm (19in)	43cm (17in)	43cm (17in)	43cm (17in)
Depth	66cm (26in)	66cm (26in)	66cm (26in)	66cm (26in)
Weight	43.6kg (96.0lb)	55kg (120lb)	111kg (244lb)	111kg (244lb)
<b>Outlets/power Out</b>				
9A (C13)	8	8	4	4
14.5A (C20)	1	2	4	4
Hard Wire	-	-	1	1
Max Power Out (Watts)	2700	3500	6000	8000
<b>Input Power &amp; Cables</b>				
Max Input Current	16A	24A	38A	50A
Voltage Range	160-280V	160-280V	160-280V	160-280V
Mains Cable Type	3xAWG14	3xAWG10	3xAWG08	3xAWG06
Mains Plug Type	IEC320-C20	IEC320-60309	Hard Wire	Hard Wire
Mains Socket Type	IEC320-C19	IEC320-60309	-	-
<b>BATTERIES (HOT PLUG)</b>	1xRBC43	2xRBC44	4xRBC44	4xRBC44
<b>Breaker</b>	16A	32A	50A	64A
<b>Bypass on</b>	No	Yes	Yes	No
<b>UPS Fail</b>		Auto & Manual	Auto & Manual	Auto & Manual

These 4 UPS are compliant with European Power regulation, 230V/2 phases + Neutral.  
For UPS models to be used in Northern America and other countries, consult your Bull representative.



## Appendix B. Conversion Tables

### Imperial to Metric

1 inch (")	2.54 cm (centimeters)
1 foot (') (12 inches)	30.48 cm
1 yards (yd) (3 feet)	0.91 m (meters)
1 mile (mi) (1760 yards)	1.6093 km (kilometers)
1 pound (avdp) (lb)	0.5 kg (kilograms)
1 ounce (avdp) (oz)	28.4 g (grams)
1 square foot (ft <sup>2</sup> )	0.093 m <sup>2</sup> (square meters)
1 square inch (in <sup>2</sup> )	6.5 cm <sup>2</sup> (square centimeters)
1 square yard (yd <sup>2</sup> )	0.8 m <sup>2</sup> (square meters)
1 acre	0.4 ha (hectares)
1 cubic foot (ft <sup>3</sup> )	0.03 m <sup>3</sup> (cubic meters)
1 horsepower (hp)	0.7 kw (kilowatts)
1 lb/ft <sup>2</sup>	4.88 kg/m <sup>2</sup>
1 Btu	0.2929 w hour

Table 31. Imperial to metric conversion table

### Metric to Imperial

1 meter (meter)	3.3' (feet) / 1.09 yd (yards)
1 centimeter (cm)	0.3937" (inches)
1 kilometer (km)	0.62 mi (miles)
1 gram (g)	0.04 oz (ounces (avdp))
1 kilogram (kg)	2.2 lbs (pounds (avdp))
1 sq. centimeter (cm <sup>2</sup> )	0.15 in <sup>2</sup> (square inches)
1 square meter (m <sup>2</sup> )	10.76 ft <sup>2</sup> (square feet)
1 square meter (m <sup>2</sup> )	1.2 yd <sup>2</sup> (square yards)
1 hectare (ha)	2.5 acres
1 cubic meters (m <sup>3</sup> )	35.3 ft <sup>3</sup> (cubic feet)
1 kilowatts (kW)	1.3 hp (horsepower)
1 kg/m <sup>2</sup>	0.205 lb/ft <sup>2</sup>
1 kW hour	3412 Btu (British thermal unit)

Table 32. Metric to imperial conversion table

### Celsius to Fahrenheit Conversion

Multiply the temperature in Celsius by 9, divide by 5 and add 32:

$$(C \times 9/5) + 32 = F$$

### Fahrenheit to Celsius Conversion

Subtract 32 degrees from the temperature in Fahrenheit, multiply by 5 and divide by 9:

$$(F - 32) \times 5/9 = C$$



---

# Index

## A

- Air
  - circulation, 3-3
  - distribution, 3-2
  - filtering, 3-2
  - pollution, 3-2
  - renewal, 3-2
- Air conditioning, 3-1
  - features, 3-1
  - functions, 3-1
  - specifications, 3-2
- Alarms, temperature, 3-5

## C

- Cable, cut-outs, 2-3
- Cables, network, 2-4
- Cabling, 2-3
  - requirements, 4-2
- Carry-in, route, 1-2
- Ceiling, 2-10
  - suspended, 2-10
- Cleaning, 2-11
- Connection, neutral point, 4-6
- Control
  - hygrometry, 3-1
  - temperature, 3-1

## D

- Delivery, 1-2
- Dynamic safety, 3-5

## E

- Electromagnetic compatibility, xi
- Electrostatic discharges, xii
- Emergency, lighting, 4-8
- Environmental standards, xi
- Equipment, ancillary, 2-12

## F

- Features
  - raised floor, 2-9
  - suspended ceiling, 2-10
- Fire
  - alarms, 2-8
  - detection, 2-7
  - extinguishing agents, 2-8
  - extinguishing procedure, 2-7
  - protection, 2-7
- Floor
  - computer room, 2-9
  - primary, 2-9
  - raised, 2-9
- Floor plan, system, 2-6

## G

- Grounding, 4-5
  - raised floor, 4-5

## H

- Heat dissipation, 3-1
- Hygrometry, control, 3-1

## I

- Installation, server, 2-3
- Interference
  - electrical, 2-7
  - electromagnetic, 2-7

## L

- Layout, data processing center, 2-1
- Lighting
  - ambient, 4-8
  - emergency, 4-8
- Limits
  - audio-noise, xiii
  - pollution, xiii

## M

- Media storage room, 2-12

## N

- Network, cables, 2-4
- Neutral, power system, 4-6
- Neutral point, connection, 4-6
- NovaScale Series, A-15

## P

- Paper storage room, 2-12
- Pollutants, 3-4
- Pollution, air, 3-2
- Power cables, sockets, 4-3
- Power supply, 4-1
  - non-computing, 4-8
  - system, 4-1
- Power system, neutral, 4-6
- Primary floor, 2-9
- Printing room, 2-12
- Protection
  - fire, 2-7
  - sunlight, 2-11

## R

- Raised floor, 2-9
- Requirements, cabling, 4-2

## S

- Safety
  - dynamic, 3-5
  - specifications, xiii
- Server
  - cabinet, 1-1
  - installation, 2-3
- Server components, power cables, 4-3
- Shocks and vibrations, xii

Site, layout grid, 2-6  
 Sound-proofing, 2-11  
 Specifications
 

- air-conditioning, 3-2
- Blade 2020, A-7
- Blade 2021, A-7
- Blade 2040, A-7
- Blade 2320, A-8
- Blade B260 Server, A-8
- Blade B260+ Server, A-8
- Blade B280 Server, A-9
- chassis, NovaScale Blade 20xx, A-6
- chassis 7U, NovaScale Blade, A-4
- chassis 9U, Bull Blade, A-5
- atmospheric, xi
- electrical, xi
- NovaScale 20xx Cabinets, A-2
- NovaScale 3xx5 Cabinets, A-10
- NovaScale 4020 Server, A-17
- NovaScale 4040 Server, A-18
- NovaScale 421 Servers, A-19
- NovaScale 422 Servers, A-20
- NovaScale 5080/5160 Servers, A-25
- NovaScale 5085 Servers, A-29
- NovaScale 5165 Server, A-31
- NovaScale 5245 Server, A-33
- NovaScale 5320/6320 Servers, A-27
- NovaScale 5325 Server, A-35
- NovaScale Series, A-15
- NovaScale universal R421-E1 Servers, A-21
- NovaScale universal R422-E1 /R422-INF-E1 Servers, A-22
- NovaScale universal R423 Servers, A-23
- NovaScale universal R425 Servers, A-24
- safety, xiii
- system, A-1
- Sunlight, protection, 2-11
- Suspended ceiling, 2-10
- System
  - dimensions, A-1
  - service clearance, 2-5
  - weight, A-1

**T**

Temperature
 

- alarms, 3-5
- control, 3-1

**U**

Unpacking, 1-3

**W**

Water damage, 2-8



## Technical publication remarks form

<b>Title :</b> NOVASCALE Site Preparation Guide
---

<b>Reference:</b> 86 A1 87EF 10
---------------------------------

<b>Date:</b> January 2008
---------------------------

### ERRORS IN PUBLICATION

--

### SUGGESTIONS FOR IMPROVEMENT TO PUBLICATION

--

Your comments will be promptly investigated by qualified technical personnel and action will be taken as required.  
If you require a written reply, please include your complete mailing address below.

NAME : \_\_\_\_\_ Date : \_\_\_\_\_

COMPANY : \_\_\_\_\_

ADDRESS : \_\_\_\_\_

Please give this technical publication remarks form to your BULL representative or mail to:

Bull - Documentation D<sup>é</sup>pt.  
1 Rue de Provence  
BP 208  
38432 ECHIROLLES CEDEX  
FRANCE  
info@frec.bull.fr

# Technical publications ordering form

To order additional publications, please fill in a copy of this form and send it via mail to:

**BULL CEDOC**  
**357 AVENUE PATTON**  
**B.P.20845**  
**49008 ANGERS CEDEX 01**  
**FRANCE**

**Phone:** +33 (0) 2 41 73 72 66  
**FAX:** +33 (0) 2 41 73 70 66  
**E-Mail:** [srv.Duplicopy@bull.net](mailto:srv.Duplicopy@bull.net)

Reference	Designation	Qty
-- -- -- -- -- [ -- ]		
-- -- -- -- -- [ -- ]		
-- -- -- -- -- [ -- ]		
-- -- -- -- -- [ -- ]		
-- -- -- -- -- [ -- ]		
-- -- -- -- -- [ -- ]		
-- -- -- -- -- [ -- ]		
-- -- -- -- -- [ -- ]		
-- -- -- -- -- [ -- ]		
-- -- -- -- -- [ -- ]		
-- -- -- -- -- [ -- ]		
-- -- -- -- -- [ -- ]		
[ -- ] : The latest revision will be provided if no revision number is given.		

NAME: \_\_\_\_\_ Date: \_\_\_\_\_

COMPANY: \_\_\_\_\_

ADDRESS: \_\_\_\_\_

PHONE: \_\_\_\_\_ FAX: \_\_\_\_\_

E-MAIL: \_\_\_\_\_

**For Bull Subsidiaries:**

Identification: \_\_\_\_\_

**For Bull Affiliated Customers:**

Customer Code: \_\_\_\_\_

**For Bull Internal Customers:**

Budgetary Section: \_\_\_\_\_

**For Others: Please ask your Bull representative.**



**BULL CEDOC**  
**357 AVENUE PATTON**  
**B.P.20845**  
**49008 ANGERS CEDEX 01**  
**FRANCE**

REFERENCE  
**86 A1 87EF 10**

Utiliser les marques de découpe pour obtenir les étiquettes.  
Use the cut marks to get the labels.



**NOVASCALE**

Site Preparation  
Guide

86 A1 87EF 10



**NOVASCALE**

Site Preparation  
Guide

86 A1 87EF 10

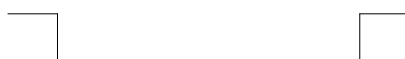

**NOVASCALE**

Site Preparation  
Guide

86 A1 87EF 10



