

NovaScale R430 F2

Hardware Owner's Manual

NOVASCALÉ



REFERENCE
86 A1 62FD 00

NOVASCALE

NovaScale R430 F2

Hardware Owner's Manual

Hardware

December 2009

BULL CEDOC
357 AVENUE PATTON
B.P.20845
49008 ANGERS CEDEX 01
FRANCE

REFERENCE
86 A1 62FD 00

The following copyright notice protects this book under Copyright laws which prohibit such actions as, but not limited to, copying, distributing, modifying, and making derivative works.

Copyright © Bull SAS 2009

Trademarks and Acknowledgements

Citrix and XenServer are trademarks of Citrix Systems, Inc. and/or more of its subsidiaries, and may be registered in the United States

Patent and Trademark Office and in other countries. Intel and Xeon are registered trademarks of Intel Corporation in the U.S. and other countries; Microsoft, Hyper-V, Windows, and Windows Server are either trademarks or registered trademarks of Microsoft Corporation in the United States and/or other countries. Red Hat and Enterprise Linux are registered trademarks of Red Hat, Inc. in the United States and other countries; SUSE is a registered trademark of Novell, Inc., in the United States and other countries. VMware is a registered trademark of VMware, Inc. in the United States and/or other jurisdictions.

Other trademarks and trade names may be used in this document to refer to either the entities claiming the marks and names or their products. Bull disclaims any proprietary interest in trademarks and trade names other than its own.

We acknowledge the rights of the proprietors of the trademarks mentioned in this manual.

All brand names and software and hardware product names are subject to trademark and/or patent protection.

Quoting of brand and product names is for information purposes only and does not represent trademark misuse.

The information in this document is subject to change without notice. Bull will not be liable for errors contained herein, or for incidental or consequential damages in connection with the use of this material.

Contents

1	About Your System	7
	Accessing System Features During Startup	7
	Front-Panel Features and Indicators	8
	LCD Panel Features (Optional)	10
	Hard Drive Status Indicators	14
	Back-Panel Features and Indicators	15
	Guidelines for Connecting Optional External Devices	17
	NIC Indicator Codes	17
	Power Indicator Codes	18
	Diagnostic Lights (Optional)	19
	LCD Status Messages (Optional)	21
	System Messages	35
	Warning Messages	52
	Diagnostics Messages	52
	Alert Messages	52

2	Using the System Setup Program and UEFI Boot Manager	55
	Choosing the System Boot Mode	55
	Entering the System Setup Program	56
	System Setup Options	57
	Entering the UEFI Boot Manager	68
	System and Setup Password Features	71
	Embedded System Management	75
	Baseboard Management Controller Configuration.	76
	iDRAC Configuration Utility	76
3	Installing System Components	79
	Recommended Tools	79
	Inside the System	79
	Removing and Replacing the Optional Front Bezel	81
	Opening and Closing the System	82
	Hard Drives	84
	Power Supplies	92
	Expansion Cards	96
	Integrated Storage Controller Card	99
	Expansion-Card Riser	102
	Internal USB Memory Key	104

System Board Shroud	105
Integrated Remote Access Controller 6 (iDRAC6) Express Card (Optional)	107
Integrated Remote Access Controller 6 (iDRAC6) Enterprise Card (Optional)	109
VFlash Media (Optional)	112
Cooling Fans	112
Optical Drive	114
RAID Battery (Optional)	117
System Memory	119
Processors	126
System Battery	131
Control Panel Assembly-LED/LCD (Service-Only Procedure) (Optional)	133
SAS Backplane (Service-Only Procedure)	137
Power Distribution Board (Service-Only Procedure)	139
System Board (Service-Only Procedure)	141
4 Troubleshooting Your System	147
Safety First—For You and Your System	147
Troubleshooting System Startup Failure	147
Troubleshooting External Connections	147
Troubleshooting the Video Subsystem	148

Troubleshooting a USB Device	148
Troubleshooting a Serial I/O Device	149
Troubleshooting a NIC	149
Troubleshooting a Wet System	150
Troubleshooting a Damaged System	151
Troubleshooting the System Battery.	152
Troubleshooting Power Supplies	153
Troubleshooting System Cooling Problems	153
Troubleshooting a Fan.	154
Troubleshooting System Memory	154
Troubleshooting an Internal USB Key.	156
Troubleshooting an Optical Drive	157
Troubleshooting an External Tape Drive	157
Troubleshooting a Hard Drive.	158
Troubleshooting a SAS or SAS RAID Controller	160
Troubleshooting Expansion Cards.	161
Troubleshooting the Microprocessors	162

5 Running the System Diagnostics 165

Using Online Diagnostics 165

Embedded System Diagnostics Features 165

When to Use the Embedded System Diagnostics 166

Running the Embedded System Diagnostics	166
Embedded System Diagnostics Testing Options.	166
Using the Custom Test Options	167
6 Getting Help	169
Contacting Bull	169
.	169
7 Jumpers and Connectors	171
System Board Jumpers	171
System Board Connectors.	172
Disabling a Forgotten Password.	174
Glossary	177
Index	187

About Your System

Accessing System Features During Startup

The following keystrokes provide access to system features during startup.



Keystroke	Description
<F2>	Enters the System Setup program. See "Using the System Setup Program and UEFI Boot Manager" on page 55.
<F10>	Enters System Services, which opens the Unified Server Configurator. The Unified Server Configurator allows you to access utilities such as embedded system diagnostics. For more information, see the Unified Server Configurator documentation.
<F11>	Enters the BIOS Boot Manager or the UEFI Boot Manager, depending on the system's boot configuration. See "Using the System Setup Program and UEFI Boot Manager" on page 55.
<F12>	Starts PXE boot.
<Ctrl+E>	Enters the Baseboard Management Controller (BMC) or iDRAC Configuration Utility, which allows access to the system event log (SEL) and configuration of remote access to the system. For more information, see the BMC or iDRAC user documentation.
<Ctrl+C>	Enters the SAS Configuration Utility. See your SAS adapter documentation for more information.
<Ctrl+R>	Enters the RAID configuration utility. For more information, see the documentation for your SAS RAID card.
<Ctrl+S>	Enters the utility to configure NIC settings for PXE boot. For more information, see the documentation for your integrated NIC.

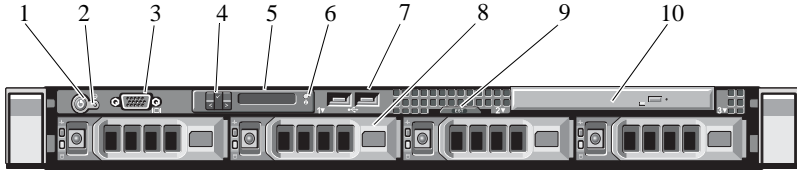

Front-Panel Features and Indicators

Figure 1-1. Front-Panel Features and Indicators



Item	Indicator, Button, or Connector	Icon	Description
1	Power-on indicator, power button		<p>The power-on indicator lights when the system power is on.</p> <p>The power button controls the DC power supply output to the system. When the optional system bezel is installed, the power button is not accessible.</p> <p>NOTE: When powering on the system, the video monitor can take from several seconds to over 2 minutes to display an image, depending on the amount of memory installed in the system.</p> <p>NOTE: On ACPI-compliant operating systems, turning off the system using the power button causes the system to perform a graceful shutdown before power to the system is turned off.</p> <p>NOTE: To force an ungraceful shutdown, press and hold the power button for five seconds.</p>

Item	Indicator, Button, or Connector	Icon	Description
2	NMI button		<p>Used to troubleshoot software and device driver errors when using certain operating systems. This button can be pressed using the end of a paper clip.</p> <p>Use this button only if directed to do so by qualified support personnel or by the operating system's documentation.</p>
3	Video connector		Connects a monitor to the system.
4	LCD menu buttons		Allows you to navigate the control panel LCD menu.
5	LED or LCD panel		<p>NOTE: Depending on the configuration, your system may have either LED diagnostic indicators or an LCD panel.</p> <p>LED panel: The four diagnostic indicator lights display error codes during system startup. See "Diagnostic Lights (Optional)" on page 19.</p> <p>LCD panel: Provides system ID, status information, and system error messages.</p> <p>The LCD lights during normal system operation. Both the systems management software and the identification buttons located on the front and back of the system can cause the LCD to flash blue to identify a particular system.</p> <p>The LCD lights amber when the system needs attention, and the LCD panel displays an error code followed by descriptive text.</p> <p>NOTE: If the system is connected to AC power and an error has been detected, the LCD lights amber regardless of whether the system has been powered on.</p>

Item	Indicator, Button, or Connector	Icon	Description
6	System identification button		The identification buttons on the front and back panels can be used to locate a particular system within a rack. When one of these buttons is pushed, the LCD panel on the front and the blue system status indicator on the back blink until one of the buttons is pushed again.
7	USB connectors (2)		Connects USB devices to the system. The ports are USB 2.0-compliant.
8	Hard drives (4)		Up to four 2.5-inch in 3.5-inch HDD hot swap carrier or up to four 3.5-inch cabled/hot swap.
9	System identification panel		A slide-out panel for system information including the Express Service tag, embedded NIC MAC address, and iDRAC6 Enterprise card MAC address.
10	Optical drive (optional)		One optional slim-line SATA DVD-ROM drive or DVD+/-RW drive. NOTE: DVD devices are data only.

LCD Panel Features (Optional)

The system's LCD panel provides system information and status and error messages to signify when the system is operating correctly or when the system needs attention. See "LCD Status Messages (Optional)" on page 21 for information on specific status codes.

The LCD backlight lights blue during normal operating conditions and lights amber to indicate an error condition. When the system is in standby mode, the LCD backlight will switch off after five minutes of inactivity, and can be turned on by pressing the Select button on the LCD panel. The LCD backlight will remain off if LCD messaging is turned off through the BMC or iDRAC utility, the LCD panel, or other tools.

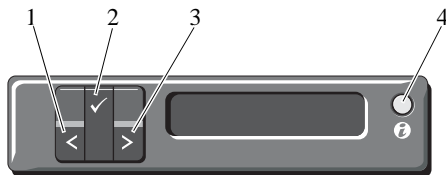

Figure 1-2. LCD Panel Features



Item	Buttons	Description
1	Left	Moves the cursor back in one-step increments.
2	Select	Selects the menu item highlighted by the cursor.
3	Right	Moves the cursor forward in one-step increments. During message scrolling: <ul style="list-style-type: none"> • Press once to increase scrolling speed. • Press again to stop. • Press again to return to default scrolling. • Press again to repeat the cycle.
4	System ID	Turns the system ID mode on and off. (LCD panel flashes blue) after "system ID mode on." Press quickly to toggle the system ID on and off. If the system hangs during POST, press and hold the system ID button for more than five seconds to enter BIOS Progress mode.

Home Screen

The Home screen displays user-configurable information about the system. This screen is displayed during normal system operation when there are no status messages or errors present. When the system is in standby mode, the LCD backlight will turn off after five minutes of inactivity if there are no error messages. Press one of the three navigation buttons (Select, Left, or Right) to view the Home screen.

To navigate to the Home screen from another menu, continue to select the up arrow  until the Home icon  is displayed, and then select the Home icon.

Setup Menu

Option	Description
BMC or DRAC NOTE: If an iDRAC6 Express card is installed on the system, the BMC option is replaced by DRAC.	Select DHCP or Static IP to configure the network mode. If Static IP is selected, the available fields are IP , Subnet (Sub), and Gateway (Gtw). Select Setup DNS to enable DNS and to view domain addresses. Two separate DNS entries are available.
Set error	Select SEL to display LCD error messages in a format that matches the IPMI description in the SEL. This can be useful when trying to match an LCD message with an SEL entry. Select Simple to display LCD error messages in a more user-friendly description. See "LCD Status Messages (Optional)" on page 21 for a list of messages in this format.
Set home	Select the default information to be displayed on the LCD Home screen. See "View Menu" on page 13 to see the options and option items that can be selected to display by default on the Home screen.

View Menu

Option	Description
BMC IP or DRAC IP NOTE: If an iDRAC6 Express card is installed on the system, the BMC IP option is replaced by DRAC IP.	Displays the IPv4 or IPv6 addresses for the optional iDRAC6. Addresses include DNS (Primary and Secondary), Gateway, IP, and Subnet (IPv6 does not have Subnet). NOTE: BMC IP supports only IPv4 addresses.
MAC	Displays the MAC addresses for DRAC, iSCSI_n, or NET_n . NOTE: If the iDRAC6 Express card is not installed on the system, the MAC option displays the MAC addresses for BMC, iSCSI _n , or NET _n .
Name	Displays the name of the Host, Model, or User String for the system.
Number	Displays the Asset tag or the Service tag for the system.
Power	Displays the power output of the system in BTU/hr or Watts. The display format can be configured in the "Set home" submenu of the Setup menu (see "Setup Menu" on page 12).
Temperature	Displays the temperature of the system in Celsius or Fahrenheit. The display format can be configured in the "Set home" submenu of the Setup menu (see "Setup Menu" on page 12).

Hard Drive Status Indicators

Figure 1-3. Hard Drive Indicators

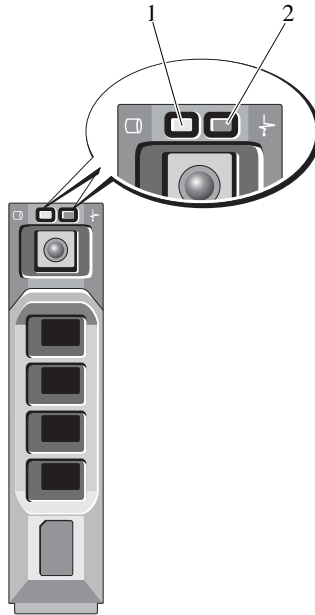

- 1 drive-activity indicator (green) 2 drive-status indicator (green and amber)

Drive-Status Indicator Pattern (RAID Only)	Condition
Blinks green two times per second	Identify drive/preparing for removal
Off	Drive ready for insertion or removal

NOTE: The drive status indicator remains off until all hard drives are initialized after system power is applied. Drives are not ready for insertion or removal during this time.





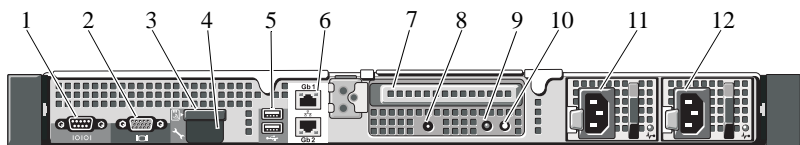

Drive-Status Indicator Pattern (RAID Only)	Condition
Blinks green, amber, and off	Drive predicted failure
Blinks amber four times per second	Drive failed
Blinks green slowly	Drive rebuilding
Steady green	Drive online
Blinks green three seconds, amber three seconds, and off six seconds.	Rebuild aborted

Back-Panel Features and Indicators

Figure 1-4 shows the controls, indicators, and connectors located on the system's back panel.

Figure 1-4. Back-Panel Features and Indicators



Item	Indicator, Button, or Connector	Icon	Description
1	serial connector		Connects a serial device to the system.
2	video connector		Connects a VGA display to the system.
3	VFlash media slot (optional)		Connects an external SD memory card for the optional iDRAC6 Enterprise card.
4	iDRAC6 Enterprise port (optional)		Dedicated management port for the optional iDRAC6 Enterprise card.
5	USB connectors (2)		Connects USB devices to the system. The ports are USB 2.0-compliant.
6	Ethernet connectors (2)		Embedded 10/100/1000 NIC connectors.

Item	Indicator, Button, or Connector	Icon	Description
7	PCIe slot 1		PCI Express (generation 2) x16-wide expansion slot (full-height, half-length).
8	Active ID CMA connector		Connector for attaching a system indicator extension cable that is used on a cable management arm.
9	System status indicator light		<p>Lights blue during normal system operation.</p> <p>Both the systems management software and the identification buttons located on the front and back of the system can cause the indicator to flash blue to identify a particular system.</p> <p>Lights amber when the system needs attention due to a problem.</p>
10	system identification button		<p>Turns the system ID modes on and off.</p> <p>The identification buttons on the front and back panels can be used to locate a particular system within a rack. When one of these buttons is pushed, the LCD panel on the front and the system status indicator on the chassis back panel light blue until one of the buttons is pushed again.</p>
11	power supply 1(PS1)		500-W power supply (redundant).
12	power supply 2(PS2)		500-W power supply (redundant) or 480-W power supply (non-redundant).

Guidelines for Connecting Optional External Devices

- Turn off power to the system and external devices before attaching a new external device. Turn on any external devices before turning on the system (unless the documentation for the device specifies otherwise).
- Ensure that the appropriate driver for the attached device has been installed on the system.
- If necessary to enable ports on your system, use the System Setup program. See "Using the System Setup Program and UEFI Boot Manager" on page 55.

NIC Indicator Codes

Figure 1-5. NIC Indicators

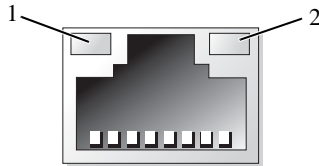

1 link indicator

2 activity indicator

Indicator	Indicator Code
Link and activity indicators are off	The NIC is not connected to the network.
Link indicator is green	The NIC is connected to a valid link partner on the network.
Link indicator is amber	The NIC is connected to a valid network link at 10/100 Mbps.
Activity indicator is amber blinking	Network data is being sent or received.

Power Indicator Codes

An LED indicator on the power button indicates when power is supplied to the system and the system is operational.

The power supplies have an indicator that shows whether power is present or whether a power fault has occurred.

- Not lit — AC power is not connected.
- Green — In standby mode, indicates that a valid AC source is connected to the power supply, and that the power supply is operational. When the system is on, it also indicates that the power supply is providing DC power to the system.
- Amber — Indicates a problem with the power supply.
- Alternating green and amber — When hot-adding a power supply, this indicates that the power supply is mismatched with the other power supply (a high output power supply and a Energy Smart power supply are installed in the same system). Replace the power supply that has the flashing indicator with a power supply that matches the capacity of the other installed power supply.

Figure 1-6. Power Supply Status Indicator

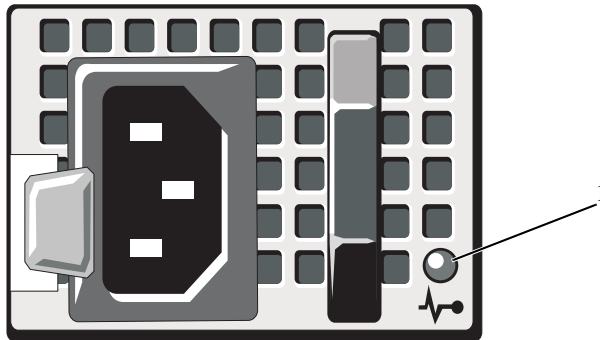

1 power supply status

Diagnostic Lights (Optional)

The four diagnostic indicator lights on the system front panel display error codes during system startup. Table 1-1 lists the causes and possible corrective actions associated with these codes. A highlighted circle indicates the light is on; a non-highlighted circle indicates the light is off.

 **NOTE:** The diagnostic LEDs are not present when the system is equipped with an LCD display.

Table 1-1. Diagnostic Indicator Codes (Optional)

























Code	Causes	Corrective Action
   	<p>The system is in a normal off condition or a possible pre-BIOS failure has occurred.</p> <p>The diagnostic lights are not lit after the system successfully boots to the operating system.</p> <p>The system is in a normal operating condition after POST.</p>	<p>Plug the system into a working electrical outlet and press the power button.</p> <p>Information only.</p>
   	<p>BIOS checksum failure detected; system is in recovery mode.</p>	<p>See "Getting Help" on page 169.</p>
   	<p>Possible processor failure.</p>	<p>See "Troubleshooting the Microprocessors" on page 162.</p>
   	<p>Memory failure.</p>	<p>See "Troubleshooting System Memory" on page 154.</p>
   	<p>Possible expansion card failure.</p>	<p>See "Troubleshooting Expansion Cards" on page 161.</p>
   	<p>Possible video failure.</p>	<p>See "Getting Help" on page 169.</p>

Table 1-1. Diagnostic Indicator Codes (Optional) (continued)

Code	Causes	Corrective Action
① ② ③ ④	hard drive failure.	Ensure that the diskette drive and hard drive are properly connected. See "Hard Drives" on page 84 for information on the drives installed in your system.
① ② ③ ④	Possible USB failure.	See "Troubleshooting a USB Device" on page 148.
① ② ③ ④	No memory modules detected.	See "Troubleshooting System Memory" on page 154.
① ② ③ ④	System board failure.	See "Getting Help" on page 169.
① ② ③ ④	Memory configuration error.	See "Troubleshooting System Memory" on page 154.
① ② ③ ④	Possible system board resource and/or system board hardware failure.	See "Getting Help" on page 169.
① ② ③ ④	Possible system resource configuration error.	See "Contacting Bull" on page 169.
① ② ③ ④	Other failure.	Ensure that the diskette drive, optical drive, and hard drives are properly connected. See "Troubleshooting Your System" on page 147 for the appropriate drive installed in your system. If the problem persists, see "Getting Help" on page 169.

LCD Status Messages (Optional)

The system's control panel LCD provides status messages to signify when the system is operating correctly or when the system needs attention.

The LCD lights blue to indicate a normal operating condition, and lights amber to indicate an error condition. The LCD scrolls a message that includes a status code followed by descriptive text. The table that follows provides a listing of LCD status messages and the probable cause for each message. The LCD messages refer to events recorded in the System Event Log (SEL). For information on the SEL and configuring system management settings, see the systems management software documentation.



NOTE: If your system fails to boot, press the System ID button for at least five seconds until an error code appears on the LCD. Record the code, then see "Getting Help" on page 169.

Table 1-2. LCD Status Messages (Optional)

Code	Text	Causes	Corrective Actions
<i>N/A</i>	<i>SYSTEM NAME</i>	<i>A 62-character string that can be defined by the user in the System Setup program.</i> The <i>SYSTEM NAME</i> displays under the following conditions: <ul style="list-style-type: none">• The system is powered on.• The power is off and active errors are displayed.	This message is for information only. You can change the system ID and name in the System Setup program. See "Using the System Setup Program and UEFI Boot Manager" on page 55.
E1000	Failsafe voltage error. Contact support.	Check the system event log for critical failure events.	Remove AC power to the system for 10 seconds and restart the system. If the problem persists, see "Getting Help" on page 169.

Table 1-2. LCD Status Messages (Optional) (continued)

Code	Text	Causes	Corrective Actions
E1114	Ambient Temp exceeds allowed range.	Ambient temperature has reached a point outside of the allowed range.	See "Troubleshooting System Cooling Problems" on page 153.
E1116	Memory disabled, temp above range. Power cycle AC.	Memory has exceeded allowable temperature and has been disabled to prevent damage to the components.	Remove AC power to the system for 10 seconds and restart the system. See "Troubleshooting System Cooling Problems" on page 153. If the problem persists, see "Getting Help" on page 169.
E1210	Motherboard battery failure. Check battery.	CMOS battery is missing or the voltage is outside of the allowable range.	See "Troubleshooting the System Battery" on page 152.
E1211	RAID Controller battery failure. Check battery.	RAID battery is either missing, bad, or unable to recharge due to thermal issues.	Reseat the RAID battery connector. See "Installing the RAID Battery" on page 118, and "Troubleshooting System Cooling Problems" on page 153.
E1216	3.3V Regulator failure. Reseat PCIe cards.	3.3V voltage regulator has failed.	Remove and reseat the PCIe expansion cards. If the problem persists, see "Troubleshooting Expansion Cards" on page 161.
E1229	CPU # VCORE Regulator failure. Reseat CPU.	Specified processor VCORE voltage regulator has failed.	Reseat the processor(s). See "Troubleshooting the Microprocessors" on page 162. If the problem persists, see "Getting Help" on page 169.

Table 1-2. LCD Status Messages (Optional) (*continued*)

Code	Text	Causes	Corrective Actions
E122A	CPU # VTT Regulator failure. Reseat CPU.	Specified processor VTT voltage regulator has failed.	Reseat the processor(s). See "Troubleshooting the Microprocessors" on page 162. If the problem persists, see "Getting Help" on page 169.
E122C	CPU Power Fault. Power cycle AC.	A power fault was detected when powering up the processor(s).	Remove AC power to the system for 10 seconds and restart the system. If the problem persists, see "Getting Help" on page 169.
E122D	Memory Regulator # Failed. Reseat DIMMs.	One of the memory regulators has failed.	Reseat the memory modules. See "Troubleshooting System Memory" on page 154.
E122E	On-board regulator failed. Call support.	One of the on-board voltage regulators failed.	Remove AC power to the system for 10 seconds and restart the system. If the problem persists, see "Getting Help" on page 169.
E1310	Fan ## RPM exceeding range. Check fan.	RPM of specified fan is outside of the intended operating range.	See "Troubleshooting System Cooling Problems" on page 153.
E1311	Fan module ## RPM exceeding range. Check fan.	RPM of specified fan in specified module is outside of intended operating range.	See "Troubleshooting System Cooling Problems" on page 153.

Table 1-2. LCD Status Messages (Optional) (continued)

Code	Text	Causes	Corrective Actions
E1313	Fan redundancy lost. Check fans.	The system is no longer fan redundant. Another fan failure would put the system at risk of over-heating.	Check LCD for additional scrolling messages. See "Troubleshooting a Fan" on page 154.
E1410	Internal Error detected. Check "FRU X".	Specified processor has an internal error. The error may or may not have been caused by the processor.	Remove AC power to the system for 10 seconds and restart the system. If the problem persists, see "Getting Help" on page 169.
E1414	CPU # temp exceeding range. Check CPU heatsink.	Specified processor is out of acceptable temperature range.	Ensure that the processor heat sinks are properly installed. See "Troubleshooting the Microprocessors" on page 162 and "Troubleshooting System Cooling Problems" on page 153.
E1418	CPU # not detected. Check CPU is seated properly.	Specified processor is missing or bad, and the system is in an unsupported configuration.	Ensure that the specified microprocessor is properly installed. See "Troubleshooting the Microprocessors" on page 162.
E141C	Unsupported CPU configuration. Check CPU or BIOS revision.	Processors are in an unsupported configuration.	Ensure that your processors match and conform to the type described in the processor technical specifications outlined in your system's <i>Getting Started Guide</i> .

Table 1-2. LCD Status Messages (Optional) (*continued*)

Code	Text	Causes	Corrective Actions
E141F	CPU # protocol error. Power cycle AC.	The system BIOS has reported a processor protocol error.	Remove AC power to the system for 10 seconds and restart the system. If the problem persists, see "Getting Help" on page 169.
E1420	CPU Bus parity error. Power cycle AC.	The system BIOS has reported a processor bus parity error.	Remove AC power to the system for 10 seconds and restart the system. If the problem persists, see "Getting Help" on page 169.
E1422	CPU # machine check error. Power cycle AC.	The system BIOS has reported a machine check error.	Remove AC power to the system for 10 seconds and restart the system. If the problem persists, see "Getting Help" on page 169.
E1610	Power Supply # (### W) missing. Check power supply.	Specified power supply was removed or is missing from the system.	See "Troubleshooting Power Supplies" on page 153.
E1614	Power Supply # (### W) error. Check power supply.	Specified power supply has failed.	See "Troubleshooting Power Supplies" on page 153.
E1618	Predictive failure on Power Supply # (### W). Check PSU.	An over-temperature condition or power supply communication error has caused the predictive warning of an impending power supply failure.	See "Troubleshooting Power Supplies" on page 153.

Table 1-2. LCD Status Messages (Optional) (*continued*)

Code	Text	Causes	Corrective Actions
E161C	Power Supply # (### W) lost AC power. Check PSU cables.	Specified power supply is attached to the system, but it has lost its AC input.	Check the AC power source for the specified power supply. If the problem persists, see "Troubleshooting Power Supplies" on page 153.
E1620	Power Supply # (### W) AC power error. Check PSU cables.	Specified power supply's AC input is outside of the allowable range.	Check the AC power source for the specified power supply. If the problem persists, see "Troubleshooting Power Supplies" on page 153.
E1624	Lost power supply redundancy. Check PSU cables.	The power supply subsystem is no longer redundant. If the remaining power supply fails, the system will shut down.	See "Troubleshooting Power Supplies" on page 153.
E1626	Power Supply Mismatch. PSU1 = ### W, PSU2 = ### W.	The power supplies in the system are not the same wattage.	Ensure that power supplies with matching wattage are installed. See the Technical Specifications outlined in your system's <i>Getting Started Guide</i> .
E1629	Power required > PSU wattage. Check PSU and config.	The system configuration requires more power than the power supplies can provide, even with throttling.	Turn off power to the system, reduce the hardware configuration or install higher-wattage power supplies, and then restart the system.

Table 1-2. LCD Status Messages (Optional) (*continued*)

Code	Text	Causes	Corrective Actions
E1710	I/O channel check error. Review & clear SEL.	The system BIOS has reported an I/O channel check.	Check the SEL for more information and then clear the SEL. Remove AC power to the system for 10 seconds and restart the system. If the problem persists, see "Getting Help" on page 169.
E1711	PCI parity error on Bus ## Device ## Function ##	The system BIOS has reported a PCI parity error on a component that resides in PCI configuration space at bus ##, device ##, function ##.	Remove and reseal the PCIe expansion cards. If the problem persists, see "Troubleshooting Expansion Cards" on page 161.
	PCI parity error on Slot #. Review & clear SEL.	The system BIOS has reported a PCI parity error on a component that resides in the specified slot.	Remove and reseal the PCIe expansion cards. If the problem persists, see "Troubleshooting Expansion Cards" on page 161.
E1712	PCI system error on Bus ## Device ## Function ##	The system BIOS has reported a PCI system error on a component that resides in PCI configuration space at bus ##, device ##, function ##.	Remove and reseal the PCIe expansion cards. If the problem persists, see "Troubleshooting Expansion Cards" on page 161.

Table 1-2. LCD Status Messages (Optional) (*continued*)

Code	Text	Causes	Corrective Actions
E1714	Unknown error. Review & clear SEL.	The system BIOS has determined there has been an error in the system, but is unable to determine its origin.	Check the SEL for more information and then clear the SEL. Remove AC power to the system for 10 seconds and restart the system. If the problem persists, see "Getting Help" on page 169.
E171F	PCIe fatal error on Bus ## Device ## Function ##	The system BIOS has reported a PCIe fatal error on a component that resides in PCI configuration space at bus ##, device ##, function ##.	Remove and reseal the PCIe expansion cards. If the problem persists, see "Troubleshooting Expansion Cards" on page 161.
E1810	Hard drive ## fault. Review & clear SEL.	The specified hard drive has experienced a fault.	See "Troubleshooting a Hard Drive" on page 158.
E1812	Hard drive ## removed. Check drive.	The specified hard drive has been removed from the system.	Information only.
E1920	iDRAC6 Upgrade Failed.	optional iDRAC6 upgrade has failed.	See "Troubleshooting Expansion Cards" on page 161.
E1A14	SAS cable A failure. Check connection.	SAS cable A is missing or bad.	Reseat the cable. If the problem persists, replace cable. If the problem persists, see "Getting Help" on page 169.

Table 1-2. LCD Status Messages (Optional) (*continued*)

Code	Text	Causes	Corrective Actions
E1A15	SAS cable B failure. Check connection.	SAS cable B is missing or bad.	Reseat the cable. If the problem persists, replace cable. If the problem persists, see "Getting Help" on page 169.
E1A1D	Control panel USB cable not detected. Check cable.	USB cable to the control panel is missing or bad.	Reseat the cable. If the problem persists, replace cable. If the problem persists, see "Getting Help" on page 169.
E2010	Memory not detected. Inspect DIMMs.	No memory was detected in the system.	Install memory or reseat memory modules. See "Installing Memory Modules" on page 123 or "Troubleshooting System Memory" on page 154.
E2011	Memory configuration failure. Check DIMMs.	Memory detected, but is not configurable. Error detected during memory configuration.	See "Troubleshooting System Memory" on page 154.
E2012	Memory configured but unusable. Check DIMMs.	Memory configured, but is unusable.	See "Troubleshooting System Memory" on page 154.
E2013	BIOS unable to shadow memory. Check DIMMs.	The system BIOS failed to copy its flash image into memory.	See "Troubleshooting System Memory" on page 154.
E2014	CMOS RAM failure. Power cycle AC.	CMOS failure. CMOS RAM not functioning properly.	Remove AC power to the system for 10 seconds and restart the system. If the problem persists, see "Getting Help" on page 169.

Table 1-2. LCD Status Messages (Optional) (*continued*)

Code	Text	Causes	Corrective Actions
E2015	DMA Controller failure. Power cycle AC.	DMA controller failure.	Remove AC power to the system for 10 seconds and restart the system. If the problem persists, see "Getting Help" on page 169.
E2016	Interrupt Controller failure. Power cycle AC.	Interrupt controller failure.	Remove AC power to the system for 10 seconds and restart the system. If the problem persists, see "Getting Help" on page 169.
E2017	Timer refresh failure. Power cycle AC.	Timer refresh failure.	Remove AC power to the system for 10 seconds and restart the system. If the problem persists, see "Getting Help" on page 169.
E2018	Programmable Timer error. Power cycle AC.	Programmable interval timer error.	Remove AC power to the system for 10 seconds and restart the system. If the problem persists, see "Getting Help" on page 169.
E2019	Parity error. Power cycle AC.	Parity error.	Remove AC power to the system for 10 seconds and restart the system. If the problem persists, see "Getting Help" on page 169.

Table 1-2. LCD Status Messages (Optional) (*continued*)

Code	Text	Causes	Corrective Actions
E201A	SuperIO failure. Power cycle AC.	SIO failure.	Remove AC power to the system for 10 seconds and restart the system. If the problem persists, see "Getting Help" on page 169.
E201B	Keyboard Controller error. Power cycle AC.	Keyboard controller failure.	Remove AC power to the system for 10 seconds and restart the system.If the problem persists, see "Getting Help" on page 169.
E201C	SMI initialization failure. Power cycle AC.	System management interrupt (SMI) initialization failure.	Remove AC power to the system for 10 seconds and restart the system. If the problem persists, see "Getting Help" on page 169.
E201D	Shutdown test failure. Power cycle AC.	BIOS shutdown test failure.	Remove AC power to the system for 10 seconds and restart the system. If the problem persists, see "Getting Help" on page 169.
E201E	POST memory test failure. Check DIMMs.	BIOS POST memory test failure.	See "Troubleshooting System Memory" on page 154. If the problem persists, see "Getting Help" on page 169.
E2020	CPU configuration failure. Check screen message.	Processor configuration failure.	Check screen for specific error messages. See "Troubleshooting the Microprocessors" on page 162.

Table 1-2. LCD Status Messages (Optional) (*continued*)

Code	Text	Causes	Corrective Actions
E2021	Incorrect memory configuration. Review User Guide.	Incorrect memory configuration.	Check screen for specific error messages. See "Troubleshooting System Memory" on page 154.
E2022	General failure during POST. Check screen message.	General failure after video.	Check screen for specific error messages.
E2023	BIOS Unable to mirror memory. Check DIMMs.	The system BIOS could not enable memory mirroring because of a faulty memory module or an invalid memory configuration.	See "Troubleshooting System Memory" on page 154.
E2110	Multibit Error on DIMM ##. Reseat DIMM.	The memory module in slot "##" has had a multi-bit error (MBE).	See "Troubleshooting System Memory" on page 154.
E2111	SBE log disabled on DIMM ##. Reseat DIMM.	The system BIOS has disabled memory single-bit error (SBE) logging and will not log anymore SBEs until the system is rebooted. "##" represents the memory module implicated by the BIOS.	Remove AC power to the system for 10 seconds and restart the system. If the problem persists, see "Troubleshooting System Memory" on page 154.
E2112	Memory spared on DIMM ##. Power cycle AC.	The system BIOS has spared the memory because it has determined the memory had too many errors. "##" represents the memory module implicated by the BIOS.	Remove AC power to the system for 10 seconds and restart the system. If the problem persists, see "Troubleshooting System Memory" on page 154.

Table 1-2. LCD Status Messages (Optional) (*continued*)

Code	Text	Causes	Corrective Actions
E2113	Mem mirror OFF on DIMM ## & ##. Power cycle AC	The system BIOS has disabled memory mirroring because it has determined one half of the mirror has had too many errors. "## & ##" represents the memory-module pair implicated by the BIOS.	Remove AC power to the system for 10 seconds and restart the system. If the problem persists, see "Troubleshooting System Memory" on page 154.
I1910	Intrusion detected. Check chassis cover.	System cover has been removed.	Information only.
I1911	LCD Log Full. Check SEL to review all Errors.	LCD overflow message. A maximum of ten error messages can display sequentially on the LCD. The eleventh message instructs the user to check the SEL for details on the events.	Check the SEL for details on the events. Remove AC power to the system for 10 seconds or clear the SEL.
I1912	SEL full. Review & clear log.	The SEL is full of events and is unable to log any more.	Check the SEL for details on the events, then clear the SEL.
I1920	iDRAC6 Upgrade Successful	optional iDRAC6 has been upgraded successfully.	Information only.
W1228	RAID Controller battery capacity < 24hr.	Warns predictively that the RAID battery has less than 24 hours of charge left.	Allow RAID battery to charge to greater than 24 hours of sustained charge. If problem persists, replace RAID battery. See "Installing the RAID Battery" on page 118.

Table 1-2. LCD Status Messages (Optional) (continued)

Code	Text	Causes	Corrective Actions
W1627	Power required > PSU wattage. Check PSU and config.	The system configuration requires more power than what the power supply can provide.	Turn off power to the system, reduce the hardware configuration or install higher-wattage power supplies, and then restart the system.
W1628	Performance degraded. Check PSU and system configuration.	The system configuration requires more power than what the power supply can provide, but it can boot if throttled.	Turn off power to the system, reduce the hardware configuration or install higher-wattage power supplies, and then restart the system.

NOTE: For the full name of an abbreviation or acronym used in this table, see the "Glossary" on page 177.

Solving Problems Described by LCD Status Messages (Optional)

The code and text on the LCD can often specify a very precise fault condition that is easily corrected. For example, if the code `E1418 CPU_1_Presence` appears, you know that a microprocessor is not installed in socket 1.

In contrast, you might be able to determine the problem if multiple related errors occur. For example, if you receive a series of messages indicating multiple voltage faults, you might determine that the problem is a failing power supply.

Removing LCD Status Messages (Optional)

For faults associated with sensors, such as temperature, voltage, fans, and so on, the LCD message is automatically removed when that sensor returns to a normal state. For example, if temperature for a component goes out of range, the LCD displays the fault; when the temperature returns to the acceptable range, the message is removed from the LCD. For other faults, you must take action to remove the message from the display:

- Clear the SEL — You can perform this task remotely, but you will lose the event history for the system.
- Power cycle — Turn off the system and disconnect it from the electrical outlet; wait approximately ten seconds, reconnect the power cable, and restart the system.

Any of these actions will remove fault messages, and return the status indicators and LCD colors to the normal state. Messages will reappear under the following conditions:

- The sensor returns to a normal state but fails again, resulting in a new SEL entry.
- The system is reset and new error events are detected.
- A failure is recorded from another source that maps to the same display entry.

System Messages

System messages appear on the screen to notify you of a possible problem with the system.



NOTE: If you receive a system message not listed in the table, check the documentation for the application that is running when the message appears or the operating system's documentation for an explanation of the message and recommended action.

Table 1-3. System Messages

Message	Causes	Corrective Actions
128-bit Advanced ECC mode disabled. For 128-bit Advanced ECC, DIMMs must be installed in pairs. Pairs must be matched in size and geometry.	The Advanced ECC option was enabled in BIOS, but is no longer valid due to an unsupported memory configuration, possibly a faulty or removed memory module. The Advanced ECC setting has been disabled.	Check other messages for a faulty memory module. Reconfigure the memory modules for Advanced ECC mode. See "System Memory" on page 119.
Alert! Advanced ECC Memory Mode disabled! Memory configuration does not support Advanced ECC Memory Mode.	Advanced ECC Memory Mode was enabled in the system setup program, but the current configuration does not support Advanced ECC Memory Mode. A memory module may be faulty.	Ensure that the memory modules are installed in a configuration that supports Advanced ECC Memory Mode. Check other system messages for additional information for possible causes. For memory configuration information, see "General Memory Module Installation Guidelines" on page 119. If the problem persists, see "Troubleshooting System Memory" on page 154.
Alert! iDRAC6 not responding. Rebooting.	The optional iDRAC6 is not responding to BIOS communication either because it is not functioning properly or has not completed initialization. The system will reboot.	Wait for the system to reboot.

Table 1-3. System Messages (*continued*)

Message	Causes	Corrective Actions
Alert! iDRAC6 not responding. Power required may exceed PSU wattage.	The optional iDRAC6 has hung. The optional iDRAC6 was remotely reset while system was booting.	Remove AC power to the system for 10 seconds and restart the system.
Alert! Continuing system boot accepts the risk that system may power down without warning.	After AC recovery, the optional iDRAC6 takes longer than normal to boot.	
Alert! Node Interleaving disabled! Memory configuration does not support Node Interleaving.	The memory configuration does not support node interleaving, or the configuration has changed (for example, a memory module has failed) so that node interleaving cannot be supported. The system will still run, but without node interleaving.	Ensure that the memory modules are installed in a configuration that supports node interleaving. Check other system messages for additional information for possible causes. For memory configuration information, see "General Memory Module Installation Guidelines" on page 119. If the problem persists, see "Troubleshooting System Memory" on page 154.

Table 1-3. System Messages (*continued*)

Message	Causes	Corrective Actions
Alert! Power required exceeds PSU wattage. Check PSU and system configuration.	The system configuration of processor(s), memory modules, and expansion cards may not be supported by the power supplies.	If any system components were just upgraded, return the system to the previous configuration. If the system boots without this warning, then the replaced component(s) are not supported with this power supply. If Energy Smart power supplies are installed, replace them with High Output power supplies to use the components. See "Power Supplies" on page 92.
Alert! Continuing system boot accepts the risk that system may power down without warning.		
Alert! Redundant memory disabled! Memory configuration does not support redundant memory.	Memory Sparing or Memory Mirroring was enabled in the system setup program, but the current configuration does not support redundant memory. A memory module may be faulty.	Check the memory modules for failure. See "Troubleshooting System Memory" on page 154. Reset the memory setting, if appropriate. See "Using the System Setup Program and UEFI Boot Manager" on page 55.
Alert! System fatal error during previous boot.	An error caused the system to reboot.	Check other system messages for additional information for possible causes.

Table 1-3. System Messages (*continued*)

Message	Causes	Corrective Actions
BIOS MANUFACTURING MODE detected. MANUFACTURING MODE will be cleared before the next boot. System reboot required for normal operation.	System is in manufacturing mode.	Reboot to take the system out of manufacturing mode.
BIOS Update Attempt Failed!	Remote BIOS update attempt failed.	Retry the BIOS update. If problem persists, see "Getting Help" on page 169.
Caution! NVRAM_CLR jumper is installed on system board. Please run SETUP	NVRAM_CLR jumper is installed in the clear setting. CMOS has been cleared.	Move the NVRAM_CLR jumper to the default position (pins 3 and 5). See Figure 7-1 for jumper location. Restart the system and re-enter the BIOS settings. See "Using the System Setup Program and UEFI Boot Manager" on page 55.
CPU set to minimum frequency.	The processor speed may be intentionally set lower for power conservation.	If not an intentional setting, check any other system messages for possible causes.
CPU x installed with no memory.	Memory modules are required but not installed in the indicated processor's memory slots.	Install memory modules for the processor. See "System Memory" on page 119.

Table 1-3. System Messages (*continued*)

Message	Causes	Corrective Actions
CPUs with different cache sizes detected.	Mismatched processors have been installed in the system.	Ensure that all processors have the same cache size, number of cores and logical processors, and power rating.
CPUs with different core sizes detected! System halted		Ensure that the processors are properly installed. See "Processors" on page 126.
CPUs with different logical processors detected! System halted		
CPUs with different power rating detected! System halted		
Current boot mode is set to UEFI. Please ensure compatible bootable media is available. Use the system setup program to change the boot mode as needed.	The system failed to boot because UEFI boot mode is enabled in BIOS and the boot operating system is non-UEFI.	Ensure that the boot mode is set correctly and that the proper bootable media is available. See "Using the System Setup Program and UEFI Boot Manager" on page 55.
Decreasing available memory	Faulty or improperly installed memory modules.	Reseat the memory modules. See "Troubleshooting System Memory" on page 154.
DIMM configuration on each CPU should match.	Invalid memory configuration on a dual-processor system. The memory module configuration for each processor must be identical.	Ensure that the memory modules are installed in a valid configuration. See "General Memory Module Installation Guidelines" on page 119.

Table 1-3. System Messages (*continued*)

Message	Causes	Corrective Actions
Embedded NICx and NICy: OS NIC=<ENABLED /DISABLED>, Management Shared NIC= <ENABLED /DISABLED>	The OS NIC interface is set in BIOS. The Management Shared NIC interface is set in management tools.	Check the system management software or the System Setup program for NIC settings. If a problem is indicated, see "Troubleshooting a NIC" on page 149.
Error 8602 - Auxiliary Device Failure. Verify that mouse and keyboard are securely attached to correct connectors.	Mouse or keyboard cable is loose or improperly connected. Defective mouse or keyboard.	Reseat the mouse or keyboard cable. Ensure that the mouse or keyboard is operational. See "Troubleshooting a USB Device" on page 148.
Gate A20 failure	Faulty keyboard controller; faulty system board.	See "Getting Help" on page 169.
Invalid configuration information - please run SETUP program.	An invalid system configuration caused a system halt.	Run the System Setup program and review the current settings. See "Using the System Setup Program and UEFI Boot Manager" on page 55.
Invalid PCIe card found in the Internal_Storage slot!	The system halted because an invalid PCIe expansion card is installed in the dedicated storage controller slot.	Remove the PCIe expansion card and install the integrated storage controller in the dedicated slot. See "RAID Battery (Optional)" on page 117.
Keyboard fuse has failed	Overcurrent detected at the keyboard connector.	See "Getting Help" on page 169.

Table 1-3. System Messages (*continued*)

Message	Causes	Corrective Actions
Local keyboard may not work because all user accessible USB ports are disabled. If operating locally, power cycle the system and enter system setup program to change settings.	The USB ports are disabled in the system BIOS.	Power down and restart the system from the power button, and then enter the System Setup program to enable the USB port(s). See "Entering the System Setup Program" on page 56.
Manufacturing mode detected	System is in manufacturing mode.	Reboot to take the system out of manufacturing mode.
Maximum rank count exceeded. The following DIMM has been disabled: x	Invalid memory configuration. The system will run but with the specified memory module disabled.	Ensure that the memory modules are installed in a valid configuration. See "General Memory Module Installation Guidelines" on page 119.
Memory Initialization Warning: Memory size may be reduced	Invalid memory configuration. The system will run but with less memory than is physically available.	Ensure that the memory modules are installed in a valid configuration. See "General Memory Module Installation Guidelines" on page 119.
Memory set to minimum frequency.	The memory frequency may be intentionally set lower for power conservation. The current memory configuration may support only the minimum frequency.	If not an intentional setting, check any other system messages for possible causes. Ensure that your memory configuration supports the higher frequency. See "General Memory Module Installation Guidelines" on page 119.

Table 1-3. System Messages (*continued*)

Message	Causes	Corrective Actions
Memory tests terminated by keystroke.	POST memory test was terminated by pressing the spacebar.	Information only.
MEMTEST lane failure detected on x	Invalid memory configuration. Mismatched memory modules are installed.	Ensure that the memory modules are installed in a valid configuration. See "General Memory Module Installation Guidelines" on page 119.
Mirror mode disabled. For mirror mode, DIMMs must be installed in pairs. Pairs must be matched in size and geometry.	The memory configuration does not match the setting in BIOS. The BIOS setting has been disabled.	Reconfigure the memory modules for Memory Mirroring mode. See "System Memory" on page 119.
No boot device available	Faulty or missing optical drive subsystem, hard drive, or hard drive subsystem, or no bootable USB key installed.	Use a bootable USB key, optical drive, or hard drive. If the problem persists, see "Troubleshooting an Optical Drive" on page 157, "Troubleshooting a USB Device" on page 148, "Troubleshooting an Internal USB Key" on page 156, and "Troubleshooting a Hard Drive" on page 158. See "Using the System Setup Program and UEFI Boot Manager" on page 55 for information on setting the order of boot devices.

Table 1-3. System Messages (*continued*)

Message	Causes	Corrective Actions
No boot sector on hard drive	Incorrect configuration settings in System Setup program, or no operating system on hard drive.	Check the hard drive configuration settings in the System Setup program. See "Using the System Setup Program and UEFI Boot Manager" on page 55. If necessary, install the operating system on your hard drive. See your operating system documentation.
No timer tick interrupt	Faulty system board.	See "Getting Help" on page 169.
PCIe Training Error: Expected Link Width is <i>x</i> , Actual Link Width is <i>y</i> .	Faulty or improperly installed PCIe card in the specified slot.	Reseat the PCIe card in the specified slot number. See "Troubleshooting Expansion Cards" on page 161. If the problem persists, see "Getting Help" on page 169.
Plug & Play Configuration Error	Error encountered in initializing PCIe device; faulty system board.	Install the NVRAM_CLR jumper in the clear position (pins 1 and 3) and reboot the system. See Figure 7-1 for jumper location. If the problem persists, see "Troubleshooting Expansion Cards" on page 161.
Quad rank DIMM detected after single rank or dual rank DIMM in socket.	Invalid memory configuration.	Ensure that the memory modules are installed in a valid configuration. See "General Memory Module Installation Guidelines" on page 119.

Table 1-3. System Messages (*continued*)

Message	Causes	Corrective Actions
Read fault Requested sector not found	The operating system cannot read from the hard drive, optical drive, or USB device, the system could not find a particular sector on the disk, or the requested sector is defective.	Replace the optical medium, USB medium, or USB device. Ensure that the USB cables, SAS/SATA backplane cables, or optical drive cables are properly connected. See "Troubleshooting a USB Device" on page 148, "Troubleshooting an Optical Drive" on page 157, or "Troubleshooting a Hard Drive" on page 158 for the appropriate drive(s) installed in your system.
SATA Port x device not found	There is no device connected to the specified SATA port.	Information only.
Sector not found Seek error Seek operation failed	Faulty hard drive, USB device, or USB medium.	Replace the USB medium or device. Ensure that the USB or SAS backplane cables are properly connected. See "Troubleshooting a USB Device" on page 148 or "Troubleshooting a Hard Drive" on page 158 for the appropriate drive(s) installed in your system.
Shutdown failure	General system error.	See "Getting Help" on page 169.
Sparing mode disabled. For sparing mode, matched sets of three must be populated across slots.	The memory configuration does not match the setting in BIOS. The BIOS setting has been disabled.	Reconfigure the memory modules for Memory Sparing mode. See "System Memory" on page 119.

Table 1-3. System Messages (*continued*)

Message	Causes	Corrective Actions
The amount of system memory has changed	Memory has been added or removed or a memory module may be faulty.	If memory has been added or removed, this message is informative and can be ignored. If memory has not been added or removed, check the SEL to determine if single-bit or multi-bit errors were detected and replace the faulty memory module. See "Troubleshooting System Memory" on page 154.
The following DIMMs should match in geometry: x, x, ... The following DIMMs should match in rank count: x, x, ... The following DIMMs should match in size: x, x, ... The following DIMMs should match in size and geometry: x, x, ... The following DIMMs should match in size and rank count: x, x, ...	Invalid memory configuration. The specified memory modules do not match in size, number of ranks, or number of data lanes.	Ensure that the memory modules are installed in a valid configuration. See "General Memory Module Installation Guidelines" on page 119.

Table 1-3. System Messages (*continued*)

Message	Causes	Corrective Actions
Thermal sensor not detected on x	A memory module without a thermal sensor is installed in the specified memory slot.	Replace the memory module. See "System Memory" on page 119.
Time-of-day clock stopped	Faulty battery or faulty chip.	See "Troubleshooting the System Battery" on page 152.
Time-of-day not set - please run SETUP program	Incorrect Time or Date settings; faulty system battery.	Check the Time and Date settings. See "Using the System Setup Program and UEFI Boot Manager" on page 55. If the problem persists, replace the system battery. See "System Battery" on page 131.
Timer chip counter 2 failed	Faulty system board.	See "Getting Help" on page 169.
TPM configuration operation honored. System will now reset.	A TPM configuration command has been entered. The system will reboot and execute the command.	Information only.
TPM configuration operation is pending. Press (I) to Ignore OR (M) to Modify to allow this change and reset the system. WARNING: Modifying could prevent security.	This message displays during system restart after a TPM configuration command has been entered. User interaction is required to proceed.	Enter I or M to proceed.
TPM failure	A Trusted Platform Module (TPM) function has failed.	See "Getting Help" on page 169.

Table 1-3. System Messages (*continued*)

Message	Causes	Corrective Actions
Unable to launch System Services image. System halted!	System halted after F10 keystroke because System Services image is either corrupted in the system firmware or has been lost due to system board replacement. The optional iDRAC6 Enterprise card flash memory or BMC SPI flash may be corrupted.	Restart the system and update the Unified Server Configurator repository to the latest software to restore full functionality. See the Unified Server Configuration user documentation for more information. Restore the flash memory using the latest version on support.bull.com. See the <i>Integrated Remote Access Controller 6 (iDRAC6) User Guide</i> for instructions on performing a field replacement of the flash memory.
Unexpected interrupt in protected mode	Improperly seated memory modules or faulty keyboard/mouse controller chip.	Reseat the memory modules. See "Troubleshooting System Memory" on page 154. If the problem persists, see "Getting Help" on page 169.
Unsupported CPU combination Unsupported CPU stepping detected	Processor(s) is not supported by the system.	Install a supported processor or processor combination. See "Processors" on page 126.
Unsupported DIMM detected. The following DIMM has been disabled: x	Invalid memory configuration. The system will run but with the specified memory module disabled.	Ensure that the memory modules are installed in a valid configuration. See "General Memory Module Installation Guidelines" on page 119.

Table 1-3. System Messages (*continued*)

Message	Causes	Corrective Actions
Unsupported memory configuration. DIMM mismatch across slots detected: <i>x, x, . . .</i>	Invalid memory configuration. Memory modules are mismatched in the specified slots.	Ensure that the memory modules are installed in a valid configuration. See "General Memory Module Installation Guidelines" on page 119.
Unused memory detected. DIMM's installed in the following slot are not available when in mirror mode: <i>x, x, x</i>	The memory configuration is not optimal for mirroring Mode. Modules in the specified slots are unused.	Reconfigure the memory for Memory Mirroring Mode, or change the memory mode to Optimized or Sparing in the BIOS setup screen. See "System Memory" on page 119.
Unused memory detected. DIMM's installed in the following slot are not available when in 128-bit advanced ECC mode: <i>x, x, x</i>	The memory configuration is not optimal for Advanced ECC Memory Mode. Modules in the specified slots are unused.	Reconfigure the memory for Advanced ECC Memory Mode, or change the memory mode to Optimized or Sparing in the BIOS setup screen. See "System Memory" on page 119.
Warning: A fatal error has caused system reset! Please check the system event log!	A fatal system error occurred and caused the system to reboot.	Check the SEL for information that was logged during the error. See the applicable troubleshooting section in "Troubleshooting Your System" on page 147 for any faulty components specified in the SEL.

Table 1-3. System Messages (*continued*)

Message	Causes	Corrective Actions
Warning: Control Panel is not installed.	The control panel is not installed or has a faulty cable connection.	Install the control panel, or check the cable connections between the display module, the control panel board, and the system board. See "Control Panel Assembly-LED/LCD (Service-Only Procedure) (Optional)" on page 133.
Warning! No micro code update loaded for processor n	Micro code update failed.	Update the BIOS firmware. See "Getting Help" on page 169.
Warning! Power required exceeds PSU wattage. Check PSU and system configuration. Warning! Performance degraded. CPU and memory set to minimum frequencies to meet PSU wattage. System will reboot.	The system configuration of processor(s), memory modules, and expansion cards may not be supported by the power supplies.	If any system components were just upgraded, return the system to the previous configuration. If the system boots without this warning, then the replaced component(s) are not supported with this power supply. If Energy Smart power supplies are installed, replace them with the High Output power supplies to use the components. See "Power Supplies" on page 92.
Warning! PSU mismatch. PSU redundancy lost. Check PSU.	A High Output power supply and an Energy Smart power supply are installed in the system at the same time.	Install two High Output or two Energy Smart power supplies in the system. You can also run the system on one power supply until you can obtain two power supplies of the same type. See "Troubleshooting Power Supplies" on page 153.

Table 1-3. System Messages (*continued*)

Message	Causes	Corrective Actions
Warning! Unsupported memory configuration detected. The memory configuration is not optimal. The recommended memory configuration is: <message>	Invalid memory configuration. The system will run but with reduced functionality.	Ensure that the memory modules are installed in a valid configuration. See "General Memory Module Installation Guidelines" on page 119. If the problem persists, see "Troubleshooting System Memory" on page 154.
Write fault Write fault on selected drive	Faulty USB device, USB medium, optical drive assembly, hard drive, or hard drive subsystem.	Replace the USB medium or device. Ensure that the USB, SAS backplane, or SATA cables are properly connected. See "Troubleshooting a USB Device" on page 148, "Troubleshooting an Internal USB Key" on page 156, "Troubleshooting an Optical Drive" on page 157, and "Troubleshooting a Hard Drive" on page 158.

NOTE: For the full name of an abbreviation or acronym used in this table, see the "Glossary" on page 177.

Warning Messages

A warning message alerts you to a possible problem and prompts you to respond before the system continues a task. For example, before you format a diskette, a message will warn you that you may lose all data on the diskette. Warning messages usually interrupt the task and require you to respond by typing y (yes) or n (no).



NOTE: Warning messages are generated by either the application or the operating system. For more information, see the documentation that accompanied the operating system or application.

Diagnostics Messages

The system diagnostic utilities may issue messages if you run diagnostic tests on your system. See "Running the Embedded System Diagnostics" on page 166 for more information about system diagnostics.

Alert Messages

Systems management software generates alert messages for your system. Alert messages include information, status, warning, and failure messages for drive, temperature, fan, and power conditions. For more information, see the systems management software documentation.

Using the System Setup Program and UEFI Boot Manager

The System Setup program is the BIOS program that enables you to manage your system hardware and specify BIOS-level options. From the System Setup program, you can:

- Change the NVRAM settings after you add or remove hardware
- View the system hardware configuration
- Enable or disable integrated devices
- Set performance and power management thresholds
- Manage system security

Choosing the System Boot Mode

The System Setup program also enables you to specify the boot mode for installing your operating system:

- BIOS boot mode (the default) is the standard BIOS-level boot interface.
- UEFI boot mode is an enhanced 64-bit boot interface based on Unified Extensible Firmware Interface (UEFI) specifications that overlays the system BIOS. See "Entering the UEFI Boot Manager" on page 68 for more information on this interface.

You select the boot mode in the **Boot Mode** field of the Boot Settings screen of the System Setup program. See "Boot Settings Screen" on page 62. Once you specify the boot mode, the system boots in that mode and you proceed then to install your operating system from that mode. Thereafter, you must boot the system to the same boot mode (BIOS or UEFI) to access the installed operating system. Trying to boot the operating system from the other boot mode will cause the system to halt immediately at startup.



NOTE: Operating systems must be UEFI-compatible (for example, Microsoft® Windows Server® 2008 x64 version) to be installed from the UEFI boot mode. DOS and 32-bit operating systems do not support UEFI and can only be installed from the BIOS boot mode.

Entering the System Setup Program

- 1 Turn on or restart your system.
- 2 Press <F2> after you see the following message:

<F2> = System Setup



NOTE: The system will not respond until the USB keyboard is active.

If your operating system begins to load before you press <F2>, allow the system to finish booting, and then restart your system and try again.

Responding to Error Messages

If an error message appears while the system is booting, make a note of the message. See "System Messages" on page 35 for an explanation of the message and suggestions for correcting errors.



NOTE: After installing a memory upgrade, it is normal for your system to display a message that the system memory size has changed the first time you start your system.

Using the System Setup Program Navigation Keys

Keys	Action
Up arrow or <Shift><Tab>	Moves to the previous field.
Down arrow or <Tab>	Moves to the next field.
Spacebar, <+>, <->, left and right arrows	Cycles through the settings in a field. In many fields, you can also type the appropriate value.
<Esc>	Exits the System Setup program and restarts the system if any changes were made.
<F1>	Displays the System Setup program's help file.



NOTE: For most of the options, any changes that you make are recorded but do not take effect until you restart the system.

System Setup Options

Main Screen

Figure 2-1. Main System Setup Program Screen

BIOS Version xx.yy.zz [This is DOS Setup]			
Service Tag: xxxxxxxx	Asset Tag: xxxxxxxxxx		
<pre> System Time00:00:00 System DateDAY/MO/DATE/YR Memory Settings<Enter> Processor Settings<Enter> SATA Settings<Enter> Boot Settings<Enter> Integrated Devices<Enter> PCI IRQ Assignment<Enter> Serial Communication<Enter> Embedded Server Management<Enter> Power Management<Enter> </pre>			
Up,Down Arrow to select	SPACE, +, - to change	ESC to exit	F1 = Help

 **NOTE:** The options for the System Setup program change based on the system configuration.

 **NOTE:** The System Setup program defaults are listed under their respective options in the following sections, where applicable.

Option	Description
System Time	Sets the time on the system's internal clock.
System Date	Sets the date on the system's internal calendar.
Memory Settings	Displays information related to installed memory. See "Memory Settings Screen" on page 60.

Option	Description
Processor Settings	Displays information related to microprocessors (speed, cache size, and so on). See "Processor Settings Screen" on page 60.
SATA Settings	See "SATA Settings Screen" on page 61.
Boot Settings	See "Boot Settings Screen" on page 62.
Integrated Devices	See "Integrated Devices Screen" on page 63.
PCI IRQ Assignment	Displays a screen to change the IRQ assigned to each of the integrated devices on the PCI bus, and any installed expansion card that requires an IRQ.
Serial Communication (Off default)	See "Serial Communication Screen" on page 64.
Embedded Server Management	See "Embedded Server Management Screen (Optional)" on page 65.
Power Management	See "Power Management Screen" on page 65.
System Security	Displays a screen to configure the system password and setup password features. See "System Security Screen" on page 66, "Using the System Password" on page 71, and "Using the Setup Password" on page 74 for more information.
Keyboard NumLock (On default)	Determines whether your system starts up with the NumLock mode activated on 101- or 102-key keyboards (does not apply to 84-key keyboards).
Report Keyboard Errors (Report default)	Enables or disables reporting of keyboard errors during the POST. Select Report for host systems that have keyboards attached. Select Do Not Report to suppress all error messages relating to the keyboard or keyboard controller during POST. This setting does not affect the operation of the keyboard itself if a keyboard is attached to the system.

Option	Description
F1/F2 Prompt on Error (Enabled default)	<p data-bbox="356 240 1006 355">Enables the system to halt on errors during POST, which allows the user to observe events that may scroll by unnoticed during normal POST. You can select F1 to continue or F2 to enter the System Setup program.</p> <p data-bbox="356 368 1006 488"> CAUTION: When setting this option to Disabled, the system will not halt if an error occurs during POST. Any critical errors will be displayed and logged in the system event log.</p>

Memory Settings Screen

Option	Description
System Memory Size	Displays the amount of system memory.
System Memory Type	Displays the type of system memory.
System Memory Speed	Displays the system memory speed.
Video Memory	Displays the amount of video memory.
System Memory Testing (Enabled default)	Specifies whether system memory tests are run at system boot. Options are Enabled and Disabled .
Memory Operating Mode	<p>This field displays the type of memory operation if a valid memory configuration is installed. When set to Optimizer Mode, the memory controllers run independently of each other for improved memory performance. When set to Mirror Mode, memory mirroring is enabled. When set to Advanced ECC Mode, two controllers are joined in 128-bit mode running multi-bit advanced ECC. For information about the memory modes, see "System Memory" on page 119.</p> <p>NOTE: The Spare Mode option may not be present on all systems.</p>
Node Interleaving (Disabled default)	If this field is Enabled , memory interleaving is supported if a symmetric memory configuration is installed. If Disabled , the system supports Non-Uniform Memory architecture (NUMA) (asymmetric) memory configurations.

Processor Settings Screen

Option	Description
64-bit	Specifies if the processor(s) support 64-bit extensions.
Clock Speed	Displays the processor clock speed.
Bus Speed	Displays the processor bus speed.

Option	Description
Logical Processor (Enabled default)	On processors that support Simultaneous Multi- Threading (SMT) technology, each processor core supports up to two logical processors. If this field is set to Enabled , the BIOS reports both logical processors. If set to Disabled , only one logical processor is monitored by the BIOS.
Virtualization Technology (Disabled default)	NOTE: Disable this feature if your system will not be running virtualization software. Enabled permits virtualization software to use the virtualization technology incorporated in the processor.
Execute Disable (Enabled default)	Enables or disables Execute Disable Memory Protection Technology .
Number of Cores per Processor (All default)	If set to All , the maximum number of cores in each processor is enabled.
Turbo Mode (Enabled default)	If Turbo Boost Technology is supported by the processor(s), enables or disables Turbo Mode .
C States (Enabled default)	When set to Enabled , the processor(s) can operate in all available power states.
Processor 1 Family -Model- Stepping	Displays the family, model, and stepping of the selected processor.

SATA Settings Screen

Option	Description
Embedded SATA (ATA Mode default)	ATA Mode enables the integrated SATA controller. Off disables the controller.
Port A (Auto default)	Auto enables BIOS support for the device attached to SATA port A. Off disables BIOS support for the device.
Port B (Off default)	Auto enables BIOS support for the device attached to SATA port B. Off disables BIOS support for the device.
Port C (Off default)	Auto enables BIOS support for the device attached to SATA port C. Off disables BIOS support for the device.
Port D (Off default)	Auto enables BIOS support for the device attached to SATA port D. Off disables BIOS support for the device.

Option	Description
Port E	Auto enables BIOS support for the device attached to SATA port E. Off disables BIOS support for the device.

Boot Settings Screen

Option	Description
Boot Mode (BIOS default)	<p> CAUTION: Switching the boot mode could prevent the system from booting if the operating system was not installed in the same boot mode.</p> <p>If the system operating system supports Unified Extensible Firmware Interface, you can set this option to UEFI. Setting this field to BIOS allows compatibility with non-UEFI operating systems.</p> <p>NOTE: Setting this field to UEFI disables the Boot Sequence, Hard-Disk Drive Sequence, and USB Flash Drive Emulation Type fields.</p>
Boot Sequence	If Boot Mode is set to BIOS , this field tells the system where the operating system files needed for startup are located. If Boot Mode is set to UEFI , you can access the UEFI boot manager utility by rebooting the system and pressing F11 when prompted to do so.
Hard-Disk Drive Sequence	Determines the order in which the BIOS will attempt to boot from hard drives in the system during system startup.
USB Flash Drive Emulation Type (Auto default)	Determines the emulation type for a USB flash drive. Hard disk allows the USB flash drive to act as a hard drive. Floppy allows the USB flash drive to act as a removable diskette drive. Auto automatically chooses an emulation type.
Boot Sequence Retry (Disabled default)	If this field is enabled and the system has failed to boot, the system will reattempt to boot after 30 seconds.

Integrated Devices Screen

Option	Description
Integrated SAS/RAID Controller (Enabled default)	Enables or disables the integrated storage controller.
User Accessible USB Ports (All Ports On default)	Enables or disables the user-accessible USB ports. Options are All Ports On , Only Back Ports On , and All Ports Off .
Internal USB Port (On default)	Enables or disables the internal USB port.
Embedded NIC1 and NIC2	Enables or disables the OS interface of the four embedded NICs. (The NICs may also be accessed through the system's management controller.)
Embedded Gb NICx (NIC1 default: Enabled with PXE ; Other NICs: Enabled)	Enables or disables the embedded NICs. Options are Enabled , Enabled with PXE , and Enabled with iSCSI Boot . PXE support allows the system to boot from the network.
MAC Address	Displays the MAC address for the NIC.
Capability Detected	Displays the features of the NIC hardware key, if installed. NOTE: Some NIC features may require the installation of an additional driver.
OS Watchdog Timer (Disabled default)	Sets a timer to monitor the operating system for activity, and aids in recovery if the system stops responding. When Enabled , the operating system is allowed to initialize the timer. When Disabled , the timer is not initialized. NOTE: This feature is usable only with operating systems that support WDAT implementations of the Advanced Configuration and Power Interface (ACPI) 3.0b specification.
I/OAT DMA Engine (Disabled default)	Enables or disables the I/O acceleration technology (I/OAT). This feature should only be enabled if the hardware and software support I/OAT.
Embedded Video Controller (Enabled default)	Displays the total amount of video memory available in the embedded video controller.

PCI IRQ Assignments Screen

Option	Description
<PCIe device>	Use the <+> and <-> keys to manually select an IRQ for a given device, or select Default to allow the BIOS to select an IRQ value at system startup.

Serial Communication Screen

Option	Description
Serial Communication (On without Console Redirection default)	Selects whether the serial communication devices (Serial Device 1 and Serial Device 2) are enabled in BIOS. BIOS console redirection can also be enabled and the port address used can be specified. Options are On without Console Redirection , On with Console Redirection via COM1 , On with Console Redirection via COM2 , and Off .
Serial Port Address (Serial Device 1=COM1, Serial Device2=COM2 default)	Sets the serial port addresses for the two serial devices. NOTE: Only Serial Device 2 can be used for Serial Over LAN (SOL). To use console redirection by SOL, configure the same port address for console redirection and the serial device.
External Serial Connector (Serial Device1 default)	Specifies whether Serial Device 1 , Serial Device 2 , or Remote Access Device has access to the external serial connector. NOTE: Only Serial Device 2 can be used for Serial Over LAN (SOL). To use console redirection by SOL, configure the same port address for console redirection and the serial device.
Failsafe Baud Rate (115200 default)	Displays the failsafe baud rate used for console redirection. BIOS attempts to determine the baud rate automatically. This failsafe baud rate is used only if the attempt fails. This rate should not be adjusted.
Remote Terminal Type (VT100/VT220 default)	Sets the remote console terminal type, either VT100/VT220 or ANSI .
Redirection After Boot (Enabled default)	Enables or disables BIOS console redirection when the operating system is loaded.

Embedded Server Management Screen (Optional)

Option	Description
Front Panel LCD Options	Options are User Defined String , Model Number , or None . If the LCD Home display is set to anything other than User Defined String , Model Number , or None , this option in BIOS will display Advanced . You will not be able to edit this setting in BIOS until it is set back to User Defined String , Model Number , or None through another LCD configuration utility (such as the optional BMC or iDRAC6 Configuration Utility or LCD panel menu).
User-Defined LCD String	You can enter a name or other identifier for the system, to be displayed on the LCD module screen.

Power Management Screen

Option	Description
Power Management	Options are OS Control , Active Power Controller , Custom , or Maximum Performance . If you select OS Control , Active Power Controller , or Maximum Performance , the BIOS preconfigures the remaining options on this screen. If you select Custom , you can configure each option independently.

Option	Description
CPU Power and Performance Management	<p>Options are OS Control, Active Power Controller, Custom, or Maximum Performance. For all but the Custom setting, the BIOS pre-configures the power settings on this screen as follows:</p> <p>OS Control sets the CPU power to OS DBPM, the fan power to Minimum Power, and the memory power to Maximum Performance. In this setting, all processor performance information is passed from the system BIOS to the operating system for control. The operating system sets the processor performance based on processor utilization.</p> <p>Active Power Controller sets the CPU power to System DBPM, the fan power to Minimum Power, and the memory power to Maximum Performance. In this setting, processor performance is controlled by the system BIOS.</p> <p>Maximum Performance sets all fields to Maximum Performance.</p> <p>If you select Custom, you can configure each option independently.</p>
Fan Power and Performance Management	Options are Maximum Performance or Minimum Power .
Memory Power and Performance Management	Options are Maximum Performance , a specified frequency, or Minimum Power .

System Security Screen

Option	Description
System Password	<p>Displays the current status of the password security feature and allows a new system password assignment and verification.</p> <p>NOTE: See "Using the System Password" on page 71 for more information.</p>
Setup Password	<p>Restricts access to the System Setup program by using a setup password.</p> <p>NOTE: See "Using the System Password" on page 71 for more information.</p>

Option	Description
Password Status (Unlocked default)	<p>When Setup Password is assigned and this field is Locked, the system password cannot be changed or disabled at system start-up.</p> <p>See "Using the System Password" on page 71 for more information.</p>
TPM Security (Off default)	<p>Sets the reporting of the Trusted Platform Module (TPM) in the system.</p> <p>If Off, the presence of the TPM is not reported to the operating system.</p> <p>If On with Pre-boot Measurements, the system reports the TPM to the operating system and stores the pre-boot measurements to the TPM during POST.</p> <p>If On without Pre-boot Measurements, the system reports the TPM to the operating system and bypasses pre-boot measurements.</p>
TPM Activation (No Change default)	<p>When set to Activate, the TPM is enabled to default settings. When set to Deactivate, the TPM is disabled. The No Change state initiates no action. The operational state of the TPM remains unchanged (all user settings for the TPM are preserved).</p> <p>NOTE: This field is read-only when TPM Security is set to Off.</p>
TPM Clear (No default)	<p> CAUTION: Clearing the TPM will lose all encryption keys in the TPM. This option prevents booting to the operating system and results in data loss if the encryption keys cannot be restored. Back up the TPM keys prior to enabling this option.</p> <p>When set to Yes, all TPM contents are cleared.</p> <p>NOTE: This field is read-only when TPM Security is set to Off.</p>
Power Button (Enabled default)	<p>If Enabled, the power button can turn the system's power off and on. On an ACPI-compliant operating system, the system performs an orderly shutdown before power is turned off.</p> <p>When Disabled, the button can only turn on system power.</p>

Option	Description
NMI Button (Disabled default)	 CAUTION: Clearing the TPM will lose all encryption keys in the TPM. This option prevents booting to the operating system and results in data loss if the encryption keys cannot be restored. Back up the TPM keys prior to enabling this option. Enables or disables the NMI feature.
AC Power Recovery (Last default)	Determines how the system reacts when power is restored. If set to Last , the system returns to the last power state. On turns on the system after power is restored. Off allows the system to remain off after power is restored.
AC Power Recovery Delay (Immediate default)	Determines when the system restarts after power is restored. Options are Immediate , Random (between 30 to 240 seconds), or a user-defined value of 30 to 240 seconds.

Exit Screen

Press <Esc> to exit the System Setup program; the **Exit** screen displays:

- Save Changes and Exit
- Discard Changes and Exit
- Return to Setup

Entering the UEFI Boot Manager



NOTE: Operating systems must be 64-bit UEFI-compatible (for example, Microsoft® Windows Server® 2008 x64 version) to be installed from the UEFI boot mode. DOS and 32-bit operating systems can only be installed from the BIOS boot mode.



NOTE: The Boot Mode must be set to UEFI in the System Setup program to access the UEFI Boot Manager.

The UEFI Boot Manager enables you to:

- Add, delete, and arrange boot options
 - Access the System Setup program and BIOS-level boot options without rebooting
- 1 Turn on or restart your system.

2 Press <F11> after you see the following message:

<F11> = UEFI Boot Manager



NOTE: The system will not respond until the USB keyboard is active.

If your operating system begins to load before you press <F11>, allow the system to finish booting, and then restart your system and try again.

Using the UEFI Boot Manager Navigation Keys

Keys	Action
Up arrow	Moves to and highlights the previous field.
Down arrow	Moves to and highlights the next field.
Spacebar, <Enter>, <+>, <->	Cycles through the settings in a field.
<Esc>	Refreshes the UEFI Boot Manager screen (page one) or returns to the previous screen.
<F1>	Displays the UEFI Boot Manager help file.

UEFI Boot Manager Screen

Option	Description
Continue	The system attempts to boot to devices starting with the first item in the boot order. If the boot attempt fails, the system will continue with the next item in the boot order until the boot is successful or no more boot options are found.
<Boot options>	Displays the list of available boot options (marked with asterisks). Select the boot option you wish to use and press <Enter>. NOTE: If you hot-swap a boot device, press <ESC> to refresh the list of boot options.
UEFI Boot Settings	Enables you to add, delete, enable, or disable boot options; change boot order; or execute a one-time boot option.
System Utilities	Enables you to access the System Setup program, System Services (Unified Server Configurator [USC]), Diagnostics, and BIOS-level boot options.

UEFI Boot Settings Screen

Option	Description
Add Boot Option	Adds a new boot option.
Delete Boot Option	Deletes an existing boot option.
Enable/Disable Boot Option	Disables and enables an option in the boot option list.
Change Boot Order	Changes the order of the boot option list.
One-Time Boot from File	Sets a one-time boot option not included in the boot option list.

System Utilities Screen

Option	Description
System Setup	Accesses the System Setup program without rebooting.
System Services (USC)	Restarts the system and accesses the Unified Server Configurator, which enables you to run utilities such as system diagnostics.
BIOS Boot Manager	Accesses the BIOS-level boot options list without rebooting. This option enables you to conveniently switch to BIOS boot mode if you need to boot to a device with a non-UEFI operating system, such as a bootable DOS media with diagnostics software.
Reboot System	Restarts the system.

System and Setup Password Features



NOTE: For a forgotten password, see "Disabling a Forgotten Password" on page 174.

Your system is shipped without the system password feature enabled in BIOS. The password features provide a basic level of security for the data on your system.



CAUTION: Anyone can access the data stored on your system if the system is running and unattended.

Using the System Password

When a system password is assigned, the system prompts for the system password after the system starts and only those with the password have full use of the system.

Assigning a System Password

Before assigning a system password, enter the System Setup program and check the **System Password** option.

When a system password is assigned, **System Password** is **Enabled**.

If **Password Status** is **Unlocked**, you can change the system password.

If **Locked**, you cannot change the system password. Disabling the password jumper on the system board sets **System Password** to **Disabled**, and you cannot change or enter a new system password.

When a system password is not assigned and the password jumper on the system board is in the enabled position, **System Password is Not Enabled and Password Status is Unlocked**. To assign a system password:

- 1 Verify that **Password Status is Unlocked**.
- 2 Highlight the **System Password** option and press <Enter>.
- 3 Type your new system password.

You can use up to 32 characters in your password.

As you type, placeholders appear in the field.

The password assignment is not case-sensitive. To erase a character, press <Backspace> or the left-arrow key.

 **NOTE:** To escape from the field without assigning a system password, press <Enter> to move to another field, or press <Esc> prior to completing step 5.

- 4 Press <Enter>.
- 5 To confirm your password, type it a second time and press <Enter>.

System Password changes to **Enabled**. Exit the System Setup program and begin using your system.

- 6 Either reboot the system now for the password protection to take effect or continue working.

 **NOTE:** Password protection does not take effect until the system reboots.

Using Your System Password to Secure Your System

 **NOTE:** If you have assigned a setup password (see "Using the Setup Password" on page 74), the system accepts your setup password as an alternate system password.

When **Password Status is Unlocked**, you have the option to leave the password security enabled or to disable password security.

To leave the password security enabled:

- 1 Turn on or reboot your system by pressing <Ctrl><Alt>.
- 2 Type your password and press <Enter>.

To disable the password security:

- 1 Turn on or reboot your system by pressing <Ctrl><Alt>.
- 2 Type your password and press <Ctrl><Enter>.

When **Password Status** is **Locked**, you must type the password and press <Enter> when prompted at reboot.

If an incorrect system password is entered, the system displays a message and prompts you to re-enter your password. You have three attempts to enter the correct password. After the third unsuccessful attempt, the system displays an error message that the system has halted and must be shut down manually using the power button.

Even after you shut down and restart the system, the error message continues to be displayed until the correct password is entered.



NOTE: You can use the Password Status option in conjunction with the System Password and Setup Password options to protect your system from unauthorized changes.

Disabling the System Password

If the system password is already set, you can disable it by typing the password during POST and pressing <Ctrl><Enter> or you can enter the system setup and press <Enter> twice when you are in the system password menu.

Changing an Existing System Password

- 1 Enter the System Setup program by pressing <F2> during POST.
- 2 Select the **System Security** screen.
- 3 Verify that the **Password Status** is **Unlocked**.
- 4 Type the new system password in the two password fields.

The **System Password** field changes to **Not Enabled** if the password was deleted.

Using the Setup Password

Assigning a Setup Password

You can assign a setup password only when the **Setup Password** is **Not Enabled**. To assign a setup password, highlight the **Setup Password** option and press the <+> or <-> key. The system prompts you to enter and verify the password.



NOTE: The setup password can be the same as the system password. If the two passwords are different, the setup password can be used as an alternate system password. The system password cannot be used in place of the setup password.

You can use up to 32 characters in your password.

As you type, placeholders appear in the field.

The password assignment is not case-sensitive. To erase a character, press <Backspace> or the left-arrow key.

When you verify the password, the **Setup Password** changes to **Enabled**. The next time you enter the System Setup program, the system prompts you for the setup password.

A change to the **Setup Password** option becomes effective immediately (restarting the system is not required).

Operating With a Setup Password Enabled

If **Setup Password** is **Enabled**, you must enter the correct setup password before modifying most of the System Setup options.

If you do not enter the correct password in three attempts, the system lets you view, but not modify, the System Setup screens. The following options are exceptions: If **System Password** is not **Enabled** and is not locked through the **Password Status** option, you can assign a system password. You cannot disable or change an existing system password.



NOTE: You can use the Password Status option in conjunction with the Setup Password option to protect the system password from unauthorized changes.

Deleting or Changing an Existing Setup Password

- 1 Enter the System Setup program and select the **System Security**.
- 2 Highlight **Setup Password**, press <Enter> to access the setup password window. Press <Enter> twice to clear the existing setup password.
The setting changes to **Not Enabled**.
- 3 If you want to assign a new setup password, perform the steps in "Assigning a Setup Password" on page 74.

Embedded System Management

The Unified Server Configurator (USC) is an embedded utility that enables systems and storage management tasks from an embedded environment throughout the server's lifecycle.

The USC can be started during the boot sequence and can function independently of the operating system.



NOTE: Certain platform configurations may not support the full set of features provided by USC.

The following features of USC are supported on systems with Baseboard Management Controller (BMC):

- Installing an operating system
- Running diagnostics to validate the memory, I/O devices, processors, physical disks, and other peripherals

When an optional iDRAC6 Express card is installed, USC provides the following additional features:

- Downloading and applying firmware updates
- Configuring hardware and firmware

Baseboard Management Controller Configuration

 **NOTE:** If an iDRAC6 Express card is installed on the system, the Baseboard Management Controller (BMC) utility is replaced by the iDRAC6 utility.

The BMC enables configuring, monitoring, and recovery of systems remotely. BMC provides the following features:

- Uses the system's integrated NIC
- Enables fault logging and SNMP alerting
- Provides access to system event log and sensor status
- Allows control of system functions including power on and off
- Functions independently of the system's power state or the system's operating system
- Provides text console redirection for system setup, text-based utilities, and operating system consoles

 **NOTE:** To remotely access the BMC through the integrated NIC, you must connect the network connection to integrated NIC1.

For additional information on using BMC, see the documentation for the BMC and systems management applications.

Entering the BMC Setup Module

- 1 Turn on or restart your system.
- 2 Press <Ctrl><E> when prompted after POST.

If your operating system begins to load before you press <Ctrl><E>, allow the system to finish booting, and then restart your system and try again.

iDRAC Configuration Utility

The iDRAC Configuration Utility is a pre-boot configuration environment that allows you to view and set parameters for the optional iDRAC6 and for the managed server. The iDRAC Configuration Utility enables you to:

- Configure, enable, or disable the iDRAC6 local area network (LAN) through the dedicated iDRAC6 Enterprise card port or the embedded NICs.
- Enable or disable IPMI over LAN.
- Enable a LAN Platform Event Trap (PET) destination.

- Attach or detach the Virtual Media devices.
- Change the administrative username and password and manage user privileges.
- View System Event Log (SEL) messages or clear messages from the log.

For additional information on using iDRAC6, see the documentation for iDRAC6 and systems management applications.

Entering the iDRAC Configuration Utility

- 1 Turn on or restart your system.
- 2 Press <Ctrl><E> when prompted during POST.

If your operating system begins to load before you press <Ctrl><E>, allow the system to finish booting, restart your system and try again.

Installing System Components

 **WARNING:** While moving or transferring the system, it is recommended that you use the packaging material that shipped with the system and/or take care to avoid any damage due to shock or vibration.

 **NOTE:** Depending on the configuration, your system may have cabled or hot-swappable hard drives, redundant or non-redundant power supplies, and an LCD panel or diagnostic indicators. The illustrations in this section show a system with hot-swappable hard drives and an LCD panel.

Recommended Tools

- Key to the system keylock
- #1 and #2 Phillips screwdrivers
- Wrist grounding strap

Inside the System

 **WARNING:** Only trained service technicians are authorized to remove the system cover and access any of the components inside the system. Before you begin this procedure, review the safety instructions that came with the system.

Figure 3-1. Inside the System



- | | | | |
|----|-------------------------|----|-------------------------------|
| 1 | power supply shroud | 2 | system board shroud |
| 3 | power supply bays (2) | 4 | expansion-card riser |
| 5 | heat sink/processor (2) | 6 | memory modules (8) |
| 7 | system cooling fans (4) | 8 | optical drive |
| 9 | hard drives (4) | 10 | control panel board |
| 11 | SAS backplane | 12 | power supply cooling fans (2) |

Removing and Replacing the Optional Front Bezel

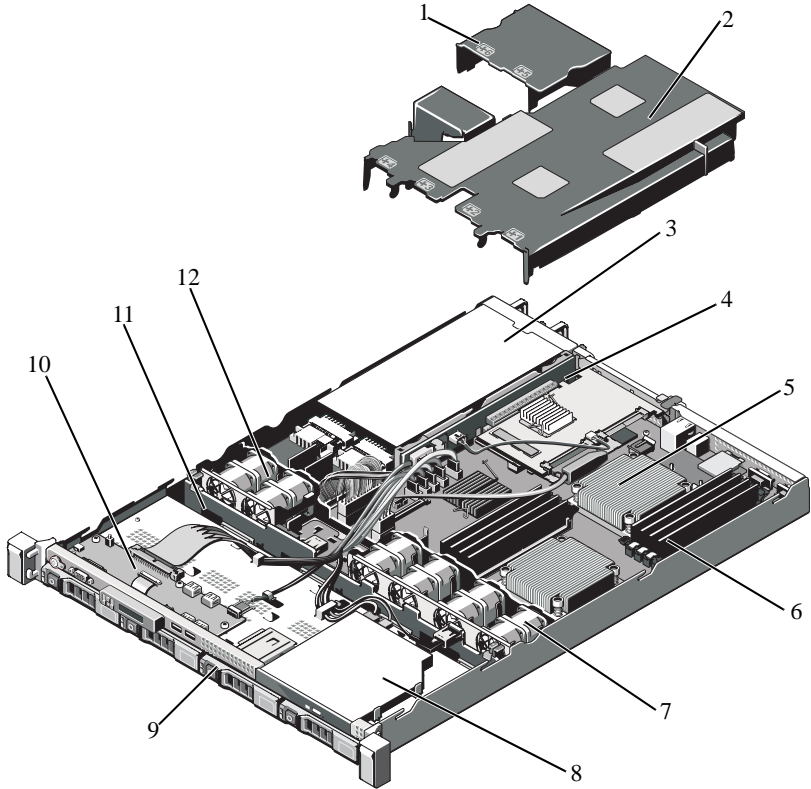
- 1 Unlock the keylock at the left end of the bezel.
- 2 Lift up the release latch next to the key lock.
- 3 Rotate the left end of the bezel away from the front panel.
- 4 Unhook the right end of the bezel and pull the bezel away from the system.

Figure 3-2. Removing and Replacing the Optional Front Bezel

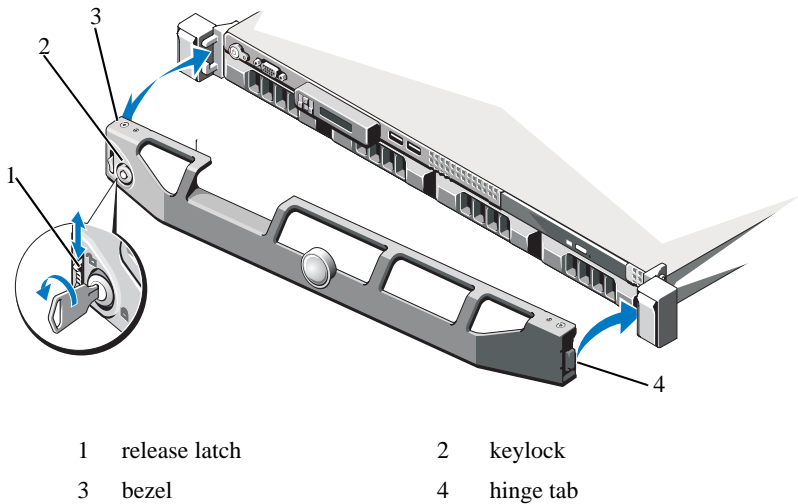

To replace the optional bezel, hook the right end of the bezel onto the chassis, then fit the free end of the bezel onto the system. Secure the bezel with the keylock. See Figure 3-2.

Opening and Closing the System

 **WARNING:** Only trained service technicians are authorized to remove the system cover and access any of the components inside the system. Before you begin this procedure, review the safety instructions that came with the system.

 **WARNING:** Whenever you need to lift the system, get others to assist you. To avoid injury, do not attempt to lift the system by yourself.

Opening the System

- 1 Turn off the system and attached peripherals, and disconnect the system from the electrical outlet and peripherals.
- 2 Rotate the latch release lock counter clockwise to the unlocked position. See Figure 3-3.
- 3 Grasp the cover on both sides while pressing your thumbs on latch release lock and the indent, carefully slide the cover back, and lift it away from the system. See Figure 3-3.

Figure 3-3. Removing and Replacing the System Cover

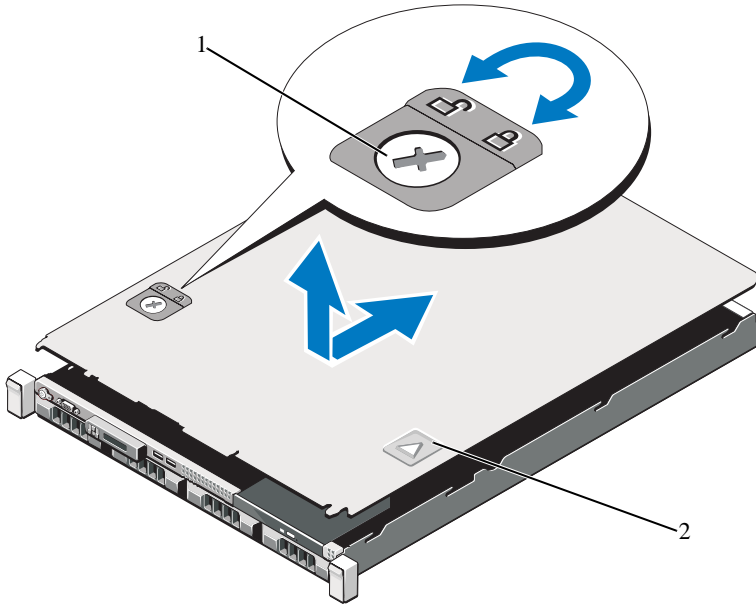

1 latch release lock

2 indent

Closing the System

- 1 Place the cover onto the chassis and offset it slightly towards the back of the system, so that the two hooks on the back edge of the cover fit over the corresponding slots on the back edge of the chassis. See Figure 3-3.
- 2 Slide the cover towards the front of the chassis till it snaps in position.
- 3 Rotate the latch release lock in a clockwise direction to secure the cover.

Hard Drives

Your system supports up to four 3.5-inch (SAS or SATA) or 2.5-inch (SAS, SATA, or SSD) hard drives in 3.5-inch hot-swap hard drive carrier or cabled internal drives. Depending on your chassis, the hard drives are installed internally or at the front of the system (see Figure 3-1). Internal hard drives are connected to the system board or an optional controller card. Front-mounted hard drives are connected to a SAS backplane through hard-drive carriers and can be configured as hot-swappable.

Removing a Drive Blank

△ CAUTION: To maintain proper system cooling, all empty hard-drive bays must have drive blanks installed.

- 1 Remove the front bezel. See "Removing and Replacing the Optional Front Bezel" on page 81.
- 2 Grasp the front of the hard-drive blank, press the release lever on the right side, and slide the blank out until it is free of the drive bay. See Figure 3-4.

Figure 3-4. Removing or Installing a Hard-Drive Blank

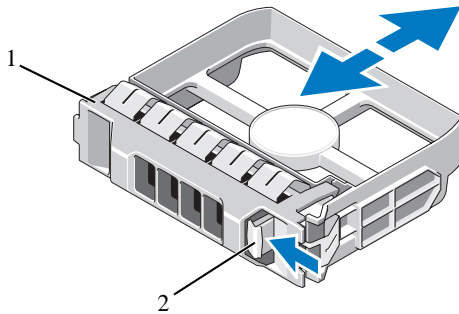

1 hard-drive blank

2 release lever

Installing a Drive Blank

Align the hard-drive blank with the drive bay and insert the blank into the drive bay until the release lever clicks into place. See Figure 3-4.

Removing a Hot-Swap Hard Drive

△ **CAUTION:** Ensure that your operating system supports hot-swap drive installation. See the documentation supplied with the operating system.

- 1 Remove the front bezel. See "Removing and Replacing the Optional Front Bezel" on page 81.
- 2 Using the RAID management software, prepare the drive for removal. Wait until the hard-drive indicators on the drive carrier signal that the drive can be removed safely. See your storage controller documentation for information about hot-swap drive removal.

If the drive has been online, the green activity/fault indicator will flash as the drive is powered down. When the drive indicators are off, the drive is ready for removal.

- 3 Press the release button and open the drive carrier release handle to release the drive. See Figure 3-5.
- 4 Slide the hard drive out of the drive bay.
- 5 Insert a drive blank in the vacated drive bay. See "Installing a Drive Blank" on page 84.

△ **CAUTION:** To maintain proper system cooling, all empty hard-drive bays must have drive blanks installed.



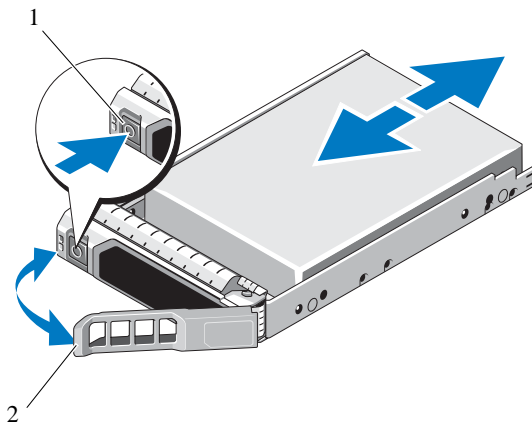

Figure 3-5. Removing and Installing a Hot-Swap Hard Drive



1 release button

2 hard-drive carrier handle

Installing a Hot-Swap Hard Drive

-  **CAUTION:** Use only hard drives that have been tested and approved for use with the SAS/SATA backplane.
-  **CAUTION:** When installing a hard drive, ensure that the adjacent drives are fully installed. Inserting a hard-drive carrier and attempting to lock its handle next to a partially installed carrier can damage the partially installed carrier's shield spring and make it unusable.
-  **CAUTION:** Ensure that your operating system supports hot-swap drive installation. See the documentation supplied with the operating system.
-  **CAUTION:** Combining SATA and SAS hard drives in the same system configuration is not supported.

- 1 Remove the front bezel. See "Removing and Replacing the Optional Front Bezel" on page 81.
- 2 If a drive blank is present in the bay, remove it. See "Removing a Drive Blank" on page 84.
- 3 Install the hot-swap hard drive.
 - a Press the button on the front of the drive carrier.
 - b Insert the hard-drive carrier into the drive bay until the carrier contacts the backplane.
 - c Close the handle to lock the drive in place. With the lever on the hard drive carrier open, slide the hard drive into the drive bay until the carrier contacts the backplane (see Figure 3-5).

Removing a Hard Drive From a Hard-Drive Carrier

Remove the screws from the slide rails on the hard-drive carrier and separate the hard drive from the carrier. See Figure 3-6.

Figure 3-6. Installing a Hard Drive Into a Drive Carrier

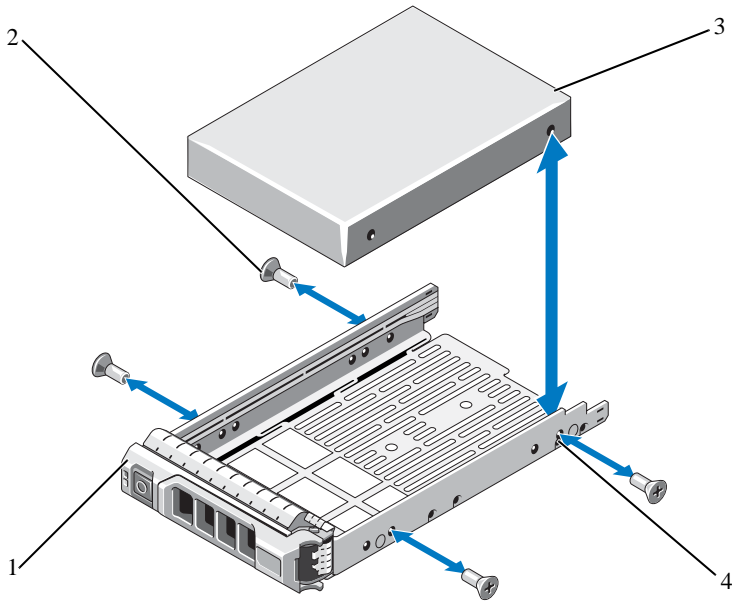

- | | | | |
|---|---------------|---|---------------------|
| 1 | drive carrier | 2 | screws (4) |
| 3 | hard drive | 4 | SAS/SATA screw hole |

Installing a Hard Drive Into a Hard-Drive Carrier

- 1 Insert the hard drive into the hard-drive carrier with the connector end of the drive at the back. See Figure 3-6.
- 2 Align the holes on the hard drive with the back set of holes on the hard drive carrier.
When aligned correctly, the back of the hard drive will be flush with the back of the hard-drive carrier.
- 3 Attach the four screws to secure the hard drive to the hard-drive carrier.

Removing a Cabled Hard Drive

! **WARNING:** Only trained service technicians are authorized to remove the system cover and access any components inside the system. Before you begin this procedure, review the safety instructions that came with the system.

- 1 Turn off the system and attached peripherals, and disconnect the system from the electrical outlet and from the peripherals.
- 2 Open the system. See "Opening the System" on page 82.
- 3 Disconnect the data/power cable from the hard drive in the drive bay.
- 4 Lift the tab with blue dot on the hard-drive bracket and slide the drive out of the bay. See Figure 3-7.

Figure 3-7. Removing and Installing a Cabled Hard Drive

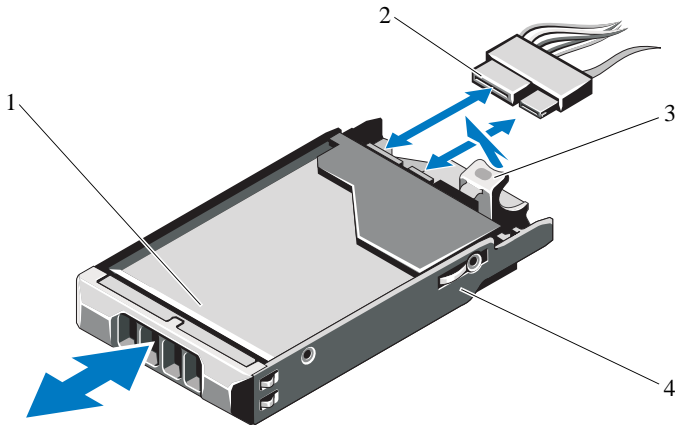

- | | | | |
|---|------------|---|------------------|
| 1 | hard drive | 2 | power/data cable |
| 3 | tab | 4 | drive bracket |

✎ **NOTE:** If you are not replacing the hard drive, remove the drive from the drive bracket (see Figure 3-8) and insert the empty bracket back into the drive bay.

- 5 Replace the system cover. See "Closing the System" on page 83.

Installing a Cabled Hard Drive



WARNING: Only trained service technicians are authorized to remove the system cover and access any components inside the system. Before you begin this procedure, review the safety instructions that came with the system.

- 1 Turn off the system and attached peripherals, and disconnect the system from the electrical outlet and from the peripherals.
- 2 Open the system. See "Opening the System" on page 82.
- 3 Remove the existing hard-drive bracket by lifting the tab with blue dot on the bracket and sliding the bracket up and out of the system. See Figure 3-7.
- 4 Install the hard drive into the bracket. See "Installing a Hard Drive Into a Hard-Drive Bracket" on page 91.
- 5 Slide the hard drive into the drive bay.
- 6 Connect the power/data cable to the hard drive.
 - If connecting to the integrated SATA controller (SATA hard drives only), connect the SATA data cable to the SATA_A connector on the system board. See Figure 7-1.
 - If connecting to a SAS RAID controller card (SAS or SATA hard drives), connect the data cable to the connector on the card edge. For information on installing a SAS controller card, see "Installing an Expansion Card" on page 97.
- 7 Replace the system cover. See "Closing the System" on page 83.
- 8 Reconnect the system to the electrical outlet and turn on the system and attached peripherals.
- 9 Enter the System Setup program and ensure that the hard drive's controller is enabled. See "Entering the System Setup Program" on page 56.
- 10 Exit the System Setup program and reboot the system.

See the documentation that came with the hard drive for instructions on installing any software required for drive operation.

Removing a Hard Drive From a Hard-Drive Bracket

Remove the screws from the slide rails on the hard-drive bracket and separate the hard drive from the bracket. See Figure 3-8.

Figure 3-8. Removing a Hard Drive From a Hard-Drive Bracket

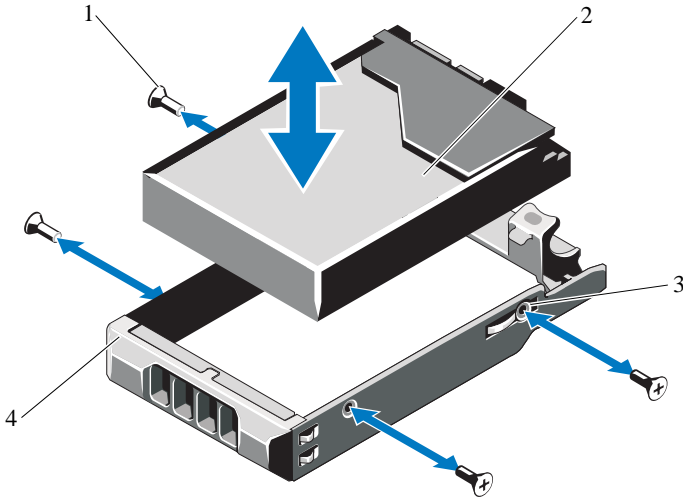

Installing a Hard Drive Into a Hard-Drive Bracket

- | | | | |
|---|---------------------|---|--------------------|
| 1 | screws (4) | 2 | hard drive |
| 3 | SAS/SATA screw hole | 4 | hard-drive bracket |

1 Insert the hard drive into the hard-drive bracket with the connector end of the drive at the back. See Figure 3-8.

2 Align the holes on the hard drive with the back set of holes on the hard-drive bracket.

When aligned correctly, the back of the hard drive will be flush with the back of the hard-drive bracket.

3 Attach the four screws to secure the hard drive to the hard-drive bracket.

Power Supplies

Your system supports the following power supply modules:

- 480W (non-redundant power supply)
- 500W (redundant power supply)

If two power supplies are installed, the second power supply provides hot-swappable, power redundancy. In redundant mode, the system distributes the power load across both power supplies to maximize efficiency. When a power supply is removed with the system powered on, the full power load is picked up by the remaining power supply.

Removing a Redundant Power Supply

 **CAUTION:** The system requires one power supply to operate the system normally. On power-redundant systems, remove and replace only one power supply at a time in a system that is powered on.

- 1 Disconnect the power cable from the power source.
- 2 Disconnect the power cable from the power supply and remove the Velcro straps that bundle and secure the system cables.



NOTE: You may have to unlatch and lift the optional cable management arm if it interferes with power-supply removal. For information about the cable management arm, see the system's rack documentation.

- 3 Pull the power supply straight out to release it from the power distribution board and clear the chassis.

Figure 3-9. Removing and Replacing a Redundant Power Supply

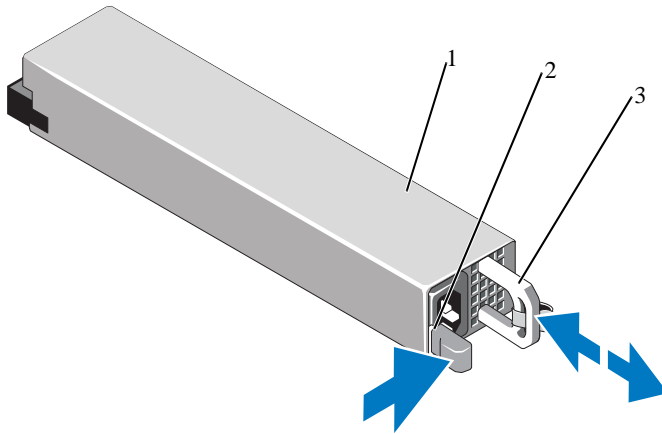

- | | | | |
|---|-------------------------|---|-------------|
| 1 | power supply | 2 | locking tab |
| 3 | cable retention bracket | | |

Installing a Redundant Power Supply

- 1 Verify that both power supplies are the same type and have the same maximum output power.

 **NOTE:** The maximum output power (shown in watts) is listed on the power supply label.

- 2 Slide the new power supply into the chassis until the power supply is fully seated and the release latch snaps into place. See Figure 3-9.

 **NOTE:** If you unlatched the cable management arm in step of the previous procedure, relatch it. For information about the cable management arm, see the system's rack documentation.

- 3 Connect the power cable to the power supply and plug the cable into a power outlet.

 **CAUTION:** When connecting the power cable, secure the cable with the Velcro strap.

 **NOTE:** When installing, hot-swapping, or hot-adding a new power supply in a system with two power supplies, allow several seconds for the system to recognize the power supply and determine its status. The power-supply status indicator turns green to signify that the power supply is functioning properly (see Figure 1-6).

Removing the Power Supply Blank

If you are installing a second power supply, remove the power supply blank in bay PS2 by pulling outward on the blank.

 **CAUTION:** To ensure proper system cooling, the power supply blank must be installed in power supply bay PS2 in a non-redundant configuration. Remove the power supply blank only if you are installing a second power supply.

Installing the Power Supply Blank

 **NOTE:** Install the power supply blank only in power supply bay PS2.

To install the power supply blank, align the blank with the power supply bay and insert the blank into the chassis until it clicks into place.

Removing a Non-Redundant Power Supply

- 1 Turn off the system and all attached peripherals.
- 2 Disconnect the power cable from the power source.
- 3 Disconnect the power cable from the power supply and remove the Velcro straps that bundle and secure the system cables.

 **NOTE:** You may have to unlatch and lift the optional cable management arm if it interferes with power-supply removal. For information about the cable management arm, see the system's rack documentation.

 **NOTE:** Remove the power cord retention bracket that secures the system cables. See the *Getting Started Guide* that ships with your system for more information.

- 4 Open the system. See "Opening the System" on page 82. Disconnect all the power cables from the power supply to the system board, hard drives and optical drive. See Figure 3-10.
- 5 Loosen the screw securing the power supply to the chassis and lift the power supply to remove it from the chassis. See Figure 3-10.

Figure 3-10. Removing and Replacing a Non-Redundant Power Supply

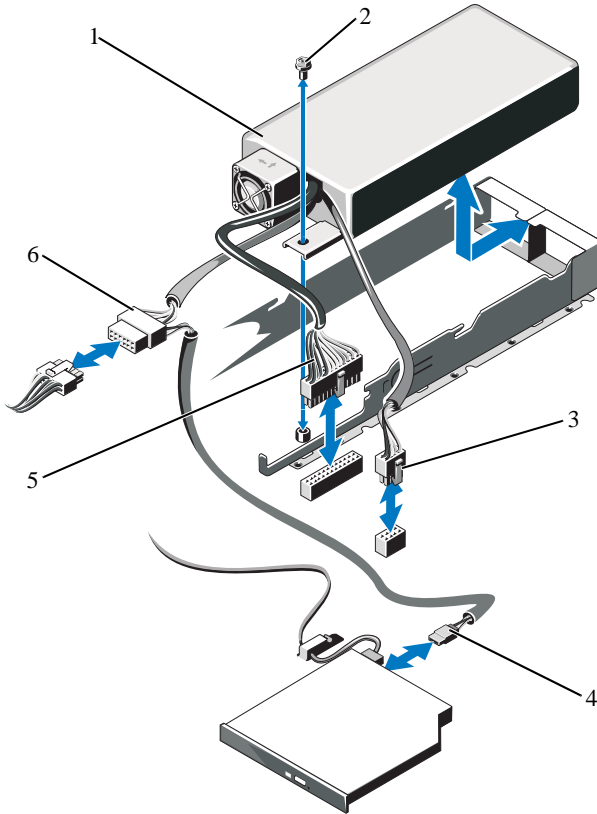

- 1 power supply
- 3 power cable 8 pins
- 5 power cable 24 pins

- 2 screw
- 4 ODD power cable
- 6 SATA power cable

Installing a Non-Redundant Power Supply

- 1 Open the system. See "Opening the System" on page 82.
- 2 Place the power supply on the chassis. See Figure 3-10. Tighten the screw to secure the power supply to the chassis.
- 3 Connect all the power cables to the system board, hard drive(s), and optical drive.
- 4 Replace the system cover. See "Closing the System" on page 83.
- 5 Connect the power cable to the power supply and plug the cable into a power outlet.

Expansion Cards

Expansion Card Installation Guidelines

Your system supports one x16 Gen 1 or Gen2 PCIe expansion card installed in connectors on an expansion-card riser.

 **CAUTION:** Expansion cards can only be installed in the slots on the expansion-card riser. Do not attempt to install expansion cards directly into the riser connector on the system board.

- The expansion slot supports full-height, half-length cards.
- The expansion-card slot is not hot-swappable.
- PCI Express Generation 1 and Generation 2 expansion cards are supported in the slot.

 **CAUTION:** To ensure proper cooling, only one of the two expansion cards can have a power consumption of greater than 15W (up to 25W maximum), not including the integrated storage controller.

- Table 3-1 provides a guide for installing expansion cards to ensure proper cooling and mechanical fit. The expansion cards with the highest priority should be installed first using the slot priority indicated. All other expansion cards should be installed in card priority and slot priority order.

Table 3-1. Expansion-Card Installation Order

Card Priority	Card Type	Slot Priority	Max Allowed	25-W Card?
1	SAS 6/iR Modular	2	1	Y
2	PERC 6/i	1	1	Y
3	PERC 6/E controller	1	1	Y
4	SAS 5/E	1	1	Y
5	SCSI controllers	1	1	Y
6	HPCC	1	1	Y
7	Fibre Channel	1	1	Y
8	10 Gb NIC	1	1	Y
9	All other Bull storage cards	1	1	Y
10	All other NICs	1	1	N*
11	Non-Bull storage cards	1	1	N*

* Refer to the expansion card's documentation to determine if the maximum power exceeds 15W. Any cards that exceed 15W will be affected by the restriction of one 25W card.

Installing an Expansion Card

 **WARNING:** Only trained service technicians are authorized to remove the system cover and access any of the components inside the system. Before you begin this procedure, review the safety instructions that came with the system.

- 1 Unpack the expansion card and prepare it for installation.
For instructions, see the documentation accompanying the card.
- 2 Turn off the system, including any attached peripherals, and disconnect the system from the electrical outlet.
- 3 Open the system. See "Opening the System" on page 82.
- 4 Open the expansion-card latch and remove the filler bracket. See Figure 3-11.

- 5 Install the expansion card:
 - a Holding the card by its edges, position the card so that the card-edge connector aligns with the expansion-card connector on the expansion-card riser.
 - b Insert the card-edge connector firmly into the expansion-card connector until the card is fully seated.
 - c Close the expansion-card latch. See Figure 3-11.

Figure 3-11. Installing or Removing an Expansion Card

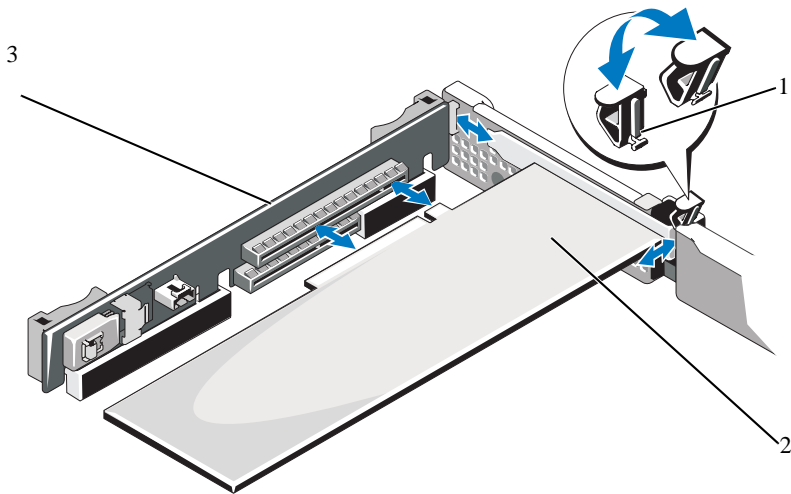

- | | | | |
|---|----------------------|---|----------------|
| 1 | expansion-card latch | 2 | expansion card |
| 3 | expansion-card riser | | |

- 6 Connect any cables to the expansion card.
- 7 Close the system. See "Closing the System" on page 83.
- 8 Reconnect the system to its electrical outlet and turn the system on, including any attached peripherals.

Removing an Expansion Card

 **WARNING:** Only trained service technicians are authorized to remove the system cover and access any of the components inside the system. Before you begin this procedure, review the safety instructions that came with the system.

- 1 Turn off the system, including any attached peripherals, and disconnect the system from the electrical outlet.
- 2 Open the system. See "Opening the System" on page 82.
- 3 Disconnect all cables from the card.
- 4 Remove the expansion card:
 - a Open the expansion-card latch. See Figure 3-11.
 - b Grasp the expansion card by its edges, and carefully remove it from the expansion-card connector.
- 5 If you are removing the card permanently, install a metal filler bracket over the empty expansion slot opening and close the expansion-card latch.

 **NOTE:** You must install a filler bracket over an empty expansion slot to maintain Federal Communications Commission (FCC) certification of the system. The brackets also keep dust and dirt out of the system and aid in proper cooling and airflow inside the system.
- 6 Close the system. See "Closing the System" on page 83.

Integrated Storage Controller Card

Your system includes a dedicated expansion-card slot on the riser for an integrated SAS or PERC controller card that provides the integrated storage subsystem for your system's internal hard drives. The controller supports SAS and SATA hard drives and also enables you to set up the hard drives in RAID configurations as supported by the version of the storage controller included with your system.

Removing the Integrated Storage Controller Card

⚠ WARNING: Only trained service technicians are authorized to remove the system cover and access any of the components inside the system. Before you begin this procedure, review the safety instructions that came with the system.

- 1 Turn off the system, including any attached peripherals, and disconnect the system from the electrical outlet.
- 2 Open the system. See "Opening the System" on page 82.
- 3 If installed, remove the expansion card. See "Removing an Expansion Card" on page 99.
- 4 Remove the card from the storage controller card slot:
 - a Pull the blue release lever to free the card from the connector on the expansion-card riser.
 - b Lift to remove the card.

Figure 3-12. Installing the Integrated Storage Controller Card

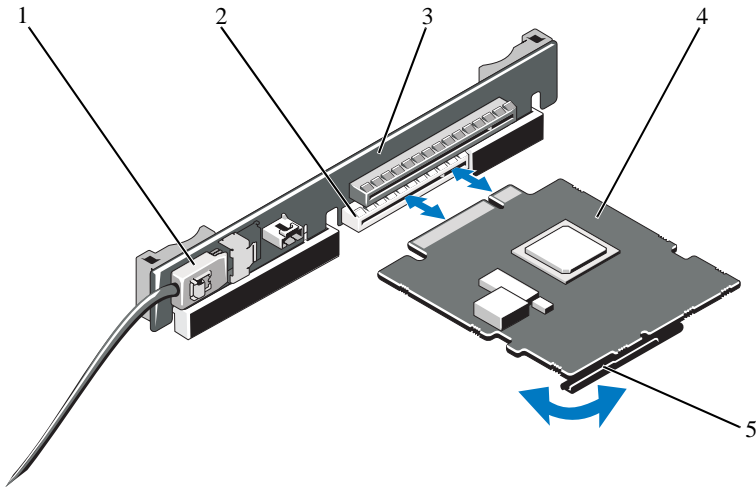

- | | | | |
|---|--------------------------|---|------------------------------------|
| 1 | SAS data cable connector | 2 | storage connector |
| 3 | expansion card riser | 4 | integrated storage controller card |
| 5 | release lever (blue) | | |

Installing the Integrated Storage Controller Card

 **WARNING:** Only trained service technicians are authorized to remove the system cover and access any of the components inside the system. Before you begin this procedure, review the safety instructions that came with the system.

- 1 Turn off the system, including any attached peripherals, and disconnect the system from the electrical outlet.
 - 2 Open the system. See "Opening the System" on page 82.
 - 3 If installed, remove the expansion card. See "Removing an Expansion Card" on page 99.
 - 4 To install the controller card in the expansion slot on the riser labeled "STORAGE_PCIE":
 - a Hold the card by its edges.
 - b Insert the card-edge connector firmly into the expansion-card connector until the card is fully seated and the plastic card guide fits over the edges of the card.
 - 5 Connect the card to the SAS backplane:
 - a Connect the SAS data cable connector to the integrated storage controller card. See Figure 3-12.
-  **NOTE:** Be sure to connect the cable according to the connector labels on the cable. The cable will not function properly if reversed.
- b Route the SAS data cable through the channel on the inner side of the chassis.
 - c Attach the connector labeled "SAS A" to connector SAS A on the backplane, and attach the connector labeled "SAS B" to connector SAS B on the backplane. See Figure 3-12. Close the system. See "Closing the System" on page 83.
- 6 Reconnect the system to its electrical outlet and turn the system on, including any attached peripherals.

Expansion-Card Riser

The system's expansion-card riser supports an x16 link Gen1 or Gen2 PCIe expansion card. (An additional slot on the riser is reserved for use by the integrated storage controller card.)

Removing an Expansion-Card Riser



WARNING: Only trained service technicians are authorized to remove the system cover and access any of the components inside the system. Before you begin this procedure, review the safety instructions that came with the system.

- 1 Turn off the system, including any attached peripherals, and disconnect the system from the electrical outlet.
- 2 Open the system. See "Opening the System" on page 82.
- 3 If installed, remove the expansion card from the expansion slot, now. See "Removing an Expansion Card" on page 99.
- 4 If installed, remove the integrated storage controller card. See "Removing the Integrated Storage Controller Card" on page 100.
- 5 To remove the expansion-card riser, grasp the riser guides and lift the expansion-card riser from the chassis. See Figure 3-13.

Figure 3-13. Installing or Removing an Expansion-Card Riser

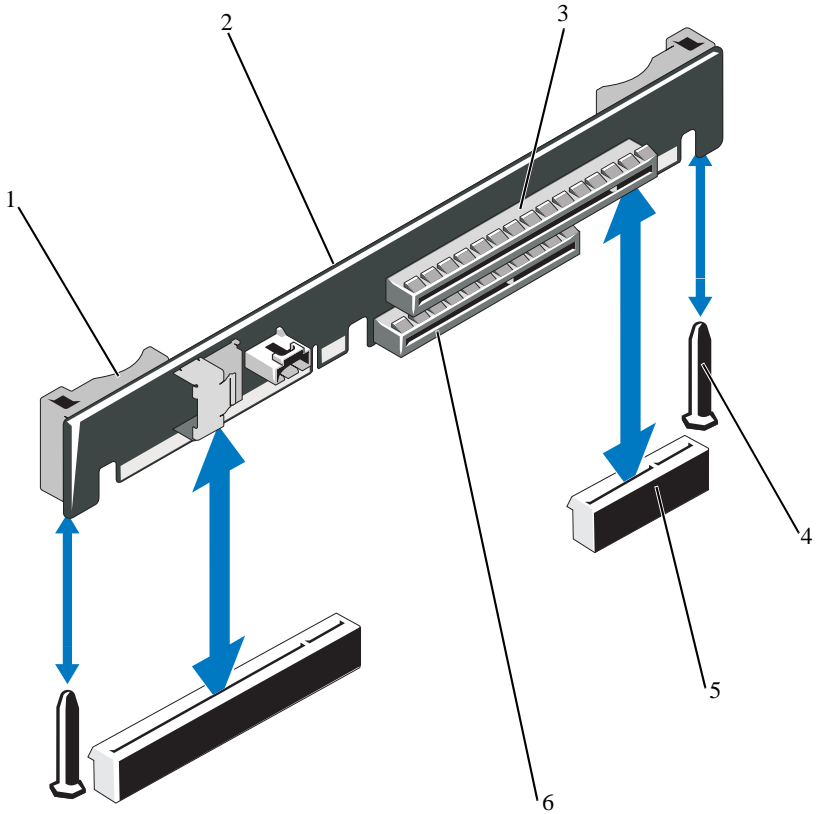

- | | | | |
|---|---------------------------------|---|------------------------------------|
| 1 | riser guides (2) | 2 | expansion-card riser |
| 3 | expansion card slot | 4 | riser guide posts (2) |
| 5 | expansion-card riser socket (2) | 6 | integrated storage controller slot |

Replacing an Expansion-Card Riser

- 1 To install an expansion-card riser, align the riser guide posts with the riser guide posts on the system board. See Figure 3-13.
- 2 Lower the expansion-card riser into place until the expansion-card riser connector is fully seated.

- 3 If applicable, reinstall the integrated storage controller card. See "Installing the Integrated Storage Controller Card" on page 101.
- 4 If applicable, reinstall the expansion card. See "Installing an Expansion Card" on page 97.
- 5 Close the system. See "Closing the System" on page 83.
- 6 Reconnect the system and peripherals to their power sources.

Internal USB Memory Key

The USB memory key can be used as a boot device, security key, or mass storage device. To use the internal USB connector, the **Internal USB Port** option must be enabled in the **Integrated Devices** screen of the System Setup program.

To boot from the USB memory key, you must configure the USB memory key with a boot image and then specify the USB memory key in the boot sequence in the System Setup program. See "Boot Settings Screen" on page 62. For information on creating a bootable file on the USB memory key, see the user documentation that accompanied the USB memory key.



WARNING: Only trained service technicians are authorized to remove the system cover and access any of the components inside the system. Before you begin this procedure, review the safety instructions that came with the system.



NOTE: To avoid interference with other components, the maximum allowable dimensions of the USB key are 24 mm (.94 in) wide x 79 mm (3.11 in) long x 8.6 mm (.33 in) high.

- 1 Turn off the system, including any attached peripherals, and disconnect the system from the electrical outlet.
- 2 Open the system. See "Opening the System" on page 82.
- 3 Locate the USB connector on the control panel board. See Figure 3-14.
- 4 Insert the USB memory key into the USB connector.
- 5 Close the system. See "Closing the System" on page 83.
- 6 Reconnect the system to power and restart the system.

Figure 3-14. Removing or Installing a USB Memory Key

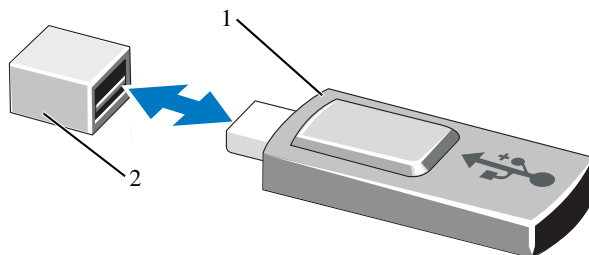

1 USB memory key

2 USB memory key connector

System Board Shroud

The system board shroud covers the processor, heat sink, memory modules, and system battery and provides air flow to these components. Airflow is facilitated by the cooling fan modules, which are positioned directly behind the system board shroud.

Removing the System Board Shroud

⚠ WARNING: Only trained service technicians are authorized to remove the system cover and access any of the components inside the system. Before you begin this procedure, review the safety instructions that came with the system.

- 1 Open the system. See "Opening and Closing the System" on page 82.
- 2 Locate the two shroud tabs with blue dots between the fan assemblies. See Figure 3-15.

- 3 Grasping the tabs, gently lift the shroud straight up and away from the system board. See Figure 3-15.
- 4 Remove the system board shroud.

Figure 3-15. Installing and Removing the System Board Shroud

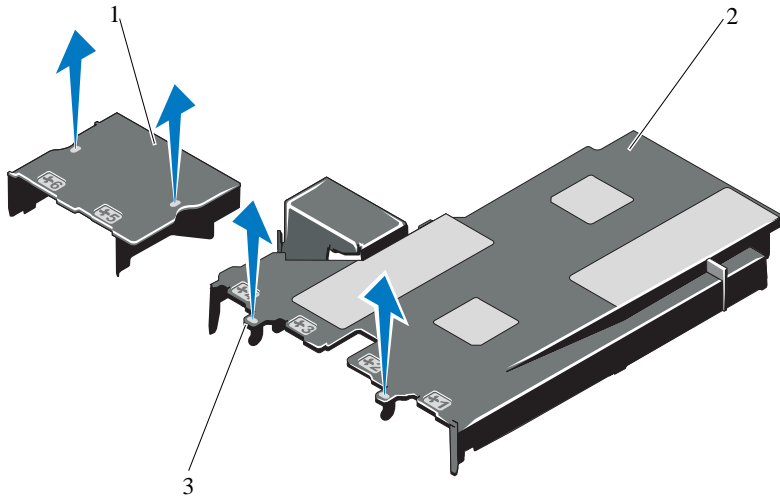

- | | | | |
|---|---------------------------------|---|---------------------|
| 1 | power distribution board shroud | 2 | system board shroud |
| 3 | tabs (2) | | |

Installing the System Board Shroud

- 1 Align the shroud using center of the numbered fan bays as a guide and locate the tab projection on the left side of the fan module numbered 3. See Figure 3-15.
- 2 Push the system board shroud down until all edges are seated in the slots, securing the shroud to the system board.
- 3 Close the system. See "Opening and Closing the System" on page 82.

Integrated Remote Access Controller 6 (iDRAC6) Express Card (Optional)

Installing an iDRAC6 Express Card

 **WARNING:** Only trained service technicians are authorized to remove the system cover and access any of the components inside the system. Before you begin this procedure, review the safety instructions that came with the system.

- 1 Turn off the system, including any attached peripherals, and disconnect the system from the electrical outlet.
- 2 Open the system. See "Opening the System" on page 82.
- 3 To install the iDRAC6 Express card:
 - a Insert the notch on the iDRAC6 Express card into the clip on the system board.
 - b Align the front edge of the card with the connector on the system board. See Figure 7-1 for the location of the connector.
 - c Press the card down until it is fully seated. See Figure 3-16.
When the front of the card is fully seated, the plastic standoff tab snaps over the edge of the holder.

Figure 3-16. Installing or Removing an iDRAC6 Express Card (Optional)

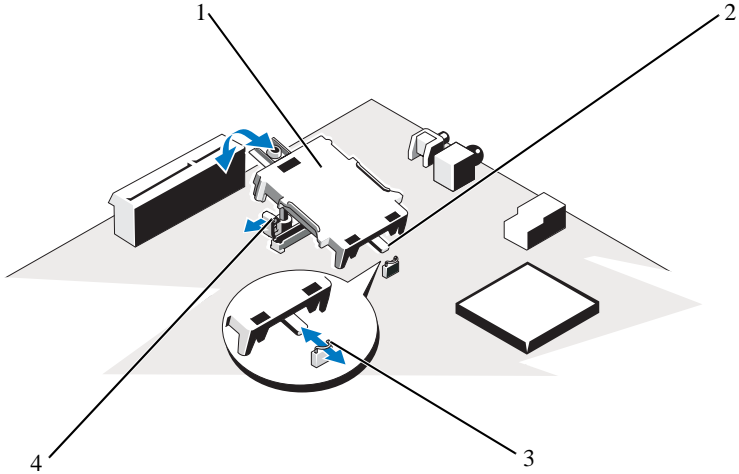

- | | | | |
|---|---------------------|---|----------------------|
| 1 | iDRAC6 Express card | 2 | notch |
| 3 | clip | 4 | plastic standoff tab |
- 4 Close the system. See "Closing the System" on page 83.
 - 5 Reconnect the system and peripherals to their power sources, and turn them on.

Removing an iDRAC6 Express Card (Optional)

⚠ WARNING: Only trained service technicians are authorized to remove the system cover and access any of the components inside the system. Before you begin this procedure, review the safety instructions that came with the system.

- 1 Turn off the system, including any attached peripherals, and disconnect the system from the electrical outlet.
- 2 Open the system. See "Opening the System" on page 82.

- 3 To remove the iDRAC6 Express card:
 - a Pull back slightly on the retention standoff tab at the front edge of the card and gently lift the card off the retention standoff. See Figure 3-20.

As the holder releases from the standoff, the connector under the card disengages from the system board connector.
 - b Angle the card so that the notch on the card slips through the clip on the system board.
- 4 Close the system. See "Closing the System" on page 83.
- 5 Reconnect the system and peripherals to their power sources, and turn them on.

Integrated Remote Access Controller 6 (iDRAC6) Enterprise Card (Optional)

Installing an iDRAC6 Enterprise Card

 **WARNING:** Only trained service technicians are authorized to remove the system cover and access any of the components inside the system. Before you begin this procedure, review the safety instructions that came with the system.

- 1 Turn off the system, including any attached peripherals, and disconnect the system from the electrical outlet.
- 2 Open the system. See "Opening the System" on page 82.
- 3 Remove the system board shroud. See "Removing the System Board Shroud" on page 105.
- 4 Remove the plastic filler plug for the iDRAC6 Enterprise port from the system back panel.

5 Install the iDRAC6 Enterprise card:

- a Angle the card so that the RJ-45 connector fits through the back-panel opening. See Figure 3-17.
- b Align the front edge of the card with the two front plastic retention standoffs next to the iDRAC6 connector on the system board, and lower the card into place. See Figure 3-17.

When the front of the card is fully seated, the plastic standoffs snap over the edge of the card.

Figure 3-17. Installing or Removing an iDRAC6 Enterprise Card (Optional)

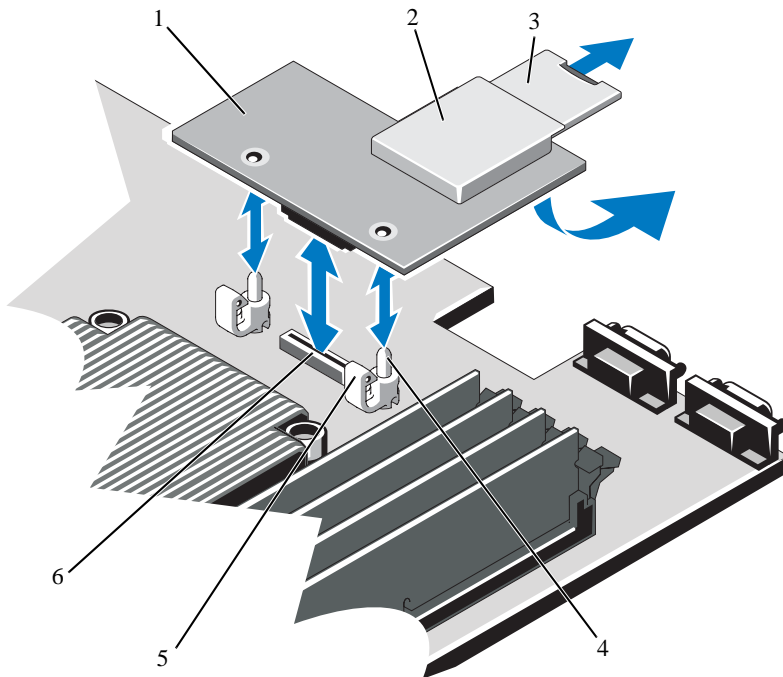

- | | | | |
|---|-----------------------------|---|----------------------------------|
| 1 | iDRAC6 Enterprise card | 2 | VFlash media slot |
| 3 | VFlash SD card | 4 | retention standoff posts (2) |
| 5 | retention standoff tabs (2) | 6 | iDRAC6 Enterprise card connector |

- 6 Close the system. See "Closing the System" on page 83.
- 7 Reconnect the system and peripherals to their power sources, and turn them on.

Removing an iDRAC6 Enterprise Card



WARNING: Only trained service technicians are authorized to remove the system cover and access any of the components inside the system. Before you begin this procedure, review the safety instructions that came with the system.

- 1 Turn off the system, including any attached peripherals, and disconnect the system from the electrical outlet.
- 2 If present, disconnect the Ethernet cable from the iDRAC6 enterprise card connector on the system back panel. See Figure 1-4.
- 3 Open the system. See "Opening the System" on page 82.
- 4 Remove the system board shroud. See "Removing the System Board Shroud" on page 105.
- 5 Remove the VFlash media card (if installed) from the iDRAC6 enterprise card. See "Integrated Remote Access Controller 6 (iDRAC6) Express Card (Optional)" on page 107.
- 6 Remove the iDRAC6 Enterprise card:
 - a Pull back slightly on the two tabs at the front edge of the card and gently lift the front edge of the card off of the retention standoffs.

As the card releases from the standoffs, the connector under the card disengages from the system board connector.
 - b Slide the card away from the back of the system until the RJ-45 connector is clear of the back panel, then lift the card out of the system.
- 7 Replace the plastic filler plug over the port at the system back panel. See "Back-Panel Features and Indicators" on page 15 for the port location.
- 8 Replace the system board shroud. See "Installing the System Board Shroud" on page 106.
- 9 Close the system. See "Closing the System" on page 83.
- 10 Reconnect the system and peripherals to their power sources, and turn them on.

VFlash Media (Optional)

The VFlash media card is a Secure Digital (SD) card that plugs into the optional iDRAC6 Enterprise card at the back corner of the system.

Installing a VFlash Media Card

- 1 Locate the VFlash media slot at the back corner of the system.
- 2 With the label side facing up, insert the contact-pin end of the SD card into the card slot on the module.
 **NOTE:** The slot is keyed to ensure correct insertion of the card.
- 3 Press inward on the card to lock it into the slot.

Removing a VFlash Media Card

To remove the VFlash media, push inward on the card to release it, and pull the card from the card slot.

Cooling Fans

Your system contains four dual-motor fans and provides cooling for the processor and memory modules and two dual-motor fans for the redundant power supplies.



NOTE: Hot-swap removal or installation of the fans is not supported.



NOTE: In the event of a problem with a particular fan, the fan number is referenced by the system's management software, allowing you to easily identify and replace the proper fan by noting the fan numbers on the fan assembly.

Removing a Cooling Fan



WARNING: Only trained service technicians are authorized to remove the system cover and access any of the components inside the system. Before you begin this procedure, review the safety instructions that came with the system.



WARNING: The cooling fan can continue to spin for some time after the system has been powered down. Allow time for the fan to stop spinning before removing it from the system.



WARNING: Do not attempt to operate the system without the cooling fan.



NOTE: The procedure for removing each individual fan module is the same.

- 1 Turn off the system, including any attached peripherals, and disconnect the system from its electrical outlet.
- 2 Open the system. See "Opening the System" on page 82.
- 3 Remove the system board shroud. See "Removing the System Board Shroud" on page 105.
- 4 Disconnect the fan's power cable from the system board. See Figure 3-18.
- 5 Remove the faulty fan by grasping the fan and sliding the fan from the fan assembly. See Figure 3-18.

Figure 3-18. Removing and Replacing a Fan

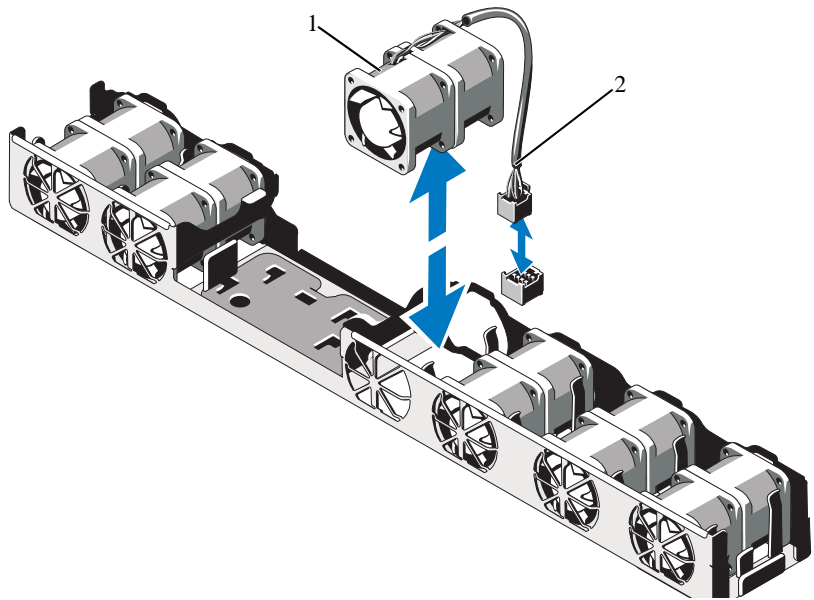

1 fan

2 power cable

Replacing a Cooling Fan

- 1 Ensure that the fan is oriented correctly.
Orient the fan module so that the side with the power cable faces towards the back of the system.
- 2 Slide the fan module into the fan assembly until the fan is fully seated. See Figure 3-18.
- 3 Connect the fan's power cable to the power connector on the system board.
- 4 Replace the system board shroud. See "Installing the System Board Shroud" on page 106.
- 5 Close the system. See "Closing the System" on page 83.
- 6 Reconnect the system to its electrical outlet and turn the system on, including any attached peripherals.

Optical Drive

An optional slimline DVD or DVD-RW optical drive slides into the front panel and connects to the SATA controller on the system board.

 NOTE: DVD devices are data only.

Removing an Optical Drive

-  **WARNING:** Only trained service technicians are authorized to remove the system cover and access any of the components inside the system. Before you begin this procedure, review the safety instructions that came with the system.
- 1 If installed, remove the optional front bezel. See "Removing and Replacing the Optional Front Bezel" on page 81.
 - 2 Turn off the system, including any attached peripherals, and disconnect the system from its electrical outlet.

- 3 Open the system. See "Opening the System" on page 82.
- 4 Disconnect the power and data cables from the back of the drive.
Note the routing of the power and data cables underneath the tabs on the system chassis as you remove them from the system board and drive. You must route these cables properly when you replace them to prevent them from being pinched or crimped.
- 5 To remove the drive, pull the release latch and lift and angle the drive to release it from the notch on the metal standoffs. Lift the drive out of the chassis. See Figure 3-19.
- 6 Close the system. See "Closing the System" on page 83.
- 7 If applicable, replace the optional front bezel. See "Removing and Replacing the Optional Front Bezel" on page 81.

Figure 3-19. Removing the Optical Drive

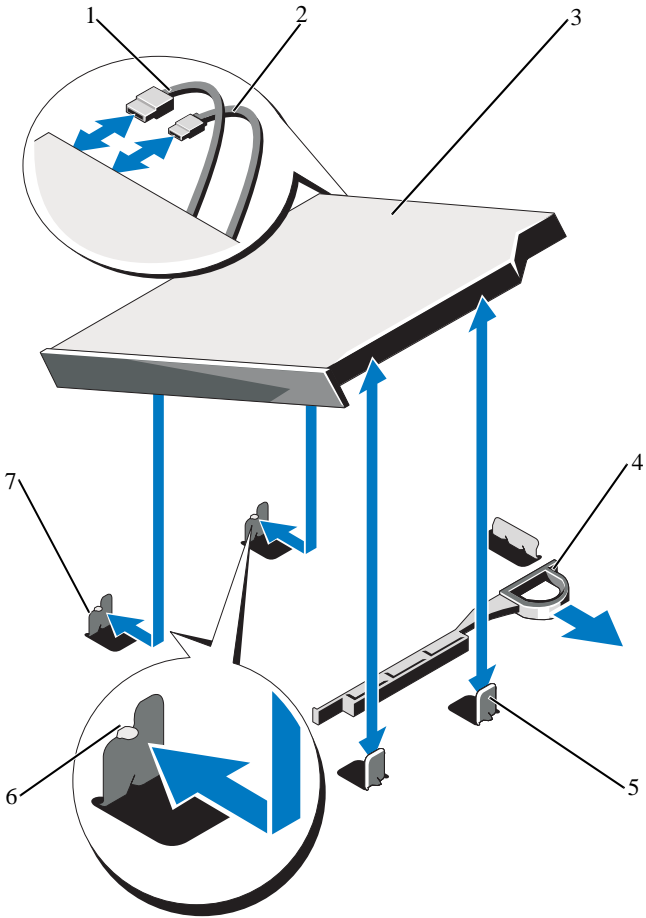

- | | | | |
|---|-------------------------------|---|---------------|
| 1 | data cable | 2 | power cable |
| 3 | optical drive | 4 | release latch |
| 5 | metal standoff (2) | 6 | notch (2) |
| 7 | metal standoff with notch (2) | | |

Installing an Optical Drive

 **WARNING:** Only trained service technicians are authorized to remove the system cover and access any of the components inside the system. Before you begin this procedure, review the safety instructions that came with the system.

- 1 If installed, remove the optional front bezel. See "Removing and Replacing the Optional Front Bezel" on page 81.
- 2 Turn off the system, including any attached peripherals, and disconnect the system from its electrical outlet.
- 3 Open the system. See "Opening the System" on page 82.
- 4 Align the two notches of the metal standoffs on the chassis with the holes in the drive. See Figure 3-19.
- 5 Pull the release latch, place the optical drive in position, and release the release latch.
- 6 Connect the power and data cables to the back of the drive.
You must route these cables properly underneath the tabs on the system chassis to prevent them from being pinched or crimped. See Figure 3-1.
- 7 If not already done, connect the power cable to DVD_PWR and the interface cable to SATA_E on the system board. See Figure 7-1.
- 8 If applicable, replace the optional front bezel. See "Removing and Replacing the Optional Front Bezel" on page 81.
- 9 Reconnect the system and peripherals to their electrical outlets.

RAID Battery (Optional)

Removing the RAID Battery

The information in this section applies only to systems with the optional PERC controller card.

- 1 Turn off the system, including any attached peripherals, and disconnect the system from the electrical outlet.
- 2 Open the system. See "Opening the System" on page 82.
- 3 To disconnect the RAID battery cable from the connector on the system board, press the tab on the RAID battery cable connector, and gently pull the cable connector out of the connector on the system board. See Figure 3-20.

- 4 Pull back gently on the two tabs holding the RAID battery and lift the RAID battery from the battery carrier. See Figure 3-20.

Figure 3-20. Removing and Installing the RAID Battery

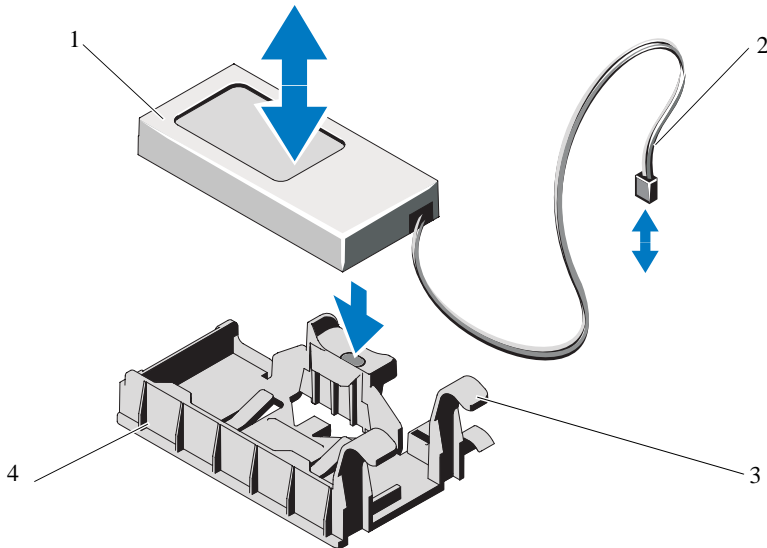

- | | | | |
|---|--------------------------|---|-------------------------|
| 1 | RAID battery | 2 | battery cable connector |
| 3 | battery carrier tabs (2) | 4 | battery carrier |

Installing the RAID Battery

- 1 Insert the RAID battery into the battery carrier until it locks into place. See Figure 3-20.
- 2 Connect the battery cable to the connector on the system board. See Figure 7-1.
- 3 Close the system. See "Closing the System" on page 83.
- 4 Place the system upright on a flat, stable surface.
- 5 Turn on the system and attached peripherals.

System Memory

Your system supports DDR3 registered DIMMs (RDIMMs) or unbuffered ECC DIMMs (UDIMMs). Single and dual-rank DIMMs can be 1067- or 1333-MHz, and quad-rank DIMMs can be 1067-MHz.

The system contains 8 memory sockets split into two sets of four sockets, one set per each processor. Each four-socket set is organized into three channels. Two DIMMs for channel 0 and a single DIMM for channel 1 and 2. The first socket of each channel is marked with white release levers.

The maximum memory that is supported on your system varies according to the types and sizes of memory modules being used:

- Single-rank and dual-rank RDIMMs of sizes 2-GB, 4-GB and 8-GB are supported for a total of up to 64 GB.
- Quad-rank RDIMMs are supported for a total of up to 64 GB.
- 1-GB and 2-GB UDIMMs are supported for a total of up to 16 GB.

General Memory Module Installation Guidelines

To ensure optimal performance of your system, observe the following general guidelines when configuring your system memory.



NOTE: Memory configurations that fail to observe these guidelines can prevent your system from starting and producing any video output.

- RDIMMs and UDIMMs cannot be mixed.
- Except for memory channels that are unused, all populated memory channels must have identical configurations.
- In a dual-processor configuration, the memory configuration for each processor must be identical.
- Memory modules of different sizes can be mixed in A1-A4 or B1-B4 (for example, 2-GB and 4-GB), but all populated channels must have identical configurations.
- For Optimizer Mode, memory modules are installed in the numeric order of the sockets beginning with A1 or B1.
- For Memory Mirroring or Advanced ECC Mode, the two sockets furthest from the processor are unused and memory modules are installed beginning with socket A1 or B1 and proceeding with socket A2 or B2.

- Advanced ECC Mode requires memory modules that use x4 or x8 DRAM device widths.
- The memory speed of each channel depends on the memory configuration:
 - For single or dual-rank memory modules:
 - One memory module per channel supports up to 1333 MHz.
 - Two memory modules per channel supports up to 1067 MHz.
 - For quad-rank memory modules:
 - One memory module per channel supports up to 1067 MHz.
 - Two memory modules per channel are limited to 800 MHz, regardless of memory module speed.
- If quad-rank memory modules are mixed with single- or dual-rank modules, the quad-rank modules must be installed in the sockets with the white release levers.
- If memory modules with different speeds are installed, they will operate at the speed of the slowest installed memory module(s).

Mode-Specific Guidelines

Three memory channels are allocated to each processor. The number of channels used and the allowable configurations depend on the memory mode selected.

Advanced ECC (Lockstep) Mode Support

In this configuration, the two channels closest to the processor are combined to form one 128-bit channel. This mode supports Single Device Data Correction (SDDC) for both x4- and x8-based memory modules. Memory modules must be identical in size, speed, and technology in corresponding slots.

Memory Mirroring Support

The system supports memory mirroring if identical memory modules are installed in the two channels closest to the processor (memory should not be installed in the farthest channel). Mirroring must be enabled in the System Setup program. In a mirrored configuration, the total available system memory is one-half of the total installed physical memory.

Optimizer (Independent Channel) Mode

In this mode, all three channels are populated with identical memory modules. This mode permits a larger total memory capacity but does not support SDDC with x8-based memory modules.

A minimal single-channel configuration of one 1-GB memory module per processor is also supported in this mode.

Table 3-2 and Table 3-3 show sample memory configurations that follow the appropriate memory guidelines stated in this section. The samples show identical memory-module configurations and their the physical and available memory totals. The tables do not show mixed or quad-rank memory-module configurations, nor do they address the memory speed considerations of any configuration.

Table 3-2. Sample RDIMM Single- and Dual-Rank Memory Configurations (Per Processor)

Memory Mode	Memory Module Size	Memory Sockets				Single Processor		Dual Processor	
		4	1	2	3	Physical Memory (GB)	Available Memory (GB)	Physical Memory (GB)	Available Memory (GB)
Optimizer	1-GB		X			1	all	2	all
			X	X		2		4	
			X	X	X	3		6	
		X	X			2		4	
		X	X	X	X	4		8	

Table 3-2. Sample RDIMM Single- and Dual-Rank Memory Configurations
(Per Processor) (*continued*)

Memory Mode	Memory Module Size	Memory Sockets				Single Processor		Dual Processor	
		4	1	2	3	Physical Memory (GB)	Available Memory (GB)	Physical Memory (GB)	Available Memory (GB)
	2-GB		X			2	all	4	all
			X	X		4		8	
			X	X	X	6		12	
		X	X	X	X	4		8	
		X	X	X	X	8		16	
	4-GB		X			4	all	8	all
			X	X		8		16	
			X	X	X	12		24	
		X	X	X	X	8		16	
		X	X	X	X	16		32	
	8-GB ¹		X			8	all	16	all
			X	X		16		32	
		X	X	X	24		48		
X		X	X	X	16		32		
	X	X	X	X	32		64		
Advanced ECC ²	2-GB		X	X		4	all	8	all
	4-GB		X	X		8	all	16	all
	8-GB ¹		X	X		16	all	32	all
Mirroring	2-GB		X	X		4	2	8	4
	4-GB		X	X		8	4	16	8
	8-GB ¹		X	X		16	8	32	16



1. When available.
2. Requires x4- or x8-based memory modules.

Table 3-3. Sample UDIMM Memory Configurations (Per Processor)

Memory Mode	Memory Module Size	Memory Sockets				Single Processor		Dual Processor	
		4	1	2	3	Physical Memory (GB)	Available Memory (GB)	Physical Memory (GB)	Available Memory (GB)
Optimizer	1-GB		X			1	all	2	all
			X	X		2		4	
			X	X	X	3		6	
		X	X	X	X	4		8	
	2-GB		X			2	all	4	all
			X	X		4		8	
			X	X	X	6		12	
		X	X	X	X	8		16	
Advanced ECC ¹	1-GB		X	X		2	all	4	all
	2-GB		X	X		4	all	8	all
Mirroring	1-GB		X	X		2	1	4	2
	2-GB		X	X		4	2	8	4

1.Requires x4- or x8-based memory modules.

Installing Memory Modules

-  **WARNING:** Only trained service technicians are authorized to remove the system cover and access any of the components inside the system. Before you begin this procedure, review the safety instructions that came with the system.
-  **WARNING:** The memory modules are hot to the touch for some time after the system has been powered down. Allow time for the memory modules to cool before handling them. Handle the memory modules by the card edges and avoid touching the components on the memory module.
-  **CAUTION:** To ensure proper system cooling, memory-module blanks must be installed in any memory socket that is not occupied. Remove memory-module blanks only if you intend to install memory in those sockets.

- 1 Turn off the system, including any attached peripherals, and disconnect the system from the electrical outlet.
- 2 Open the system. See "Opening the System" on page 82.
- 3 Remove the system board shroud. See "Removing the System Board Shroud" on page 105.
- 4 Locate the memory module sockets. See Figure 7-1.
- 5 Press the ejectors on the memory module socket down and out, as shown in Figure 3-21, to allow the memory module to be inserted into the socket.
- 6 Handle each memory module only on either card edge, making sure not to touch the middle of the memory module.

Figure 3-21. Installing and Removing a Memory Module

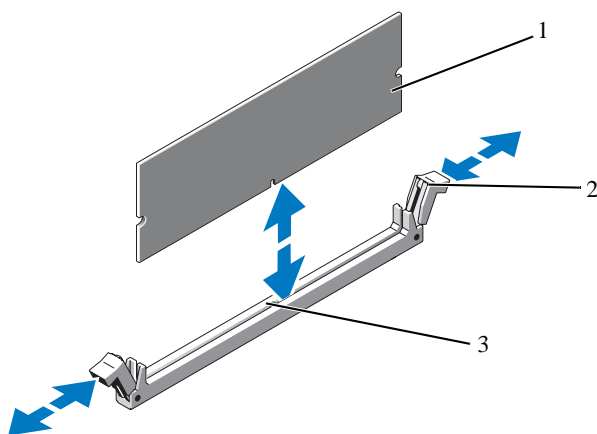

- | | | | |
|---|---------------|---|-----------------------------------|
| 1 | memory module | 2 | memory module socket ejectors (2) |
| 3 | alignment key | | |

- 7 Align the memory module's edge connector with the alignment key of the memory module socket, and insert the memory module in the socket.



NOTE: The memory module socket has an alignment key that allows you to install the memory module in the socket in only one way.

- 8 Press down on the memory module with your thumbs to lock the memory module into the socket.

When the memory module is properly seated in the socket, the ejectors on the memory module socket align with the ejectors on the other sockets that have memory modules installed.

- 9 Repeat step 5 through step 8 of this procedure to install the remaining memory modules. See Table 3-3.
- 10 Replace the system board shroud. See "Installing the System Board Shroud" on page 106.
- 11 Close the system. See "Closing the System" on page 83.
- 12 Start up the system, press <F2> to enter the System Setup program, and check the **System Memory** setting on the main System Setup screen.
The system should have already changed the value to reflect the newly installed memory.
- 13 If the value is incorrect, one or more of the memory modules may not be installed properly. Repeat step 2 through step 12 of this procedure, checking to ensure that the memory modules are firmly seated in their sockets.
- 14 Run the system memory test in the system diagnostics. See "Running the Embedded System Diagnostics" on page 166.

Removing Memory Modules



WARNING: Only trained service technicians are authorized to remove the system cover and access any of the components inside the system. Before you begin this procedure, review the safety instructions that came with the system.



WARNING: The memory modules are hot to the touch for some time after the system has been powered down. Allow time for the memory modules to cool before handling them. Handle the memory modules by the card edges and avoid touching the components on the memory module.



CAUTION: To ensure proper system cooling, memory-module blanks must be installed in any memory socket that is not occupied. Remove memory-module blanks only if you intend to install memory in those sockets.

- 1 Turn off the system, including any attached peripherals, and disconnect the system from the electrical outlet.
- 2 Open the system. See "Opening the System" on page 82.
- 3 Remove the system board shroud. See "Removing the System Board Shroud" on page 105.
- 4 Locate the memory module sockets. See Figure 7-1.
- 5 Press down and out on the ejectors on each end of the socket until the memory module pops out of the socket. See Figure 3-21.
Handle each memory module only on either card edge, making sure not to touch the middle of the memory module.
- 6 Replace the system board shroud. See "Installing the System Board Shroud" on page 106.
- 7 Close the system. See "Closing the System" on page 83.
- 8 Reconnect the system and peripherals to their power sources, and turn them on.

Processors

Removing a Processor



WARNING: Only trained service technicians are authorized to remove the system cover and access any of the components inside the system. Before you begin this procedure, review the safety instructions that came with the system.

- 1 Prior to upgrading your system, download the latest system BIOS version on **support.bull.com**.
- 2 Turn off the system, including any attached peripherals, and disconnect the system from the electrical outlet.
- 3 Open the system. See "Opening the System" on page 82.
- 4 Remove the system board shroud. See "Removing the System Board Shroud" on page 105.



CAUTION: Never remove the heat sink from a processor unless you intend to remove the processor. The heat sink is necessary to maintain proper thermal conditions.

- 5 Using a #2 Phillips screwdriver, loosen one of the heat-sink retention screws. See Figure 3-22.
- 6 Wait 30 seconds for the heat sink to loosen from the processor.
- 7 Loosen the other heat-sink retention screws.
- 8 Gently lift the heat sink off of the processor and set the heat sink aside with thermal grease side facing up.

△ CAUTION: The processor is held in its socket under strong pressure. Be aware that the release lever can spring up suddenly if not firmly grasped.

- 9 Position your thumb firmly over the processor socket-release lever and release the lever from the locked position. Rotate the lever 90 degrees upward until the processor is released from the socket. See Figure 3-23.

Figure 3-22. Installing and Removing the Heat Sink

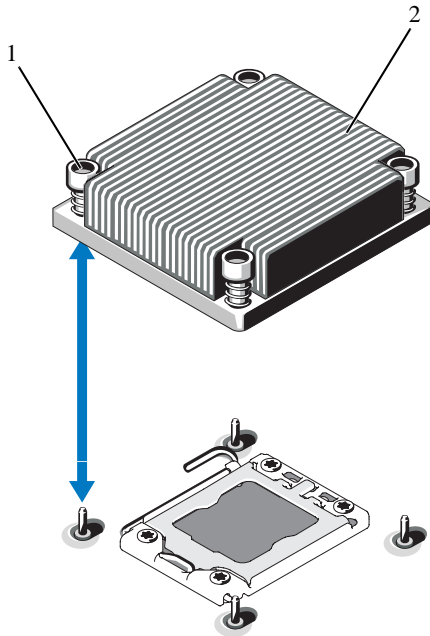

1 heat-sink retention screws (4)

2 heat sink

- 10 Rotate the processor shield upward and out of the way. See Figure 3-23.
- 11 Lift the processor out of the socket and leave the release lever up so that the socket is ready for the new processor.

 **CAUTION:** Be careful not to bend any of the pins on the ZIF socket when removing the processor. Bending the pins can permanently damage the system board.

If you are permanently removing a processor from socket CPU2, you must install a processor blank and a heat-sink blank to ensure proper system cooling. Adding the blanks is similar to adding a processor. See "Installing a Processor" on page 129.

 **NOTE:** In single-processor configurations, a processor must be installed in socket CPU1. Install the blanks in socket CPU2 only.

Figure 3-23. Installing and Removing a Processor



- | | | | |
|---|--------------------|---|----------------------|
| 1 | processor | 2 | processor shield |
| 3 | notch in processor | 4 | socket key |
| 5 | ZIF socket | 6 | socket-release lever |

Installing a Processor

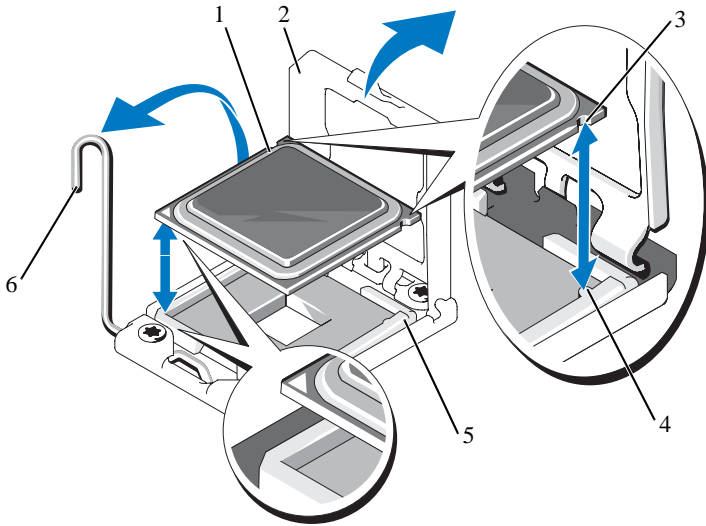
⚠ **WARNING:** Only trained service technicians are authorized to remove the system cover and access any of the components inside the system. Before you begin this procedure, review the safety instructions that came with the system.

- 1 If you are upgrading your processors, prior to upgrading your system, download and install the latest system BIOS version from support.bull.com. Follow the instructions included in the file download to install the update on your system.

📎 **NOTE:** In single-processor configurations, socket CPU1 must be used.

- 2 If you are adding a second processor for the first time, remove the heatsink blank and the processor blank from the vacant processor socket. Removing the blanks is similar to removing a processor. See "Removing a Processor" on page 126.
- 3 Unpack the processor if it has not been used previously.
If the processor has already been used, remove any thermal grease from the top of the processor using a lint-free cloth.
- 4 Align the processor with the socket keys on the ZIF socket. See Figure 3-23.
- 5 Install the processor in the socket.



CAUTION: Positioning the processor incorrectly can permanently damage the system board or the processor. Be careful not to bend the pins in the socket.

- a With the release lever on the processor socket in the open position, align the processor with the socket keys and set the processor lightly in the socket.



CAUTION: Do not use force to seat the processor. When the processor is positioned correctly, it engages easily into the socket.



- b Close the processor shield.
- c Rotate the socket release lever down until it snaps into place.

- 6 Install the heat sink.
 - a Using a clean lint-free cloth, remove the thermal grease from the heat sink.
 - b Open the grease packet included with your processor kit and apply thermal grease evenly to the center of the top of the new processor.
-  **CAUTION:** Using excess thermal grease can cause grease to contact the processor shield, which can cause contamination of the processor socket.
 - c Place the heat sink on the processor. See Figure 3-22.
 - d Using a #2 Phillips screwdriver, tighten the heat-sink retention screws. See Figure 3-22.
- 7 Replace the system board shroud. See "Installing the System Board Shroud" on page 106.
- 8 Close the system. See "Closing the System" on page 83.
- 9 Reconnect the system to its electrical outlet and turn the system on, including any attached peripherals.
- 10 Press <F2> to enter the System Setup program, and check that the processor information matches the new system configuration. See "Entering the System Setup Program" on page 56.
- 11 Run the system diagnostics to verify that the new processor operates correctly.

See "Running the Embedded System Diagnostics" on page 166 for information about running the diagnostics.

System Battery

Replacing the System Battery

-  **WARNING:** Only trained service technicians are authorized to remove the system cover and access any of the components inside the system. Before you begin this procedure, review the safety instructions that came with the system.
-  **WARNING:** There is a danger of a new battery exploding if it is incorrectly installed. Replace the battery only with the same or equivalent type recommended by the manufacturer. See your safety information for additional info.

- 1 Turn off the system, including any attached peripherals, and disconnect the system from the electrical outlet.
- 2 Open the system. See "Opening the System" on page 82.
- 3 Remove the system board shroud. See "Removing the System Board Shroud" on page 105.

Figure 3-24. Replacing the System Battery

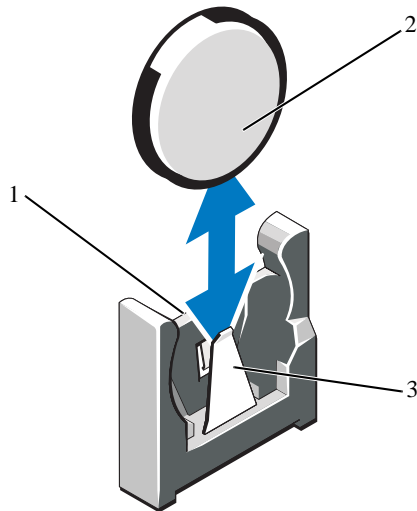

- | | |
|--------------------------------------|------------------|
| 1 positive side of battery connector | 2 system battery |
| 3 negative side of battery connector | |

- 4 Locate the battery socket. See "Jumpers and Connectors" on page 171.

△ CAUTION: To avoid damage to the battery connector, you must firmly support the connector while installing or removing a battery.

- 5 Remove the system battery.
 - a Support the battery connector by firmly holding the positive side of the connector.
 - b Press the battery toward the negative side of the connector and lift it up out of the securing tab at the negative side of the connector.

- 6 Install the new system battery.
 - a Support the battery connector by pressing down firmly on the positive side of the connector.
 - b Hold the battery with the "+" facing the plastic connector on the system board and slide it under the securing tabs.
 - c Press the battery straight down into the connector until it snaps into place.
- 7 Replace the system board shroud. See "Installing the System Board Shroud" on page 106.
- 8 Close the system. See "Closing the System" on page 83.
- 9 Reconnect the system to the electrical outlet and turn the system on, including any attached peripherals.
- 10 Enter the System Setup program to confirm that the battery is operating properly. See "Entering the System Setup Program" on page 56.
- 11 Enter the correct time and date in the System Setup program's **Time** and **Date** fields.
- 12 Exit the System Setup program.

Control Panel Assembly-LED/LCD (Service-Only Procedure) (Optional)



NOTE: The LCD control panel assembly consists of two separate modules—the display module and the control panel circuit board. Use the following instructions to remove and install either module.

Removing the Control Panel Assembly



WARNING: Only trained service technicians are authorized to remove the system cover and access any of the components inside the system. Before you begin this procedure, review the safety instructions that came with the system.

- 1 If installed, remove the optional front bezel. See "Removing and Replacing the Optional Front Bezel" on page 81.
- 2 Turn off the system and attached peripherals, and disconnect the system from the electrical outlet and peripherals.

- 3 Open the system. See "Opening the System" on page 82.
- 4 Disconnect the control panel cable at back of the control panel board.
 - For LED control panel see Figure 3-25.
 - For LCD control panel see Figure 3-26.



CAUTION: Do not pull on the cable to unseat the connector. Doing so can damage the cable.

- a Press the metal tabs on the ends of the cable connector.
- b Gently work the connector out of the socket.
- 5 For LCD control panel, disconnect the display module cable from the control panel board. See Figure 3-26.
- 6 Remove the two screws that secure the control panel board to the system chassis and remove the board.

This completes the removal for LED control panel.

- 7 Remove the display module:
 - a Using a knife or a small flat-blade screwdriver, insert the blade beneath the front panel of the display and slide the blade across the bottom to lift the panel outward. See Figure 3-26.
 - b Bend the panel upward to allow access to the mounting screws.
 - c Remove the two screws that secure the display module to the system chassis.
 - d Remove the display module from the chassis cutout.

Figure 3-25. Control Panel Removal-LED (Optional)

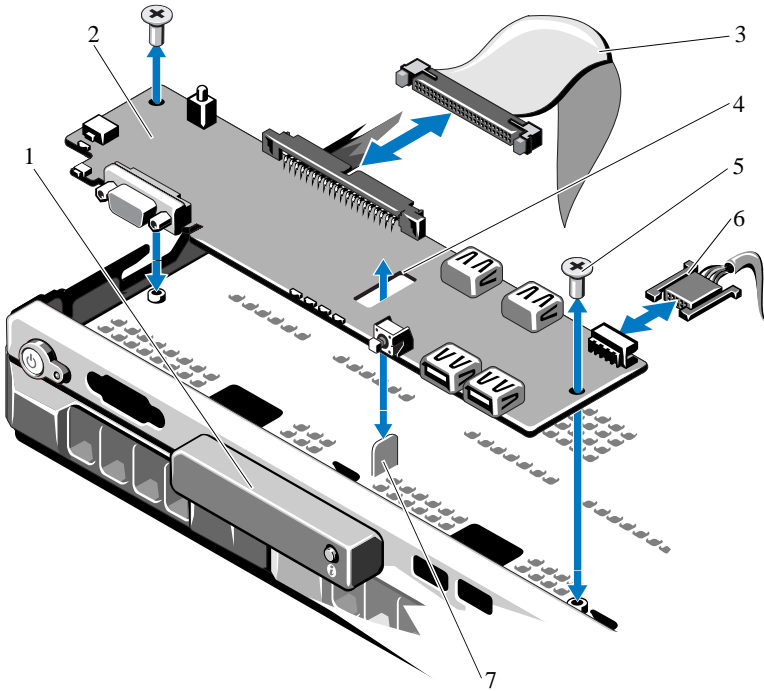

- | | | | |
|---|--------------------------|---|---------------------|
| 1 | LED display module | 2 | control panel board |
| 3 | control panel data cable | 4 | slot |
| 5 | mounting screws (2) | 6 | power cable |
| 7 | standoff | | |

Figure 3-26. Control Panel Removal-LCD (Optional)

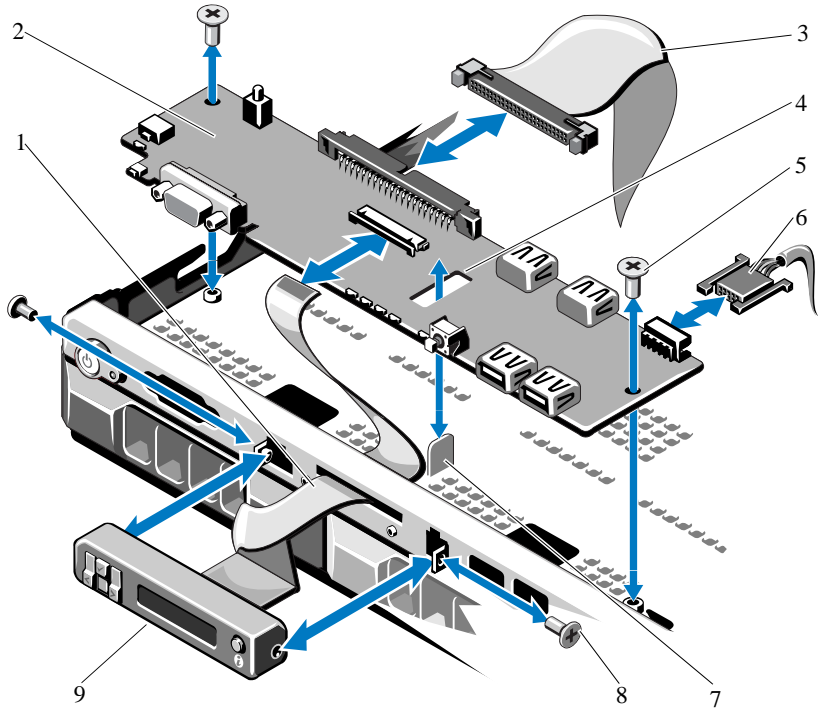



- | | | | |
|---|--------------------------|---|-----------------------|
| 1 | display module cable | 2 | control panel board |
| 3 | control panel data cable | 4 | slot |
| 5 | mounting screws (2) | 6 | power cable |
| 7 | standoff | 8 | front panel screw (2) |
| 9 | LCD display module | | |

Installing the Control Panel Assembly

- 1 For LED control panel, proceed to step 3. Insert the display module into the chassis cutout and secure with the two screws.
- 2 Affix the replacement panel to the front of the display module.
- 3 Align the slot in the control panel board with the standoff on the system chassis and secure with the two Phillips screws. See Figure 3-26. For LED control panel, skip step 4.
- 4 Connect the display module cable to the control panel board.
- 5 Connect the control panel cable to the control panel board.
- 6 Close the system. See "Closing the System" on page 83.
- 7 If applicable, replace the optional front bezel. See "Removing and Replacing the Optional Front Bezel" on page 81
- 8 Reconnect the system to the power source and turn on the system and attached peripherals.

SAS Backplane (Service-Only Procedure)

Removing the SAS Backplane

-  **WARNING:** Only trained service technicians are authorized to remove the system cover and access any of the components inside the system. Before you begin this procedure, review the safety instructions that came with the system.
- 1 If applicable, remove the bezel. See "Removing and Replacing the Optional Front Bezel" on page 81.
 - 2 Turn off the system and attached peripherals, and disconnect the system from the electrical outlet.
 - 3 Open the system. See "Opening the System" on page 82.
-  **CAUTION:** To prevent damage to the drives and backplane, you must remove the hard drives from the system before removing the backplane.
-  **CAUTION:** You must note the number of each hard drive and temporarily label them before removal so that you can replace them in the same locations.
- 4 Remove all hard drives. See "Removing a Hot-Swap Hard Drive" on page 85.
 - 5 Disconnect the power cable from the end of the SAS backplane.

- 6 Disconnect the SAS data cables from the backplane.
- 7 Remove the SAS backplane from the system:
 - a While pulling the two blue latches towards the front of the system, slide the backplane upward. See Figure 3-27.
 - b When the backplane cannot slide upward any farther, pull the backplane toward the back of the system to remove it from the retention hooks.
 - c Lift the board out of the system, being careful to avoid damaging components on the face of the board.
 - d Place the SAS backplane face down on a work surface.

Figure 3-27. Removing and Installing a SAS Backplane

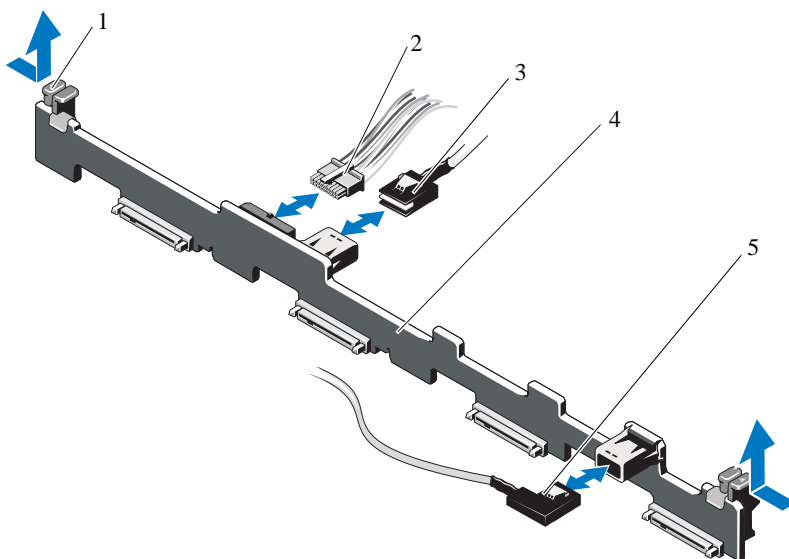

- | | | | |
|---|---------------------------------|---|---------------------------|
| 1 | backplane retention latches (2) | 2 | SAS backplane power cable |
| 3 | SAS A cable | 4 | SAS backplane |
| 5 | SAS B cable | | |

Installing the SAS Backplane

- 1 Install the SAS backplane:
 - a Lower the backplane into the system, being careful to avoid damaging components on the face of the board.
 - b Align the slots in the backplane with the retention hooks on the back of the drive bays, then move the backplane forward until the retention hooks fit through the slots in the backplane. See Figure 3-27.
 - c Slide the backplane downward until the two blue retention latches snap into place.
- 2 Connect the SAS data and power cables to the SAS backplane.
- 3 Install the hard drives in their original locations.
- 4 Close the system. See "Closing the System" on page 83.
- 5 Reconnect the system to its electrical outlet and turn the system on, including any attached peripherals.

Power Distribution Board (Service-Only Procedure)

The power distribution board is located on your system directly behind the power supply fan modules. This feature provides additional cooling to the power supplies through the power distribution shroud that routes airflow to the power supplies. See Figure 3-28.

Removing the Power Distribution Board

 **WARNING:** Only trained service technicians are authorized to remove the system cover and access any of the components inside the system. Before you begin this procedure, review the safety instructions that came with the system.

- 1 Remove the power supplies from the system. See "Removing a Redundant Power Supply" on page 92.
- 2 Locate the power distribution shroud cover and lift it out. See Figure 3-1.
- 3 Disconnect power distribution cables from the system board (see "System Board (Service-Only Procedure)" on page 141) and disconnect the fan cable connectors. See Figure 3-28.

- 4 Remove the two screws securing the power distribution board to the chassis. See Figure 3-28.
- 5 Slide the power distribution board away from the standoffs, and then lift the board out. See Figure 3-28.

Figure 3-28. Power Distribution Board

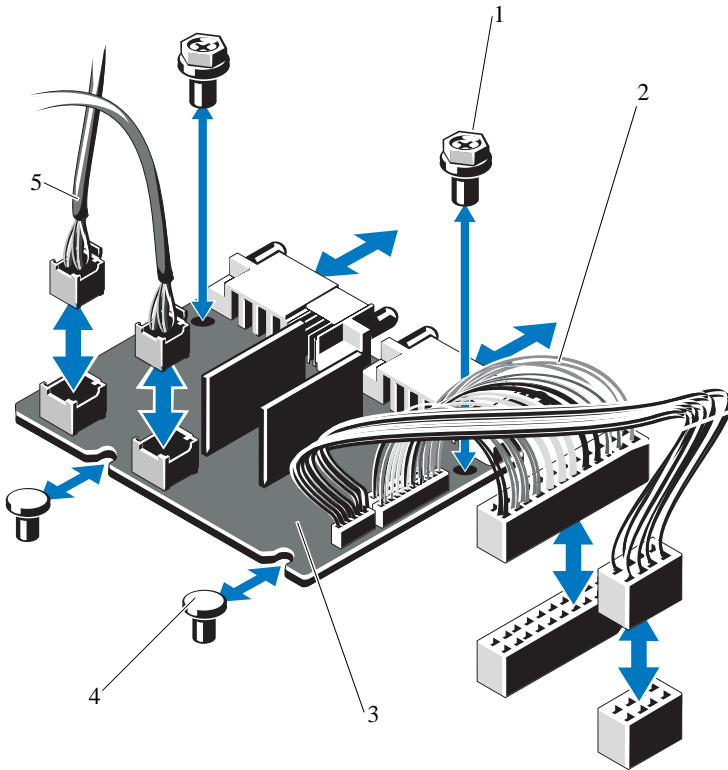

- | | | | |
|---|---------------------------------|---|-----------------------------|
| 1 | screws (2) | 2 | power supply connectors (2) |
| 3 | power-distribution board | 4 | standoffs (2) |
| 5 | fan module cable connectors (2) | | |

Replacing the Power Distribution Board

 **WARNING:** Only trained service technicians are authorized to remove the system cover and access any of the components inside the system. Before you begin this procedure, review the safety instructions that came with the system.

- 1 Unpack the new power distribution board assembly.
- 2 Align the power distribution board with the standoffs on the chassis and slide it in place. See Figure 3-28.
- 3 Install the two screws that secure the power distribution board to the chassis. See Figure 3-28.
- 4 Connect the power distribution cables to the system board (see "System Board (Service-Only Procedure)" on page 141) and fan cable connectors to the power distribution board as shown in Figure 3-28.
- 5 "Removing the Control Panel Assembly on page 133, and "Removing the SAS Backplane" on page 137.
- 6 Locate the hinged interior catches on either side of the shroud and align and seat the power distribution board cover, rotating it down and over the shroud. See Figure 3-28.
- 7 Install the power supplies in the system. See "Installing a Redundant Power Supply" on page 93.
- 8 Close the system. See "Closing the System" on page 83.
- 9 Reconnect the system to its electrical outlet and turn the system on, including any attached peripherals.

System Board (Service-Only Procedure)

Removing the System Board

 **WARNING:** Only trained service technicians are authorized to remove the system cover and access any of the components inside the system. Before you begin this procedure, review the safety instructions that came with the system.

 **CAUTION:** If you are using the Trusted Program Module (TPM) with an encryption key, you may be prompted to create a recovery key during program or system setup. Be sure to create and safely store this recovery key. If you replace this system board, you must supply the recovery key when you restart your system or program before you can access the encrypted data on your hard drives.

- 1 Turn off the system and attached peripherals, and disconnect the system from the electrical outlet.
- 2 Open the system. See "Opening the System" on page 82.
- 3 Remove the system board shroud. See "Removing the System Board Shroud" on page 105.
- 4 Remove all expansion cards and the integrated storage controller card. See "Removing an Expansion Card" on page 99 and "Removing the Integrated Storage Controller Card" on page 100.
- 5 Remove the expansion-card riser. See "Removing an Expansion-Card Riser" on page 102.
- 6 Remove the processor heat sinks. See "Removing a Processor" on page 126.
- 7 If installed, remove the optional iDRAC6 Enterprise card. See "Removing an iDRAC6 Enterprise Card" on page 111.
- 8 If installed, remove the optional iDRAC6 Express card. See "Removing an iDRAC6 Express Card (Optional)" on page 108.
- 9 Disconnect all cables from the system board.
- 10 Remove the system board assembly:
 - a Remove the nine screws securing the system board to the chassis and then slide the system board assembly toward the front end of the chassis.



CAUTION: Do not lift the system board assembly by grasping a memory module, processor, or other components.

- b Grasp the system board assembly by the edges of the system board and lift the assembly away from the chassis. See Figure 3-29.

Figure 3-29. Removing and Installing the System Board

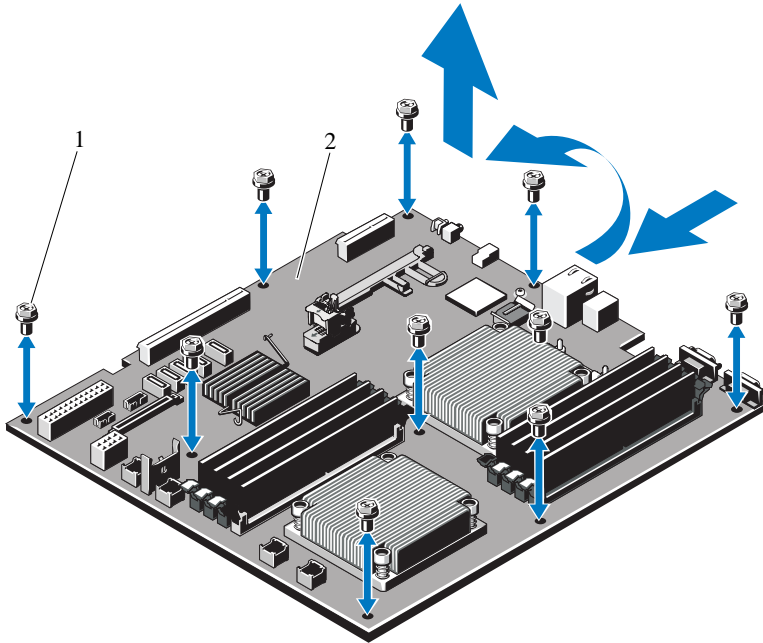

1 screws (9)

2 system board assembly

Installing the System Board

- 1 Unpack the new system board.
- 2 Remove the labels from the processor shield and affix them to the system identification panel on the front of the system. See Figure 1-1.
- 3 Transfer the processors to the new system board. See "Removing a Processor" on page 126 and "Installing a Processor" on page 129.
- 4 Remove the memory modules and transfer them to the same locations on the new board. See "Removing Memory Modules" on page 125 and "Installing Memory Modules" on page 123.

- 5 Install the new system board:
 - a Holding the system board by the edges of the system board, lower the the system board into the chassis.



CAUTION: Do not lift the system board assembly by grasping a memory module, processor, or other components.

- b Slightly lift up the front of the system board and maneuver the system board to the bottom of the chassis until it lays completely flat.
 - c Push the system board toward the back of the chassis until the board is in place.
 - d Tighten the nine screws that secure the system board to the chassis. See Figure 3-29.
 - e Tighten the processor heat sink screws. See "Installing a Processor" on page 129.
- 6 Connect the cables in the order listed below (see Figure 7-1 for the locations of the connectors on the system board):
 - SATA interface cable, if applicable
 - Control panel interface cable connector
 - Optical drive power cable connector
 - Control panel USB interface cable connector
 - SAS backplane power cable connector
 - System board power cable connectors
- 7 Replace the expansion-card risers. See "Replacing an Expansion-Card Riser" on page 103.
- 8 Install all expansion cards. See "Installing an Expansion Card" on page 97.
- 9 Reinstall the integrated storage controller card. See "Installing the Integrated Storage Controller Card" on page 101.

After connecting the SAS cables to the controller, make sure to place the cables under the guide on the end of riser 1.

- 10 If applicable, reconnect the RAID battery cable to the PERC controller card.
- 11 If applicable, reinstall the iDRAC6 Enterprise card. See "Installing an iDRAC6 Enterprise Card" on page 109.
- 12 If applicable, reinstall the iDRAC6 Express card. See "Installing an iDRAC6 Express Card" on page 107.
- 13 Replace the system board shroud. See "Installing the System Board Shroud" on page 106.
- 14 Close the system. See "Closing the System" on page 83.
- 15 Reconnect the system to its electrical outlet and turn the system on, including any attached peripherals.
- 16 If applicable, replace the Bezel. See "Removing and Replacing the Optional Front Bezel" on page 81.

Troubleshooting Your System

Safety First—For You and Your System

 **WARNING:** Only trained service technicians are authorized to remove the system cover and access any of the components inside the system. Before you begin this procedure, review the safety instructions that came with the system.

Troubleshooting System Startup Failure

If your system halts during startup prior to video imaging or LCD messaging, especially after installing an operating system or reconfiguring your system's hardware, check for the following conditions:

- If you boot the system to the BIOS boot mode after installing an operating system from the UEFI Boot Manager, the system will hang. The reverse is also true. You must boot to the same boot mode in which you installed the operating system. See "Using the System Setup Program and UEFI Boot Manager" on page 55.
- Invalid memory configurations could cause the system to halt at startup without any video output. See "System Memory" on page 119.

For all other startup issues, note the LCD panel messages and any system messages that appear onscreen. See "LCD Status Messages (Optional)" on page 21 and "System Messages" on page 35 for more information.

Troubleshooting External Connections

Ensure that all external cables are securely attached to the external connectors on your system before troubleshooting any external devices. See Figure 1-1 and Figure 1-4 for the front- and back-panel connectors on your system.

Troubleshooting the Video Subsystem

- 1 Check the system and power connections to the monitor.
- 2 Check the video interface cabling from the system to the monitor.
- 3 Run the appropriate online diagnostic test. See "Running the System Diagnostics" on page 165.
If the tests run successfully, the problem is not related to video hardware.
If the tests fail, see "Getting Help" on page 169.

Troubleshooting a USB Device

- 1 Use the following steps to troubleshoot a USB keyboard and/or mouse.
For other USB devices, go to step 2.
 - a Disconnect the keyboard and mouse cables from the system briefly and reconnect them.
 - b Connect the keyboard/mouse to the USB port(s) on the opposite side of the system.
If the problem is resolved, restart the system, enter the System Setup program, and check if the nonfunctioning USB ports are enabled.
 - c Replace the keyboard/mouse with another working keyboard/mouse.
If the problem is resolved, replace the faulty keyboard/mouse.
If the problem is not resolved, proceed to the next step to begin troubleshooting the other USB devices attached to the system.
- 2 Power down all attached USB devices and disconnect them from the system.
- 3 Restart the system and, if your keyboard is functioning, enter the system setup program. Verify that all USB ports are enabled. See "Integrated Devices Screen" on page 63.
If your keyboard is not functioning, you can also use remote access. If the system is not accessible, see "System Board Jumpers" on page 171 for instructions on setting the NVRAM_CLR jumper inside your system and restoring the BIOS to the default settings.

- 4 Reconnect and power on each USB device one at a time.
- 5 If a device causes the same problem, power down the device, replace the USB cable, and power up the device.

If the problem persists, replace the device.

If all troubleshooting fails, see "Getting Help" on page 169.

Troubleshooting a Serial I/O Device

- 1 Turn off the system and any peripheral devices connected to the serial port.
- 2 Swap the serial interface cable with another working cable, and turn on the system and the serial device.

If the problem is resolved, replace the interface cable.

- 3 Turn off the system and the serial device, and swap the device with a comparable device.
- 4 Turn on the system and the serial device.

If the problem is resolved, replace the serial device.

If the problem persists, see "Getting Help" on page 169.

Troubleshooting a NIC

- 1 Run the appropriate online diagnostic test. See "Using Online Diagnostics" on page 165.
- 2 Restart the system and check for any system messages pertaining to the NIC controller.
- 3 Check the appropriate indicator on the NIC connector. See "NIC Indicator Codes" on page 17.

- If the link indicator does not light, check all cable connections.
- If the activity indicator does not light, the network driver files might be damaged or missing.

Remove and reinstall the drivers if applicable. See the NIC's documentation.

- Change the autonegotiation setting, if possible.
- Use another connector on the switch or hub.

If you are using a NIC card instead of an integrated NIC, see the documentation for the NIC card.

- 4 Ensure that the appropriate drivers are installed and the protocols are bound. See the NIC's documentation.
- 5 Enter the System Setup program and confirm that the NIC ports are enabled. See "Integrated Devices Screen" on page 63.
- 6 Ensure that the NICs, hubs, and switches on the network are all set to the same data transmission speed. See the documentation for each network device.
- 7 Ensure that all network cables are of the proper type and do not exceed the maximum length.

If all troubleshooting fails, see "Getting Help" on page 169.

Troubleshooting a Wet System



WARNING: Only trained service technicians are authorized to remove the system cover and access any of the components inside the system. Before you begin this procedure, review the safety instructions that came with the system.

- 1 Turn off the system and attached peripherals, and disconnect the system from the electrical outlet.
- 2 Open the system. See "Opening the System" on page 82.
- 3 Remove the following components from the system. See "Installing System Components" on page 79.
 - Cooling shroud
 - Hard drives
 - Vflash SD cards
 - USB memory keys
 - NIC hardware key
 - Expansion cards
 - Integrated storage card
 - iDRAC6 Express card

- iDRAC6 Enterprise card
 - Power supplies
 - Fans
 - Processors and heat sinks
 - Memory modules
- 4 Let the system dry thoroughly for at least 24 hours.
 - 5 Reinstall the components you removed in step 3.
 - 6 Close the system. See "Closing the System" on page 83.
 - 7 Reconnect the system to the electrical outlet, and turn on the system and attached peripherals.
If the system does not start properly, see "Getting Help" on page 169.
 - 8 If the system starts properly, shut down the system and reinstall all of the expansion cards that you removed. See "Installing an Expansion Card" on page 97.
 - 9 Run the appropriate online diagnostic test. See "Using Online Diagnostics" on page 165.
If the tests fail, see "Getting Help" on page 169.

Troubleshooting a Damaged System

 **WARNING:** Only trained service technicians are authorized to remove the system cover and access any of the components inside the system. Before you begin this procedure, review the safety instructions that came with the system.

- 1 Open the system. See "Opening the System" on page 82.
- 2 Ensure that the following components are properly installed:
 - Expansion cards
 - Power supplies
 - Fans
 - Processors and heat sinks
 - Memory modules
 - Hard-drive carriers
 - Cooling shroud

- 3 Ensure that all cables are properly connected.
 - 4 Close the system. See "Closing the System" on page 83.
 - 5 Run the system board tests in the system diagnostics. See "Running the System Diagnostics" on page 165.
- If the tests fail, see "Getting Help" on page 169.

Troubleshooting the System Battery



NOTE: If the system is turned off for long periods of time (for weeks or months), the NVRAM may lose its system configuration information. This situation is caused by a defective battery.

- 1 Re-enter the time and date through the System Setup program. See "Entering the System Setup Program" on page 56.
- 2 Turn off the system and disconnect it from the electrical outlet for at least one hour.
- 3 Reconnect the system to the electrical outlet and turn on the system.
- 4 Enter the System Setup program.

If the date and time are not correct in the System Setup program, replace the battery. See "Replacing the System Battery" on page 131.

If the problem is not resolved by replacing the battery, see "Getting Help" on page 169.



NOTE: Some software may cause the system time to speed up or slow down. If the system seems to operate normally except for the time kept in the System Setup program, the problem may be caused by software rather than by a defective battery.

Troubleshooting Power Supplies

- 1 Identify the faulty power supply by the power supply's fault indicator. See "Power Indicator Codes" on page 18.

 **CAUTION:** At least one power supply must be installed for the system to operate. Operating the system with only one power supply installed for extended periods of time can cause the system to overheat.

- 2 Reseat the power supply by removing and reinstalling it. See "Power Supplies" on page 92.

 **NOTE:** After installing a power supply, allow several seconds for the system to recognize the power supply and to determine if it is working properly. The power indicator turns green to signify that the power supply is functioning properly.

If the problem persists, replace the faulty power supply.

- 3 If the problem persists, see "Getting Help" on page 169.

Troubleshooting System Cooling Problems

 **WARNING:** Only trained service technicians are authorized to remove the system cover and access any of the components inside the system. Before you begin this procedure, review the safety instructions that came with the system

Ensure that none of the following conditions exist:

- System cover, cooling shroud, drive blank, or front or back filler panel is removed.
- Ambient temperature is too high.
- External airflow is obstructed.
- Cables inside the system obstruct airflow.
- An individual cooling fan is removed or has failed. See "Troubleshooting a Fan" on page 154.

Troubleshooting a Fan

 **WARNING:** Only trained service technicians are authorized to remove the system cover and access any of the components inside the system. Before you begin this procedure, review the safety instructions that came with the system.

- 1 Locate the faulty fan indicated by the LCD panel or the diagnostic software.
- 2 Turn off the system and all attached peripherals.
- 3 Open the system. See "Opening the System" on page 82.
- 4 Reseat the fan's power cable.
- 5 Restart the system.

If the fan functions properly, close the system. See "Closing the System" on page 83.

- 6 If the fan does not function, turn off the system and install a new fan. See "Replacing a Cooling Fan" on page 114.
- 7 Restart the system.

If the problem is resolved, close the system. See "Closing the System" on page 83.

If the replacement fan does not operate, see "Getting Help" on page 169.

Troubleshooting System Memory

 **WARNING:** Only trained service technicians are authorized to remove the system cover and access any of the components inside the system. Before you begin this procedure, review the safety instructions that came with the system.

- 1 If the system is operational, run the appropriate online diagnostic test. See "Running the System Diagnostics" on page 165.

If diagnostics indicates a fault, follow the corrective actions provided by the diagnostic program.

- 2 Turn off the system and attached peripherals, and unplug the system from the power source. Press the power button with the system unplugged, and then reconnect the system to power.

- 3 Turn on the system and attached peripherals and note the messages on the screen.
Go to step 12 if an error message appears indicating a fault with a specific memory module.
- 4 Enter the System Setup program and check the system memory setting. See "Memory Settings Screen" on page 60. Make any changes to the memory settings, if needed.
If the memory settings match the installed memory but a problem is still indicated, go to step 12.
- 5 Turn off the system and attached peripherals, and disconnect the system from the electrical outlet.
- 6 Open the system. See "Opening the System" on page 82.
- 7 Check the memory banks and ensure that they are populated correctly. See "General Memory Module Installation Guidelines" on page 119.
- 8 Reseat the memory modules in their sockets. See "Installing Memory Modules" on page 123.
- 9 Close the system. See "Closing the System" on page 83.
- 10 Reconnect the system to its electrical outlet, and turn on the system and attached peripherals.
- 11 Enter the System Setup program and check the system memory setting. See "Memory Settings Screen" on page 60.
- 12 Turn off the system and attached peripherals, and disconnect the system from the power source.
- 13 Open the system. See "Opening the System" on page 82.
- 14 If a diagnostic test or error message indicates a specific memory module as faulty, swap or replace the module.
- 15 To troubleshoot an unspecified faulty memory module, replace the memory module in the first DIMM socket with a module of the same type and capacity. See "Installing Memory Modules" on page 123.
- 16 Close the system. See "Closing the System" on page 83.
- 17 Reconnect the system to its electrical outlet, and turn on the system and attached peripherals.

- 18 As the system boots, observe any error message that appears and the diagnostic indicators on the front of the system.
- 19 If the memory problem is still indicated, repeat step 12 through step 18 for each memory module installed.

If the problem persists after all memory modules have been checked, see "Getting Help" on page 169.

Troubleshooting an Internal USB Key



WARNING: Only trained service technicians are authorized to remove the system cover and access any of the components inside the system. Before you begin this procedure, review the safety instructions that came with the system.

- 1 Enter the System Setup program and ensure that the USB key port is enabled. See "Integrated Devices Screen" on page 63.
- 2 Turn off the system and attached peripherals.
- 3 Open the system. See "Opening the System" on page 82.
- 4 Locate the USB key and reseat it. See "Internal USB Memory Key" on page 104.
- 5 Close the system. See "Closing the System" on page 83.
- 6 Turn on the system and attached peripherals and check if the USB key is functioning.
- 7 Repeat step 2 and step 3.
- 8 Insert a different USB key that you know works properly.
- 9 Close the system. See "Closing the System" on page 83.
- 10 Turn on the system and attached peripherals and check if the USB key is functioning.

Troubleshooting an Optical Drive

 **WARNING:** Only trained service technicians are authorized to remove the system cover and access any of the components inside the system. Before you begin this procedure, review the safety instructions that came with the system.

- 1 If installed, remove the optional front bezel. See "Removing and Replacing the Optional Front Bezel" on page 81.
- 2 Try using a different CD or DVD.
- 3 Enter the System Setup program and ensure that the drive's controller is enabled. See "Entering the System Setup Program" on page 56.
- 4 Run the appropriate online diagnostic test. See "Running the System Diagnostics" on page 165.
- 5 Turn off the system and attached peripherals, and disconnect the system from the electrical outlet.
- 6 Open the system. See "Opening the System" on page 82.
- 7 Ensure that the interface cable is securely connected to the optical drive and to the controller.
- 8 Ensure that a power cable is properly connected to the drive.
- 9 Close the system. See "Closing the System" on page 83.
- 10 Reconnect the system to the electrical outlet, and turn on the system and attached peripherals.

If the problem is not resolved, see "Getting Help" on page 169.

Troubleshooting an External Tape Drive

- 1 Try using a different tape cartridge.
- 2 Ensure that the device drivers for the tape drive are installed and are configured correctly. See your tape drive documentation for more information about device drivers.
- 3 Reinstall the tape-backup software as instructed in the tape-backup software documentation.
- 4 Ensure that the tape drive's interface cable is fully connected to the tape drive and the external port on the controller card.

- 5 Run the appropriate online diagnostics tests. See "Running the System Diagnostics" on page 165.
- 6 Turn off the system and attached peripherals, and disconnect the system from the electrical outlet.



WARNING: Only trained service technicians are authorized to remove the system cover and access any of the components inside the system. Before you begin this procedure, review the safety instructions that came with the system.

- 7 Open the system. See "Opening the System" on page 82.
- 8 Reseat the controller card in the expansion card slot.
- 9 Close the system. See "Closing the System" on page 83.
- 10 Reconnect the system to the electrical outlet, and turn on the system, including attached peripherals.

If the problem is not resolved, see the documentation for the tape drive for additional troubleshooting instructions.

If you cannot resolve the problem, see "Getting Help" on page 169.

Troubleshooting a Hard Drive



WARNING: Only trained service technicians are authorized to remove the system cover and access any of the components inside the system. Before you begin this procedure, review the safety instructions that came with the system.



CAUTION: This troubleshooting procedure can destroy data stored on the hard drive. Before you proceed, back up all files on the hard drive.

- 1 Run the appropriate online diagnostics test. See "Using Online Diagnostics" on page 165.
Depending on the results of the diagnostics test, proceed as needed through the following steps.
- 2 If installed, remove the optional front bezel. See "Removing and Replacing the Optional Front Bezel" on page 81.

- 3 If your system has a SAS RAID controller and your hard drives are configured in a RAID array, perform the following steps.
 - a Restart the system and press <Ctrl><R> to enter the host adapter configuration utility program.

See the documentation supplied with the host adapter for information about the configuration utility.
 - b Ensure that the hard drive(s) have been configured correctly for the RAID array.
 - c Exit the configuration utility and allow the system to boot to the operating system.
- 4 Ensure that the required device drivers for your controller card are installed and are configured correctly. See the operating system documentation for more information.
- 5 Restart the system, enter the System Setup program, and verify that the controller is enabled and the drives appear in the System Setup program. See "Entering the System Setup Program" on page 56.
- 6 Check the cable connections inside the system:
 - a Turn off the system, including any attached peripherals, and disconnect the system from the electrical outlet.
 - b Open the system. See "Opening the System" on page 82.
 - c Verify that the cable connections between the hard drive(s) and the drive controller are correct and that the cables are securely seated in their connectors.
 - d Close the system. See "Closing the System" on page 83
 - e Reconnect the system to the electrical outlet, and turn on the system and attached peripherals.

If the problem persists, see "Getting Help" on page 169.

Troubleshooting a SAS or SAS RAID Controller



NOTE: When troubleshooting a SAS or SAS RAID controller, also see the documentation for your operating system and the controller.

- 1 Run the appropriate online diagnostic test. See "Using Online Diagnostics" on page 165.
- 2 Enter the System Setup program and ensure that the SAS or SAS RAID controller is enabled. See "Entering the System Setup Program" on page 56.
- 3 Restart the system and press the applicable key sequence to enter the configuration utility program:
 - <Ctrl><C> for a SAS controller
 - <Ctrl><R> for a SAS RAID controller

See the controller's documentation for information about configuration settings.

- 4 Check the configuration settings, make any necessary corrections, and restart the system.
- 5 If installed, remove the optional front bezel. See "Removing and Replacing the Optional Front Bezel" on page 81.



WARNING: Only trained service technicians are authorized to remove the system cover and access any of the components inside the system. Before you begin this procedure, review the safety instructions that came with the system.

- 6 Turn off the system and attached peripherals, and disconnect the system from its electrical outlet.
- 7 Open the system. See "Opening the System" on page 82.
- 8 If you have a SAS RAID controller, ensure that the following RAID components are properly installed and connected:
 - Memory module
 - Battery
- 9 Verify that the cable connections between the SAS backplane(s) and the SAS controller are correct. See "Installing the SAS Backplane" on page 139.
- 10 Ensure that the cables are firmly connected to the SAS controller and the SAS backplane board.
- 11 Close the system. See "Closing the System" on page 83.

- 12 Reconnect the system to its electrical outlet, and turn on the system and attached peripherals.

If the problem persists, see "Getting Help" on page 169.

Troubleshooting Expansion Cards



NOTE: When troubleshooting an expansion card, see the documentation for your operating system and the expansion card.



WARNING: Only trained service technicians are authorized to remove the system cover and access any of the components inside the system. Before you begin this procedure, review the safety instructions that came with the system.

- 1 Run the appropriate online diagnostic test. See "Using Online Diagnostics" on page 165.
- 2 If installed, remove the optional front bezel. See "Removing and Replacing the Optional Front Bezel" on page 81.
- 3 Turn off the system and attached peripherals, and disconnect the system from the electrical outlet.
- 4 Open the system. See "Opening the System" on page 82.
- 5 Ensure that each expansion card is firmly seated in its connector. See "Installing an Expansion Card" on page 97.
- 6 Close the system. See "Closing the System" on page 83.
- 7 Reconnect the system to the electrical outlet, and turn on the system and attached peripherals.
- 8 Turn off the system and attached peripherals, and disconnect the system from the electrical outlet.
- 9 Open the system. See "Opening the System" on page 82.
- 10 Remove all expansion cards installed in the system. See "Removing an Expansion Card" on page 99.
- 11 Close the system. See "Closing the System" on page 83.
- 12 Reconnect the system to the electrical outlet, and turn on the system and attached peripherals.
- 13 Run the appropriate online diagnostic test. See "Running the System Diagnostics" on page 165.

If the tests fail, see "Getting Help" on page 169.

- 14 For each expansion card you removed in step 10, perform the following steps:
 - a Turn off the system and attached peripherals, and disconnect the system from the electrical outlet.
 - b Open the system. See "Opening the System" on page 82.
 - c Reinstall one of the expansion cards.
 - d Close the system. See "Closing the System" on page 83.
 - e Run the appropriate diagnostic test.If the tests fail, see "Getting Help" on page 169.

Troubleshooting the Microprocessors



WARNING: Only trained service technicians are authorized to remove the system cover and access any of the components inside the system. Before you begin this procedure, review the safety instructions that came with the system.

- 1 Run the appropriate online diagnostics test. See "Using Online Diagnostics" on page 165.
- 2 Turn off the system and attached peripherals, and disconnect the system from the electrical outlet.
- 3 Open the system. See "Opening the System" on page 82.
- 4 Ensure that each processor and heat sink are properly installed. See "Installing a Processor" on page 129.
- 5 Close the system. See "Closing the System" on page 83.
- 6 Reconnect the system to the electrical outlet, and turn on the system and attached peripherals.
- 7 Run the appropriate online diagnostic test. See "Running the System Diagnostics" on page 165.

If your system only has one processor and a problem is still indicated, see "Getting Help" on page 169.
- 8 For systems with multiple processors, turn off the system and attached peripherals, and disconnect the system from the electrical outlet.
- 9 Open the system. See "Opening the System" on page 82.

- 10 Remove all processors except for processor 1. See "Removing a Processor" on page 126.
- 11 Close the system. See "Closing the System" on page 83.
- 12 Reconnect the system to the electrical outlet, and turn on the system and attached peripherals.
- 13 Run the appropriate online diagnostic test. See "Running the System Diagnostics" on page 165.
If the test fails, the processor is faulty. See "Getting Help" on page 169.
- 14 Turn off the system and attached peripherals, and disconnect the system from the electrical outlet.
- 15 Open the system. See "Opening the System" on page 82.
- 16 Replace processor 1 with processor 2. See "Installing a Processor" on page 129.
- 17 Repeat step 11 through step 13.

If your system has more than two processors, continue installing and testing each processor in the processor 1 slot until you determine the faulty processor, and then replace the faulty processor. See "Getting Help" on page 169.

If you have tested all the processors and the problem persists, the system board is faulty. See "Getting Help" on page 169.

Running the System Diagnostics

If you experience a problem with your system, run the diagnostics before calling for technical assistance. The purpose of the diagnostics is to test your system's hardware without requiring additional equipment or risking data loss. If you are unable to fix the problem yourself, service and support personnel can use diagnostics test results to help you solve the problem.

Using Online Diagnostics

To assess a system problem, first use the online diagnostics. Online Diagnostics is a suite of diagnostic programs, or test modules, that include diagnostic tests on chassis and storage components such as hard drives, physical memory, communications ports, NICs, CMOS, and more. If you are unable to identify the problem using the online diagnostics, then use the embedded system diagnostics.

The files required to run online diagnostics for systems running supported Microsoft® Windows® and Linux operating systems are available at **support.bull.com**.

Embedded System Diagnostics Features

The embedded system diagnostics provides a series of menus and options for particular device groups or devices. The system diagnostics menus and options allow you to:

- Run tests individually or collectively
- Control the sequence of tests
- Repeat tests
- Display, print, or save test results
- Temporarily suspend testing if an error is detected or terminate testing when a user-defined error limit is reached
- View help messages that briefly describe each test and its parameters
- View status messages that inform you if tests are completed successfully

- View error messages that inform you of problems encountered during testing.

When to Use the Embedded System Diagnostics

If a major component or device in the system does not operate properly, component failure may be indicated. As long as the processor and the system's input/output devices are functioning, you can use the system diagnostics to help identify the problem.

Running the Embedded System Diagnostics

The system diagnostics program is run from the iDRAC6 Express System Services menu.

 **CAUTION:** Use the system diagnostics to test only your system. Using this program with other systems may cause invalid results or error messages.

- 1 As the system boots, press <F10>.
- 2 Select **Diagnostics** from the System Services menu.
- 3 Select **Launch Diagnostics**.
- 4 From the **Diagnostics** main menu, select **Run Diags**, or select **MpMemory** if you are troubleshooting memory.

The **Diagnostics** menu allows you to run all or specific diagnostics tests, or to exit.

Embedded System Diagnostics Testing Options

Select the testing option in the **Main Menu** window.

Testing Option	Function
Express Test	Performs a quick check of the system. This option runs device tests that do not require user interaction.
Extended Test	Performs a more thorough check of the system. This test can take an hour or longer.
Custom Test	Tests a particular device.
Information	Displays test results.

Using the Custom Test Options

When you select **Custom Test** in the **Main Menu** window, the **Customize** window allows you to select the device(s) to be tested, select specific options for testing, and view the test results.

Selecting Devices for Testing

The left side of the **Customize** window lists devices that can be tested. Click the (+) next to a device or module to view its components. Click (+) on any component to view the tests that are available. Clicking a device, rather than its components, selects all of the components of the device for testing. If an item is grayed-out and you wish to run that test, you can select it by highlighting the item and pressing the spacebar.



NOTE: After you select all the devices and components that you want to test, highlight All Devices and then click Run Tests.

Selecting Diagnostics Options

From the **Diagnostics Options** area, select the test(s) you want to run on a device.

- **Non-Interactive Tests Only** — Runs only tests that require no user intervention.
- **Quick Tests Only** — Runs only the quick tests on the device.
- **Show Ending Timestamp** — Time stamps the test log.
- **Test Iterations** — Selects the number of times the test is run.
- **Continue on Failure** — Enables the tests to continue without user intervention in the event that one of the tests has failed.
- **Log output file pathname** — Enables you to specify the diskette drive or USB memory key where the test log file is saved. You cannot save the file to a hard drive.

Viewing Information and Results

The following tabs in the **Customize** window provide information about the test and the test results.

- **Results** — Displays the test that ran and the result.
- **Errors** — Displays any errors that occurred during the test.

- **Help** — Displays information about the currently selected device, component, or test.
- **Configuration** — Displays basic configuration information about the currently selected device.
- **Parameters** — Displays parameters that you can set for the test.

Getting Help

Contacting Bull

 NOTE: If you do not have an active Internet connection, you can find contact information on your purchase invoice, packing slip, bill, or Bull product catalog.

Bull provides several online and telephone-based support and service options. Availability varies by country and product, and some services may not be available in your area.

Please contact your Bull Sales Representative for sales information.

Visit www.bull.com for product information or support.bull.com for technical support or customer service issues.





Jumpers and Connectors

This section provides specific information about the system jumpers. It also provides some basic information on jumpers and switches and describes the connectors on the various boards in the system.

System Board Jumpers

Figure 7-1 shows the location of the configuration jumpers on the system board. Table 7-1 lists the jumper settings.

Table 7-1. System Board Jumper Settings

Jumper	Setting	Description
PWRD_EN	 (default)	The password feature is enabled (pins 2-4)
		The password feature is disabled (pins 4-6)
NVRAM_CLR	 (default)	The configuration settings are retained at system boot (pins 3-5)
		The configuration settings are cleared at the next system boot (pins 1-3)

System Board Connectors

See Figure 7-1 and Table 7-2 for the location and description of the system board connectors.

Figure 7-1. System Board Connectors

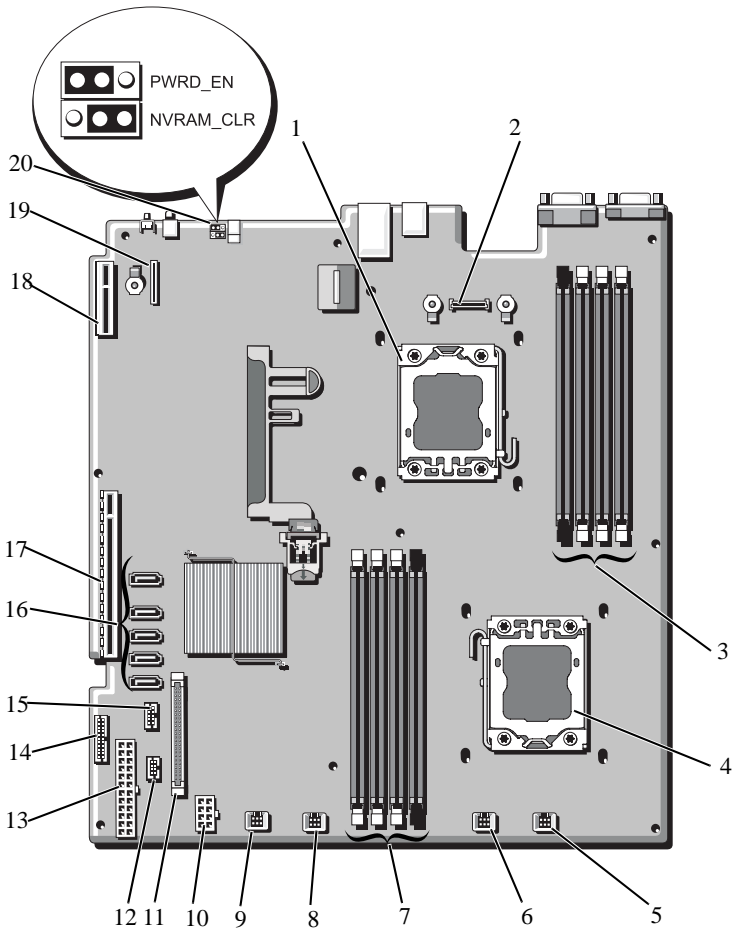

Table 7-2. System Board Connectors

Item	Connector	Description
1	CPU2	Processor 2
2	iDRAC6 Enterprise	iDRAC 6 Enterprise card connector
3	B4	Memory module slot B4
	B1	Memory module slot B1 (white release lever)
	B2	Memory module slot B2 (white release lever)
	B3	Memory module slot B3 (white release lever)
4	CPU1	Processor 1
5	FAN1	System fan 1 connector
6	FAN2	System fan 2 connector
7	A3	Memory module slot A3 (white release lever)
	A2	Memory module slot A2 (white release lever)
	A1	Memory module slot A1 (white release lever)
	A4	Memory module slot A4
8	FAN3	System fan 3 connector
9	FAN4	System fan 4 connector
10	12V	8-pin power connector
11	FP_CONN	Control panel connector
12	BP_CONN	Backplane power connector
13	PWR_CONN	24-pin power connector
14	PDB_I2C	Power distribution board connector
15	FP_USB_CONN	Control panel USB connector

NOTE: For the full name of an abbreviation or acronym used in this table, see the "Glossary" on page 177.

Table 7-2. System Board Connectors (*continued*)

Item	Connector	Description
16	SATA_A	SATA connector A
	SATA_B	SATA connector B
	SATA_C	SATA connector C
	SATA_D	SATA connector D
	SATA_E	SATA connector E
17	RISER	expansion-card riser connector
18	RISER	expansion-card riser connector
19	iDRAC6 Express	iDRAC6 Express card connector
20	PSWD_EN	Password enable jumper
	NVRM_CLR	NVRAM clear jumper

NOTE: For the full name of an abbreviation or acronym used in this table, see the "Glossary" on page 177.

Disabling a Forgotten Password

The system's software security features include a system password and a setup password, which are discussed in detail in "Using the System Setup Program and UEFI Boot Manager" on page 55. The password jumper enables these password features or disables them and clears any password(s) currently in use.

 **CAUTION:** Only trained service technicians are authorized to remove the system cover and access any of the components inside the system. Before you begin this procedure, review the safety instructions that came with the system.

- 1 Turn off the system, including any attached peripherals, and disconnect the system from the electrical outlet.
- 2 Open the system. See "Opening and Closing the System" on page 82.
- 3 Move the password jumper to the "disabled" position to clear the password. See Table 7-1.
See Figure 7-1 to locate the password jumper on the system board.
- 4 Close the system.

- 5 Reconnect your system and peripherals to their electrical outlets, and turn on the system.

The existing passwords are not disabled (erased) until the system boots with the password jumper plug in the "disabled" position. However, before you assign a new system and/or setup password, you must return the jumper plug to the enabled position.

 **NOTE:** If you assign a new system and/or setup password with the jumper plug still in the "disabled" position, the system disables the new password(s) the next time it boots.

- 6 Turn off the system, including any attached peripherals, and disconnect the system from the electrical outlet.
- 7 Open the system. See "Opening and Closing the System" on page 82.
- 8 Move the password jumper back to the enabled position to restore the password function. See Table 7-1.
- 9 Close the system.
- 10 Reconnect your system and peripherals to their electrical outlets, and turn on the system.
- 11 Assign a new system and/or setup password.

To assign a new password using the System Setup program, see "System and Setup Password Features" on page 71.

Glossary

A — Ampere(s).

AC — Alternating current.

ACPI — Advanced Configuration and Power Interface. A standard interface for enabling the operating system to direct configuration and power management.

ambient temperature — The temperature of the area or room where the system is located.

ANSI — American National Standards Institute. The primary organization for developing technology standards in the U.S.

asset tag — An individual code assigned to a system, usually by an administrator, for security or tracking purposes.

backup — A copy of a program or data file. As a precaution, back up your system's hard drive(s) on a regular basis.

blade — A module that contains a processor, memory, and a hard drive. The modules are mounted into a chassis that includes power supplies and fans.

BMC — Baseboard management controller.

bootable media — A CD, diskette, or USB memory key that is used to start your system if the system will not boot from the hard drive.

BTU — British thermal unit.

bus — An information pathway between the components of a system. Your system contains an expansion bus that allows the processor to communicate with controllers for the peripheral devices connected to the system. Your system also contains an address bus and a data bus for communications between the processor and RAM.

C — Celsius.

cache — A fast storage area that keeps a copy of data or instructions for quick data retrieval.

cm — Centimeter(s).

COM n — The device names for the serial ports on your system.

control panel — The part of the system that contains indicators and controls, such as the power button and power indicator.

controller — A chip or expansion card that controls the transfer of data between the processor and memory or between the processor and a peripheral device.

coprocessor — A chip that relieves the system's processor of specific processing tasks. A math coprocessor, for example, handles numeric processing.

CPU — Central processing unit. See *processor*.

DC — Direct current.

DDR — Double-data rate. A technology in memory modules that potentially doubles the data rate by transferring data on both the rising and falling pulses of a clock cycle.

device driver — A program that allows the operating system or some other program to interface correctly with a peripheral.

DHCP — Dynamic Host Configuration Protocol. A method of automatically assigning an IP address to a client system.

diagnostics — A comprehensive set of tests for your system.

DIMM — Dual in-line memory module. See also *memory module*.

DNS — Domain Name System. A method of translating Internet domain names, such as **www.example.com**, into IP addresses, such as 208.77.188.166.

DRAM — Dynamic random-access memory. A system's RAM is usually made up entirely of DRAM chips.

driver — See *device driver*.

DVD — Digital versatile disc or digital video disc.

ECC — Error checking and correction.

EMI — Electromagnetic interference.

ERA — Embedded remote access. ERA allows you to perform remote, or "out-of-band," server management on your network server using a remote access controller.

ESD — Electrostatic discharge.

ESM — Embedded server management.

expansion bus — Your system contains an expansion bus that allows the processor to communicate with controllers for peripherals, such as NICs.

expansion card — An add-in card, such as a NIC or SCSI adapter, that plugs into an expansion-card connector on the system board. An expansion card adds some specialized function to the system by providing an interface between the expansion bus and a peripheral.

expansion-card connector — A connector on the system board or riser board for plugging in an expansion card.

F — Fahrenheit.

FAT — File allocation table. The file system structure used by MS-DOS to organize and keep track of file storage. The Microsoft® Windows® operating systems can optionally use a FAT file system structure.

Fibre Channel — A high-speed network interface used primarily with networked storage devices.

flash memory — A type of electronic chip that can be programmed and reprogrammed using a software utility.

FSB — Front-side bus. The FSB is the data path and physical interface between the processor and the main memory (RAM).

FTP — File transfer protocol.

g — Gram(s).

G — Gravities.

Gb — Gigabit(s); 1024 megabits or 1,073,741,824 bits.

GB — Gigabyte(s); 1024 megabytes or 1,073,741,824 bytes. However, when referring to hard-drive capacity, the term is usually rounded to 1,000,000,000 bytes.

graphics mode — A video mode that can be defined as x horizontal by y vertical pixels by z colors.

host adapter — A controller that implements communication between the system's bus and the peripheral device, typically a storage device.

hot-swap — The ability to insert or install a device, typically a hard drive or an internal cooling fan, into the host system while the system is powered on and running.

Hz — Hertz.

I/O — Input/output. A keyboard is an input device, and a monitor is an output device. In general, I/O activity can be differentiated from computational activity.

IDE — Integrated drive electronics. A standard interface between the system board and storage devices.

iDRAC — Internet Remote Access Controller. A remote access controller that uses the Internet SCSI protocol.

IP — Internet Protocol.

IPv6 — Internet Protocol version 6.

IPX — Internet package exchange.

IRQ — Interrupt request. A signal that data is about to be sent to or received by a peripheral device travels by an IRQ line to the processor. Each peripheral connection must be assigned an IRQ number. Two devices can share the same IRQ assignment, but you cannot operate both devices simultaneously.

iSCSI — Internet SCSI (see *SCSI*). A protocol that enables SCSI device communication across a network or the Internet.

jumper — Small blocks on a circuit board with two or more pins emerging from them. Plastic plugs containing a wire fit down over the pins. The wire connects the pins and creates a circuit, providing a simple and reversible method of changing the circuitry in a board.

K — Kilo-; 1000.

Kb — Kilobit(s); 1024 bits.

KB — Kilobyte(s); 1024 bytes.

Kbps — Kilobit(s) per second.

KBps — Kilobyte(s) per second.

kg — Kilogram(s); 1000 grams.

kHz — Kilohertz.

KVM — Keyboard/video/mouse. KVM refers to a switch that allows selection of the system from which the video is displayed and for which the keyboard and mouse are used.

LAN — Local area network. A LAN is usually confined to the same building or a few nearby buildings, with all equipment linked by wiring dedicated specifically to the LAN.

LCD — Liquid crystal display.

LED — Light-emitting diode. An electronic device that lights up when a current is passed through it.

LGA — Land grid array.

local bus — On a system with local-bus expansion capability, certain peripheral devices (such as the video adapter circuitry) can be designed to run much faster than they would with a traditional expansion bus. See also *bus*.

LOM — LAN on motherboard.

LVD — Low voltage differential.

m — Meter(s).

mA — Milliamper(s).

MAC address — Media Access Control address. Your system's unique hardware number on a network.

mAh — Milliampere-hour(s).

Mb — Megabit(s); 1,048,576 bits.

MB — Megabyte(s); 1,048,576 bytes. However, when referring to hard-drive capacity, the term is often rounded to mean 1,000,000 bytes.

Mbps — Megabits per second.

MBps — Megabytes per second.

MBR — Master boot record.

memory address — A specific location, usually expressed as a hexadecimal number, in the system's RAM.

memory module — A small circuit board containing DRAM chips that connects to the system board.

memory — An area in your system that stores basic system data. A system can contain several different forms of memory, such as integrated memory (ROM and RAM) and add-in memory modules (DIMMs).

memory key — A portable flash memory storage device integrated with a USB connector.

MHz — Megahertz.

mirroring — A type of data redundancy in which a set of physical drives stores data and one or more sets of additional drives stores duplicate copies of the data. Mirroring functionality is provided by software. See also *striping* and *RAID*.

mm — Millimeter(s).

ms — Millisecond(s).

NAS — Network Attached Storage. NAS is one of the concepts used for implementing shared storage on a network. NAS systems have their own operating systems, integrated hardware, and software that are optimized to serve specific storage needs.

NIC — Network interface controller. A device that is installed or integrated in a system to allow connection to a network.

NMI — Nonmaskable interrupt. A device sends an NMI to signal the processor about hardware errors.

ns — Nanosecond(s).

NVRAM — Nonvolatile random-access memory. Memory that does not lose its contents when you turn off your system. NVRAM is used for maintaining the date, time, and system configuration information.

parity — Redundant information that is associated with a block of data.

parity stripe — In RAID arrays, a striped hard drive containing parity data.

partition — You can divide a hard drive into multiple physical sections called *partitions* with the **fdisk** command. Each partition can contain multiple logical drives. You must format each logical drive with the **format** command.

PCI — Peripheral Component Interconnect. A standard for local-bus implementation.

PDU — Power distribution unit. A power source with multiple power outlets that provides electrical power to servers and storage systems in a rack.

peripheral — An internal or external device, such as a diskette drive or keyboard, connected to a system.

pixel — A single point on a video display. Pixels are arranged in rows and columns to create an image. A video resolution, such as 640 x 480, is expressed as the number of pixels across by the number of pixels up and down.

POST — Power-on self-test. Before the operating system loads when you turn on your system, the POST tests various system components such as RAM and hard drives.

processor — The primary computational chip inside the system that controls the interpretation and execution of arithmetic and logic functions. Software written for one processor must usually be revised to run on another processor. *CPU* is a synonym for processor.

PXE — Preboot eXecution Environment. A way of booting a system via a LAN (without a hard drive or bootable diskette).

RAC — Remote access controller.

RAID — Redundant array of independent disks. A method of providing data redundancy. Some common implementations of RAID include RAID 0, RAID 1, RAID 5, RAID 10, and RAID 50. See also *mirroring* and *striping*.

RAM — Random-access memory. The system's primary temporary storage area for program instructions and data. Any information stored in RAM is lost when you turn off your system.

R-DIMM — A registered DDR3 memory module.

readme file — A text file, usually shipped with software or hardware, that contains information supplementing or updating the product's documentation.

read-only file — A read-only file is one that you are prohibited from editing or deleting.

ROM — Read-only memory. Your system contains some programs essential to its operation in ROM code. A ROM chip retains its contents even after you turn off your system. Examples of code in ROM include the program that initiates your system's boot routine and the POST.

ROMB — RAID on motherboard.

SAN — Storage Area Network. A network architecture that enables remote network-attached storage devices to appear to a server to be locally attached.

SAS — Serial-attached SCSI.

SATA — Serial Advanced Technology Attachment. A standard interface between the system board and storage devices.

SCSI — Small computer system interface. An I/O bus interface with faster data transmission rates than standard ports.

SD card — Secure digital flash memory card.

SDRAM — Synchronous dynamic random-access memory.

sec — Second(s).

serial port — A legacy I/O port with a 9-pin connector that transfers data one bit at a time and is most often used to connect a modem to the system.

service tag — A bar code label on the system used to identify it when you call Bull for technical support.

SMART — Self-Monitoring Analysis and Reporting Technology. Allows hard drives to report errors and failures to the system BIOS and then display an error message on the screen.

SMP — Symmetric multiprocessing. Used to describe a system that has two or more processors connected via a high-bandwidth link and managed by an operating system, where each processor has equal access to I/O devices.

SNMP — Simple Network Management Protocol. A standard interface that allows a network manager to remotely monitor and manage workstations.

striping — Disk striping writes data across three or more disks in an array, but only uses a portion of the space on each disk. The amount of space used by a "stripe" is the same on each disk used. A virtual disk may use several stripes on the same set of disks in an array. See also *guarding*, *mirroring*, and *RAID*.

SVGA — Super video graphics array. VGA and SVGA are video standards for video adapters with greater resolution and color display capabilities than previous standards.

system board — As the main circuit board, the system board usually contains most of your system's integral components, such as the processor(s), RAM, controllers for peripherals, and various ROM chips.

system configuration information — Data stored in memory that tells a system what hardware is installed and how the system should be configured for operation.

system memory — See *RAM*.

System Setup program — A BIOS-based program that allows you to configure your system's hardware and customize the system's operation by setting features such as password protection. Because the System Setup program is stored in NVRAM, any settings remain in effect until you change them again.

TCP/IP — Transmission Control Protocol/Internet Protocol.

termination — Some devices (such as the last device at each end of a SCSI cable) must be terminated to prevent reflections and spurious signals in the cable. When such devices are connected in a series, you may need to enable or disable the termination on these devices by changing jumper or switch settings on the devices or by changing settings in the configuration software for the devices.

TOE — TCP/IP offload engine.

U-DIMM — An unregistered (unbuffered) DDR3 memory module.

uplink port — A port on a network hub or switch used to connect to other hubs or switches without requiring a crossover cable.

UPS — Uninterruptible power supply. A battery-powered unit that automatically supplies power to your system in the event of an electrical failure.

USB — Universal Serial Bus. A USB connector provides a single connection point for multiple USB-compliant devices, such as mice and keyboards. USB devices can be connected and disconnected while the system is running.

USB memory key — See *memory key*.

utility — A program used to manage system resources—memory, disk drives, or printers, for example.

V — Volt(s).

VAC — Volt(s) alternating current.

VDC — Volt(s) direct current.

VGA — Video graphics array. VGA and SVGA are video standards for video adapters with greater resolution and color display capabilities than previous standards.

video adapter — The logical circuitry that provides (in combination with the monitor) your system's video capabilities. A video adapter may be integrated into the system board or may be an expansion card that plugs into an expansion slot.

video memory — Most VGA and SVGA video adapters include memory chips in addition to your system's RAM. The amount of video memory installed primarily influences the number of colors that a program can display (with the appropriate video drivers and monitor capabilities).

video resolution — Video resolution (800 x 600, for example) is expressed as the number of pixels across by the number of pixels up and down. To display a program at a specific graphics resolution, you must install the appropriate video drivers and your monitor must support the resolution.

virtualization — The ability via software to share the resources of a single computer across multiple environments. A single physical system may appear to the user as multiple virtual systems able to host multiple operating systems.

W — Watt(s).

WH — Watt-hour(s).

XML — Extensible Markup Language. XML is a way to create common information formats and to share both the format and the data on the World Wide Web, intranets, and elsewhere.

ZIF — Zero insertion force.

Index

A

Advanced ECC memory
mode, 120

B

back-panel features, 15

batteries

troubleshooting, 152

battery

troubleshooting the RAID card
battery, 160

battery (system)

replacing, 131

bezel, 81

blank

hard drive, 84

power supply, 94

BMC

configuring, 76

Bull

contacting, 169

C

cabling

optical drive, 114

CD drive

troubleshooting, 157

CD/DVD drive

See optical drive.

connectors

system board, 172

USB, 8

video, 8

contacting Bull, 169

control panel assembly

features, 8

installing, 137

LCD panel features, 10

removing, 133

cooling fan

replacing, 114

cooling fans

troubleshooting, 154

cooling shroud

installing, 106

removing, 105

cover

closing, 83

opening, 82

D

damaged systems

troubleshooting, 151

diagnostics
using Online Diagnostics, 165

DIMMs
See memory modules (DIMMs).

drive blank
installing, 84
removing, 84

E

embedded system diagnostics
testing options, 166

Embedded System
Management, 75

error messages, 56

expansion card
troubleshooting, 161

expansion cards
installing, 97
removing, 99
SAS controller, 100

expansion slots, 96

F

front-panel features, 8

G

guidelines
connecting external devices, 17
expansion card installation, 96

memory installation, 119

H

hard drive
troubleshooting, 158

hard drives (cabled)
installing, 90
removing, 89

hard drives (hot-pluggable)
installing, 86
removing, 85

heat sink, 127

I

iDRAC card
installing, 107, 109
system port, 15

iDRAC Configuration Utility, 76

indicators
back-panel, 15
front-panel, 8
NIC, 17
power, 8, 18

installing
control panel assembly, 137
cooling shroud, 106
expansion card, 97
hard drive (cabled), 90
hard drive (hot-pluggable), 86
hard drive blank, 84
iDRAC card, 107, 109

- memory modules, 123
- optical drive, 114
- power supply blank, 94
- processor, 129
- SAS backplane board, 139
- SAS controller, 101

J

- jumpers (system board), 171

K

- keyboards
 - troubleshooting, 148

L

- LCD panel
 - features, 10
 - menus, 11

M

- memory
 - troubleshooting, 154
- Memory Mirroring memory mode, 120
- memory mode
 - Advanced ECC, 120
 - memory mirroring, 120
 - Optimizer, 121
- memory modules (DIMMs)

- configuring, 119
- installing, 123
- RDIMM configurations, 121
- removing, 125
- UDIMM configurations, 97

messages

- error messages, 56
- status LCD, 21
- system, 35
- warning, 52

microprocessor

- See* processor.

microprocessors

- troubleshooting, 162

N

NIC

- indicators, 17

NICs

- back-panel connectors, 15
- troubleshooting, 149

O

optical drive

- installing, 114

Optimizer memory mode, 121

P

password

- setup, 74

- system, 71
- passwords
 - disabling, 174
- POST
 - accessing system features, 7
- power indicators, 8, 18
- power supplies
 - indicators, 18
 - removing, 92, 94
 - replacing, 93, 96
- power supply blank, 94
- processor
 - installing, 129
 - removing, 126
 - upgrades, 126

R

- remote access controller
 - See* iDRAC.
- removing
 - bezel, 81
 - control panel assembly, 133
 - cooling shroud, 105
 - cover, 82
 - expansion card, 99
 - hard drive (cabled), 89
 - hard drive blank, 84
 - hard drives (hot-pluggable), 85
 - memory modules, 125
 - power supply, 92, 94
 - power supply blank, 94
 - processor, 126

- SAS backplane board, 137
- SAS controller, 100
- system board, 141

- replacing
 - cooling fan, 114
 - power supply, 93, 96
 - system battery, 131

S

- safety, 147
- SAS backplane board
 - installing, 139
 - removing, 137
- SAS controller card
 - installing, 101
 - removing, 100
- SAS controller daughter card
 - troubleshooting, 160
- SAS hard drive. *See* hard drive.
- SAS RAID controller daughter card
 - troubleshooting, 160
- SATA hard drive. *See* hard drive.
- SD card
 - troubleshooting, 156
- securing your system, 66, 72
- service-only procedure
 - system board, 141
- setup password, 74
- slots
 - See* expansion slots.

- startup
 - accessing system features, 7
- support
 - contacting Bull, 169
- system
 - closing, 83
 - opening, 82
- system board
 - connectors, 172
 - installing, 143
 - jumpers, 171
 - removing, 141
- system cooling
 - troubleshooting, 153
- system features
 - accessing, 7
- system messages, 35
- system password, 71
- system setup program
 - boot settings, 62
 - embedded server management options, 65
 - integrated devices options, 63
 - keystroke to enter, 56
 - memory settings, 60
 - PCI IRQ assignments, 64
 - power management options, 65
 - processor settings, 60
 - SATA settings, 61
 - serial communications options, 64
 - system security options, 66
- system setup screens
 - main, 57

T

- tape drive
 - troubleshooting, 157
- TPM security, 66
- troubleshooting
 - battery, 152
 - CD drive, 157
 - cooling fans, 154
 - damaged system, 151
 - expansion card, 161
 - external connections, 147
 - hard drive, 158
 - internal USB key, 156
 - keyboard, 148
 - memory, 154
 - microprocessors, 162
 - NIC, 149
 - SAS RAID controller daughter card, 160
 - SD card, 156
 - system cooling, 153
 - tape drive, 157
 - video, 148
 - wet system, 150

U

- UEFI Boot Manager
 - entering, 68
 - main screen, 70
 - System Utilities screen, 71
 - UEFI Boot Settings screen, 70
- Unified Server Configurator, 75
- upgrades

- processor, 126

USB

- front-panel connectors, 8

USB device

- back-panel connectors, 15

USB key

- troubleshooting, 156

USC, 75

V

video

- back-panel connector, 15

- front-panel connectors, 8

- troubleshooting, 148

W

- warning messages, 52

wet system

- troubleshooting, 150

BULL CEDOC
357 AVENUE PATTON
B.P.20845
49008 ANGERS CEDEX 01
FRANCE

REFERENCE
86 A1 62FD 00