



Customer Release Note - TS008.02

■ Number DEL000906

■ Version H



© Bull

The following copyright notice protects this book under Copyright laws which prohibit such actions as, but not limited to, copying, distributing, modifying, and making derivative works.

Copyright ©Bull SAS 2015

Printed in France

Trademarks and Acknowledgements

We acknowledge the right of proprietors of trademarks mentioned in this manual.

All brand names and software and hardware product names are subject to trademark and/or patent protection.

Quoting of brand and product names is for information purposes only and does not represent trademark and/or patent misuse.

Contents

1. Abstract and purpose of the release.....	5
2. Features.....	6
3. Release content.....	8
3.1. Documentation	8
3.2. Platform Firmware	8
3.3. Adapter Firmware.....	9
3.4. Customer Tools.....	9
3.5. Other Software and Firmware.....	9
4. New features and changes	10
5. Detailed Information.....	11
5.1. BIOS	11
5.2. EMM.....	11
5.3. VMware ESXi	12
5.4. Linux Red Hat.....	12
5.5. Windows Server	12
5.6. Supported Adapters.....	13
5.6.1. HGST PCIe Solid-State Accelerator	13
5.6.2. Intel Ethernet Server Adapters.....	13
5.6.3. LSI MegaRAID® SAS 9261-8i and 9361-4i.....	13
5.6.4. LSI SAS 9200-8e and 9300-8e	14
5.6.5. Emulex Adapters.....	14
6. Dependencies.....	15
6.1. Firmware	15
6.2. Linux Red Hat.....	15
7. Resolved issues	16
7.1. Memory blade green light on after OS shutdown (platform)	16
7.2. Erroneous Memory description using dmidecode (Red Hat)	16
7.3. Update of EMM firmware in power on state	16
7.4. LSI MegaRAID SAS 9261-8i not detected at reboot on bullion S2	16
7.5. SAN boot on LPe16002.....	16
7.6. PCI Hot Plug of Intel Ethernet Server I350-T2 and I350-T4 adapters.....	16
8. Recommendations	17
8.1. Setting BIOS boot time-out on bullion S16 servers	17
8.2. Power consumption optimization on bullion S2 servers (disabling BCS).....	18
8.3. Emulex LPe12002 card (VMware) support	19
8.3.1. Caution	19

8.3.2.	Upgrading LPe12002	19
8.4.	VMware installation	21
8.4.1.	Installing VMware from Bull Hypervisor 5 Installer-External USB Flash Drive	21
8.4.2.	Creating a bootable custom USB key from an ISO image of a supported OS	21
8.5.	kdump over NFS on bullion S8 Requirements (Red Hat)	22
8.6.	BIOS UEFI Mode.....	23
8.7.	Installation of native Windows on bullion S2	23
8.8.	Locating COA Windows labels.....	23
9.	Platform known restrictions, issues and workarounds	24
9.1.	Restrictions for PCI Hot Plug	24
9.2.	Restrictions on Memory Hot Add	24
9.3.	LSI MegaRAID 9261 card first configuration	25
9.4.	PCIe configuration upgrading on a bullion S16 server	25
9.5.	iSCSI Boot with Emulex OCe11102 card	25
9.6.	USB and on board 1Gb/s ports on slave modules	26
9.7.	Add Boot Option BIOS function fails	27
9.8.	Windows Device Manager reports QPI error.....	27
9.9.	Disabling BIOS VTD option not allowed on E7-XXXX V3 (Haswell).....	27
9.10.	(Bluescreen: DPC Watchdog violation).....	27
10.	Software known restrictions, issues and workarounds	28
10.1.	VMware Software	28
10.1.1.	Memory holes not supported by VMware 5.5	28
10.1.2.	vCenter system health (VMware).....	28
10.1.3.	1Gb Ethernet ports under ESXi	29
10.1.4.	SR IOV feature.....	29
10.1.5.	Emulex LPe15004 does not enable the link to Scan Devices in Device Manager	29
10.1.6.	ESXi detects LPe15004 as an LPe16000	30
10.1.7.	PCI bus addresses change when adding modules to a system	30
10.2.	Red Hat Software	30
10.2.1.	Red Hat specific	30
10.2.2.	DIMM location for correctable memory errors	30
10.2.3.	Emulex PCIe LPe12002 is not bootable.....	30
11.	History of previous releases.....	31
11.1.	TS007.03 (April 2015)	31
11.2.	TS006.04 (January 2015).....	31

1. Abstract and purpose of the release

This document is the customer release note for **Technical Status 008.02**.

It describes the objects delivered in the Technical Status, and the features of the resources provided on the Resource and Documentation DVDs.

2. Features

The Resources and Documentation DVDs provide the software, firmware and documentation required to install, configure, use and maintain the system:

Documentation:

Complete documentation included in a portfolio.

Firmware - Provided for the following components:

BIOSX	The CIX (system motherboard) BIOS image.
CPLD_MUCM	The flash image file for the CPLD component on the Ultra-Capacitors management board.
CPLD_M_CIX	The flash image file for the CPLD memory component on the CIX board (system motherboard).
CPLD_P_CIX	The flash image file for the CPLD Power component on the CIX board (system motherboard).
CPLD_PM1_CIX	The flash image file for the PM1CPLD component on the CIX board (system motherboard).
CPLD_PM2_CIX	The flash image file for the PM2CPLD component on the CIX board (system motherboard).
DS1600PED_PSU	The flash image file for the DPS1600PED component rated 1600W on the PSU board.
DS750PED_PSU	The flash image file for the DPS750PED component rated 750W on the PSU board.
EMM30_BMC	The software embedded in the server module to implement management functions accessible from the System Hardware Console (SHC) graphical interface.
ESXi_5	The VMware hypervisor.
FPGA_CIX	The firmware to be loaded on the CIX board (system motherboard) FPGA processors.
FPGA_WEO	The flash image file for 1Gb Ethernet switch component included in the connecting box.
LCP	The firmware for the Local Control Panel display.
PM_MUCM	The flash image file for Power Module (PM) component on the Ultra-Capacitor management board.
PM_RMxD3	The flash image file for PM component on the RMxD3 boards.
PM_RM3D4	The flash image file for PM component on the RM3D4 boards.
POWERVILLE_CIX	The flash image file for the integrated Ethernet controller on the CIX board (system motherboard).

Adapter Firmware and configuration files - Provided for the following cards:

Emulex PCIe LPe12002-M8
 Emulex PCIe LPe15004-M8
 Emulex PCIe LPe16002
 Emulex PCIe OCe11102-FM/NM/NT
 Emulex PCIe OCe14102-UM/NM
 Intel Ethernet Server I350-T2 and I350-T4
 HGST PCIe Solid-State Accelerator
 LSI MegaRAID SAS 9261-8i
 LSI MegaRAID SAS 9361-4i
 LSI SAS 9200-8e
 LSI SAS 9300-8e

Tools:

bmclanpet	The Platform Event Trap definition file. This MIB (Management Information Base) file is used by SNMP (Simple Network Management Protocol) managers to receive server hardware events.
BPM	A WEB application used to display server hardware status and information. It can also be used to get and set hardware configuration parameters. Both Linux and Windows versions are provided.
BSMHW_NG	A set of prompt commands, based on free IPMI open source, used to manage server or device hardware. These commands can be used to return information and status and/ or to remotely control and configure server hardware.
Bull_Admin_Tools_VM_Appliance	An appliance that delivers Bull Administration tools on a Virtual Machine running CentOS system.
iCare	A WEB application used for hardware maintenance. Both Linux and Windows versions are provided.
mc-setup	A Linux Utility used to discover the embedded management board's MAC address and to change the embedded management board's IP address.
psetup	A Windows Utility used to discover the embedded management board's MAC address and to change the embedded management board's IP-address.

3. Release content

This release provides the following items.

3.1. Documentation

Name	Version
bullion S Customer Documentation Portfolio	07

3.2. Platform Firmware

Name	Product Version	Build Number
BIOSX05 E7-XXX V2 (Ivybridge)	5.21.2	015
BIOSX08 E7_XXXX V3 (Haswell)	8.27.1	005
CPLD_MUCM	1.4	
CPLD_M_CIX	0.1.1	
CPLD_PM1_CIX	0.0.6	HS10
CPLD_PM2_CIX	0.0.6	HS10
CPLD_P_CIX	0.2.9	
DS1600PED_PSU	01.03/01.06	
DS750PED_PSU	01.15.00	
EMM30_BMC	30.20.00	1334
ESXi_5	5.5 update 2 Patch 4	2403361
	5.5 update 2 Patch 5	2718055
FPGA_CIX	0.3.6	
FPGA_WEO	0.2.3	HS11
LCP	20	
PM_MUCM	0.4	
PM_RMxD3	0.3	HS11
PM_RM3D4	001	
POWERVILLE_CIX	1.63	

3.3. Adapter Firmware

Name	Product Version	Build Number
Emulex PCIe LPe12002-M8	fw201a12 Universal boot version 513a10	
Emulex PCIe LPe15004-M8	10.4.255.23	
Emulex PCIe LPe16002	10.4.255.23	
Emulex PCIe OCe11102	10.4.255.25	
Emulex PCIe OCe14102	10.4.255.25	
Intel Ethernet Server I350-T2 and I350-T4	P20	
HGST PCIe Solid-State Accelerator	FW H0BV - Boot 2.6.28	
LSI MegaRAID SAS 9261-8i	12.15.0-0205	
LSI MegaRAID SAS 9361-4i	24.8.0-0020	
LSI SAS 9200-8e	P20	
LSI SAS 9300-8e	P8	

3.4. Customer Tools

Name	Product Version	Build Number
mc-setup	1.2.1	2
psetup	1.2.4	

3.5. Other Software and Firmware

Name	Product Version	Build Number
Bull_Admin_Tools_VM_Appliance	1.0.3	
bmclanpet_23	2.3-4	
BPM	2.5.1	
BSMHW_NG	1.2.8	
iCare	1.7.1	

4. New features and changes

TS008.02 (June 2015)

- Support for XEON E7-XXXX V3 (Haswell EX) in addition to E7-XXXX V2 (Ivybridge)
- Support for DDR4

See also section 7 *Resolved issues*.

5. Detailed Information

5.1. BIOS

Release identification

5.21.2 build 015 (BIOSX05.021.02.015)

This BIOS can be used for all operating systems (VMware ESXi included) and all server configurations (from bullion S2 to bullion S16) on E7 V2 processors.

Component versions

UEFI revision specification 2.3

Intel® Brickland-EX reference code 1.40

Microcodes:

- MED306E7_0000070D (Intel® Xeon® Processor E7 v2 Family D1 stepping)

Release identification

8.27.1 build 005 (BIOSX08.027.01.005)

This BIOS can be used for all operating systems (VMware ESXi included) and all server configurations (from bullion S2 to bullion S16) on E7 V3 processors.

Component versions

UEFI revision specification 2.3

Brickland® reference code 1.00 for Intel® Xeon® Processor E7 v3

Microcodes:

- M80306F4_00000005 (Intel® Xeon® Processor E7 v3 Family E0 stepping)
- M80306F3_00000008 (Intel® Xeon® Processor E7 v3 Family D0 stepping)

5.2. EMM

Release Identification

EMM bullion S 30.20.00 Build 1334

Note: EMM release identification is displayed in the following Hardware Console (SHC) page:

Maintenance → Hardware Information → Management Controller

Dependencies

BIOSX05.21.02 or higher and **BIOSX08.27.00** or higher

FPGA 0.3.6 or higher

Hardware supported

bullion S2, S4, S8, S16

5.3. VMware ESXi

Supported versions

ESXi 5.5

For certification details check <http://www.vmware.com/resources/compatibility>

Delivery

VMware ESXi is delivered on a bootable USB flash drive (ESXi installer).

For bullion S2 to S8 (IVB-EX) & S2 to S4 (HSW-EX): **ESXi 5.5U2P4 build 2403361**

For bullion S8 with more than 4TB & S8 (HSW-EX): **ESXi 5.5U2P5 build 2718055**

Additional and updated components

Name	Version	Vendor	Acceptance Level
elxnet	10.2.445.0-1OEM.550.0.0.1331820	Emulex	VMwareCertified
emulex-cim-provider	10.2.348.18-01OEM.550.0.0.1331820	Emulex	VMwareAccepted
lpfc	10.2.455.0-1OEM.550.0.0.1331820	Emulex	VMwareCertified
net-igb	5.2.7-1OEM.550.0.0.1331820	Intel	VMwareCertified
net-ixgbe	3.21.4-1OEM.550.0.0.1331820	Intel	VMwareCertified
lsiprovider	500.04.V0.53-0003	LSI	VMwareAccepted
scsi-stec-s1120	2.2.1.0202-1OEM.550.0.0.1331820	Stec (HGST)	VMwareCertified
scsi-megaraid-sas	6.606.06.00-1OEM.550.0.0.1331820	LSI	VMwareCertified

Emulex CIM Provider is required by the Emulex One Command Manager vCenter plugin, which allows you to update most Emulex firmware on the fly.

LSI CIM provider is needed to remotely manage LSI boards via MegaRAID Storage Manager software.

5.4. Linux Red Hat

Supported version

Red Hat Enterprise Linux Server 6.5 and 6.6.

5.5. Windows Server

Supported version

Windows Server 2012 R2 on bullion S2 and S4

5.6. Supported Adapters

bullion S supports the following adapters.

5.6.1. HGST PCIe Solid-State Accelerator

1TB PCIe HH-HL Solution

For more information, see <http://www.hgst.com>

5.6.2. Intel Ethernet Server Adapters

Intel® Ethernet Server Adapter I350-T2
Dual ports - PCIe v2.1 (5.0GT/s) Interface

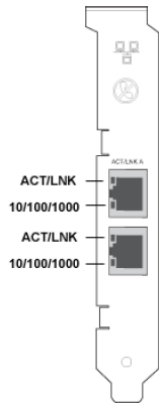

Intel® Ethernet Server Adapter I350-T4
Quad ports - PCIe v2.1 (5.0GT/s) Interface

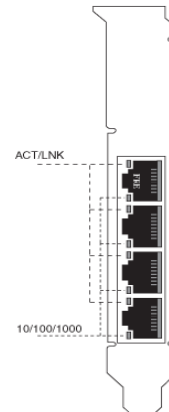

The port numbers depend on OS and drivers. To know the port numbers, you can either unplug cable and check the port status on the console, or set a port to disable and check the LED colors.

For more information, see <http://ark.intel.com>

5.6.3. LSI MegaRAID® SAS 9261-8i and 9361-4i

Eight-Port 6Gb/s PCI Express SATA+SAS RAID Controller

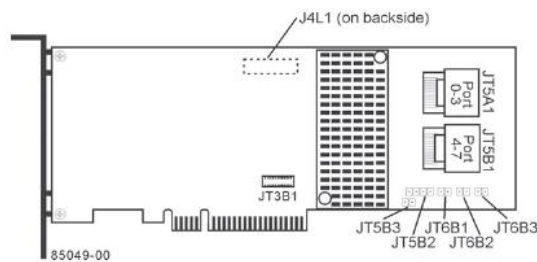

Four Port MegaRAID SAS 9361-4i 12Gb/s SAS and SATA RAID Controller



No external connector.

For more information, see <http://www.lsi.com>

5.6.4. LSI SAS 9200-8e and 9300-8e

LSI SAS 9200-8e
8-Port, 6Gb/s SAS+SATA to PCI Exp HBA

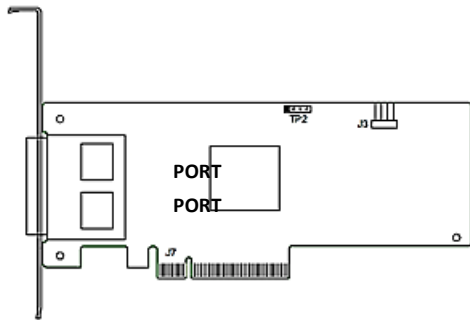

LSI SAS 9300-8e
8-Port 12Gb/s SAS+SATA to PCI Exp HBA

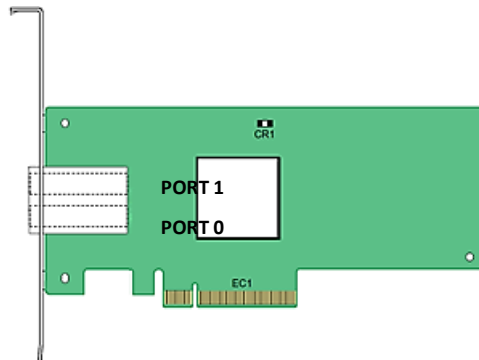

For more information, see <http://www.lsi.com>

5.6.5. Emulex Adapters

Emulex OneConnect®
OCe11102-FM, OCe11102-NM, OCe11102-NT
dual-port 10Gb Ethernet (10GbE) Adapter

Emulex LightPulse LPe16002B
Gen 5 Fibre Channel PCIe 3.0 Dual-Port HBA

Emulex OneConnect®
OCe14102-UM, OCe14102-NM
dual-port 10Gb Ethernet (10GbE) Adapter

Emulex LightPulse LPe12002
dual-channel Fibre Channel HBA

Emulex LightPulse LPe15004
Advanced-8 8Gb FC (8GFC), quad-port,
low-profile HBA



POR
PORT 1
POR
T 2
POR
T 3

For more information, see www.emulex.com

6. Dependencies

6.1. Firmware

All firmware versions included in a Technical State are compatible with each other. You should not install a firmware image independently of the rest of the technical set without consulting your Customer Service Representative.

6.2. Linux Red Hat

The following prerequisites must be met in order to install RHEL 6.5 or 6.6 on a bullion S:

- a PC with a Web browser and Java installed
- 25 GBs minimum disk storage space available from the server

Note: If the server is equipped with a hardware RAID and/or a Fiber Channel controller, storage has to be visible from the controller's BIOS

- 4 GBs minimum RAM available on the server.

7. Resolved issues

7.1. Memory blade green light on after OS shutdown (platform)

After an OS shutdown, the green light on memory blade switches off.

7.2. Erroneous Memory description using dmidecode (Red Hat)

The memory description in **smbios** table (using **dmidecode** tool) is now correct for empty slots.

7.3. Update of EMM firmware in power on state

Update of the EMM firmware is now currently supported on power on state.

7.4. LSI MegaRAID SAS 9261-8i not detected at reboot on bullion S2

LSI MegaRAID SAS 9261-8i adapters are now detected at reboot on bullion S2.

7.5. SAN boot on LPe16002

It is now possible to configure a boot LUN from a SAN using the LPe16002 adapter.

7.6. PCI Hot Plug of Intel Ethernet Server I350-T2 and I350-T4 adapters

Hot Plug of Intel Ethernet Server I350-T2 and I350-T4 adapters is now supported under Red Hat 6.6.

8. Recommendations

8.1. Setting BIOS boot time-out on bullion S16 servers

The time-out value must be set to **30 min** to prevent problems.

On LINUX systems

1. To display the current value:

```
/opt/BSMHW_NG/sbin/ipmi-raw_bull -D lan -h [IP] -u super -p pass 0 0x3A 0x19 0x00 0x05
```

Output:

```
00 00 xx yy
```

Current value (24 min): xx=C0 yy=0x12

2. To change the current value to 30 min:

```
/opt/BSMHW_NG/sbin/ipmi-raw_bull -D lan -h [IP] -u super -p pass 0 0x3A 0x18 0x00 0x05 0x00 0x00 0x70 0x17
```

New value (30 min): xx=0x70 yy=0x17

On windows system

1. To display the current value:

```
C:\Windows\system32>cd %BSMHW_NG_HOME%/engine/bin
```

```
C:\BSM\BSMHW_NG\engine\bin>bash --login -i
```

```
a455979@B017814 ~
```

```
$ cd /bin
```

```
../sbin/ipmi-raw_bull -D lan -h [IP] -u super -p pass 0 0x3A 0x19 0x00 0x05
```

Output:

```
00 00 xx yy
```

Current value (24 min): xx=C0 yy=0x12

2. To change the current value to 30 min:

```
C:\Windows\system32>cd %BSMHW_NG_HOME%/engine/bin
```

```
C:\BSM\BSMHW_NG\engine\bin>bash --login -i
```

```
a455979@B017814 ~
```

```
$ cd /bin
```

```
../sbin/ipmi-raw_bull -D lan -h [IP] -u super -p pass 0 0x3A 0x18 0x00 0x05 0x00 0x00 0x70 0x17
```

New value (30 min): xx=0x70 yy=0x17

8.2. Power consumption optimization on bullion S2 servers (disabling BCS)

To optimize power consumption on bullion S2 servers, it is recommended to disable the node controller (**BCS**) access using the bsmGetConfParam CLI command:

1. To get the current value:

```
cd /bin
```

```
./bsmGetConfParam.sh -H <host> -u <user> -p <password> -a getDisableBCS
```

BCS disabling value is 'no'.

2. To change the current value:

```
cd /bin
```

```
./bsmSetConfParam.sh -H <host> -u <user> -p <password> -a setDisableBCS -  
x <yes|no>
```



WARNING

If the module is added later to a partition, BCS access must be re-enabled.

8.3. Emulex LPe12002 card (VMware) support

8.3.1. Caution

The Emulex LPe12002 card under VMware requires the firmware version listed in Section 3.3.

The server is delivered with this version.

8.3.2. Upgrading LPe12002

To upgrade the Emulex LPe12002 card:

1. Set the BIOS mode to **Legacy**
2. Get the **Lpe12002-v2.ima** file (if needed contact your Support Representative)
3. Connect to the remote console to connect a virtual drive
4. For virtual drive 1, select image file, browse to **Lpe12002-v2.ima**, and then click **Connect**.

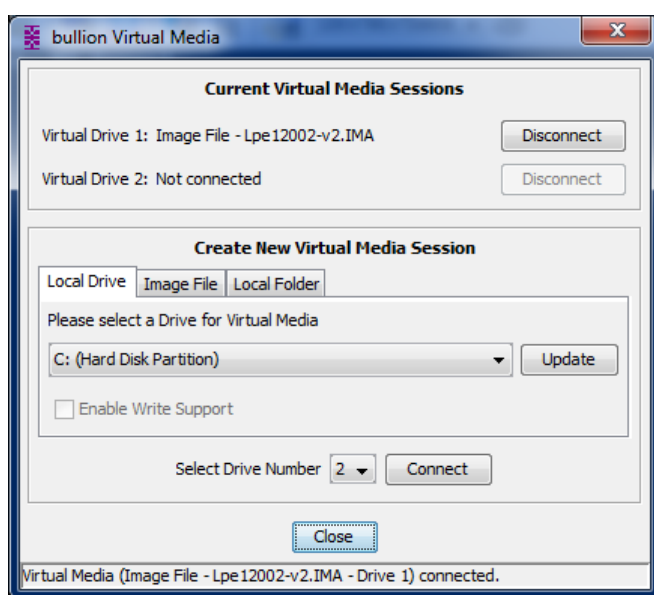

1. Power on the server, then press ESC to enter the BIOS menu.
2. In the BIOS Boot Manager, select **Raritan** as Boot Device.
3. On the **FreeDOS** starting list, select 5.

Listing Emulex hba

From the FreeDOS prompt, enter:

doslpcfg listhba

```
A:\>doslpcfg listhba
Command: LISTHBA
adapter 1: 10000090 FA0B9936 Functional FW: US2.01A11 LPe12002-M8
adapter 2: 10000090 FA0B9937 Functional FW: US2.01A11 LPe12002-M8
adapter 3: 10000000 C987BED8 Functional FW: US2.01A11 LPe12002-M8
adapter 4: 10000000 C987BED9 Functional FW: US2.01A12 LPe12002-M8
adapter 5: 10000000 C9B7981A Functional FW: US2.01A11 LPe12002-M8
adapter 6: 10000000 C9B7981B Functional FW: US2.01A11 LPe12002-M8
adapter 7: 10000000 C9873154 Functional FW: US2.01A12 LPe12002-M8
adapter 8: 10000000 C9873155 Functional FW: US2.01A12 LPe12002-M8
Command completed, NO Error!
```

Updating the Bootcode

1. To update the HBA bootcode, enter:

doslpcfg download i=uu513a3.prg n=<HBA number>

```
A:\>doslpcfg download i=uu513a3.prg n=1_
Opening File
...
File Extension .prg
Reading Header
...
Validating Checksum
...
Restarting board via Warmstart => SLI1
...
Erasing Sector(s) In Flash ROM
...
...
Loading Image
...
4% complete
```

2. Repeat this operation for each LPe12002 HBA

Updating the firmware

1. To update the HBA firmware, enter:

doslpcfg download i=ud201a12.all n=<HBA number>

```
A:\>doslpcfg download i=ud201a12.all n=1
File Extension .all
Opening File...
Validte file type
UPD Style OK T2:78,T3:79,7A,7B,7D,7E,7F,T7:73,TB:73,TFF:78 ff 78
Validte file type
DWC imageID 73
UPD Style OK T2:78,T3:79,7A,7B,7D,7E,7F,T7:73,TB:73,TFF:78 ? 73
End Of File
Checksum OK!!!
Reading AIF Header #1...
ImageBase 0 Len 1d888
Download AWC image for adapter f100
Validating Checksum...
```

2. Repeat this operation for each LPe12002 HBA.
3. Restart the server and set the BIOS to **UEFI** mode.

8.4. VMware installation

8.4.1. Installing VMware from Bull Hypervisor 5 Installer-External USB Flash Drive

Note: the USB flash drive used for this procedure must have been generated as described in section 8.4.2. This is the case for the USB flash drive delivered with your system.

Procedure

1. Plug the USB flash drive in the bullion S front panel USB port.
2. Boot the bullion S and press to ESC key to enter the Boot Manager menu. Select the USB device.
3. Install ESXi 5.5 U1 or U2 on your target media (SAN disks for example).
4. Boot your ESXi disk when requested.

8.4.2. Creating a bootable custom USB key from an ISO image of a supported OS

Pre-Requisites

- ISO image of a supported OS
- The **Rufus** software downloaded from: <http://rufus.akeo.ie/>
- 1GB or higher USB key.

Procedure

1. Run **Rufus software**.
2. Select your USB device and the ESXi .iso image.
3. Select **MBR partition scheme for BIOS or UEFI computers** as a partition scheme.
CAUTION: be sure to select the right partition scheme as it is not the default one.
4. Create the USB key.
5. Accept the update **menu.c32** file version.
6. Once finished, plug the USB key in the server front panel USB port.

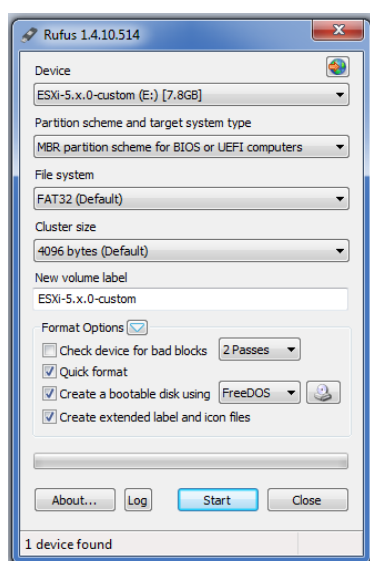

7. Install the OS on your target media (SAN disks for example).
8. Boot your OS disk.

8.5. kdump over NFS on bullion S8 Requirements (Red Hat)

It is highly recommended to run the following operations to ensure that **kdump over NFS** works properly on a bullion S8 running RHEL 6.5 or 6.6:

1. Check that the following updates have been applied to the RHEL 6.5 or 6.6 operating systems:

kexec-tools-2.0.0-273.el6_5.1.x86_64.rpm

kexec-tools-debuginfo-2.0.0-273.el6_5.1.x86_64.rpm

kernel-2.6.32-431.37.1.el6.x86_64.rpm

kernel-abi-whitelists-2.6.32-431.37.1.el6.noarch.rpm

kernel-debug-2.6.32-431.37.1.el6.x86_64.rpm

kernel-debug-debuginfo-2.6.32-431.37.1.el6.x86_64.rpm

kernel-debug-devel-2.6.32-431.37.1.el6.x86_64.rpm

kernel-debuginfo-2.6.32-431.37.1.el6.x86_64.rpm

kernel-debuginfo-common-x86_64-2.6.32-431.37.1.el6.x86_64.rpm

kernel-devel-2.6.32-431.37.1.el6.x86_64.rpm

kernel-doc-2.6.32-431.37.1.el6.noarch.rpm

kernel-firmware-2.6.32-431.37.1.el6.noarch.rpm

kernel-headers-2.6.32-431.37.1.el6.x86_64.rpm

perf-2.6.32-431.37.1.el6.x86_64.rpm

perf-debuginfo-2.6.32-431.37.1.el6.x86_64.rpm

python-perf-2.6.32-431.37.1.el6.x86_64.rpm

python-perf-debuginfo-2.6.32-431.37.1.el6.x86_64.rpm

2. Edit the `/etc/sysconfig/kdump` file, and change the **KDUMP_COMMANDLINE_APPEND=** line, as follows:

- Change **nr_cpus=1** to **nr_cpus=4**

- Add: **disable_cpu_apicid=0**

3. Restart the kdump service:

service kdump restart

8.6. BIOS UEFI Mode

The BIOS must always be configured in **UEFI** mode (default mode).

The **legacy** mode should only be used to work around specific configuration issues described in this Release Note.

8.7. Installation of native Windows on bullion S2

To install native Windows on a bullion S2 server, set the **enable_full_power_cycle** key to **yes**:

```
ipmitool -I lan -H [IP] -U super -P pass bulloem setcfg bmc.power.enable_full_power_cycle yes
```

8.8. Locating COA Windows labels

The identification labels are located at the rear of the server drawers in a little drawer (A).

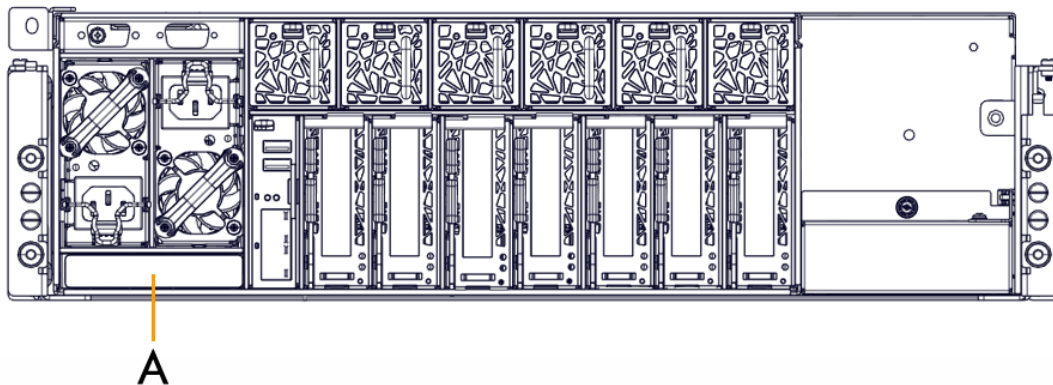

Press on the little drawer to open it and check the labels.



9. Platform known restrictions, issues and workarounds

9.1. Restrictions for PCI Hot Plug

- Hot Plug of Emulex PCIe LPe16002 and Emulex PCIe OCe11102 is not supported under Windows 2012 R2.
- PCI Hot Plug is not supported under ESXi.
- Under Windows 2012 R2 or Red Hat 6.5/6.6, if the number LPe Fibre Channel PCIe boards plus the number OCE network controller PCIe boards exceeds 8, then **IO Resource Denial** should be enabled for the slots containing those board types. Refer to the *bullion S Configuration Guide*, Ref. 86 A1 46FL for more information about this option.

Refer to *Upgrade Guidelines*, 86 A1 35FP, in the *bullion S Customer Documentation Portfolio* for more information about hot plugging PCI adapters.

9.2. Restrictions on Memory Hot Add

- Memory Hot Add is only allowed on memory blade slots 2 and 6 under Red Hat. This is due to operating system limitations:
 - Memory Hot Add does not work on bullion S2 under Red Hat, due to Red Hat limitations.
 - Memory Hot Add is not supported under ESXi.
- Memory Hot Add is not currently supported on servers equipped with E7-XXXX V3 (Haswell HSW-EX) processor.

Refer to the *Upgrade Guidelines*, 86 A1 35FP, in the *bullion S Customer Documentation Portfolio* for more information about hot adding memory.

9.3. LSI MegaRAID 9261 card first configuration

Issue

Legacy mode (not UEFI) must be used the first time the LSI MegaRAID 9261 card is configured.

Workaround

1. Boot the server to BIOS “**Setup Utility**”, by pressing the ESC key or using the bsmBootDevice CLI command:
 - From a Linux console:

```
/opt/BSMHW_NG/bin/bsmBootDevice.sh -H <host> -u <user> -p <password> -d bios
```
 - From a Windows console:

Launch Cygwin:
bash login -i
 Enter:
cd /bin
bsmBootDevice.sh -H <host> -u <user> -p <password> -d bios
2. From the **Boot** menu, select **Legacy Boot Type** as a boot type. Save by pressing F10 and reboot the system in Legacy mode.



3. Reconfigure or rebuild the RAID disks using the LSI utility
4. When the installation is finished and the system reboots, enter the BIOS **Setup Utility**, and from the **Boot** menu select **UEFI Boot Type**. Save by pressing F10 and reboot the system in UEFI mode.

9.4. PCIe configuration upgrading on a bullion S16 server

If you need to upgrade a bullion S16 server with PCI-e cards, please contact your Bull representative.

9.5. iSCSI Boot with Emulex OCe11102 card

Restriction

iSCSI boot using the OCe11102 card is not supported.

In iSCSI, boot is to be performed on a bullion S hard disk. Emulex OCe11102 cards are used for data only.

9.6. USB and on board 1Gb/s ports on slave modules

Issue

The USB port and on board 1Gb/s Ethernet controller (powerville) are disabled on all slave modules of a partition.

Workaround

Use USB port and on board 1GB/s Ethernet ports in master module only.

9.7. Add Boot Option BIOS function fails

Issue

The “**Boot From File > Add Boot Option**” BIOS function does not work (final save fails).

As a consequence it is not possible to change the name of a boot instance in the BIOS menu. For example, if several instances of the same boot device are installed, the BIOS will show them with the same name.

Workaround

None. This is not a blocking problem.

9.8. Windows Device Manager reports QPI error

Issue

Windows Server 2012R2 Device manager report QPI errors while the BMC and SOL log show the QPI is OK.

Workaround

Update intel chipset driver firmware to the latest revision 9.4.2.1020

9.9. Disabling BIOS VTD option not allowed on E7-XXXX V3 (Haswell)

Issue

It is not allowed to deactivate the BIOS VTD option on servers equipped with E7-XXXX V3 (Haswell) processors.

9.10. (Bluescreen: DPC Watchdog violation)

Issue

Windows Servers 2012 R2 not booting (Bluescreen: DPC Watchdog violation) with Intel Xeon E7 v3 when an Intel i350 Gbe is connected to the system (either the integrated one or the external PCIe card version).

Workaround

Update your Intel i350 GbE controller's drivers to the latest 12.11.97.1 version.

10. Software known restrictions, issues and workarounds

10.1. VMware Software

10.1.1. *Memory holes not supported by VMware 5.5*

Issue

VMware 5.5 may generate illegal memory access when memory gaps exist between modules in a multi module server, leading the server to crash.

This problem has been fixed in ESXi version 5.5 update 2 patch 4 (build 2403361 and later), which comes with the server.

Workaround for older ESXi release

If you use an ESXi version prior to build 2403361, you must set the following SHC key:

```
bmc.BIOS_no_memory_hole    yes
```

10.1.2. *vCenter system health (VMware)*

Issue

The system health sensors are not available under vCenter (temperatures, fan sensors, server consumption, etc) on bullion S8 servers.

Workaround

This information is still available through SHC interface.

10.1.3. 1Gb Ethernet ports under ESXi

VMware constraints

VMware ESXi 5.5 U1 and U2 support up to 16x 1Gb/s ports or up to 4 x 1Gb/s and up to 8 x 10Gb/s ports.

According to the number of authorized 1Gb/s Ethernet cards (Intel I350-T2 or I350-T4) in the configuration, the on-board 1Gb/s (powerville) ports may have to be disabled to comply with VMware limits.

Disabling on-board 1Gb/s if needed

The server is delivered with on-board 1Gb/s ports enabled or disabled, depending on the configuration and VMWare constraints.

If a new 1Gb/s PCI-e is installed as an add-on, the on-board 1Gb/s ports may need to be disabled.

1. Boot the server to the BIOS "Setup Utility", by pressing ESC key or using the `bsmBootDevice` command:
 - From a Linux console:

```
/opt/BSMHW_NG/bin/bsmBootDevice.sh -H <host> -u <user> -p <password> -d bios
```
 - From a Windows console:
Launch Cygwin: **bash login -i**
Enter:
cd /bin
bsmBootDevice.sh -H <host> -u <user> -p <password> -d bios
2. From the **Advanced** section, select **Chipset Configuration>PCI Express Configuration>PCI Express root port 1 > Disable**.
3. Save by pressing F10 and reboot the system. Both the 1GbE controller ports are no longer listed in the BIOS (PXE boot ports) or OS.

10.1.4. SR IOV feature

SR IOV feature is not supported with Intel Ethernet Server I350-T2 and I350-T4 adapters.

10.1.5. Emulex LPe15004 does not enable the link to Scan Devices in Device Manager

Issue

When trying to configure LPe15004 to boot from SAN via the Device Manager, the LPe15004 ports may not enable the link to Scan Devices.

Workaround

In Device Manager, go to the LPe15004 port and select **Configure HBA and Boot Parameters**. Then toggle **Topology Selection** to **AUTO Loop First - default**.

Select **Commit Changes**.

The Scan Devices now enables the link and finds the device.

10.1.6. *ESXi detects LPe15004 as an LPe16000*

Note

VMware ESXi5.5 detects LPe15004 as LPe16000.

10.1.7. *PCI bus addresses change when adding modules to a system*

Issue

When switching between a 2 module system and a 4 module system, even though no PCI boards have been moved, the PCI location changes.

This means that for a Virtual Machine that is configured with a SRIOV VF (virtual function), will have to be manually reconfigured by an administrator in order for the PCI Device to be functional.

10.2. Red Hat Software

10.2.1. *Red Hat specific*

Issue

There may be some known issues for Red Hat 6.5 or 6.6.

Workaround

In case of a problem with the Red Hat Operating System, please see the Red Hat customer portal using your Red Hat account.

10.2.2. *DIMM location for correctable memory errors*

Issue

In the case of a correctable error, the information in the MCE log leads to the channel only, not to the DIMM.

Note:

if a RAS feature is triggered (e.g. DDDC, rank sparing, etc), or if the number of corrected errors exceeds the threshold (leaky bucket), then a SEL event is issued.

This event points to the DIMM.

10.2.3. *Emulex PCIe LPe12002 is not bootable*

Restriction

Emulex PCIe LPe12002 is not bootable on Red Hat.

11. History of previous releases

11.1. TS007.03 (April 2015)

New Features

- Emulex OCe 14102 adapter support
- LSI SAS 9300-8e adapter support
- Use of fine grain time synchronization between modules (TSC)
- Management of error LEDs in memory blades to help locate a the faulty DIMM
- Support of active/passive PSU using the UCM module
- Red Hat 6.6 support
- Windows Server 2012 R2 support on bullion S2 and S4
- Improved error reporting in the SEL (e.g. lack of PCI resources, XQPI errors leading to reduced speed)

Resolved issues

- The following misleading message is no longer displayed in the BIOS trace at boot time:
BMC Message BIOS Setup parameters are successfully deleted
- FPGA programming file is optimized to complete the firmware faster. So, the Server Hardware Console no longer displays time-out message.

11.2. TS006.04 (January 2015)

New Features

- PCIe hot plug (Red Hat 6.5 only as of today)
- Memory hot add (Red Hat 6.5 only as of today)
- Emulex PCIe LPe15004-M8 adapter support
- LSI MegaRAID SAS 9361-4i adapter support
- New disks support:
 - 300GB 2,5" 15Krpm SAS HDD Blade
 - 1.2TB 2,5" 10Krpm SAS HDD Blade
 - 1TB 2,5" 7.2Krpm SATA HDD Blade
 - 256GB 2,5" SATA SSD Blade
 - 512GB 2,5" SATA SSD Blade
 - 600GB 2,5" 15Krpm SAS HDD Blade
- UCM (Ultra Capacitor Module) support and associated BSM CLI commands.

- Memory sparing, scrubbing, device tagging, DDDC (Double Device Data Correction)
- BPM / BSM CLI for enabling/disabling the BCS2 (Bull Coherent Switch)
 - BIOS setting update from EMM (Embedded Management Module)
- Inventory: PCIe board information (VID, DID, SSVID) included
- bullion S8 can be partitioned as 6 socket system + 2 socket system
- bullion S8 with 6 sockets (3 modules) can be upgraded with a 2 socket module, so becoming a full 8 socket system.
- Improved stress diag suite
- UCM firmware upgrade
- PSU firmware upgrade

Resolved issues

- SR IOV feature (VMware) is supported with Emulex OneConnect OCe adapters.
- BIOS settings change is operational on all bullion S server range.
- DHCP configuration (platform)
 - After breaker off, the BMC DHCP connection remains available.
- BIOS settings after BIOS upgrade (platform)
 - The BIOS settings are no longer revert to their default value after a BIOS upgrade. Changed values are preserved.
- FCoE boot through the OCe11102 card is now supported.

End of document