

EVIDEN

BullSequana EXD

Description Guide

The following copyright notice protects this book under Copyright laws which prohibit such actions as, but not limited to, copying, distributing, modifying, and making derivative works.

Copyright ©Bull SAS 2024, part of Eviden group. Eviden is a registered trademark of Eviden SAS. This document, or any part of it, may not be reproduced, copied, circulated and/or distributed nor quoted without prior written approval from Bull SAS.

Trademarks and Acknowledgements

We acknowledge the right of proprietors of trademarks mentioned in this manual.

All brand names and software and hardware product names are subject to trademark and/or patent protection.

Quoting of brand and product names is for information purposes only and does not represent trademark and/or patent misuse.

Hardware

April 2024

**Eviden
30 bis rue du Nid de Pie
49000 Angers
FRANCE**

The information in this document is subject to change without notice. Eviden will not be liable for errors contained herein, or for incidental or consequential damages in connection with the use of this material.

Table of Contents

Table of Contents	i
Preface	p-1
Intended Readers	p-1
Regulatory declarations and disclaimers	p-2
Safety compliance statement	p-2
European Union (EU)	p-2
UL/CSA certification	p-2
Electromagnetic compatibility statement	p-2
European Union (EU)	p-2
Federal Communications Commission (FCC) compliance (USA)	p-2
ICES-003 compliance (Canada)	p-3
Waste management	p-3
REACH	p-3
ROHS	p-3
WEEE	p-3
Safety Notices	p-4
Chapter 1. Related publications	1-1
Chapter 2. BullSequana EXD description	2-1
2.1. Overview	2-1
2.2. Front view	2-2
2.3. Rear components	2-3
2.4. Top level components	2-4
2.4.1. Top view with air duct	2-4
2.4.2. Top view without air duct	2-5
2.5. Memory modules	2-6
2.6. M.2 NVMe disks	2-7
2.7. M.2 riser board	2-8
2.8. Fans	2-10
2.9. Optional mezzanine	2-11
Chapter 3. Buttons, ports and LEDs	3-1
3.1. Front buttons, ports and LEDs	3-1
3.1.1. Buttons	3-1
3.1.2. LEDs	3-1
3.2. Rear buttons, ports and LEDs	3-2
3.2.1. Buttons	3-2
3.2.2. Ports	3-3

3.2.3. LEDs	3-4
Appendix A. Technical description	A-1
A.1. General technical specifications	A-1
A.2. Dimensions and weight	A-2
A.3. Module technical specifications	A-3
A.4. Server technical description	A-4
A.5. Antenna specifications	A-5
A.5.1. Dual-band WiFi	A-5
A.5.2. LoraWAN	A-6
A.5.3. LTE / 5G	A-7
Acronyms	a-1

Preface

This guide provides a general overview of the server.

See The Bull support web site for the most up-to-date product information, documentation, firmware updates, software fixes and service offers:
<https://support.bull.com>

Intended Readers

This guide is intended for use by system administrators and operators.

Regulatory declarations and disclaimers

Safety compliance statement

This product is in compliance with the following:

European Union (EU)

Low voltage directive 2014/35/EU: standard EN 62368-1

UL/CSA certification

UL 62368 (USA)

CSA 62368 (Canada)

Electromagnetic compatibility statement

This product is in compliance with the protection requirements of the following:

European Union (EU)

EMC directive 2014/30/EU : standards EN 55032, EN 55035, EN 61000-3-2, EN 61000-3-3

Federal Communications Commission (FCC) compliance (USA)

CFR 47, FCC Part 15 B

FCC declaration of conformity

This device complies with Part 15 of the FCC Rules. Operation is subject to the following two conditions: (1) this device may not cause harmful interference, and (2) this device must accept any interference received, including interference that may cause undesired operation.

FCC statement

This equipment has been tested and found to comply with the limits for a Class A digital device, pursuant to Part 15 of the FCC Rules. These limits are designed to provide reasonable protection against harmful interference when the equipment is operated in a commercial environment. This equipment generates, uses, and can radiate radio frequency energy and, if not installed and used in accordance with the instruction manual, may cause harmful interference to radio communications. Operation of this equipment in a residential area is likely to cause harmful interference in which case the user will be required to correct the interference at his own expense.

Properly shielded and grounded cables and connectors must be used in order to meet FCC emission limits. Neither the provider nor the manufacturer are responsible for any radio or television interference caused by using other than recommended cables and connectors or by unauthorized changes or modifications to this equipment. Unauthorized changes or modifications could void the user's authority to operate the equipment.

Pursuant to Part 15.21 of the FCC Rules, any changes or modifications to this equipment not expressly approved by the manufacturer may cause harmful interference and void the FCC authorization to operate this equipment. An FCC regulatory label is affixed to the equipment.

ICES-003 compliance (Canada)

Canadian Compliance Statement (Industry Canada)

This Class A digital apparatus meets all requirements of the Canadian Interference Causing Equipment Regulations.

This product is in conformity with the protection requirements of the ICES-003 standard.

Waste management

This product has been built to comply with the following:

REACH

Regulation (EC) N°1907/2006 of the European Parliament and the 18/12/2006 REACH Council

ROHS

2011/65/EU, complemented by the delegated directive 2015/863/UE

WEEE

2012/19/EU

Safety Notices

Important **Read the safety notices before undertaking any procedures described in the documentation.**

All safety notices used in the documentation are listed in the Multilingual Safety Notices Guide, 86 X1 12FL and are classified by severity:



DANGER D000

A Danger notice indicates the presence of a hazard that has the potential of causing death or serious personal injury.



CAUTION C000

A Caution notice indicates the presence of a hazard that has the potential of causing moderate or minor personal injury.



WARNING W000

A Warning notice indicates an action that could cause damage to a program, device, system, or data.

Each safety notices is prefixed with a unique identification number. This can be used to locate the corresponding translated version in the Multilingual Safety Notices Guide, 86 X1 12FL.

Chapter 1. Related publications

This list is not exhaustive. Useful documentation is supplied on the Resource and Documentation ISO file delivered with the system. It is strongly advised to refer carefully to this documentation before proceeding to configure, use, maintain, or update the system.

Documentation Sets

- BullSequana EXCustomer Documentation Set, 86 XP 74PA
This documentation set contains all the customer documentation relative to the server.
- BullSequana EXField Documentation Set, 86 XP 75PA
This documentation set contains all the field documentation relative to the server.

Read me First

- Resource and Documentation ISO file
This ISO file contains the tools and documentation required to configure, operate and maintain the system.
- BullSequana ServersSite Preparation Guide, 86 A1 85FP
This guide explains how to prepare a data processing center for servers, in compliance with the standards in force. This guide is intended for use by all personnel and trade representatives involved in the site preparation process.
- BullSequana ServersSafety Notices Guide, 86 X1 12FL
This guide lists, in different languages, the notices referenced in the documentation procedures.
- BullSequana EXD Description Guide, 86 A1 88FS
This guide provides a general overview of the server. This guide is intended for use by system administrators and operators.

Installation

BullSequana EXD Installation Guide, 86 A1 99FS

This guide explains how to install the server for the first time. This guide is intended for use by instructed or skilled personnel in charge of installing the server.

Operation

- BullSequana EX Server Hardware Console (SHC), 86 A1 26FT
This guide explains how to use the SHC to manage the server. This guide is intended for use by system administrators and operators.

- BullSequana EX Getting Started Guide, 86 A1 31FT
This guide explains how to set up the server. This guide is intended for use by system administrators and operators.

Maintenance

BullSequana EX Redfish Events Messages, 86 A1 35FT

This guide lists the messages issued by the server and provides associated actions and information to troubleshoot. This guide is intended for use by system administrators and operators.

Chapter 2. BullSequana EXD description

2.1. Overview

BullSequana EX servers exploit the Intel® Xeon® platform, Sapphire Rapids processor. Each BullSequana EX includes one processor that can support up to eight DDR5 memory modules.

Each BullSequana EXD module is 2U high.

Up to 8x M.2 NVMe disks are available for storage

In addition two M.2 cards are supported on an internal riser for boot disk, accelerator cards and WIFI communication card options.

A PCIe module supports one double or two single width PCIe cards, including GPU accelerators.

Four wireless technologies are supported:

- 2.4 GHz - 5.9 GHz dual-band WiFi (Dual-band WiFi)
- Bluetooth
- Long Term Evolution 5G Global System for Mobile Communications
- LoRa

BullSequana EX servers are air-cooled and managed by a single Baseboard Management Controller (BMC).

2.2. Front view

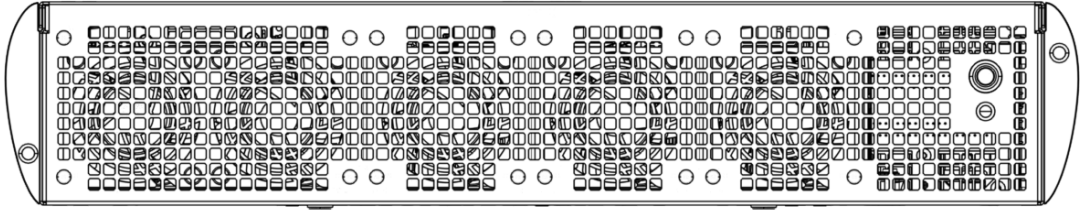

2.3. Rear components



Rear View

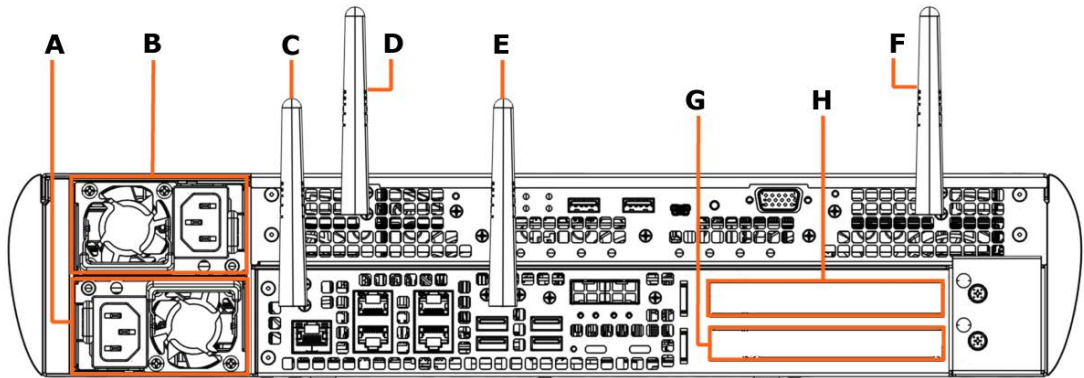

Mark	Description
A	PSU 0
B	PSU 1
C	Antenna
D	Antenna
E	Antenna
F	Antenna
G	Up to 2 x 150 W or 1 x 300 W PCIe modules
H	

Note Dual-band 2.4-5.9 GHz WIFI, LoRa, LTE/5G wireless technologies are supported. See the Installation Guide for the different antenna configurations possible.

2.4. Top level components

2.4.1. Top view with air duct

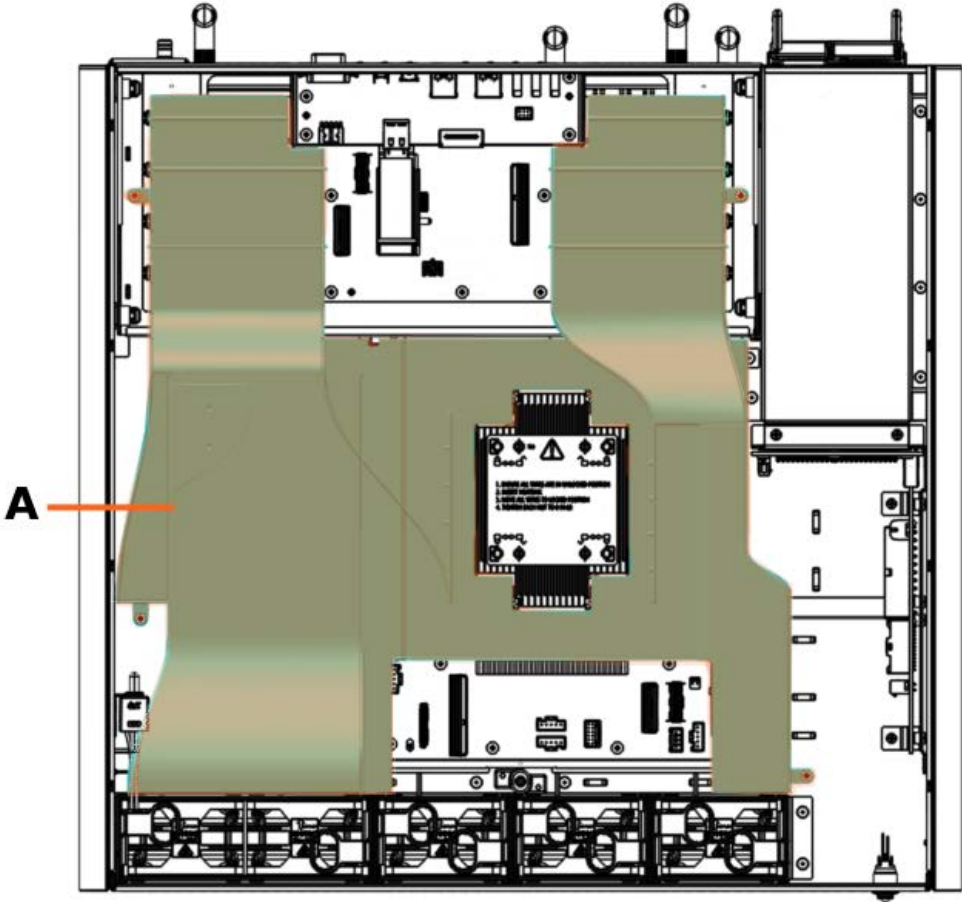

Mark	Description
A	Air duct

2.4.2. Top view without air duct



Top View

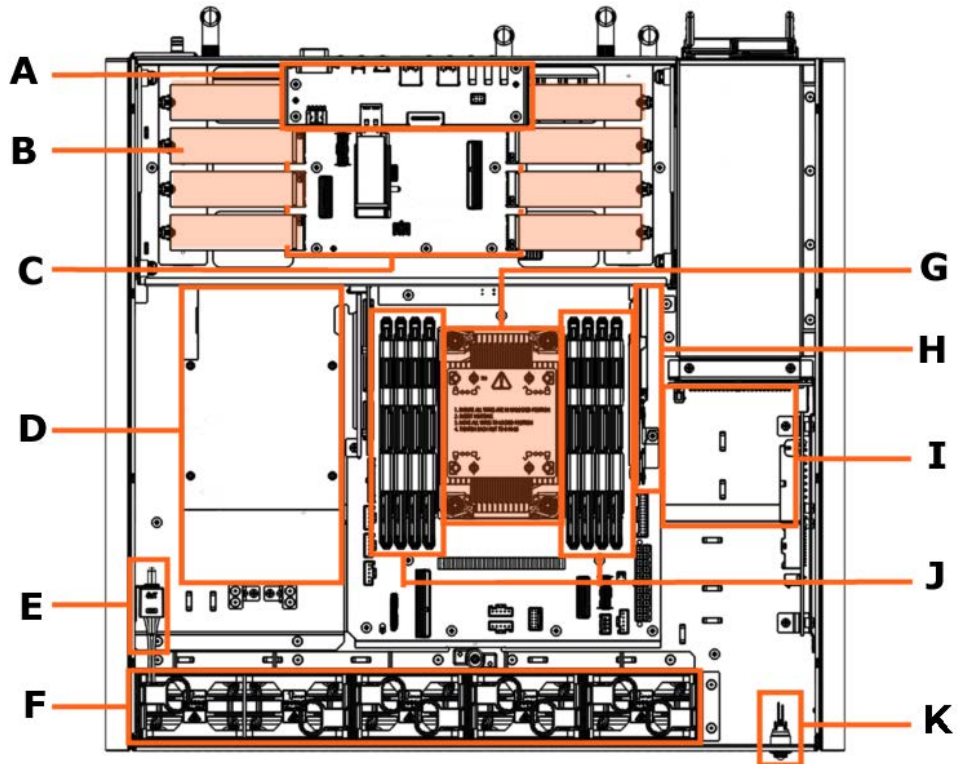

Mark	Description	Quantity
A	Front Panel Board (FPB)	1
B	M.2 NVMe disks	8
C	NVMe backpanel board	1
D	PCIe modules	2
E	Intrusion detection switch	1
F	Fans	5
G	Processor assembly	1
H	M.2 riser board	1
I	Power Distribution Board (PDB)	1
J	Memory modules	8
K	Power button	1

2.5. Memory modules

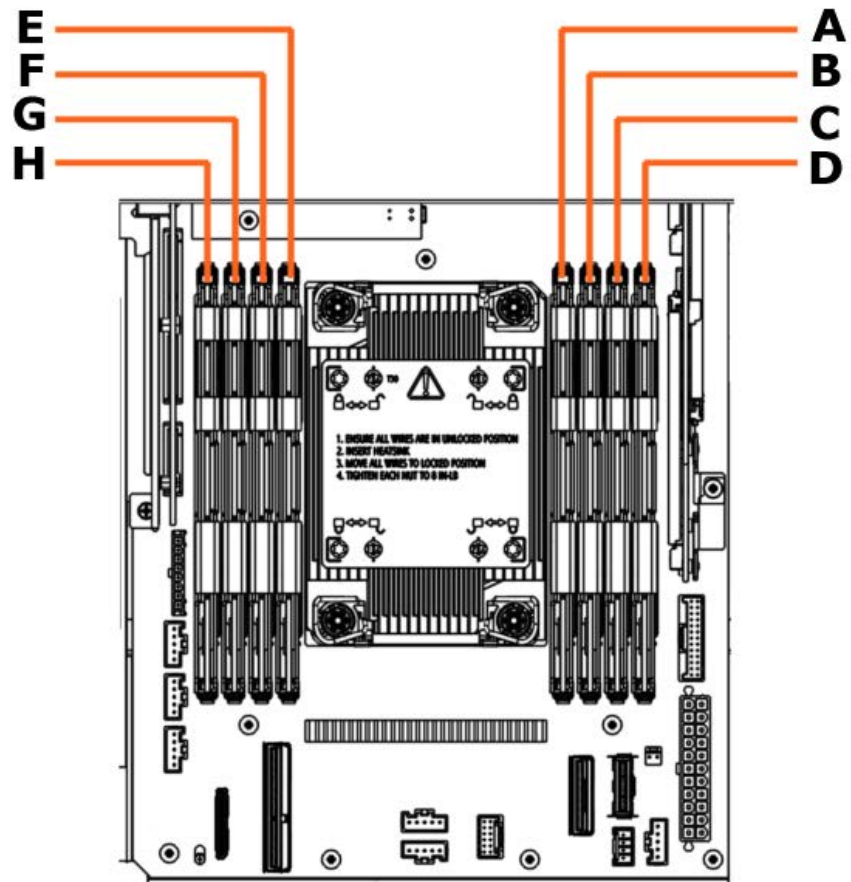

Mark	Channel Number	Board slot
A	0	CH-A
B	1	CH-B
C	2	CH-C
D	3	CH-D
E	4	CH-E
F	5	CH-F
G	6	CH-G
H	7	CH-H

2.6. M.2 NVMe disks

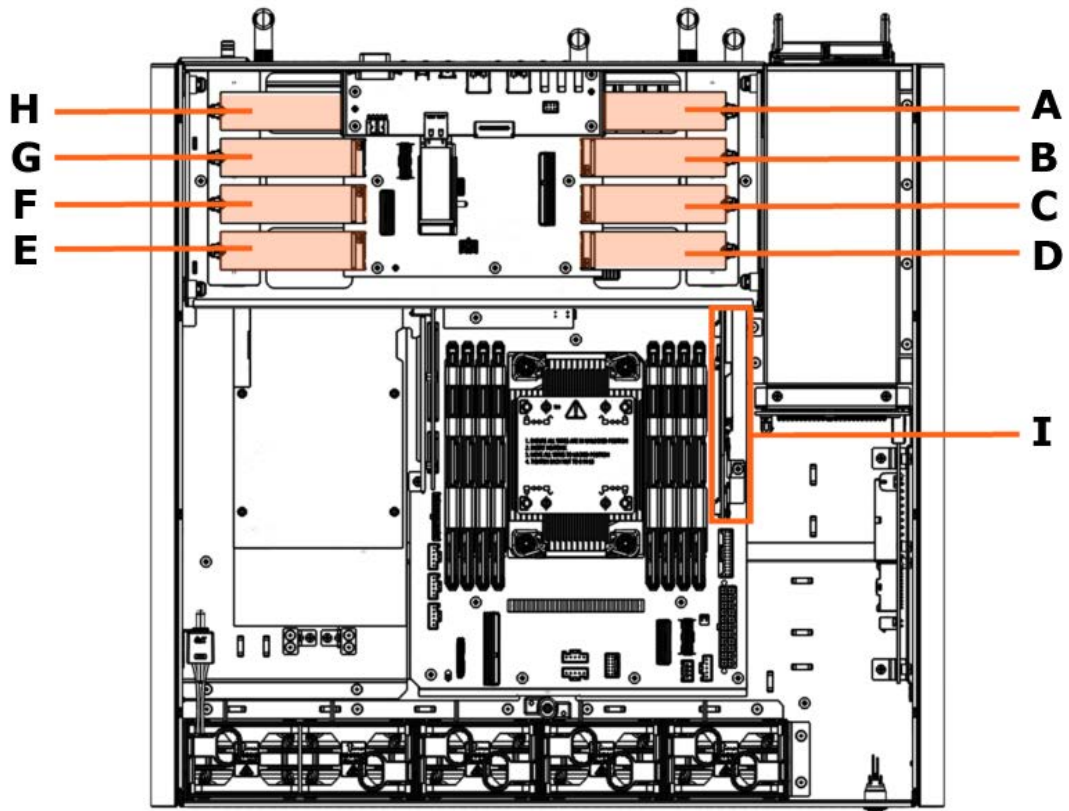

Mark	Description	Quantity
A	M.2 NVMe disk 0	1
B	M.2 NVMe disk 1	1
C	M.2 NVMe disk 2	1
D	M.2 NVMe disk 3	1
E	M.2 NVMe disk 4	1
F	M.2 NVMe disk 5	1
G	M.2 NVMe disk 6	1
H	M.2 NVMe disk 7	1
I	M.2 riser board disks	2

2.7. M.2 riser board

M.2 type M riser board

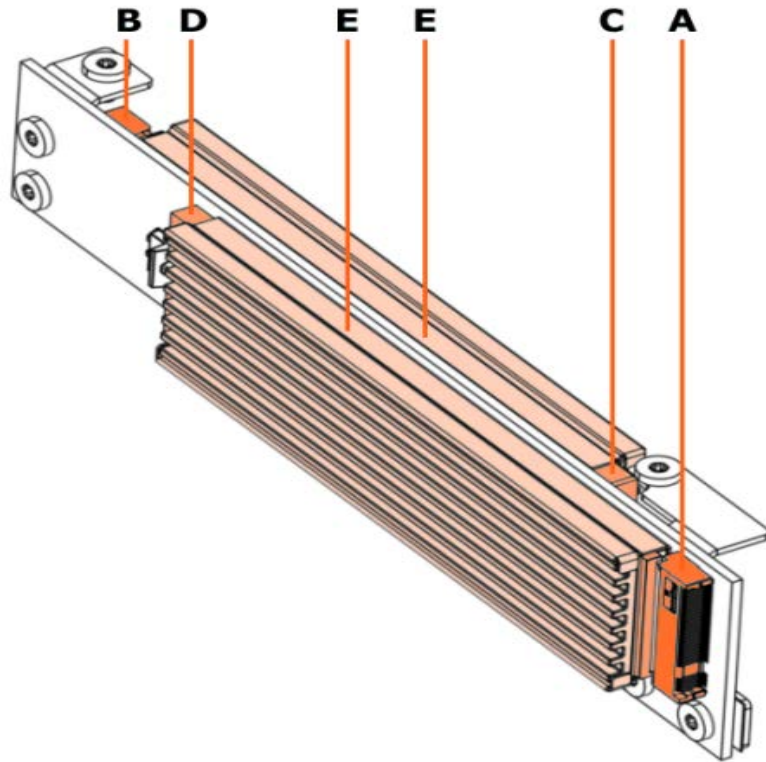

Mark	Slot	Possible card type
A	Slot 0 - M key connector	<ul style="list-style-type: none"> ▪ M.2 NVMe disk - M key (C) ▪ Accelerator card - B+M key (C)
B	Slot 1 - M key connector	<ul style="list-style-type: none"> ▪ M.2 NVMe disk - M key (C) ▪ Accelerator card - B+M key (C)
E	M.2 heat sink	N/A

Possible configurations

Slot	Configuration 1	Configuration 2	Configuration 3
M key connector	M.2 NVMe disk M key	Accelerator card B+M key	Accelerator card B+M key
M key connector	M.2 NVMe disk M key	Accelerator card B+M key	M.2 NVMe disk M key

M.2 type B riser board

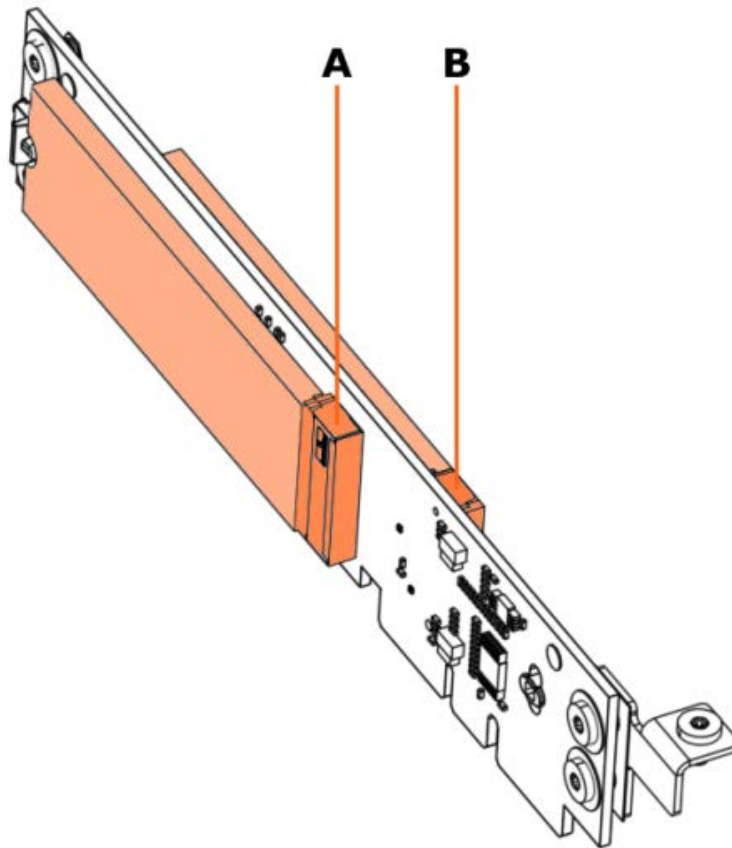

Mark	Slot	Possible card types
A	Slot 0 - B key connector	<ul style="list-style-type: none"> ▪ LTE 5G ▪ Accelerator - B+M key
B	Slot 1 - E key connector	<ul style="list-style-type: none"> ▪ LoRa (using adaptor) ▪ WIFI + Bluetooth ▪ Accelerator - A+E key

Possible configurations

Slot	Config 1	Config 2	Config 3	Config 4	Config 5
B key connector	LTE\5G	Accelerator card B+M key	LTE\5G	LTE\5G	Accelerator card B+M key
E key connector	WIFI + Bluetooth	WIFI + Bluetooth	Accelerator card A+E key	LoRa	LoRa

2.8. Fans

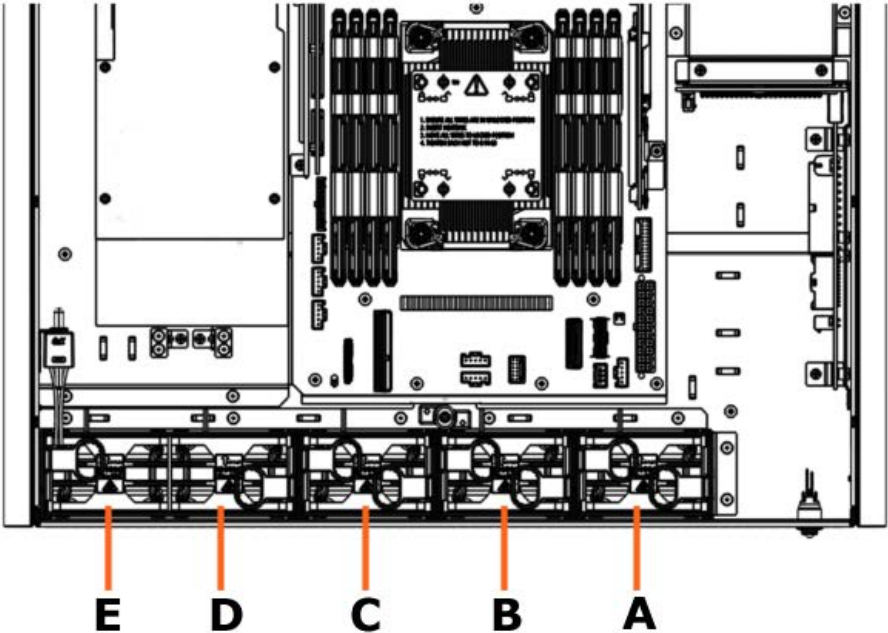

Mark	Description
A	FAN 0
B	FAN 1
C	FAN 2
D	FAN 3
E	FAN 4

2.9. Optional mezzanine

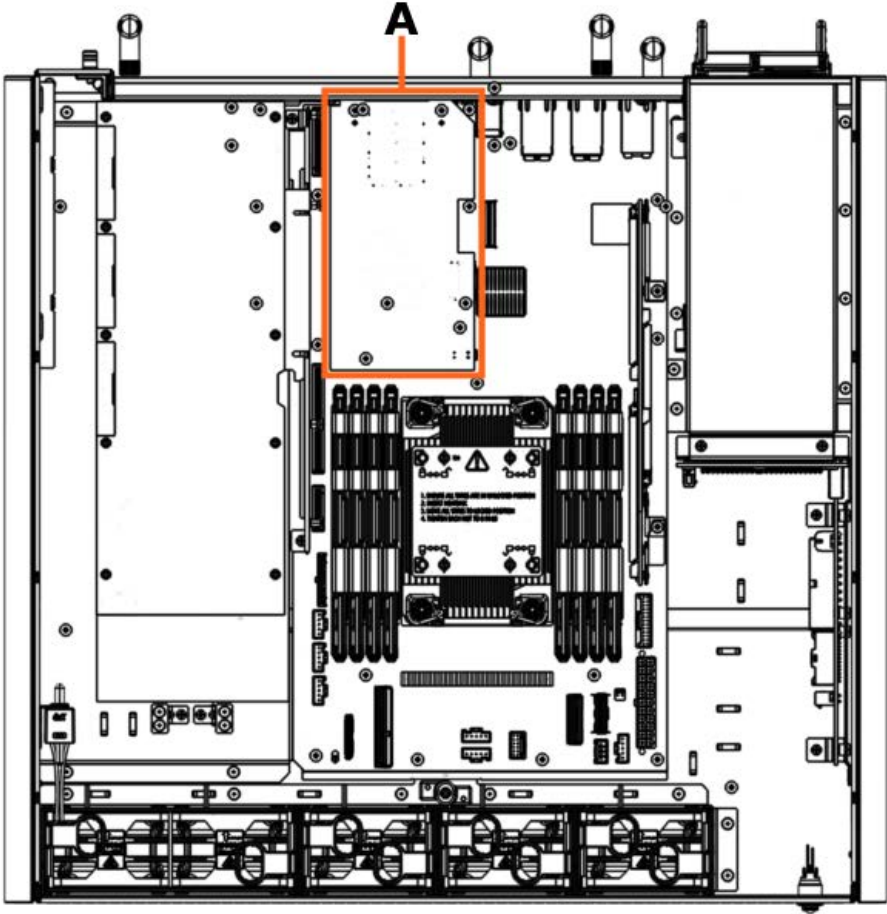

Mark	Description
A	10 Gb/s mezzanine

Chapter 3. Buttons, ports and LEDs

3.1. Front buttons, ports and LEDs

3.1.1. Buttons

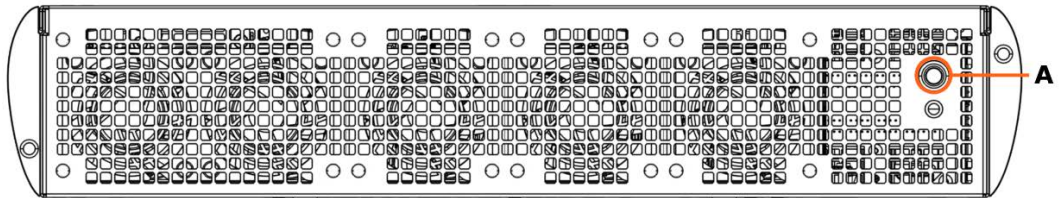

Mark	Description
A	Power On / Off

3.1.2. LEDs

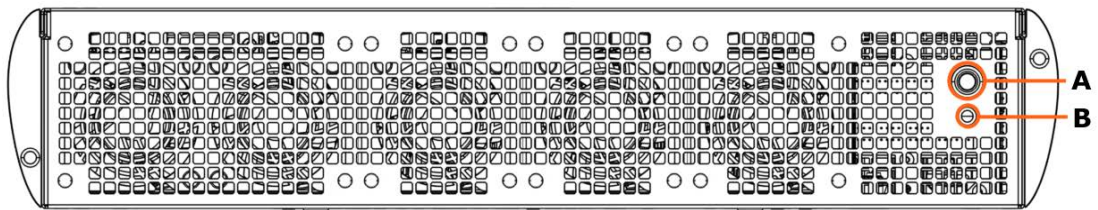

Mark	LEDs	Colour	Description
A	Power	Green	Module power on status
		Blinking green	Module standby status
B	ID	Blinking blue	Module identification

3.2. Rear buttons, ports and LEDs

3.2.1. Buttons

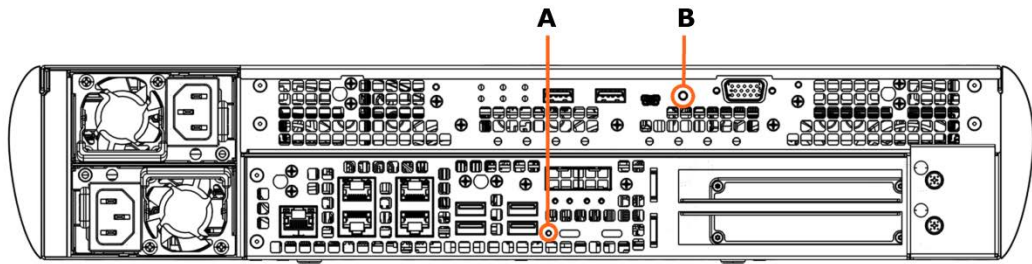

Mark	Description	Operation
A	BMC firmware recovery	Push the button in using a pointed object and release.
	Factory reset	Push the button in using a pointed object and hold it in for more than 10 seconds before releasing.
B	Power On / Off	

3.2.2. Ports

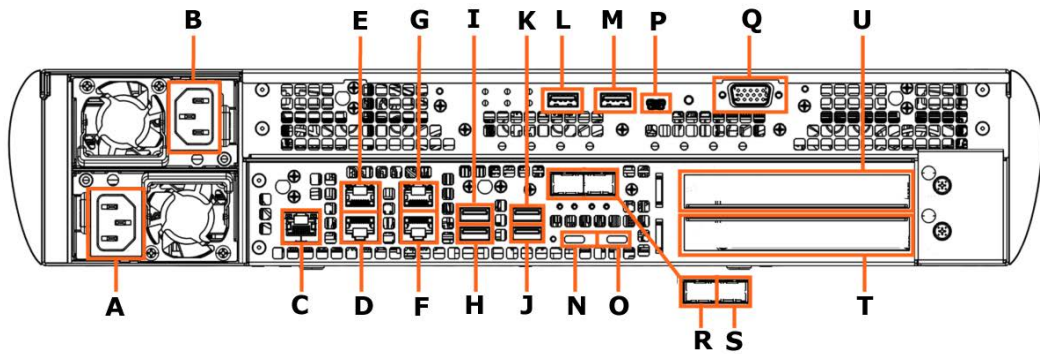

Mark	Description	Port identification
A	Power supply 0	PSU0
B	Power supply 1	PSU1
C	RJ45 1 Gb/s BMC Ethernet	BMC
D	RJ45 1 Gb/s Host Ethernet	Port 0
E	RJ45 1 Gb/s Host Ethernet	Port 1
F	RJ45 1 Gb/s Host Ethernet	Port 2
G	RJ45 1 Gb/s Host Ethernet	Port 3
H	USB 3.1 type A	Port 0
I	USB 3.1 type A	Port 1
J	USB 3.1 type A	Port 2
K	USB 3.1 type A	Port 3
L	USB 3.1 type A	Port 4
M	USB 3.1 type A	Port 5
N	USB 3.1 type C	Port 0
O	USB 3.1 type C	Port 1
P	USB 2.0 mini type B	N/A
Q	VGA connector	N/A
R	SFP+ 10 Gb/s Ethernet (optional)	Port 0
S	SFP+ 10 Gb/s Ethernet (optional)	Port 1
T	x16 PCIe riser	Slot 0
U	x16 PCIe riser	Slot 1

3.2.3. LEDs

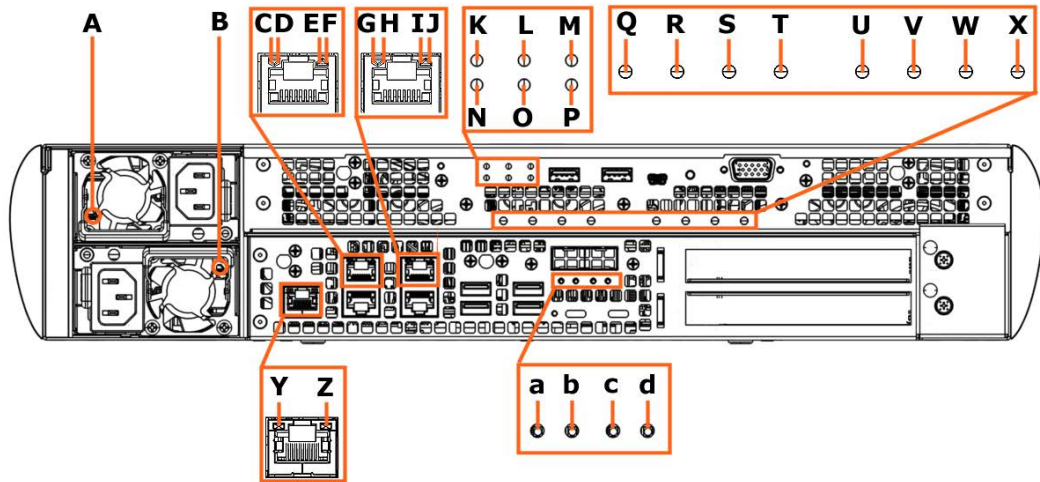

Mark	Colour	Description	Component
A / B	OFF	No AC power to all PSUs	PSU 1 / PSU0
	Green	Normal power	
	Blinking green 1Hz	AC present / Only Vsb ON - PS OFF	
	Blinking green 1Hz	Secondary PSU is set as active standby mode (cold redundant)	
	Blinking green 2Hz	PSU FW updating	
	Amber	AC cord unplugged or AC power lost, with a second PSU in parallel still with AC input power	
	Amber	PSU critical event causing a shutdown: failure, OCP, SCP, OVP, Fan Fail and OTP	
	Blinking amber 1Hz	PSU warning events where the PSU continues to operate; high temperature, high power, high current and slow FAN	
C	Green	1 Gb/s Ethernet speed up	RJ45 port 0
D	Blinking amber	Ethernet link activity	
E	Green	1 Gb/s Ethernet speed up	RJ45 port 1
F	Blinking amber	Ethernet link activity	
G	Green	1 Gb/s Ethernet speed up	RJ45 port 2
H	Blinking amber	Ethernet link activity	

Mark	Colour	Description	Component
I	Green	1 Gb/s Ethernet speed up	RJ45 port 3
J	Blinking amber	Ethernet link activity	
K	Green	OK	Temp fault
	Red blinking	Warning	
	Red	Error	
L	Green	OK	Fan fault
	Red blinking	Non critical error	
	Red	Critical error / fault occur	
M	Green	Module power on status	Power
	Green blinking	Module standby status	
	Red blinking	Recovery mode	
	Red	Power supply error	
N	Green	OK	WDT fault
	Red blinking	Warning limit overdue	
	Red	Error limit overdue	
O	Green	OK	DIMM fault
	Red blinking	Warning	
	Red	Error	
P	Blinking blue	Module identification	ID
Q	Blinking green	OK	NVME disk0 activity
	No LED	Fault/error or no AC power	
R	Blinking green	OK	NVME disk1 activity
	No LED	Fault/error or no AC power	
S	Blinking green	OK	NVME disk2 activity
	No LED	Fault/error or no AC power	
T	Blinking green	OK	NVME disk3 activity
	No LED	Fault/error or no AC power	
U	Blinking green	OK	NVME disk4 activity
	No LED	Fault/error or no AC power	
V	Blinking green	OK	NVME disk5 activity
	No LED	Fault/error or no AC power	
W	Blinking green	OK	NVME disk6 activity
	No LED	Fault/error or no AC power	

Mark	Colour	Description	Component
X	Blinking green	OK	NVME disk7 activity
	No LED	Fault/error or no AC power	
Y	Green	1 Gb/s Ethernet speed up	RJ45 BMC
Z	Blinking amber	Ethernet link activity	RJ45 BMC
a	Green	10 Gb/s Ethernet speed up	Mezzanine 10G port 0
b	Blinking amber	Ethernet link activity	
c	Green	10 Gb/s Ethernet speed up	Mezzanine 10G port 1
d	Blinking amber	Ethernet link activity	

Appendix A. Technical description

A.1. General technical specifications

Operating Limits	
Ambient air temperature	0°C to + 45°C ; Gradient 20°C / hour
Relative humidity (non condensing)	5% to 85% ; Gradient 5%/hour
Pressure	70 to 106 kPa
Elevation	Sea level < 3000 m
Non-operating Limits	
Ambient air temperature	<-20°C and >60°C
Relative humidity (non condensing)	<5% and >95% (Gradient 30%/h)
Moisture content	1 to 29 g/m ³
Shipping Limits	
Operating air temperature	-20°C to + 60°C ; Gradient 25°C/hour
Relative humidity (non condensing)	5% to 95% ; Gradient 30%/hour

A.2. Dimensions and weight

BullSequana EXD	
Height	2U - 87 mm
Width	430 mm
Depth	433 mm
Weight	~15 Kg

A.3. Module technical specifications

Electrical Specifications			
Each BullSequana EXD module is equipped with 2 redundant PSUs			
Input	100-127V AC 50/60Hz 12A max	200-240V AC 50/60Hz 8A max	240V DC 7A max
Output	+12.2V DC 82A +12.2Vsb DC 3A	+12.2V DC 106A +12.2Vsb DC 3A	
Total power	1000W max	1300W max	
Environmental Specifications			
Noise	25°C inlet, 75% of worst TDP power : 75dB		

A.4. Server technical description

Processor	
Number	BullSequana EXD Server: 1 processor
Type	Intel® Xeon® family: Sapphire Rapid
Architecture	
Platform	Based on Intel Eaglestream Platform
Memory	
Minimum / Maximum	BullSequana EXD Server: up to 1TB
Type	DDR5 RDIMM Up to 4400 MT/s
Slots	8x slots per module
I/O slots per module	
USB port	Rear 8x USB 3.0
Ethernet port	2x 10 Gb and 5x 1Gb Ethernet ports
Disks per module	
Disk	Internal 2x M.2 NVMe Disk Storage Upto 8x M.2 NVMe Disk
GPUs per module	
GPU	2x upto 150W GPU cards or 1x upto 300W GPU card

A.5. Antenna specifications

A.5.1. Dual-band WiFi

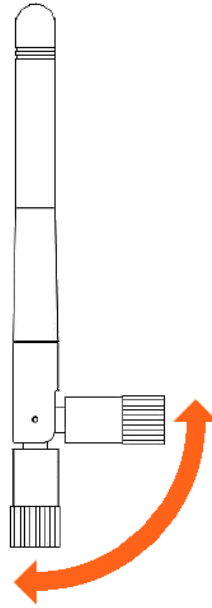

Dimensions	
Unfolded height	108 mm
Unfolded height	78 mm
Maximum width	10 mm
Minimum width	8 mm
Attached depth	31 mm
Technical specifications	
Frequency	2.4 - 5.9 GHz
Voltage Standing Wave Ratio	$\leq 2.5 : 1$
Gain	2.5 dB
Polarization	Vertical
Impedance	50 Ω
Max power	20 W
Environmental characteristics	
Operating temperature	- 40°C to + 85°C
Compliance	RoHS compliant

A.5.2. LoraWAN

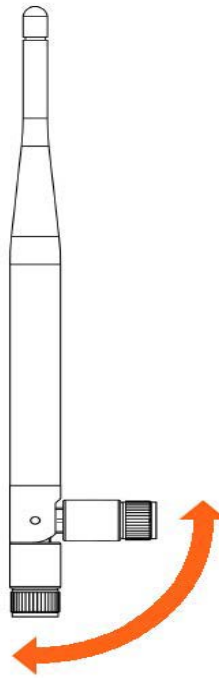

Dimensions	
Unfolded height	197 ± 3 mm
Unfolded height	173 ± 2 mm
Maximum width	13 mm
Minimum width	6 mm
Attached depth	37.3 ± 0.5 mm
Technical specifications	
Frequency	868 MHz
Voltage Standing Wave Ratio	< 2.0
Gain	3 dBi
Polarization	Linear
Impedance	50 Ω
Max power	20 W
Environmental characteristics	
Operating temperature	- 40°C to + 85°C
Vibration	10 to 55 Hz with 1.5 mm amplitude 2 hours
Compliance	RoHS compliant

A.5.3. LTE / 5G

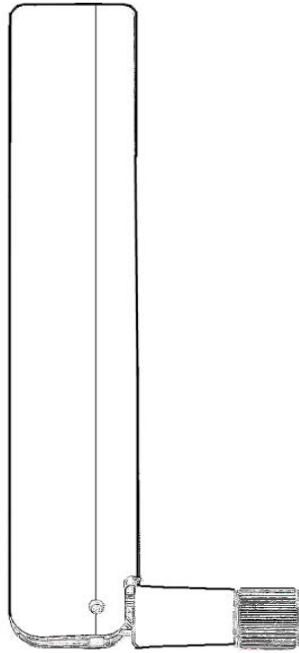

Dimensions			
Height	135 mm		
Width	10 mm		
Attached depth	19 mm		
Technical specifications			
Frequency (MHz)	617-960	1427-2690	3300-5000
Voltage Standing Wave Ratio	~2.0:1	~2.6:1	~2.3:1
Peak gain (dBi)	~-1.1	~0.5	~0.3
Average gain (dB)	~-4.3	~-3.8	~-4.6
Polarization	Linear		
Impedance	50 Ω		
Max power	25 W		
Environmental characteristics			
Operating temperature	- 40°C to + 85°C		
Compliance	RoHS compliant		

Acronyms

A

No entries

B

BIOS

Basic Input / Output System

BMC

Baseboard Management Controller

C

CPU

Central Processing Unit

CRU

Customer Replaceable Unit

D

DDR5

Double Data Rate fifth generation

DIMM

Dual In-line Memory Module

E

No entries

F

FPB

Front Panel Board

FPGA

Field Programmable Gate Array

FRU

Field Replaceable Unit

G

GPU

Graphical Processing Unit

GSM

Global System for Mobile communications

H

HTTPS

HyperText Transfer Protocol Secure

I

IP

Internet Protocol

J

No entries

K

No entries

L

LAN

Local Area Network

LED

Light Emitting Diode

LoRa

Long Range wireless communication

LoRaWAN

Long Range Wide Area Network

LTE

Long Term Evolution

M

MAC

Media Access Control

MI

Machine Intelligence

MISM

Machine Intelligence System Management

MIPSE

Machine Intelligence Pocket Server

N

NVMe

Non-Volatile Memory express

O

No entries

P

PDB

Power Distribution Board

PCI

Peripheral Component Interconnect

PCIe

PCI Express

PDU

Power Distribution Unit

PSU

Power Supply Unit

Q

No entries

R

RDIMM

Registered Dual In-line Memory Module

REST

Representational State Transfer

S

SATA

Serial ATA

SEL

System Event Log

SSD

Solid State Drive

SSH

Secured Shell

SSL

Secure Socket Layer

T

TDP

Thermal Design Point

U

USB

Universal Serial Bus

V**VGA**

Video Graphic Array

W**WIFI**

Wireless Fidelity

WDT

Watch Dog Timer

X

No entries

Y

No entries

Z

No entries

