

Bull NovaScale 6080, 6160 & 6320

Installation Guide

Bull



Bull NovaScale 6080, 6160 & 6320

Installation Guide

Hardware

October 2004

BULL CEDOC
357 AVENUE PATTON
B.P.20845
49008 ANGERS CEDEX 01
FRANCE

ORDER REFERENCE
86 A1 25EM 01

The following copyright notice protects this book under the Copyright laws of the United States of America and other countries which prohibit such actions as, but not limited to, copying, distributing, modifying, and making derivative works.

Copyright © Bull S.A. 2003, 2004

Printed in France

Suggestions and criticisms concerning the form, content, and presentation of this book are invited. A form is provided at the end of this book for this purpose.

To order additional copies of this book or other Bull Technical Publications, you are invited to use the Ordering Form also provided at the end of this book.

Trademarks and Acknowledgements

We acknowledge the right of proprietors of trademarks mentioned in this book.

Intel and Itanium are registered trademarks of Intel Corporation.

Windows and Microsoft software are registered trademarks of Microsoft Corporation.

UNIX is a registered trademark in the United States of America and other countries licensed exclusively through the Open Group.

Linux is a registered trademark of Linus Torvalds.

Table of Contents

Table of Contents	iii
Overview	vii
Intended Readers	vii
Highlighting	vii
Related Publications	viii
Regulatory Specifications and Disclaimers	ix
Definition of Safety Notices	xi
Electrical Safety	xi
Laser Safety Information	xii
Data Integrity and Verification	xii
Environmental Standards	xiii
Installation Flowchart	xvi
Chapter 1. Delivery	1-1
Bull NovaScale Server Overview	1-2
Dynamic Partitioning	1-2
Extended Configurations	1-2
Cluster Configurations	1-2
Server Features	1-3
Server Hardware	1-4
Central SubSystem Module (CSS Module)	1-4
Platform Administration Processor (PAP) Unit	1-4
KVM Switch	1-4
Slideaway Console / Console Drawer	1-5
Disk Subsystem	1-5
Additional Peripherals	1-5
Server Firmware and Software	1-5
Conformance to Standards	1-6
General Recommendations	1-7
Unpacking the 36U Cabinet	1-8
Inspecting 36U Cabinet Packing	1-9
Removing 36U Cabinet Packing	1-10
Inspecting the Server	1-11
Unloading the 36U Cabinet	1-12
Removing the Front Door	1-12
Removing the Rear Door	1-13
Removing Side Covers	1-14
Installing the 36U Cabinet Unloading Rail / Ramp Assembly	1-15
Removing the 36U Cabinet Shipping Brackets	1-16
Storing Packing Items	1-18
Installing and the Securing the 36U Cabinet	1-19
Removing CSS Module Shipping Brackets	1-22
Inspecting Internal Components and Cabling	1-23
Refitting Doors and Side Covers	1-24
Getting to Know the Server	1-27
NovaScale 6080 Server	1-27
NovaScale 6160 Server	1-28
NovaScale 6320 Server	1-29

Main Cabinet	1-29
I/O Cabinet	1-30
Server Components	1-31
Central Subsystem (CSS) Module	1-31
NovaScale 6080/6160 Server	1-31
NovaScale 6320 Server	1-32
Integrated Platform Administration Processor (PAP) Unit	1-33
Integrated Console	1-34
Keyboard / Video / Mouse (KVM) Switch	1-35
SR-0812 SCSI RAID Disk Rack	1-36
SJ-0812 SCSI JBOD Disk Rack	1-36
SJ-0812 SCSI JBOD Extension Disk Rack	1-37
FDA 1300 FC Disk Rack	1-38
FDA 2300 FC Disk Rack	1-39
FDA 1300 FC Extension Disk Rack	1-40
Ethernet Hub	1-41
USB Modem	1-41
Power Distribution Unit (PDU)	1-42
Chapter 2. Setup Procedure	2-1
Accessing Server Components	2-2
Opening the Front Door	2-2
Closing the Front Door	2-2
Opening / Closing the Slideaway Console	2-3
Setting up the Console Drawer	2-4
Closing the Console Drawer	2-5
Accessing the PAP Unit CD-Rom and Diskette Drives	2-6
Checking PMB Code Wheels	2-7
Extended and Cluster Systems	2-8
Checking Server Cabling and Connecting Inter-Cabinet Cables	2-9
Mounting Power Supply Cable Sockets	2-11
PDU Power Cable Socket	2-13
Connecting the Server to the Site Power Supply	2-14
Safety Recommendations	2-14
Powering Up the Server to the Standby Mode	2-14
Checking Server Operation	2-15
Launching PAM Software	2-15
PAM User Interface	2-17
Checking Server Status via PAM	2-18
PAM Status Pane	2-18
CSS Availability Status	2-18
PAM Tree Pane	2-19
PAM Control Pane	2-19
Toggling the Local / Integrated Console Display	2-20
Powering Up / Down Server Domains	2-20
Powering Up / Down NovaScale 6080/6160 Server Domains	2-21
Shutting Down / Restarting the Server	2-24
Powering Up / Down NovaScale 6320 Server Domains	2-25
Shutting Down / Restarting the Server	2-28
Completing PAP Unit Configuration	2-29
Changing the Default PAP Unit Name	2-29
Launching the PAP Configuration Setup Wizard	2-29
Configuring Customer Information	2-31

Configuring Autocalls	2-32
Changing the iStorage Manager User Name and Password	2-34
Connecting the PAP Unit to the Customer's Enterprise LAN	2-35
Connecting to the PAM Web Site from a Remote Computer/Workstation	2-36
Enabling Remote Access to the PAM Web Site with Internet Explorer	2-36
Enabling Remote Access to the PAM Web Site with Mozilla	2-36
Enabling Remote Access to iSM on the Client Computer	2-37
Completing Operating System Setup	2-38
NovaScale 6080/6160 Server – Operating System Setup	2-39
Microsoft Windows Setup	2-40
Linux RedHat Setup	2-41
Linux SuSe Setup	2-42
NovaScale 6320 Server – Operating System Setup	2-43
Microsoft Windows Setup	2-44
Linux RedHat Setup	2-45
Linux SuSe Setup	2-46
Preparing SCSI Disk Racks	2-48
SJ-0812 SCSI JBOD Disk Racks	2-48
SR-0812 SCSI RAID Disk Racks	2-49
SJ-0812 SCSI Extension Disk Racks	2-49
Connecting the Server to the Enterprise LAN	2-50
Connecting the USB Modem and External Devices	2-51
Connecting the USB Modem	2-51
Connecting External Storage Peripherals	2-51
Testing Network Connections	2-52
Testing Autocalls	2-52
Completing the PAM Installation Intervention Report	2-52
Renaming the Central Subsystem	2-53
Removing / Adding the Central Subsystem	2-53
Redefining the Default Scheme (NovaScale 6080/6160 Server)	2-55
Redefining the Default Scheme (NovaScale 6320 Server)	2-58
Setting up PAP Unit Users	2-61
Predefined PAP User Groups	2-61
Backing Up and Restoring PAM Configuration Files	2-63
Backing Up PAM Configuration Files	2-63
Restoring PAM Configuration Data	2-64
Chapter 3. Troubleshooting	3-1
Server Power	3-2
Mouse	3-3
Keyboard	3-4
Monitor	3-5
KVM Switch	3-6
PAP Unit	3-7
Disk Rack	3-8
CD-ROM Drive	3-9
Operating System	3-10
PAM Software	3-11
Appendix A. Specifications	A-1
NovaScale 6080/6160 Server Specifications	A-1
NovaScale 6320 Server Specifications	A-3
Appendix B. Conversion, Keyboard, and Writing Tables	B-1
Imperial to Metric	B-1

Metric to Imperial	B-1
Celsius to Fahrenheit Conversion	B-2
Fahrenheit to Celsius Conversion	B-2
AZERTY/QWERTY Keyboard Lookup Table	B-3
PAM Writing Rules	B-4
Illegal Characters	B-4
String Lengths	B-4
Registry Keys	B-5
Appendix C. Cabling Diagrams	C-1
Section I – NovaScale 6080/6160 Server Cabling Diagrams	C-2
Section II – NovaScale 6320 Server Cabling Diagrams	C-20
Glossary	G-1
Index	X-1

Overview

Intended Readers

This guide is intended for use by qualified personnel in charge of setting up and starting NovaScale 6080/6160/6320 Servers for the first time.

Chapter 1. *Delivery*

describes server features and explains delivery unpacking and inspection procedures.

Chapter 2. *Setup Procedure*

explains the procedures required to set up and start the server for the first time.

Chapter 3. *Troubleshooting*

explains what to do if a problem occurs during installation.

Appendix A. *Specifications*

Appendix B. *Conversion Tables*

Appendix C. *Server Cabling*

Highlighting

The following highlighting conventions are used in this guide:

Bold	Identifies predefined commands, subroutines, keywords, files, structures, buttons, labels, and icons.
<i>Italics</i>	Identifies referenced publications, chapters, sections, figures, and tables.
< >	Identifies parameters to be supplied by the user.

Related Publications

Site Preparation Guide, 86 A1 87EF

explains how to prepare a Data Processing Center for Bull NovaScale Servers, in compliance with the standards in force. This guide is intended for use by all personnel and trade representatives involved in the site preparation process.

User's Guide, 86 A1 21EM

explains how to use NovaScale 6080/6160/6320 Servers. This guide is intended for use by Customer Administrators and Operators.

Maintenance and Service Guide, 86 A7 26EM

explains how to maintain, service, and upgrade NovaScale 6080/6160/6320 Servers. This guide is intended for use by qualified support personnel.

Troubleshooting Guide, 86 A7 91EF

explains how to diagnose and solve any problems occurring during Bull NovaScale Server operation. This guide is intended for use by qualified support personnel.

Documentation Overview, 86 A2 27EM

describes the hardware, software and online documentation available for Bull NovaScale Servers, related Operating Systems, and licensed programs.

Bull 40U/19U Server Rack Cabinets, 86 A1 91EM

explains how to install and fit out rack cabinets for Bull NovaScale Servers and peripheral devices.



Note:

According to server configuration and version, certain features and functions described in this guide may not be accessible. Please contact your Bull Sales Representative for sales information.

Regulatory Specifications and Disclaimers

Declaration of the Manufacturer or Importer

We hereby certify that this product is in compliance with European Union EMC Directive 89/336/EEC, using standards EN55022 (Class A) and EN55024 and Low Voltage Directive 73/23/EEC, using standard EN60950. The product has been marked with the CE Mark to illustrate its compliance.

Safety Compliance Statement

- UL 60950 (USA)
- IEC 60950 (International)
- CSA 60950 (Canada)

European Community (EC) Council Directives

This product is in conformity with the protection requirements of the following EC Council Directives:

Electromagnetic Compatibility

- 89/336/EEC

Low Voltage

- 73/23/EEC

EC Conformity

- 93/68/EEC

Telecommunications Terminal Equipment

- 199/5/EC

Neither the provider nor the manufacturer can accept responsibility for any failure to satisfy the protection requirements resulting from a non-recommended modification of the product.

Compliance with these directives requires:

- an EC declaration of conformity from the manufacturer
- an EC label on the product
- technical documentation

Federal Communications Commission (FCC) Statement



Note:

This equipment has been tested and found to comply with the limits for a Class A digital device, pursuant to Part 15 of the FCC Rules. These limits are designed to provide reasonable protection against harmful interference when the equipment is operated in a commercial environment. This equipment generates, uses, and can radiate radio frequency energy and, if not installed and used in accordance with the instruction manual, may cause harmful interference to radio communications. Operation of this equipment in a residential area is likely to cause harmful interference in which case the user will be required to correct the interference at his own expense.

Properly shielded and grounded cables and connectors must be used in order to meet FCC emission limits. Neither the provider nor the manufacturer are responsible for any radio or television interference caused by using other than recommended cables and connectors or by unauthorized changes or modifications to this equipment. Unauthorized changes or modifications could void the user's authority to operate the equipment.

Any changes or modifications not expressly approved by the grantee of this device could void the user's authority to operate the equipment. The customer is responsible for ensuring compliance of the modified product.

FCC Declaration of Conformity

This device complies with Part 15 of the FCC Rules. Operation is subject to the following two conditions: (1) this device may not cause harmful interference, and (2) this device must accept any interference received, including interference that may cause undesired operation.

Canadian Compliance Statement (Industry Canada)

This Class A digital apparatus meets all requirements of the Canadian Interference Causing Equipment Regulations.

Cet appareil numérique de la classe A est conforme à la norme NMB-003 du Canada.

This product is in conformity with the protection requirements of the following standards:

Electromagnetic Compatibility

- ICES-003
- NMB-003

Laser Compliance Notice

This product that uses laser technology complies with Class 1 laser requirements.

A CLASS 1 LASER PRODUCT label is located on the laser device.

<p>Class 1 Laser Product Luokan 1 Laserlaite Klasse 1 Laser Apparat Laser Klasse 1</p>
--

Definition of Safety Notices



DANGER

A *Danger* notice indicates the presence of a hazard that has the potential of causing death or serious personal injury.



CAUTION:

A *Caution* notice indicates the presence of a hazard that has the potential of causing moderate or minor personal injury.



Warning:

A *Warning* notice indicates an action that could cause damage to a program, device, system, or data.

Electrical Safety

The following safety instructions shall be observed when connecting or disconnecting devices to the system.



DANGER

The Customer is responsible for ensuring that the AC electricity supply is compliant with national and local recommendations, regulations, standards and codes of practice.

An incorrectly wired and grounded electrical outlet may place hazardous voltage on metal parts of the system or the devices that attach to the system and result in an electrical shock.

It is mandatory to remove power cables from electrical outlets before relocating the system.



CAUTION:

This unit has more than one power supply cable. Follow procedures for removal of power from the system when directed.

Laser Safety Information

The optical drive in this system unit is classified as a Class 1 level Laser product. The optical drive has a label that identifies its classification.

The optical drive in this system unit is certified in the U.S. to conform to the requirements of the Department of Health and Human Services 21 Code of Federal Regulations (DHHS 21 CFR) Subchapter J for Class 1 laser products. Elsewhere, the drive is certified to conform to the requirements of the International Electrotechnical Commission (IEC) 60825–1: 2001 and CENELEC EN 60825–1: 1994 for Class 1 laser products.



CAUTION:

Invisible laser radiation when open. Do not stare into beam or view directly with optical instruments.

Class 1 Laser products are not considered to be hazardous. The optical drive contains internally a Class 3B gallium–arsenide laser that is nominally 30 milliwatts at 830 nanometers. The design incorporates a combination of enclosures, electronics, and redundant interlocks such that there is no exposure to laser radiation above a Class 1 level during normal operation, user maintenance, or servicing conditions.

Data Integrity and Verification



Warning:

Bull NovaScale Servers are designed to reduce the risk of undetected data corruption or loss. However, if unplanned outages or system failures occur, users are strongly advised to check the accuracy of the operations performed and the data saved or transmitted by the system at the time of outage or failure.

Environmental Standards

Climatic and Atmospheric Specifications

Bull NovaScale Servers comply with standards:

- IEC 60068.2.1
- IEC 60068.2.2
- IEC 60068.2.78
- IEC 60529
- IEC 60950
- ISO 7779

Electrical Specifications

Bull NovaScale Servers comply with standards:

- IEC 60038
- IEC 60059
- IEC 60196
- IEC 60364
- IEC 61689

Mains Source Power

- 207–244 VAC, 49 – 61 Hz (single phase Ph / N + PE or Ph / Ph + PE), 20A

Voltage Sag

- 20 ms (IEC 1000–4–11)

Electromagnetic Compatibility

Bull NovaScale Servers comply with standards:

Europe

- EN 55022 Class A
- EN 55024 Class A
- EN 61000–3–2
- EN 61000–3–3

North America

- FCC Part 15 Class A
- ICES–003 Issue 3 Class A

Protection against Electrostatic Discharges

CMOS (Complementary Metal Oxide Semiconductor) technology is highly sensitive to electrostatic discharges. The use of conductive antistatic flooring is strongly recommended.

Maintenance personnel must wear wrist–straps before handling electronic equipment.

Shocks and Vibrations

Bull NovaScale Servers comply with standards:

- IEC 60068–1
- IEC 60068–2–6
- IEC 60068–2–27
- IEC 60068–2–31
- IEC 60068–2–47
- IEC 60068–2–64
- IEC 60050
- ISO 2041
- ISO 5348
- ISO 5344
- ISO 8626

Operating Mode (on levelers)

- Sinusoidal vibrations:
 - Duration: 1 sweep, 1 octave/mn
 - 5 – 16 Hz range: 0.25 mm peak
 - 16 –200 Hz range: 0.25 g peak
- Random excitation:
 - Duration: 15 mn
 - Frequency: 5 – 200 Hz
 - Spectral density: 1.5×10^{-4} g²/Hz
 - Root mean square acceleration: 0.17g RMS

Non–operating Mode (on castors)

- Sweep sine:
 - Duration: 1 sweep, 1 octave/mn
 - 5 – 16 Hz range: 0.25 mm peak
 - 16 – 200 Hz range: 0.25 g peak
- Random excitation:
 - Duration: 15 mn
 - Frequency: 5 – 200 Hz
 - Spectral density: 1.5×10^{-3} g²/Hz
 - Root mean square acceleration: 0.54g RMS

Shock Tests:

- Duration: 11 ms
- Form: 1/2 sinusoidal
- Amplitude: 15 g

Pollution Limits

Bull NovaScale Servers comply with standard:

- NFX44–101, Class 4 000 000

Audio–Noise Limits

Bull NovaScale Servers comply with standards:

- ISO 7779
- ISO 11201
- ISO 7574
- ISO 4871
- ISO 9295
- ISO 9296
- IEC 61260
- IEC 60651

Operating LwAd Acoustical Power

- 7.4 Bel

Operating Lpa Acoustical Pressure

- 60 dBA

Safety Specifications

Bull NovaScale Servers comply with national and international standards:

- IEC 60950
- EN 60950
- UL 60950
- CAN/CSA C22–2 N° 60950–00

Installation Flowchart

This flowchart summarizes main installation and setup procedures.

Unpacking the Server	
Step	OK
• Inspect server packing	<input type="checkbox"/>
• Remove server packing	<input type="checkbox"/>
• Inspect the server	<input type="checkbox"/>
• Remove doors and side covers	<input type="checkbox"/>
• Unload the server cabinet(s) and accessories	<input type="checkbox"/>
• Store packing items	<input type="checkbox"/>



Installing and Securing the Cabinet	
Step	OK
• Position the cabinet(s)	<input type="checkbox"/>
• Secure the cabinet(s) into place	<input type="checkbox"/>
• Remove shipping brackets	<input type="checkbox"/>



Inspecting the Server	
Step	OK
• Check that the server is not damaged and is compliant with the Purchase Order	<input type="checkbox"/>
• Inspect internal components and cabling	<input type="checkbox"/>
• Refit doors and side covers	<input type="checkbox"/>



Connecting Inter-Cabinet Cables	
Step	OK
<ul style="list-style-type: none"> Connect server inter-cabinet data cables. 	<input type="checkbox"/>



Connecting the Server to the Power Supply	
Step	OK
<ul style="list-style-type: none"> Mount power supply cable sockets 	<input type="checkbox"/>
<ul style="list-style-type: none"> Connect the server power cables to the dedicated power supply 	<input type="checkbox"/>



Powering up the Server	
Step	OK
<ul style="list-style-type: none"> Power on the server to the standby mode 	<input type="checkbox"/>
<ul style="list-style-type: none"> Launch PAM software 	<input type="checkbox"/>
<ul style="list-style-type: none"> Check server status 	<input type="checkbox"/>
<ul style="list-style-type: none"> Power up / down the server domain(s) 	<input type="checkbox"/>
<ul style="list-style-type: none"> Shut down / restart the server 	<input type="checkbox"/>



Completing PAP Unit Configuration and Operating System Setup	
Step	OK
<ul style="list-style-type: none"> Change the PAP unit default name 	<input type="checkbox"/>
<ul style="list-style-type: none"> Launch the PAP Configuration Setup wizard 	<input type="checkbox"/>
<ul style="list-style-type: none"> Configure Customer information 	<input type="checkbox"/>
<ul style="list-style-type: none"> Configure Autocalls 	<input type="checkbox"/>
<ul style="list-style-type: none"> Connect the PAP unit to the Enterprise LAN 	<input type="checkbox"/>
<ul style="list-style-type: none"> Complete Operating System setup for the server domain(s) 	<input type="checkbox"/>



Connecting the Server to the Enterprise LAN and Connecting External Devices	
Step	OK
• Connect the server to the Enterprise LAN	<input type="checkbox"/>
• Connect external peripherals (storage, modem, ...)	<input type="checkbox"/>



Confirming Correct Installation	
Step	OK
• Test network connections	<input type="checkbox"/>
• Test Autocalls	<input type="checkbox"/>
• Record site data	<input type="checkbox"/>
• Send the Intervention Report	<input type="checkbox"/>

Chapter 1. Delivery

This chapter explains delivery unpacking and inspection procedures for NovaScale 6080/6160/6320 Servers. It includes the following topics:

- Overview, on page 1-2
- General Recommendations, on page 1-7
- Unpacking the 36U Cabinet, on page 1-8
- Inspecting the Server, on page 1-11
- Unloading the 36U Cabinet, on page 1-12
- Installing and Securing the 36U Cabinet, on page 1-19
- Inspecting Internal Components and Cabling, on page 1-23
- Getting to know the Server, on page 1-27

Bull NovaScale Server Overview

Bull NovaScale Servers for business and scientific applications are based upon the FAME architecture (Flexible Architecture for Multiple Environments), leveraging the latest generation of Intel® Itanium® 2 processors.

NovaScale 6xx0 Servers are designed to operate as one, two, three or four hardware-independent SMP systems or domains, each running an Operating System instance and a specific set of applications.

According to version, servers are delivered rack-mounted and ready-to-use in high or low cabinets.



Figure 1. Bull NovaScale Server cabinets

Dynamic Partitioning

Bull NovaScale 6000 Series servers can be dynamically partitioned into physically independent ccNUMA (Cache Coherent Non Uniform Memory Access) SMP systems or domains, each running an Operating System instance and a specific set of applications.

Extended Configurations

Several Bull NovaScale Servers may be administered through a single instance of PAM software.

Cluster Configurations

Several Bull NovaScale Servers may be grouped to act like a single system, enabling high availability, load balancing and parallel processing.

Server Features

The main features of Bull NovaScale Servers are:

Intel® Itanium® Processor Family architecture:

- Modularity, predictable performance and growth

High availability:

- Component redundancy
- Capacity to isolate or replace a faulty components without service disruption
- Global and unified system visibility
- Round-the-clock operation

Scalability:

- Dynamic partitioning
- Power on demand : capacity to dynamically adapt resources to load requirement

Simultaneous support of multiple environments:

- Microsoft® Windows® Server
- Linux®

High performance computing capabilities:

- Business Intelligence:
 - . Datawarehousing
 - . Datamining
- Large enterprise applications:
 - . ERP
 - . CRM
 - . SCM ...
- Large database applications for Internet transactions.
- Large business sector applications:
 - . Online billing
 - . Online reservations
 - . Online banking ...

Built-in Platform Administration and Maintenance (PAM) software suite:

- Proactive administration
- Optimization of resources
- Automatic generation of corrective actions and calls to support centers
- Dynamic configuration

Bull NovaScale Master System Management (NSM) software suite:

- Windows, Linux, and Platform management
- Monitoring, Information, Control, and Event Handling
- Client / Server / Agent architecture
- WEB standard OpenSource solutions

Server Hardware



Note:

Abbreviations and acronyms are documented in the *Glossary*.

Main server hardware components are:

Central SubSystem Module (CSS Module)

The CSS Module houses core hardware components:

- 2 or 4 QBBs
- 2 IOBs
- 2 IORs
- 1 PMB
- 1 MPB
- DPS units

A CSS Module can be logically divided into two **Cells**, each with one or two QBBs and one IOB, to allow dynamic partitioning.

The NovaScale 6320 Server is equipped with two inter-connected CSS modules.

Quad Brick Block (QBB)

The QBB is equipped with 1 to 4 Itanium 2 processors and 16 DDR DIMMs. The QBB communicates with the rest of the system the high-speed bidirectional link **Scalability Port Switches (SPS)** located on the Midplane.

IO Board (IOB)

The IOB provides 4 PCI-X bridges for the connection of up to 11 PCI-X boards, and a PCI Hot Plug Board (PHPB). The IOB communicates with the rest of the system through the high-speed bidirectional link **Scalability Port Switches (SPS)** located on the Midplane.

IO Riser (IOR)

The IOR is an IOB daughter board providing legacy IO connections: 2 USB ports, 1 LAN port, 2 serial ports, 1 video port, and 1 CD/DVD Rom drive.

Platform Maintenance Board (PMB)

The PMB concentrates logistics access and links the platform to the Platform Administration Processor (PAP Unit) running Platform Administration and Maintenance (PAM) software.

Midplane (MPB)

The MPB houses the high-speed directional link **Scalability Port Switch (SPS)**. The MPB is divided into two physical **Cells**, each capable of connecting 2 QBBs and 1 IOB, which communicate with the rest of the system through the SPS. The MPB also houses the system clock and connects all other system boards.

Distributed Power Supply (DPS) Unit

Each DPS Unit supplies 48V AC/DC power to the server. Each module is equipped with 4 DPS units for full redundancy.

Platform Administration Processor (PAP) Unit

The PAP Unit hosts all server administration software, in particular Platform Administration and Maintenance (PAM) software.

KVM Switch

The KVM Switch allows the use of a single keyboard, monitor and mouse for the local server domains and the local PAM console.

Slideaway Console / Console Drawer

The Console contains the keyboard, monitor and touch pad / mouse used for local access to the server domains and to the PAP Unit.

Disk Subsystem

A SCSI RAID or FC disk subsystem is required for OS disk partitions.

Additional Peripherals

Additional peripherals such as disk subsystems, storage area networks, communication networks, archiving peripherals etc. can be connected to the server via PCI adapters located in the IOCs. Such peripherals may either be rack-mounted in the server cabinet (if free space is available) or in external cabinets.

Server Firmware and Software

Operating Systems (OS)

The server is certified for the following Operating Systems:

- Windows Server 2003, Enterprise Edition
- Windows Server 2003, Datacenter Edition
- Linux Red Hat Advanced Server
- Linux SUSE

BIOS

The BIOS controls the server startup process, dynamic resource allocation (Domain reconfiguration, hot-plugging), and error handling. The BIOS also includes:

- The **Extended Firmware Interface (EFI)**, which provides the OS with system services.
- The **EFI Shell**, an autonomous environment used to run Off-line Test & Diagnostic suites.

Platform Administration and Maintenance (PAM) suite

The PAM Web-based software suite is used to operate, monitor, and configure the server. PAM can be accessed locally or remotely through Microsoft Internet Explorer or Mozilla browsers, under the protection of appropriate access rights. PAM provides the administration functions needed to manage and maintain the server:

- Domain configuration and resource allocation
- Alert or maintenance requests to the Customer Service Center
- Error logging ...

Test & Diagnostics suites

The server is delivered with the following T & D suites:

- Online Test & Diagnostic suite
- Offline Test & Diagnostic suite
- Power-On Self-Test suite

NovaScale Master (NSM) Management suite

The NSM software suite allows you to monitor and manage NovaScale Windows and Linux systems.

Conformance to Standards

Intel

Bull NovaScale Servers conform to all Intel platform standards:

- ACPI (Advanced Configuration and Power Interface)
- IPMI (Intelligent Platform Management Interface)
- EFI (Extended Firmware Interface)
- SMBIOS (System Management BIOS)
- DIG64 (Developer Interface Guide for Intel Itanium Architecture)

Windows

Bull NovaScale Servers conform to the standards set out in the Windows Hardware Design Guide.

General Recommendations

Bull NovaScale Servers are delivered rack-mounted and pre-cabled in one or more high or low cabinets, according to the version chosen.

Site preparation must be completed by the pre-arranged delivery date. Any delay due to non-completion of the site by the pre-arranged date will be considered as the Customer's responsibility.

The server is delivered 24 hours in advance of the scheduled installation date. On arrival, it must be placed, in its packing, in the Computer Room so that it reaches room temperature before powering up (optimum operating temperature = $22^{\circ}\text{C} \pm 3^{\circ}\text{C}$, hygrometry = $50\% \pm 5\%$).



CAUTION:

It is mandatory for the server to be transported vertically. Server cabinets are extremely heavy and require the use of an elevator. The Data Processing Site manager must allocate enough personnel to ensure safe handling.

See Appendix A. for server specifications.

Use the Packing Slip to check the number and condition of the shipping boxes prior to unpacking.

The server is delivered with a box labeled *Open Me First* containing all the data and items required for installation.



Warning:

To avoid condensation and incorrect handling, the server must be removed from its packing by authorized Service personnel ONLY, on the scheduled installation date.



Notes:

40U/19U Rack Cabinets

Instructions on how to install and fit out 40U/19U rack cabinets for Bull NovaScale Servers and peripheral devices are set out in document *Bull 40U/19U Server Rack Cabinets*, 86 A1 91EM.

36U Rack Cabinets

Instructions on how to install 36U rack cabinets are set out in the present document.

Unpacking the 36U Cabinet



Note:

40U/19U Rack Cabinets

Instructions on how to install and fit out 40U/19U rack cabinets for Bull NovaScale Servers and peripheral devices are set out in document *Bull 40U/19U Server Rack Cabinets*, 86 A1 91EM.



Warning:

The server must not be unpacked before it has reached room temperature (24 hours in the Computer Room).

Server cabinets are delivered packed on a pallet with rails for easy unloading. The Data Processing Site manager must set aside the required working area for unpacking as shown in the following figure.

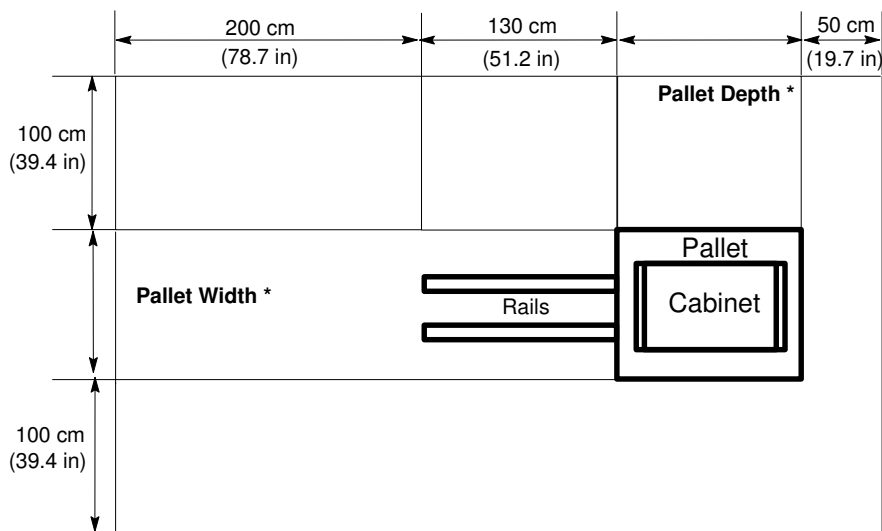

Server	Pallet Width *	Pallet Depth *
NovaScale 6xx0 Servers	80 cm (32 in)	128 cm (51 in)

Figure 2. Required unpacking area – standard rack cabinet

The following packing items are used to protect server cabinets during shipping:

- anti-condensation barrier packing,
- top, front, rear protective covers,
- pallet,
- loading / unloading rails and ramp,
- plastic straps,
- velcro straps,
- shockwatch and tiltwatch labels.

See Appendix A. Specifications for cabinet packing details.



DANGER

Server cabinets are extremely heavy. Authorized Service personnel **ONLY** may unpack and physically install cabinets. The instructions set out below are to be strictly complied with to avoid serious personal injury.

Inspecting 36U Cabinet Packing

Before unpacking, check the indicators on the 2 shockwatch and 4 tiltwatch labels, positioned as follows on the packing:

Shockwatch labels

- 1 on the front cover,
- 1 on the rear cover.

Tiltwatch labels

- 1 on the front cover,
- 1 on the side cover,
- 1 on the outer side of the internal front door cover,
- 1 on the inner side of the internal front door cover.

If one or more of the indicators are RED, the server may be damaged. Note indicator status on the bill of lading and carefully inspect the server before powering up.

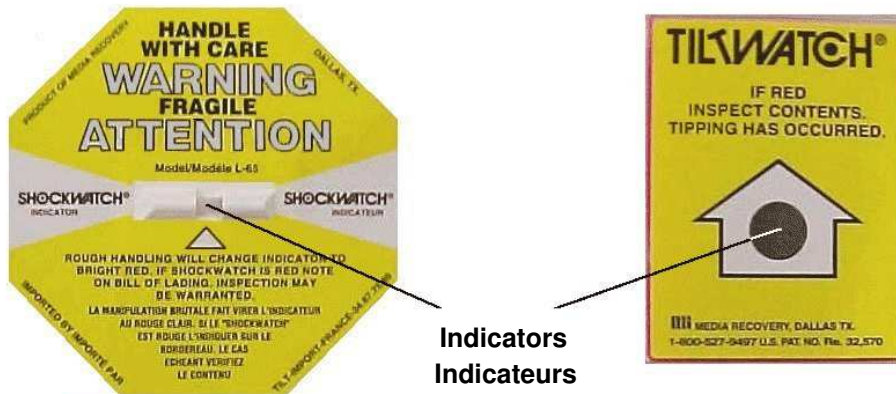

NOTE :

Inspecter l'étiquette détectrice de choc de cet envoi **AVANT** d'accepter la marchandise

ATTENTION :

Le TILT est rouge, ne pas refuser le colis, mais notez-le sur le bordereau et vérifiez le contenu



NOTE: Check the Shockwatch label BEFORE accepting the merchandise.	ATTENTION: If the Tiltwatch label is red, make a reserve on the delivery slip and check packing contents.
---	---

Figure 3. Packing shockwatch and tiltwatch labels

Removing 36U Cabinet Packing

Tools Required:

- Cutter
- 27 mm wrench
- 17 mm hex wrench



Figure 4. Removing the top, front, and rear covers – standard 36U cabinet

1. Cut the plastic straps with the cutter.
2. Remove the top cover.
3. Remove the rear and front covers by opening the plastic fasteners.
4. Remove the stretch film / condensation barrier packing retaining the loading / unloading rails and ramp.
5. Unfasten and remove the stoppers surrounding the cabinet.

Inspecting the Server

A preliminary visual inspection must be performed once the server has been unpacked and before unloading the cabinets from their pallets.



CAUTION:

If the inspection indicates an unacceptable safety condition, the condition must be corrected before powering up the server.

1. Check that the server delivered is compliant with the Purchase Order.
2. Check covers and doors for sharp edges, damage or alterations.
3. Check the correct fit of covers and doors.
4. Open the front and rear doors.



Note:

Unlock the front door with the key, pull the handle forwards and upwards to disengage the lock.

5. Check for internal damage, alterations and obvious safety hazards such as broken wires, sharp edges, or broken insulation.
6. Check internal cables for damage.
7. Check for dirt, water, and any other form of contamination inside the cabinet.
8. Check the voltage label on the back of the cabinet to ensure that it matches the voltage at the power outlet.
9. Check external power cables for damage.
10. Check correct closure of front and rear doors.



Note:

Server components and configuration may differ according to the version chosen.

Unloading the 36U Cabinet

To ensure safe handling, doors and side covers must be removed before unloading cabinets from their pallet.

Removing the Front Door

The front door can be fitted on the right or left side of the cabinet, according to site requirements. See *Turning the Front Door* in the *Maintenance and Service Guide*.

Tools Required:

- Cabinet key

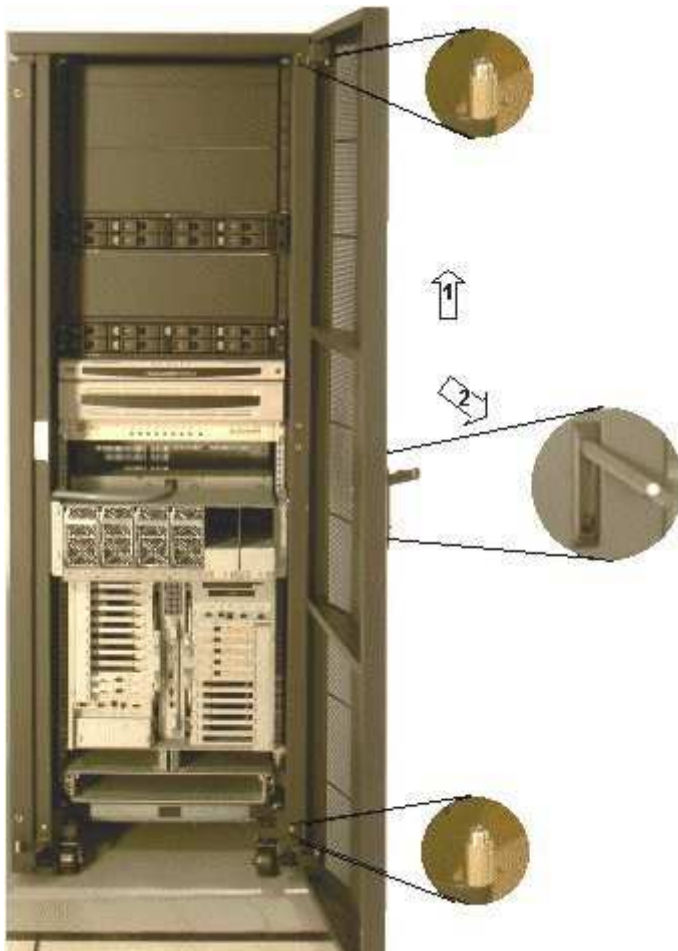

Figure 5. Removing the front door – 36U cabinet

1. Unlock the front door with the key, pull the handle forwards and upwards to disengage the lock.
2. Open the front door until it is at a right angle with the front of the cabinet.
3. Firmly grip either side of the door and lift to remove from the hinges (1).
4. Pull the door away from the front of the cabinet (2) and store in a safe place.

Removing the Rear Door

Tools Required:

- None

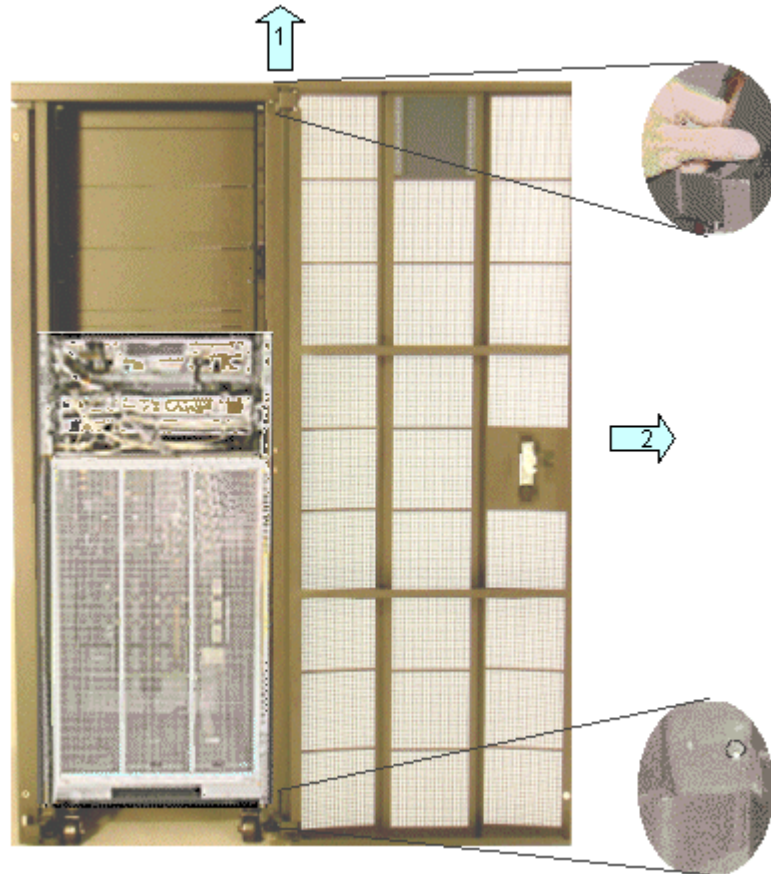

Figure 6. Removing the rear door – 36U cabinet

1. Open the rear door at an angle of 60° with the rear of the cabinet.
2. Push the tab at the top of the door upwards to release from the top hinge.
3. Gently disengage the top of the door from the top hinge.
4. Grip either side of the door and lift to remove from the hinges (1).
5. Pull the door away from the rear of the cabinet (2) and store in a safe place.

Removing Side Covers

Tools Required:

- None



Figure 7. Removing side covers – 36U cabinet

1. Open the rear and front doors.
2. Firmly grip both sides of the side cover.
3. Pull slightly forward (1) and lift to release the side cover from the cabinet fittings (2).
4. Store in a safe place.

Installing the 36U Cabinet Unloading Rail / Ramp Assembly

Tools Required:

- 17 mm hex wrench

1. Remove the rail fixtures from their packing.



Figure 8. Rail / ramp assembly – 36U cabinet

2. Assemble the two rails and tighten the four bolts with the 17 mm hex wrench (A).
3. Insert the pin at the top of each rail into the small holes on both sides of the pallet (B).
4. Insert the pin at the bottom of each rail into the small holes on both sides of the ramp (C).

5. Manually check that the pallet / rail / ramp assembly is secure.

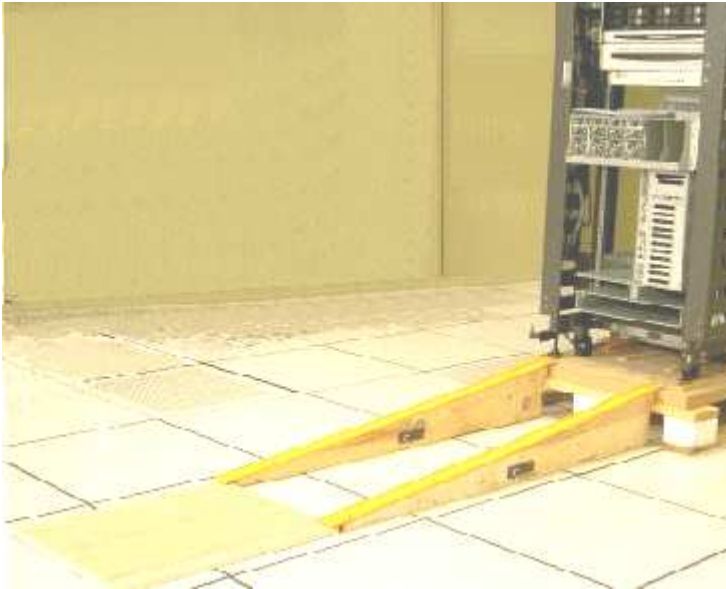

Figure 9. Assembling / installing unloading rails – 36U cabinet

6. Repeat Steps 1 to 5 for each server cabinet.

Removing the 36U Cabinet Shipping Brackets

Yellow shipping brackets are used to secure cabinet flanges to the pallet during transport. These brackets must be removed before unloading the cabinet.

Tools Required:

- 27 mm hex wrench
- 17 mm hex wrench

1. Lower the four jacking screws with the 27 mm hex wrench.



Figure 10. Lowering cabinet jacking screws – 36U cabinet

2. Use the 17 mm hex wrench to loosen the shipping brackets on either side of the cabinet.
3. Disengage the left shipping bracket from the cabinet by pushing firmly forwards.

4. Remove the left shipping bracket and store in a safe place.

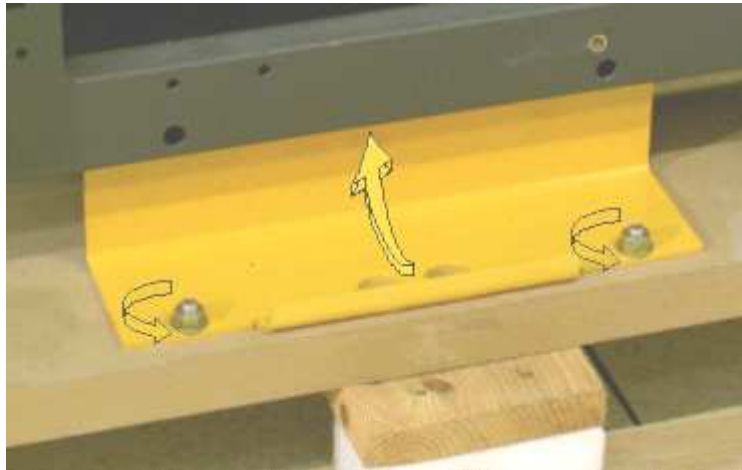

Figure 11. Removing cabinet shipping brackets – 36U cabinet

5. Repeat steps 3 and 4 for the right shipping bracket.
6. Position the four cabinet wheels so that they are facing the rear of the cabinet.



Figure 12. Positioning cabinet wheels – 36U cabinet

7. Raise the four jacking screws with the 27 mm hex wrench.

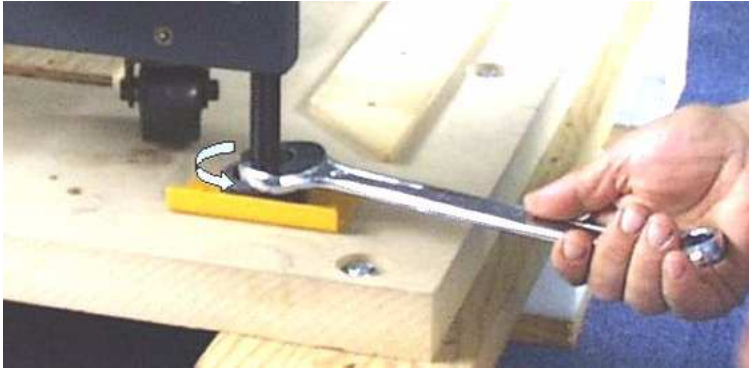

Figure 13. Cabinet jacking screws and retaining brackets – 36U cabinet

8. Carefully unload the cabinet from the pallet by rolling it slowly down the rail / ramp assembly.



Figure 14. Unloading the 36U cabinet

9. Roll the cabinet to the location indicated on the Customer's floor plan.
10. Repeat Steps 1 to 9 for each server cabinet.

Storing Packing Items

All packing items are to be stored in an ancillary room for re-use in the event of relocation or shipping.

Before proceeding to set up the server, clear and clean the installation area.

Installing and the Securing the 36U Cabinet



Important:

The front door opens flush with the front of the cabinet (180° opening angle) and may be fitted on either side of the cabinet frame, according to site requirements. Full access to the cabinet is mandatory for maintenance. Customers are advised to plan ahead and to provide space for extensions.

Tools Required:

- 27 mm hex wrench
 - 8 mm hex wrench
1. Check required service clearance at the rear, front and sides of the server.
For further information, refer to the *Site Preparation Guide*.

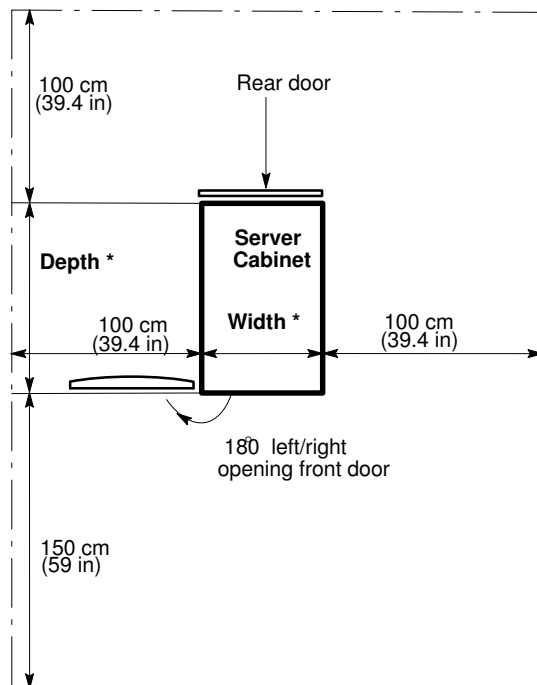

Server	Width *	Depth *
NovaScale 6xx0 Servers	65 cm (25.6 in)	113 cm (44.5 in)

Figure 15. Single cabinet service clearance – 36U cabinet

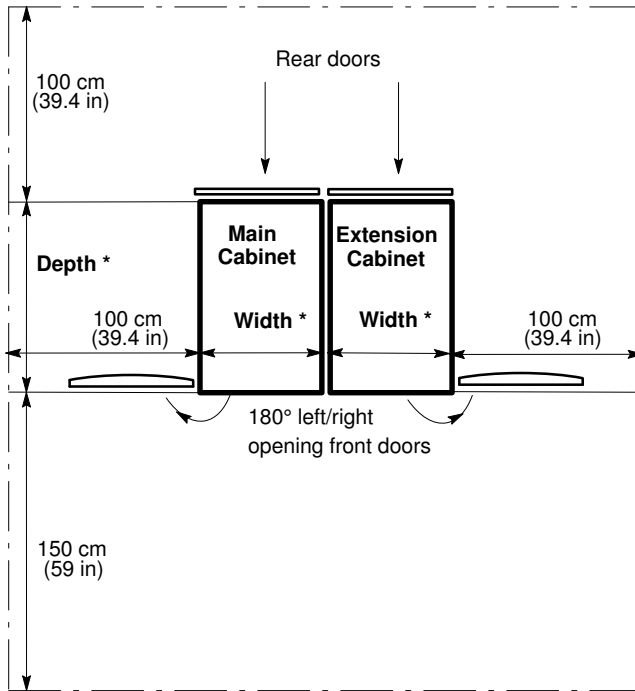

Server	Width *	Depth *
NovaScale 6xx0 Servers	65 cm (25.6 in)	113 cm (44.5 in)

Figure 16. Dual cabinet service clearance – 36U cabinet



Important:

It is mandatory for the extension cabinet to be placed to the right of the main cabinet. The extension cabinet is installed and secured in the same way as the main cabinet.

2. Take care to leave sufficient access to raised floor cable cut-outs.

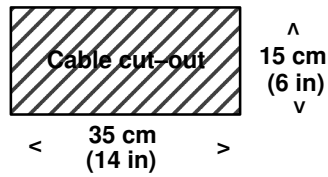

Server	Cable cut-out
NovaScale 6xx0 Servers	Front (main cabinet) Rear (I/O cabinet)

Figure 17. Cabinet cable cut-outs – 36U cabinet

3. Lower the four jacking screws with the 27 mm hex wrench and lock firmly into place to secure the cabinet.

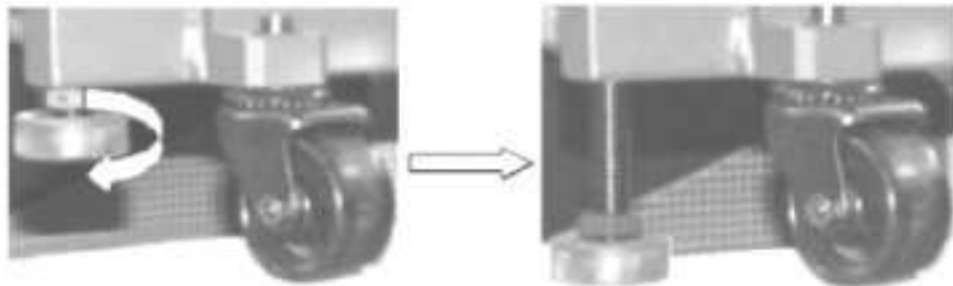

Figure 18. Locking jacking screws – 36U cabinet

4. Check cabinet stability and horizontality.
5. Repeat Steps 1 to 4 for each server cabinet.



DANGER

The cabinet is extremely heavy. It is mandatory for cabinet jacking screws to be locked safely into place before use or maintenance. Incorrect installation may result in serious personal injury or damage to components.

Removing CSS Module Shipping Brackets

Each Bull NovaScale Server CSS module is equipped with five yellow shipping brackets at the rear of the standard 36U cabinet. Once the server has been installed and correctly secured, all shipping brackets must be removed.

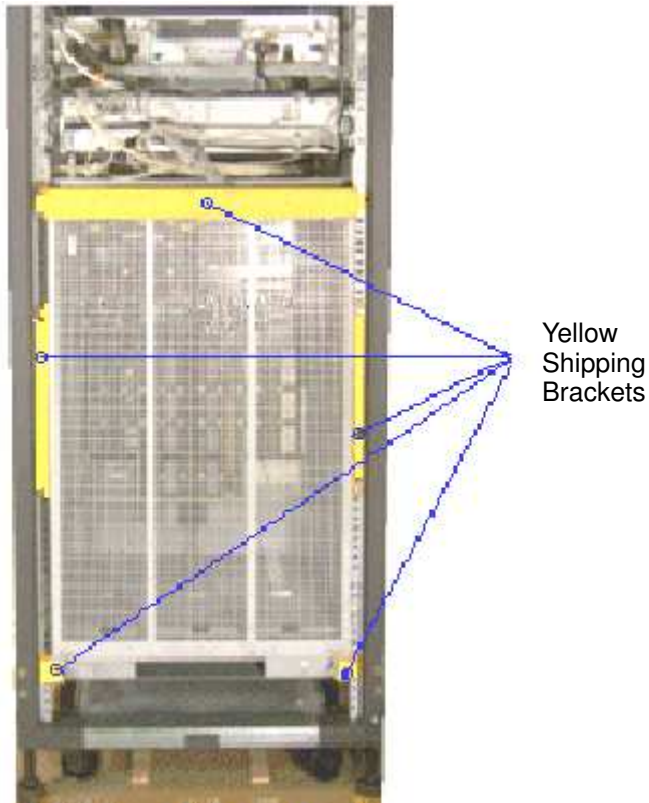

Figure 19. Removing CSS module shipping brackets – rear – 36U cabinet

1. Loosen and remove the 4 shipping brackets on either side of the CSS module / cabinet with the 8 mm hex wrench.
2. Loosen and remove the horizontal shipping bracket above the CSS module. The cable retaining plate is no longer secured to the cabinet.
3. Use the 4 bolts from the horizontal shipping bracket to re-secure the cable retaining plate to the cabinet.



Important:

Take care to store shipping brackets and fittings with other packing items.

Inspecting Internal Components and Cabling

The server is delivered pre-tested and ready for use.

A general preliminary visual inspection was carried out before unloading the server. Now that the server has been secured into place in the Computer Room, a thorough visual inspection of internal components and cabling should be carried out before refitting side covers and doors.



CAUTION:

If the inspection indicates an unacceptable safety condition, the condition must be corrected before powering up the server.

1. Visually check internal cables for damage.
2. Visually check system components for damage.
3. Manually check internal cable connections.
4. Visually check external power cables for damage.



Note:

If you need to check CSS Module components, refer to the *Maintenance and Service Guide*.

For guidance with cabling, see Appendix C. *Cabling Diagrams*, on page C-1.

Refitting Doors and Side Covers

Once the inspection is complete, doors and side covers must be refitted before powering up the server.

Refitting the Front Door

Tools Required:

- Cabinet key

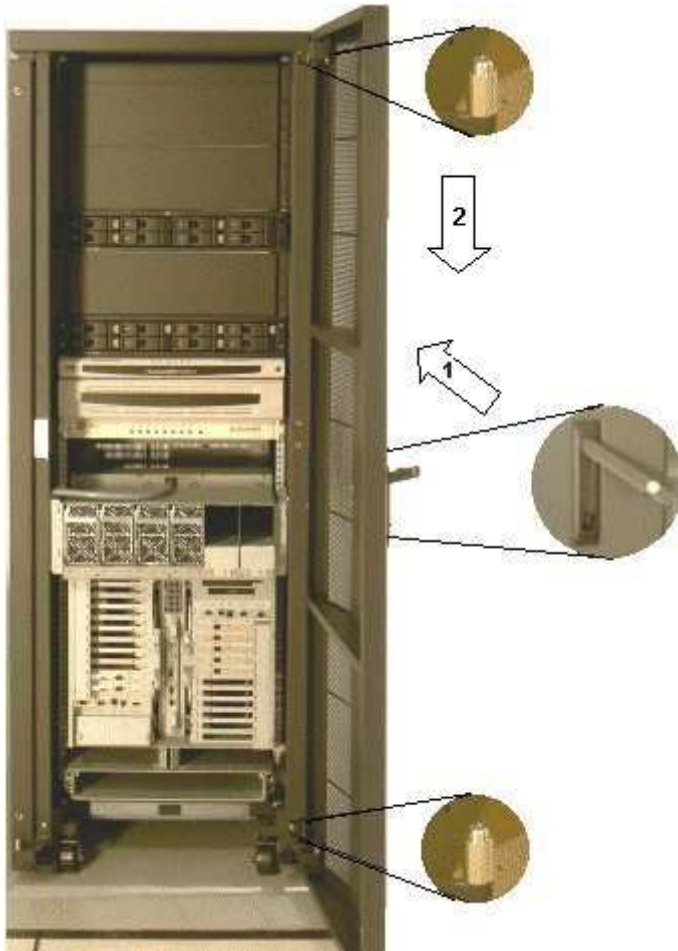

Figure 20. Refitting the front door – 36U cabinet

1. Firmly grip either side of the door and place at a right angle with the front of the cabinet.
2. Carefully lower the door onto the cabinet hinges.
3. Close the door and engage the lock by lowering the handle and pushing it back into the recess.
4. Lock the front door with the key.

Refitting the Rear Door

Tools Required:

- None

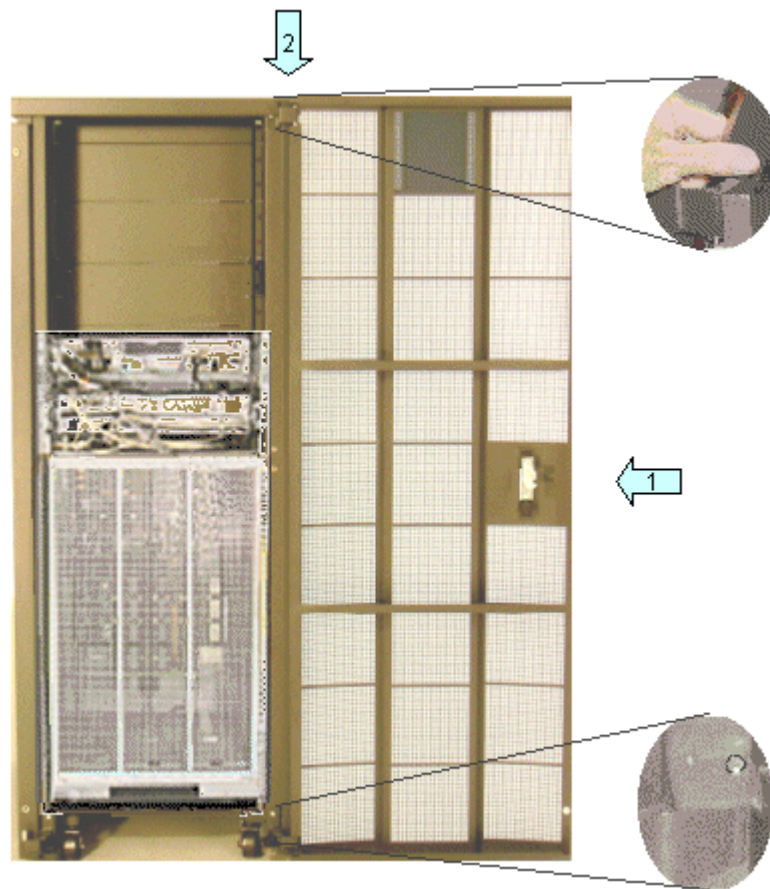

Figure 21. Refitting the rear door – 36U cabinet

1. Firmly grip either side of the door and hook carefully onto the bottom hinge.
2. Push the tab at the top of the door upwards and pull the door onto the top hinge.
3. Ease the tab at the top of the door back into place and close the door.

Refitting Side Covers

Tools Required:

- None



Figure 22. Refitting side covers – 36U cabinet

1. Firmly grip both sides of the side cover.
2. Carefully hook the side cover onto the cabinet fittings (1) and lower into place (2).
3. Close the rear and front doors.

Getting to Know the Server



Note:

Abbreviations and acronyms are documented in the *Glossary*.

NovaScale 6080 Server

The server is delivered rack-mounted and pre-cabled in a high cabinet, containing the following components:

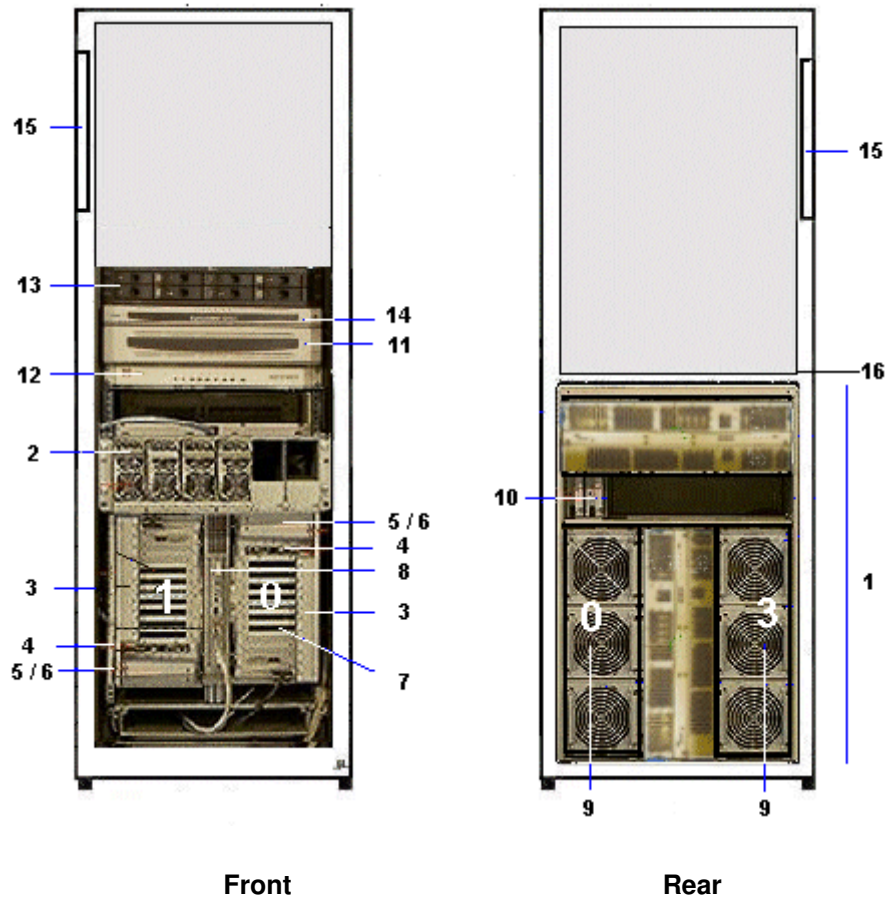

1	CSS module with midplane, redundant power supply and AC power cable		11	Console drawer with monitor, keyboard and mouse	
	2	DPS units	12	KVM switch	
	3	2 IOB (s) with:		13	1 or two SCSI or FC disk rack(s) with RAID controller(s) and disks
		4	IOR	14	PAP unit with CD-ROM drive, FDD and disk(s)
	5	2 USB ports	15	PDU with AC power cable	
	6	DVD / CD-ROM drive	16	Hub with power bar	
	7	PCI hot plug board (11 slots)	NovaScale 6080 configuration: – QBB #0 and QBB #3 See <i>Glossary</i> for abbreviations and acronyms.		
	8	PMB			
	9	2 QBBs with fan boxes			
	10	SPS fan boxes			

Figure 23. NovaScale 6080 Server components (example)

NovaScale 6160 Server

The server is delivered rack-mounted and pre-cabled in a high cabinet, containing the following components:

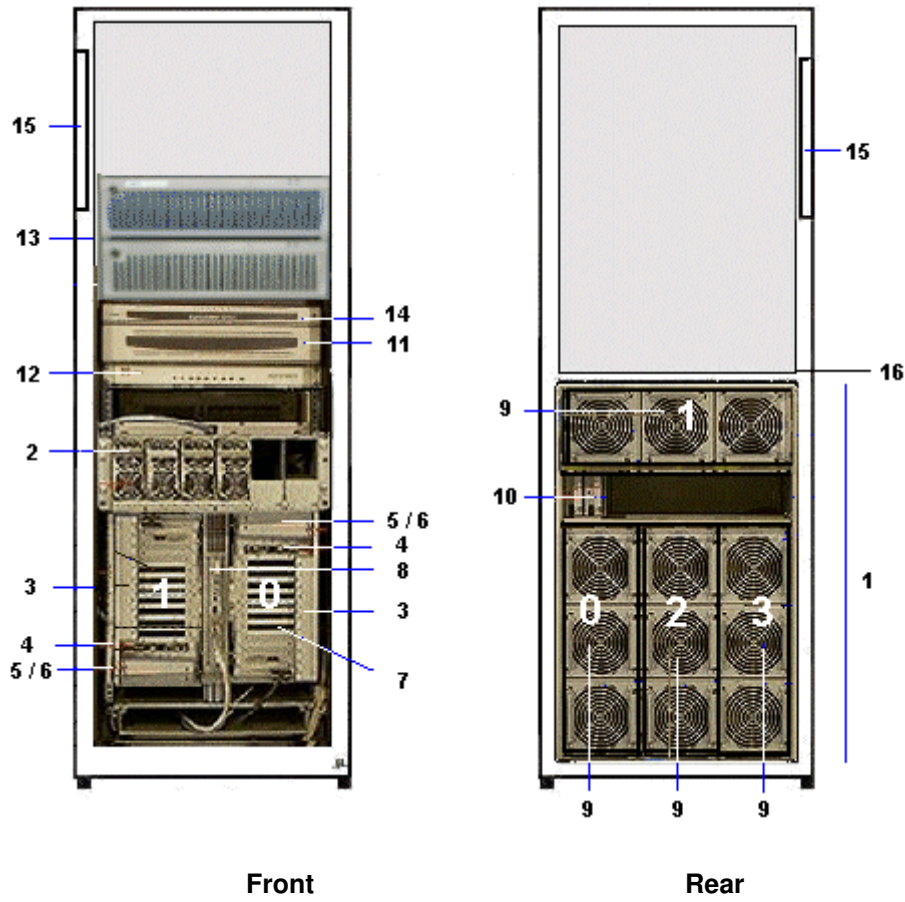

1	CSS module with midplane, redundant power supply and AC power cable	11	Console drawer with monitor, keyboard and mouse
2	DPS units	12	KVM switch
3	2 IOB (s) with:	13	1 or two SCSI or FC disk rack(s) with RAID controller(s) and disks
4	IOR	14	PAP unit with CD-ROM drive, FDD and disk(s)
5	2 USB ports	15	PDU with AC power cable
6	DVD / CD-ROM drive	16	Hub with power bar
7	PCI hot plug board (11 slots)	NovaScale 6160 configuration: – QBB #0, QBB #1, QBB #2, and QBB #3	
8	PMB	See <i>Glossary</i> for abbreviations and acronyms.	
9	4 QBBs with fan boxes		
10	SPS fan boxes		

Figure 24. NovaScale 6160 Server components (example)

NovaScale 6320 Server

The server is delivered rack-mounted and pre-cabled in two high cabinets, a Main Cabinet and an I/O Cabinet.

Main Cabinet

The main cabinet contains the following components:

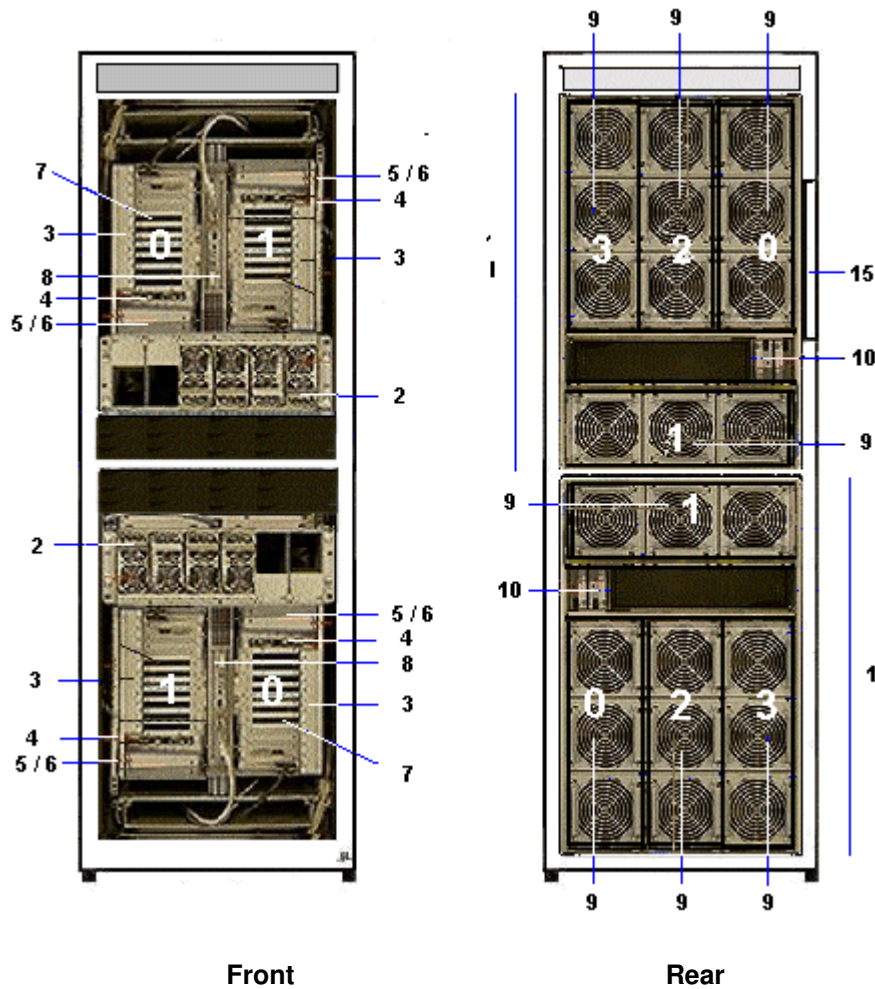

1	2	2 CSS modules, each with midplane, redundant power supply and AC power cable	8	PMB
	2	DPS units	9	1 to 4 QBBs with fan boxes
	3	1 or 2 IOB (s) with:	10	SPS fan boxes
		4	IOR	15
	5	2 USB ports	NovaScale 53206320 configuration: – QBB #0, QBB #1, QBB #2, and QBB #3 Module 0 – QBB #0, QBB #1, QBB #2, and QBB #3 Module 1 See <i>Glossary</i> for abbreviations and acronyms.	
	6	DVD / CD-ROM drive		
	7	PCI hot plug board (11 slots)		

Figure 25. NovaScale 6320 Server main cabinet components (example)

I/O Cabinet

The I/O cabinet contains the following components:

I/O cabinet with SCSI disks

I/O cabinet with FC disks

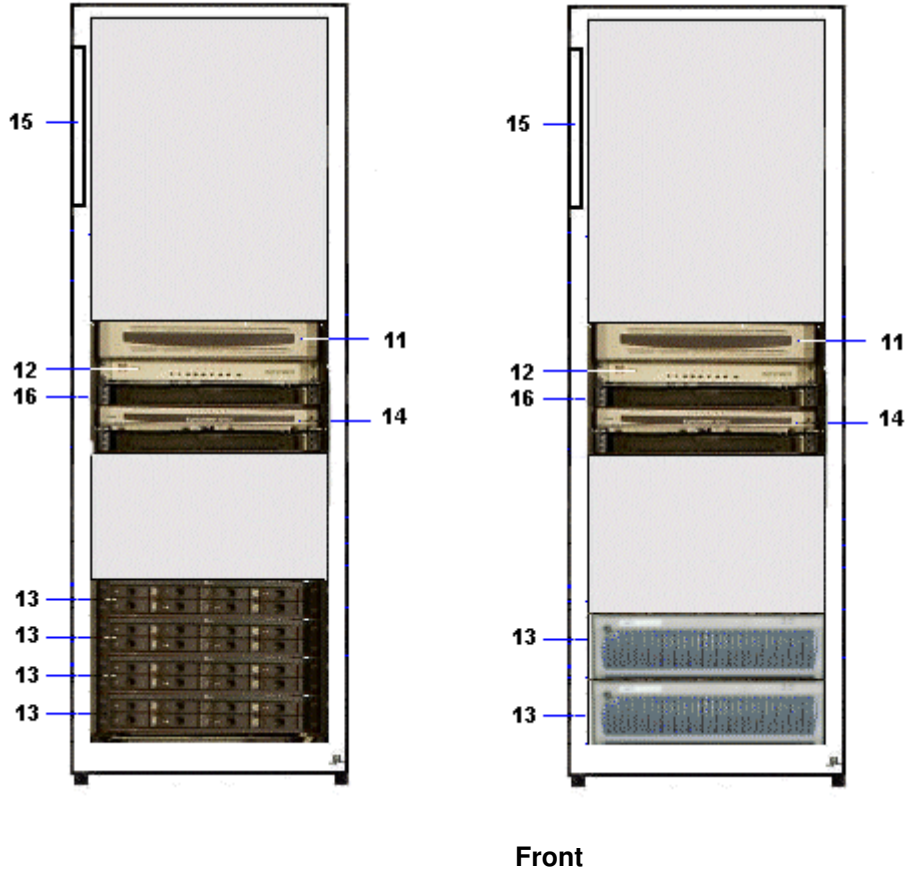

11	Console drawer with monitor, keyboard and mouse
12	KVM switch
13	1 up to 4 SCSI disk rack(s) with RAID controller(s) and disks, or 1 or two FC disk rack(s) with RAID controller(s) and disks
14	PAP unit with CD-ROM drive, FDD and disk(s)
15	PDU with AC power cable
16	Hub with power bar

Figure 26. NovaScale 6320 Server I/O cabinet components (examples)

Server Components

Central Subsystem (CSS) Module

The CSS Module houses core hardware components.

NovaScale 6080/6160 Server

The server is equipped with one CSS module, located at the bottom of the cabinet.

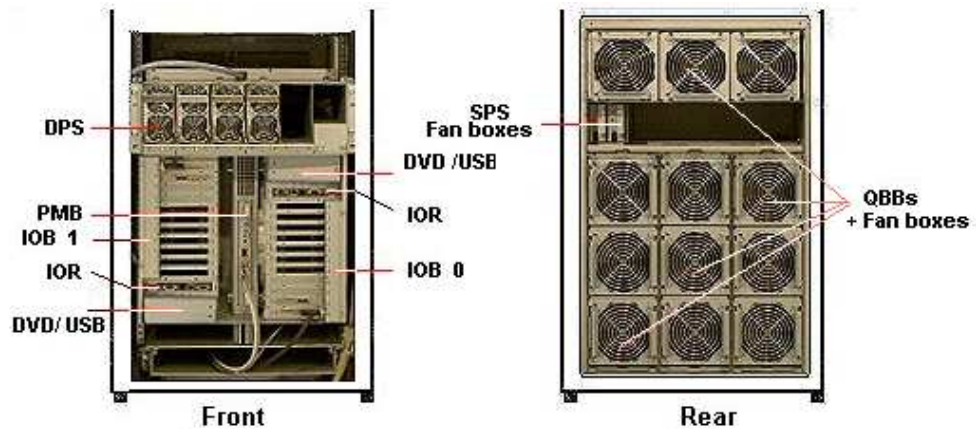

1 MidPlane (MP)

This active board is used to interconnect the QBBs, IOBs and the PMB.

2 SPS fan boxes

Each Midplane is equipped with two redundant fan boxes for cooling.

1, 2, 3 or 4 QBB (Quad Brick Board) subsets:

Each QBB subset houses:

- 1 mother board
- 2 memory boards
- 4 processors
- 16 DIMMs

1, 2, 3 or 4 QBB fan boxes:

Each QBB subset is equipped with a fan box for cooling.

2 IOBs (Input / Output Box):

Each IOB box houses:

- 1 IOB (Input / Output Board)
- 1 PHPB (PCI Hot Plug Board)
- 11 hot-plug PCI-X (100–133 MHz) slots with optional:
 - 1 SCSI HBA
 - 1 PCI SCSI card
 - 1 PCI FC card
 - 1 PCI Giga Ethernet card
 - 8 free slots
- 1 IOR (Input / Output Riser):
 - 2 A-type USB ports
- 1 RJ45 10/100 Mbps Ethernet port
 - 2 DB9–M RS232 serial ports
 - 1 HD15–F VGA port
- 1 DVD/CD–ROM drive
- 1 LS240 drive (optional)

Each IOB is cooled by the corresponding QBB fan box.

1 PMB (Platform Management Board):

This active board links the server to the Platform Administration Processor (PAP) Unit (via an Ethernet link).

Figure 27. NovaScale 5080/5160 ServerNovaScale 6080/6160 Server CSS module features

NovaScale 6320 Server

The server is equipped with two CSS modules, located at the top and bottom of the main cabinet.

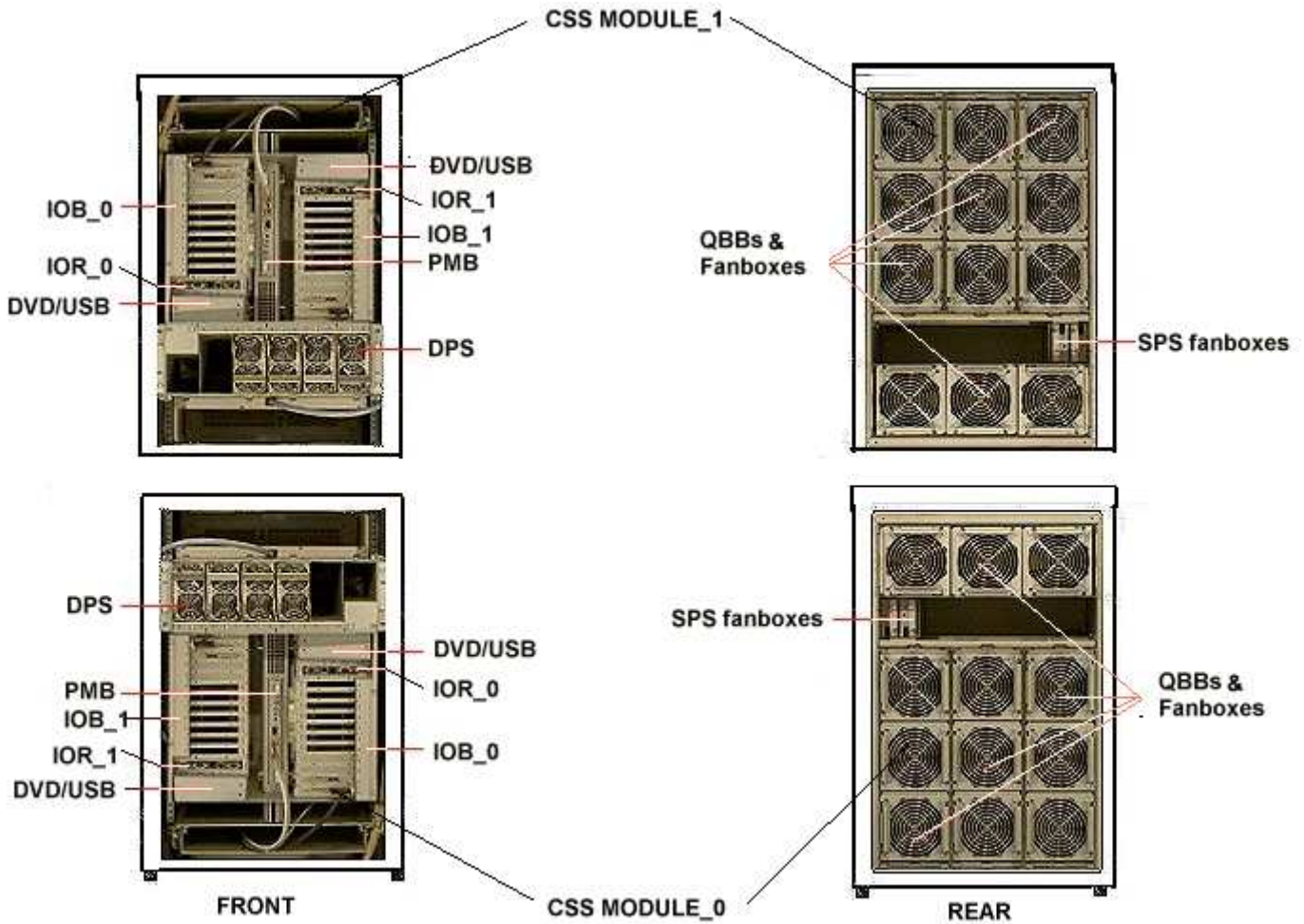

1 MidPlane (MP) 2 SPS fan boxes
1, 2, 3 or 4 QBB (Quad Brick Board) subsets 1, 2, 3 or 4 QBB fan boxes
1 or 2 IOBs (Input / Output Box)
1 PMB (Platform Management Board)

Figure 28. NovaScale 6320 Server CSS module features



Note:

See Figure 27 for details.

Integrated Platform Administration Processor (PAP) Unit

The PAP unit is linked to the server via the Platform Management Board (PMB). It hosts Platform Administration Software (PAM). According to version, the PAP unit is located in the center of a high cabinet or at the top of a low cabinet.



Or

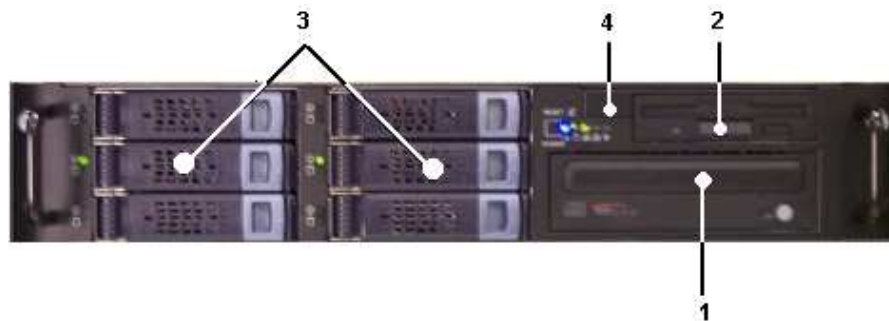

PAP Unit 1U	PAP Unit 2U
<ul style="list-style-type: none"> • 1 PIII / 1 GHz PC – 512 Mb RAM – 2 x 36 Gb disks (soft mirrored) (3) – 1 free disk slot (4) – 1 CD/DVD-ROM drive (1) – 1 FDD(2) – 2 serial ports – 2 PCI slots – 2 Ethernet ports (1 free) 	<ul style="list-style-type: none"> • 1 P4SCi / 2.6 GHz PC – 2 x 512 Mb RAM – 2 x 80 Gb disks (RAID) (3) – 4 free disk slots – 1 CD/DVD-ROM drive (1) – 1 FDD (2) – 2 serial ports – 3 PCI slots – 2 x 1 Gb Ethernet ports (1 free) – 4 USB ports (2 front (4)+ 2 rear))
<ul style="list-style-type: none"> • Microsoft Windows operating system • Internet Explorer software • PAM software • 1 power cable 	

Figure 29. PAP unit

Integrated Console

According to version, the integrated console is located in the center of a high cabinet or at the top of a low cabinet.

Slideaway Console

The Slideaway Console contains the keyboard, monitor and touch pad used for local access to the server and to the Platform Administration Processor (PAP) Unit.

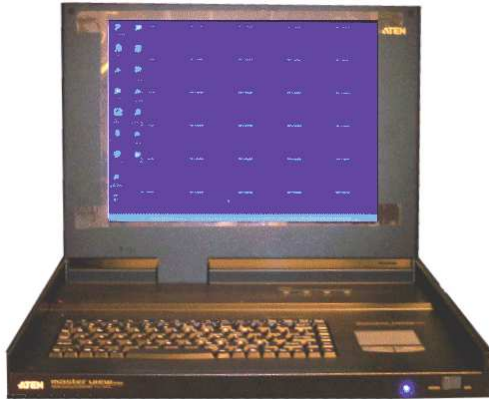

- 1 monitor
- 1 QWERTY keyboard and touch pad
- 1 power cable

Figure 30. Slideaway Console features

Console Drawer

The Console Drawer contains the keyboard, monitor and mouse used for local access to the server and to the Platform Administration Processor (PAP) Unit.



- 1 pull-out table top
- 1 monitor
- 1 QWERTY keyboard and mouse kit
- 1 power cable

Figure 31. Console drawer features

Keyboard / Video / Mouse (KVM) Switch

The KVM Switch allows the use of the integrated console for the local server and the local Platform Administration and Maintenance console.

8–Port KVM Switch

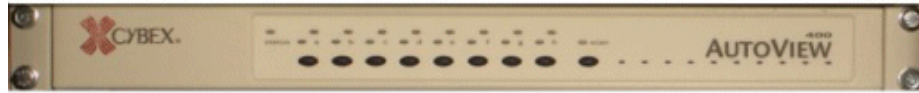

Or



- 8 ports
- 1 power cable

Figure 32. KVM switch features

16–Port KVM Switch



- 16 ports
- 1 power cable

Figure 33. KVM switch features

SR-0812 SCSI RAID Disk Rack

The SR-0812 SCSI RAID Disk Rack is delivered with three system disks (two RAID#1 and one spare disk per domain) and offers five empty slots for Customer data disks. One SR-0812 SCSI RAID Disk Rack is delivered per domain. According to version, the Disk Rack is located in the main or I/O cabinet.

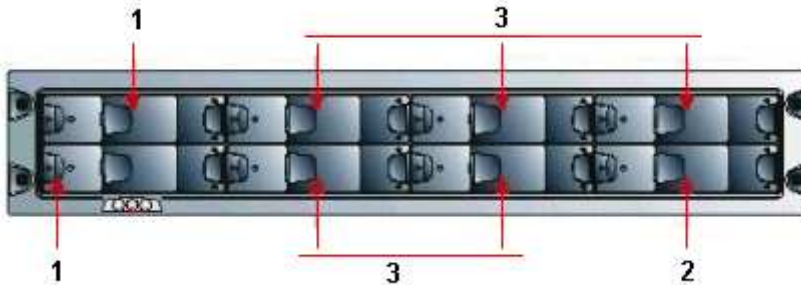

- 1 OS disks
- 2 Spare disks
- 3 Optional data disks

- 8 slots
- 1 RAID controller card
- 6 disks (3 per domain: 2 RAID#1 + 1 spare)
- 2 power cables (redundant power supply)

Figure 34. SR-0812 SCSI RAID disk rack features

SJ-0812 SCSI JBOD Disk Rack

The SJ-0812 SCSI JBOD Disk Rack is delivered with six system disks (two RAID#1 and one spare disk per domain) and offers two empty slots for Customer data disks. According to version, the Disk Rack is located in the main or I/O cabinet.

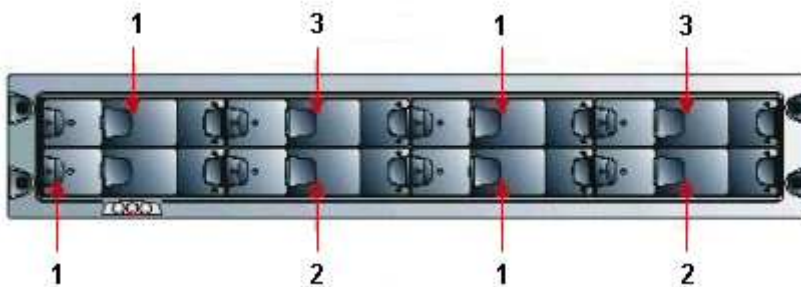

- 1 OS disks
- 2 Spare disks
- 3 Optional data disks

- 8 slots
- 6 disks (3 per domain: 2 RAID#1 + 1 spare)
- 2 power cables (redundant power supply)

Figure 35. SJ-0812 SCSI JBOD disk rack features

SJ-0812 SCSI JBOD Extension Disk Rack

The SJ-0812 SCSI JBOD Extension Disk Rack offers eight empty slots for Customer data disks. The Extension Disk Rack is located in the center of the cabinet, above the Main Disk Rack. According to version, the Extension Disk Rack is located in the main or I/O cabinet.

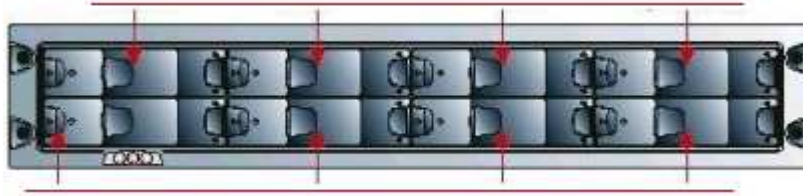

- 8 slots
- 2 power cables (redundant power supply)

Figure 36. SJ-0812 SCSI JBOD extension disk rack features

FDA 1300 FC Disk Rack

The FDA 1300 FC Disk Rack is delivered with six system disks (two RAID#1 and one spare disk per domain) and offers nine empty slots for Customer data disks. According to version, the Disk Rack is located in the main or I/O cabinet.

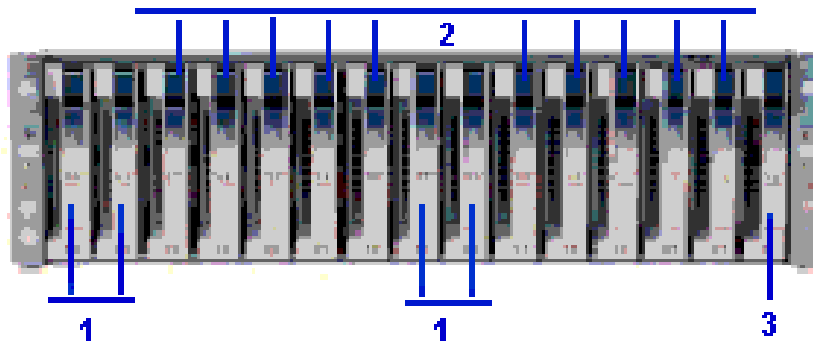

- 1 OS disks
- 2 Optional data disks
- 3 Spare disk

- 15 slots
- 2 FC RAID controller cards, 1 FC port per controller
- 3 disks (2 RAID#1 + 1 spare)
- 6 disks (3 per domain: 2 RAID#1 + 1 spare)
- 2 power cables (redundant power supply)

Figure 37. FDA 1300 FC disk rack features

FDA 2300 FC Disk Rack

The FDA 2300 FC Disk Rack is delivered with three system disks (two RAID#1 and one spare disks) and offers 12 empty slots for Customer data disks. According to version, the Controller Unit and Disk Unit are located in the main or I/O cabinet.

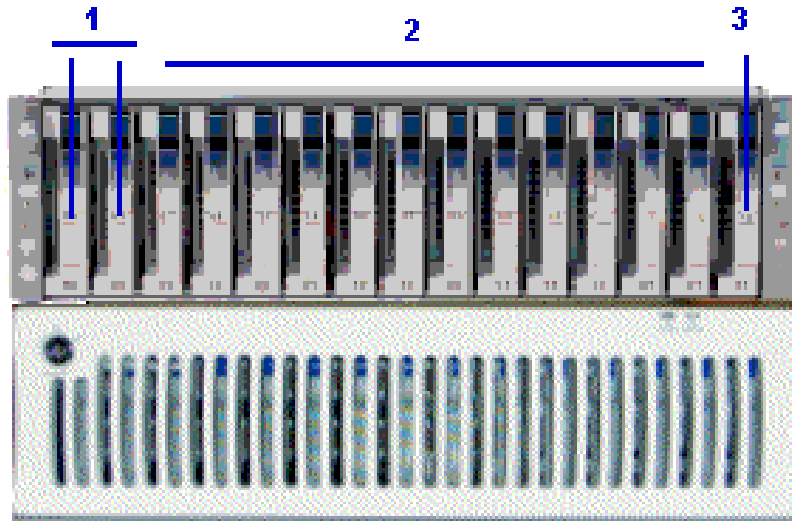

- 1 OS disks
- 2 Optional data disks
- 3 Spare disk

- 1 controller unit & 1 disk unit
- 15 slots
- 2 FC RAID controller cards, 2 FC ports per controller
- 3 disks (configuration: 2 in RAID#1 + 1 spare)
- 2 power cables (redundant power supply)

Figure 38. FDA 2300 FC disk rack features

FDA 1300 FC Extension Disk Rack

The FDA 1300 FC Extension Disk Rack offers 15 empty slots for Customer data disks. The Extension Disk Rack is located in the center of the cabinet, above the Main Disk Rack. The Disk Rack is located in the center of the cabinet, above the PAP Unit. According to version, the Disk Rack is located in the main or I/O cabinet.



- 15 slots
- 2 power cables (redundant power supply)

Figure 39. FDA 1300 FC extension disk rack features

Ethernet Hub

The optional Maintenance LAN Ethernet Hub is used to connect PMB, PAP Unit and external FDA FC Disk Rack Ethernet ports.



Ethernet Hub	<ul style="list-style-type: none">- 8 ports- 1 power cable- 1 power bar
--------------	---

Figure 40. Ethernet hub features

USB Modem

The optional USB modem is used to transmit Autocalls to the Remote Maintenance Center, if the Customer's maintenance contract includes the Autocall feature.



USB Modem	<ul style="list-style-type: none">- 1 USB cable- 1 RJ11 cable
-----------	--

Figure 41. USB modem features

Power Distribution Unit (PDU)

The PDU supplies mains power to the PAP unit, the external Disk Rack, the KVM Switch, the Integrated Console, and the Ethernet Hub. When the server is equipped with an FDA 1300 FC or an FDA 2300 FC, the PDU also supplies mains power to the Power Bar. The PDU is located in the top left part of the cabinet. According to version, the PDU is located in the top left part of the main or I/O cabinet.



Front Rear

- 6 (8A) sockets (front):
- 2 (1A) sockets (rear):
- 1 (20A) power cable

Figure 42. PDU features

Chapter 2. Setup Procedure

This chapter explains the procedures required to set up and start the server for the first time. It includes the following topics:

- Accessing Server Components, on page 2-2
- Checking PMB Code Wheels, on page 2-7
- Checking Server Cabling and Connecting Inter-Cabinet Cables, on page 2-7
- Mounting Power Supply Cable Sockets, on page 2-11
- Connecting the Server to the Site Power Supply, on page 2-14
- Launching PAM Software, on page 2-15
- Checking Server Status via PAM, on page 2-18
- Toggling the Local / Integrated Console Display, on page 2-20
- Powering Up / Down Server Domains, on page 2-20
- Completing PAP Unit Configuration, on page 2-29
- Configuring Customer Information, on page 2-31
- Configuring Autocalls, on page 2-32
- Changing the iStorage Manager User Name and Password, on page 2-34
- Connecting the PAP Unit to the Customer's Enterprise LAN, on page 2-35
- Connecting to the PAM Web Site from a Remote Computer/Workstation, on page 2-36
- Enabling Remote Access to iSM on the Client Computer, on page 2-36
- Completing Operating System Setup, on page 2-38
- Connecting the Server to the Enterprise LAN, on page 2-50
- Connecting External Devices, on page 2-51
- Testing Network Connections, on page 2-52
- Testing Autocalls, on page 2-52
- Completing the PAM Installation Intervention Report, on page 2-52
- Renaming the Central Subsystem, on page 2-53
- Setting up PAP Unit Users, on page 2-61
- Backing Up / Restoring PAM Configuration Data, on page 2-63

Accessing Server Components

Opening the Front Door

Tools Required:

- Cabinet key

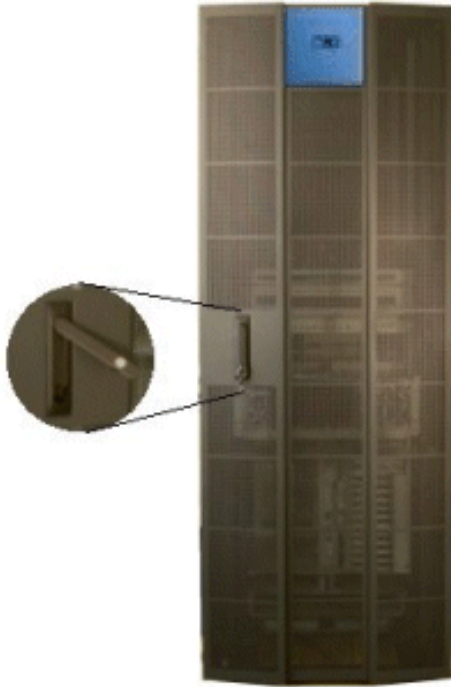

Figure 43. Opening the front door

1. Unlock the front door with the key.
2. Pull out the locking mechanism and turn to open.
3. Open the door as required (90° / 180°).

Closing the Front Door

1. Close the door.
2. Turn the locking mechanism to close and push back into place.
3. Lock the front door with the key.

Opening / Closing the Slideaway Console

The server is equipped with an integrated console for local administration and maintenance operations.



Figure 44. Slideaway console

To open the slideaway console:

1. Slide the console forward until it clicks into place.
2. Use the front bar to lift the screen panel into position.

To close the slideaway console:

1. Press the 2 buttons marked PUSH on either side of the keyboard panel to release the console.
2. Lower the front bar to close the screen panel.
3. Slide the console back into the cabinet.

Setting up the Console Drawer

The server is equipped with an integrated console for local administration and maintenance operations. This console will be required during the installation procedure to configure the server and to check operational status. To set up the system console, proceed as follows:

1. Pull out the console drawer and lower the magnetic front flap.



Figure 45. Lowering the console drawer flap

2. Pull on the tab to extend the mouse tray.



Figure 46. Extending the mouse tray

3. Manually position the monitor and check that the vacation switch on the right-hand side of the monitor is ON.



Figure 47. Positioning the monitor

4. Install the mouse on the extendable tray, ready for use.



Figure 48. Console ready for use



Important:

The keyboard and mouse connectors, fitted to the rear of the console drawer with velcro retainers, may become loose during shipping. Once the monitor is positioned, manually check keyboard and mouse cable connections.

Closing the Console Drawer

1. Replace the mouse on the pad inside the drawer and push on the tab to replace the mouse tray in its housing.
2. Raise the magnetic front flap.
3. Manually lower the monitor.
4. Press firmly on the tabs on each side of the drawer and push the drawer back into the cabinet.



(1) Tab (1 on each side of the drawer)

Figure 49. Closing the console drawer

Accessing the PAP Unit CD–Rom and Diskette Drives

Tools Required:

- PAP unit key

The PAP unit CD–Rom and diskette drives are located behind the front bezel. To access the CD–Rom and/or diskette drives, unlock the front bezel with the PAP unit key and remove.



Figure 50. PAP Unit CD–Rom and Diskette Drives

Checking PMB Code Wheels

The Platform Management Board (PMB) links the server to the PAP unit, which displays server status data on the console monitor. The PMB is equipped with two code wheels used to indicate the server cabinet number and the CSS module number. These code wheels are set prior to shipping (factory default setting), according to the configuration ordered.

Configuration	Cabinet Hexadecimal Code (0 to F)	CSS Module Hexadecimal Code (0 to F)
NovaScale 6080/6160 Server	0	0
NovaScale 6320 Server	0	0 (module 0) 1 (module 1)

Table 1. PMB code wheel settings – default single server configuration



Important:

Code wheels may change position during shipping. Check code wheel position before powering up the system.

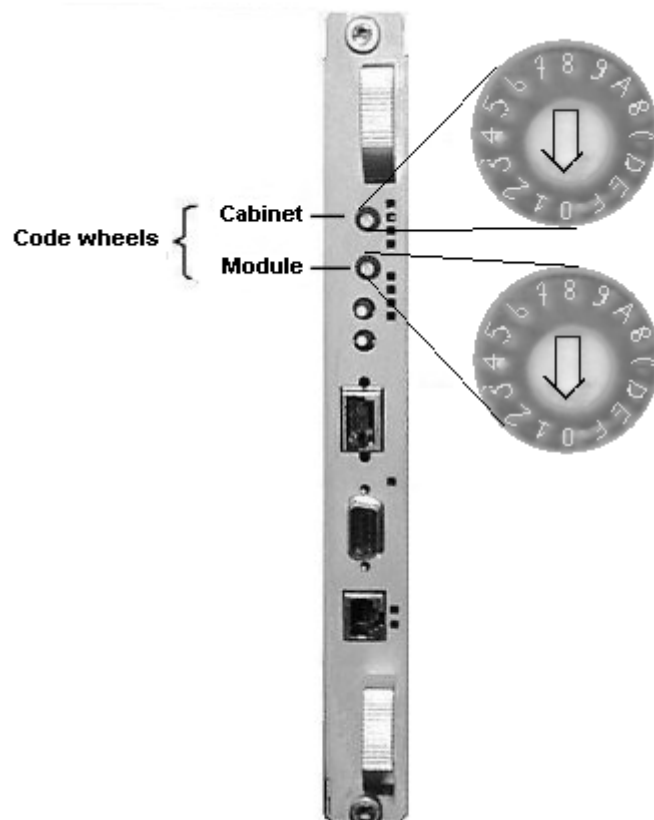

Figure 51. PMB code wheels

Extended and Cluster Systems

Up to 16 CSS modules can be linked, via a PMB to the PAP unit. PMB code wheels allow the identification of each cabinet and each CSS module in the Customer's configuration.

Example of PMB code wheel settings for a system with 3 cabinets, each containing 2 modules:

	Cabinet 1	Cabinet 2	Cabinet 3
Cabinet Hexadecimal Code (0 to F)	0	1	2
CSS Module_0 Hexadecimal Code (0 to F)	0	0	0
CSS Module_1 Hexadecimal Code (0 to F)	1	1	1
CSS Module_2 Hexadecimal Code (0 to F)	2	2	2

Table 2. PMB code wheel settings – multiple server configuration example

Checking Server Cabling and Connecting Inter-Cabinet Cables



Important:

Cables to external peripherals must NOT be connected before powering up the server for the first time.

These cables must only be connected once server operation has been checked.

All internal cabinet cables are pre-connected before shipping. However, cables may become loose during shipping and you are advised to check for loose cables before powering up the server. See *Cabling Diagrams*, on page C-1 for details. See *Cabling Diagrams*, on page 0 for details.

Connecting NovaScale 6320 Server Inter-Cabinet Data Cables

Once you have checked for loose cables, you can proceed to connect the following inter-cabinet data cables:

- PMB – Ethernet hub data cables, see details on page C-40
- IOR – 16-port KVM switch data cables, see details on page C-41
- IOB HBA – SR-0812 SCSI RAID disk rack data cables, see details on page C-43
- IOB HBA RAID – SJ-0812 SCSI JBOD disk rack data cables, see details on page C-42
- IOB HBA – FDA 1300 FC disk rack data cables, see details on page C-43
- IOB HBA – FDA 2300 FC disk rack data cables, see details on page C-44

These cables are already connected to the PMB, IOR, and IOB HBAs located in the main cabinet and must now be connected to the Ethernet hub, KVM switch, and disk racks in the I/O cabinet.

To connect inter-cabinet data cables:

1. Uncoil the required cable and check the “From” and “To” labels.
2. Use the corresponding cabling diagram to locate the required device port in the I/O cabinet. See *Inter-Cabinet Cabling Diagrams*, on page 0 for details.
3. Carefully guide the cable down through the right-hand cable inlet and into the cable cut-out at the base of the main cabinet.

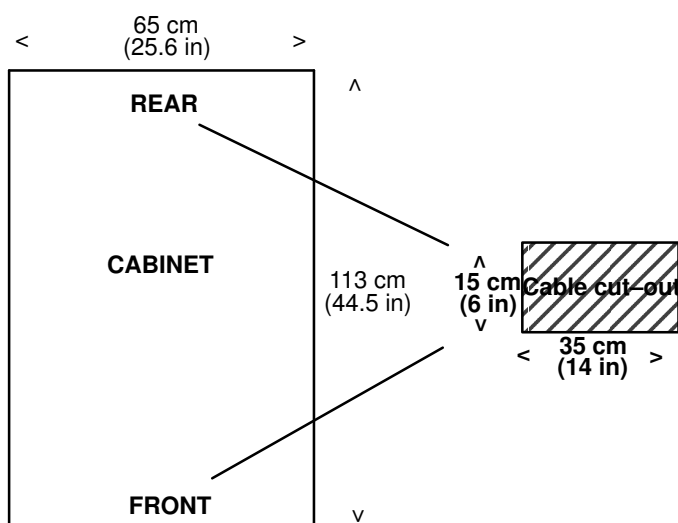

Figure 52. Cabinet cable cut-outs

4. From the plenum space, carefully guide the cable up through the cable cut-out at the base of the I/O cabinet.
5. Connect the cable to the device port.
6. Repeat Steps 1 to 5 for each inter-cabinet data cable.

For further details, see *Cabling requirements* on page 0.

Mounting Power Supply Cable Sockets



CAUTION:
To be performed by a certified electrician only.

Tools Required

- Multimeter
- Phillips screwdriver
- Velcro fasteners

Europe, Japan, Brazil

Server power cables are equipped with ready-mounted IEC309 plugs and dedicated sockets for connection to the site power supply.

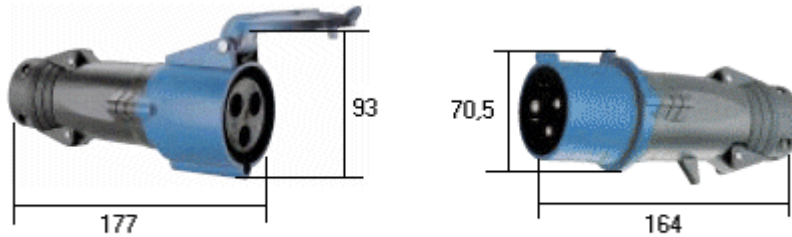

As required in the *Site Preparation Guide*, the Customer has provided the following power supply cables to the cable cut-outs at the base of the cabinet:

Server	Power Supply Cable
NovaScale 6xx0 Servers	1 x 20A power supply cable per PDU ¹ 1 x 20A power supply cable per CSS Module ²



Note:

¹ The Power Distribution Unit (PDU) cable has an extra cable length of 1.5 meters.

United States of America

Server power cables are equipped with ready-mounted NEMA L6-30P plugs. The Customer is responsible for supplying appropriate NEMA L6-30R sockets for connection to the site power supply.

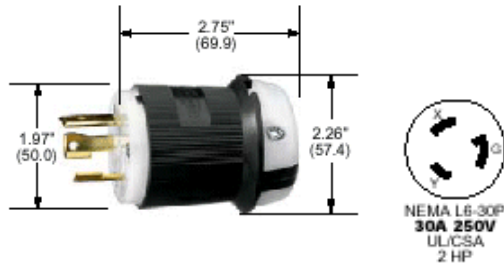

Figure 53. US plug characteristics

As required in the *Site Preparation Guide*, the Customer has provided the following power supply cables (and appropriate NEMA L6-30R sockets) to the cable cut-outs at the base of the cabinet:

Server	Power Supply Cable
NovaScale 6xx0 Servers	1 x 20A power supply cable per PDU ¹ 1 x 20A power supply cable per CSS Module ²



Note:

¹ The Power Distribution Unit (PDU) cable has an extra cable length of 1.5 meters.

PDU Power Cable Socket

1. Check that the power supply cable is not live with the multimeter.
2. Carefully guide the PDU power supply cable (cable with extra 1.5 meter length) through the left-hand cable inlet at the base of the cabinet.
3. Check that the power supply cable is long enough for connection to the PDU.
4. Remove the power socket from the PDU plug.
5. Unscrew the base of the socket (A), insert the cable through the socket base (B), and wire to the socket head, as shown in Figure 54.



Figure 54. PDU power cable socket

6. Screw the socket base back to the socket head (C).
7. Check for ≤ 0.1 ohm resistance between the grounding pin on the power cable plug and the metal frame with the multimeter.
8. Connect the power supply cable socket to the PDU power cable plug.
9. Use velcro fasteners to secure the cable into place along the cabinet frame.
10. Check that the power switches on the peripheral devices are set to ON:

Peripheral Device	Power Switch Location
KVM Switch	1 switch – rear left
PAP Unit	1 switch – front right

Connecting the Server to the Site Power Supply



Important:

Do NOT connect external data cables before powering up the server for the first time on the Customer's premises.

The Customer is responsible for ensuring that the electrical network is compliant with the standards set out in the *Site Preparation Guide*, 86 A1 87EF.



CAUTION:

Only duly certified electricians may connect the server to the power supply, under the Customer's responsibility. The server is NOT equipped with a circuit breaker. The circuit breakers referred to in this section are the SITE circuit breakers supplied by the Customer.

Safety Recommendations



DANGER

An electrical outlet that is not correctly wired could place hazardous voltage on metal parts of the server or the devices that attach to the server. It is the Customer's responsibility to ensure that the outlet is correctly wired and grounded to prevent an electrical shock.

Use one hand, when possible, to connect or disconnect signal cables to prevent a possible shock from touching two surfaces with different electrical potentials.



CAUTION:

The server is equipped with three-wire (phase/phase/ground) power cables for user safety. Use these power cables with properly grounded electrical outlets to avoid electrical shock.

- 1. The server has more than one power supply cable. Follow procedures for removal of power from the server when directed.**
- 2. Energy hazard, remove all jewelry before servicing.**
- 3. Check that the dedicated power supply circuit breakers are OFF.**

Powering Up the Server to the Standby Mode

Once the PDU cables have been connected to the power outlets at the base of the cabinet, request the Customer to turn the site power supply circuit breakers ON.

The Platform Management Board (PMB) in each CSS module automatically powers up to the standby mode (48V) and the Platform Administration Processor (PAP) unit automatically boots Microsoft Windows software. Server operation can now be checked.



Note:

It may take several seconds for something to be displayed on the monitor. If the server does not initialize to standby (48V), or if an incident occurs, see Chapter 3. *Troubleshooting*.

Checking Server Operation

Once the server has been installed and powered up, correct operation must be checked.



Important:

The server must be fully checked with factory default data.

See the *Read Me First* booklet delivered with the system 24 hours before the scheduled installation date for factory default data.

When the server check has been successfully completed, the authorized Customer Service Engineer in charge of installing the system will re-configure the system with Customer data. See *Customizing the Server* on page 0.

Launching PAM Software

The server is equipped with an integrated Platform Administration and Maintenance software package, otherwise known as PAM software.

One part of PAM software is an embedded application (MAESTRO) running on the Platform Management Boards (PMB) and the other is an external application running on the Platform Administration Processor (PAP) unit under Microsoft Windows.

You will use the secured PAM Web-based interface to operate, monitor, and configure the server.

Once the Microsoft Windows software on the PAP unit has been booted, you will be requested to supply a User Name and Password to open a Windows session. The session **MUST** be started for the first time with the following factory default User Name and Password:

User Name	Administrator
Password	administrator



Important:

The factory default User Name and Password are used by the authorized Customer Service Engineer during the setup procedure ONLY.

Factory default data must be replaced by Customer data once the system check has been successfully completed. See *Completing PAP Unit Configuration* on page 0.

To complete installation, you need to open a Customer Administrator and a Support Administrator PAM session.

To open a **Customer Administrator** PAM session:

1. From the Microsoft Windows desktop, double-click the Internet Explorer icon (<http://localhost/PAM>).
2. When prompted, request the Customer Administrator to enter the default User Name and Password:

Customer Administrator	
User Name	Administrator
Password	administrator

The PAM home page appears.



Note:

The PAM tree building process may take one to two minutes.

To open a **Support Administrator** PAM session:

1. From the Microsoft Windows desktop, double-click the Internet Explorer icon (<http://localhost/PAM>).
2. When prompted, enter the predefined User Name and Password.

The PAM Home Page appears.



Note:

If an error dialog box appears, see Chapter 3. *Troubleshooting*.

PAM User Interface

The PAM user interface is divided into three areas in the browser window: a **Status** pane, a **PAM Tree** pane, and a **Control** pane.

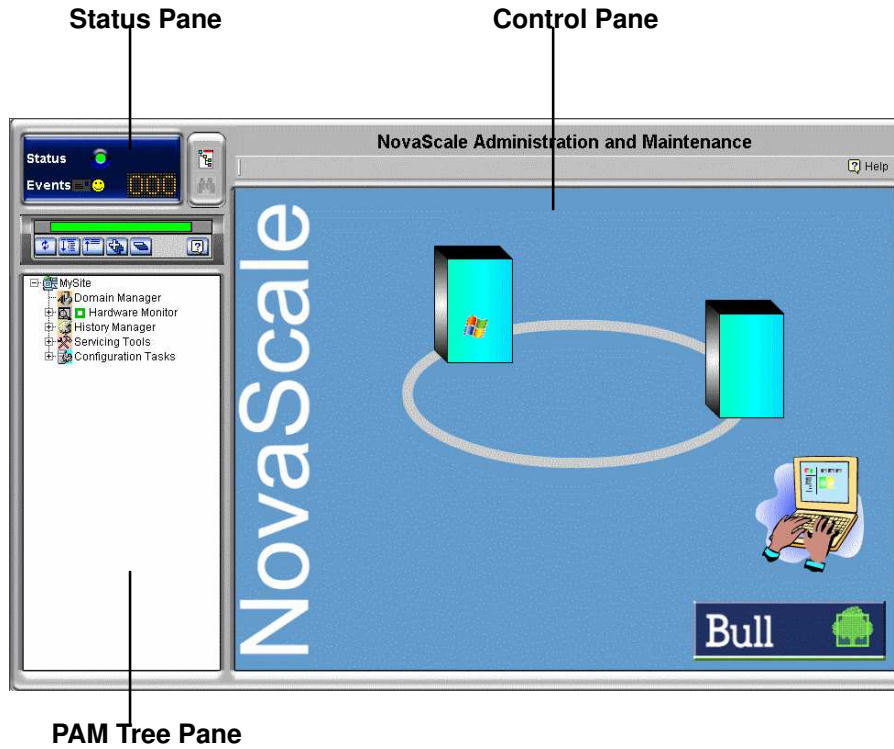

Figure 55. PAM user interface



Note:

For further details about the PAM user interface, please consult the *User's Guide*.

Checking Server Status via PAM

The PAM user interface allows you to check system status at a glance. If the **Functional Status** icon in the **Status** pane and the **CSS Availability Status** bar are green, the server is ready to be powered up.

PAM Status Pane

The **Status** pane, which is automatically refreshed every few seconds, provides quick access to the following synthetic information:

- **Functional Status:** if the system is operating correctly, the status icon is green,
- **Event Messages:** shows the number and maximum severity of pending event messages,
- **CSS Availability Status:** if the CSS Module is present, configured correctly, and is ready to operate, the status bar is green.

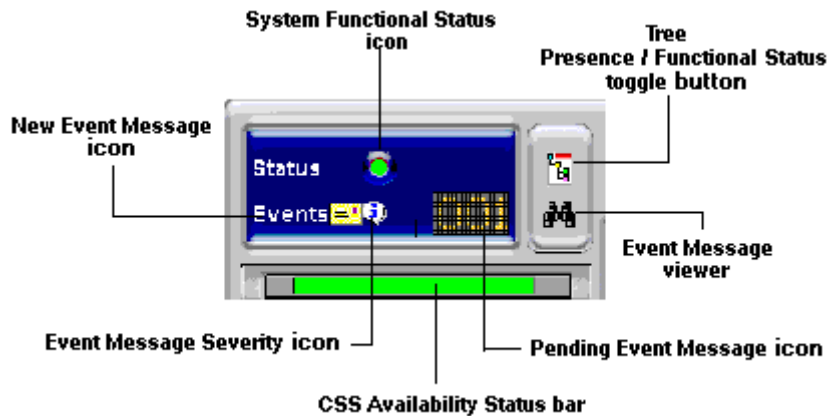

Figure 56. Status pane

CSS Availability Status

NovaScale 6080/6160 Servers

When the CSS Module is operating correctly, the **CSS Availability Status** bar is green. If the CSS Module is not operating correctly, the bar is red.

NovaScale 6320 Servers

The **CSS Availability Status** bar is divided into two zones.

If the CSS Modules are operating correctly, the **CSS Availability Status** bar is green.

If the CSS Modules are not operating correctly, the bar is red.

If one of the CSS Modules is not operating correctly, half the bar is red.

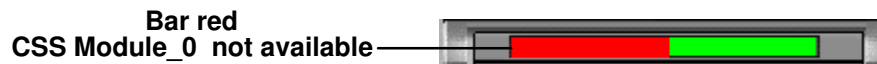

Figure 57. CSS Module availability status bar

PAM Tree Pane



Note:

The PAM tree building process may take one to two minutes. The PAM tree pane is refreshed on request.

The **PAM Tree** pane provides access to server administration and maintenance features:

Tree Nodes	Function
Domain Manager	to power on / off and manage domains.
Hardware Monitor	to display the status of hardware components and assemblies.
History Manager	to view logs and manage archives.
Servicing Tools	to install, maintain, and update the server.
Configuration Tasks	to customize server features.

Table 3. PAM Tree nodes

PAM Tree Toolbar

The PAM Tree toolbar, located at the top of the PAM Tree, is used to refresh, expand, or collapse the tree display.



Toolbar Buttons	Explanation
	Refresh /rebuild the PAM Tree to view changes.
	Expand the complete tree.
	Collapse the complete tree.
	Expand selected node.
	Collapse selected node.
	View the related Help topic.

Figure 58. PAM Tree toolbar

PAM Control Pane

When an item is selected in the **PAM Tree** pane, details and related commands are displayed in the **Control** pane, which is automatically refreshed at one minute intervals.

toggling the Local / Integrated Console Display

During the powering up / down sequences, you will be requested to toggle the local / integrated console from the PAP unit display to the server domain display, or vice versa, as explained below.



CAUTION:

Access to the local / integrated console should be restricted to Customer / Support Administrators and Operators ONLY to avoid inadvertent damage to software and/or hardware components.

The KVM Switch allows the integrated console to be used as the local server domain and local PAP unit console. KVM ports are configured as shown in Table 4.

8-Port KVM Switch	Console Display	Domain
Port A	PAP Unit	N/A
Port B	CSS0-Mod0-IO0	MyOperations_1
Port C	CSS0-Mod0-IO1	MyOperations_2

16-Port KVM Switch	Console Display	Domain
Port 1	PAP Unit	N/A
Port 3	CSS0-Mod0-IO0	MyOperations_1
Port 4	CSS0-Mod0-IO1	MyOperations_2
Port 5	CSS0-Mod1-IO0	MyOperations_3
Port 6	CSS0-Mod1-IO1	MyOperations_4

Table 4. KVM port configuration

You can easily toggle from the server domain display to the PAP unit display, or vice versa:

1. From the keyboard, press the **Control** key twice to display the KVM Switch Command Menu.
2. Select the required port with the $\uparrow\downarrow$ keys and press **Enter**.
3. The selected display appears on the Console monitor.

Powering Up / Down Server Domains

When server status has been checked – system functional status icon and CSS availability status bar green in the Status pane – the server can be powered up.

To power up / down the server, see:

- *Powering Up / Down the NovaScale 6080/6160 Server Domains*, on page 2-21.
- *Powering Up / Down NovaScale 6320 Server Domains*, on page 2-25.

Powering Up / Down NovaScale 6080/6160 Server Domains

The NovaScale 6080/6160 Server is designed to operate as two hardware-independent SMP systems, or domains.

For easy configuration and optimum use of the physical and logical resources required for simultaneous operation, domains are defined via the **PAM Domain Scheme** wizard. For further details about domain configuration, see *Configuring Domains*, in the *User's Guide*.





The server is delivered with a default scheme, or configuration file, called **MyOperationsScheme**, containing two domains. An Operating System instance is pre-installed on each domain boot disk (EFI LUN). According to Customer requirements, identical or different Operating System instances may be pre-installed on each EFI LUN. The default scheme allows domains to be booted simultaneously or independently. A brief summary of the organization of physical and logical resources in **MyOperationsScheme** is given in the following table.



Note:

In the screen shots used in this guide, an instance of Microsoft Windows is pre-installed on **MyOperations-1** and an instance of Linux is pre-installed on **MyOperations-2**.

MyOperationsScheme Organization

Domain Identity: MyOperations-1	
Hardware Cell	Cell_0
Operating System (customer-specific)	 Windows or  Linux
EFI LUN**	*<MyServer>_0LU0
IOB	Module0_IOB0
QBBs	Module0_QBB0, Module0_QBB1
Domain KVM Ports	***CSS0_Mod0_IO0
Domain Identity: MyOperations-2	
Hardware Cell	Cell_1
Operating System (customer-specific)	 Windows or  Linux
EFI LUN**	*<MyServer>_0LU1
IOB	Module0_IOB1
QBBs	Module0_QBB2, Module0_QBB3
Domain KVM Ports	***CSS0_Mod0_IO1

* <MyServer> = default server name, e.g.: NS6080-0, NS6160-0

** EFI LUN: xLUx = boot LUN device location (*ModxLUIOx*):



0LU0 = LUN device connected to Module0, IOB0

0LU1 = LUN device connected to Module0, IOB1

0LU2 = LUN device connected to Module1, IOB0

0LU3 = LUN device connected to Module1, IOB1

***CSSx = CSS number, Modx = Module number, IOx = IO box number

Operating System type is indicated by the Microsoft Windows  or Linux  logo in the **Domain Identities** box.



Note:

The NovaScale 6080 Server is equipped with QBB_0 and QBB_3, only.

Table 5. MyOperationsScheme organization – mono-module server

To power up / down server domains:



Note:

If an error dialog box appears during this sequence, see Chapter 3. *Troubleshooting*.

1. From the Customer Administrator PAM Tree, click **Domain Manager** to open the **Control** pane. You are invited to load a **Domain Scheme**.
2. Click **Schemes**. The **Schemes List** dialog opens displaying the pre-configured scheme.
3. Select **MyOperationsScheme** and click **Apply**.

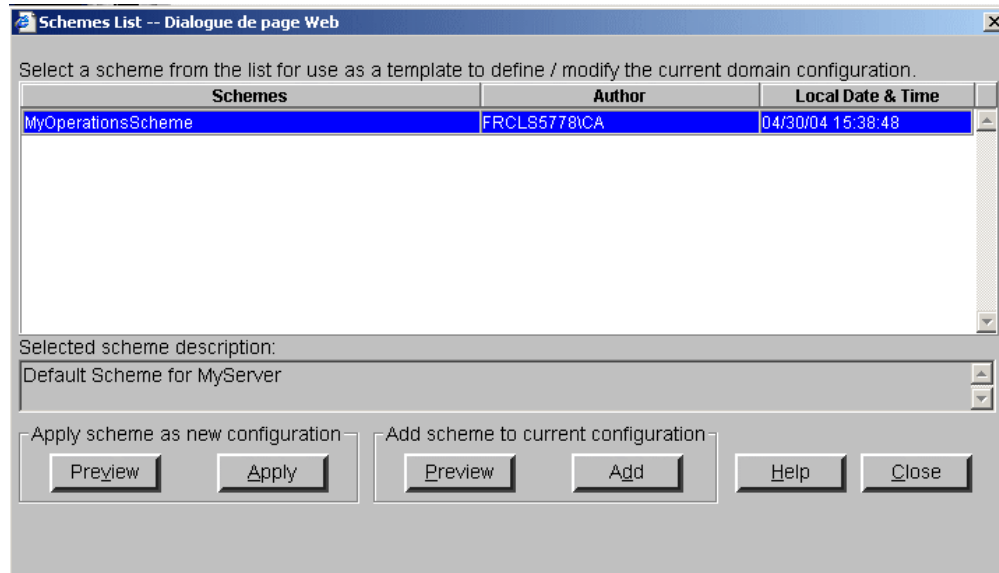

Figure 59. Domain schemes list dialog

4. When requested, click **Yes** to confirm. **MyOperations–1, MyOperations–2**, domains are loaded in the **Control** pane.

If the domains are ready to be powered up, **INACTIVE** is displayed in the **Domain State** boxes and the **Power On** button is accessible for each domain.

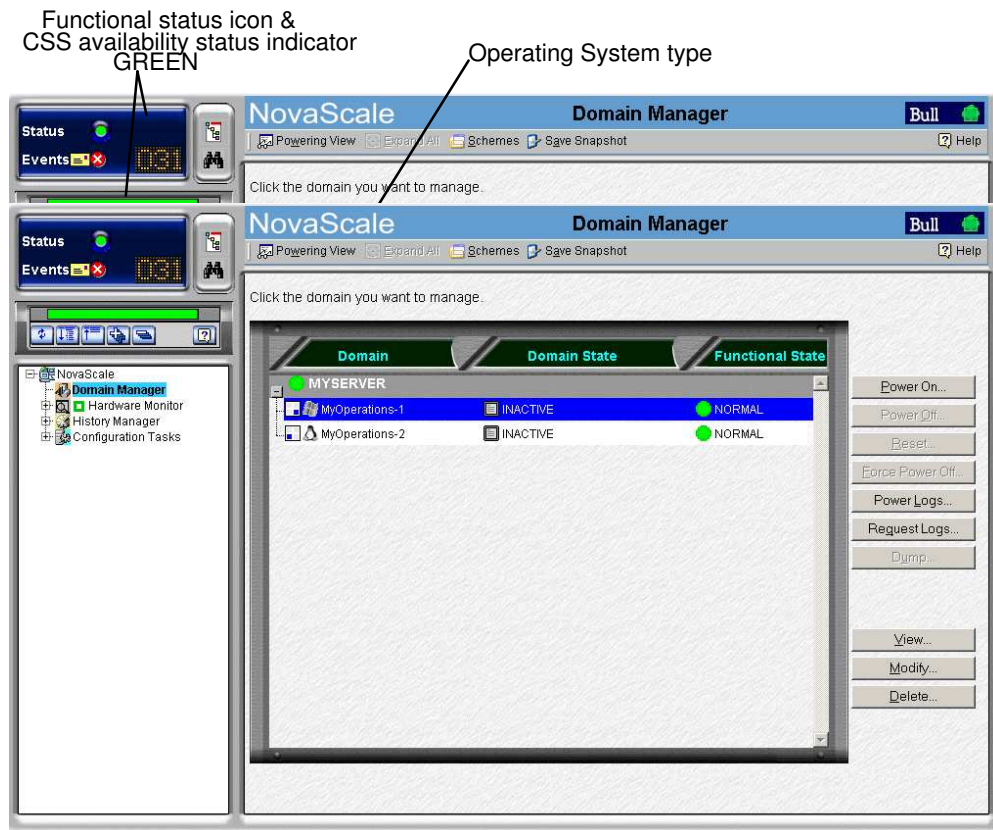

Figure 60. Domain Manager Control pane

5. Select **MyOperations–1** in the **Control** pane and click **Power On** to power up the domain and associated hardware components.
6. Select **MyOperations–2** in the **Control** pane and click **Power On** to power up the domain and associated hardware components.
7. Follow the power–on steps displayed in the **Domain State** boxes, until **RUNNING** is displayed in both **Domain State** boxes.

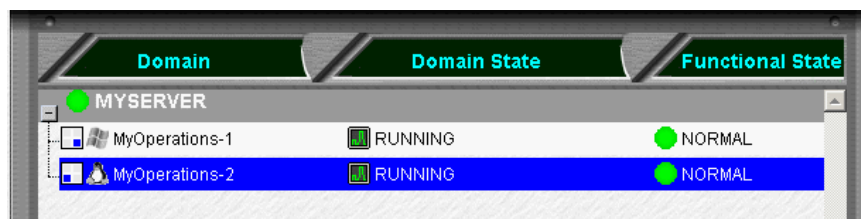

Figure 61. Domain state

8. Toggle the local / integrated console from the PAP unit display to **MyOperations–1** display. See *Toggling the Local / Integrated Console Display*, on page 2-20.
9. Wait for the Operating System to load completely. **MyOperations–1** domain is now fully functional.
10. Toggle the local / integrated console from **MyOperations–1** display to **MyOperations–2** display.
11. Wait for the Operating System to load completely. **MyOperations–2** domain is now fully functional.
12. Check the Operating System environment pre–installed on each domain.

13. Shut down each Operating System to power down the corresponding domain to the stand-by mode.
14. Toggle the local / integrated console to the PAP unit display. **INACTIVE** is displayed in the **Domain State** boxes and the **Power ON** button is accessible for each domain.



Notes:

For further details about the **Power ON / OFF** sequences, see *Powering ON a Domain* and *Powering OFF a Domain* in the *User's Guide*.

If the functional status icon and/or presence status bar is/are not green or if domains cannot be powered up / powered down, see Chapter 3. *Troubleshooting*.

Shutting Down / Restarting the Server

1. From the PAM home page, click **File** → **Close** to return to the Microsoft Windows desktop.
2. Shut down the PAP unit by selecting the **Shut Down** command in the Start Menu.
3. Request the Customer to turn the two site power supply circuit breakers OFF.
4. Request the Customer to turn the two site power supply circuit breakers ON.

The Platform Management Board (PMB) in the CSS module automatically powers up to the standby mode (48V) and the Platform Administration Processor (PAP) unit automatically boots Microsoft Windows software.

Powering Up / Down NovaScale 6320 Server Domains

The NovaScale 6320 Server is designed to operate as four hardware-independent SMP systems, or domains.

For easy configuration and optimum use of the physical and logical resources required for simultaneous operation, domains are defined via the **PAM Domain Scheme** wizard. For further details about domain configuration, see *Configuring Domains*, in the *User's Guide*, 86 A1 21EM.









The server is delivered with a default scheme, or configuration file, called **MyOperationsScheme**, containing two or four domains. An Operating System instance is pre-installed on each domain boot disk (EFI LUN). According to Customer requirements, identical or different Operating System instances may be pre-installed on each EFI LUN. The default scheme allows you to simultaneously boot all domains. A brief summary of the organization of physical and logical resources in **MyOperationsScheme** is given in the following table.



Note:

In the screen shots used in this guide, an instance of Microsoft Windows is pre-installed on **MyOperations-1** and **MyOperations-3** and an instance of Linux is pre-installed on **MyOperations-2** and **MyOperations-4**.

MyOperationsScheme Organization

Domain Identity: MyOperations-1	
Hardware Cell	Cell_0
Operating System (customer-specific)	 Windows or  Linux
EFI LUN**	*<MyServer>_0LU0
IOB	Module0_IOB0
QBBs	Module0_QBB0, Module0_QBB1
Domain KVM Ports	***CSS0_Mod0_IO0
Domain Identity: MyOperations-2	
Hardware Cell	Cell_1
Operating System (customer-specific)	 Windows or  Linux
EFI LUN**	*<MyServer>_0LU1
IOB	Module0_IOB1
QBBs	Module0_QBB2, Module0_QBB3
Domain KVM Ports	***CSS0_Mod0_IO1
Domain Identity: MyOperations-3 (NovaScale 6320 Server)	
Hardware Cell	Cell_2
Operating System (customer-specific)	 Windows or  Linux
EFI LUN**	*<MyServer>_0LU2
IOB	Module1_IOB0
QBBs	Module1_QBB0, Module1_QBB1
Domain KVM Ports	***CSS0_Mod1_IO0
Domain Identity: MyOperations-4 (NovaScale 6320 Server)	
Hardware Cell	Cell_3
Operating System (customer-specific)	 Windows or  Linux
EFI LUN**	*<MyServer>_0LU3
IOB	Module1_IOB1
QBBs	Module1_QBB2, Module1_QBB3
Domain KVM Ports	***CSS0_Mod1_IO1

* <MyServer> = default server name, e.g.: NS6080-0, NS6160-0, NS6320-0

** EFI LUN: xLUx = boot LUN device location (*ModxLUIOx*):

0LU0 = LUN device connected to Module0, IOB0

0LU1 = LUN device connected to Module0, IOB1

0LU2 = LUN device connected to Module1, IOB0

0LU3 = LUN device connected to Module1, IOB1

***CSSx = CSS number, Modx = Module number, IOx = IO box number

Operating System type is indicated by the Microsoft Windows  or Linux  logo in the **Domain Identities** box.

Table 6. MyOperations Scheme organization – bi-module server

To power up / down server domains:

1. From the Customer Administrator PAM Tree, click **Domain Manager** to open the **Control** pane. You are invited to load a **Domain Scheme**.
2. Click **Schemes**. The **Schemes List** dialog opens displaying the pre-configured scheme.
3. Select **MyOperationsScheme** and click **Apply**.

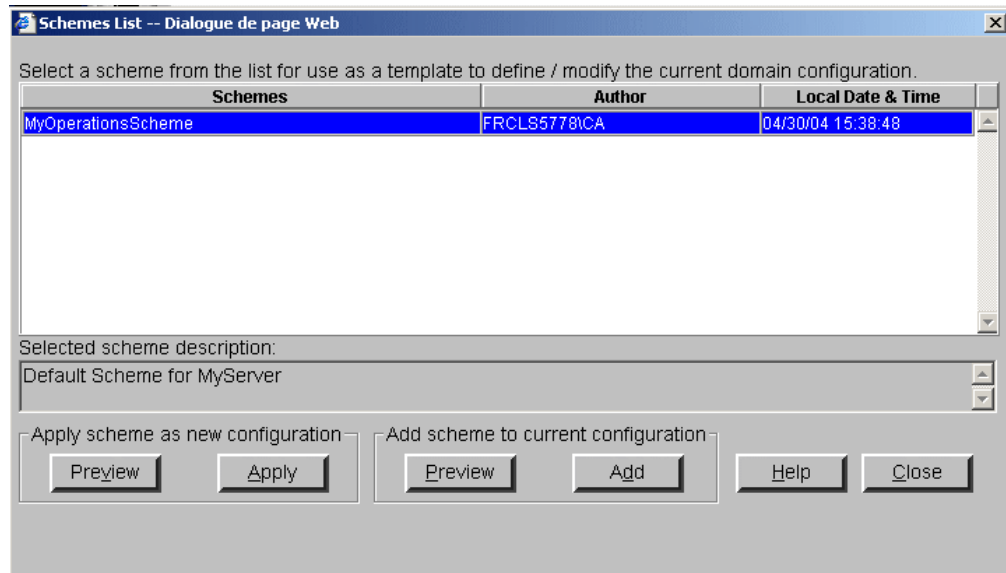

Figure 62. Domain schemes list dialog

4. When requested, click **Yes** to confirm. **MyOperations-1**, **MyOperations-2**, **MyOperations-3**, and **MyOperations-4** domains are loaded in the **Control** pane. If the domains are ready to be powered up, **INACTIVE** is displayed in the **Domain State** boxes and the **Power On** button is accessible for each domain.

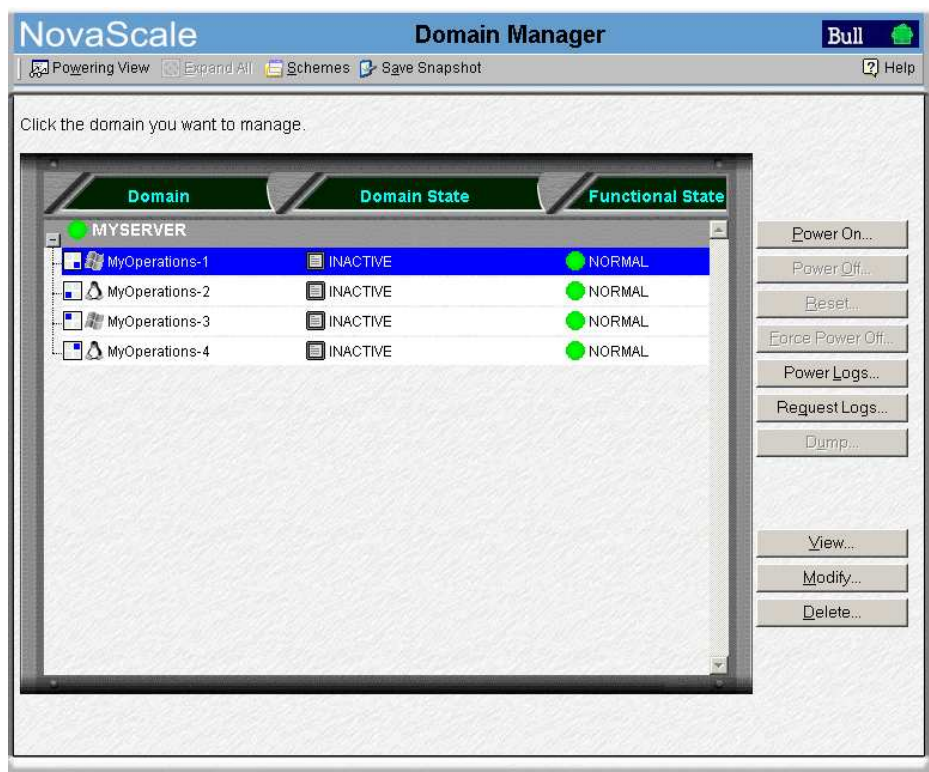

Figure 63. Domain Manager Control pane

5. Select **MyOperations–1** in the **Control** pane and click **Power On** to power up the domain and associated hardware components.
6. Repeat Step 5 for each domain in the **Control** pane.
7. Follow the power–on steps displayed in the **Domain State** boxes, until **RUNNING** is displayed in all **Domain State** boxes.

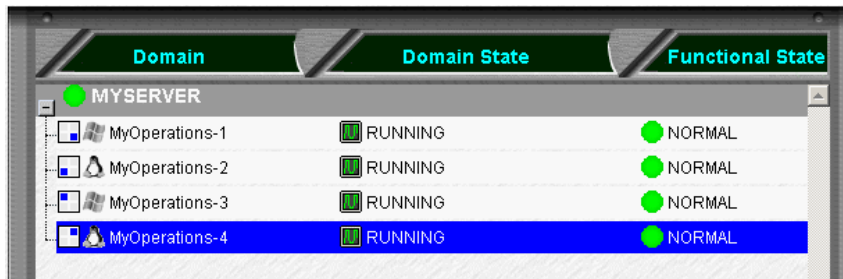

Figure 64. Domain state

8. Toggle the local / integrated console from the PAP unit display to the first domain display. See *Toggling the Local / Integrated Console Display*, on page 2-20.
9. Wait for the Operating System to load completely. The domain is now fully functional.
10. Toggle the local / integrated console from this domain display to the next domain display.
11. Wait for the Operating System to load completely. The domain is now fully functional.
12. Repeat Steps 10 and 11 for each domain.
13. Check the Operating System environment pre–installed on each domain.
14. Shut down each Operating System to power down the corresponding domain to the stand–by mode.
15. Toggle the local / integrated console to the PAP unit display. **INACTIVE** is displayed in the **Domain State** boxes and the **Power ON** button is accessible for each domain.



Notes:

For further details about the **Power ON / OFF** sequences, see *Powering ON a Domain* and *Powering OFF a Domain* in the *User's Guide*, 86 A1 21EM.
 If the functional status icon and/or presence status bar is/are not green or if domains cannot be powered up / powered down, see Chapter 3. *Troubleshooting*.

Shutting Down / Restarting the Server

1. From the PAM home page, click **File** → **Close** to return to the Microsoft Windows desktop.
2. Shut down the PAP unit by selecting the **Shut Down** command in the Start Menu.
3. Request the Customer to turn the two site power supply circuit breakers OFF.
4. Request the Customer to turn the two site power supply circuit breakers ON in the following order:
 - a. PDU breaker.
 - b. CSS module breaker.

The Platform Management Board (PMB) in each CSS module automatically powers up to the standby mode (48V) and the Platform Administration Processor (PAP) unit automatically boots Microsoft Windows software.

Completing PAP Unit Configuration

- Refer to the *PAM Writing Rules*, on page B-4
- Check **Regional, Date/Time, and Time Zone settings**



Note:

If an error dialog box appears during these sequences, see Chapter 3. *Troubleshooting*.

Changing the Default PAP Unit Name

Request the Customer to change the default PAP unit name <PAP> from the Microsoft Windows Network configuration utility.

To change the default PAP unit name:

5. From the Microsoft Windows desktop, select:
MyComputer → **Properties** → **Network Identification** → **Properties**.
6. Complete the fields as required.

Launching the PAP Configuration Setup Wizard

To complete PAP unit configuration:

1. Request the Customer to provide the *Installation Setup Data* listed in the *Read Me First* booklet enclosed in the *Open Me First* kit.
2. Open a new Microsoft Windows session with the predefined User Name and Password.

User Name	Administrator
Password	administrator

3. From the Microsoft Windows desktop, click:
Start → **Program Files** → **Platform Administration and Maintenance** → **PAP Configuration**
to launch the PAP configuration setup wizard which guides you through the PAP Unit configuration procedure (approximately 10 minutes).

The PAP configuration setup wizard dialog opens.



Figure 65. PAP configuration wizard dialog

4. Click the **Check PAM Release Type** button. The **Release Type** dialog opens.

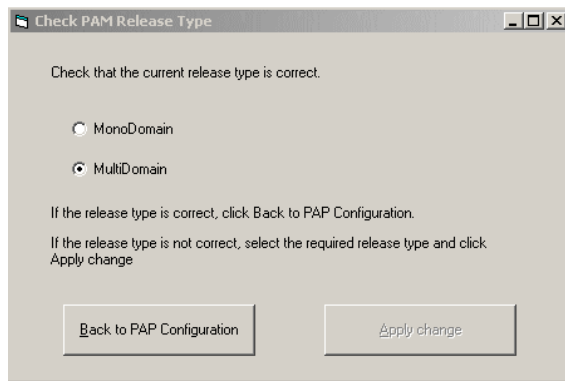

Figure 66. Release type dialog



Note:

If the release type is not correct, select the required release type and click **Apply change**.

5. Check that the **MultiDomain** radio button is highlighted and click **Back to PAP Configuration** to customize the PAP unit with the *Installation Setup Data* supplied by the Customer:
 - Click the **Configure the Network** button to configure Customer Enterprise LAN settings and to change the default factory PAP unit network setting.
 - Click the **Change Windows Administrator Password** button to change the PAP unit Customer Administrator password.
 - Click **Configure PAM Software via the PAM Web Site** to open a Support Administrator PAM session to complete **Customer Information**, **Autocalls** and **Central Subsystem** configuration.



Warning:

Changes to Central Subsystem configuration are hazardous and must not be performed until the server has been fully tested.

If the Customer wants to rename the Central Subsystem, this entails removing the existing Central Subsystem and adding a new Central Subsystem with the required name.

Default Domain Schemes will not be applicable to the new Central Subsystem and must be redefined.

See Configuring the Central Subsystem, on page 2-53.

Configuring Customer Information

Customer information is used by PAM software for the **PAM Tree** display and to complete Intervention Reports.

To configure Customer information:



Note:

If an error dialog box appears during this sequence, see Chapter 3. *Troubleshooting*.

1. From the PAM Tree, click **Configuration Tasks** → **Customer Information**. The **Customer Information** configuration page opens.
2. Enter Customer data and click **Save** to confirm changes.

The screenshot shows a web browser window titled "NovaScale Customer Information". The browser's address bar shows "Save" and "Help" buttons. The main content area contains the following form fields:

Site name:	<input type="text"/>
Customer name:	<input type="text"/>
Site number:	<input type="text"/>
Site engineer name:	<input type="text"/>
Site engineer phone number:	<input type="text"/>
Town:	<input type="text"/>
Country code:	<input type="text"/>

Figure 67. Customer Information configuration page



Notes:

The value entered in the **Site name** field is used for the PAM Tree root node. The default name is NovaScale.

The values entered in the other fields can be consulted by the Customer and / or Support personnel.

Configuring Autocalls

The **Autocall** feature is part of the BULL Remote Maintenance contract. It is used to automatically route system events to the Remote Maintenance Center. Full details are given in the BULL *Remote Maintenance Guide*.

If the Customer's maintenance contract includes the Autocall feature, configure Autocall parameters as follows:



Note:

If an error dialog box appears during this sequence, see Chapter 3. *Troubleshooting*.

1. Click **Configuration Tasks** → **Autocalls**. The **Autocalls** configuration page opens.

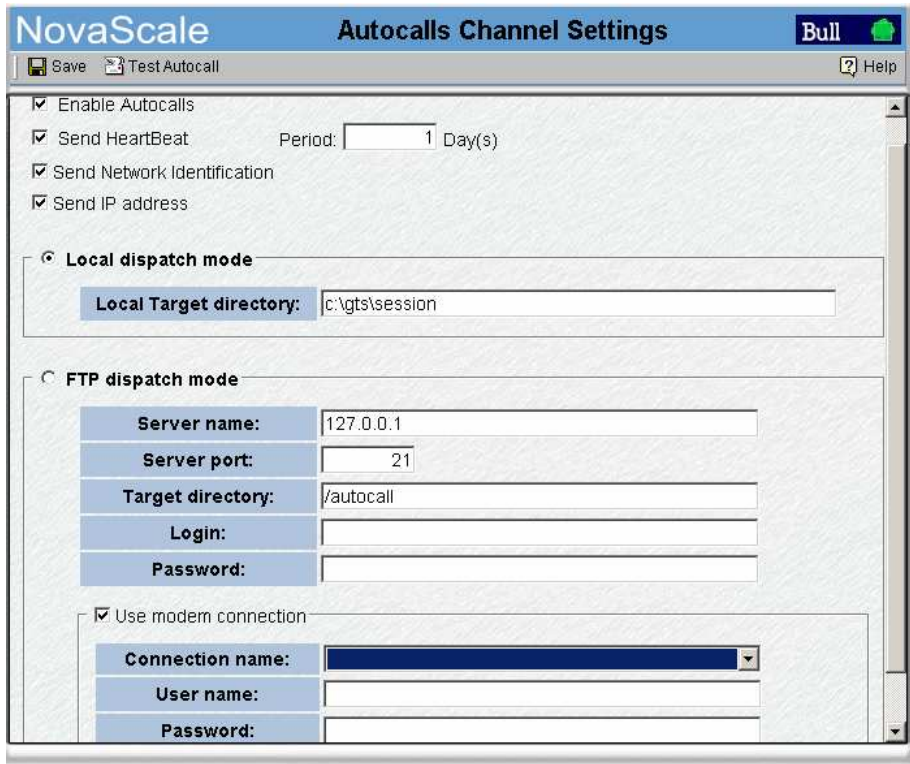

Figure 68. Autocalls Channel Settings control pane

2. Select the **Enable Autocalls** checkbox.
3. Select the the **Send Heartbeat** checkbox and enter a value “in days” for the autocall channel control in the **Period** box. Recommended value = 1.
4. Select the autocall dispatch mode :
 - **Local dispatch mode** (default mode) sends autocalls to the local target directory indicated under **Local Settings**,
 - **FTP dispatch mode** sends autocalls to the server indicated under **FTP Settings**.
5. If **Local dispatch mode** (default mode) is selected, complete the **Local Settings** field with the following information:

Field	Explanation	Value
Local target directory	Default GTS directory used to store autocalls.	c:\gts\session

6. If **FTP dispatch mode** is selected, complete the **FTP Settings** fields with the following information:

Field	Explanation	Value
Server name	Remote Maintenance Center server IP address	127.0.0.1
Server port	Default server port	21
Target directory	Default server directory	/autocall
Login	Declared authorized user name	X
Password	Declared authorized user password	X

7. If a modem connection is to be used:
- From the PAM Unit Microsoft Windows desktop, configure the dial-up connection (**Control Panel** → **Phone and Modem Options**).
 - From the PAM **Autocalls Control Pane**, select the **Use modem connection** checkbox.
 - Use the **Connection name** drop-down menu to select the required modem connection.
 - Complete the **User name** and **Password** fields with the declared authorized user name and user password.
8. Return to the PAM Unit Microsoft Windows desktop to complete remote maintenance setup as explained in the BULL *Remote Maintenance Guide*.



Note:

Connection of the USB modem required for the Autocall feature is explained in *Connecting the USB Modem and External Devices*, on page 2-51.

Changing the iStorage Manager User Name and Password

FDA 1300 FC and FDA 2300 FC subsystems are delivered with iStorage Manager (iSM) for integrated monitoring and centralized management.

The iSM Server / Client utility is installed on the PAP Unit desktop. The Customer can install iSM Client on any standard PC running under Microsoft Windows (2000 or later).

Before using iSM, the Customer is advised to replace the factory default User Name and Password.

To change the iStorage Manager User Name and Password:

1. From the PAP Unit Microsoft Windows desktop, click:
Start → Programs → NEC Storage Manager Server → Setting Utility.
2. Select the **Users** tab. The default User Name and User Level is displayed in the User List.

Default User Name	Administrator
Default User Level	L3
Default Password	administrator

3. Select **Administrator** from the User List and click **Edit** to open the **User – Edit** dialog box.
4. Change the User Name and Password and check that the **L3** radio button is highlighted.
5. Click **OK**.
6. A dialog box requests you to restart iSM to apply changes. Click **Yes**.
7. From the PAP Unit Microsoft Windows desktop, click:
Start → Programs → Administrative Tools → Services.
8. Select **NEC Storage Manager → Action → Stop** to stop iSM.
9. Click **Action → Start** to restart iSM. Changes are applied.

Connecting the PAP Unit to the Customer's Enterprise LAN



CAUTION:

Remote access via the Web is a potential security hazard. Customers are strongly advised to protect their systems with up-to-date protection devices such as virus-prevention programs and firewalls, and to maintain a detailed record of authorized users.

Once PAP unit configuration is complete, it can be connected to the Customer's Enterprise LAN.

The PAP unit provides two RJ45 Ethernet ports. The first is used for the internal server network and the second for connection to the Customer's Enterprise LAN for remote platform administration and maintenance.

1. Open the rear door and remove the left side cover.
See *Removing Side Covers*, on page 1-14.
2. Guide the Enterprise network cable supplied by the Customer through the cable cut-out at the base of the cabinet and up through the free space on the left side of the cabinet.
3. Access the PAP unit RJ45 Ethernet ports from the rear of the cabinet.

Figure 69. PAP unit free Ethernet port

4. Secure the Enterprise network cable to the left flange of the cabinet with the velcro fasteners supplied in the *Open Me First* kit.
5. Close the rear door and refit the left side cover. See *Refitting Side Covers*, on page 1-26.



Important:

If the PAP unit is not connected to the Customer's Enterprise LAN, event messaging systems will not be enabled.

Connecting to the PAM Web Site from a Remote Computer/Workstation



Important:

For optimum security, before connecting to PAM from a remote computer, you are advised to disconnect from your local Windows session on the PAP unit by clicking **Start → Log Off**.

The PAM Software utility can be accessed from any PC running Microsoft Windows with the Internet Explorer (6 or later) browser installed and/or from any workstation running Linux with the Mozilla (1.6 or later) browser installed.



Notes:

PAM Configuration Tasks and **Servicing Tools** can only be accessed from the local/integrated console or from a remote computer running Microsoft Windows with the Internet Explorer browser installed.

PAP unit setup is described in *Completing PAP Unit Configuration*, on page 2-29.

Enabling Remote Access to the PAM Web Site with Internet Explorer

1. From the remote computer, configure Internet Explorer to connect directly to the PAM Web site:
 - a. From the Internet Explorer main menu bar, select **Tools → Internet Options → Home Page**.
 - b. Type the PAM Web site URL defined during the PAP installation procedure in the home page address field: **http://<PAPname>/pam**
(where **<PAPname>** is the name allocated to PAP unit during setup).
 - c. Save your changes and close Internet Explorer.
2. Launch Internet Explorer to connect directly to the PAM web site.
3. When prompted, enter the appropriate Administrator or Operator **User Name** and **Password**. The PAM home page appears.

Enabling Remote Access to the PAM Web Site with Mozilla

1. From the remote computer, configure Mozilla to connect directly to the PAM Web site:
 - a. From the Mozilla main menu bar, select **Edit → Preferences → Navigator**.
 - b. Check the **Home Page** box and enter the PAM Web site URL defined during the PAP installation procedure in the location field:
http://<PAPname>/pam
(where **<PAPname>** is the name allocated to PAP unit during setup).
 - c. Save your changes and close Mozilla.
2. Launch Mozilla to connect directly to the PAM web site.
3. When prompted, enter the appropriate Administrator or Operator **User Name** and **Password**. The PAM home page appears.

Enabling Remote Access to iSM on the Client Computer

FDA 1300 FC and FDA 2300 FC subsystems are delivered with iStorage Manager (iSM) for integrated monitoring and centralized management.

The iSM Server / Client utility is installed on the PAP Unit desktop. The Customer can install iSM Client on any standard PC running under Microsoft Windows (2000 or later).

To enable remote access to iSM:

1. Insert the iSM Client setup CD–Rom in the client computer.
2. Run the **CLIENT\2000\ISMCE211.EXE** program to launch the setup wizard which guides you through the iSM Client configuration procedure.
3. When you are requested to select **Setup Type**, click **basic + extended function** → **Next**.
4. Once setup is complete, launch iSM Client to connect to iSM Server. A dialog box appears requesting you to set the environment for iSM Client.
5. From the iSM Client menu, click **File** → **Environment Settings** to open the **Server Settings** page.
6. In the **IP Address** field, enter the PAP unit IP address allocated during the PAP unit setup process. See *Completing PAP Unit Configuration*, on page 2-29.
7. Click **OK** to establish the connection.
8. When requested enter the User Name and Password and click **OK**. See *Changing the iStorage Manager User Name and Password*, on page 2-34.

Completing Operating System Setup

A list of the Customer data required to complete setup is given in the *Read Me First* booklet delivered with the system 24 hours before the scheduled installation date.



Note:

For further information about the server booting environment, see *Using EFI Utilities* in the *User's Guide*.

To complete Operating System setup, see:

- NovaScale 6080/6160 Server – *Operating System Setup*, on page 2-39
- NovaScale 6320 Server – *Operating System Setup*, on page 2-43

NovaScale 6080/6160 Server – Operating System Setup

An Operating System instance is pre-installed on each domain boot disk (EFI LUN):



0LU0 = LUN device connected to Module0, IOB0

0LU1 = LUN device connected to Module0, IOB1

According to Customer requirements, identical or different Operating System instances may be pre-installed on each EFI LUN. Operating System setup must be completed for each Operating System instance.

Before proceeding to complete setup on each domain:

1. From the Customer Administrator PAM Tree, click **Domain Manager**.
MyOperations-1 and **MyOperations-2** domains are displayed in the **Control** pane.
2. Check Operating System type for each domain:

Microsoft Windows  or Linux  logo in the **Domain Identities** box.
3. Locate the corresponding DVD-Rom drive:
MyOperations-1: Module0, IOB0
MyOperations-2: Module0, IOB1
4. Note KVM ports for each domain:
MyOperations-1: CSS0-Mod0-IO0
MyOperations-2: CSS0-Mod0-IO1
5. Check that the Customer has supplied the System and Networking data required to complete setup and customize the system. See the *Installation Setup Data* tables in the *Read Me First* document supplied on delivery.

To complete Operating System setup, see:

- *Microsoft Windows Setup*, on page 2-40
- *Linux Redhat Setup*, on page 2-41
- *Linux SuSe Setup*, on page 2-42

Microsoft Windows Setup



Warning:

Most of the options selected and validated during the setup sequence can be modified. However, special attention is to be paid when selecting and validating the Licensing Mode (Per Seat / Per Server). If selected and validated, the “Per Server” Licensing Mode option CAN be modified. If selected and validated, the “Per Seat” Licensing Mode CANNOT be modified.

1. Check that the Microsoft Windows CD–Rom labeled “**TO BE COMPLETED**” is ready for use and that the yellow sticker with the 25–character Microsoft Windows Product Key required to complete setup is clearly visible inside the cabinet.
2. Select the first Microsoft Windows domain in the **Control** pane and click **Power On** to power up the domain and associated hardware components.
3. Toggle the local / integrated console from the PAP unit display to **MyOperations–1** or **MyOperations–2** display, as required. See *Toggling the Local / Integrated Console Display*, on page 2-20.
4. Check Regional, Date/Time, and Time Zone settings.
5. Place the Microsoft Windows CD–Rom in the corresponding DIB drive. The setup wizard is launched automatically and guides the Customer and the Customer Service Engineer through the setup completion procedure (approximately 30 minutes).

Once setup is complete, Microsoft Windows shuts down, the system domain is rebooted and the server configuration wizard is launched automatically.



Note:

Server configuration is a Customer–specific task and is not performed by the Customer Service Engineer during installation. Once the system has been fully installed, the Customer Administrator may launch this wizard to configure and manage Server Roles.

6. Close the server configuration wizard.
7. Shut down the domain and associated hardware components by selecting the **Shut Down** command in the **Start Menu**.
8. Toggle the local / integrated console from the domain display to the PAP unit display. See *Toggling the Local / Integrated Console Display*, on page 2-20.
9. Update **Domain Identity Management Parameters**:
 - a. From the Customer Administrator PAM Tree, click **Domains** → **Identities**.
 - b. Select the corresponding **Domain Identity** and click **Edit**. The **Edit Identity** dialog opens.
 - c. Complete the **Network Name**, **IP Address**, and **URL** fields with the data entered during the setup completion procedure.
10. Repeat steps 3 to 9 for each pre–installed Microsoft Windows instance.

Linux RedHat Setup

1. Select the first Linux RedHat domain in the **Control** pane scheme and click **Power On** to power up the domain and associated hardware components.
2. Toggle the local / integrated console from the PAP unit display to **MyOperations–1** or **MyOperations–2** display, as required. See *Toggling the Local / Integrated Console Display*, on page 2-20.
3. Check Regional, Date/Time, and Time Zone settings.
4. Place the Linux RedHat CD–Rom in the corresponding DIB drive. Setup is completed via the Webmin administration tool:
 - a. Enter the Webmin URL:
http://<localhost>:10000. The **Login to Webmin** dialog box opens.
 - b. Enter the default User Name and Password, followed by **Enter**. The Webmin home page opens.

User Name	root
Password	root

- c. Click the **Networking** icon to open the Networking main page.
 - d. Click **Network Configuration** → **Network Interfaces**. In the **Interfaces Activated at Boot Time** field, click **Add a new interface** to open the **Create Bootup Interface** configuration page. Complete the required fields with the data supplied by the Customer and click **Create**.
 - e. From the **Interfaces Activated at Boot Time** field, select the new interface. The **Edit Bootup Interface** page opens. Check settings and click **Save and Apply** → **Return to network configuration**.
 - f. Click **Routing and Gateways** to open the **Routing and Gateways** configuration page. Complete the required fields with the data supplied by the Customer and click **Save** → **Return to network configuration**.
 - g. Click **DNS Client** to open the **DNS Client Options** configuration page. Complete the required fields with the data supplied by the Customer and click **Save** → **Return to network configuration**.
 - h. Click **Host Addresses** → **Add a new host address** to open the **Host and Addresses** configuration box. Complete the required fields with the data supplied by the Customer and click **Create** → **Return to host addresses list** → **Return to network configuration** → **Return to index** → **System** → **Bootup and Shutdown** to create a new bootup and shutdown action.
 - i. From the action list, select **Network** to display the **Edit Action** page and click → **Restart Now** → **Return to action** → **Return to bootup and shutdown actions** → **Return to index** → **Log Out** to exit Webmin. Once setup is complete, the network is activated.
5. Shut down the domain and associated hardware components by selecting the **Shut Down** command in the **Start Menu**.
 6. Toggle the local / integrated console from the domain display to the PAP unit display. See *Toggling the Local / Integrated Console Display*, on page 2-20.
 7. Update **Domain Identity Management Parameters**:
 - a. From the Customer Administrator PAM Tree, click **Domains** → **Identities**.
 - b. Select the corresponding **Domain Identity** and click **Edit**. The **Edit Identity** dialog opens.
 - c. Complete the **Network Name**, **IP Address**, and **URL** fields with the data entered during the setup completion procedure.
 8. Repeat steps 1 to 7 for each pre–installed Linux Redhat instance.

Linux SuSe Setup

1. Select the first Linux SuSe domain in the **Control** pane scheme and click **Power On** to power up the domain and associated hardware components.
2. Toggle the local / integrated console from the PAP unit display to **MyOperations–1** or **MyOperations–2** display, as required. See *Toggling the Local / Integrated Console Display*, on page 2-20.
3. Check Regional, Date/Time, and Time Zone settings.
4. Place the Linux SuSe CD–Rom in the corresponding drive. Setup is completed via the Yast Control Center administration tool:
 - a. Type the default User Name and Password, followed by **Enter**.

User Name	root
Password	root

- b. Enter **yast2** (graphical mode) or **yast** (non–graphical mode) to open the Yast Control Center main page.



Note:

Use the **<Tab>** and **<Arrow>** keys to navigate through the menus.

- c. Click **Network/Basic** → **Network Card Configuration**.
 - d. Select the required network card and click **Configure**.
 - e. From the **Network Address Setup** page, select the setup method and complete the required fields with the data supplied by the Customer.
 - f. From the **Details settings** area, click **Host name and name server**. Complete the required fields and click **Next**.
 - g. From the **Details settings** area, click **Routing**. Complete the required fields and click **Next** to return to the **Network Card Configuration** page. Your network card is displayed in the **Already configured devices** area.
 - h. Click **Close** to exit Yast Control Center. Once setup is complete, the network is activated.
5. Shut down the domain and associated hardware components by selecting the **Shut Down** command in the **Start Menu**.
 6. Toggle the local / integrated console from the domain display to the PAP unit display. See *Toggling the Local / Integrated Console Display*, on page 2-20.
 7. Update **Domain Identity Management Parameters**:
 - a. From the Customer Administrator PAM Tree, click **Domains** → **Identities**.
 - b. Select the corresponding **Domain Identity** and click **Edit**. The **Edit Identity** dialog opens.
 - c. Complete the **Network Name**, **IP Address**, and **URL** fields with the data entered during the setup completion procedure.
 8. Repeat steps 1 to 7 for each pre–installed Linux SuSE instance.

NovaScale 6320 Server – Operating System Setup

An Operating System instance is pre-installed on each domain boot disk (EFI LUN):

0LU0 = LUN device connected to Module0, IOB0

0LU1 = LUN device connected to Module0, IOB1



0LU2 = LUN device connected to Module1, IOB0

0LU3 = LUN device connected to Module1, IOB1

According to Customer requirements, identical or different Operating System instances may be pre-installed on each EFI LUN. Operating System setup must be completed for each Operating System instance.

Before proceeding to complete setup on each domain:

1. From the Customer Administrator PAM Tree, click **Domain Manager**.
MyOperations–1 and **MyOperations–2**, **MyOperations–3** and **MyOperations–4** domains are displayed in the **Control** pane.
2. Check Operating System type for each domain:

Microsoft Windows  or Linux  logo in the **Domain Identities** box.
3. Locate the corresponding CD–Rom drive:
MyOperations–1: Module0, IOB0
MyOperations–2: Module0, IOB1
MyOperations–3: Module1, IOB0
MyOperations–4: Module1, IOB1
4. Note KVM ports for each domain:
MyOperations–1: CSS0_Mod0_IO0
MyOperations–2: CSS0_Mod0_IO1
MyOperations–3: CSS0_Mod1_IO0
MyOperations–4: CSS0_Mod1_IO1
5. Check that the Customer has supplied the System and Networking data required to complete setup and customize the system. See the *Installation Setup Data* tables in the *Read Me First* document supplied on delivery.

To complete Operating System setup, see:

- *Microsoft Windows Setup*, on page 2-44
- *Linux Redhat Setup*, on page 2-45
- *Linux SuSe Setup*, on page 2-46

Microsoft Windows Setup



Warning:

Most of the options selected and validated during the setup sequence can be modified. However, special attention is to be paid when selecting and validating the Licensing Mode (Per Seat / Per Server). If selected and validated, the “Per Server” Licensing Mode option CAN be modified. If selected and validated, the “Per Seat” Licensing Mode CANNOT be modified.

1. Check that the Microsoft Windows CD–Rom labeled “**TO BE COMPLETED**” is ready for use and that the yellow sticker with the 25–character Microsoft Windows Product Key required to complete setup is clearly visible inside the cabinet.
2. **SCSI Disk Racks**
Locate the corresponding SCSI disk rack and unlock all system and data disks not used by the current Operating System instance.
See *Preparing SCSI Disk Racks*, on page 2-48.
FC Disk Racks
No action.
3. Select the first Microsoft Windows domain in the **Control** pane and click **Power On** to power up the domain and associated hardware components.
4. Toggle the local / integrated console from the PAP unit display to **MyOperations–1** or , **MyOperations–2**, **MyOperations–3**, or **MyOperations–4** display, as required. See *Toggling the Local / Integrated Console Display*, on page 2-20.
5. Check Regional, Date/Time, and Time Zone settings.
6. Place the Microsoft Windows CD–Rom in the corresponding drive. The setup wizard is launched automatically and guides the Customer and the Customer Service Engineer through the setup completion procedure (approximately 30 minutes).

Once setup is complete, Microsoft Windows shuts down, the system domain is rebooted and the server configuration wizard is launched automatically.



Note:

Server configuration is a Customer–specific task and is not performed by the Customer Service Engineer during installation. Once the system has been fully installed, the Customer Administrator may launch this wizard to configure and manage Server Roles.

7. Close the server configuration wizard.
8. Shut down the domain and associated hardware components by selecting the **Shut Down** command in the **Start Menu**.
9. Toggle the local / integrated console from the domain display to the PAP unit display.
See *Toggling the Local / Integrated Console Display*, on page 2-20.
10. Update **Domain Identity Management Parameters**:
 - a. From the Customer Administrator PAM Tree, click **Domains** → **Identities**.
 - b. Select the corresponding **Domain Identity** and click **Edit**. The **Edit Identity** dialog opens.
 - c. Complete the **Network Name**, **IP Address**, and **URL** fields with the data entered during the setup completion procedure.
11. **SCSI Disk Racks**
Lock the disks unlocked before launching the setup completion procedure.
12. Repeat steps 3 to 11 for each pre–installed Microsoft Windows instance.

Linux RedHat Setup

1. SCSI Disk Racks

Locate the corresponding SCSI disk rack and unlock all system and data disks not used by the current Operating System instance. See *Preparing SCSI Disk Racks*, on page 2-48.

FC Disk Racks

No action.

2. Select the first Linux RedHat domain in the **Control** pane scheme and click **Power On** to power up the domain and associated hardware components.
3. Toggle the local / integrated console from the PAP unit display to **MyOperations–1** or , **MyOperations–2**, **MyOperations–3**, or **MyOperations–4** display, as required. See *Toggling the Local / Integrated Console Display*, on page 2-20.
4. Check Regional, Date/Time, and Time Zone settings.
5. Place the Linux RedHat CD–Rom in the corresponding drive. Setup is completed via the Webmin administration tool:

- a. Enter the Webmin URL:

http://<localhost>:10000. The **Login to Webmin** dialog box opens.

- b. Enter the default User Name and Password, followed by **Enter**. The Webmin home page opens.

User Name	root
Password	root

- c. Click the **Networking** icon to open the Networking main page.
 - d. Click **Network Configuration** → **Network Interfaces**. In the **Interfaces Activated at Boot Time** field, click **Add a new interface** to open the **Create Bootup Interface** configuration page. Complete the required fields with the data supplied by the Customer and click **Create**.
 - e. From the **Interfaces Activated at Boot Time** field, select the new interface. The **Edit Bootup Interface** page opens. Check settings and click **Save and Apply** → **Return to network configuration**.
 - f. Click **Routing and Gateways** to open the **Routing and Gateways** configuration page. Complete the required fields with the data supplied by the Customer and click **Save** → **Return to network configuration**.
 - g. Click **DNS Client** to open the **DNS Client Options** configuration page. Complete the required fields with the data supplied by the Customer and click **Save** → **Return to network configuration**.
 - h. Click **Host Addresses** → **Add a new host address** to open the **Host and Addresses** configuration box. Complete the required fields with the data supplied by the Customer and click **Create** → **Return to host addresses list** → **Return to network configuration** → **Return to index** → **System** → **Bootup and Shutdown** to create a new bootup and shutdown action.
 - i. From the action list, select **Network** to display the **Edit Action** page and click → **Restart Now** → **Return to action** → **Return to bootup and shutdown actions** → **Return to index** → **Log Out** to exit Webmin. Once setup is complete, the network is activated.
6. Shut down the domain and associated hardware components by selecting the **Shut Down** command in the **Start Menu**.
 7. Toggle the local / integrated console from the domain display to the PAP unit display. See *Toggling the Local / Integrated Console Display*, on page 2-20.
 8. Update **Domain Identity Management Parameters**:

- a. From the Customer Administrator PAM Tree, click **Domains** → **Identities**.
 - b. Select the corresponding **Domain Identity** and click **Edit**. The **Edit Identity** dialog opens.
 - c. Complete the **Network Name**, **IP Address**, and **URL** fields with the data entered during the setup completion procedure.
9. **SCSI Disk Racks**
Lock the disks unlocked before launching the setup completion procedure.
10. Repeat steps 1 to 9 for each pre-installed Linux Redhat instance.

Linux SuSe Setup

1. **SCSI Disk Racks**
Locate the corresponding SCSI disk rack and unlock all system and data disks not used by the current Operating System instance. See *Preparing SCSI Disk Racks*, on page 2-48.
- FC Disk Racks**
No action.
2. Select the first Linux SuSe domain in the **Control** pane scheme and click **Power On** to power up the domain and associated hardware components.
3. Toggle the local / integrated console from the PAP unit display to **MyOperations–1** or , **MyOperations–2**, **MyOperations–3**, or **MyOperations–4** display, as required. See *Toggling the Local / Integrated Console Display*, on page 2-20.
4. Check Regional, Date/Time, and Time Zone settings.
5. Place the Linux SuSe CD–Rom in the corresponding drive. Setup is completed via the Yast Control Center administration tool:
 - a. Type the default User Name and Password, followed by **Enter**.

User Name	root
Password	root
 - b. Enter **yast2** (graphical mode) or **yast** (non-graphical mode) to open the Yast Control Center main page.



Note:

Use the <Tab> and <Arrow> keys to navigate through the menus.

- c. Click **Network/Basic** → **Network Card Configuration**.
 - d. Select the required network card and click **Configure**.
 - e. From the **Network Address Setup** page, select the setup method and complete the required fields with the data supplied by the Customer.
 - f. From the **Details settings** area, click **Host name and name server**. Complete the required fields and click **Next**.
 - g. From the **Details settings** area, click **Routing**. Complete the required fields and click **Next** to return to the **Network Card Configuration** page. Your network card is displayed in the **Already configured devices** area.
 - h. Click **Close** to exit Yast Control Center. Once setup is complete, the network is activated.
6. Shut down the domain and associated hardware components by selecting the **Shut Down** command in the **Start Menu**.
7. Toggle the local / integrated console from the domain display to the PAP unit display. See *Toggling the Local / Integrated Console Display*, on page 2-20.
8. Update **Domain Identity Management Parameters**:

- a. From the Customer Administrator PAM Tree, click **Domains** → **Identities**.
 - b. Select the corresponding **Domain Identity** and click **Edit**. The **Edit Identity** dialog opens.
 - c. Complete the **Network Name**, **IP Address**, and **URL** fields with the data entered during the setup completion procedure.
9. **SCSI Disk Racks**
Lock the disks unlocked before launching the setup completion procedure.
10. Repeat steps 1 to 9 for each pre-installed Linux SuSE instance.

Preparing SCSI Disk Racks



Important:

Only the system / spare disks used by the current Operating System instance must be accessible. Optional data disk drives must be unlocked, as shown in the following figures.

SJ-0812 SCSI JBOD Disk Racks

Two domains share a disk rack with system and optional data disks. System and spare disks are located in the same slots in each disk rack.

MyOperations-1 and **MyOperations-2** share the same disk rack. **MyOperations-1** is connected to the SCSI HBA adapter located in Module0, IOB0, Slot 01 (Port A) and **MyOperations-2** is connected to the SCSI HBA adapter located in Module0, IOB1, Slot 01 (Port A).

MyOperations-3 and **MyOperations-4** share the same disk rack. **MyOperations-3** is connected to the SCSI HBA adapter located in Module1, IOB0, Slot 01 (Port A) and **MyOperations-4** is connected to the SCSI HBA adapter located in Module1, IOB1, Slot 01 (Port A).

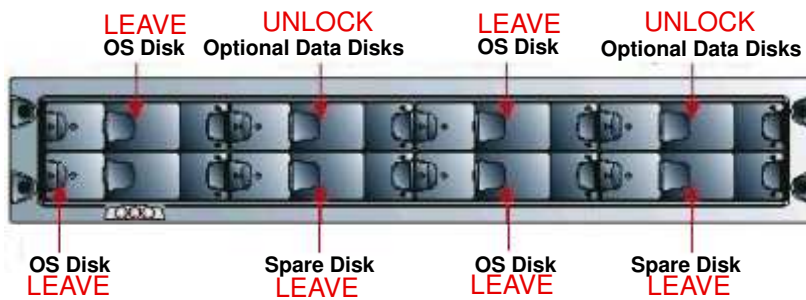

Figure 70. SJ-0812 SCSI JBOD disk racks – all domains

SR-0812 SCSI RAID Disk Racks

Each domain has its own disk rack with system and optional data disks. System and spare disks are located in the same slots in each disk rack.

MyOperations-1 disk rack is connected to the SCSI HBA adapter located in Module0, IOB0, Slot 01 (Port A).

MyOperations-2 disk rack is connected to the SCSI HBA adapter located in Module0, IOB1, Slot 01 (Port A).

MyOperations-3 disk rack is connected to the SCSI HBA adapter located in Module1, IOB0, Slot 01 (Port A).

MyOperations-4 disk rack is connected to the SCSI HBA adapter located in Module1, IOB1, Slot 01 (Port A).

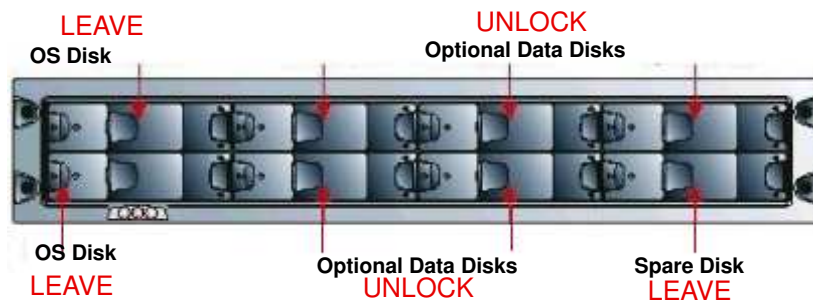

Figure 71. SR-0812 SCSI RAID disk racks – all domains

SJ-0812 SCSI Extension Disk Racks

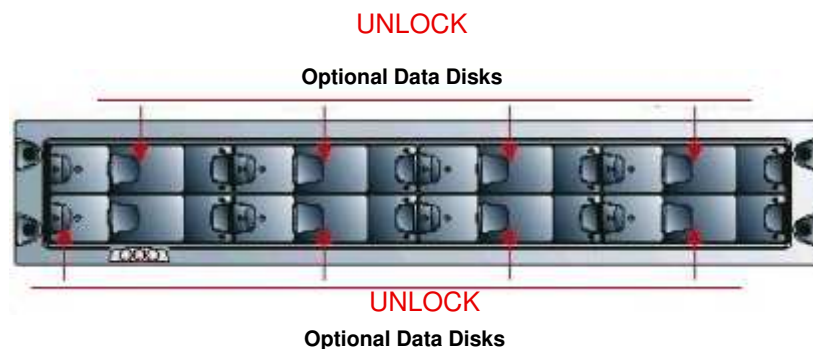

Figure 72. SJ-0812 extension disk location (data) – All domains

Unlocking Disk Drives

1. Before proceeding to complete Operating System setup, use a Torx T10 screwdriver to open the optional disk drive anti-tamper lock, the indicator becomes black.
2. Press the carrier latch to release the handle.
3. Wait 30 seconds.

Locking Disk Drives

1. Once Operating System setup is complete, use a Torx T10 screwdriver to close the optional disk drive anti-tamper lock, the indicator becomes red.
2. Check drive LED status. If the lock is correctly closed, both LEDs should be lit.

Connecting the Server to the Enterprise LAN



Important:

Extra cable lengths of 1.5 meters are required for maintenance. These extra cable lengths must be absorbed in the plenum space under the cabinet.

At the Customer's request, server domains server can be connected to the Enterprise LAN for remote operation. The server offers two LAN connection options for each domain:

- via the IOR for a **10/100 Mb/s** network,
- via an optional Gigabit Ethernet PCI adapter for a **1 Gb/s** network.

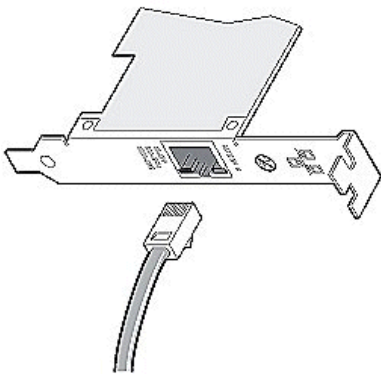

Figure 73. 1Gb/s network connection

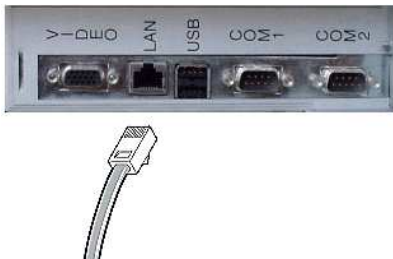

Figure 74. 10/100 Mb/s network connection

To connect server domain(s) to the Enterprise LAN:

NovaScale 6xx0 Servers

3. Locate the corresponding IOB / IOR network ports for each domain:

MyOperations–1: Module0, IOB0, IOR0

MyOperations–2: Module0, IOB1, IOR1

MyOperations–3: Module1, IOB0, IOR0

MyOperations–4: Module1, IOB1, IOR1

4. Connect the network cable equipped with an RJ45 connector to the IOR LAN port or to the optional Gigabit Ethernet PCI adapter. Network connections are detected automatically.
5. Carefully route network cables through the cable inlet at the base of the cabinet.

Connecting the USB Modem and External Devices

Connecting the USB Modem

If the Customer's maintenance contract includes the Autocall feature, connect the USB modem as follows:

1. Connect the modem cable equipped with a USB connector to the USB port on the rear of the PAP unit.
2. Route the line modem cable equipped with an RJ11 connector through the cable cut-out at the base of the cabinet.
3. Connect the modem cable to the line port on the rear of the USB modem.
See *Cabling Diagrams*, on page C-1. See *Cabling Diagrams*, on page 0.



Note:

Modem cable connectors differ from country to country. Customers are to provide the RJ11 adapter required to comply with national standards.

Connecting External Storage Peripherals

The Customer may now proceed to connect any external storage peripherals (tape libraries, external disk subsystems, ...) required for use with the server.

Testing Network Connections

Network connections to the PAP unit and to server domains can be tested from a remote workstation connected to the same network by launching a PING command.



Note:

PAP unit setup is described in *Completing PAP Unit Configuration*, on page 2-29.

Windows Workstation

1. Click **Start** → **Run** and enter **cmd**.
2. Enter **ping <IP_address>**, (where <IP_address> is the IP address allocated to the PAP unit or server domain during setup).

Linux Workstation

1. Open a Shell command window.
2. Enter **ping <IP_address>**, (where <IP_address> is the IP address allocated to the PAP unit or server domain during setup).



Note:

If the PAP unit or server domain does not reply to the PING command, check network connections and configuration:

- IP address,
- DHCP,
- Network mask,
- Network card driver.

Testing Autocalls

If the Customer's maintenance contract includes the Autocall feature, check the connection between the PAP unit and the Remote Maintenance Center Server as follows:

1. From the PAM home page, click **Configuration Tasks** → **Autocalls**.
2. Click the **Test Autocall** button in the toolbar. A dialog appears to confirm that the autocall has been sent to the Remote Maintenance Center.

Completing the PAM Installation Intervention Report

Once system operation has been checked, an **Installation Intervention Report** must be completed. If the Customer's maintenance contract includes the Autocall feature, this report will be automatically transferred to the Remote Maintenance Center.



Note:

If the Customer's maintenance contract does not include the Autocall feature, manually complete the **Installation Work Order** provided in the **Open Me First** box. The intervention report is sent as an event message and stored in the PAM History directory. See the *User's Guide*.

1. From the PAM home page, click **Servicing Tools** → **Intervention Report**.
2. Complete the Intervention Report.
3. Click **Send**. If the Customer's maintenance contract includes the Autocall feature, the report is automatically transferred to the Remote Maintenance Center. If the Customer's maintenance contract does not include the Autocall feature, the report is sent as an event message and stored in the PAM History directory.

Renaming the Central Subsystem



Note:

Central Subsystem configuration is reserved for Customer Service Engineers.

The Central Subsystem may be renamed to suit Customer requirements. Changes to Central Subsystem configuration entail removing the existing Central Subsystem from the configuration and adding a new Central Subsystem to the configuration with the name chosen by the Customer.



Important:

Default Domain Schemes CANNOT be used by the new Central Subsystem and have to be re-defined.

Default Domain Identities CAN still be used and do not have to be re-defined.

Removing / Adding the Central Subsystem

1. From the Support Administrator PAM Tree, click **Domain Manager** to check that all domains are INACTIVE. If a domain is ACTIVE, request the Customer to power down the domain. See *Powering Up / Down Server Domains*, on page 0.
2. Click **Configuration Tasks** → **Central Subsystem**. The Central Subsystem management page opens.
3. Select the Central Subsystem and click **Remove**. A dialog opens requesting you to confirm removal.
4. Click **OK** to remove the Central Subsystem.
5. Click **New**. The **Add Central Subsystem** dialog appears.

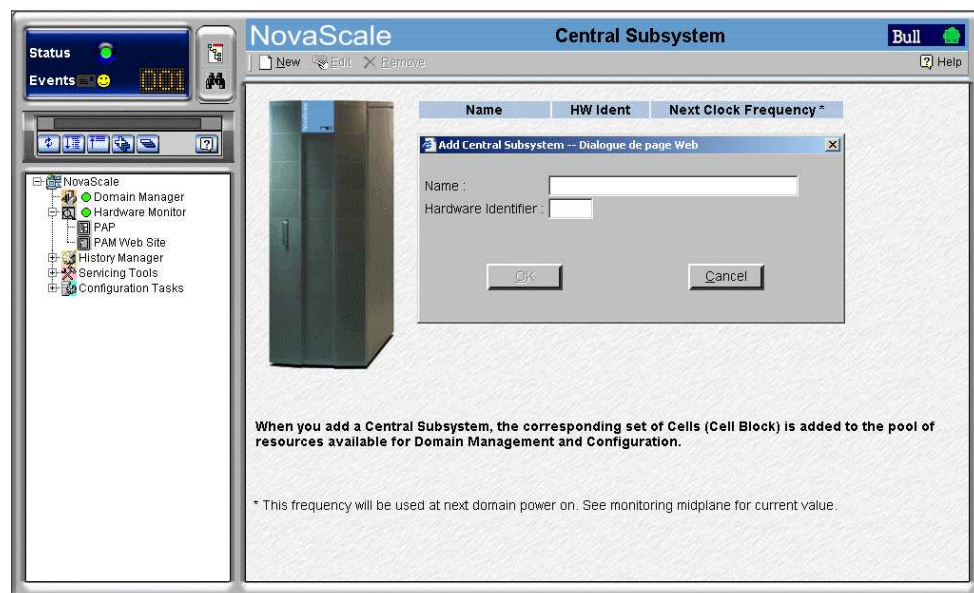

Figure 75. Central Subsystem configuration page

- Enter the Central Subsystem name supplied by the Customer and the hardware hexadecimal identifier (between 0 and F as indicated on the PMB CSS code wheel).

Configuration	Cabinet Hexadecimal Code (0 to F)	CSS Module Hexadecimal Code (0 to F)
NovaScale 6080/6160 Server	0	0
NovaScale 6320 Server	0 0	0 (module 0) 1 (module 1)



Note:

If more than one server is present in the Customer's configuration, increment cabinet hexadecimal code position accordingly, e.g. Cabinet 1 = Position 0, Cabinet 2 = Position 1, Cabinet 3 = Position 2, etc.

- Click **OK**. You are requested to update the PAM tree.

- Click the PAM tree **Refresh** button. The new Central Subsystem is added to the pool of resources available for domain management and configuration and appears in the PAM tree under the **Hardware Monitor** node.

Functional status icon & CSS availability status bar

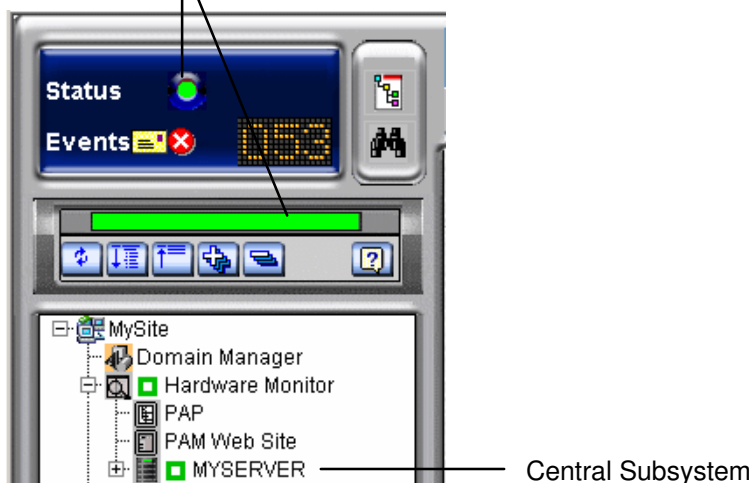

Figure 76. Central Subsystem node

- Check server status – system functional status icon and CSS availability status bar green in the Status pane. See Figure 56. Status pane, on page 2-18.

You must now redefine the default domain scheme, go to:

- *Redefining the Default Scheme* (NovaScale 6080/6160 Server), on page 2-55 or
- *Redefining the Default Scheme* (NovaScale 6320 Server), on page 2-58



Note:

PAM software allocates a PUID (PAM Universal / Unique Identifier) to each hardware / software object to guarantee unambiguous identification.

The PUID for a Central Subsystem is:

PAM:/CELLSBLOCK_<NAME>,

where <NAME> is the name allocated by the Customer when the Central Subsystem is declared.

The PUID for the Central Subsystem in the example shown above is:

PAM:/CELLSBLOCK_MYSERVER

Redefining the Default Scheme (NovaScale 6080/6160 Server)

Note:

In the screen shots used in this guide, an instance of Microsoft Windows is pre-installed on **MyOperations-1** and an instance of Linux is pre-installed on **MyOperations-2**.

1. From the Customer Administrator PAM Tree, click **Configuration Tasks** → **Domains** → **Schemes** to open the **Schemes Management** pane.
2. Select **MyOperationsScheme** click **Delete**.
3. Click **New** to open the **Scheme Creation** dialog and complete the fields as follows:

Field	Value
Scheme	MyOperationsScheme
Description	Default scheme for <MyServer>*

* <MyServer> = New Central Subsystem name given by the Customer

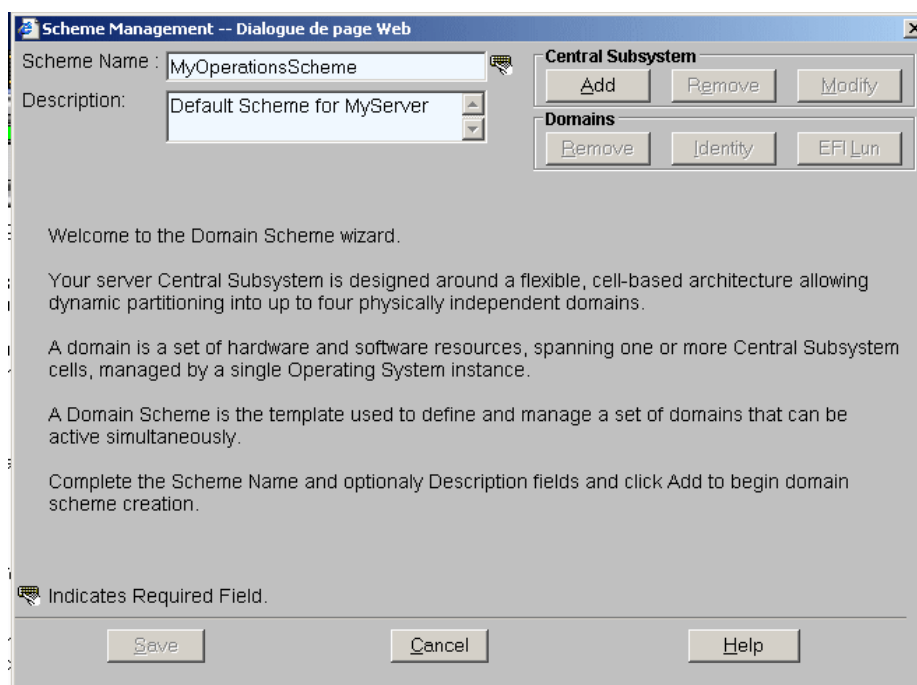

Scheme Management -- Dialogue de page Web

Scheme Name : MyOperationsScheme

Description: Default Scheme for MyServer

Central Subsystem
Add Remove Modify

Domains
Remove Identity EFI Lun

Welcome to the Domain Scheme wizard.

Your server Central Subsystem is designed around a flexible, cell-based architecture allowing dynamic partitioning into up to four physically independent domains.

A domain is a set of hardware and software resources, spanning one or more Central Subsystem cells, managed by a single Operating System instance.

A Domain Scheme is the template used to define and manage a set of domains that can be active simultaneously.

Complete the Scheme Name and optionally Description fields and click Add to begin domain scheme creation.

 Indicates Required Field.

Save Cancel Help

Figure 77. Scheme creation page

- Click **Central Subsystem** → **Add** to select the previously declared Central Subsystem. The **Central Subsystem Configuration** dialog opens.

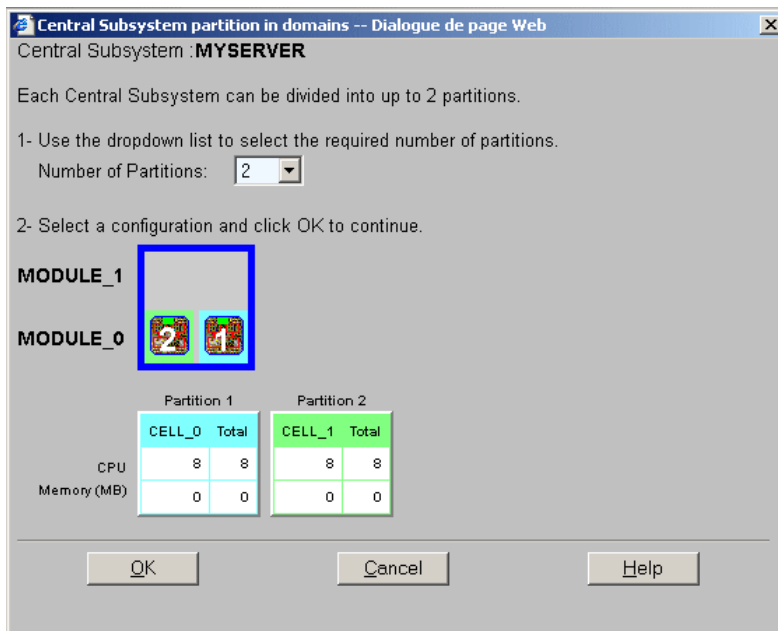

Figure 78. Central Subsystem Configuration dialog

- Check that the Central Subsystem is highlighted and select **2** in the **Number of Parts** dropdown list. Click **OK** to return to the **Scheme Management** dialog. **Status** icons are red because a domain **Identity** is required to complete domain configuration.

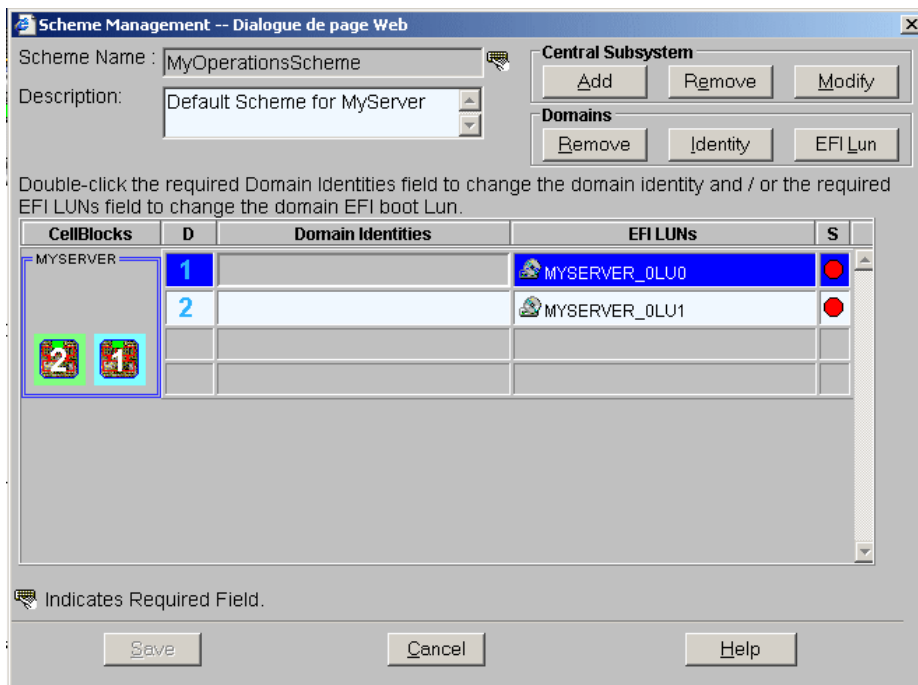

Figure 79. Scheme Management dialog

- Double click the empty **D1 Identities** field and select **MyOperations-1** from the list of available identities. The corresponding **Status** icon turns green.

7. Double click the empty **D2 Identities** field and select **MyOperations–2** from the list of available identities. The corresponding **Status** icon turns green.

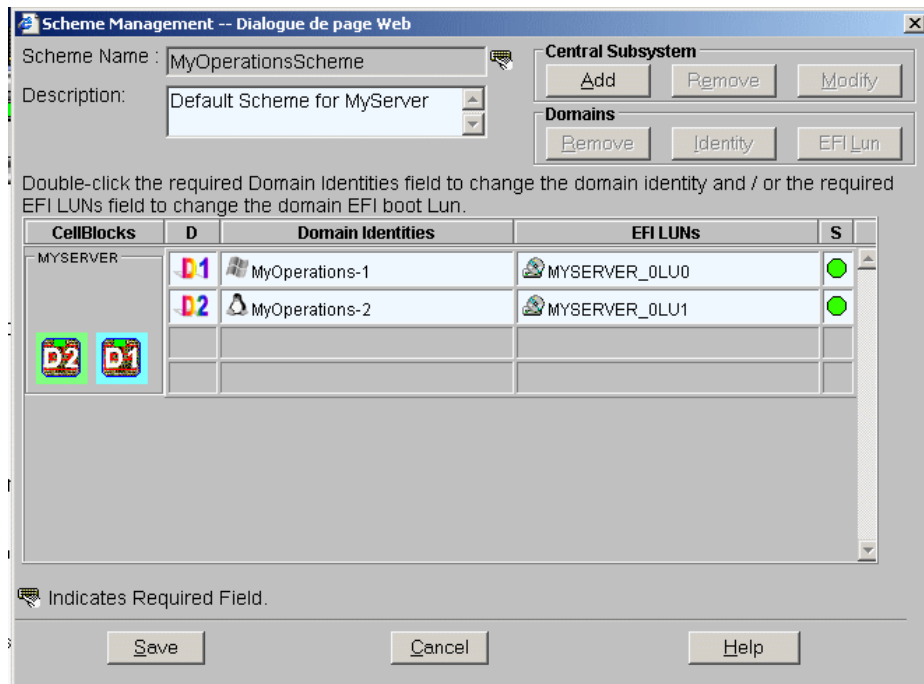

Figure 80. Scheme Management dialog

8. Click **Save**. The re–defined default domain scheme is now available for domain management.



Note:

For further details about domain configuration, see *Configuring Domains* in the *User’s Guide*.

Redefining the Default Scheme (NovaScale 6320 Server)



Note:

In the screen shots used in this guide, an instance of Microsoft Windows is pre-installed on **MyOperations-1** and **MyOperations-3** and an instance of Linux is pre-installed on **MyOperations-2** and **MyOperations-4**.

1. From the Customer Administrator PAM Tree, click **Configuration Tasks** → **Domains** → **Schemes** to open the **Schemes Management** pane.
2. Select **MyOperationsScheme** click **Delete**.
3. Click **New** to open the **Scheme Creation** dialog and complete the fields as follows:

Field	Value
Scheme	MyOperationsScheme
Description	Default scheme for <MyServer>*

* <MyServer> = New Central Subsystem name given by the Customer

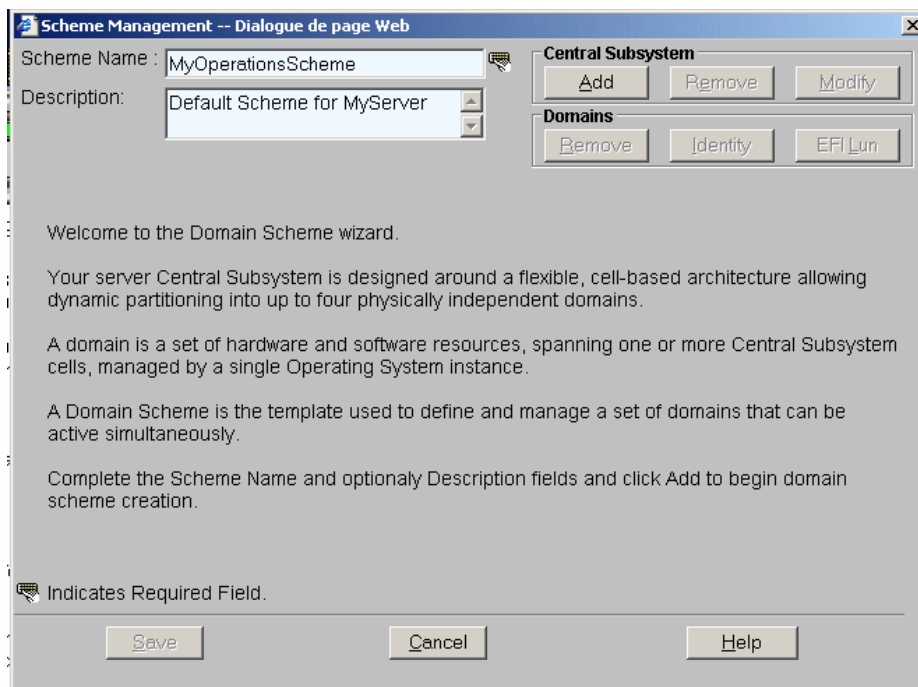

Figure 81. Scheme creation page

- Click **Central Subsystem** → **Add** to select the previously declared Central Subsystem. The **Central Subsystem Configuration** dialog opens.

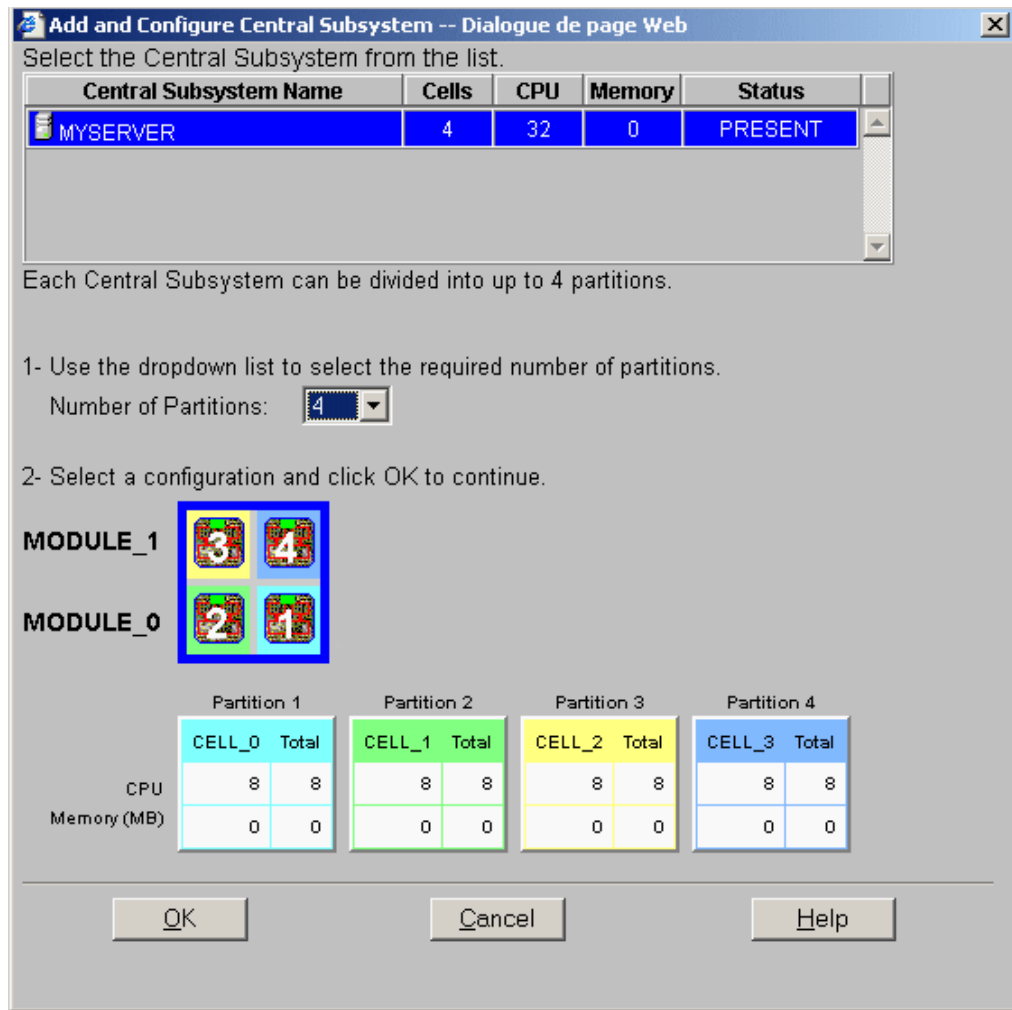

Figure 82. Central Subsystem Configuration dialog

- Check that the Central Subsystem is highlighted and select **4** in the **Number of Parts** dropdown list.
- Click **OK** to return to the **Scheme Management** dialog. **Status** icons are red because a domain **Identity** is required to complete domain configuration.

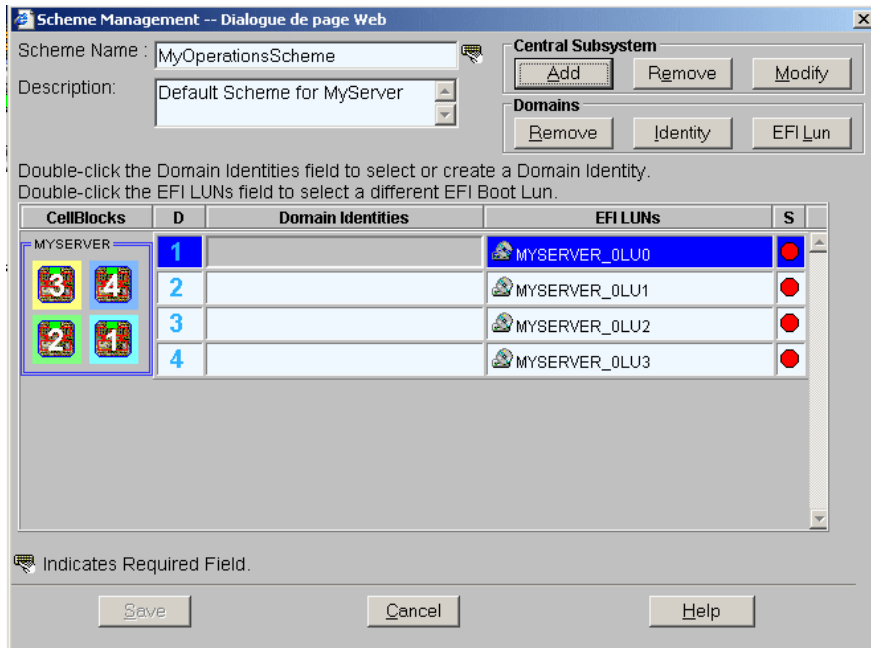

Figure 83. Scheme Management dialog

7. Double click the empty **D1 Identities** field and select **MyOperations–1** from the list of available identities. The corresponding **Status** icon turns green.
8. Repeat Step 7 for each empty **Domain Identities** field, taking care to select **MyOperations–2** for **D2**, **MyOperations–3** for **D3**, **MyOperations–4** for **D4** from the list of available identities. All the **Status** icons turn green.

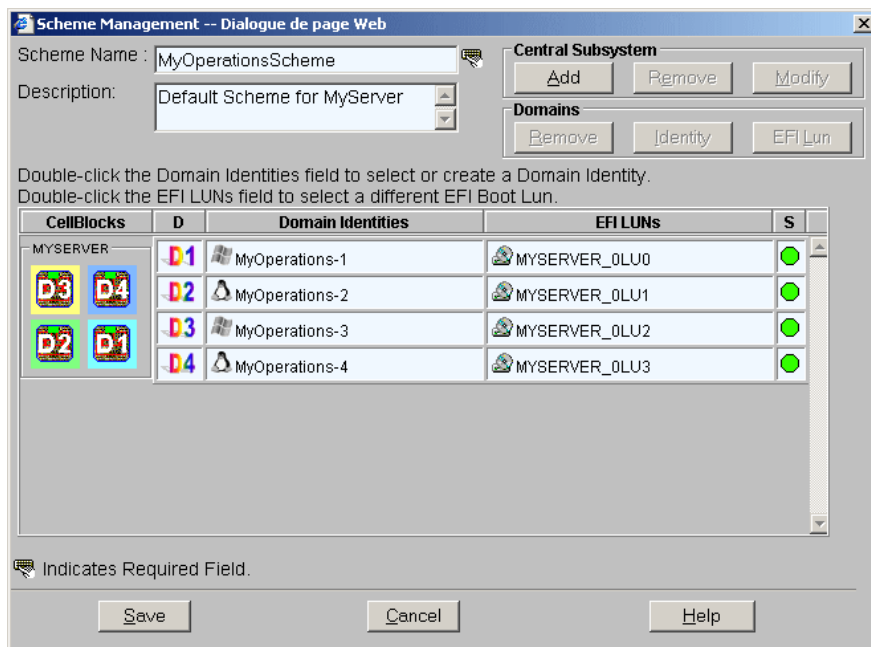

Figure 84. Scheme Management dialog

9. Click **Save**. The re–defined default domain scheme is now available for domain management.



Note:

For further details about domain configuration, see *Configuring Domains* in the *User's Guide*.

Setting up PAP Unit Users

The Customer Administrator should now set up at least one Customer Administrator and one Customer Operator user account to ensure controlled access to the PAP unit.

The Microsoft Windows operating system pre-installed on the PAP unit provides standard security features for controlling access to applications and resources. PAM software security is based on Windows user management and you are advised to give Windows administrator rights to at least one member of the PAP Customer Administrator user group. For further details about user management, refer to the Microsoft Windows documentation on the Bull NovaScale Server System Resource CD.



Note:

You are advised to change the temporary Administrator password (**administrator**) used for setup purposes and to maintain a detailed record of authorized users.

Predefined PAP User Groups

For optimum security and flexibility, the Microsoft Windows software environment is delivered with two predefined Customer user groups:

Pap_Customer_Administrators Group (CA)

This group is designed for customer representatives responsible for the overall management, configuration, and operation of the system. Members of the Customer Administrator group are allowed to configure and administrate the server and have full access to the PAM **Domain Manager**, **Hardware Monitor**, **History Manager** and **Configuration Tasks** menus, as shown in Table 7.

Pap_Customer_Operators (CO)

This group is designed for customer representatives responsible for the daily operation of the system. Members of the Customer Operator group are allowed to operate the server and have full access to the **Domain Manager** menu and partial access to the **History Manager** menu, as shown in Table 7.



Notes:

- Group membership also conditions which Event Messages a user will receive via the PAM Web interface. See *Setting up Event Subscriptions*, in the User's Guide.
- The two predefined Support user groups:
 - **Pap_Support_Administrators**
 - **Pap_Support_Operators**are reserved EXCLUSIVELY for Customer Service Engineers responsible for monitoring, servicing, and upgrading the system.
- The predefined Customer user groups have been designed to suit the needs of most Administrator and Operators. Contact your Customer Service Engineer if you require a customized user group.

PAM Tools	Associated Actions	CA	CO
Domain Manager	Load/delete domains	X	X
	Power on/off/reset domains	X	X
	View/modify domain settings	X	X
	View domain status	X	X
	View domain resources	X	X
	View BIOS info	X	X
	View BIOS version	X	X
	View loaded BIOS image	X	X
	View power logs	X	X
	View request logs	X	X
	Request a system dump	X	X
Hardware Monitor	View hardware functional/presence status	X	
	View detailed hardware status information	X	
	Use the hardware Search engine	X	
	Exclude/include hardware components	X	
	View current PAM Web site user information	X	
	View PAM version information	X	
History Manager	View system history files and messages	X	
	Manually archive system history files	X	
	View/delete system history archives	X	
	View user history files	X	X
	Manually archive user history files	X	X
	View/delete user history archives	X	X
Configuration Tasks	View/modify customer information	X	
	Modify the system history automatic archiving policy	X	
	Create/modify/delete domain schemes and identities	X	
	Modify domain schemes and identities	X	
	Create/delete user histories	X	
	Modify user history automatic archiving policy	X	
	Customize the event messaging system	X	
	View/ modify PAM parameters	X	
	Display/modify autocall parameters	X	
Status Pane	View/acknowledge WEB event messages	X	X
	Check system functional status	X	X
	Check CSS availability	X	X

Table 7. User access to PAM features

CA = Customer Administrator

CO = Customer Operator

Backing Up and Restoring PAM Configuration Files

The Customer Administrator should now set up an automatic backup task via the Microsoft Windows **Task Scheduler** to save PAM configuration data to a removable media or network directory for rapid restoration in the event of a PAP unit failure.

PAM software can be deployed on any standard PC running the appropriate version of Microsoft Windows and you can restore your configuration data to rebuild your working environment.

PAM configuration data is automatically saved to the default PAM Site Data directory on the PAP unit:

<WinDrive>:\Program Files\BULL\PAM\PAMSiteData<DataCompatibilityRelease>

To ensure carefree, reliable and regular configuration data backup, the Bull NovaScale Server Resource CD contains two scripts, **PamBackupData.js** and **PamRestoreData.js**, that can be scheduled to run via the Microsoft Windows **Task Scheduler**.



Note:

The **PamBackupData.js** and **PamRestoreData.js** scripts can also be stored in the PAM Site Data directory on the PAP unit:

<WinDrive>:\Program Files\BULL\PAM\PAMSiteData\ReleaseData\Utilities



Warning:

The same PAM software release must be deployed on the PAP unit and on the backup PC to allow data restoration.

PAM releases use the same data directory to ensure configuration consistency.

Before activating / re-activating a PAM Version, ensure that the <Data Compatibility Release> level of deployed releases is compatible.

Backing Up PAM Configuration Files

To create a Microsoft Windows automatic backup task:

1. Select or create the local or network directory to be used for saving configuration data, e.g. **<MyPamBackupDirectory>**.
2. Create a local directory for the **PamBackupData.js** and **PamRestoreData.js** script files, e.g. **<MyPamBackupTools>**.
3. Copy the **PamBackupData.js** and **PamRestoreData.js** script files into the **<MyPamBackupTools>** directory.
4. Create a Text File and enter the following command line:
Cscript PamBackupData.js <MyPamBackupDirectory>
5. Save the Text File as a batch file with a **.BAT** extension, e.g. **<MyPamBackupCommand>.bat**.
6. Click **Control Panel** → **Scheduled Tasks** → **Add Scheduled Task** to open the **Task Scheduler** wizard and follow the instructions. PAM configuration data will be automatically saved at the interval indicated in the wizard.



Note:

When requested to select a program, select the **<MyPamBackupCommand>.bat** batch file.

Restoring PAM Configuration Data

To restore PAM configuration data:

1. If required, install the same PAM software release on the backup PC as on the PAP unit. See *Deploying a New PAM Release*, on page 0 and *Activating a PAM Version*, on page 0.
2. From the Microsoft Windows desktop, open a command window. Browse to the **<MyPamBackupTools>** directory containing the script files and enter the following command line:

```
Cscript PamRestoreBackupData.js <MyPamBackupDirectory>
```

Saved PAM configuration data is restored.

Chapter 3. Troubleshooting

This chapter describes what to do if a problem occurs during installation. It includes the following topics:

- Server power, on page 3-2
- Mouse, on page 3-3
- Keyboard, on page 3-4
- Monitor, on page 3-5
- KVM Switch, on page 3-6
- PAP Unit, on page 3-7
- Disk Rack, on page 3-8
- CD/DVD Drive, on page 3-9
- Operating System, on page 3-10
- PAM Software, on page 3-11

Server Power

Problem	Possible Cause	Solution
The server does not power up to standby.	The CSS module power cable is not connected or is incorrectly connected to the AC outlet.	<i>Check the CSS module power cable connection. Connect or reconnect the power cable to the AC outlet.</i>
	The AC outlet is faulty.	<i>Try another AC outlet.</i>
	The AC source is missing.	<i>Call the site electrician to check the AC source.</i>
	The AC power cable is faulty.	<i>Check the AC power cable for faults. Replace the faulty cable.</i>
The operating system does not boot.	The disk rack power button is not set to ON.	<i>Check the power button on the rear of the disk rack. Set to ON (I).</i>
	System disks are incorrectly inserted in the disk rack.	<i>Check system disk status LEDs. If the status LEDs are not green, reinsert system disks.</i>
	The disk rack power cable is not connected or is incorrectly connected to the PDU.	<i>Check the disk rack power cable connection. Connect or reconnect the power cable to the PDU.</i>
	The PDU power cable is not connected or is incorrectly connected to the AC outlet.	<i>Check the PDU power cable connection. Connect or reconnect the power cable to the AC outlet.</i>
	The PDU circuit breaker is not ON.	<i>Check the PDU circuit breaker and turn ON if required.</i>
	The AC outlet is faulty.	<i>Try another AC outlet.</i>
	The AC source is missing.	<i>Call the site electrician to check the AC source.</i>
	Internal cables are not connected or are incorrectly connected to their dedicated ports.	<i>Check data cable connections. Connect or reconnect cables to their dedicated ports.</i>
	An internal cable is faulty.	<i>Check internal cables for faults. Replace the faulty cable.</i>
The server does not power down (an activated domain cannot be powered down).	Domain Operating System power management settings do not allow PAM software to power down the domain.	<i>Check domain Operating System power management settings and change if required. See User's Guide.</i>
	The domain Operating System is not responding.	<i>Click Force Power OFF to shut down the domain Operating System.</i>
The PAM functional status icon is not green.		<i>See User's Guide.</i>
The PAM presence status bar is not green.		<i>See User's Guide.</i>

Mouse

Problem	Possible Cause	Solution
The mouse does not move the cursor or there is no cursor on the screen.	The mouse signal has not been reset.	Press the Control key twice to access the Command Menu. Enter the KVM Command Mode.: Press and hold down the Num Lock key. Press and release the (-) key. Type MR (mouse reset). Press the Enter key to accept and exit the KVM Command Mode.
	Internal cables are not connected or are incorrectly connected to their dedicated ports.	Check internal cable connections: – Mouse to KVM, – KVM to PAP, – IOR to KVM. Connect or reconnect cables to their dedicated ports.
	The KVM switch power button is not set to ON.	Check the power button on the rear of the KVM switch. Set to ON (I).
	The KVM switch power cable is not connected or is incorrectly connected to the PDU.	Check the KVM switch power cable connection. Connect or reconnect the power cable to the PDU.
	The PDU power cable is not connected or is incorrectly connected to the AC outlet.	Check the PDU power cable connection. Connect or reconnect the power cable to the AC outlet.
	The PDU circuit breaker is not ON.	Check the PDU circuit breaker and turn ON if required.
	The AC outlet is faulty.	Try another AC outlet.
	The AC source is missing.	Call the site electrician to check the AC source.
	An internal cable is faulty.	Check internal cables for faults. Replace the faulty cable.

Keyboard

Problem	Possible Cause	Solution
The keyboard does not function.	The KVM switch power button is not set to ON.	<i>Check the power button on the rear of the KVM switch. Set to ON (I).</i>
	Internal cables are not connected or are incorrectly connected to their dedicated ports.	<i>Check internal cable connections: – Keyboard to KVM, – KVM to PAP, – IOR to KVM Connect or reconnect cables to their dedicated ports.</i>
	The KVM switch power cable is not connected or is incorrectly connected to the PDU.	<i>Check the KVM switch power cable connection. Connect or reconnect the power cable to the PDU.</i>
	The PDU power cable is not connected or is incorrectly connected to the AC outlet.	<i>Check the PDU power cable connection. Connect or reconnect the power cable to the AC outlet.</i>
	The PDU circuit breaker is not ON.	<i>Check the PDU circuit breaker and turn ON if required.</i>
	The AC outlet is faulty.	<i>Try another AC outlet.</i>
	The AC source is missing.	<i>Call the site electrician to check the AC source.</i>
	An internal cable is faulty.	<i>Check internal cables for faults. Replace the faulty cable.</i>

Monitor

Problem	Possible Cause	Solution
The monitor does not power up (the status LED on the monitor is not alight).	The monitor power button is not set to ON.	<i>Check that the power button on the front of the monitor is ON. Check that the vacation switch on the right-hand side of the monitor is ON. Turn the power button / vacation switch ON.</i>
	The monitor power cable is not connected or is incorrectly connected to the PDU.	<i>Check the monitor power cable connection. Connect or reconnect the power cable to the PDU.</i>
	The PDU power cable is not connected or is incorrectly connected to the AC outlet.	<i>Check the PDU power cable connection. Connect or reconnect the power cable to the AC outlet.</i>
	The PDU circuit breaker is not ON.	<i>Check the PDU circuit breaker and turn ON if required.</i>
	The server is not powered up.	<i>Power up the server.</i>
	The AC outlet is faulty.	<i>Try another AC outlet.</i>
	The AC source is missing.	<i>Call the site electrician to check the AC source.</i>
	The AC power cable is faulty.	<i>Check the AC power cable for faults. Replace the faulty cable.</i>
The status LED on the monitor is alight but there is no display on the screen.	The monitor contrast and / or brightness settings are too low.	<i>Use the buttons on the front of the monitor to adjust contrast and / or brightness settings.</i>
	The KVM switch power cable is not connected or is incorrectly connected to the PDU.	<i>Check the KVM switch power cable connection. Connect or reconnect the power cable to the PDU.</i>
	The KVM switch power button is not set to ON.	<i>Check the power button on the rear of the KVM switch. Set to ON (I).</i>
	The KVM is not set to the correct port (Port A – PAP, Port B – Microsoft Windows, Port C – Linux).	<i>Press the Control key twice to access the Command Menu. Select the required channel with the ↑↓ keys. Press Enter to activate the selected channel and exit the Command Mode. If the KVM cannot be accessed or switched, see KVM Switch on page 3-6.</i>
	Internal video cables are not connected or are incorrectly connected to their dedicated ports.	<i>Check internal video cable connections: – Monitor to KVM, – KVM to PAP, – IOR to KVM Connect or reconnect video cables to their dedicated ports.</i>
	An internal cable is faulty.	<i>Check internal cables for faults. Replace the faulty cable.</i>

KVM Switch

Problem	Possible Cause	Solution
The green status / channel LEDs on the front of the KVM unit are not alight.	The KVM unit is not powered up.	<i>Check the power button on the rear of the KVM unit. Turn to ON (I).</i>
	The KVM unit power cable is not connected or is incorrectly connected to the PDU.	<i>Check the KVM unit power cable connection. Connect or reconnect the power cable to the PDU.</i>
	The PDU power cable is not connected or is incorrectly connected to the AC outlet.	<i>Check the PDU power cable connection. Connect or reconnect the power cable to the AC outlet.</i>
	The PDU circuit breaker is not ON.	<i>Check the PDU circuit breaker and turn ON if required.</i>
	The AC outlet is faulty.	<i>Try another AC outlet.</i>
	The AC source is missing.	<i>Call the site electrician to check the AC source.</i>
	The AC power cable is faulty.	<i>Check the AC power cable for faults. Replace the faulty cable.</i>
The status LED on the front of the KVM unit is RED.	Internal unit failure.	<i>Replace the KVM.</i>
The KVM cannot be accessed or switched.	The KVM unit is in secure mode (lock symbol on OSD screen).	<i>If the KVM has been configured to the secure mode, enter the password at the prompt. Refer to the manufacturer's documentation for further information.</i>
	An internal cable is faulty.	<i>Check internal cables for faults. Replace the faulty cable.</i>

PAP Unit

Problem	Possible Cause	Solution
The PAP unit does not power up (the status LED on the PAP unit is not alight).	The PAP unit power switch is not set to ON.	Press the power button on the front of the PAP unit .
	BIOS settings are incorrect.	Press F2 during the power-on sequence to enter BIOS Setup. 1. Set the "After Power Failure" parameter to "Power ON". 2. Save Settings and Exit.
	The PAP unit power cable is not connected or is incorrectly connected to the PDU.	Check the PAP unit power cable connection. Connect or reconnect the power cable to the PDU.
	The PDU power cable is not connected or is incorrectly connected to the AC outlet.	Check the PDU power cable connection. Connect or reconnect the power cable to the AC outlet.
	The PDU circuit breaker is not ON.	Check the PDU circuit breaker and turn ON if required.
	The AC outlet is faulty.	Try another AC outlet.
	The AC source is missing.	Call the site electrician to check the AC source.
	The AC power cable is faulty.	Check the AC power cable for faults. Replace the faulty cable.
	POST is in progress.	Wait a while. The status LED will turn green once the POST is completed.
The status LED on the PAP unit is alight but the PAP unit does not boot.	Incorrect boot sequence.	Press the reset button on the front of the PAP unit.
The PAP unit does not boot.	PAP unit disks are incorrectly inserted.	Check disk status LEDs. If the status LEDs are not green, reinsert the disks.
The PAP unit cannot be accessed via the internal network.	The LAN cable is not connected or is incorrectly connected to the IOR in the CSS module.	Check the PAP unit LAN cable connection. Connect or reconnect the LAN cable to the IOR in the CSS module.
PAM software cannot be launched.	The KVM switch is not set to the correct port (Port A – PAP). The green channel 1 (PAP) LED on the front of the KVM switch is not alight (another channel LED is alight).	Press the Control key twice to access the KVM Command Menu, see <i>Toggling the Integrated Console</i> , on page 2-20. Select the PAP unit channel with the ↑↓ keys. Press Enter to activate the PAP unit channel and exit the Command Mode.
	An internal cable is faulty.	Check internal cables for faults. Replace the faulty cable.

Disk Rack

Problem	Possible Cause	Solution
The disk rack does not power up (the power on and power status LEDs on the disk rack are not alight).	The disk rack power switch is not set to ON.	<i>Press the power button on the front of the disk rack.</i>
	The disk rack power cable is not connected or is incorrectly connected to the PDU.	<i>Check the disk rack power cable connection. Connect or reconnect the power cable to the PDU.</i>
	The PDU power cable is not connected or is incorrectly connected to the AC outlet.	<i>Check the PDU power cable connection. Connect or reconnect the power cable to the AC outlet.</i>
	The PDU circuit breaker is not ON.	<i>Check the PDU circuit breaker and turn ON if required.</i>
	The AC outlet is faulty.	<i>Try another AC outlet.</i>
	The AC source is missing.	<i>Call the site electrician to check the AC source.</i>
The disk rack is not recognized by the server.	The interface cable(s) is (are) not connected or is (are) incorrectly connected to the HBA(s) in the CSS module.	<i>Check the disk rack interface cable connection. Connect or reconnect the interface cable(s) to the HBA(s) in the CSS module.</i>
	An internal cable is faulty.	<i>Check internal cables for faults. Replace the faulty cable.</i>
The disk rack is not recognized by the server.	Disk drives have not finished spinning up.	<i>Wait a while. The drive status LEDs will turn green once they have finished spinning up.</i>
	Disk drives have not been correctly installed.	<i>Check that all disk drive carriers are correctly installed.</i>
The disk rack cannot be accessed from the PAP unit.	The interface cable is not connected or is incorrectly connected to the COM port on the PAP unit.	<i>Check the interface cable connection. Connect or reconnect the interface cable to the COM port on the PAP unit. Refer to the manufacturer's documentation for further information.</i>
	An internal cable is faulty.	<i>Check internal cables for faults. Replace the faulty cable.</i>

CD-ROM Drive

Problem	Possible Cause	Solution
The inserted CD cannot be read.	The CD is faulty.	<i>Eject the CD. Check for visible faults. Reinsert and try to read it again. If the CD still cannot be read, try again with another CD. If the problem persists, see Maintenance and Service Guide.</i>

Operating System

Problem	Possible Cause	Solution
Microsoft Windows / Linux does not start.	Incorrect EFI boot option.	<i>See Maintenance and Service Guide.</i>
Microsoft Windows / Linux does not respond.	Program run error.	<i>Reboot the server.</i>
The server does not boot.	System disks are incorrectly inserted in the disk rack.	<i>Check system disk status LEDs. If the status LEDs are not green, reinsert system disks.</i>
The server does not power down (an activated domain cannot be powered down).	Domain Operating System power management settings do not allow PAM software to power down the domain.	<i>Check domain Operating System power management settings and change if required. See User's Guide.</i>
	The domain Operating System is not responding.	<i>Click Force Power OFF to shut down the domain Operating System.</i>

PAM Software

Problem	Possible Cause	Solution
<p>Internet Explorer does not connect to the PAM Web site.</p>	<p>The Maintenance LAN connection is incorrectly configured.</p>	<p><i>Check maintenance LAN settings. Configure or reconfigure if necessary:</i> <i>IP address: 10.10.240.240</i> <i>Subnet mask: 255.255.0.0</i> <i>No DNS</i> <i>No WINS</i></p> <p><i>Refer to the Microsoft Windows documentation for further information.</i></p>
<p>The server presence status bar is RED, indicating that the CSS Module has not been detected.</p>	<p>The PMB is not connected or is incorrectly connected to the PAP unit.</p>	<ol style="list-style-type: none"> 1. <i>Check the PMB to PAP unit internal network cable connection. Connect or reconnect the PMB to the PAP unit.</i> 2. <i>Check PAP unit network connection configuration. From the PAP Windows desktop, click Start → Settings → Network and Dial-up Connection.</i> 3. <i>Click the Command Prompt icon in the Windows Task Bar.</i> 4. <i>Enter IPCONFIG to check IP address configuration.</i> 5. <i>If the local PAP address: 10.10.240.240 does NOT appear in the table, check that the PAP is not configured as a DNS server.</i> 6. <i>Check that PMB code wheel position has not been changed. Default position : Cabinet 0 / Module 0. See PMB LEDs in the Maintenance and Service Guide.</i> 7. <i>Check PMB LED status. See PMB LEDs in the Maintenance and Service Guide.</i> 8. <i>Reset the PMB by pressing the Reset button on the front of the PMB. See PMB LEDs in the Maintenance and Service Guide.</i>
<p>The Schemes List is empty.</p>	<p>The default Domain Scheme has been deleted.</p>	<p>Create the default Domain Scheme with the PAM Domain Scheme wizard. See <i>User's Guide</i>.</p>

Appendix A. Specifications

NovaScale 6080/6160 Server Specifications

The following web site may be consulted for general site preparation information:
<http://www.cs.bull.net/aise>

Dimensions / Weight	
Unpacked	Packed
Height: 177.5 cm (70 in) Width: 65.0 cm (25.6 in) Depth: 113 cm (44.5 in) Weight: 510 kg (1122 lb)	Height: 202 cm (79.5 in) Width: 80.0 cm (31.5 in) Depth: 127.5 cm (50.2 in) Weight: 550 kg (1210 lb)
Service Clearance	
Front Rear Side (left and right)	150 cm 100 cm 100 cm
Operating Limits	
Dry bulb temperature range Relative humidity (non-condensing) Max. wet bulb temperature Moisture content Pressure / Elevation	+15°C to +30°C (+59°F to +86°F) Gradient 5°C/h (41°F/h) 35 to 60% (Gradient 5%/h) +24°C (+75.2°F) 0.019 kg water/kg dry air Sea level ≤ 2500 m
Optimum Operational Reliability	
Temperature Hygrometry	+ 22°C (± 3°C) (+ 72°F (± 5°F)) 50% (± 5%)
Non-Operating Limits	
Dry bulb temperature range Relative humidity (non-condensing) Max. wet bulb temperature Moisture content	+5°C to +50°C (+41°F to +122°F) Gradient 25°C/h (77°F/h) 5 to 95% (Gradient 30%) +28°C (+75°F) 0.024 kg water/kg dry air
Shipping Limits	
Dry bulb temperature range Relative humidity (non-condensing)	-35°C to +65°C (-31°F to +149°F) Gradient 25°C/h (77°F/h) 5 to 95% Gradient 30%/h
Acoustic Power at Room Temperature +20° C (+68° F)	
System Running	System Idle
Lw(A) 6.3 Bels	Lw(A) 6.1 Bels

Power Cables	
AC (20A)	2 per cabinet
Cable type	3 x 4mm ² / AWG # 12 (US)
Connector type	C22 Appliance Coupler
It is mandatory for power lines and terminal boxes to be located within the immediate vicinity of the system and to be easily accessible. Each power line must be connected to a separate, independent electrical panel and bipolar circuit breaker. The PDU requires an extra cable length of 1.5 meters for connection inside the cabinet.	
Electrical Specifications (power supplies are auto-sensing and auto-ranging)	
Current draw	29.5 A max. at 200 VAC input
Power consumption	3000 VA per full CSS module) 1500 VA (per PDU)
Thermal dissipation	2700 W / 9250 BTU (per full CSS module) 1300 W / 4610 BTU (per PDU)
Europe	
Nominal voltage	230 VAC (Phase / Neutral)
Voltage range	207 – 244 VAC
Frequency	50 Hz ± 1%
United States of America	
Nominal voltage	208 VAC (Phase / Neutral)
Voltage range	182 – 229 VAC
Frequency	60 Hz ± 0.3%
Japan	
Nominal voltage	200 VAC (Phase / Neutral)
Voltage range	188 – 212 VAC
Frequency	60 Hz ± 0.2%
Brazil	
Nominal voltage	220 VAC (Phase / Neutral)
Voltage range	212 – 231 VAC
Frequency	60 Hz ± 2%
Breaker Protection	
Mains power CSS module	20A Curve C
Maximum inrush current	210A / per quarter period
Mains power PDU	20A Curve C
Maximum inrush current	210A / per quarter period

Table 8. NovaScale 6080/6160 Server specifications

NovaScale 6320 Server Specifications

The following web site may be consulted for general site preparation information:
<http://www.cs.bull.net/aise>

Dimensions / Weight	
Unpacked	Packed
Height: 177.5 cm (70 in) Width: 65.0 cm (25.6 in) Depth: 113 cm (44.5 in) Weight: Main cabinet: 590 kg (1300 lb) I/O cabinet: 300 kg (661 lb)	Height: 202 cm (79.5 in) Width: 80.0 cm (31.5 in) Depth: 127.5 cm (50.2 in) Weight: Main cabinet: 630 kg (1390 lb) I/O cabinet: 340 kg (750 lb)
Service Clearance	
Front	150 cm
Rear	100 cm
Side (free side)	100 cm
Operating Limits	
Dry bulb temperature range	+15°C to +30°C (+59°F to +86°F) Gradient 5°C/h (41°F/h)
Relative humidity (non-condensing)	35 to 60% (Gradient 5%/h)
Max. wet bulb temperature	+24°C (+75.2°F)
Moisture content	0.019 kg water/kg dry air
Pressure / Elevation	Sea level ≤ 2500 m
Optimum Operational Reliability	
Temperature	+ 22°C (± 3°C) (+ 72°F (± 5°F)
Hygrometry	50% (± 5%)
Non-Operating Limits	
Dry bulb temperature range	+5°C to +50°C (+41°F to +122°F) Gradient 25°C/h (77°F/h)
Relative humidity (non-condensing)	5 to 95% (Gradient 30%)
Max. wet bulb temperature	+28°C (+75°F)
Moisture content	0.024 kg water/kg dry air
Shipping Limits	
Dry bulb temperature range	-35°C to +65°C (-31°F to +149°F) Gradient 25°C/h (77°F/h)
Relative humidity (non-condensing)	5 to 95% Gradient 30%/h
Acoustic Power at Room Temperature +20° C (+68° F)	
System Running	System Idle
Lw(A) 6.3 Bels	Lw(A) 6.1 Bels

Power Cables	
AC (20A)	Main cabinet: 2 (1 per CSS module) I/O cabinet: 1 per PDU
Cable type	3 x 4mm ² / AWG # 12 (US)
Connector type	C22 Appliance Coupler
It is mandatory for power lines and terminal boxes to be located within the immediate vicinity of the system and to be easily accessible. Each power line must be connected to a separate, independent electrical panel and bipolar circuit breaker. The PDU requires an extra cable length of 1.5 meters for connection inside the cabinet.	
Electrical Specifications (power supplies are auto-sensing and auto-ranging)	
Current draw	29.5 A max. at 200 VAC input
Power consumption	3000 VA per full CSS module) 1500 VA (per PDU)
Thermal dissipation	2700 W / 9250 BTU (per full CSS module) 1300 W / 4610 BTU (per PDU)
Europe	
Nominal voltage	230 VAC (Phase / Neutral)
Voltage range	207 – 244 VAC
Frequency	50 Hz ± 1%
United States of America	
Nominal voltage	208 VAC (Phase / Neutral)
Voltage range	182 – 229 VAC
Frequency	60 Hz ± 0.3%
Japan	
Nominal voltage	200 VAC (Phase / Neutral)
Voltage range	188 – 212 VAC
Frequency	60 Hz ± 0.2%
Brazil	
Nominal voltage	220 VAC (Phase / Neutral)
Voltage range	212 – 231 VAC
Frequency	60 Hz ± 2%
Breaker Protection	
Mains power CSS module	20A Curve C
Maximum inrush current	210A / per quarter period
Mains power PDU	20A Curve C
Maximum inrush current	210A / per quarter period

Table 9. NovaScale 6320 Server specifications

Appendix B. Conversion, Keyboard, and Writing Tables

Imperial to Metric

1 inch (")	2.54 cm (centimeters)
1 foot (') (12 inches)	30.48 cm
1 yards (yd) (3 feet)	0.91 m (meters)
1 mile (mi) (1760 yards)	1.6093 km (kilometers)
1 pound (avdp) (lb)	0.5 kg (kilograms)
1 ounce (avdp) (oz)	28.4 g (grams)
1 square foot (ft ²)	0.093 m ² (square meters)
1 square inch (in ²)	6.5 cm ² (square centimeters)
1 square yard (yd ²)	0.8 m ² (square meters)
1 acre	0.4 ha (hectares)
1 cubic foot (ft ³)	0.03 m ³ (cubic meters)
1 horsepower (hp)	0.7 kw (kilowatts)
1 lb/ft ²	4.88 kg/m ²
1 Btu	0.2929 w hour

Table 10. Imperial to metric conversion table

Metric to Imperial

1 meter (meter)	3.3' (feet) / 1.09 yd (yards)
1 centimeter (cm)	0.3937" (inches)
1 kilometer (km)	0.62 mi (miles)
1 gram (g)	0.04 oz (ounces (avdp))
1 kilogram (kg)	2.2 lbs (pounds (avdp))
1 sq. centimeter (cm ²)	0.15 in ² (square inches)
1 square meter (m ²)	10.76 ft ² (square feet)
1 square meter (m ²)	1.2 yd ² (square yards)
1 hectare (ha)	2.5 acres
1 cubic meters (m ³)	35.3 ft ³ (cubic feet)
1 kilowatts (kW)	1.3 hp (horsepower)
1 kg/m ²	0.205 lb/ft ²
1 kW hour	3412 Btu (British thermal unit)

Table 11. Metric to imperial conversion table

Celsius to Fahrenheit Conversion

Multiply the temperature in Celsius by 9, divide by 5 and add 32:

$$(C^{\circ} \times 9/5) + 32 = F^{\circ}$$

Fahrenheit to Celsius Conversion

Subtract 32 degrees from the temperature in Fahrenheit, multiply by 5 and divide by 9:

$$(F^{\circ} - 32) \times 5/9 = C^{\circ}$$

AZERTY/QWERTY Keyboard Lookup Table

	1	2	3	4	5	6	7	8	9	0	°	+
²	&	é ~	* #	' { ([- è ' _ \ ç ^ à @)] = }								
A	Z	E	R	T	Y	U	I	O	P	^	£	x
Q	S	D	F	G	H	J	K	L	M	%	µ	*
>	W	X	C	V	B	N	?	.	/	\$		
<							,	;	:	!		

Figure 85. AZERTY keyboard

~	!	@	#	\$	%	^	&	*	()	-	+
‘	1	2	3	4	5	6	7	8	9	0	-	=
Q	W	E	R	T	Y	U	I	O	P	{	}	
										[]	\
A	S	D	F	G	H	J	K	L	:	”		
									:	;		
	Z	X	C	V	B	N	M	<	>	?		
								,	.	/		

Figure 86. QWERTY keyboard

PAM Writing Rules

Illegal Characters

The following table lists the illegal characters that must not be used in PAM identifiers.

Illegal Characters	
à, é, è, ù, ^, ``	Accentuated letters
/	Slash
\	Backslash
“	Double quote
’	Simple quote
‘	Inverted comma
&	Ampersand
+	Plus
*	Asterisk
%	Percent
=	Equal sign
<	Less-than sign
>	Greater-than sign
:	Colon
!	Exclamation mark
?	Question mark
;	Semi-colon
,	Comma
~	Tilde
	Pipe operator
	Space. Use – (dash) or _ (underscore)

Table 12. PAM illegal characters

String Lengths

The following table lists authorized string lengths.

String Type	Length
CellBlock / System Name	16
Scheme Name	32
History Name	64
Archive Name	75 (History Name: + 11 (_JJMAA_nnn))
LUN Name	32
Switch Name	32
Event Name	32
Description	256 (Scheme: unlimited)
Domain Identity Name	16

Table 13. String length rules

Registry Keys

PAM obtains file paths via 2 registry keys:

- **ReleaseRoot:**
Contains PAP application file paths (DLL, WEB pages, models,...).
Two versions of PAM software can be installed and used indifferently on the same machine: each new version is installed in a new directory.
- **SiteRoot:**
Contains site data file paths.
Site data remains valid when the PAM software version changes.

Registry keys are generally stored under:

HKEY_LOCAL_MACHINE\SOFTWARE\BULL\PAM

Appendix C. Cabling Diagrams

This appendix contains illustrations to supplement server cabling procedures. It includes the following sections:

- Section I – NovaScale 6080/6160 Server Cabling Diagrams, on page C-2
- Section II – NovaScale 6320 Server Cabling Diagrams, on page C-20

Section I – NovaScale 6080/6160 Server Cabling Diagrams

- ▶ Console, on page C-3
- ▶ KVM Switch, on page C-4
- ▶ IOR, on page C-6
- ▶ PAP Unit, on page C-8
- ▶ Disk Rack (SJ-0812 SCSI JBOD), on page C-10
- ▶ Disk Rack (SR-0812 SCSI RAID), on page C-11
- ▶ Disk Rack (FDA 1300 FC), on page C-12
- ▶ Extension Disk Rack (FDA 1300 FC – FDA 1300 FC), on page C-13
- ▶ Disk Rack (FDA 2300 FC), on page C-14
- ▶ Extension Disk Rack (FDA 2300 FC – FDA 1300 FC), on page C-15
- ▶ PMB, on page C-16
- ▶ Ethernet Hub, on page C-17
- ▶ Modem, on page C-18
- ▶ Power, on page C-19

Integrated Console

Slideaway Console

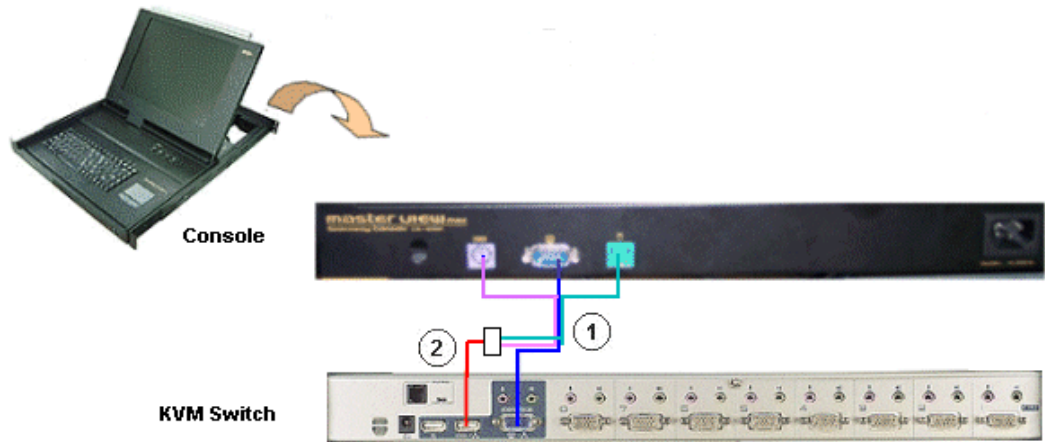

Mark	Cable Type	From	To
1	video/PS2/PS2 cable	Console (video)	KVM switch (video)
2	PS2/USB converter	Console (PS2/PS2)	KVM switch (USB)

Figure 87. Slideaway console data cabling diagram

Console Drawer

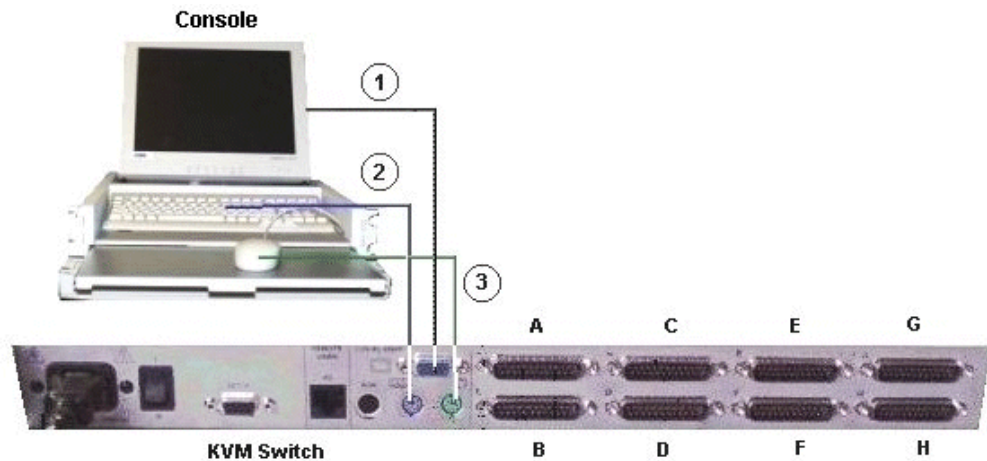

Mark	Cable Type	From	To
1	HD15 video cable	Monitor (blue)	KVM switch (blue)
2	PS2 mini-DIN6 cable + PS2/PS2 extension cable	Keyboard (mauve)	KVM switch (mauve)
3	PS2 mini-DIN6 cable + PS2/PS2 extension cable	Mouse (green)	KVM switch (green)

Figure 88. Console drawer data cabling diagram

KVM Switch

Aten 8-Port KVM Switch

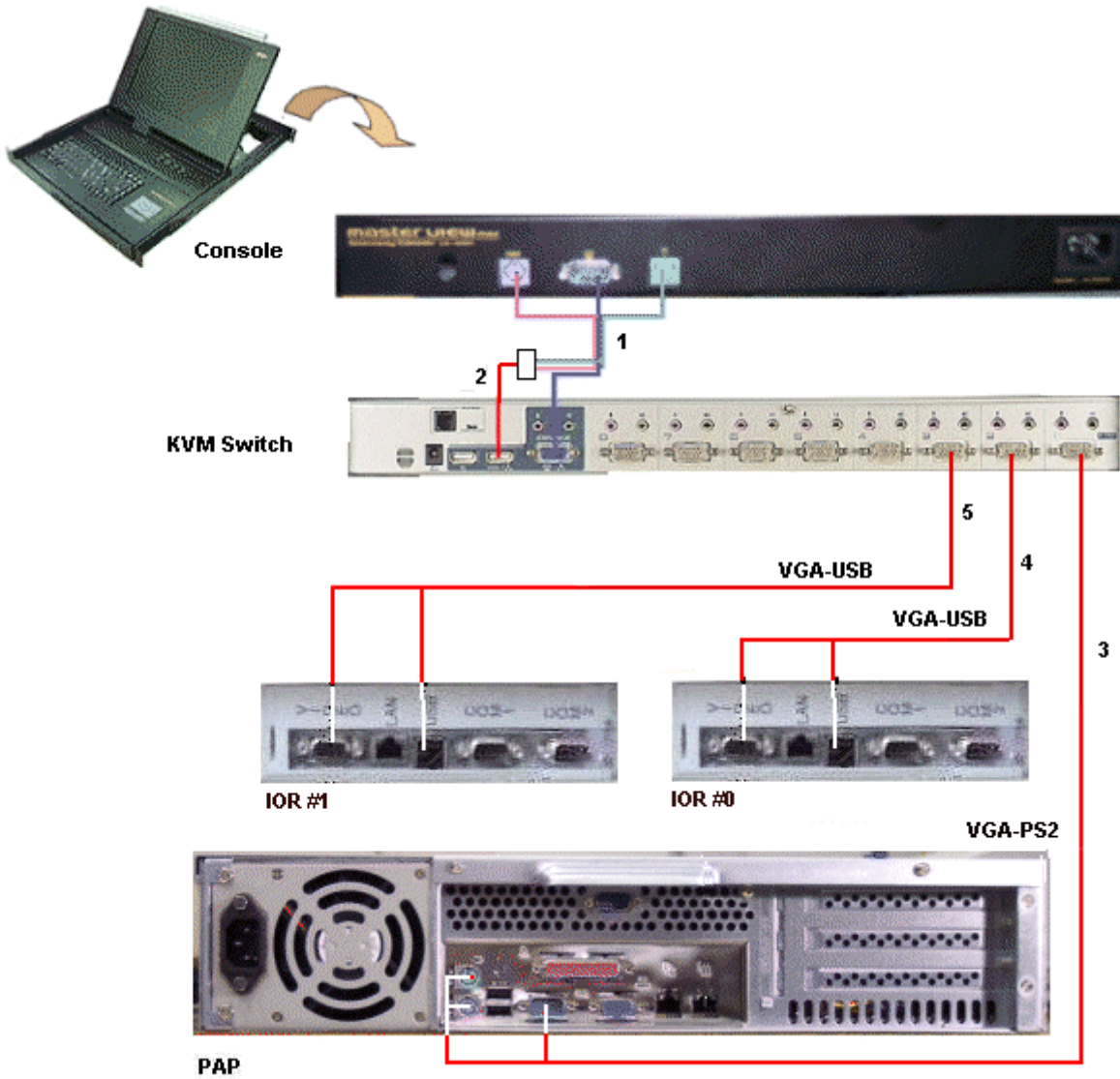

Mark	Cable Type	From	To
1	Video/PS2/PS2 cable	Console (video)	KVM switch (video)
2	PS2/USB converter	Console (PS2/PS2)	KVM switch (USB)
3	Combined PS2/VGA cable	KVM Port 1	PAP (VGA/PS2)
4	Combined USB/VGA cable	KVM Port 2	IOR (IOB0) (Video/USB)
5	Combined USB/VGA cable	KVM Port 3	IOR (IOB1) (Video/USB)

Figure 89. 8-port KVM switch data cabling diagram (example 1)

Avocent 8-Port KVM Switch

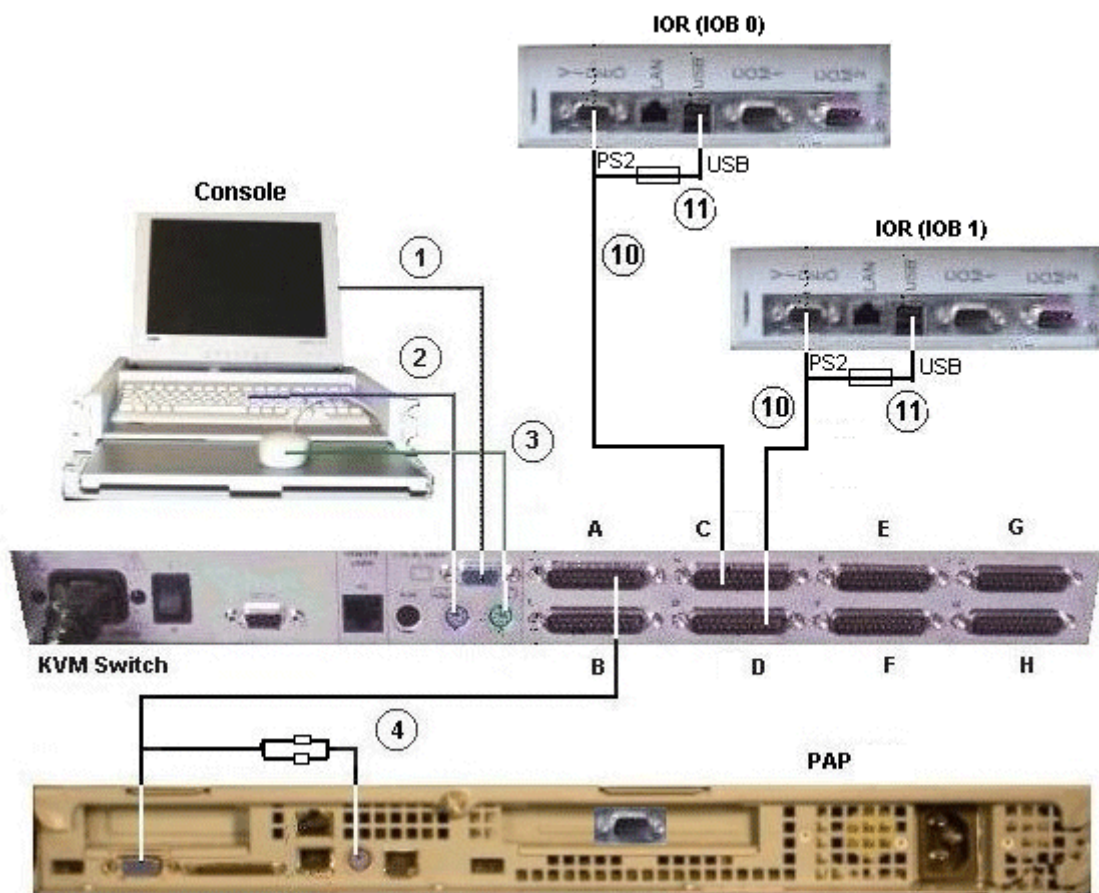

Mark	Cable Type	From	To
1	HD15 video cable	Monitor (blue)	KVM (blue)
2	PS2 mini-DIN6 cable + PS2/PS2 extension cable	Keyboard (mauve)	KVM (mauve)
3	PS2 mini-DIN6 cable + PS2/PS2 extension cable	Mouse (green)	KVM (green)
4	Combined PS2/VGA cable	KVM Port A	PAP VGA/PS2
10	Combined USB/VGA cable (Windows)	KVM Port C/D	IOR Video/USB
	Combined PS2/VGA cable (Linux)	KVM Port C/D	IOR (Video)
11	USB/PS2 converter (Linux)	PS2 cable (mark 10)	IOR (USB)

Figure 90. 8-port KVM switch data cabling diagram (example 2)

IOR

IOR – 2U PAP Unit – Aten 8-Port KVM Switch

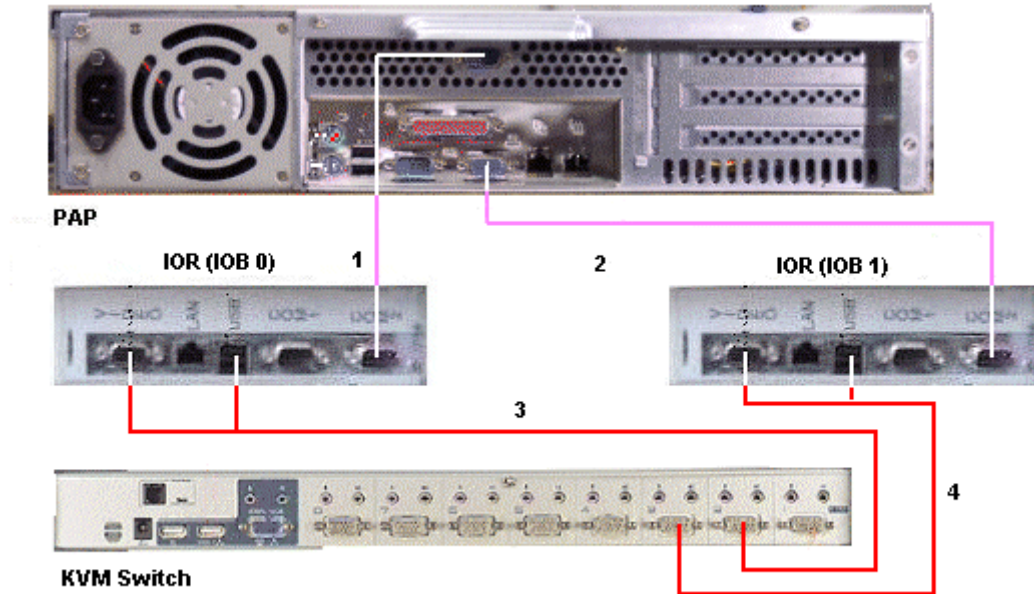

Mark	Cable Type	From	To
1	DB9 to DB9 cross cable	PAP COM 2	IOR (IOB0)
2	DB9 to DB9 cross cable	PAP COM 1	IOR (IOB1)
3	Combined USB/VGA cable	KVM Port 2	IOR (IOB0) Video/USB
4	Combined USB/VGA cable	KVM Port 3	IOR (IOB1) Video/USB

Figure 91. IOR data cabling diagram (example 1)

IOR – 1U PAP Unit – Avocent 8-Port KVM Switch

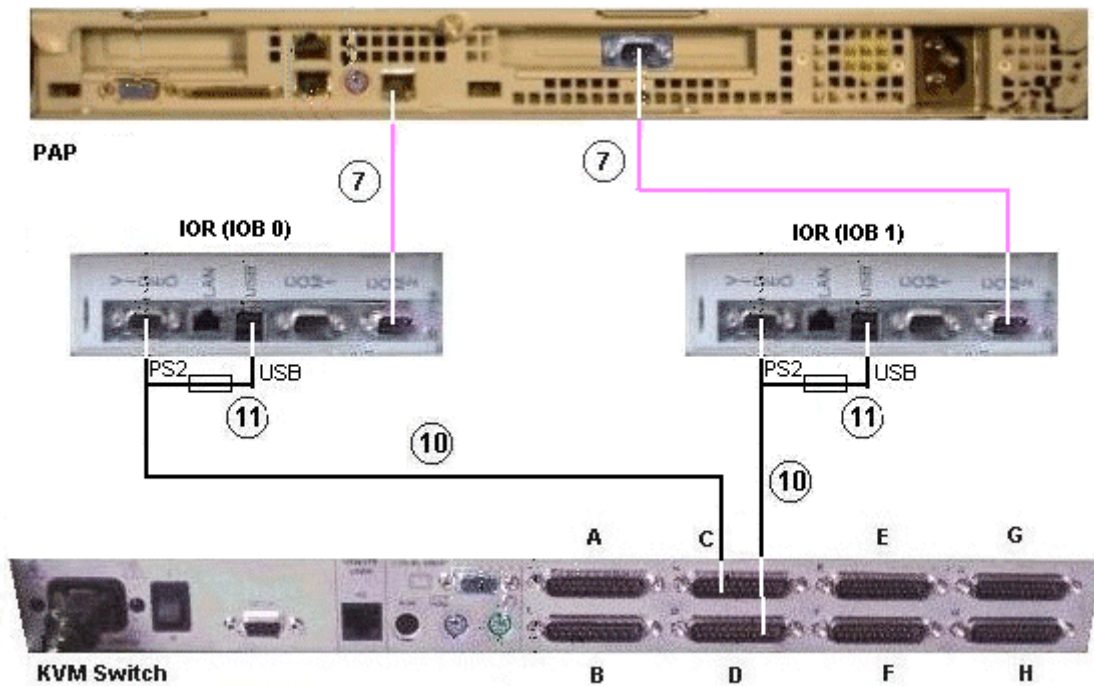

Mark	Cable Type	From	To
7	RJ45/DB9 to DB9 cross cable	PAP COM 2	IOR (IOB0)
	DB9 to DB9 cross cable	PAP COM 1	IOR (IOB1)
10	Combined USB/VGA cable (Windows)	KVM Port C/D	IOR Video/USB
	Combined PS2/VGA cable (Linux)	KVM Port C/D	IOR (Video)
11	USB/PS2 converter (Linux)	PS2 cable (mark 10)	IOR (USB)

Figure 92. IOR data cabling diagram (example 2)

PAP Unit

2U PAP Unit

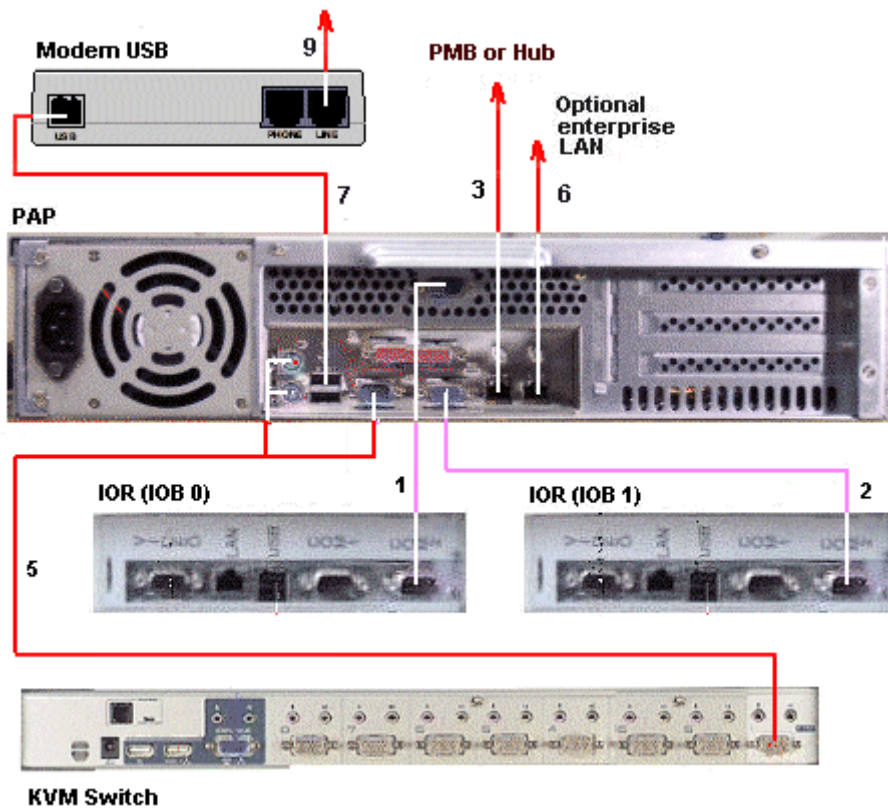

Mark	Cable Type	From	To
1	DB9 to DB9 cross cable	PAP COM 2	IOR (IOB0) COM2
2	DB9 to DB9 cross cable	PAP COM 1	IOR (IOB1) COM2
3	RJ45 – RJ45 Ethernet cable	PAP LAN Maint	PMB or Hub
5	Combined PS2/VGA cable	PAP VGA/PS2	KVM Port 1
6	RJ45 to RJ45 Ethernet cable	PAP LAN Enter	Enterprise LAN
7	USB cable	PAP USB	Modem
9	RJ11 – RJ11 cable	Modem (Line)	Telephone network socket

Figure 93. PAP unit data cabling diagram (example 1)

1U PAP Unit

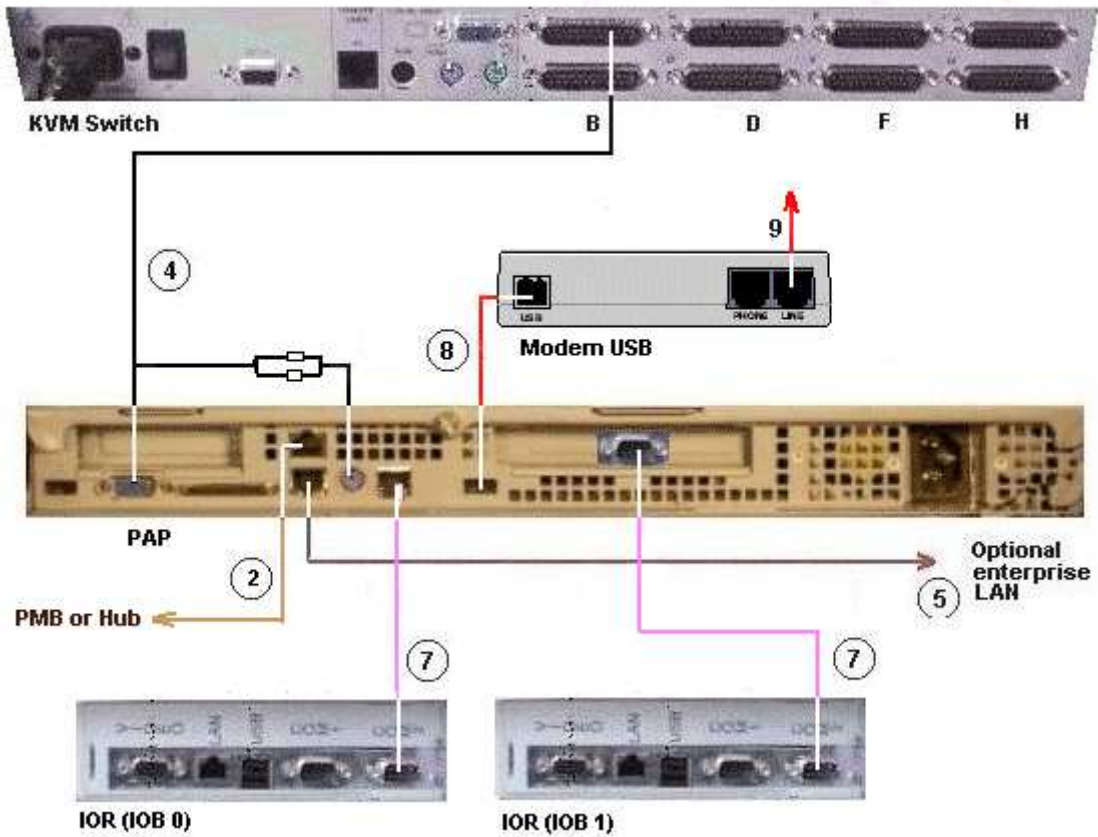

Mark	Cable Type	From	To
1	RJ45 – RJ45 Ethernet cable	PMB Ethernet	Hub port 8
2	RJ45 – RJ45 Ethernet cable	PAP LAN Maint	Hub port 7
4	Combined PS2/VGA cable	PAP VGA/PS2	KVM Port A
5	RJ45 to RJ45 Ethernet cable	PAP LAN Enter	Enterprise LAN
7	RJ45/DB9 to DB9 cross cable	PAP COM 2	IOR (IOB0)
	DB9 to DB9 cross cable	PAP COM 1	IOR (IOB1)
8	USB cable	PAP USB	Modem
9	RJ11 – RJ11 cable	Modem (Line)	Telephone network socket

Figure 94. PAP unit data cabling diagram (example 2)

Disk Rack (SJ-0812 SCSI JBOD)

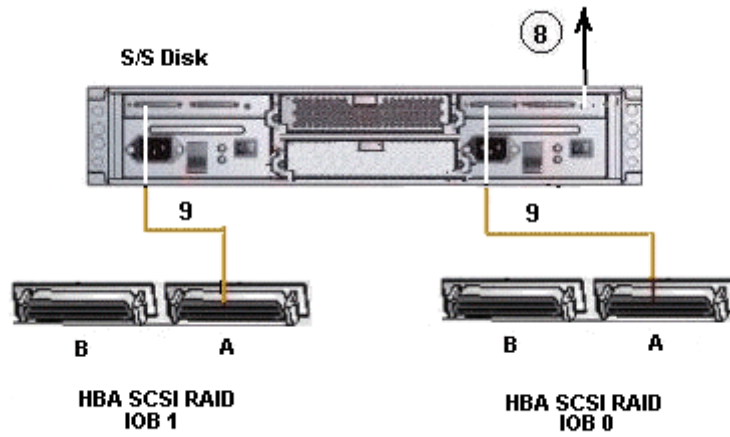

Mark	Cable Type	From	To
8*	DB9 to Jack cable	PAP COM 1	S/S Disk RS232
9	SCSI-3 68-pin VHDCI to VHDCI cable	HBA SCSI RAID	S/S Disk Extension port

* optional cable used to configure the disk S/S.

Figure 95. SJ-0812 SCSI JBOD disk rack data cabling diagram

Disk Rack (SR-0812 SCSI RAID)

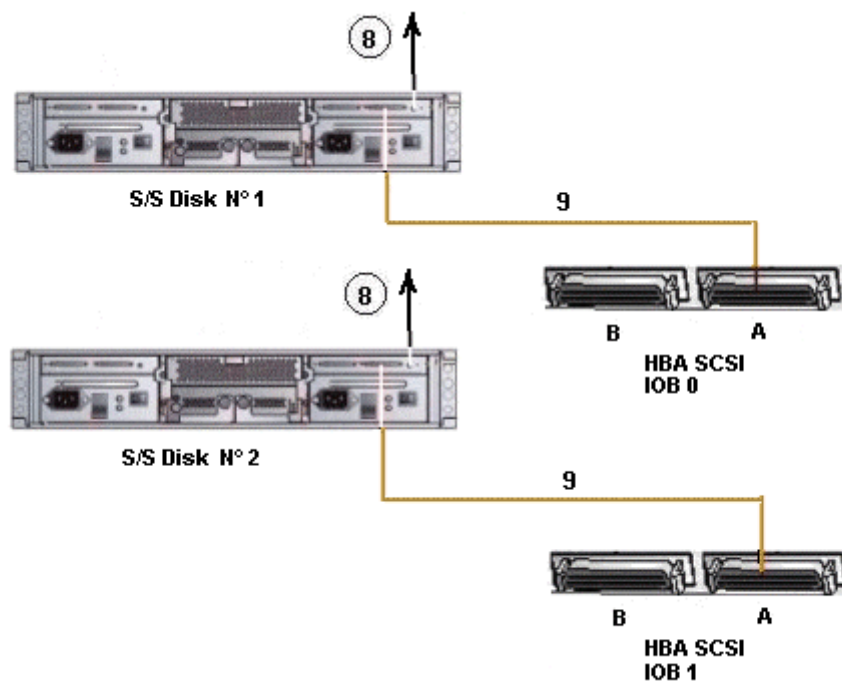

Mark	Cable Type	From	To
8*	DB9 to Jack cable	PAP COM 1 or Nport server	S/S Disk RS232
9	SCSI-3 68-pin VHDCI to VHDCI cable	HBA SCSI	S/S Disk Host port

* optional cable used to configure the disk S/S.

Figure 96. SR-0812 SCSI RAID disk rack data cabling diagram

Extension Disk Rack (SR-0812 SCSI RAID – SJ-0812 SCSI JBOD)

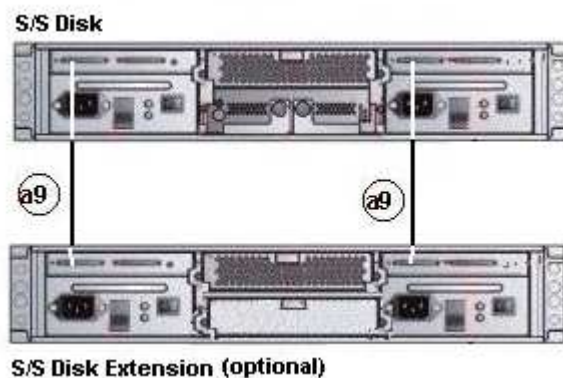

Mark	Cable Type	From	To
a9	SCSI-3 68-pin VHDCI to VHDCI cable	SR-0812 SCSI RAID extension port	SJ-0812 SCSI JBOD extension port

Figure 97. SJ-0812 SCSI JBOD extension disk rack data cabling diagram

Disk Rack (FDA 1300 FC)

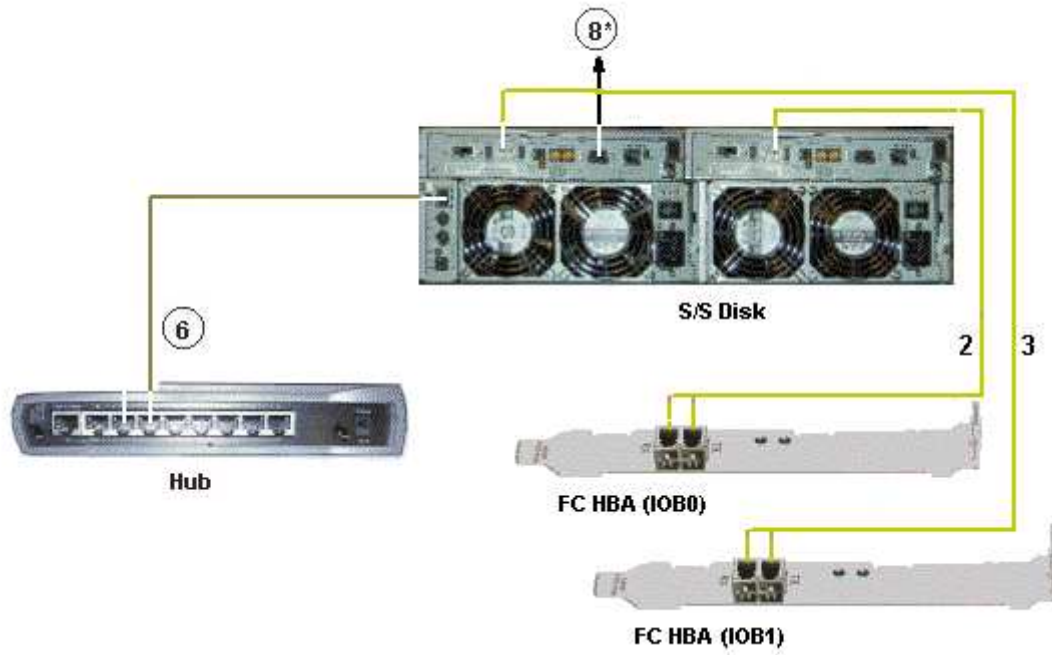

Mark	Cable Type	From	To
2	LC-LC cable	S/S Disk (CTL 0)	FC Adapter IOB 0
3	LC-LC cable	S/S Disk (CTL 1)	FC Adapter IOB 1
6	RJ45 – RJ45 Ethernet cable	S/S Disk	Hub port 6
8	DB9 to DB9 serial cable *	PAP COM 1	S/S Disk RS232

* optional cable used to configure the S/S disk.

Figure 98. FDA 1300 FC disk rack data cabling diagram

Extension Disk Rack (FDA 1300 FC – FDA 1300 FC)

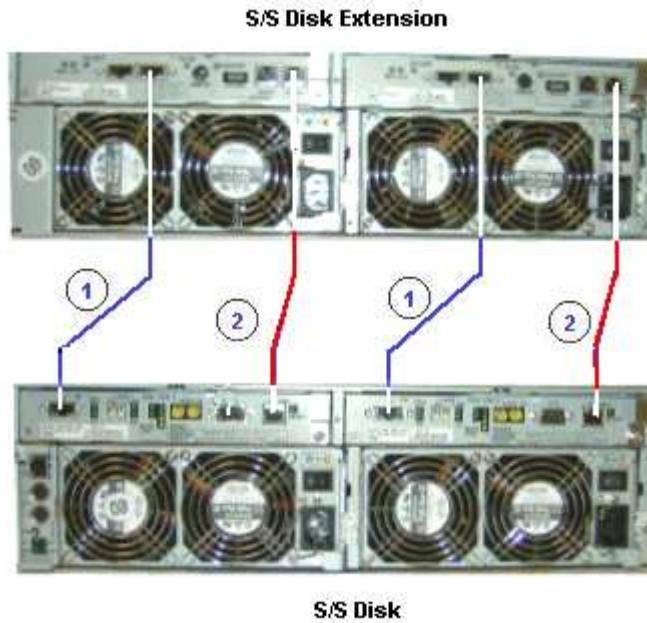

Mark	Cable Type	From	To
1	HSSDC–HSSDC cable	S/S Disk	S/S Disk Extension
2	DE diagnosis cable	S/S Disk	S/S Disk Extension

Figure 99. FDA 1300 FC – FDA 1300 FC extension disk rack data cabling diagram

Disk Rack (FDA 2300 FC)

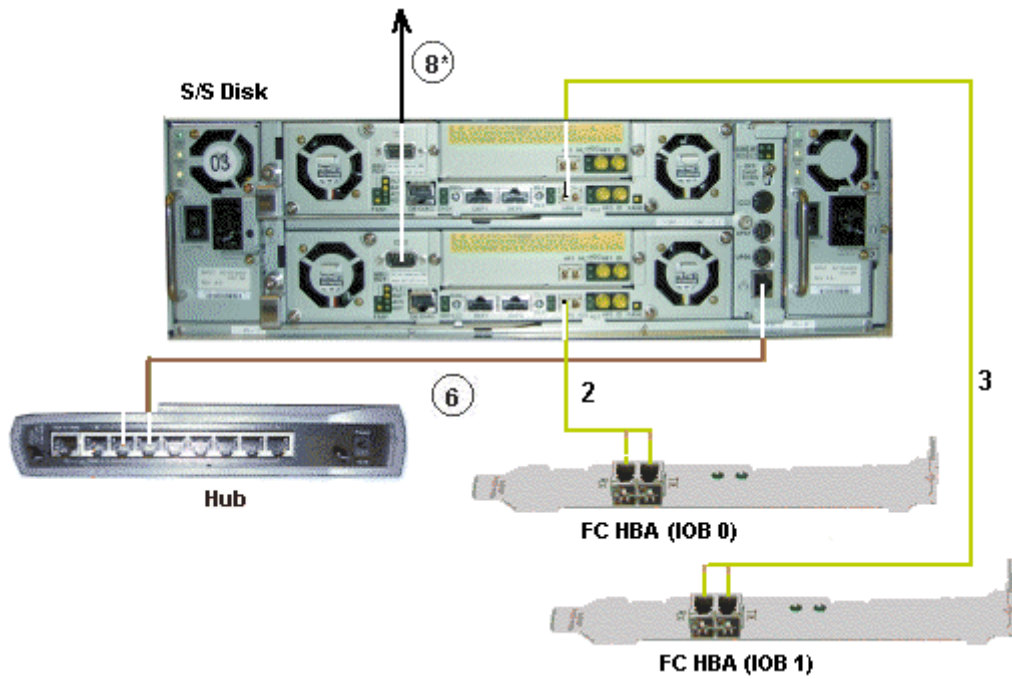

Mark	Cable Type	From	To
2	LC–LC cable	S/S Disk (CTL 0)	FC Adapter IOB 0
3	LC–LC cable	S/S Disk (CTL 1)	FC Adapter IOB 1
6	RJ45 – RJ45 Ethernet cable	S/S Disk	Hub port 6
8	DB9 to DB9 serial cable *	PAP COM 1	S/S Disk RS232

* optional cable used to configure the S/S disk.

Figure 100. FDA 2300 FC disk rack data cabling diagram

Extension Disk Rack (FDA 2300 FC – FDA 1300 FC)

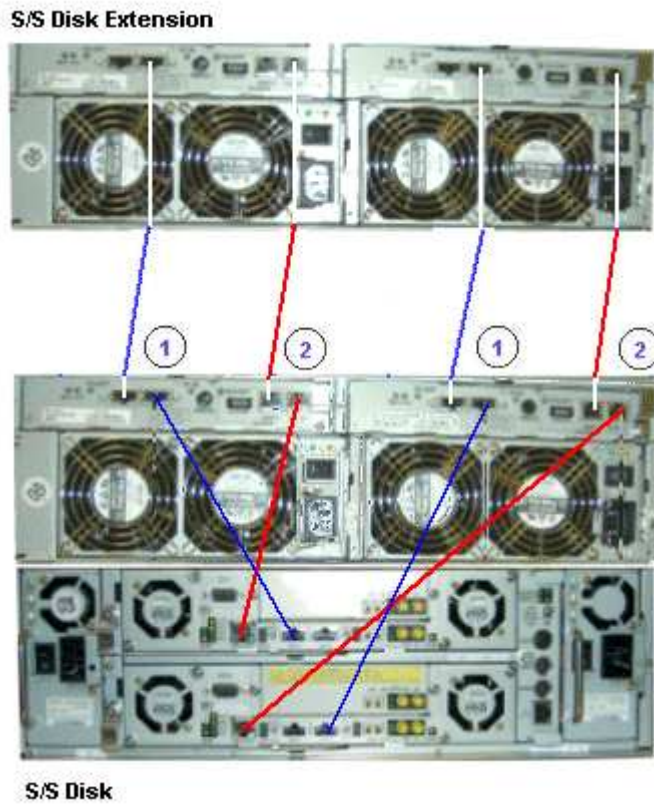

Mark	Cable Type	From	To
1	HSSDC–HSSDC cable	S/S Disk	S/S Disk Extension
2	DE diagnosis cable	S/S Disk	S/S Disk Extension

Figure 101. FDA 2300 FC – FDA 1300 FC extension data cabling diagram

PMB

1U PAP Unit

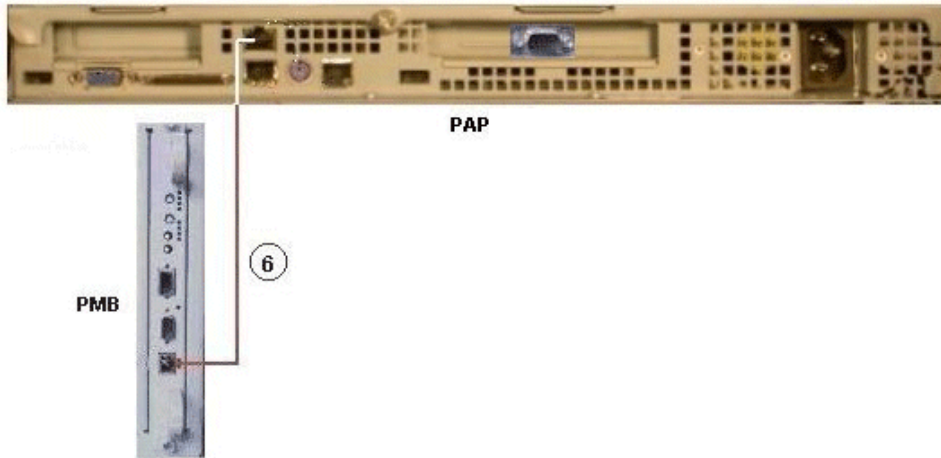

2U PAP Unit

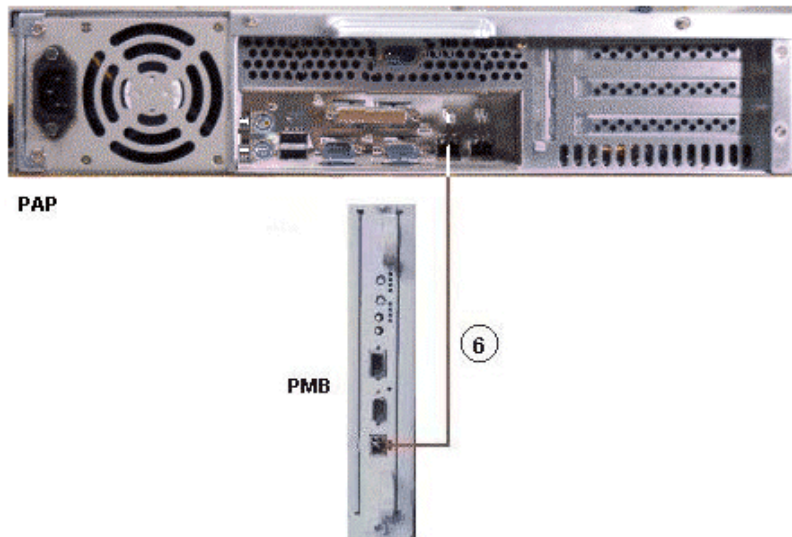

Ethernet Hub

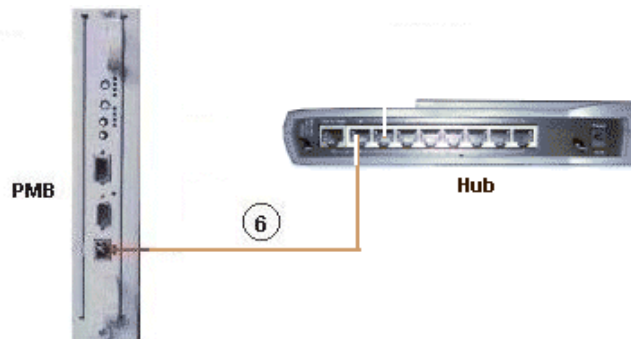

Mark	Cable Type	From	To
6	RJ45 – RJ45 Ethernet cross cable	PAP LAN Maint	PMB Ethernet or Hub

Figure 102. PMB data cabling diagram examples

Ethernet Hub

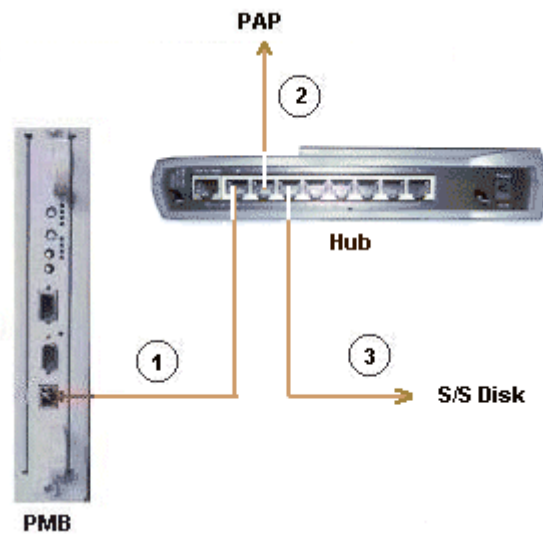

Mark	Cable Type	From	To
1	RJ45 – RJ45 Ethernet cable	Hub Ethernet port 8	PMB Ethernet
2	RJ45 – RJ45 Ethernet cable	Hub Ethernet port 7	PAP LAN Maint
3	RJ45 – RJ45 Ethernet cable	Hub Ethernet port 6	S/S Disk

Figure 103. Ethernet hub data cabling diagram

Modem

1U PAP Unit

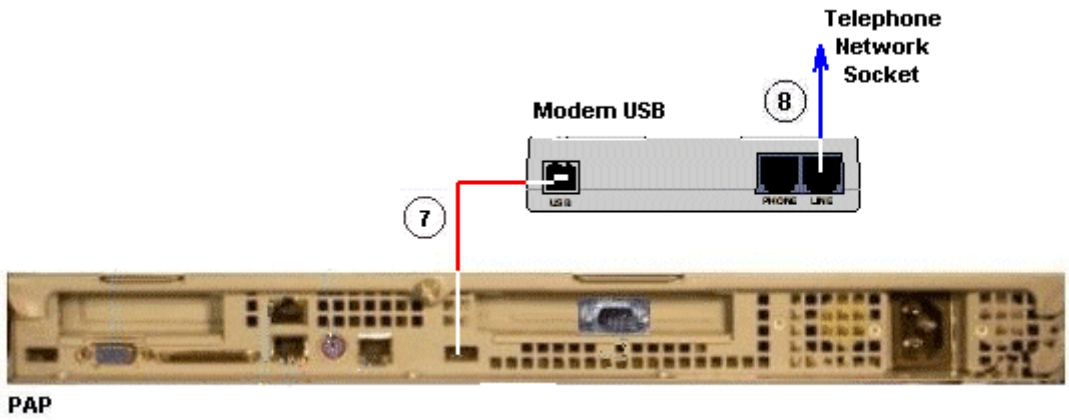

2U PAP Unit

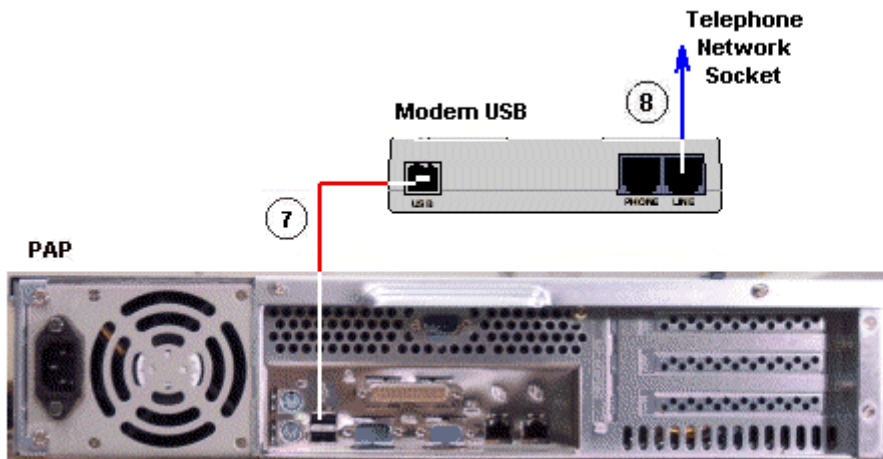

Mark	Cable Type	From	To
------	------------	------	----

Figure 104. Modem data cabling diagram

Power

The CSS Module is equipped with a dedicated power supply cable. All other server component power supply cables are connected to the internal PDU, as shown below:

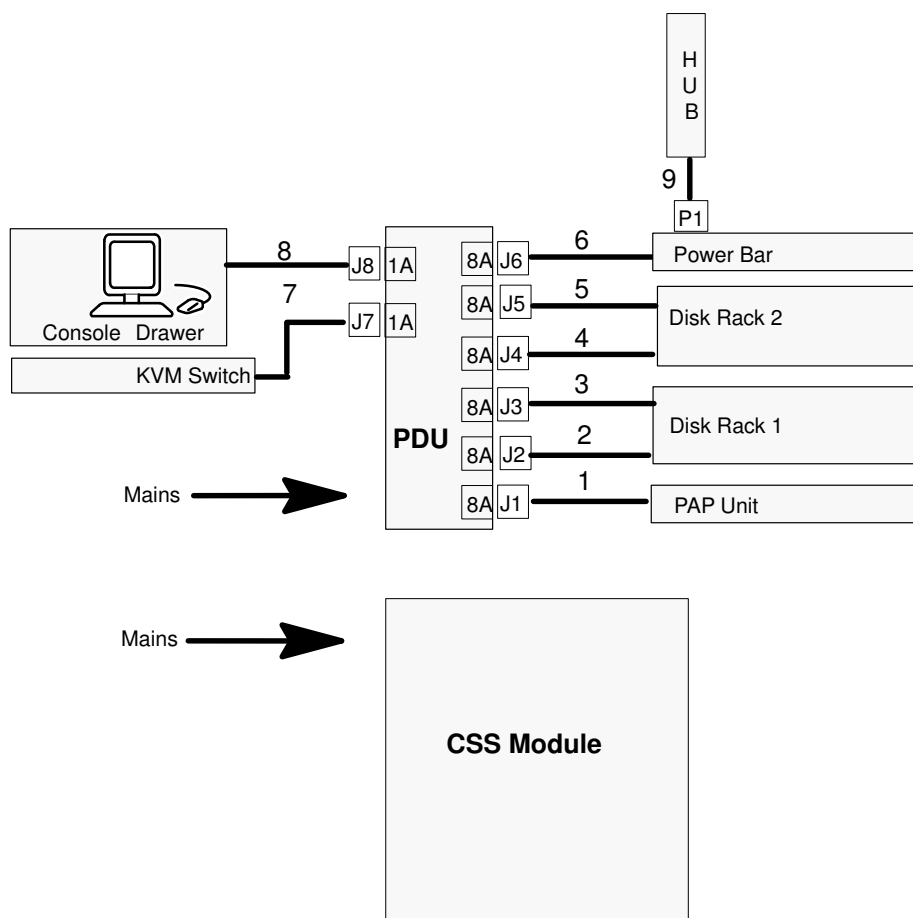

Mark	Cable Type	From	To
1	Power cable	PAP PWR	PDU J1
2	Power cable	S/S Disk 1 PWR	PDU J2
3	Power cable	S/S Disk 1 PWR	PDU J3
4	Power cable	S/S Disk 2 PWR	PDU J4
5	Power cable	S/S Disk 2 PWR	PDU J5
6	Power cable	Power Bar	PDU J6
7	Power cable	KVM PWR	PDU J7
8	Power cable	Monitor PWR	PDU J8
9	Power cable	Hub PWR	Power Bar P1

Figure 105. Power cabling diagram

Section II – NovaScale 6320 Server Cabling Diagrams

- ▶ Console, on page C-21
- ▶ KVM Switch, on page C-23
- ▶ IOR, on page C-25
- ▶ PAP Unit, on page C-26
- ▶ Disk Rack (SJ-0812 SCSI JBOD), on page C-28
- ▶ Disk Rack (SR-0812 SCSI RAID), on page C-29
- ▶ Extension Disk Rack (SR-0812 SCSI RAID – SJ-0812 SCSI JBOD), on page C-30
- ▶ Disk Rack (FDA 1300 FC), on page C-31
- ▶ Extension Disk Rack (FDA 1300 FC – FDA 1300 FC), on page C-32
- ▶ Disk Rack (FDA 2300 FC), on page C-33
- ▶ Extension Disk Rack (FDA 2300 FC – FDA 1300 FC), on page C-34
- ▶ PMB – Hub – Pap Unit, on page C-35
- ▶ Ethernet Hub, on page C-36
- ▶ Modem, on page C-37
- ▶ Power, on page C-38
- ▶ Inter-Cabinet (PMB – Ethernet Hub), on page C-40
- ▶ Inter-Cabinet (IOR – KVM Switch), on page C-41
- ▶ Inter-Cabinet (IOB HBA RAID – SJ-0812 SCSI JBOD), on page C-42
- ▶ Inter-Cabinet (IOB HBA – SR-0812 SCSI RAID), on page C-43
- ▶ Inter-Cabinet (IOB HBA – FDA 1300 FC), on page C-43
- ▶ Inter-Cabinet (IOB HBA – FDA 2300 FC), on page C-44

Console

Slideaway Console

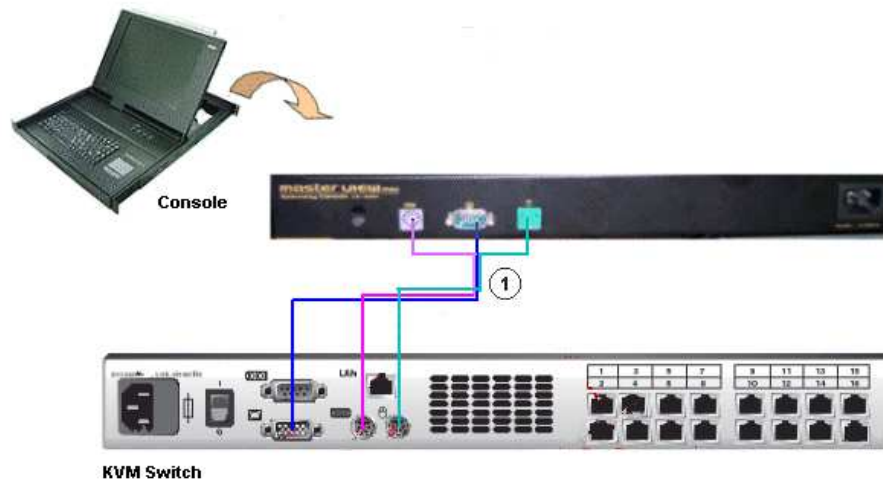

Mark	Cable Type	From	To
1	video/PS2/PS2 cable	Console	KVM switch

Figure 106. Slideaway console data cabling diagram

Console Drawer

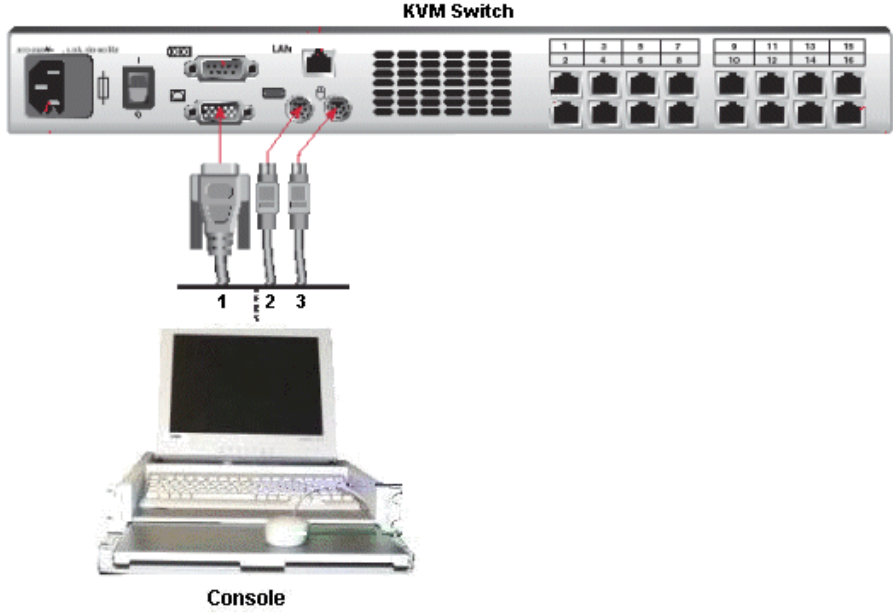

Mark	Cable Type	From	To
1	HD15 video cable	Monitor (blue)	KVM switch (blue)
2	PS2 mini-DIN6 cable + PS2/PS2 extension cable	Keyboard (mauve)	KVM switch (mauve)
3	PS2 mini-DIN6 cable + PS2/PS2 extension cable	Mouse (green)	KVM switch (green)

Figure 107. Integrated console data cabling diagram

16-Port KVM Switch

Slideaway Console – 2U PAP Unit

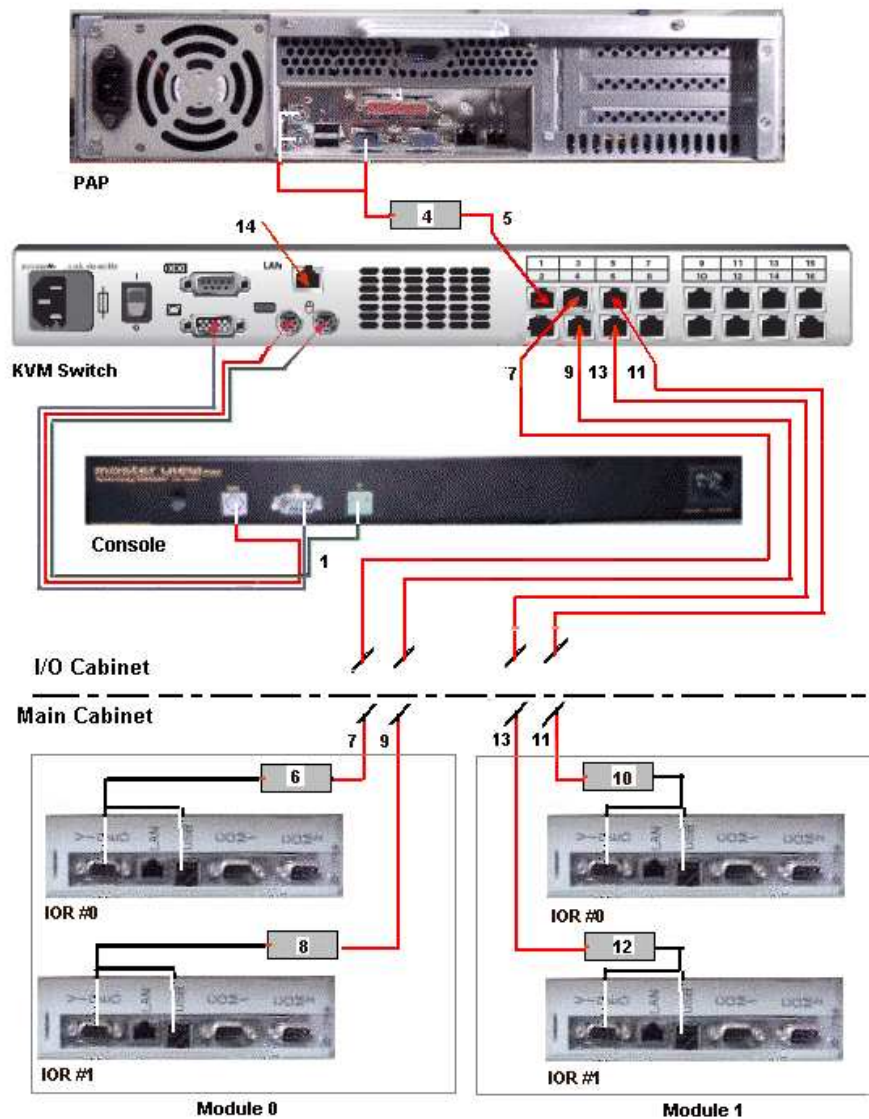

Mark	Cable Type	From	To
1	video/PS2/PS2 cable	Console	KVM switch
5	RJ45/RJ45 cable	PAP (VGA and PS2) via AVRIQ (4)	KVM Port 1
7*	RJ45/RJ45 cable	IOR #0 Module 0 VGA and USB via AVRIQ (6)	KVM Port 3
9*	RJ45/RJ45 cable	IOR #1 Module 0 VGA and USB via AVRIQ (8)	KVM Port 4
11*	RJ45/RJ45 cable	IOR #0 Module 1 VGA and USB via AVRIQ (10)	KVM Port 5
13*	RJ45/RJ45 cable	IOR #1 Module 1 VGA and USB via AVRIQ (12)	KVM Port 6
14	RJ45/RJ45 cable	KVM (LAN)	Enterprise LAN

* Inter-cabinet data cable

Figure 108. 16-port KVM switch data cabling diagram (example 1)

Console Drawer – 1U PAP Unit

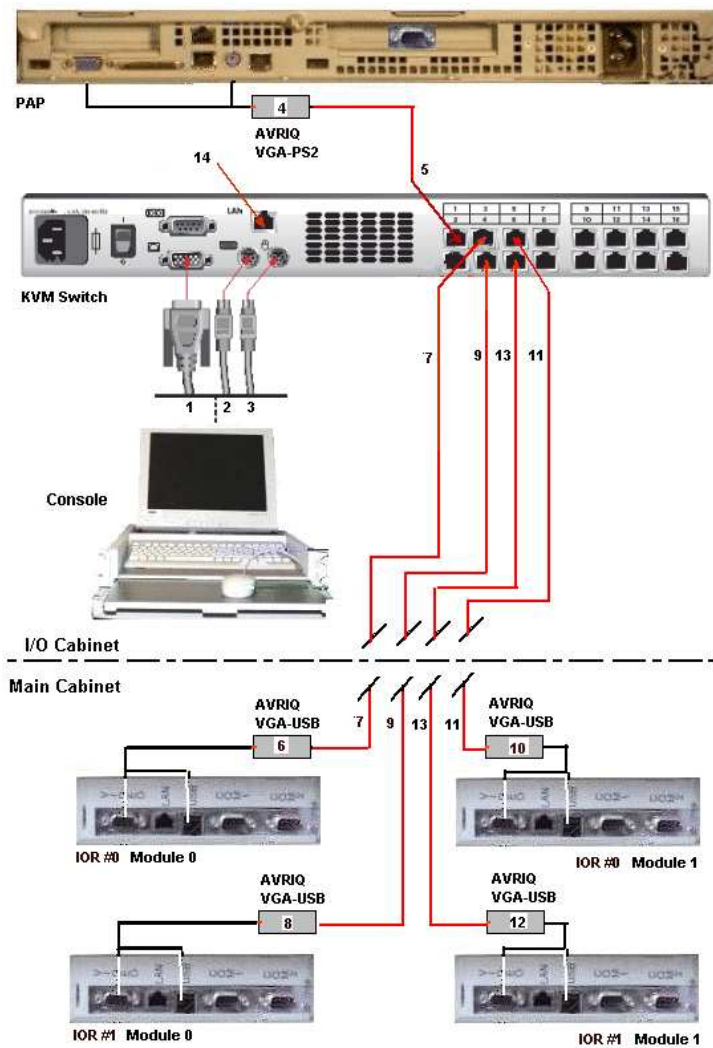

Mark	Cable Type	From	To
1	HD15 video cable	Monitor (blue)	KVM (blue)
2	PS2 mini-DIN6 cable + PS2/PS2 extension cable	Keyboard (mauve)	KVM (mauve)
3	PS2 mini-DIN6 cable + PS2/PS2 extension cable	Mouse (green)	KVM (green)
5	RJ45/RJ45 cable	PAP (VGA and PS2) via AVRIQ (4)	KVM Port 1
7*	RJ45/RJ45 cable	IOR #0 Module 0 VGA and USB via AVRIQ (6)	KVM Port 3
9*	RJ45/RJ45 cable	IOR #1 Module 0 VGA and USB via AVRIQ (8)	KVM Port 4
11*	RJ45/RJ45 cable	IOR #0 Module 1 VGA and USB via AVRIQ (10)	KVM Port 5
13*	RJ45/RJ45 cable	IOR #1 Module 1 VGA and USB via AVRIQ (12)	KVM Port 6
14	RJ45/RJ45 cable	KVM (LAN)	Enterprise LAN

* Inter-cabinet data cable

Figure 109. 16-port KVM switch data cabling diagram (example 2)

IOR

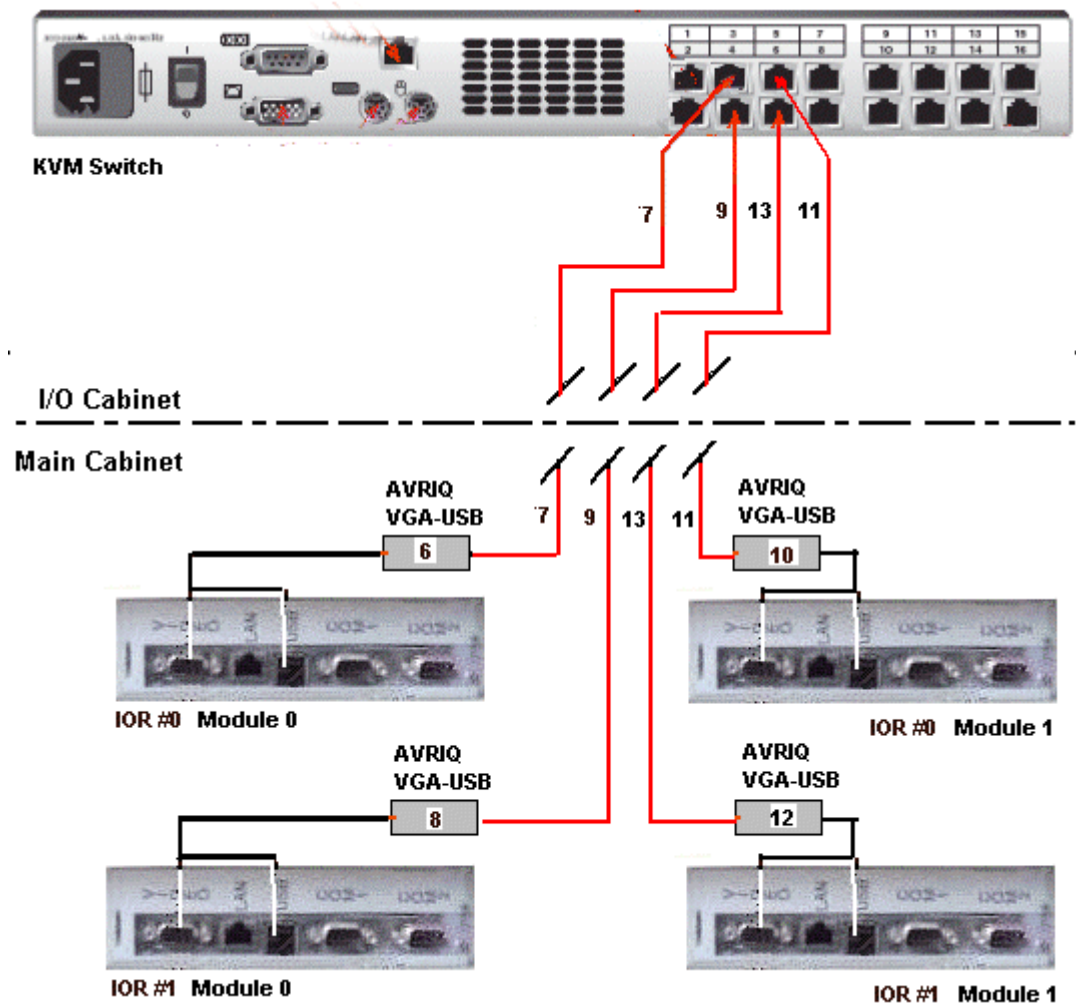

Mark	Cable Type	From	To
7*	RJ45/RJ45 cable	IOR #0 Module 0 VGA and USB via AVRIQ (6)	KVM Port 3
9*	RJ45/RJ45 cable	IOR #1 Module 0 VGA and USB via AVRIQ (8)	KVM Port 4
11*	RJ45/RJ45 cable	IOR #0 Module 1 VGA and USB via AVRIQ (10)	KVM Port 5
13*	RJ45/RJ45 cable	IOR #1 Module 1 VGA and USB via AVRIQ (12)	KVM Port 6

* Inter-cabinet data cable

Figure 110. IOR data cabling diagram (16-port KVM switch)

PAP Unit

2U PAP Unit

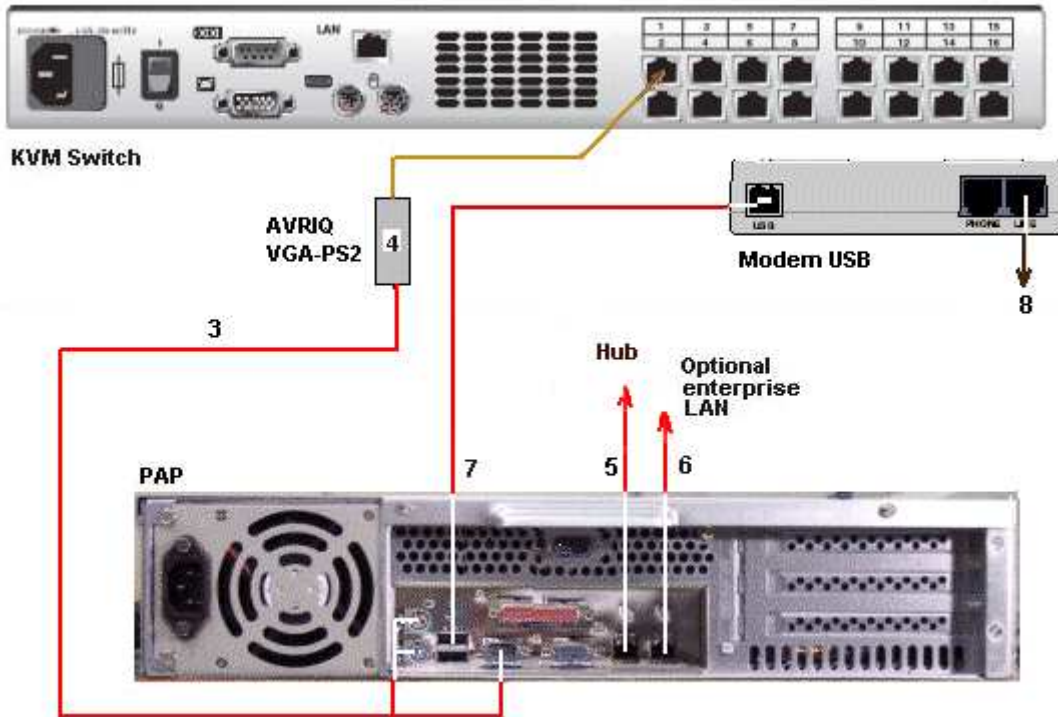

Mark	Cable Type	From	To
3	RJ45 – RJ45 Ethernet cable	PAP (VGA and PS2) via AVRIQ (4)	KVM Port 1
5	RJ45 – RJ45 Ethernet cable	PAP Ethernet	Hub Ethernet
6	RJ45 – RJ45 Ethernet cable	PAP LAN Enter	Enterprise LAN
7	USB cable	PAP USB	Modem USB
8	RJ11 – RJ11 cable	Modem (Line)	Telephone socket

* Inter-cabinet data cable

Figure 111. PAP unit (2U) data cabling diagram

1U PAP Unit

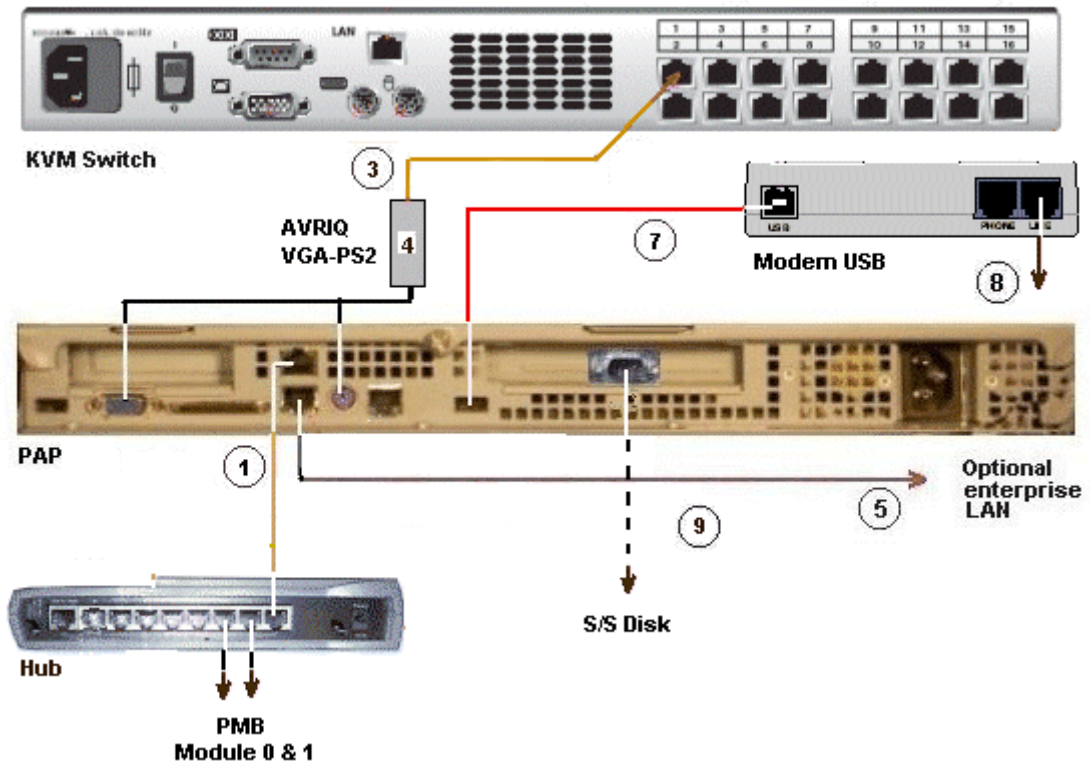

Mark	Cable Type	From	To
1	RJ45 – RJ45 Ethernet cable	PAP Ethernet	Hub Ethernet port 1
2*	RJ45 – RJ45 Ethernet cable	PMB Module 0	Hub Ethernet port 2
3	RJ45 – RJ45 Ethernet cable	PAP (VGA and PS2) via AVRIQ (4)	KVM Port 1
5	RJ45 – RJ45 Ethernet cable	PAP LAN Enter	Enterprise LAN
6*	RJ45 – RJ45 Ethernet cable	PMB Module 1	Hub Ethernet port 3
7	USB cable	PAP USB	Modem USB
8	RJ11 – RJ11 cable	Modem (Line)	Telephone socket
9 #	DB9 to DB9 serial cable *	PAP COM 1	S/S Disk RS232

* Inter-cabinet data cable

optional cable used to configure the disk S/S.

Figure 112. PAP unit (1U) data cabling diagram

Disk Rack (SJ-0812 SCSI JBOD)

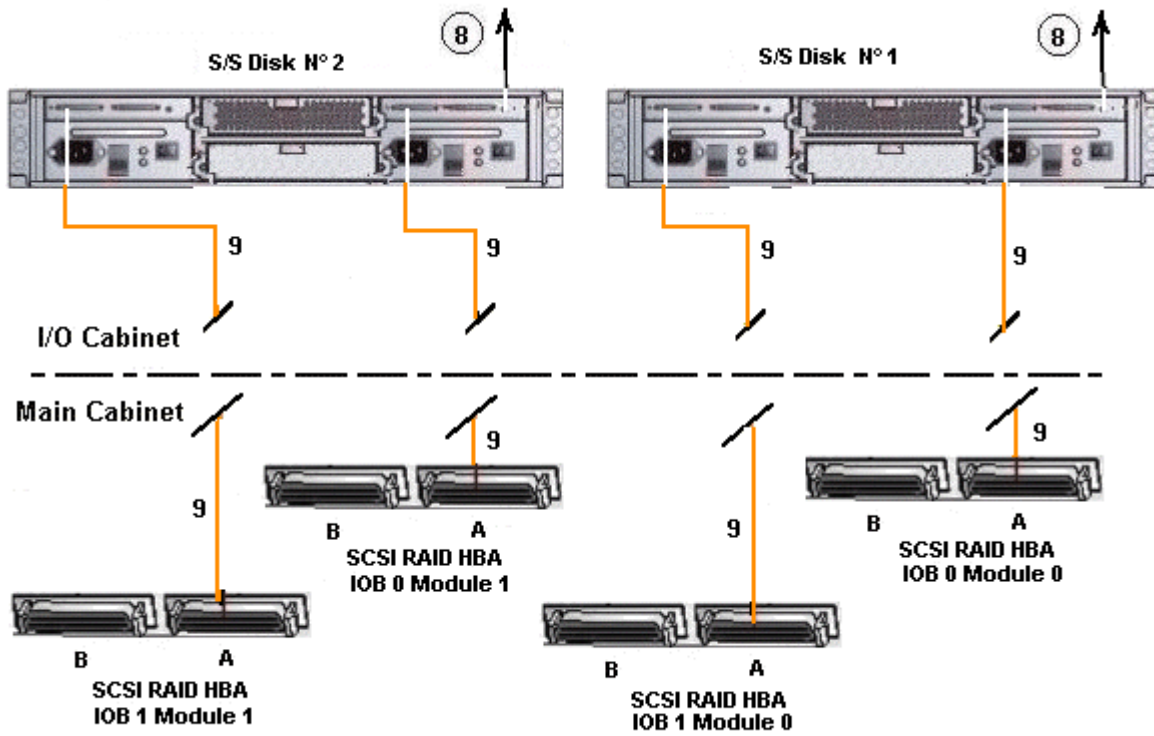

Mark	Cable Type	From	To
8*	DB9 to Jack cable	PAP COM 1	S/S Disk RS232
9	SCSI-3 68-pin VHDCI to VHDCI cable	HBA SCSI RAID	S/S Disk extension port

*optional cable used to configure the disk S/S.

Figure 113. SJ-0812 SCSI JBOD disk rack data cabling diagram

Disk Rack (SR-0812 SCSI RAID)

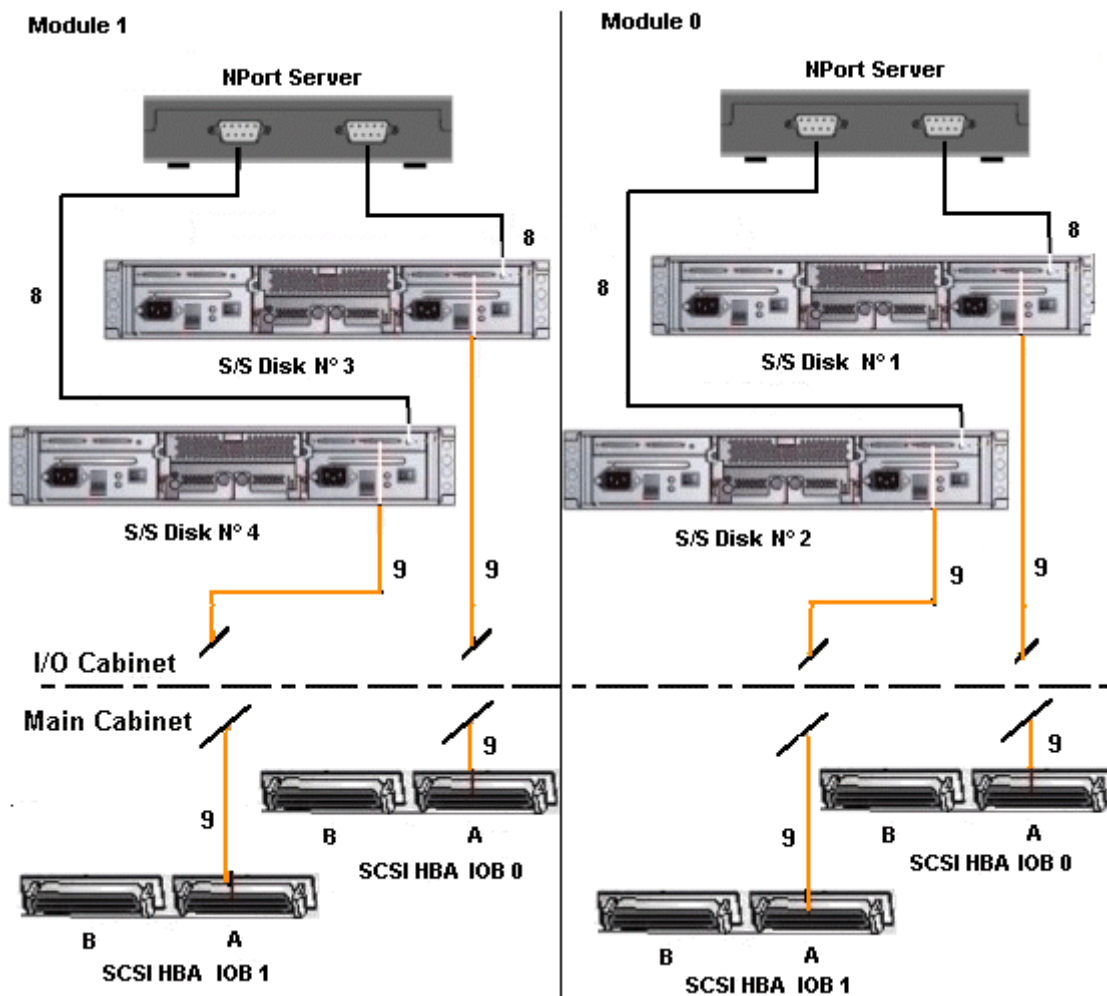

Mark	Cable Type	From	To
8*	DB9 to Jack cable	Nport server	S/S Disk RS232
9	SCSI-3 68-pin VHDCI to VHDCI cable	HBA SCSI	S/S Disk RAID Host port

*optional cable used to configure the disk S/S.

Figure 114. SR-0812 SCSI RAID disk rack data cabling diagram

Extension Disk Rack (SR-0812 SCSI RAID – SJ-0812 SCSI JBOD)

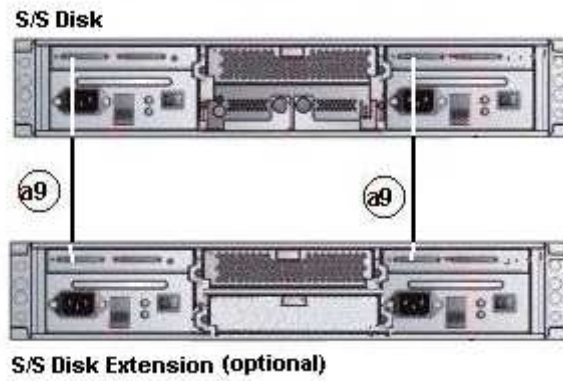

Mark	Cable Type	From	To
a9	SCSI-3 68-pin VHDCI to VHDCI cable	SR-0812 SCSI RAID extension port	SJ-0812 SCSI JBOD extension port

Figure 115. SJ-0812 SCSI JBOD extension disk rack data cabling diagram

Disk Rack (FDA 1300 FC)

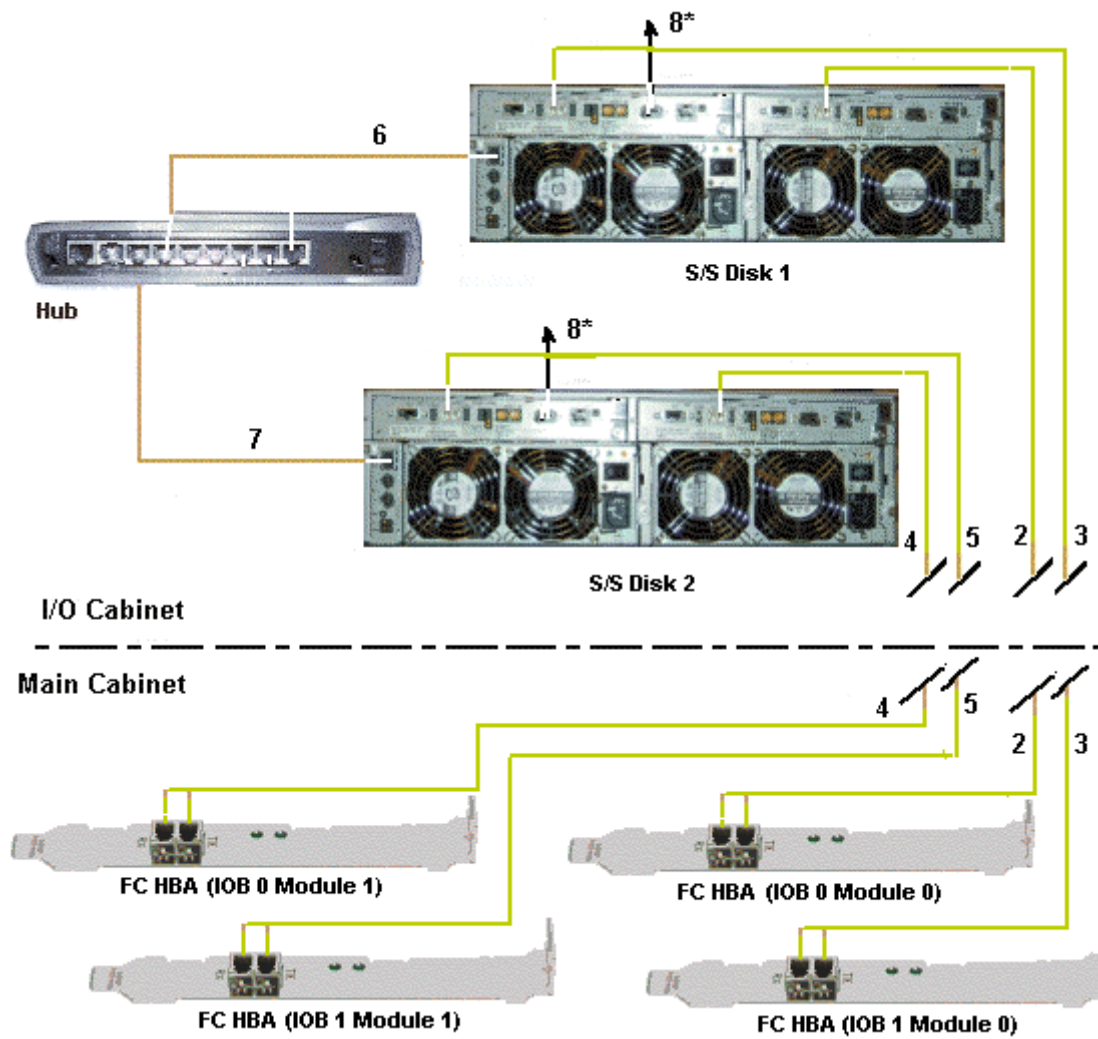

Mark	Cable Type	From	To
2**	LC–LC cable	S/S Disk (CTL 0)	FC Adapter IOB 0 Module 0
3**	LC–LC cable	S/S Disk (CTL 1)	FC Adapter IOB 1 Module 0
4**	LC–LC cable	S/S Disk (CTL 0)	FC Adapter IOB 0 Module 1
5**	LC–LC cable	S/S Disk (CTL 1)	FC Adapter IOB 1 Module 1
6	RJ45 – RJ45 Ethernet cable	S/S Disk	Hub port 6
7	RJ45 – RJ45 Ethernet cable	S/S Disk	Hub port 7
8 *	DB9 to DB9 serial cable	PAP COM 1	S/S Disk RS232

* optional cable used to configure the S/S disk.

** Inter-cabinet data cable

Figure 116. FDA 1300 FC disk rack data cabling diagram

Extension Disk Rack (FDA 1300 FC – FDA 1300 FC)

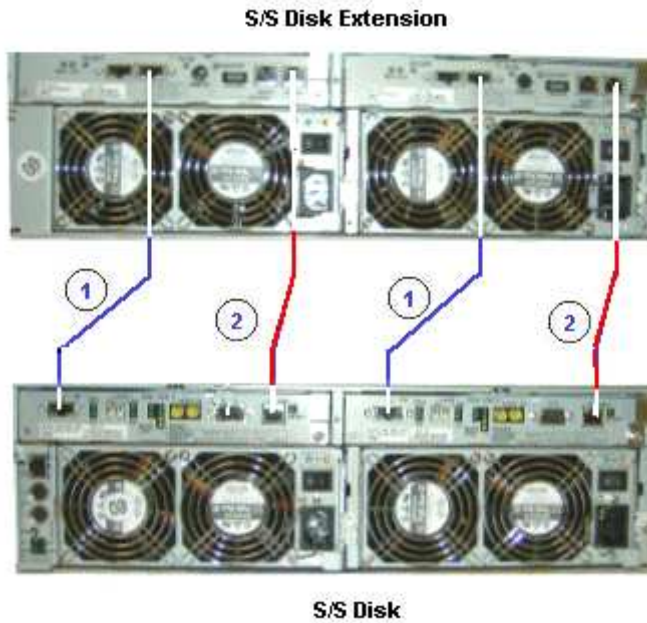

Mark	Cable Type	From	To
1	HSSDC–HSSDC cable	S/S Disk	S/S Disk Extension
2	DE diagnosis cable	S/S Disk	S/S Disk Extension

Figure 117. FDA 1300 FC – FDA 1300 FC extension disk rack data cabling diagram

Disk Rack (FDA 2300 FC)

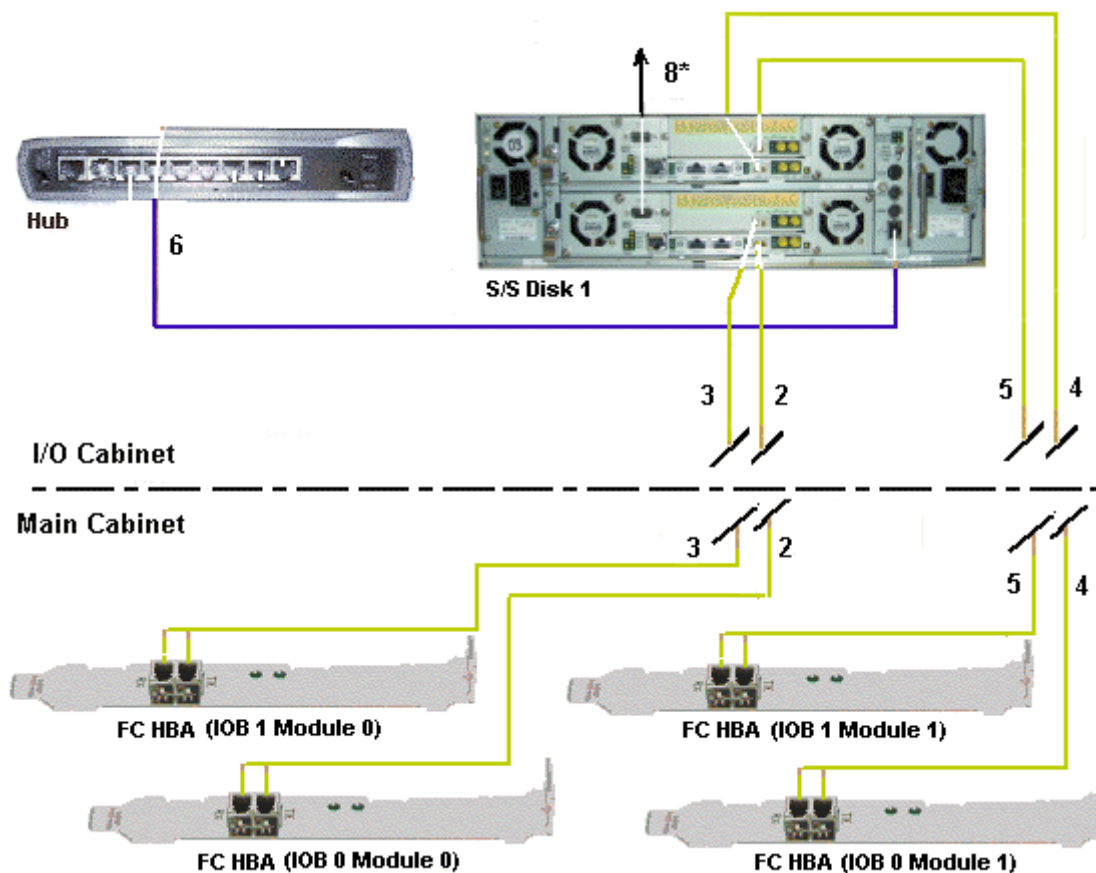

Mark	Cable Type	From	To
2**	LC-LC cable	S/S Disk (CTL0-HF0)	FC Adapter IOB 0 Module 0
3**	LC-LC cable	S/S Disk (CTL0-HF1)	FC Adapter IOB 1 Module 0
4**	LC-LC cable	S/S Disk (CTL1-HF0)	FC Adapter IOB 0 Module 1
5**	LC-LC cable	S/S Disk (CTL1-HF1)	FC Adapter IOB 1 Module 1
6	RJ45 - RJ45 Ethernet cable	S/S Disk	Hub port 6
8 *	DB9 to DB9 serial cable	PAP COM 1	S/S Disk RS232

* optional cable used to configure the S/S disk.

** Inter-cabinet data cable

Figure 118. FDA 2300 FC disk rack data cabling diagram

Extension Disk Rack (FDA 2300 FC – FDA 1300 FC)

S/S Disk Extension

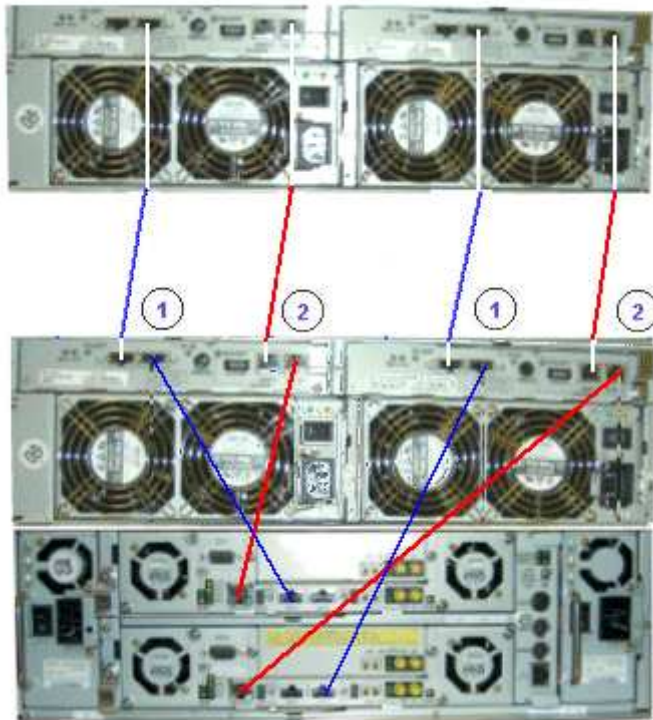

S/S Disk

Mark	Cable Type	From	To
1	HSSDC–HSSDC cable	S/S Disk	S/S Disk Extension
2	DE diagnosis cable	S/S Disk	S/S Disk Extension

Figure 119. FDA 2300 FC – FDA 1300 FC extension data cabling diagram

PMB

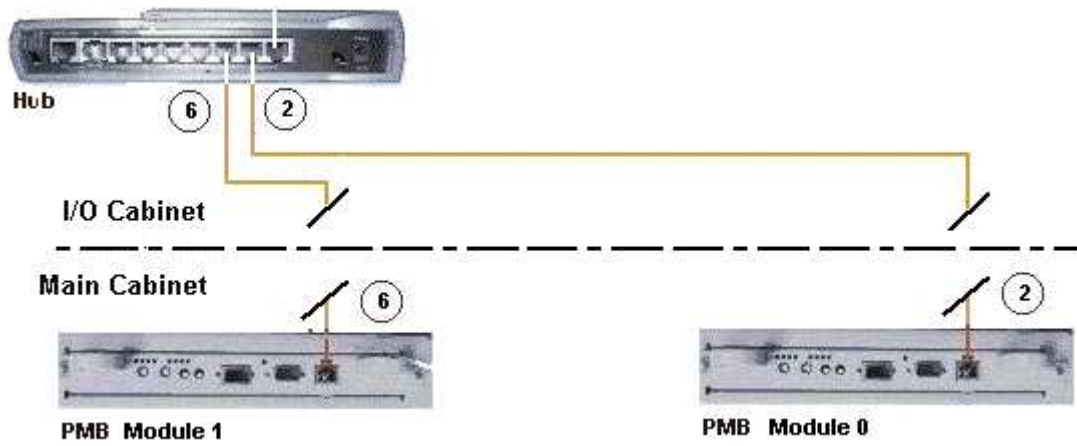

Mark	Cable Type	From	To
2*	RJ45 – RJ45 Ethernet cable	PMB Ethernet Module 0	Hub port 2
6*	RJ45 – RJ45 Ethernet cable	PMB Ethernet Module 1	Hub port 3

* Inter-cabinet data cable

Figure 120. PMB – Hub data cabling diagram

Ethernet Hub

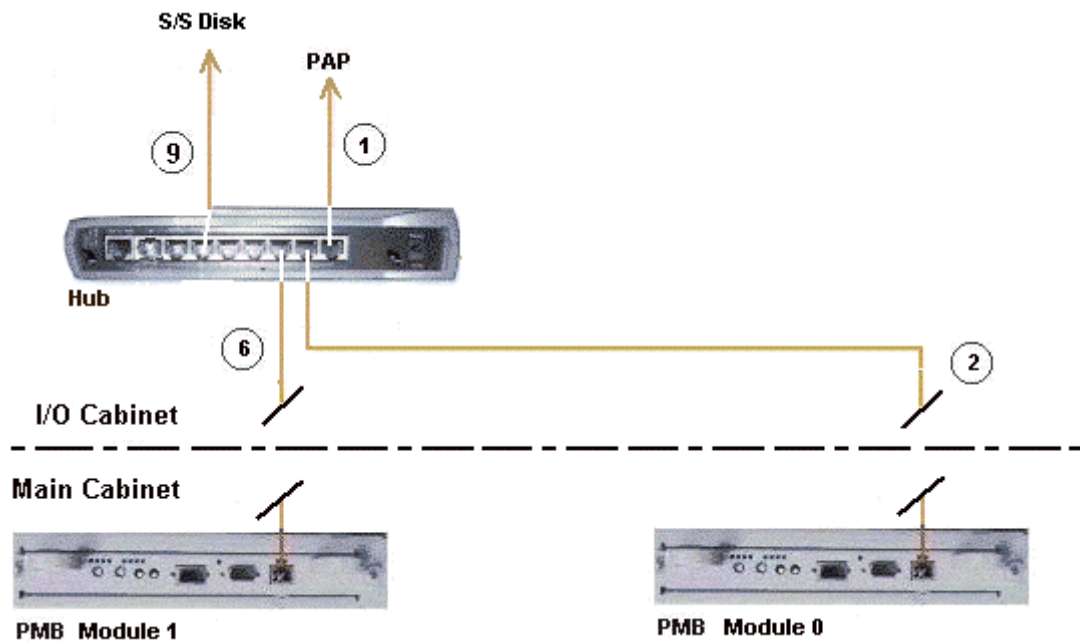

Mark	Cable Type	From	To
1	RJ45 – RJ45 Ethernet cable	PAP Ethernet	Hub port 1
2*	RJ45 – RJ45 Ethernet cable	PMB Ethernet Module 0	Hub port 2
6*	RJ45 – RJ45 Ethernet cable	PMB Ethernet Module 1	Hub port 3
9	RJ45 – RJ45 Ethernet cable	S/S Disk	Hub port 6

* Inter-cabinet data cable

Figure 121. Ethernet hub data cabling diagram

Modem

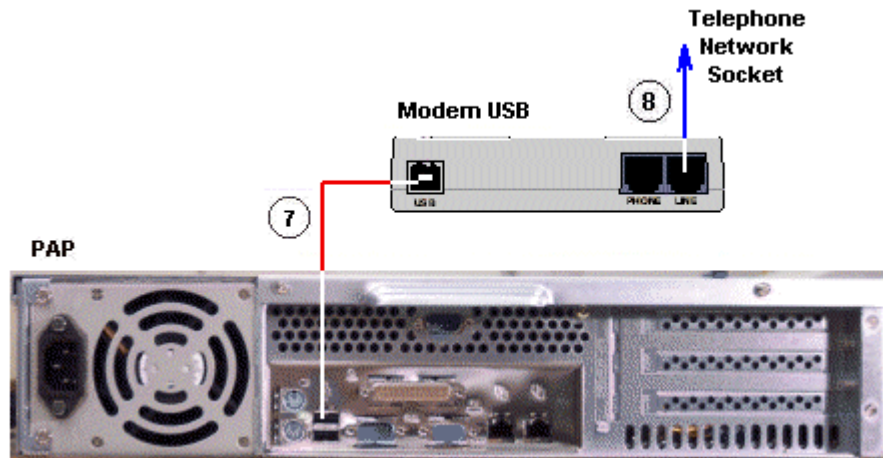
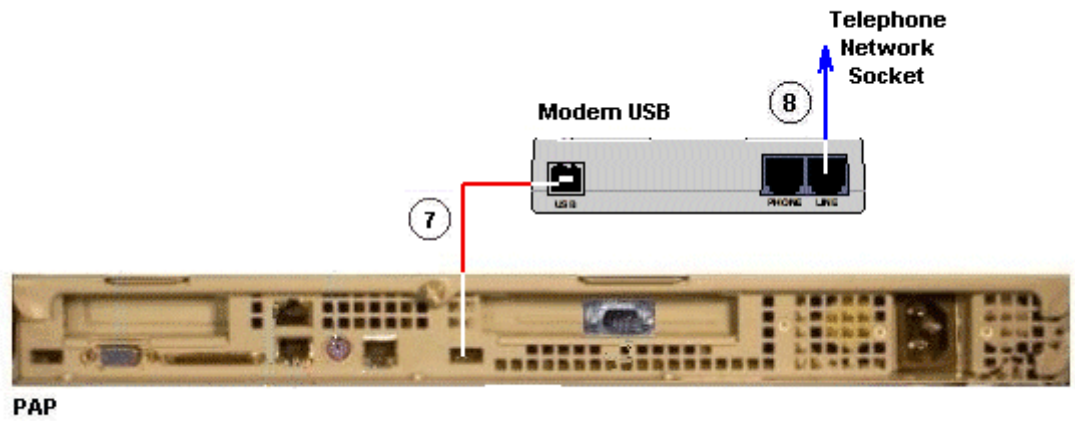

Mark	Cable Type	From	To
------	------------	------	----

Figure 122. Modem data cabling diagrams

Power

The CSS Modules in the main cabinet are equipped with dedicated power supply cables. All other server component power supply cables (in the I/O cabinet) are connected to one or two PDU(s), as shown below:

Main Cabinet

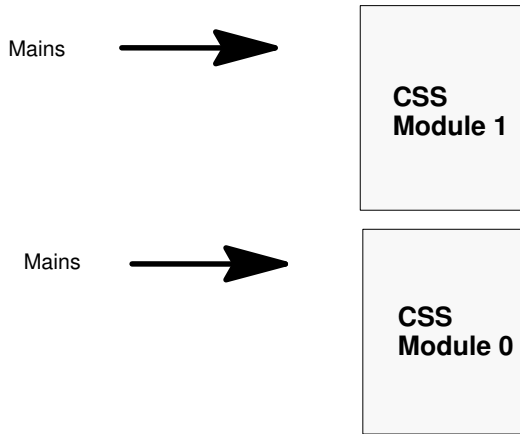
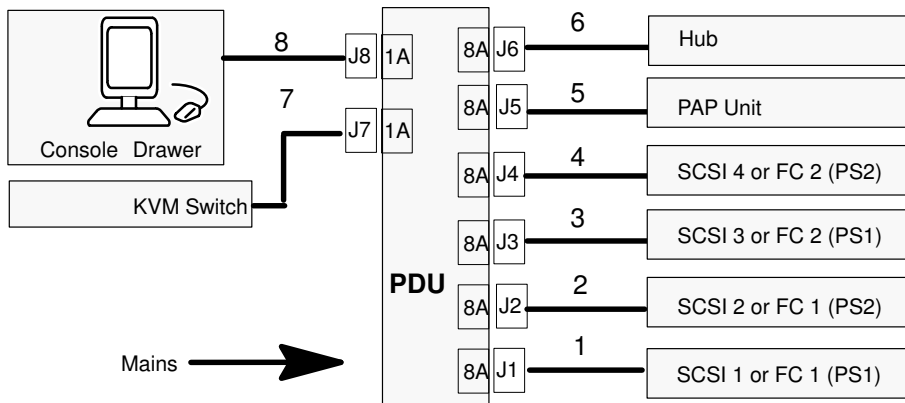

Figure 123. Main cabinet power cabling diagram

I/O Cabinet – Standard Configuration



Mark	Cable Type	From	To
1	Power cable	S/S Disk PWR	PDU J1
2	Power cable	S/S Disk PWR	PDU J2
3	Power cable	S/S Disk PWR	PDU J3
4	Power cable	S/S Disk PWR	PDU J4
5	Power cable	PAP PWR	PDU J5
6	Power cable	Hub	PDU J6
7	Power cable	KVM PWR	PDU J7
8	Power cable	Monitor PWR	PDU J8

Figure 124. I/O cabinet power cabling diagram (standard)

I/O Cabinet – Optional High Availability Configuration

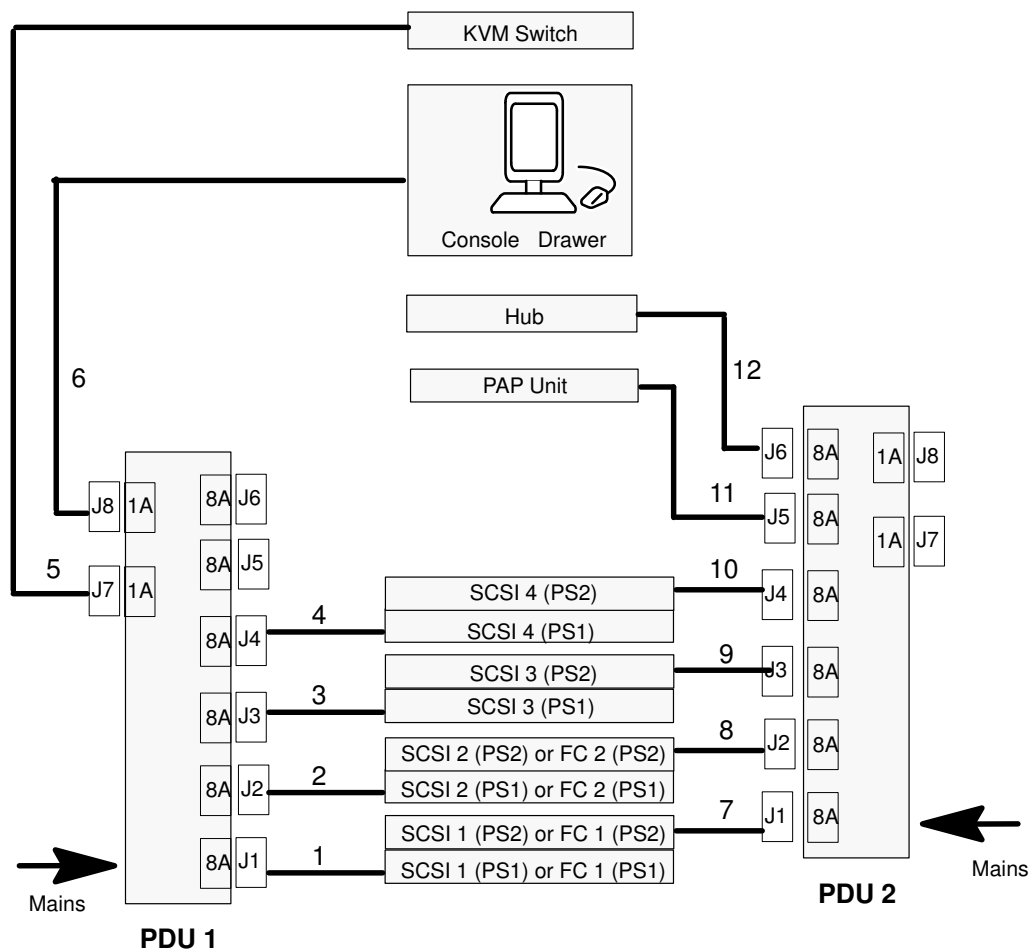

Mark	Cable Type	From	To
1	Power cable	S/S Disk PWR	PDU1 J1
2	Power cable	S/S Disk PWR	PDU1 J2
3	Power cable	S/S Disk PWR	PDU1 J3
4	Power cable	S/S Disk PWR	PDU1 J4
5	Power cable	KVM PWR	PDU1 J7
6	Power cable	Monitor PWR	PDU1 J8
7	Power cable	S/S Disk PWR	PDU2 J1
8	Power cable	S/S Disk PWR	PDU2 J2
9	Power cable	S/S Disk PWR	PDU2 J3
10	Power cable	S/S Disk PWR	PDU2 J4
11	Power cable	PAP PWR	PDU2 J5
12	Power cable	Hub	PDU2 J6

Figure 125. Power cabling diagram

Inter-Cabinet (PMB – Ethernet Hub)

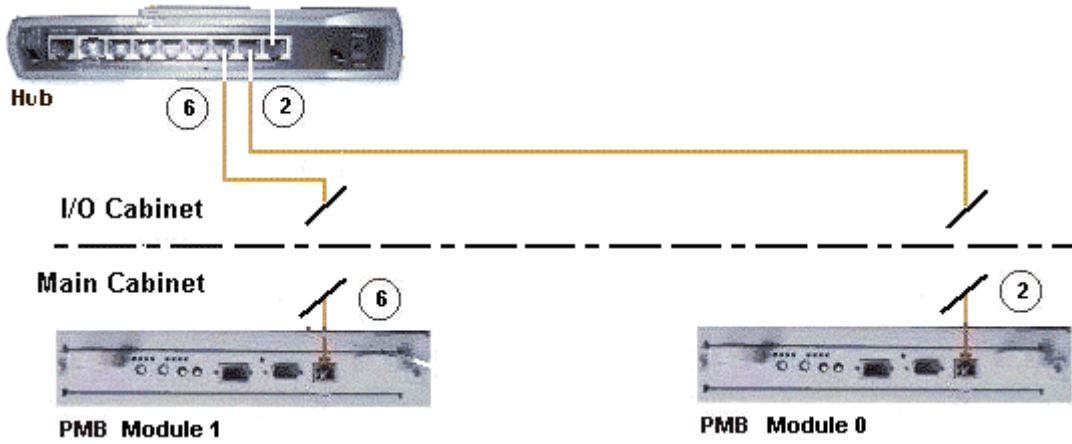

Mark	Cable Type	From	To
2	RJ45 – RJ45 Ethernet cable	PMB Ethernet Module 0	Hub port 2
6	RJ45 – RJ45 Ethernet cable	PMB Ethernet Module 1	Hub port 3

Figure 126. PMB – Ethernet Hub inter-cabinet cabling diagram

Inter-Cabinet (IOR – KVM Switch)

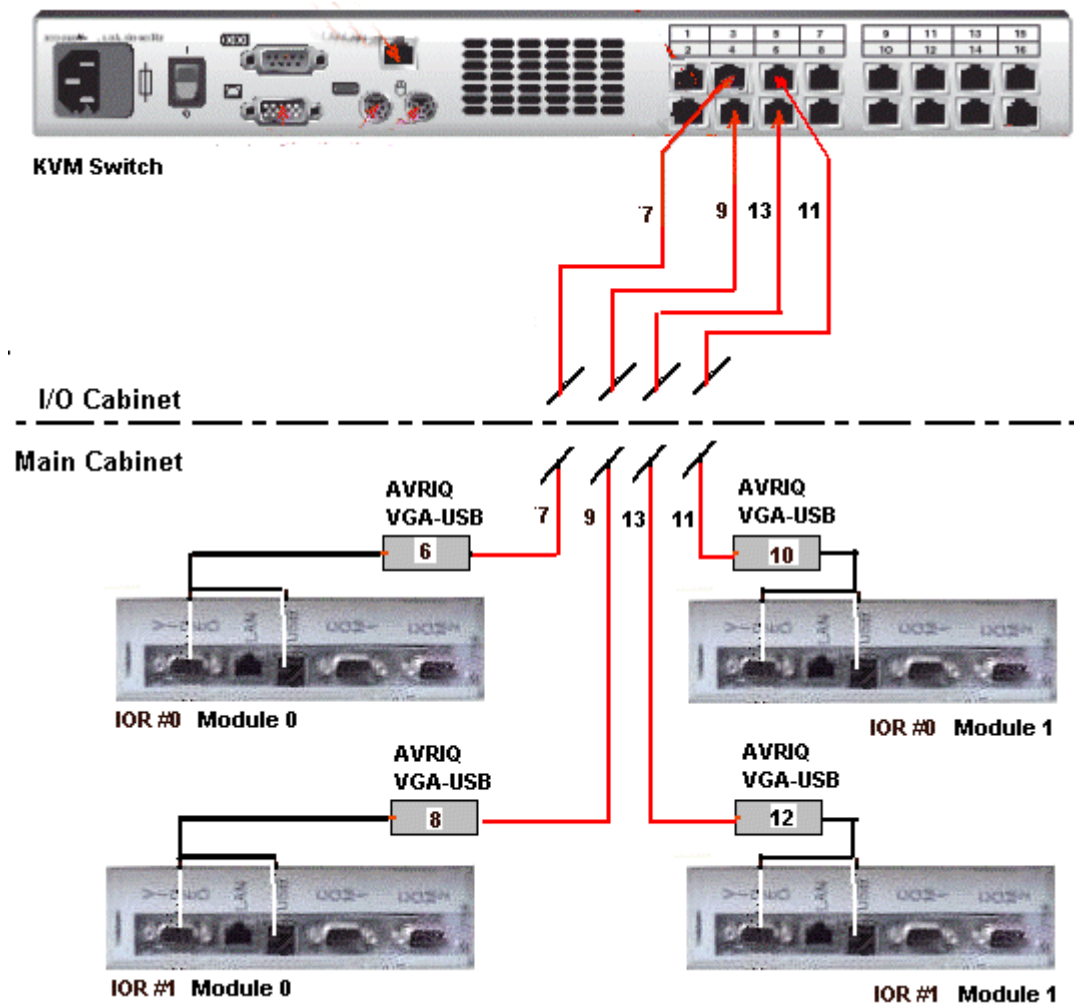

Mark	Cable Type	From	To
7	RJ45/RJ45 cable	IOR #0 Module 0 VGA and USB via AVRIQ (6)	KVM Port 3
9	RJ45/RJ45 cable	IOR #1 Module 0 VGA and USB via AVRIQ (8)	KVM Port 4
11	RJ45/RJ45 cable	IOR #0 Module 1 VGA and USB via AVRIQ (10)	KVM Port 5
13	RJ45/RJ45 cable	IOR #1 Module 1 VGA and USB via AVRIQ (12)	KVM Port 6

Figure 127. IOR – 16-port KVM switch inter-cabinet cabling diagram

Inter-Cabinet (IOB HBA RAID – SJ-0812 SCSI JBOD)

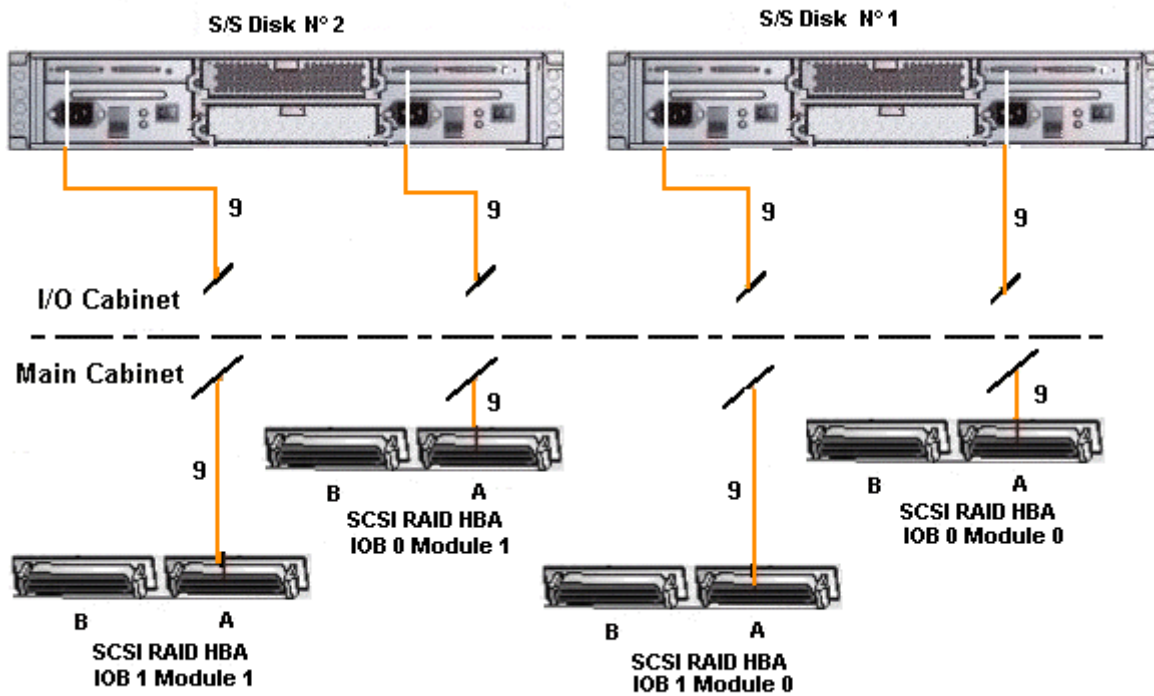

Mark	Cable Type	From	To
9	SCSI-3 68-pin VHDCI to VHDCI cable	HBA SCSI	S/S Disk Host port

Figure 128. IOB HBA RAID – SJ-0812 SCSI JBOD disk rack inter-cabinet cabling diagram

Inter-Cabinet (IOB HBA – SR-0812 SCSI RAID)

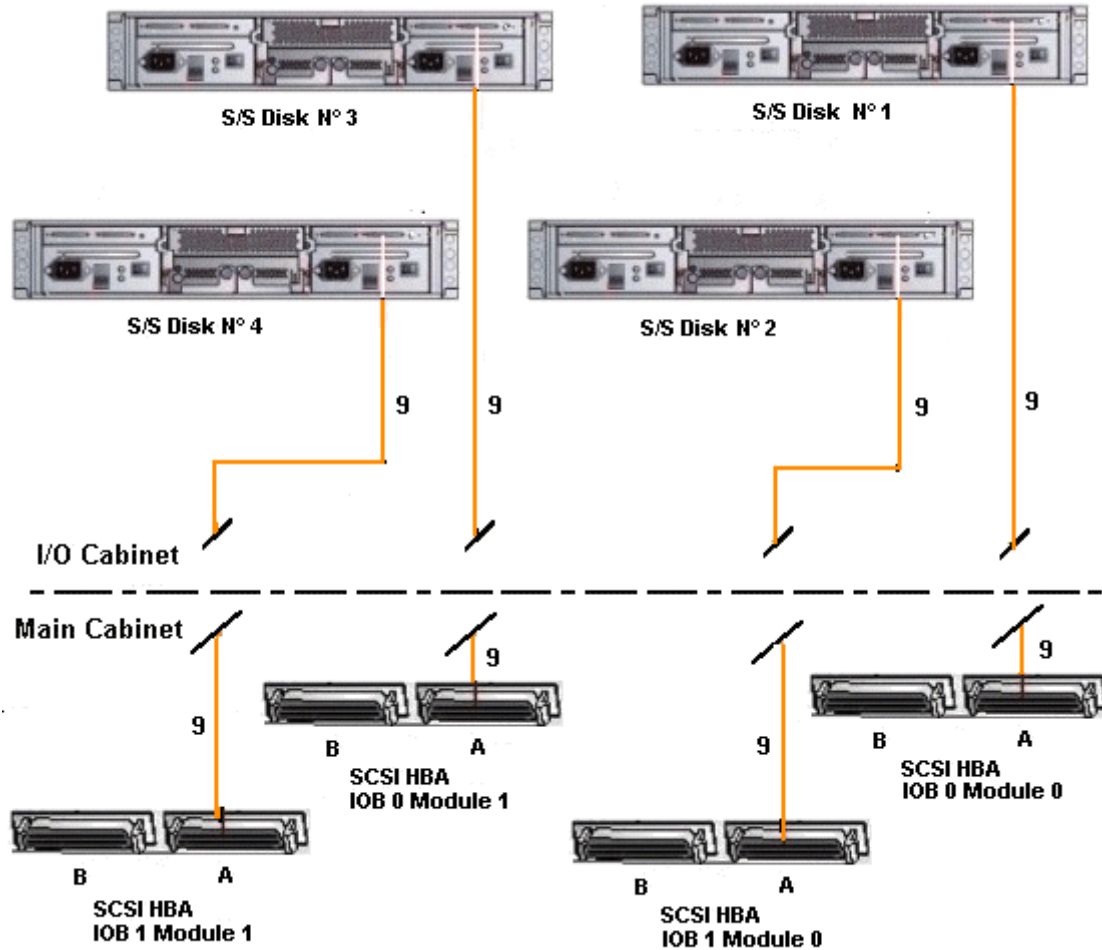

Mark	Cable Type	From	To
9	SCSI-3 68-pin VHDCI to VHDCI cable	HBA SCSI	S/S Disk Host port

Figure 129. IOB HBA – SR-0812 SCSI RAID disk rack inter-cabinet cabling diagram

Inter-Cabinet (IOB HBA – FDA 1300 FC)

Mark	Cable Type	From	To
2	LC-LC cable	S/S Disk (CTL 0)	FC Adapter IOB 0 Module 0
3	LC-LC cable	S/S Disk (CTL 1)	FC Adapter IOB 1 Module 0
4	LC-LC cable	S/S Disk (CTL 0)	FC Adapter IOB 0 Module 1
5	LC-LC cable	S/S Disk (CTL 1)	FC Adapter IOB 1 Module 1

Figure 130. IOB HBA – FDA 1300 FC disk rack inter-cabinet cabling diagram

Inter-Cabinet (IOB HBA – FDA 2300 FC)

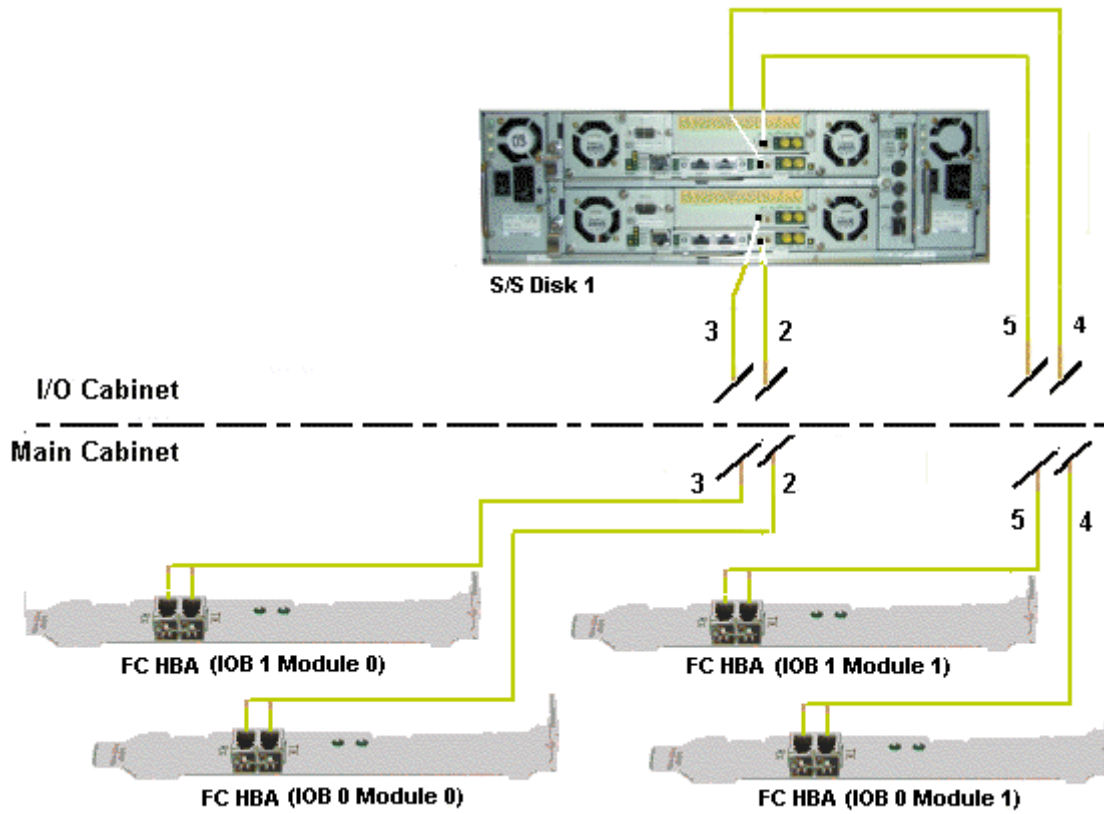

Mark	Cable Type	From	To
2	LC-LC cable	S/S Disk (CTL 0)	FC Adapter IOB 0 Module 0
3	LC-LC cable	S/S Disk (CTL 1)	FC Adapter IOB 1 Module 0
4	LC-LC cable	S/S Disk (CTL 0)	FC Adapter IOB 0 Module 1
5	LC-LC cable	S/S Disk (CTL 1)	FC Adapter IOB 1 Module 1

Figure 131. FDA 2300 FC disk rack inter-cabinet data cabling diagram

Glossary

A

AC: Alternating Current generated by the power supply. See DC.

ACPI: Advanced Configuration and Power Interface. An industry specification for the efficient handling of power consumption in desktop and mobile computers. ACPI specifies how a computer's BIOS, operating system, and peripheral devices communicate with each other about power usage.

Address: A label, name or number that identifies a location in a computer memory.

AMI: American Megatrends Incorporated.

ANSI: American National Standards Institute.

API: Application Program Interface. The specific method prescribed by a computer operating system or by an application program by which a programmer writing an application program can make requests of the operating system or another application.

Archive: (Archive file). A file that is a copy of a history file. When a history file is archived, all messages are removed from the history file.

ASCII: American National Standard Code for Information Interchange. A standard number assigned to each of the alphanumeric characters and keyboard control code keys to enable the transfer of information between different types of computers and peripherals.

B

Backup: A copy of data for safe-keeping. The data is copied from computer memory or disk to a floppy disk, magnetic tape or other media.

Backup battery: The battery in a computer that maintains real-time clock and configuration data when power is removed.

Baud rate: The speed at which data is transmitted during serial communication.

BIOS: Basic Input / Output System. A program stored in flash EPROM or ROM that controls the system startup process.

BIST: Built-In Self-Test. See POST.

Bit: Derived from Binary digit. A bit is the smallest unit of information a computer handles.

BTU: British Thermal Unit.

Byte: A group of eight binary digits (bit) long that represents a letter, number, or typographic symbol.

C

Cache Memory: A very fast, limited portion of RAM set aside for temporary storage of data for direct access by the microprocessor.

CD-ROM: Compact Disk Read-Only Memory. High-capacity read-only memory in the form of an optically readable compact disk.

Cell: The smallest set of hardware components allocated to a single OS. A cell is functionally defined by:

- the number of available processors
- memory capacity
- I/O channel capacity.

CellBlock: A group of interconnected cells within a single domain. See Central Subsystem.

Central Subsystem: A group of interconnected cells gathered within a single domain. See CellBlock.

Chip: Synonym for integrated circuit. See IC.

Clipping: A PAM Event filter criterion. Clipping is defined on a Count / Time basis aimed at routing a pre-defined number of messages only. Identical messages are counted and when the number of messages indicated in the **Count** field is reached within the period of time indicated in the **Time** field, no other messages will be selected for routing.

CMC: Corrected Memory Check.

CMOS: Complementary Metal Oxide Semiconductor. A type of low-power integrated circuits. System startup parameters are stored in CMOS memory. They can be changed via the system setup utility.

COM: Component Object Model. Microsoft technology for component based application development under Windows.

COM +: Component Object Model +. Microsoft technology for component based application development under Windows. The external part of the PAM software package is a COM+ application.

COM1 or COM2: The name assigned to a serial port to set or change its address. See Serial Port.

Command: An instruction that directs the computer to perform a specific operation.

Configuration: The way in which a computer is set up to operate. Configurable options include CPU speed, serial port designation, memory allocation, ...

Configuration Tasks: A PAM feature used to configure and customize the server.

Control Pane: One of the three areas of the PAM web page. When an item is selected in the **PAM Tree** pane, details and related commands are displayed in the **Control** pane. See PAM Tree pane and Status pane.

Core Unit: A main CSS module unit interconnecting the MIO, MQB, MSX and MFL boards. See MIO, MQB, MSX, MFL.

COS: Cluster Operating System.

CPE: Corrected PCI Error.

CPU: Central Processing Unit. See Microprocessor.

CSE: Customer Service Engineer.

CSS: Central Sub-System. See CellBlock.

CSS Module: A MidPlane with all its connected components (QBBs, IO boards, PMB) and utility devices. See Module.

D

D2D: DC to DC converter.

DC: Direct Current generated by the power supply. See AC.

Default Setting: The factory setting your server uses unless instructed otherwise.

Density: The capacity of information (bytes) that can be packed into a storage device.

Device Driver: A software program used by a computer to recognize and operate hardware.

DIB: Device Interface Board. The DIB provides the necessary electronics for the Internal Peripheral Drawer. See IPD.

DIG64: Developer Interface Guide for IA64.

DIM Code: Device Initialization Manager. Initializes different BUSES during the BIOS POST.

DIMM: Dual In-line Memory Module – the smallest system memory component.

Disk Drive: A device that stores data on a hard or floppy disk. A floppy disk drive requires a floppy disk to be inserted. A hard disk drive has a permanently encased hard disk.

DMA: Direct Memory Access. Allows data to be sent directly from a component (e.g. disk drive) to the memory on the motherboard). The microprocessor does not take part in data transfer enhanced system performance.

DMI: Desktop Management Interface. An industry framework for managing and keeping track of hardware and software components in a system of personal computers from a central location.

DNS: Domain Name Server. A server that retains the addresses and routing information for TCP/IP LAN users.

Domain: is the coherent set of resources allocated to run a customer activity, i.e. the association –at boot time– of a Partition, an OS instance (including applications) and associated LUNs and an execution context including execution modes and persistent information (e.g. time, date of the OS instance). Domain definitions and initializations are performed via PAM. A Domain can be modified to run the same OS instance on a different Partition. When a Domain is running, its resources are neither visible nor accessible to other running Domains.

Domain Identity: a PAM Domain management logical resource. This resource contains context information related to the Customer activity running in a domain. The most visible attribute of this resource is the name that the Customer gives to the activity. For each domain created, the Domain management feature allows the operator to define a new activity or choose an activity from the list of existing activities. See Domain.

Domain Manager: A PAM feature used to power on / off and manage server domains. See Domain.

DPS: Distributed Power Supply.

DRAM: Dynamic Random Access Memory is the most common type of random access memory (RAM).

E

EEPROM: Electrically Erasable Programmable Read-Only Memory. A type of memory device that stores password and configuration data. See also EPROM.

EFI: Extensible Firmware Interface.

EFIMTA: EFI Modular Test Architecture.

EFI Shell: The EFI (Extensible Firmware Interface) Shell is a simple, interactive user interface that allows EFI device drivers to be loaded, EFI applications to be launched, and operating systems to be booted. In addition, the EFI Shell provides a set of basic commands used to manage files and the system environment variables. See Shell.

EMI: Electro-Magnetic Interference.

EPROM: Erasable Programmable Read-Only Memory. A type of memory device that is used to store the system BIOS code. This code is not lost when the computer is powered off.

ERC: Error Recovery Check.

ERP: Error Recovery Procedure.

ESD: ElectroStatic Discharge. An undesirable discharge of static electricity that can damage equipment and degrade electrical circuitry.

Event: The generation of a message (event message) by a software component and that is directed to the Event Manager.

Event address: Defines the destination for a message sent over a specified event channel. An address is one of: the name of a history file (for the HISTORY channel), an e-mail address (for the EMAIL channel), the name of a user group (for the WEB channel), the SNMP Manager IP address (for the SNMP channel).

Event channel: Defines how the Event Manager sends an event message. An event channel is one of: HISTORY (the message is logged in a history file), EMAIL (the message is sent to an e-mail address), WEB (the message is stored for analysis from the PAM web user interface), SNMP (the message is sent as an SNMP trap to the selected SNMP application).

Event filter: A list of selected messages among all possible event messages. If an event message is not included in the filter, the Event Manager discards the message.

Event Manager: A PAM feature used to forward event messages over a configured event channel. See Event.

Event message: A message sent by a software component to the Event Manager for routing to a destination that is configured by an administrator.

Event subscription: An object that defines the event channel, address, and filter for sending an event message. If no such object is defined, the event message is discarded.

F

Fail-over: Failover is a backup operational mode in which the functions of a system component (such as a processor, server, network, or database, for example) are assumed by secondary system components when the primary component becomes unavailable through either failure or scheduled down time.

FAME: Flexible Architecture for Multiple Environments.

FAST WIDE: A standard 16-bit SCSI interface providing synchronous data transfers of up to 10 MHz, with a transfer speed of 20M bytes per second.

FC: Fibre Channel.

FCAL: Fibre Channel Arbitrated Loop.

FCA: Fibre Channel Adapter.

FCBQ: Fan Control Board for QBB.

FCBS: Fan Control Board for SPS.

FDA: Fibre Disk Array.

FDD: Floppy Disk Drive.

Flash EPROM: Flash Erasable Programmable Read-Only Memory. A type of memory device that is used to store the the system firmware code. This code can be replaced by an updated code from a floppy disk, but is not lost when the computer is powered off.

Firewall: A set of related programs, located at a network gateway server, that protects the resources of a private network from users from other networks.

Firmware: an ordered set of instructions and data stored to be functionally independent of main storage.

Format: The process used to organize a hard or floppy disk into sectors so that it can accept data. Formatting destroys all previous data on the disk.

FPB: FAME Power Board (FAME: Flexible Architecture for Multiple Environments).

FPGA: Field Programmable Gate Array. A gate array that can be reprogrammed at run time.

FRB: Fault Resilient Boot. A server management feature. FRB attempts to boot a system using the alternate processor or DIMM.

FRU: Field Replaceable Unit. A component that is replaced or added by Customer Service Engineers as a single entity.

FSS: FAME Scalability Switch. Each CSS Module is equipped with 2 Scalability Port Switches providing high speed bi-directional links between server components. See SPS.

FTP: File Transfer Protocol. A standard Internet protocol: the simplest way of exchanging files between computers on the Internet. FTP is an application protocol that uses Internet TCP/IP protocols. FTP is commonly used to transfer Web page files from their creator to the computer that acts as their server for everyone on the Internet. It is also commonly used to download programs and other files from other servers.

FWH: FirmWare Hub.

G

GB: GigaByte: 1,073,741,824 bytes. See Byte.

GUI: Graphical User Interface.

GTS: Global Telecontrol Server.

H

HA: High Availability. Refers to a system or component that is continuously operational for a desirably long length of time.

HA CMP: High Availability Clustered MultiProcessing.

Hard Disk Drive: HDD. See Disk Drive.

Hardware: The physical parts of a system, including the keyboard, monitor, disk drives, cables and circuit cards.

Hardware Monitor: A PAM feature used to supervise server operation.

HBA: Host Bus Adapter.

HDD: Hard Disk Drive. See Disk Drive.

History File: A file in which the History Manager logs informative messages or error messages relating to system activity. Messages are sent from source components to target components.

History Manager: The component running on the PAP Windows operating system that logs messages to history files.

HPB: Hot Plug Board. This board provides an interlock switch on each IO Box PCI slot for hot-swapping PCI boards. See P-HPB.

HPC: High Performance Computing.

Hot plugging: The operation of adding a component without interrupting system activity.

Hot swapping: The operation of removing and replacing a faulty component without interrupting system activity.

HTTP: HyperText Transfer Protocol. In the World Wide Web, a protocol that facilitates the transfer of hypertext-based files between local and remote systems.

HW Identifier: Number (0 – F) used to identify Cellblock components. This number is identical to PMB code-wheel position.

I

I2C: Intra Integrated Circuit. The I2C (Inter-IC) bus is a bi-directional two-wire serial bus that provides a communication link between integrated circuits (ICs).

The I2C bus supports 7-bit and 10-bit address space devices and devices that operate under different voltages.

IA64: is a 64-bit Intel processor Architecture based on Explicitly Parallel Instruction Computing (EPIC). The Itanium processor is the first in the Intel line of IA-64 processors.

IB: Infini Band.

IC: Integrated Circuit. An electronic device that contains miniaturized circuitry. See Chip.

ICH4: I/O Control Hub.

ICMB: Intelligent Chassis Management Bus.

ID: A number which uniquely identifies a device on a bus.

IDE: Integrated Drive Electronics. A type of hard disk drive with the control circuitry located inside the disk drive rather than on a drive controller card.

Identity: See Domain Identity.

IIS: Internet Information Server. A group of Internet servers (including a Web or HTTP server and a FTP server) with additional capabilities for Microsoft Windows NT and Microsoft Windows (and later) operating systems.

I/O: Input /Output. Describes any operation, program, or device that transfers data to or from a computer.

Interface: A connection between a computer and a peripheral device enabling the exchange of data. See Parallel Port and Serial Port.

IOB: Input / Output Board. The IOB connects up to 11 PCI-X boards.

IOC: Input / Output Board Compact. The IOC connects up to 6 PCI-X boards.

IOL: I/O Board Legacy. The IOL provides:

- I/O controller Hub
- USB ports
- 10/100/1000 Ethernet controller
- Video controller
- Serial / debug port

IOR: I/O Board Riser. The IOR provides:

- I/O controller Hub
- USB ports
- 10/100/1000 Ethernet controller
- Video controller
- Serial / debug port

IP: Internet Protocol. The protocol by which data is sent from one computer to another via the Internet. Each computer (known as a host) on the Internet has at least one IP address that uniquely identifies it from all other computers on the Internet.

IPD: Internal Peripheral Drawer. The IPD houses legacy peripherals (DVD-Rom drive, USB port) and SCSI system disks.

IPF: Itanium Processor Family.

IPL: Initial Program Load. It defines the firmware functional phases during the system initialization.

IPMB: Intelligent Platform Management Bus.

IPMI: Intelligent Platform Management Interface.

ISA: Industry Standard Architecture. An industry standard for computers and circuit cards that transfer 16 bits of data at a time.

J

Jumper: A small electrical connector used for configuration on computer hardware.

K

KVM: Keyboard Video Monitor.

KVM switch: the Keyboard Video Monitor switch allows the use of a single keyboard, monitor and mouse for more than one module.

L

LAN: Local Area Network. A group of computers linked together within a limited area to exchange data.

LD: Logical Disk. A Storeway FDA 1300/2300 logical disk (or LUN) is visible to the OS as a Disk. See LUN and PD (Physical Disk).

LED: Light Emitting Diode. A small electronic device that glows when current flows through it.

Legacy Application: An application in which a company or organization has already invested considerable time and money. Typically, legacy applications are database management systems (DBMSs) running on mainframes or minicomputers.

LPT1 or LPT2: The name assigned to a parallel port to specify its address. See Parallel Port.

LS240: Laser Servo super diskette holding up to 240 Mb.

LUN: Logical Unit Number. Term used to designate Logical Storage Units (logical disks) defined through the configuration of physical disks stored in a mass storage cabinet.

LVDS: Low Voltage Differential SCSI.

M

MAESTRO: Machine Administration Embedded Software Real Time Oriented. Part of the PAM software package embedded on the PMB board.

MCA: Machine Check Abort.

Memory: Computer circuitry that stores data and programs. See RAM and ROM.

Memory bank: The minimum quantity of memory used by the system. It physically consists of four memory DIMMs.

MFL: Midplane Fan & Logistics board. The MFL houses the Fan Boxes and is connected to the MIO and MQB. See MIO, MQB.

Microprocessor: An integrated circuit that processes data and controls basic computer functions.

Midplane: Mid–Plane. All system hardware components are connected to the Midplane.

MIMD: Multiple Instruction Multiple Data

MIO: Midplane Input / Output board. The MIO connects one or two IOC boards and the PMB. See Core Unit.

Mirrored volumes: A mirrored volume is a fault–tolerant volume that duplicates your data on two physical disks. If one of the physical disks fails, the data on the failed disk becomes unavailable, but the system continues to operate using the unaffected disk.

Module: a Midplane Board with all its connected components and utility devices. See CSS Module and MP.

MQB: Midplane QBB board. The MQB connects one or two QBBs and one or two IPDs. See QBB and IPD.

MSX: Midplane SPS & XPS board. The MSX houses a B–SPS switch and is connected to the MIO and the MQB. There are two MSX boards in a CSS module. All SP connections between a QBB and an IOC use an MSX. See B–SPS, MIO, MQB.

MTBF: Mean Time Between Failure. An indicator of expected system reliability calculated on a statistical basis from the known failure rates of various components of the system. Note: MTBF is usually expressed in hours.

Multimedia: Information presented through more than one type of media. On computer systems, this media includes sound, graphics, animation and text.

Multitasking: The ability to perform several tasks simultaneously. Multitasking allows you to run multiple applications at the same time and exchange information among them.

N

NFS: Network File System. A proprietary distributed file system that is widely used by TCP/IP vendors. Note: NFS allows different computer systems to share files, and uses user datagram protocol (UDP) for data transfer.

NMI: Non–Maskable Interrupt.

NUMA: Non Uniform Memory Access. A method of configuring a cluster of microprocessors in a multiprocessing system so that they can share memory locally, improving performance and the ability of the system to be expanded.

nsh: nsh stands for **new shell**. See Shell and EFI Shell.

NVRAM: Non Volatile Random Access Memory. A type of RAM that retains its contents even when the computer is powered off. See RAM and SRAM.

O

OF: Open Firmware. Firmware controlling a computer prior to the Operating System.

Operating System: See OS.

OS: Operating System. The software which manages computer resources and provides the operating environment for application programs.

P

PAL: Processor Abstraction Layer. See SAL.

PAM: Platform Administration & Maintenance.

PAM software: Platform Administration & Maintenance software. One part (PAP application and the PamSite WEB site) runs on the PAP unit. The other part (MAESTRO) is embedded on the PMB board.

PAM Tree pane: One of the three areas of the PAM web page. Server hardware presence and functional status are displayed in the PAM Tree pane. See Status pane and Control pane.

PAP unit: Platform Administration Processor unit. The PC hosting all server administration software.

PAP application: Platform Administration Processor application. Part of PAM software, PAP application is a Windows COM+ application running on PAP unit.

Parallel Port: Connector allowing the transfer of data between the computer and a parallel device.

PARM request: the PARM application is designed to handle Requests issued by the CSE (Customer Service Engineer)

Partition: Division of storage space on a hard disk into separate areas so that the operating system treats them as separate disk drives.

Password: A security feature that prevents an unauthorized user from operating the system.

PCI: Peripheral Component Interconnect. Bus architecture supporting high-performance peripherals.

PD: Physical Disk. A Storeway FDA 1300/2300 physical disk is not visible to the OS. See LD.

PDU: Power Distribution Unit. Power bus used for the connection of peripheral system components.

Permanence: Property of a history file that determines whether or not the history file can be modified or deleted from the PAM user interface. Permanence is either *Static* (cannot be modified) or *Dynamic* (can be modified).

P-HPB: PCI Hot Plug Board. This board provides an interlock switch on each IO Box PCI slot for hot-swapping PCI boards. See HPB.

PIC: Platform Instrumentation Control.

ping: A basic Internet program that lets you verify that a particular IP address exists and can accept requests. The verb “to ping” means the act of using the ping utility or command.

PIROM: Processor Information ROM. Processor Information ROM (PIROM) contains information about the specific processor in which it resides. This information includes robust addressing headers to allow for flexible programming and forward compatibility, core and L2 cache electrical specifications, processor part and S-spec numbers, and a 64-bit processor number.

PMB: Platform Management Board. Links the server to the PAP unit.

PNP: Plug aNd Play. The ability to plug a device into a computer and have the computer recognize that the device is there.

POST: Power On Self Test. When power is turned on, POST (Power-On Self-Test) is the diagnostic testing sequence (or “starting program”) that a computer runs to determine if hardware is working correctly.

PROM: Programmable Read-Only Memory.

PUID: PAM Universal/Unique IDentifier. PAM software allocates a PUID (PAM Universal / Unique Identifier) to each hardware / software object to guarantee unambiguous identification. The PUID for each hardware element can be obtained by hovering the mouse over the corresponding element in the PAM tree, e.g.: PAM:/CELLSBLOCK_<NAME>/MODULE_x/QBB_y/CPU_y.

Q

QBB: Quad Brick Board. The QBB is the heart of the Bull NovaScale Server, housing 4 Itanium® 2 processors and 16 DIMMs. Each QBB communicates with other CSS Module components via 2 high-speed bidirectional Scalability Port Switches.
See SPS or FSS.

R

RAID: Redundant Array of Independent Disks. A method of combining hard disk drives into one logical storage unit for disk-fault tolerance.

RAM: Random Access Memory. A temporary storage area for data and programs. This type of memory must be periodically refreshed to maintain valid data and is lost when the computer is powered off. See NVRAM and SRAM.

RAS: Reliability, Availability, Serviceability.

Real-time clock: The Integrated Circuit in a computer that maintains the time and date.

RFI: Radio Frequency Interference.

RJ45: 8-contact regular jack.

RMC: Remote Maintenance Console.

ROM: Read-Only Memory. A type of memory device that is used to store the system BIOS code. This code cannot be altered and is not lost when the computer is powered off. See BIOS, EPROM and Flash EPROM.

RS-232 Port: An industry standard serial port. See Serial Port.

RSF: Remote Service Facilities.

RTC: Real Time Clock.

S

S@N.IT: SAN Administration Tool.

SAL: System Abstraction Layer. See PAL.

SAN: Storage Area Network. A high-speed special-purpose network that interconnects different kinds of data storage devices with associated data servers on behalf of a larger network of users.

SAPIC: Streamlined Advanced Programmable Interrupt Controller message.

SBE: Single Bit Error.

Scheme: Configuration file ensuring optimum use and compatibility of the physical and logical resources used to simultaneously run multiple domains.

SCI: Scalable Coherent Interface.

SCSI: Small Computer System Interface. An input and output bus that provides a standard interface used to connect peripherals such as disks or tape drives in a daisy chain.

SDR: Sensor Data Record.

SDRAM: Synchronous Dynamic Random Access Memory. A type of DRAM that runs at faster clock speeds than conventional memory. See DRAM.

SEL: System Event Log. A record of system management events. The information stored includes the name of the event, the date and time the event occurred and event data. Event data may include POST error codes that reflect hardware errors or software conflicts within the system.

Serial Communication: Data sent sequentially, one bit at a time.

Serial Port: Connector that allows the transfer of data between the computer and a serial device. See COM1 or COM 2. Shell is a Unix term for the interactive user interface with an operating system.

SIO: Server I/O / Super I/O.

Shell: The Shell is the layer of programming that understands and executes the commands a user enters. As the outer layer of an operating system, the Shell can be contrasted with the kernel, the inmost layer or core of services of an operating system. See EFI Shell.

SIOH: Server I/O Hub.

SMBIOS: System Management BIOS.

SM-BUS: System Management Bus.

SMIC: Server Management Interface Chip.

SMP: Symmetrical Multi Processor. The processing of programs by multiple processors that share a common operating system and memory.

SNC: Scalable Node Controller.

SNM: System Network Module.

SNMP: Simple Network Management Protocol. The protocol governing network management and the monitoring of network devices and their functions.

Source: Each message refers to a source (the resource that generated the message) and a target (the component referred to in the message). This feature can be allows messages to be filtered according to one or more **Source** string(s) and is particularly useful for debugging and troubleshooting. See Target.

SPS: Scalability Port Switch. Each CSS Module is equipped with 2 Scalability Port Switches providing high speed bi-directional links between system components. See FSS.

SRAM: Static RAM. A temporary storage area for data and programs. This type of memory does not need to be refreshed, but is lost when the system is powered off. See NVRAM and RAM.

SSI: Server System Infrastructure.

Status Pane: One of the three areas of the PAM web page. Provides quick access to CSS Module availability status, server functional status, and pending event message information. See also Control pane and PAM Tree pane.

SVGA: Super Video Graphics Array.

T

Target: Each message refers to a target (the component referred to in the message), identified by its PUID, and a source (the component that generated the message). This feature allows messages to be filtered according to one or more **Target** string(s) and is particularly useful for debugging and troubleshooting. See Source and PUID.

TCP: Transmission Control Protocol. A set of rules (protocol) used along with the Internet Protocol (IP) to send data in the form of message units between computers over the Internet.

TCP/IP: Transmission Control Protocol / Internet Protocol. The basic communication language or protocol of the Internet.

T&D: Tests and Diagnostics.

Thresholding: A PAM Event filter criterion. Thresholding is defined on a Count / Time basis aimed at routing significant messages only. Identical messages are counted and when the number of messages indicated in the **Count** field is reached within the period of time indicated in the **Time** field, this message is selected for routing.

U

UART: a **U**niversal **A**synchronous **R**eceiver **T**ransmitter. The microchip with programming that controls a computer interface to its attached serial devices.

ULTRA SCSI: An enhanced standard 16-bit SCSI interface providing synchronous data transfers of up to 20 MHz, with a transfer speed of 40M bytes per second. It is also called Fast-20 SCSI.

UML: **U**nified **M**odeling **L**anguage. A standard notation for the modeling of real-world objects as a first step in developing an object-oriented design methodology.

UPS: **U**ninterruptible **P**ower **S**upply. A device that allows uninterrupted operation if the primary power source is lost. It also provides protection from power surges.

URL: **U**niform / **U**niversal **R**esource **L**ocator. The address of a file (resource) accessible on the Internet.

USB: **U**niversal **S**erial **B**us. A plug-and-play interface between a computer and add-on devices. The USB interface allows a new device to be added to your computer without having to add an adapter card or even having to turn the computer off.

V

VCC: **V**oltage **C**ontinuous **C**urrent.

VGA: **V**ideo **G**raphics **A**rray.

VI: **V**irtual **I**nterface.

Visibility: A property of a history file. Visibility is either *System* (the history file is predefined by the PAM software and is visible only to an administrator) or *User* (the history file is created by an administrator and is visible to both an administrator and an operator).

VLAN: **V**irtual **L**ocal **A**rea **N**etwork. A local area network with a definition that maps workstations on some other basis than geographic location (for example, by department, type of user, or primary application).

VxWORKS: Platform Management Board Operating System.

W

WAN: **W**ide **A**rea **N**etwork. Geographically dispersed telecommunications network. The term distinguishes a broader telecommunication structure from a local area network (LAN).

WBEM: **W**eb **B**ased **E**nterprise **M**anagement.

WMI: **W**indows **M**anagement **I**nterface.

WOL: A feature that provides the ability to remotely power on a system through a network connection.

X

XML: **eX**tended **M**arkUp **L**anguage. A flexible way to create common information formats and share both the format and the data on the World Wide Web, intranets, and elsewhere.

XSP: **eX**tended **S**calable **P**ort.

Y

No entries.

Z

No entries.

Index

Numbers

- 16-port KVM Switch, data cables, C-23
- 8-Port KVM Switch, data cables, C-4

A

- Access, front door, 2-2
- Autocalls
 - configuring, 2-32
 - FTP parameters, 2-32
 - testing, 2-52

B

- Back Up, PAM software, 2-63

C

- Cabinet
 - front door, 1-24
 - packing, 1-9
 - rear door, 1-25
 - refitting front door, 1-24
 - refitting rear door, 1-25
 - refitting side covers, 1-26
 - removing front door, 1-12
 - removing rear door, 1-13
 - removing side cover, 1-14
 - shipping brackets, 1-16
- Cabinet packing, removing, 1-10
- Cables, labels, 2-9
- Cabling, inter-cabinet, 2-9
- CD drive, troubleshooting, 3-9
- CD-ROM drive, 1-33
 - accessing, 2-6
- Central Subsystem
 - configuring, 2-53
 - removing, 2-53
- Central subsystem, adding, 2-53
- Checks
 - autocall connection, 2-52
 - network connections, 2-52
 - server operation, 2-15
 - server status, 2-18
- Components
 - 6080, 1-27
 - 6320, 1-29
 - 6160, 1-28
- Connecting, external devices, 2-51
- Connections
 - Enterprise LAN, 2-35, 2-50
 - network, 2-52
 - PAP unit, 2-35
- Console, 1-34
 - data cables, C-3, C-21
 - opening / closing, 2-3
 - setting up, 2-4
 - toggling, 2-20
- Console drawer, closing, 2-5
- CSS Module, PMB, 2-7

- CSS module, 1-31
 - availability status, 2-18
 - shipping brackets, 1-22
- Customer information, configuring, 2-31

D

- Data cables
 - integrated console, C-3
 - 16-port KVM Switch, C-23
 - 8-port KVM Switch, C-4
 - console, C-21
 - Ethernet hub, C-17, C-36
 - FDA 1300 FC disk rack, C-12
 - FDA 1300 FC extension disk rack, C-13, C-32
 - FDA 2300 FC disk rack, C-14
 - FDA 2300 FC extension disk rack, C-15, C-34
 - IOR, C-6
 - IOR (KVM AV1000R), C-25
 - PAP unit, C-8, C-26
 - PMB, C-16, C-35
 - SJ-0812 disk rack, C-28
 - SJ-0812 SCSI disk rack, C-10
 - SR-0812 disk rack, C-29
 - SR-0812 SCSI disk rack, C-11
 - Storeway FDA 1300 disk rack, C-31
 - Storeway FDA 2300 disk rack, C-33
- Delivery
 - server, 1-7
 - system, 1-2
- Details pane, PAM, 2-19
- Devices, external, 2-51
- DIMMs, 1-31
- Disk Rack, troubleshooting, 3-8
- Disk racks, setup, 2-48
- Diskette drive, accessing, 2-6
- Disks, 1-33, 1-36, 1-38
- Domain
 - power down, 2-21
 - power up, 2-21
- DVD/CD-ROM drive, 1-31

E

- Electrical safety, xi
- Electromagnetic compatibility, xiii
- Electrostatic discharges, xiii
- Enterprise LAN
 - connecting PAP unit, 2-35
 - connection, 2-50
- Environmental standards, xiii
- Ethernet hub, 1-41
 - data cables, C-17, C-36
- Ethernet ports, 1-31, 1-33

F

- FC storage subsystems, password, changing, 2-34
- FDA 1300 disk rack, 1-38
- FDA 1300 FC Disk rack, data cables, C-12

FDA 1300 FC extension Disk rack, data cables, C-13, C-32
FDA 2300 FC Disk rack, data cables, C-14
FDA 2300 FC disk rack, 1-39
FDA 2300 FC extension Disk rack, data cables, C-15, C-34
FDD, 1-33
Features, system, A-1
Front door
 opening, 2-2
 removing, 1-12

G

Getting to know, server, 1-27

I

Illegal characters, B-4
Inspecting
 cabinet packing, 1-9
 server, 1-11
Inspection
 cabling, 1-23
 components, 1-23
Installation
 flowchart, xvi
 intervention report, 2-52
Intervention report, installation, 2-52
IOB, 1-31, 1-32
IOR, 1-31
 data cables, C-6
IOR (16-port KVM Switch), data cables, C-25

K

Keyboard, 1-34
 troubleshooting, 3-4
Keys, registry, B-5
KVM switch, 1-35
 troubleshooting, 3-6

L

Labels
 shockwatch, 1-9
 tiltwatch, 1-9
Laser safety, xii
Limits
 audio-noise, xv
 pollution, xv
LS240 drive, 1-31

M

Memory boards, 1-31
Modem, 1-41
Monitor, 1-34
 troubleshooting, 3-5
Mother boards, 1-31
Mouse, 1-34
 troubleshooting, 3-3
MPI, 1-31, 1-32

N

Network, testing, 2-52

Notices
 electrical safety, xi
 laser safety, xii
 safety, xi

O

Operating System
 completing setup, 2-38
 troubleshooting, 3-10
Operating system, setup
 completing, 2-39, 2-43
 Microsoft Windows, 2-40, 2-44

P

Packing items, storing, 1-18
PAM
 details pane, 2-19
 status pane, 2-18
 toolbar, 2-19
 user interface, 2-17
 writing rules, B-4
PAM software
 back up / restore, 2-63
 launching, 2-15
 troubleshooting, 3-11
PAM tree pane, 2-19
PAP, troubleshooting, 3-7
PAP unit, 1-33
 CD-ROM drive, 1-33
 configuration, 2-29
 data cables, C-8, C-26
 diskette drive, 2-6
 disks, 1-33
 DVD-CD Rom drive, 2-6
 Ethernet ports, 1-33
 FDD, 1-33
 serial ports, 1-33
PAP users, setting up, 2-61
Password, changing, FC storage subsystems, 2-34
PDU, 1-42
PHPB, 1-31
PMB, 1-31, 1-32
 code wheels, 2-7
 data cables, C-16, C-35
Power cables, 1-33, 1-34, 1-35, 1-36, 1-37, 1-38, 1-39, 1-40, 1-42
 PDU, 2-13
 sockets, 2-11
Power down, server domain, 2-21
Power supply, connecting, 2-14
Power supply cables, server, C-19, C-38
Power-up
 server, 2-14
 server domain, 2-21
 system domains, 2-25
Processors, 1-31
Program, post-install, 2-29
PUIID, PAM software, 2-15

Q

QBB fan boxes, 1-31, 1-32

QBBs, 1-31, 1-32

R

RAID controller, 1-36

Rail / Ramp assembly, installing, 1-15

Rear door, removing, 1-13

Remote access

iSM, 2-37

PAM, 2-36

Restarting, server, 2-24, 2-28

Restoring, PAM software, 2-63

S

Safety

notices, xi

recommendations, 2-14

specifications, xv

SCSI HBA, 1-31

SCSI JBOD rack, 1-36, 1-37

SCSI rack, 1-36

Serial ports, 1-31, 1-33

Server

configuring, 2-53

domain, 2-21

getting to know, 1-27

inspecting, 1-11

power supply cables, C-19, C-38

restarting, 2-24, 2-28

shutdown, 2-24, 2-28

unloading, 1-12

unpacking, 1-8

Server cabinet

installing, 1-19

securing, 1-19

Server components

accessing, 2-2

CD-ROM drive, 1-33

console, 1-34

CSS module, 1-31

DIMMs, 1-31

disks, 1-36, 1-38

Ethernet hub, 1-41

Ethernet ports, 1-31, 1-33

FDA 1300 FC, 1-38

FDA 2300 FC, 1-39

FDD, 1-33

IOB, 1-31, 1-32

IOR, 1-31

keyboard, 1-34

KVM switch, 1-35

LS240 drive, 1-31

memory boards, 1-31

Midplane, 1-31, 1-32

modem, 1-41

monitor, 1-34

mother boards, 1-31

mouse, 1-34

PAP unit, 1-33

PAP unit disks, 1-33

PDU, 1-42

PDU power cable, 2-13

PHPB, 1-31

PMB, 1-31, 2-7

power cables, 1-33, 1-34, 1-35, 1-36, 1-37,
1-38, 1-39, 1-40, 1-42, 2-11

processors, 1-31

QBB fan boxes, 1-31, 1-32

QBBs, 1-31, 1-32

RAID controller, 1-36

SCSI HBA, 1-31

SCSI JBOD rack, 1-36, 1-37

SCSI rack, 1-36

serial ports, 1-31, 1-33

SPS fan boxes, 1-31, 1-32

USB ports, 1-31

VGA port, 1-31

Server operation, checking, 2-15

Server power, troubleshooting, 3-2

Server status, checking, 2-18

Setting up

console, 2-4

PAP users, 2-61

Setup

Microsoft Windows, 2-40, 2-44

operating system, completing, 2-39, 2-43

preparing disk racks, 2-48

Shipping brackets

cabinet, 1-16

CSS module, 1-22

Shocks and vibrations, xiv

Shockwatch, labels, 1-9

Shutdown, server, 2-24, 2-28

Side covers

refitting, 1-26

removing, 1-14

SJ-0812 disk rack, data cables, C-28

SJ-0812 SCSI disk rack, data cables, C-10

Specifications

atmospheric, xiii

electrical, xiii

NovaScale 6080/6160 Servers, A-1

NovaScale 6320 Servers, A-3

safety, xv

system, A-1

SPS fan boxes, 1-31, 1-32

SR-0812 disk rack, data cables, C-29

SR-0812 SCSI disk rack, data cables, C-11

Status, CSS module, 2-18

Status pane, PAM, 2-18

Storeway FDA 1300 Disk rack, data cables, C-31

Storeway FDA 2300 Disk rack, data cables, C-33

Storing, packing items, 1-18

String lengths, B-4

System

dimensions, A-1

domains, 2-25

weight, A-1

System components, DVD/CD-ROM drive, 1-31

T

Tiltwatch, labels, 1-9

Toolbar, PAM, 2-19

Troubleshooting, 3-1

CD drive, 3-9

disk rack, 3-8

keyboard, 3-4

- KVM switch, 3-6
- monitor, 3-5
- mouse, 3-3
- Operating System, 3-10
- PAM software, 3-11
- PAP, 3-7
- server power, 3-2

U

- Unloading
 - rail / ramp assembly, 1-15
 - server, 1-12
- Unpacking, server, 1-8

- USB modem, connecting, 2-51
- USB ports, 1-31
- User group, PAP, 2-61
- User interface, PAM, 2-17

V

- VGA port, 1-31

W

- Writing rules
 - illegal characters, B-4
 - string lengths, B-4

Vos remarques sur ce document / Technical publication remark form

Titre / Title : Bull NovaScale 6080, 6160 & 6320 Installation Guide

N° Référence / Reference N° : 86 A1 25EM 01

Daté / Dated : October 2004

ERREURS DETECTEES / ERRORS IN PUBLICATION

AMELIORATIONS SUGGEREES / SUGGESTIONS FOR IMPROVEMENT TO PUBLICATION

Vos remarques et suggestions seront examinées attentivement.

Si vous désirez une réponse écrite, veuillez indiquer ci-après votre adresse postale complète.

Your comments will be promptly investigated by qualified technical personnel and action will be taken as required.

If you require a written reply, please furnish your complete mailing address below.

NOM / NAME : _____ Date : _____

SOCIETE / COMPANY : _____

ADRESSE / ADDRESS : _____

Remettez cet imprimé à un responsable BULL ou envoyez-le directement à :

Please give this technical publication remark form to your BULL representative or mail to:

**BULL CEDOC
357 AVENUE PATTON
B.P.20845
49008 ANGERS CEDEX 01
FRANCE**

Technical Publications Ordering Form

Bon de Commande de Documents Techniques

To order additional publications, please fill up a copy of this form and send it via mail to:

Pour commander des documents techniques, remplissez une copie de ce formulaire et envoyez-la à :

BULL CEDOC
ATTN / Mr. L. CHERUBIN
357 AVENUE PATTON
B.P.20845
49008 ANGERS CEDEX 01
FRANCE

Phone / Téléphone : +33 (0) 2 41 73 63 96
FAX / Télécopie : +33 (0) 2 41 73 60 19
E-Mail / Courrier Electronique : srv.Cedoc@franp.bull.fr

Or visit our web sites at: / Ou visitez nos sites web à:

<http://www.logistics.bull.net/cedoc>

<http://www-frec.bull.com> <http://www.bull.com>

CEDOC Reference # N° Référence CEDOC	Qty Qté	CEDOC Reference # N° Référence CEDOC	Qty Qté	CEDOC Reference # N° Référence CEDOC	Qty Qté
__ __ __ __ __ [__]		__ __ __ __ __ [__]		__ __ __ __ __ [__]	
__ __ __ __ __ [__]		__ __ __ __ __ [__]		__ __ __ __ __ [__]	
__ __ __ __ __ [__]		__ __ __ __ __ [__]		__ __ __ __ __ [__]	
__ __ __ __ __ [__]		__ __ __ __ __ [__]		__ __ __ __ __ [__]	
__ __ __ __ __ [__]		__ __ __ __ __ [__]		__ __ __ __ __ [__]	
__ __ __ __ __ [__]		__ __ __ __ __ [__]		__ __ __ __ __ [__]	
__ __ __ __ __ [__]		__ __ __ __ __ [__]		__ __ __ __ __ [__]	

[__] : **no revision number means latest revision** / pas de numéro de révision signifie révision la plus récente

NOM / NAME : _____ Date : _____

SOCIETE / COMPANY : _____

ADRESSE / ADDRESS : _____

PHONE / TELEPHONE : _____ FAX : _____

E-MAIL : _____

For Bull Subsidiaries / Pour les Filiales Bull :

Identification: _____

For Bull Affiliated Customers / Pour les Clients Affiliés Bull :

Customer Code / Code Client : _____

For Bull Internal Customers / Pour les Clients Internes Bull :

Budgetary Section / Section Budgétaire : _____

For Others / Pour les Autres :

Please ask your Bull representative. / Merci de demander à votre contact Bull.

BULL CEDOC
357 AVENUE PATTON
B.P.20845
49008 ANGERS CEDEX 01
FRANCE

ORDER REFERENCE
86 A1 25EM 01

Utiliser les marques de découpe pour obtenir les étiquettes.
Use the cut marks to get the labels.



NovaScale
6080, 6160 &
6320
Installation Guide

86 A1 25EM 01



NovaScale
6080, 6160 &
6320
Installation Guide

86 A1 25EM 01



NovaScale
6080, 6160 &
6320
Installation Guide

86 A1 25EM 01



