

Bull NovaScale 5xx0 & 6xx0

User's Guide

Bull



Bull NovaScale 5xx0 & 6xx0

User's Guide

Hardware

December 2004

**BULL CEDOC
357 AVENUE PATTON
B.P.20845
49008 ANGERS CEDEX 01
FRANCE**

ORDER REFERENCE
86 A1 94EM 00

The following copyright notice protects this book under the Copyright laws of the United States of America and other countries which prohibit such actions as, but not limited to, copying, distributing, modifying, and making derivative works.

Copyright © Bull S.A. 2003, 2004

Printed in France

Suggestions and criticisms concerning the form, content, and presentation of this book are invited. A form is provided at the end of this book for this purpose.

To order additional copies of this book or other Bull Technical Publications, you are invited to use the Ordering Form also provided at the end of this book.

Trademarks and Acknowledgements

We acknowledge the right of proprietors of trademarks mentioned in this book.

Intel and Itanium are registered trademarks of Intel Corporation.

Windows and Microsoft software are registered trademarks of Microsoft Corporation.

UNIX is a registered trademark in the United States of America and other countries licensed exclusively through the Open Group.

Linux is a registered trademark of Linus Torvalds.

Preface

Table of Contents

Preface	iii
Intended Readers	xvii
Highlighting	xvii
Related Publications	xviii
Regulatory Specifications and Disclaimers	xix
Definition of Safety Notices	xxi
Electrical Safety	xxi
Laser Safety Information	xxii
Data Integrity and Verification	xxii
PAM Writing Rules	xxiii
AZERTY/QWERTY Keyboard Lookup Table	xxv
Administrator's Memorandum	xxvi
Operator's Memorandum	xxviii
Chapter 1. Introducing the Server	1-1
Bull NovaScale Server Overview	1-2
Dynamic Partitioning	1-2
Extended Configurations	1-2
Cluster Configurations	1-2
Server Features	1-3
Server Hardware	1-4
Central SubSystem Module (CSS Module)	1-4
Platform Administration Processor (PAP) Unit	1-4
KVM Switch	1-5
Slideaway Console / Console Drawer	1-5
Disk Subsystem	1-5
Additional Peripherals	1-5
Server Firmware and Software	1-5
Conformance to Standards	1-6
Getting to Know the Server	1-7
NovaScale 5080 Server	1-7
NovaScale 5160 Server	1-8
NovaScale 6080 Server	1-9
NovaScale 6160 Server	1-10
NovaScale 6320 Server	1-11
Server Components	1-13
Central Subsystem (CSS) Module	1-13
Integrated Platform Administration Processor (PAP) Unit	1-15
Integrated Console	1-16
Keyboard / Video / Mouse (KVM) Switch	1-17
SR-0812 SCSI RAID / SJ-0812 SCSI JBODDisk Racks	1-18
SJ-0812 SCSI JBOD Extension Disk Rack	1-18
Ethernet Hub	1-19
USB Modem	1-19
NPort Server	1-19
Power Distribution Unit (PDU)	1-20

Accessing Server Components	1-21
Opening the Front Door	1-21
Closing the Front Door	1-21
Opening / Closing the Slideaway Console	1-22
Setting up the Console Drawer	1-23
Closing the Console Drawer	1-24
Accessing the PAP Unit CD–Rom and Diskette Drives	1-24
Bull NovaScale Server Resources	1-25
System Resource and Documentation CD–Roms	1-25
PAM Software Package	1-25
PAP Unit Mirroring and Failover Policy	1-25
EFI Utilities	1-26
Chapter 2. Getting Started	2-1
Connecting to the PAM Web Site	2-2
Connecting to the PAM Web Site from the Local / Integrated Console	2-2
Connecting to the PAM Web Site from a Remote Computer/Workstation	2-3
Enabling Remote Access to the PAM Web Site with Internet Explorer	2-3
Enabling Remote Access to the PAM Web Site with Mozilla	2-3
Simultaneous Connection to the PAM Web Site	2-4
PAM User Interface	2-5
Checking Server Status via PAM	2-6
PAM Tree Pane	2-7
PAM Control Pane	2-7
Setting up Users	2-7
Toggling the Local / Integrated Console Display	2-8
Powering Up / Down Server Domains	2-9
Powering Up the NovaScale 5xx0 Server Domain	2-9
Powering Down the NovaScale 5xx0 Server Domain	2-10
Powering Up NovaScale 6080/6160 Server Domains	2-11
Powering Down NovaScale 6080/6160 Server Domains	2-14
Powering Up NovaScale 6320 Server Domains	2-15
Powering Down NovaScale 6320 Server Domains	2-18
Preparing Server Domains for Remote Access via the Enterprise LAN	2-19
Preparing Server Domains for Remote Access via the Web	2-21
Connecting to a Server Domain via the Enterprise LAN	2-22
Connecting to the Server via the Web	2-23
Chapter 3. Managing Domains	3-1
Introducing PAM Domain Management Tools	3-2
NovaScale 5xx0 Server Domain Manager Control Pane	3-3
NovaScale 6xx0 Server Domain Manager Control Pane	3-4
Managing Domain Schemes	3-6
Viewing a Domain Scheme	3-7
Loading a Domain Scheme	3-9
Adding a Domain Scheme to the Current Domain Scheme	3-11
Replacing the Current Domain Scheme	3-11
Saving the Current Domain Scheme Snapshot	3-12
Powering On a Domain	3-15
Powering Off a Domain	3-18
Manually Resetting a Domain	3-21
Forcing a Domain Power Off	3-24
Performing a Domain Memory Dump	3-27
Viewing Domain Functional Status	3-30
Viewing Domain Power Logs	3-31

Viewing Domain Powering Sequences	3-32
Viewing Domain BIOS Info	3-33
Viewing Domain Request Logs	3-34
Viewing Domain Configuration, Resources and Status	3-35
Viewing Domain Configuration	3-36
Viewing Domain Hardware Resources	3-38
Viewing Domain Details and Status	3-39
Modifying Domain Configuration	3-42
Adding Cells to a Domain	3-44
Removing Cells from a Domain	3-47
Changing the Domain EFI Boot LUN	3-51
Deleting a Domain	3-53
What To Do if an Incident Occurs	3-56
Chapter 4. Monitoring the Server	4-1
Introducing PAM Monitoring Tools	4-2
Viewing System / Component Status	4-3
PAM Status Pane	4-3
CSS Availability Status	4-4
System Functional Status	4-4
Event Message Status	4-4
PAM Tree Pane	4-5
Displaying Presence Status	4-5
Displaying Functional Status	4-7
Using PAM Utilities	4-9
Using the Hardware Search Engine	4-9
Viewing PAM Web Site User Information	4-10
Viewing PAM Version Information	4-11
Viewing Server Hardware Status	4-12
Viewing Detailed Hardware Information	4-14
General Tab	4-14
FRU Info Tab	4-15
Firmware Tab (Midplane & PMB only)	4-16
Thermal Zones (CSS module only)	4-16
Power Tab	4-17
CSS Module Power Tab	4-18
Temperature Tab	4-19
Fan Status (QBB Fanboxes, SPS Fanboxes and DPS units only)	4-20
Jumper Status (IOB only)	4-20
PCI Slots (IOB only)	4-21
Excluding / Including Hardware Elements	4-22
Viewing and Managing PAM Event Messages and History Files	4-26
Understanding Message Severity Levels	4-27
Consulting Event Messages, Hardware Faults and History/Archive Files	4-28
Viewing and Acknowledging PAM Web Event Messages	4-29
Sorting and Locating Messages	4-30
Viewing E-mailed Event Messages	4-30
Displaying the Hardware Faults List	4-30
Viewing, Archiving and Deleting History Files	4-31
Viewing History Files Online	4-31
Manually Archiving History Files	4-33
Viewing Archive Files Online	4-33
Manually Deleting a History Archive File	4-35
Downloading History / Archive Files for Offline Viewing	4-35
What to Do if an Incident Occurs	4-37

Investigating Incidents	4-37
Dealing with Incidents	4-40
Checking Environmental Conditions	4-40
Checking Hardware Availability	4-40
Checking Hardware Connections	4-41
Excluding a Hardware Element and Checking Exclusion Status	4-41
Checking Hardware Fault Status	4-41
Checking Hardware Power Status	4-41
Checking Hardware Temperature Status	4-41
Checking Histories and Events	4-41
Checking SNMP Settings	4-42
Checking Autocall Settings	4-42
Checking PAM Version	4-42
Checking MAESTRO Version	4-42
Checking Writing Rules	4-42
Powering OFF/ON a Domain	4-42
Rebooting the PAP Application	4-42
Modifying LUN Properties	4-42
Checking, Testing and Resetting the PMB	4-43
PMB LEDs and Code Wheels	4-44
Chapter 5. Tips and Features for Administrators	5-1
Section I – Setting up Server Users and Configuring Data Disks	5-2
Setting up Server Users	5-3
Configuring SCSI Data Disks	5-4
SJ–0812 SCSI JBOD Disk Rack	5-4
SJ–0812 SCSI JBOD / SR–0812 SCSI RAID Disk Rack	5-5
SR–0812 SCSI RAID Disk Rack	5-5
SR–1422 SCSI RAID Disk Rack	5-6
Creating a New Disk Array	5-6
Creating a New Array Partition	5-7
Configuring FC Data Disks	5-8
Section II – Using EFI Utilities	5-12
Using the EFI Boot Manager	5-13
Using the EFI Shell	5-15
Entering the EFI Shell	5-15
EFI Shell Command Syntax	5-15
Executing Batch Scripts	5-17
EFI Network Setup and Configuration	5-19
Manual EFI Network Configuration	5-19
File Transfer Protocol (FTP)	5-20
Section III – Customizing PAM Software	5-21
Setting up PAP Unit Users	5-22
Modifying Customer Information	5-24
Configuring Autocalls	5-25
Setting Thermal Units	5-27
Deploying a New PAM Release	5-28
Activating a PAM Version	5-29
Backing up and Restoring PAM Configuration Files	5-31
Section IV – Configuring Domains	5-33
Partitioning your Server	5-34

Assessing Configuration Requirements	5-36
Creating, Editing, Copying, Deleting, Renaming a Domain Scheme	5-37
Updating Test Schemes	5-42
Creating, Editing, Copying, Deleting a Domain Identity	5-43
Creating a Mono-Domain Scheme using all Server Resources	5-45
Creating a Mono-Domain Scheme using a Part of Server Resources	5-53
Creating a Multi-Domain Scheme using all Server Resources	5-61
Creating a Multi-Domain Scheme using a Part of Server Resources	5-69
Configuring and Managing Extended Systems	5-76
Clearing, Loading, Saving NVRAM Variables	5-77
Updating the LUN List	5-78
Limiting Access to Hardware Resources	5-79
Scheme, Domain Identity, and Resources Checklists	5-80
Section V – Creating Event Subscriptions and User Histories	5-84
Customizing the PAM Event Messaging System	5-85
Setting up Event Subscriptions	5-86
Event Subscription Flowcharts	5-87
Creating, Editing, Deleting an E-mail Server	5-88
Creating, Editing, Deleting an E-mail Account	5-90
Creating, Editing, Deleting a User History	5-92
Enabling / Disabling Event Channels	5-96
Creating, Editing, Deleting an Event Subscription	5-97
Standard Event Message Filtering Criteria	5-101
Advanced Event Message Filtering Criteria	5-104
Preselecting, Creating, Editing, Deleting an Event Filter	5-109
Appendix A. Specifications	A-1
NovaScale 5080/5160 Server Specifications	A-1
NovaScale 6080/6160 Server Specifications	A-3
NovaScale 6320 Server Specifications	A-5
Appendix B. Cabling Diagrams	B-1
Section I – NovaScale 5080/5160 Server Cabling Diagrams	B-2
Integrated Console	B-3
KVM Switch	B-4
IOR	B-6
PAP Unit	B-8
Disk Rack (SJ-0812 SCSI JBOD)	B-10
Disk Rack (SR-0812 SCSI RAID)	B-11
Extension Disk Rack (SR-0812 SCSI RAID – SJ-0812 SCSI JBOD)	B-11
Disk Rack (FDA 1x00 FC)	B-12
Extension Disk Rack (FDA 1x00 FC – FDA 1x00 FC)	B-13
PMB	B-14
Ethernet Hub	B-15
Modem	B-16
Power Cables	B-17
Section II – NovaScale 6080/6160 Server Cabling Diagrams	B-19
Integrated Console	B-20
KVM Switch	B-21
IOR	B-23
PAP Unit	B-25
Disk Rack (SJ-0812 SCSI JBOD)	B-27
Disk Rack (SR-0812 SCSI RAID)	B-28
Extension Disk Rack (SR-0812 SCSI RAID – SJ-0812 SCSI JBOD)	B-28

NPort Server	B-29
Disk Rack (FDA 1x00 FC)	B-30
Extension Disk Rack (FDA 1x00 FC – FDA 1x00 FC)	B-31
PMB	B-32
Ethernet Hub	B-33
Modem	B-34
Power	B-35
Section III – NovaScale 6320 Server Cabling Diagrams	B-36
Console	B-37
16–Port KVM Switch	B-39
IOR	B-41
PAP Unit	B-42
Disk Rack (SJ–0812 SCSI JBOD)	B-44
Disk Rack (SR–0812 SCSI RAID)	B-45
Extension Disk Rack (SR–0812 SCSI RAID – SJ–0812 SCSI JBOD)	B-46
NPort Server	B-47
Disk Rack (FDA 1x00 FC)	B-48
Extension Disk Rack (FDA 1x00 FC – FDA 1x00 FC)	B-49
Disk Rack (FDA 2x00 FC)	B-50
Extension Disk Rack (FDA 2x00 FC – FDA 1x00 FC)	B-51
PMB	B-52
Ethernet Hub	B-53
Modem	B-54
Power	B-55
Inter–Cabinet (PMB – Ethernet Hub)	B-57
Inter–Cabinet (IOR – KVM Switch)	B-58
Inter–Cabinet (IOB HBA RAID – SJ–0812 SCSI JBOD)	B-59
Inter–Cabinet (IOB HBA – SR–0812 SCSI RAID)	B-60
Inter–Cabinet (IOB HBA – FDA 1x00 FC)	B-61
Inter–Cabinet (IOB HBA – FDA 2x00 FC)	B-62
Appendix C. Error Messages and Recovery Information	C-1
BIOS POST Codes	C-1
BIOS Error Messages	C-2
SAL–A POST Codes	C-3
SAL–B POST Codes	C-9
SAL–F POST Codes	C-12
IA–32 POST Codes	C-14
Device Initialization Manager (DIM) Code Checkpoints	C-24
PCI Diagnostic POST Codes	C-25
EFI POST Code MAP	C-26
ACPI POST Codes	C-26
Recovery Port 80 POST Codes	C-27
Runtime POST Codes	C-29
PAM BIOS Interface Post Codes	C-30
Boot Error Messages	C-33
Storage Device Error Messages	C-33
System Configuration Error Messages	C-34
CMOS Error Messages	C-35
Miscellaneous Error Messages	C-35
PAM Help Messages	C-36
Glossary	G-1
Index	X-1

List of Figures

Figure 1.	AZERTY keyboard	xxv
Figure 2.	QWERTY keyboard	xxv
Figure 3.	Bull NovaScale Server cabinets	1-2
Figure 4.	NovaScale 5080 Server components (example)	1-7
Figure 5.	NovaScale 5160 Server components (example)	1-8
Figure 6.	NovaScale 6080 Server components (example)	1-9
Figure 7.	NovaScale 6160 Server components (example)	1-10
Figure 8.	NovaScale 6320 Server main cabinet components (example)	1-11
Figure 9.	NovaScale 6320 Server I/O cabinet components (examples)	1-12
Figure 10.	CSS module features (full CSS module example)	1-13
Figure 11.	CSS module features (NovaScale 6320 Server example)	1-14
Figure 12.	PAP unit	1-15
Figure 13.	Slideaway Console features	1-16
Figure 14.	Console drawer features	1-16
Figure 15.	KVM switch features	1-17
Figure 16.	KVM switch features	1-17
Figure 17.	SR-0812 SCSI RAID / SJ-0812 SCSI JBOD disk rack features	1-18
Figure 18.	SJ-0812 SCSI JBOD extension disk rack features	1-18
Figure 19.	Ethernet hub features	1-19
Figure 20.	USB modem features	1-19
Figure 21.	NPort Server features	1-19
Figure 22.	PDU features	1-20
Figure 23.	Opening the front door	1-21
Figure 24.	Slideaway console	1-22
Figure 25.	Lowering the console drawer flap	1-23
Figure 26.	Extending the mouse tray	1-23
Figure 27.	Positioning the monitor	1-23
Figure 28.	Console ready for use	1-24
Figure 29.	Closing the console drawer	1-24
Figure 30.	PAP Unit CD-Rom and Diskette Drives	1-24
Figure 31.	PAM software deployment	1-25
Figure 32.	PAM Web site session details	2-4
Figure 33.	Multiple session example	2-4
Figure 34.	PAM user interface	2-5
Figure 35.	Status pane	2-6
Figure 36.	CSS Module availability status bar (bi-module server)	2-6
Figure 37.	PAM Tree toolbar	2-7
Figure 38.	Domain Manager Control pane	2-9
Figure 39.	Domain state	2-9
Figure 40.	Domain schemes list dialog	2-13
Figure 41.	Domain Manager Control pane	2-13
Figure 42.	Domain state	2-14
Figure 43.	Domain schemes list dialog	2-17
Figure 44.	Domain Manager Control pane	2-17
Figure 45.	Domain state	2-18
Figure 46.	NovaScale 5xx0 Server PAM Domain Manager tools	3-3

Figure 47. Domain schemes list dialog	3-7
Figure 48. Scheme property dialog	3-8
Figure 49. Domain schemes list dialog	3-9
Figure 50. Domain Manager control pane	3-10
Figure 51. Save Snapshot dialog	3-12
Figure 52. Power logs dialog	3-31
Figure 53. Powering view dialog	3-32
Figure 54. BIOS Info dialog	3-33
Figure 55. Request Logs dialog	3-34
Figure 56. View Domain dialog	3-36
Figure 57. View Domain dialog	3-37
Figure 58. Domain Hardware Resources dialog	3-38
Figure 59. Domain Hardware Details dialog	3-39
Figure 60. Modify Domain – Add Cell dialog	3-44
Figure 61. Add Cells to Domain dialog (mono–module server)	3-45
Figure 62. Add Cells to Domain dialog (bi–module server)	3-45
Figure 63. Modify Domain – Add Cell confirmation dialog (mono–module server)	3-46
Figure 64. Modify Domain – Add Cell confirmation dialog (bi–module server)	3-46
Figure 65. Modify Domain – Remove Cell dialog (mono–module server)	3-48
Figure 66. Modify Domain – Remove Cell dialog (bi–module server)	3-48
Figure 67. Remove Cells from Domain dialog (mono–module server)	3-49
Figure 68. Remove Cells from Domain dialog (bi–module server)	3-49
Figure 69. Modify Domain – Remove Cell confirmation dialog (mono–module server)	3-50
Figure 70. Modify Domain – Remove Cell confirmation dialog (bi–module server)	3-50
Figure 71. Modify Domain – Configure LUN dialog	3-51
Figure 72. Select LUN dialog	3-51
Figure 73. Modify Domain – Configure LUN confirmation dialog	3-52
Figure 74. Delete domain dialog – mono–module server	3-53
Figure 75. Delete Domain dialog – bi–module server	3-54
Figure 76. Domain deleted information box	3-55
Figure 77. PAM Status pane	4-3
Figure 78. CSS Module availability status bar	4-4
Figure 79. PAM Tree hardware presence status display	4-5
Figure 80. PAM Tree functional status display	4-7
Figure 81. PAM Tree – automatically expanded functional status display	4-8
Figure 82. Hardware Search engine	4-9
Figure 83. Hardware Search result list (example)	4-10
Figure 84. PAM Web Site user information	4-10
Figure 85. PAM version information	4-11
Figure 86. PAM Hardware Monitor	4-12
Figure 87. NovaScale 6320 Server Hardware Monitor display	4-13
Figure 88. General Hardware Status page (example)	4-14
Figure 89. FRU data (example)	4-15
Figure 90. Firmware data (example)	4-16
Figure 91. CSS module thermal zone details	4-16
Figure 92. Converter power status details (example)	4-17
Figure 93. CSS module power status details	4-18
Figure 94. Temperature probe status details (example)	4-19
Figure 95. Fanbox details (example)	4-20

Figure 96. IOB jumpers tab	4-20
Figure 97. PCI slots tab	4-21
Figure 98. PCI slot details dialog (example)	4-21
Figure 99. Example Hardware Status page	4-22
Figure 100. Example Hardware Status page	4-23
Figure 101. Display Events page	4-28
Figure 102. Specimen message help file	4-29
Figure 103. History Manager Control pane – Histories tab	4-31
Figure 104. History properties	4-32
Figure 105. History Manager Control pane – Archived histories tab	4-33
Figure 106. Archive properties	4-34
Figure 107. PMB LED location	4-44
Figure 108. SJ–0812 SCSI JBOD disk configuration	5-4
Figure 109. SJ–0812 SCSI JBOD/SR–0812 SCSI RAID disk configuration	5-5
Figure 110. SR–0812 SCSI RAID disk configuration	5-5
Figure 111. SR–1422 SCSI RAID disk rack	5-6
Figure 112. FDA 1x00 FC / FDA 2x00 FC disk rack	5-8
Figure 113. iSM Client interface	5-10
Figure 114. Customer Information configuration page	5-24
Figure 115. Autocalls Channel Settings control pane	5-25
Figure 116. PAM configuration control pane	5-27
Figure 117. PAM Installation InstallShield Wizard	5-28
Figure 118. PAM Activation InstallShield Wizard	5-29
Figure 119. Domain scheme and identity panes	5-34
Figure 120. Schemes control pane	5-37
Figure 121. Scheme Creation and Central Subsystem Configuration dialogs	5-38
Figure 122. Scheme Management dialog	5-39
Figure 123. Edit Scheme dialog	5-41
Figure 124. Identities List page	5-43
Figure 125. Create New Identity dialog	5-43
Figure 126. Scheme creation dialog – example 1	5-46
Figure 127. Central Subsystem configuration dialog – example 1	5-47
Figure 128. Scheme Management dialog – example 1	5-48
Figure 129. Identities list dialog – example 1	5-49
Figure 130. Create new identity dialog – example 1	5-50
Figure 131. Scheme Management dialog – example 1	5-51
Figure 132. Lun list dialog – example 1	5-52
Figure 133. Scheme creation dialog – example 2	5-54
Figure 134. Central Subsystem configuration dialog – example 2	5-55
Figure 135. Remove domain confirmation dialog – example 2	5-56
Figure 136. Scheme Management dialog – example 2	5-57
Figure 137. Identities list dialog – example 2	5-58
Figure 138. Create new identity dialog – example 2	5-59
Figure 139. Scheme Management dialog – example 2	5-60
Figure 140. Scheme creation dialog – example 3	5-63
Figure 141. Central Subsystem configuration dialog – example 3	5-64
Figure 142. Scheme Management dialog – example 3	5-65
Figure 143. Identities list dialog – example 3	5-66
Figure 144. Create new identity dialog – example 3	5-67

Figure 145. Scheme management dialog – example 3	5-68
Figure 146. Scheme creation dialog – example 4	5-70
Figure 147. Central Subsystem configuration dialog – example 4	5-71
Figure 148. Scheme Management dialog – example 4	5-72
Figure 149. Remove domain confirmation dialog – example 4	5-72
Figure 150. Scheme Management dialog – example 4	5-73
Figure 151. Identities list dialog – example 4	5-74
Figure 152. Create new identity dialog – example 4	5-74
Figure 153. Scheme management dialog – example 4	5-75
Figure 154. Logical Units page	5-77
Figure 155. Hardware exclusion options	5-79
Figure 156. PAM event messaging system features	5-85
Figure 157. E–mail servers configuration page	5-88
Figure 158. E–mail accounts configuration page	5-90
Figure 159. Create a New User History dialog	5-93
Figure 160. Event Channels configuration page	5-96
Figure 161. New Event Subscription dialog box	5-97
Figure 162. Event message standard filtering criteria chart	5-99
Figure 163. Event message advanced filtering criteria chart	5-100
Figure 164. Filters configuration page	5-109
Figure 165. New Filter configuration page – standard event message filtering criteria table	5-110
Figure 166. New Filter configuration page – advanced event message filtering criteria table	5-111
Figure 167. Slideaway console data cabling diagram	B-3
Figure 168. Console drawer data cabling diagram	B-3
Figure 169. 8–port KVM switch data cabling diagram (example 1)	B-4
Figure 170. 8–port KVM switch data cabling diagram (example 2)	B-5
Figure 171. IOR data cabling diagram (example 1)	B-6
Figure 172. IOR data cabling diagram (example 2)	B-7
Figure 173. PAP unit data cabling diagram (example 1)	B-8
Figure 174. PAP unit data cabling diagram (example 2)	B-9
Figure 175. SJ–0812 SCSI JBOD disk rack data cabling diagram	B-10
Figure 176. SR–0812 SCSI RAID disk rack data cabling diagram	B-11
Figure 177. SJ–0812 SCSI JBOD extension disk rack data cabling diagram	B-11
Figure 178. FDA 1x00 FC disk rack data cabling diagram	B-12
Figure 179. FDA 1x00 FC – FDA 1x00 FC extension disk rack data cabling diagram	B-13
Figure 180. PMB data cabling diagram examples	B-14
Figure 181. Ethernet hub data cabling diagram	B-15
Figure 182. Modem data cabling diagram	B-16
Figure 183. Power cabling diagram	B-17
Figure 184. Slideaway console data cabling diagram	B-20
Figure 185. Console drawer data cabling diagram	B-20
Figure 186. 8–port KVM switch data cabling diagram (example 1)	B-21
Figure 187. 8–port KVM switch data cabling diagram (example 2)	B-22
Figure 188. IOR data cabling diagram (example 1)	B-23
Figure 189. IOR data cabling diagram (example 2)	B-24
Figure 190. PAP unit data cabling diagram (example 1)	B-25
Figure 191. PAP unit data cabling diagram (example 2)	B-26
Figure 192. SJ–0812 SCSI JBOD disk rack data cabling diagram	B-27
Figure 193. SR–0812 SCSI RAID disk rack data cabling diagram	B-28

Figure 194. SJ-0812 SCSI JBOD extension disk rack data cabling diagram	B-28
Figure 195. NPort Server data cabling diagram	B-29
Figure 196. FDA 1x00 FC disk rack data cabling diagram	B-30
Figure 197. FDA 1x00 FC – FDA 1x00 FC extension disk rack data cabling diagram	B-31
Figure 198. PMB data cabling diagram examples	B-32
Figure 199. Ethernet hub data cabling diagram	B-33
Figure 200. Modem data cabling diagram	B-34
Figure 201. Power cabling diagram	B-35
Figure 202. Slideaway console data cabling diagram	B-37
Figure 203. Integrated console data cabling diagram	B-38
Figure 204. 16–port KVM switch data cabling diagram (example 1)	B-39
Figure 205. 16–port KVM switch data cabling diagram (example 2)	B-40
Figure 206. IOR data cabling diagram (16–port KVM switch)	B-41
Figure 207. PAP unit (2U) data cabling diagram	B-42
Figure 208. PAP unit (1U) data cabling diagram	B-43
Figure 209. SJ-0812 SCSI JBOD disk rack data cabling diagram	B-44
Figure 210. SR-0812 SCSI RAID disk rack data cabling diagram	B-45
Figure 211. SJ-0812 SCSI JBOD extension disk rack data cabling diagram	B-46
Figure 212. NPort Server data cabling diagram	B-47
Figure 213. FDA 1x00 FC disk rack data cabling diagram	B-48
Figure 214. FDA 1x00 FC – FDA 1x00 FC extension disk rack data cabling diagram	B-49
Figure 215. FDA 2x00 FC disk rack data cabling diagram	B-50
Figure 216. FDA 2x00 FC – FDA 1x00 FC extension data cabling diagram	B-51
Figure 217. PMB – Hub data cabling diagram	B-52
Figure 218. Ethernet hub data cabling diagram	B-53
Figure 219. Modem data cabling diagrams	B-54
Figure 220. Main cabinet power cabling diagram	B-55
Figure 221. I/O cabinet power cabling diagram (standard)	B-55
Figure 222. Power cabling diagram	B-56
Figure 223. PMB – Ethernet Hub inter–cabinet cabling diagram	B-57
Figure 224. IOR – 16–port KVM switch inter–cabinet cabling diagram	B-58
Figure 225. IOB HBA RAID – SJ-0812 SCSI JBOD disk rack inter–cabinet cabling diagram	B-59
Figure 226. IOB HBA – SR-0812 SCSI RAID disk rack inter–cabinet cabling diagram	B-60
Figure 227. IOB HBA – FDA 1x00 FC disk rack inter–cabinet cabling diagram	B-61
Figure 228. FDA 2x00 FC disk rack inter–cabinet data cabling diagram	B-62

List of Tables

Table 1.	PAM illegal characters	xxiii
Table 2.	String length rules	xxiii
Table 3.	PAM Tree nodes	2-7
Table 4.	KVM port configuration	2-8
Table 5.	MyOperationsScheme organization – mono–module server	2-12
Table 6.	MyOperations Scheme organization – bi–module server	2-16
Table 7.	NovaScale 6xx0 Server PAM Domain Manager tools	3-5
Table 8.	MyOperations Scheme organization	3-13
Table 9.	Power–on states and steps	3-16
Table 10.	Power–on states	3-17
Table 11.	Power–off states and steps	3-19
Table 12.	Power–off states	3-20
Table 13.	Reset states and steps	3-22
Table 14.	Reset states	3-23
Table 15.	Domain states / force power–off steps	3-25
Table 16.	Force power–off error messages	3-25
Table 17.	Force power–off states	3-26
Table 18.	Dump states and steps	3-28
Table 19.	Dump states	3-29
Table 20.	Domain functional status indicators	3-30
Table 21.	Domain hardware details icons	3-40
Table 22.	Bull NovaScale 6000 Series server cell configuration	3-42
Table 23.	Domain power sequence error messages	3-56
Table 24.	CSS hardware functional status icons	4-4
Table 25.	Hardware presence status indicators	4-6
Table 26.	Hardware functional status indicators	4-7
Table 27.	Fault status indicators	4-15
Table 28.	Power tab status indicators	4-17
Table 29.	Temperature tab status indicators	4-19
Table 30.	Hardware exclusion guidelines	4-25
Table 31.	Message severity levels	4-27
Table 32.	Domain cells	4-37
Table 33.	CSS functional status / domain state	4-38
Table 34.	PMB code wheel settings	4-45
Table 35.	HyperTerminal parameters	5-6
Table 36.	SCSI data disk population order	5-7
Table 37.	FDA 1x00 FC / FDA 2x00 FC disk configuration	5-9
Table 38.	Boot Option Maintenance Menu	5-14
Table 39.	Wildcard character expansion	5-16
Table 40.	Output redirection syntax	5-16
Table 41.	List of EFI Shell Commands	5-18
Table 42.	User access to PAM features	5-23
Table 43.	Domain configuration assessment criteria	5-36
Table 44.	Scheme configuration criteria – example 1 – mono–module server	5-45
Table 45.	Scheme configuration criteria – example 1 – bi–module server	5-45
Table 46.	Scheme configuration criteria – example 2 – mono–module server	5-53

Table 47.	Scheme configuration criteria – example 2 – bi–module server	5-53
Table 48.	Scheme configuration criteria – example 3 – mono–module server	5-61
Table 49.	Scheme configuration criteria – example 3 – bi–module server	5-62
Table 50.	Scheme configuration criteria – example 4 – bi–module server	5-69
Table 51.	Scheme configuration checklist	5-80
Table 52.	Domain Identity configuration checklist	5-81
Table 53.	Resources checklist – part 1	5-82
Table 54.	Resources checklist – part 2	5-83
Table 55.	Event channels	5-86
Table 56.	System history contents	5-92
Table 57.	History automatic archiving policies	5-94
Table 58.	Event channel selection guidelines	5-96
Table 59.	Standard event message filtering criteria	5-103
Table 60.	Advanced event message filtering criteria	5-108
Table 61.	NovaScale 5080/5160 Server specifications	A-2
Table 62.	NovaScale 6080/6160 Server specifications	A-4
Table 63.	NovaScale 6320 Server specifications	A-6
Table 64.	BIOS POST code organization	C-1
Table 65.	BIOS error message organization	C-2
Table 66.	SAL–A POST codes (before release B600)	C-3
Table 67.	SAL–A POST codes (for releases B600 and later)	C-6
Table 68.	SAL–A hang POST codes (before release B600)	C-7
Table 69.	SAL–A hang POST codes (for releases B600 and later)	C-8
Table 70.	SAL–B POST codes	C-10
Table 71.	SAL–B hang POST codes	C-11
Table 72.	SAL–F POST codes	C-12
Table 73.	SAL–F Hang POST Codes	C-13
Table 74.	IA–32 POST Codes	C-23
Table 75.	DIM Code checkpoints	C-24
Table 76.	PCI diagnostic POST code format	C-25
Table 77.	PCI diagnostic POST codes	C-25
Table 78.	EFI POST Codes	C-26
Table 79.	ACPI POST Codes	C-26
Table 80.	Recovery Port 80 POST codes (before release B600)	C-27
Table 81.	Recovery Port 80 POST codes (for releases B600 and later)	C-28
Table 82.	ACPI POST codes	C-29
Table 83.	PAM – BIOS Interface POST codes (for releases B740 and later)	C-32
Table 84.	Boot error messages	C-33
Table 85.	Storage error messages	C-33
Table 86.	System configuration error messages	C-34
Table 87.	CMOS error messages	C-35
Table 88.	Miscellaneous error messages	C-35
Table 89.	PAM message list	C-47

Intended Readers

This guide is intended for use by the Administrators and Operators of NovaScale 5xx0/6xx0 Servers.

Chapter 1. Introducing the Server
describes server hardware components and user environment.

Chapter 2. Getting Started
explains how to connect to and use the server.

Chapter 3. Managing Domains
describes how to perform straightforward server domain management tasks.

Chapter 4. Monitoring the Server
explains how to supervise server operation.

Chapter 5. Tips and Features for Administrators
explains how, as Customer Administrator, you can configure the server to suit your environment.

Appendix A. Specifications

Appendix B. Server Cabling

Appendix C. Error Messages and Recovery Information

Highlighting

The following highlighting conventions are used in this guide:

Bold	Identifies predefined commands, subroutines, keywords, files, structures, buttons, labels, and icons.
<i>Italics</i>	Identifies referenced publications, chapters, sections, figures, and tables.
< >	Identifies parameters to be supplied by the user.

Abbreviations, acronyms and concepts are documented in the *Glossary*.

Related Publications

Site Preparation Guide, 86 A1 87EF

explains how to prepare a Data Processing Center for Bull NovaScale Servers, in compliance with the standards in force. This guide is intended for use by all personnel and trade representatives involved in the site preparation process.

Installation Guide, 86 A1 93EM

explains how to set up and start NovaScale 5xx0/6xx0 Servers for the first time. This guide is intended for use by qualified support personnel.

Maintenance and Service Guide, 86 A7 95EM

explains how to maintain, service, and upgrade NovaScale 5xx0/6xx0 Servers. This guide is intended for use by qualified support personnel.

Troubleshooting Guide, 86 A7 91EF

explains how to diagnose and solve any problems occurring during Bull NovaScale Server operation. This guide is intended for use by qualified support personnel.

Documentation Overview, 86 A2 27EM

describes the hardware, software and online documentation available for Bull NovaScale Servers, related Operating Systems, and licensed programs.

Bull 1300H/L & 1100H/L Rack Cabinets, 86 A1 91EM

explains how to install and fit out rack cabinets for Bull NovaScale Servers and peripheral devices.



Note:

According to server configuration and version, certain features and functions described in this guide may not be accessible. Please contact your Bull Sales Representative for sales information.

Regulatory Specifications and Disclaimers

Declaration of the Manufacturer or Importer

We hereby certify that this product is in compliance with European Union EMC Directive 89/336/EEC, using standards EN55022 (Class A) and EN55024 and Low Voltage Directive 73/23/EEC, using standard EN60950. The product has been marked with the CE Mark to illustrate its compliance.

Safety Compliance Statement

- UL 60950 (USA)
- IEC 60950 (International)
- CSA 60950 (Canada)

European Community (EC) Council Directives

This product is in conformity with the protection requirements of the following EC Council Directives:

Electromagnetic Compatibility

- 89/336/EEC

Low Voltage

- 73/23/EEC

EC Conformity

- 93/68/EEC

Telecommunications Terminal Equipment

- 199/5/EC

Neither the provider nor the manufacturer can accept responsibility for any failure to satisfy the protection requirements resulting from a non-recommended modification of the product.

Compliance with these directives requires:

- an EC declaration of conformity from the manufacturer
- an EC label on the product
- technical documentation

Federal Communications Commission (FCC) Statement



Note:

This equipment has been tested and found to comply with the limits for a Class A digital device, pursuant to Part 15 of the FCC Rules. These limits are designed to provide reasonable protection against harmful interference when the equipment is operated in a commercial environment. This equipment generates, uses, and can radiate radio frequency energy and, if not installed and used in accordance with the instruction manual, may cause harmful interference to radio communications. Operation of this equipment in a residential area is likely to cause harmful interference in which case the user will be required to correct the interference at his own expense.

Properly shielded and grounded cables and connectors must be used in order to meet FCC emission limits. Neither the provider nor the manufacturer are responsible for any radio or television interference caused by using other than recommended cables and connectors or by unauthorized changes or modifications to this equipment. Unauthorized changes or modifications could void the user's authority to operate the equipment.

Any changes or modifications not expressly approved by the grantee of this device could void the user's authority to operate the equipment. The customer is responsible for ensuring compliance of the modified product.

FCC Declaration of Conformity

This device complies with Part 15 of the FCC Rules. Operation is subject to the following two conditions: (1) this device may not cause harmful interference, and (2) this device must accept any interference received, including interference that may cause undesired operation.

Canadian Compliance Statement (Industry Canada)

This Class A digital apparatus meets all requirements of the Canadian Interference Causing Equipment Regulations.

Cet appareil numérique de la classe A est conforme à la norme NMB-003 du Canada.

This product is in conformity with the protection requirements of the following standards:

Electromagnetic Compatibility

- ICES-003
- NMB-003

Laser Compliance Notice

This product that uses laser technology complies with Class 1 laser requirements.

A CLASS 1 LASER PRODUCT label is located on the laser device.

<p>Class 1 Laser Product Luokan 1 Laserlaite Klasse 1 Laser Apparat Laser Klasse 1</p>
--

Definition of Safety Notices



DANGER

A *Danger* notice indicates the presence of a hazard that has the potential of causing death or serious personal injury.



CAUTION:

A *Caution* notice indicates the presence of a hazard that has the potential of causing moderate or minor personal injury.



Warning:

A *Warning* notice indicates an action that could cause damage to a program, device, system, or data.

Electrical Safety

The following safety instructions shall be observed when connecting or disconnecting devices to the system.



DANGER

The Customer is responsible for ensuring that the AC electricity supply is compliant with national and local recommendations, regulations, standards and codes of practice.

An incorrectly wired and grounded electrical outlet may place hazardous voltage on metal parts of the system or the devices that attach to the system and result in an electrical shock.

It is mandatory to remove power cables from electrical outlets before relocating the system.



CAUTION:

This unit has more than one power supply cable. Follow procedures for removal of power from the system when directed.

Laser Safety Information

The optical drive in this system unit is classified as a Class 1 level Laser product. The optical drive has a label that identifies its classification.

The optical drive in this system unit is certified in the U.S. to conform to the requirements of the Department of Health and Human Services 21 Code of Federal Regulations (DHHS 21 CFR) Subchapter J for Class 1 laser products. Elsewhere, the drive is certified to conform to the requirements of the International Electrotechnical Commission (IEC) 60825–1: 2001 and CENELEC EN 60825–1: 1994 for Class 1 laser products.



CAUTION:

Invisible laser radiation when open. Do not stare into beam or view directly with optical instruments.

Class 1 Laser products are not considered to be hazardous. The optical drive contains internally a Class 3B gallium–arsenide laser that is nominally 30 milliwatts at 830 nanometers. The design incorporates a combination of enclosures, electronics, and redundant interlocks such that there is no exposure to laser radiation above a Class 1 level during normal operation, user maintenance, or servicing conditions.

Data Integrity and Verification



Warning:

Bull NovaScale Servers are designed to reduce the risk of undetected data corruption or loss. However, if unplanned outages or system failures occur, users are strongly advised to check the accuracy of the operations performed and the data saved or transmitted by the system at the time of outage or failure.

PAM Writing Rules

Illegal Characters

The following table lists the illegal characters that must not be used in PAM identifiers.

Illegal Characters	
à, é, è, ù, ^, "	Accentuated letters
/	Slash
\	Backslash
"	Double quote
'	Simple quote
`	Inverted comma
&	Ampersand
+	Plus
*	Asterisk
%	Percent
=	Equal sign
<	Less-than sign
>	Greater-than sign
:	Colon
!	Exclamation mark
?	Question mark
;	Semi-colon
,	Comma
~	Tilde
	Pipe operator
	Space. Use – (dash) or _ (underscore)

Table 1. PAM illegal characters

String Lengths

The following table lists authorized string lengths.

String Type	Length
CellBlock / System Name	16
Scheme Name	32
History Name	64
Archive Name	75 (History Name: + 11 (_JJMAA_nnn))
LUN Name	32
Switch Name	32
Event Name	32
Description	256 (Scheme: unlimited)
Domain Identity Name	16

Table 2. String length rules

Registry Keys

PAM obtains file paths via 2 registry keys:

- **ReleaseRoot:**
Contains PAP application file paths (DLL, WEB pages, models,...).
Two versions of PAM software can be installed and used indifferently on the same machine: each new version is installed in a new directory.
- **SiteRoot:**
Contains site data file paths.
Site data remains valid when the PAM software version changes.

Registry keys are generally stored under:

HKEY_LOCAL_MACHINE\SOFTWARE\BULL\PAM

AZERTY/QWERTY Keyboard Lookup Table

~	1	2	3	4	5	6	7	8	9	0	°	+
z	&	é ~	” #	’ {	([-	è ‘	_ \	ç ^	à @)]	= }
A	Z	E	R	T	Y	U	I	O	P	^	£	* x
Q	S	D	F	G	H	J	K	L	M	%	ù	*
>	W	X	C	V	B	N	?	.	/	\$		
<							,	;	:	!		

Figure 1. AZERTY keyboard

~	!	@	#	\$	%	^	&	*	()	-	+
‘	1	2	3	4	5	6	7	8	9	0	-	=
Q	W	E	R	T	Y	U	I	O	P	{	}	
										[]	\
A	S	D	F	G	H	J	K	L	:	*		
									;	,		
	Z	X	C	V	B	N	M	<	>	?		
								,	.	/		

Figure 2. QWERTY keyboard

Administrator's Memorandum

Domains

- Manage Domain Schemes, on page 3-6
 - Power ON a Domain, on page 3-15
 - Power OFF a Domain, on page 3-18
 - Perform a Manual Domain Reset, on page 3-21
 - Perform a Domain Force Power OFF, on page 3-24
 - Perform a Domain Memory Dump, on page 3-27
 - View Domain Functional Status, on page 3-30
 - View Domain Power Logs, on page 3-31
 - View Domain Powering Sequences, on page 3-32
 - View Domain BIOS Info, on page 3-33
 - View Domain Request Logs, on page 3-34
 - View Domain Configuration, Resources and Status, on page 3-35
 - Modify Domain Configuration, on page 3-42*
 - Solve Incidents, on page 3-56
- * Reserved for partitioned servers and extended systems.

Monitoring

- Refresh the PAM Display, on page 4-2
- View CSS Availability Status and System Functional Status, on page 4-4
- View Event Message Status, on page 4-4
- Display Hardware Presence / Functional Status, on page 4-5
- View PAM Web Site User Information, on page 4-10
- View PAM Version Information, on page 4-11
- View Server Hardware Status, on page 4-12
- Use the Hardware Search Engine, on page 4-9
- Display Detailed Hardware Information, on page 4-14
- Exclude / Include Hardware Elements, on page 4-22
- View, Manage PAM Event Messages and History Files, on page 4-26
- Understand Message Severity Levels, on page 4-27
- Consult Event Messages, Hardware Faults List, History Files, on page 4-28
- View, Acknowledge WEB Event Messages, on page 4-29
- Sort and Locate Messages, on page 4-30
- View, Archive, Delete History / Archive files, on page 4-31
- Solve Incidents, on page 4-37

Configuration

- Set up Server Users, on page 5-3
- Configure SCSI Data Disks, on page 5-4
- Configure FC Data Disks, on page 5-8
- Use the EFI Boot Manager, on page 5-13
- Use the EFI Shell, on page 5-15
- Set Up and Configure the EFI Network, on page 5-19
- Set up PAP Unit Users, on page 5-22
- Modify Customer Information, on page 5-22
- Configure PAM Autocall Parameters, on page 5-25
- Customize PAM Settings, on page 5-27
- Deploy a New PAM Release, on page 5-28
- Activate a PAM Version, on page 5-29
- Back Up and Restore PAM Configuration Files, on page 5-31
- Configure Domains, on page 5-33*
- Assess Configuration Requirements, on page 5-36*
- Create, Edit, Copy, Delete, Rename a Domain Scheme, on page 5-37*
- Update Test Schemes, on page 5-42*
- Create, Edit, Copy, Delete a Domain Identity, on page 5-43*
- Configure Extended Systems, on page 5-76*
- Clear, Load, Save NVRAM Variables, on page 5-77*
- Update the LUN List, on page 5-78*
- Limit Access to Hardware Resources, on page 5-79*
- Prepare Scheme, Domain Identity and Resources Checklists, on page 5-80*
- Customize the PAM Event Messaging System, on page 5-85
- Set up Event Subscriptions, on page 5-86
- Event Subscription Flowcharts, on page 5-86
- Create, Edit, Delete an E-mail Server, on page 5-88
- Create, Edit, Delete an E-mail Account, on page 5-90
- Create, Edit, Delete a User History, on page 5-93
- Enable / Disable Event Channels, on page 5-96
- Create, Edit, Delete an Event Subscription, on page 5-97
- Understand Event Message Filtering Criteria, on page 5-99
- Preselect an Event Filter, on page 5-109
- Create, Edit, Delete an Event Filter, on page 5-110

* Reserved for partitioned servers and extended systems.

Operator's Memorandum

Domains

- Power ON a Domain, on page 3-15
- Power OFF a Domain, on page 3-18
- Perform a Domain Force Power OFF, on page 3-24
- Perform a Manual Domain Reset, on page 3-21
- Perform a Domain Memory Dump, on page 3-27
- View Domain Functional Status, on page 3-30
- View Power Logs, on page 3-31
- View Domain Powering Sequences, on page 3-32
- View BIOS Info, on page 3-33
- View Domain Request Logs, on page 3-34
- View Domain Configuration, Resources and Status, on page 3-35
- Solve Incidents, on page 3-56

Histories

- View, Manage PAM Event Messages, History Files, on page 4-26
- Understand Event Message and History Severity Levels, on page 4-27
- Consult Event Messages, Hardware Faults List, History Files, on page 4-28
- View, Archive, Delete History / Archive files, on page 4-31
- Sort and Locate messages, on page 4-30

Status

- Check System Functional Status, on page 4-4
- Check CSS Availability, on page 4-4
- View, Acknowledge WEB Event Messages, on page 4-29
- Sort, Locate WEB event messages, on page 4-30

Chapter 1. Introducing the Server

This chapter describes the main hardware components and user environment for NovaScale 5xx0/6xx0 Servers. It includes the following topics:

- Bull NovaScale Server Overview, on page 1-2
- Accessing Server Components, on page 1-21
- Bull NovaScale Server Resources, on page 1-25
- EFI Utilities, on page 1-26
- PAM Software Package, on page 1-25



Note:

Customer Administrators and Customer Operators are respectively advised to consult the *Administrator's Memorandum*, on page xxvi or the *Operator's Memorandum*, on page xxviii for a detailed summary of the everyday tasks they will perform.

For further information about user accounts and passwords, see *Setting up PAP Unit Users*, on page 5-22.

Bull NovaScale Server Overview

Bull NovaScale Servers for business and scientific applications are based upon the FAME architecture (Flexible Architecture for Multiple Environments), leveraging the latest generation of Intel® Itanium® 2 processors.

NovaScale 5xx0 Servers are designed to operate as single SMP systems and are delivered with one pre-configured domain englobing all the hardware and software resources managed by the Operating System.

NovaScale 6xx0 Servers are designed to operate as one, two, three or four hardware-independent SMP systems or domains, each running an Operating System instance and a specific set of applications.

According to version, servers are delivered rack-mounted and ready-to-use in high or low cabinets.



Figure 3. Bull NovaScale Server cabinets

Dynamic Partitioning

Bull NovaScale 6000 Series servers can be dynamically partitioned into physically independent ccNUMA (Cache Coherent Non Uniform Memory Access) SMP systems or domains, each running an Operating System instance and a specific set of applications.

Extended Configurations

Several Bull NovaScale Servers may be administered through a single instance of PAM software.

Cluster Configurations

Several Bull NovaScale Servers may be grouped to act like a single system, enabling high availability, load balancing and parallel processing.

Server Features

The main features of Bull NovaScale Servers are:

Intel® Itanium® Processor Family architecture:

- Modularity, predictable performance and growth

High availability:

- Component redundancy
- Capacity to isolate or replace a faulty components without service disruption
- Global and unified system visibility
- Round-the-clock operation

Scalability:

- Dynamic partitioning
- Power on demand : capacity to dynamically adapt resources to load requirement

Simultaneous support of multiple environments:

- Microsoft® Windows® Server
- Linux®

High performance computing capabilities:

- Business Intelligence:
 - . Datawarehousing
 - . Datamining
- Large enterprise applications:
 - . ERP
 - . CRM
 - . SCM ...
- Large database applications for Internet transactions.
- Large business sector applications:
 - . Online billing
 - . Online reservations
 - . Online banking ...

Built-in Platform Administration and Maintenance (PAM) software suite:

- Proactive administration
- Optimization of resources
- Automatic generation of corrective actions and calls to support centers
- Dynamic configuration

Bull NovaScale Master System Management (NSM) software suite:

- Windows, Linux, and Platform management
- Monitoring, Information, Control, and Event Handling
- Client / Server / Agent architecture
- WEB standard OpenSource solutions

Server Hardware



Note:

Abbreviations and acronyms are documented in the *Glossary*.

Main server hardware components are:

Central SubSystem Module (CSS Module)

The CSS Module houses core hardware components:

- 2 or 4 QBBs
- 1 or 2 IOBs
- 1 or 2 IORs
- 1 PMB
- 1 MPB
- 4 DPS units



Notes:

- The NovaScale 6xx0 Server CSS Module can be logically divided into two **Cells**, each with one or two QBBs and one IOB, to allow dynamic partitioning.
- The NovaScale 6320 Server is equipped with two inter-connected CSS modules.

Quad Brick Block (QBB)

The QBB is equipped with 1 to 4 Itanium 2 processors and 16 DDR DIMMs. The QBB communicates with the rest of the system the high-speed bidirectional link **Scalability Port Switches (SPS)** located on the Midplane.

IO Board (IOB)

The IOB provides 4 PCI-X bridges for the connection of up to 11 PCI-X boards, and a PCI Hot Plug Board (PHPB). The IOB communicates with the rest of the system through the high-speed bidirectional link **Scalability Port Switches (SPS)** located on the Midplane.

IO Riser (IOR)

The IOR is an IOB daughter board providing legacy IO connections: 2 USB ports, 1 LAN port, 2 serial ports, 1 video port, and 1 CD/DVD Rom drive.

Platform Maintenance Board (PMB)

The PMB concentrates logistics access and links the platform to the Platform Administration Processor (PAP Unit) running Platform Administration and Maintenance (PAM) software.

Midplane (MPB)

The MPB houses the high-speed directional link **Scalability Port Switch (SPS)**. The MPB is divided into two physical **Cells**, each capable of connecting 2 QBBs and 1 IOB, which communicate with the rest of the system through the SPS. The MPB also houses the system clock and connects all other system boards.

Distributed Power Supply (DPS) Unit

Each DPS Unit supplies 48V AC/DC power to the server. Each CSS module is equipped with 4 DPS units for full redundancy.

Platform Administration Processor (PAP) Unit

The PAP Unit hosts all server administration software, in particular Platform Administration and Maintenance (PAM) software.

KVM Switch

The KVM Switch allows the use of a single keyboard, monitor and mouse for the local server domains and the local PAM console.

Slideaway Console / Console Drawer

The Console contains the keyboard, monitor and touch pad / mouse used for local access to the server domains and to the PAP Unit.

Disk Subsystem

A SCSI RAID or FC disk subsystem is required for OS disk partitions.

Additional Peripherals

Additional peripherals such as disk subsystems, storage area networks, communication networks, archiving peripherals etc. can be connected to the server via PCI adapters located in the IOCs. Such peripherals may either be rack-mounted in the server cabinet (if free space is available) or in external cabinets.

Server Firmware and Software

Operating Systems (OS)

The server is certified for the following Operating Systems:

- Windows Server 2003, Enterprise Edition
- Windows Server 2003, Datacenter Edition
- Linux Red Hat Advanced Server
- Linux SUSE

BIOS

The BIOS controls the server startup process, dynamic resource allocation (Domain reconfiguration, hot-plugging), and error handling. The BIOS also includes:

- The **Extended Firmware Interface (EFI)**, which provides the OS with system services.
- The **EFI Shell**, an autonomous environment used to run Off-line Test & Diagnostic suites.

Platform Administration and Maintenance (PAM) suite

The PAM Web-based software suite is used to operate, monitor, and configure the server. PAM can be accessed locally or remotely through Microsoft Internet Explorer or Mozilla browsers, under the protection of appropriate access rights. PAM provides the administration functions needed to manage and maintain the server:

- Domain configuration and resource allocation
- Alert or maintenance requests to the Customer Service Center
- Error logging ...

Test & Diagnostics suites

The server is delivered with the following T & D suites:

- Online Test & Diagnostic suite
- Offline Test & Diagnostic suite
- Power-On Self-Test suite

NovaScale Master (NSM) Management suite

The NSM software suite allows you to monitor and manage NovaScale Windows and Linux systems.

Conformance to Standards

Intel

Bull NovaScale Servers conform to all Intel platform standards:

- ACPI (Advanced Configuration and Power Interface)
- IPMI (Intelligent Platform Management Interface)
- EFI (Extended Firmware Interface)
- SMBIOS (System Management BIOS)
- DIG64 (Developer Interface Guide for Intel Itanium Architecture)

Windows

Bull NovaScale Servers conform to the standards set out in the Windows Hardware Design Guide.

Getting to Know the Server

NovaScale 5080 Server



Note:

Server components and configuration may differ according to the version chosen.

The server is delivered rack-mounted and pre-cabled in a high cabinet, containing the following components:

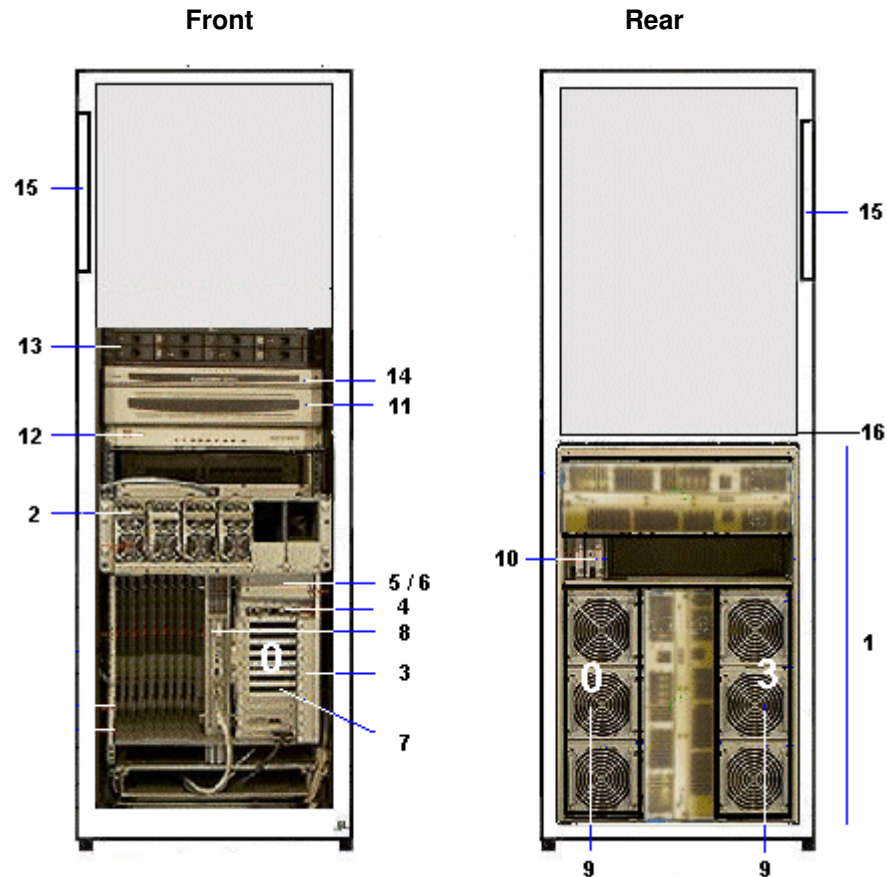

1	CSS module with midplane, redundant power supply and AC power cable		11	Console drawer with monitor, keyboard and mouse	
	2	DPS units	12	KVM switch	
	3	1 or 2 IOB (s) with:		13	1 or two SCSI or FC disk rack(s) with RAID controller(s) and disks
		4	IOR	14	PAP unit with CD-ROM drive, FDD and disk(s)
	5	LS240 disk drive (optional)	15	PDU with AC power cable	
	6	DVD / CD-ROM drive	16	Ethernet hub with power bar (FC disk rack)	
	7	PCI hot plug board (11 slots)	Dual IOB configuration: – IOB #0 = Master – IOB #1 = Slave		
	8	PMB	NovaScale 5080 Server configuration: – QBB #0 and QBB #3		
	9	1 or 2 QBB subsets with fan boxes			
	10	SPS fan boxes			

Figure 4. NovaScale 5080 Server components (example)



Note:

Abbreviations and acronyms are documented in the *Glossary*.

NovaScale 5160 Server



Note:

Server components and configuration may differ according to the version chosen.

The server is delivered rack-mounted and pre-cabled in a high cabinet, containing the following components:

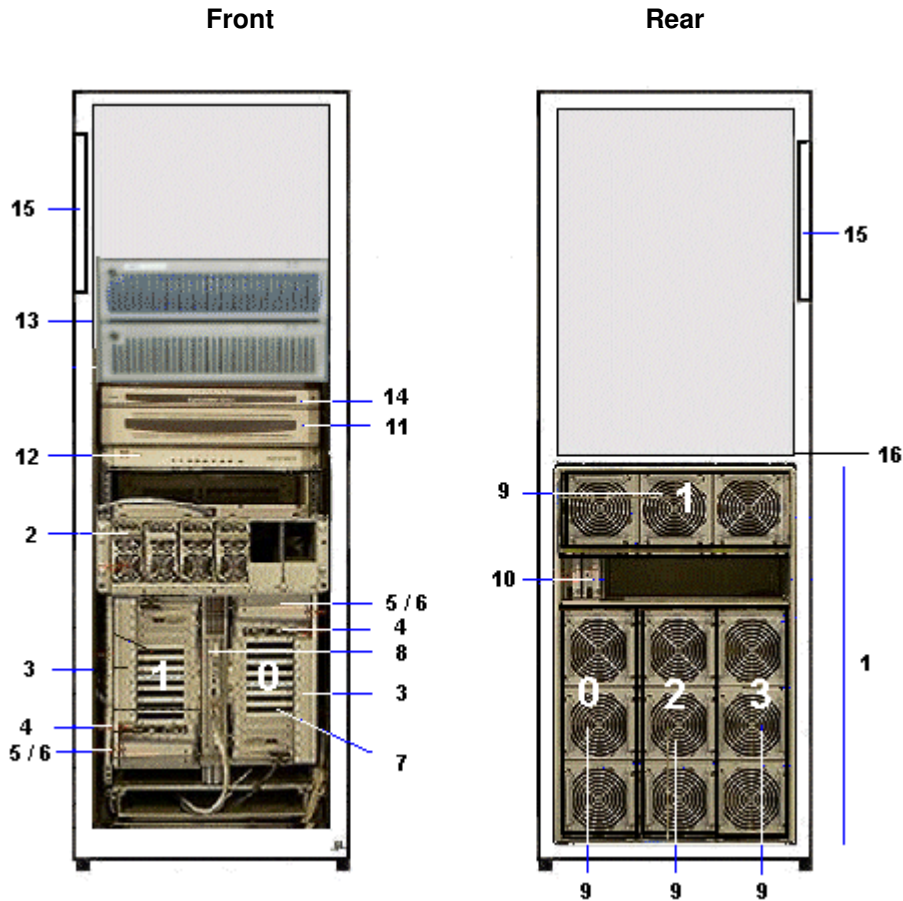

1	CSS module with midplane, redundant power supply and AC power cable		11	Console drawer with monitor, keyboard and mouse	
	2	DPS units	12	KVM switch	
	3	1 or 2 IOB (s) with:		13	1 or two SCSI or FC disk rack(s) with RAID controller(s) and disks
		4	IOR	14	PAP unit with CD-ROM drive, FDD and disk(s)
		5	LS240 disk drive (optional)	15	PDU with AC power cable
		6	DVD / CD-ROM drive	16	Ethernet hub with power bar (FC disk rack)
		7	PCI hot plug board (11 slots)	Dual IOB configuration: – IOB #0 = Master – IOB #1 = Slave	
	8	PMB	NovaScale 5160 Server configuration: – QBB #0, QBB #1, QBB #2, and QBB #3		
	9	1 up to 4 QBB subsets with fan boxes			
	10	SPS fan boxes			

Figure 5. NovaScale 5160 Server components (example)



Note:

Abbreviations and acronyms are documented in the *Glossary*.

NovaScale 6080 Server



Note:

Server components and configuration may differ according to the version chosen.

The server is delivered rack-mounted and pre-cabled in a high cabinet, containing the following components:

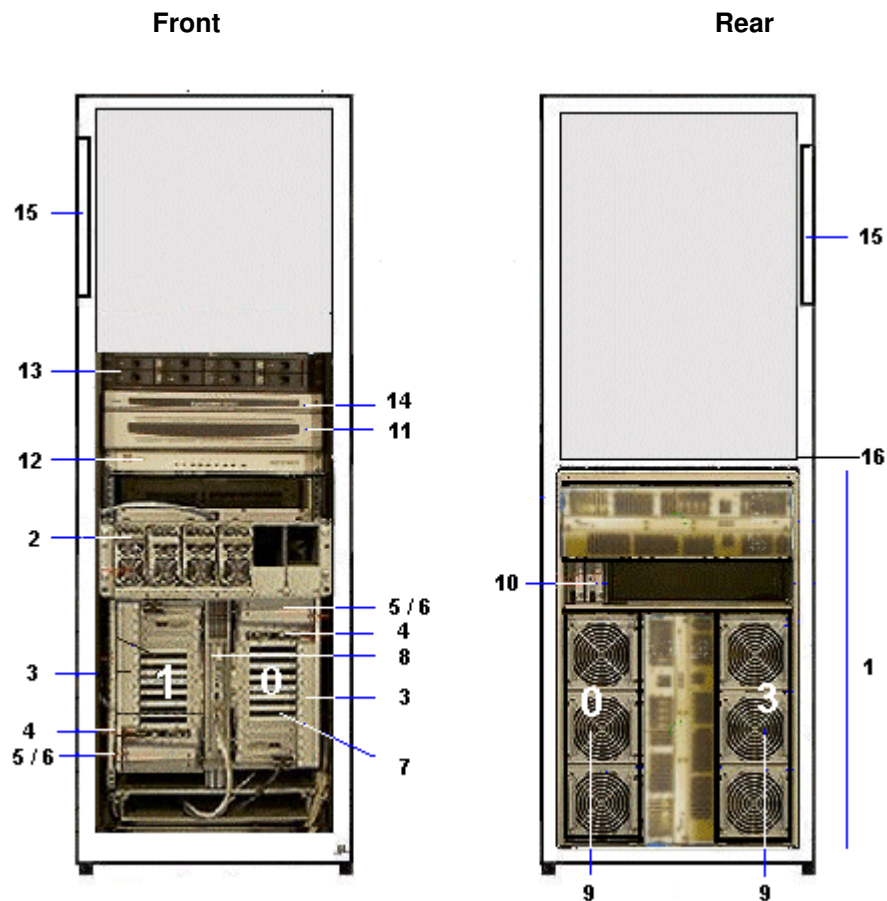

1	CSS module with midplane, redundant power supply and AC power cable		11	Console drawer with monitor, keyboard and mouse	
	2	DPS units	12	KVM switch	
	3	2 IOB (s) with:		13	1 or two SCSI or FC disk rack(s) with RAID controller(s) and disks
		4	IOR	14	PAP unit with CD-ROM drive, FDD and disk(s)
	5	2 USB ports	15	PDU with AC power cable	
	6	DVD / CD-ROM drive	16	Hub with power bar	
	7	PCI hot plug board (11 slots)	NovaScale 6080 configuration: – QBB #0 and QBB #3		
	8	PMB			
	9	2 QBBs with fan boxes			
	10	SPS fan boxes			

Figure 6. NovaScale 6080 Server components (example)



Note:

Abbreviations and acronyms are documented in the *Glossary*.

NovaScale 6160 Server



Note:

Server components and configuration may differ according to the version chosen.

The server is delivered rack-mounted and pre-cabled in a high cabinet, containing the following components:

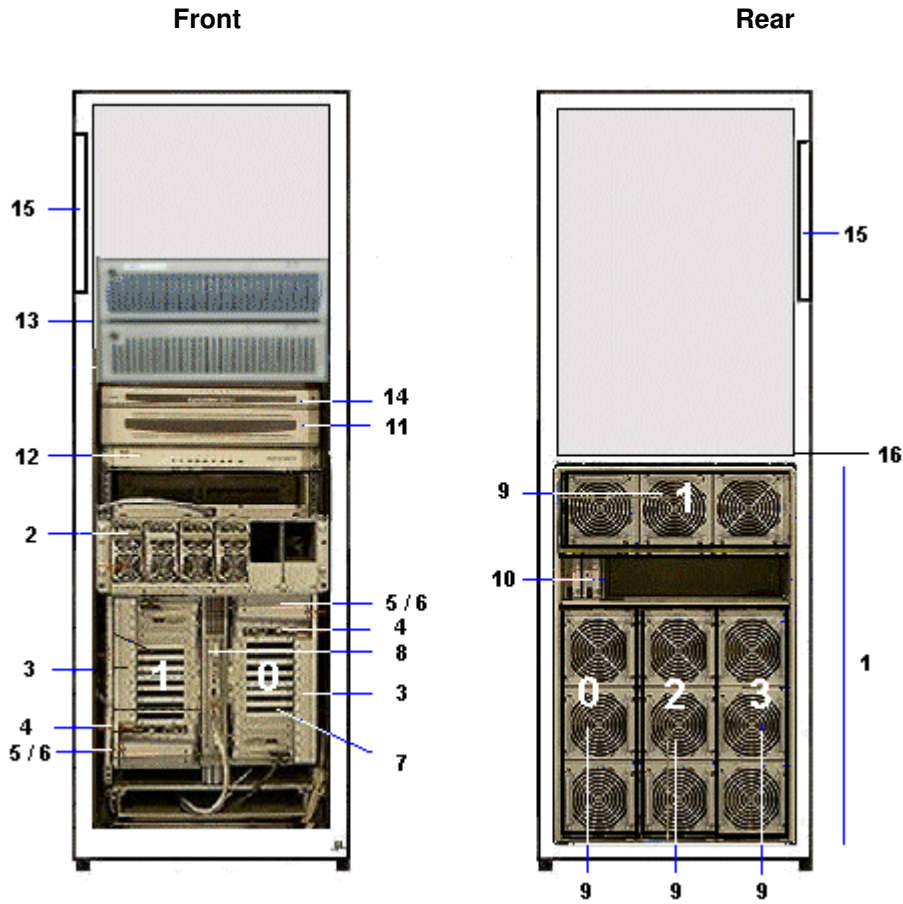

1	CSS module with midplane, redundant power supply and AC power cable	11	Console drawer with monitor, keyboard and mouse	
	2	DPS units	12	KVM switch
	3	2 IOB (s) with:	13	1 or two SCSI or FC disk rack(s) with RAID controller(s) and disks
		4		IOR
	5	2 USB ports	15	PDU with AC power cable
	6	DVD / CD-ROM drive	16	Hub with power bar
	7	PCI hot plug board (11 slots)	NovaScale 6160 configuration: – QBB #0, QBB #1, QBB #2, and QBB #3	
	8	PMB		
	9	4 QBBs with fan boxes		
	10	SPS fan boxes		

Figure 7. NovaScale 6160 Server components (example)



Note:

Abbreviations and acronyms are documented in the *Glossary*.

NovaScale 6320 Server



Note:

Server components and configuration may differ according to the version chosen.

The server is delivered rack-mounted and pre-cabled in a high cabinet, containing the following components:

Main Cabinet

The main cabinet contains the following components:

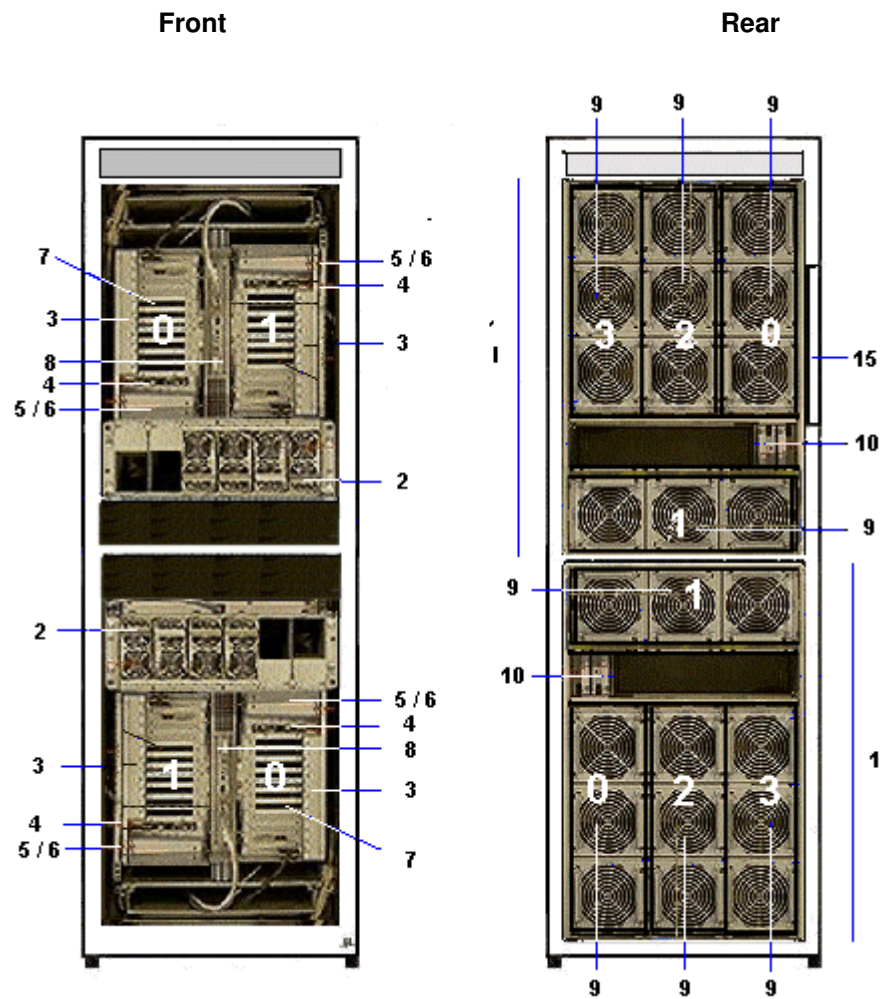

1	2	2 CSS modules, each with midplane, redundant power supply and AC power cable	8	PMB	
	2	DPS units	9	1 to 4 QBBs with fan boxes	
	3	1 or 2 IOB (s) with:		10	SPS fan boxes
		4	IOR	15	PDU with AC power cable
	5	2 USB ports	NovaScale 53206320 configuration: – QBB #0, QBB #1, QBB #2, and QBB #3 Module 0 – QBB #0, QBB #1, QBB #2, and QBB #3 Module 1		
	6	DVD / CD-ROM drive			
	7	PCI hot plug board (11 slots)			

Figure 8. NovaScale 6320 Server main cabinet components (example)



Note:

Abbreviations and acronyms are documented in the *Glossary*.

I/O Cabinet

The I/O cabinet contains the following components:

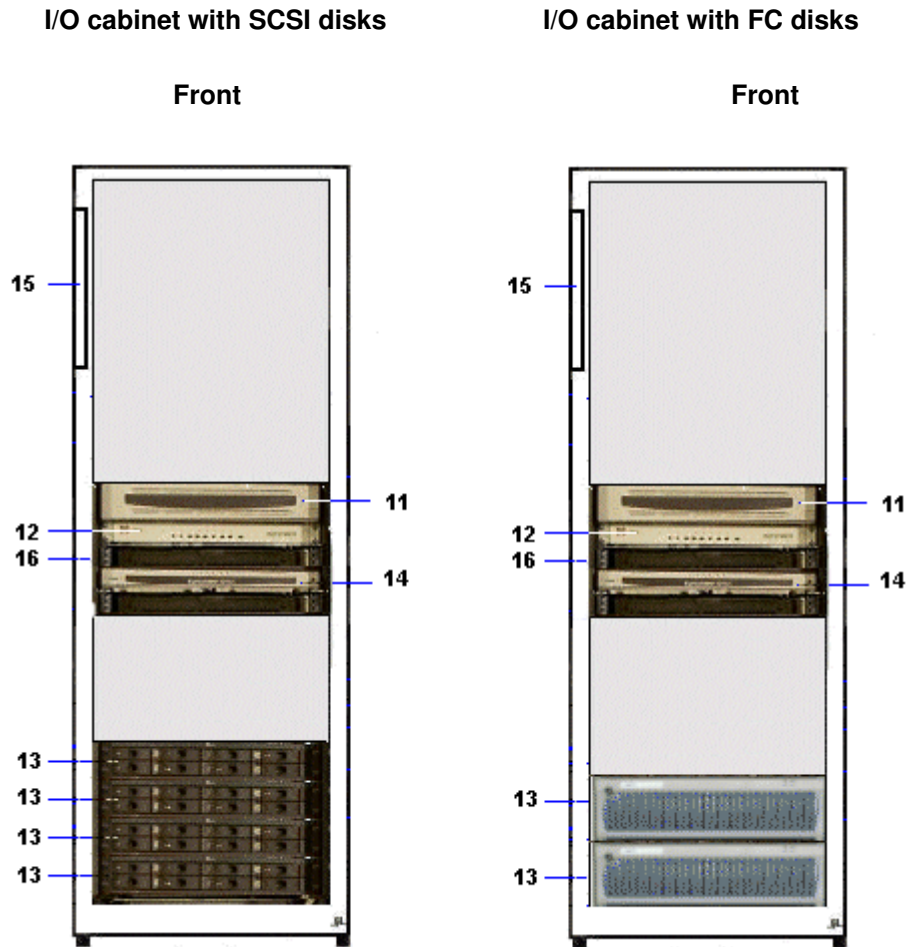

11	Console drawer with monitor, keyboard and mouse
12	KVM switch
13	1 up to 4 SCSI disk rack(s) with RAID controller(s) and disks, or 1 or two FC disk rack(s) with RAID controller(s) and disks
14	PAP unit with CD-ROM drive, FDD and disk(s)
15	PDU with AC power cable
16	Hub with power bar

Figure 9. NovaScale 6320 Server I/O cabinet components (examples)



Note:

Abbreviations and acronyms are documented in the *Glossary*.

Server Components

Central Subsystem (CSS) Module

The CSS Module houses main hardware components. The NovaScale 5080/5160 Server and the NovaScale 6080/6160 Server are equipped with one CSS module, located at the bottom of the cabinet. The NovaScale 6320 Server is equipped with two CSS modules, located at the top and bottom of the main cabinet.

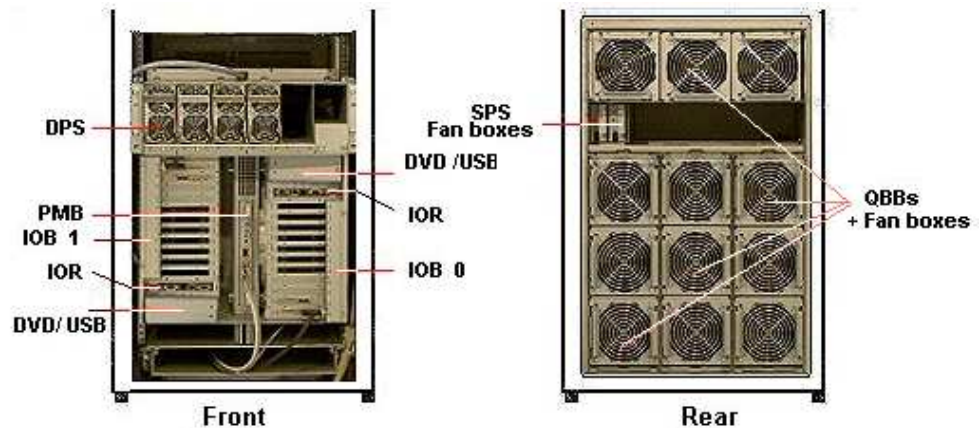

<p>1 MidPlane (MP) This active board is used to interconnect the QBBs, IOBs and the PMB.</p> <p>2 SPS fan boxes Each Midplane is equipped with two redundant fan boxes for cooling.</p>
<p>1, 2, 3 or 4 QBB (Quad Brick Board) subsets: Each QBB subset houses:</p> <ul style="list-style-type: none"> • 1 mother board • 2 memory boards • 4 processors • 16 DIMMs <p>1, 2, 3 or 4 QBB fan boxes: Each QBB subset is equipped with a fan box for cooling.</p>
<p>2 IOBs (Input / Output Box): Each IOB box houses:</p> <ul style="list-style-type: none"> • 1 IOB (Input / Output Board) • 1 PHPB (PCI Hot Plug Board) • 11 hot-plug PCI-X (100–133 MHz) slots with optional: <ul style="list-style-type: none"> – 1 SCSI HBA – 1 PCI SCSI card – 1 PCI FC card – 1 PCI Giga Ethernet card – 8 free slots • 1 IOR (Input / Output Riser): <ul style="list-style-type: none"> – 2 A-type USB ports • 1 RJ45 10/100 Mbps Ethernet port <ul style="list-style-type: none"> – 2 DB9–M RS232 serial ports – 1 HD15–F VGA port • 1 DVD/CD–ROM drive • 1 LS240 drive (optional) <p>Each IOB is cooled by the corresponding QBB fan box.</p>
<p>1 PMB (Platform Management Board): This active board links the server to the Platform Administration Processor (PAP) Unit (via an Ethernet link).</p>

Figure 10. CSS module features (full CSS module example)

NovaScale 6320 Server CSS Modules

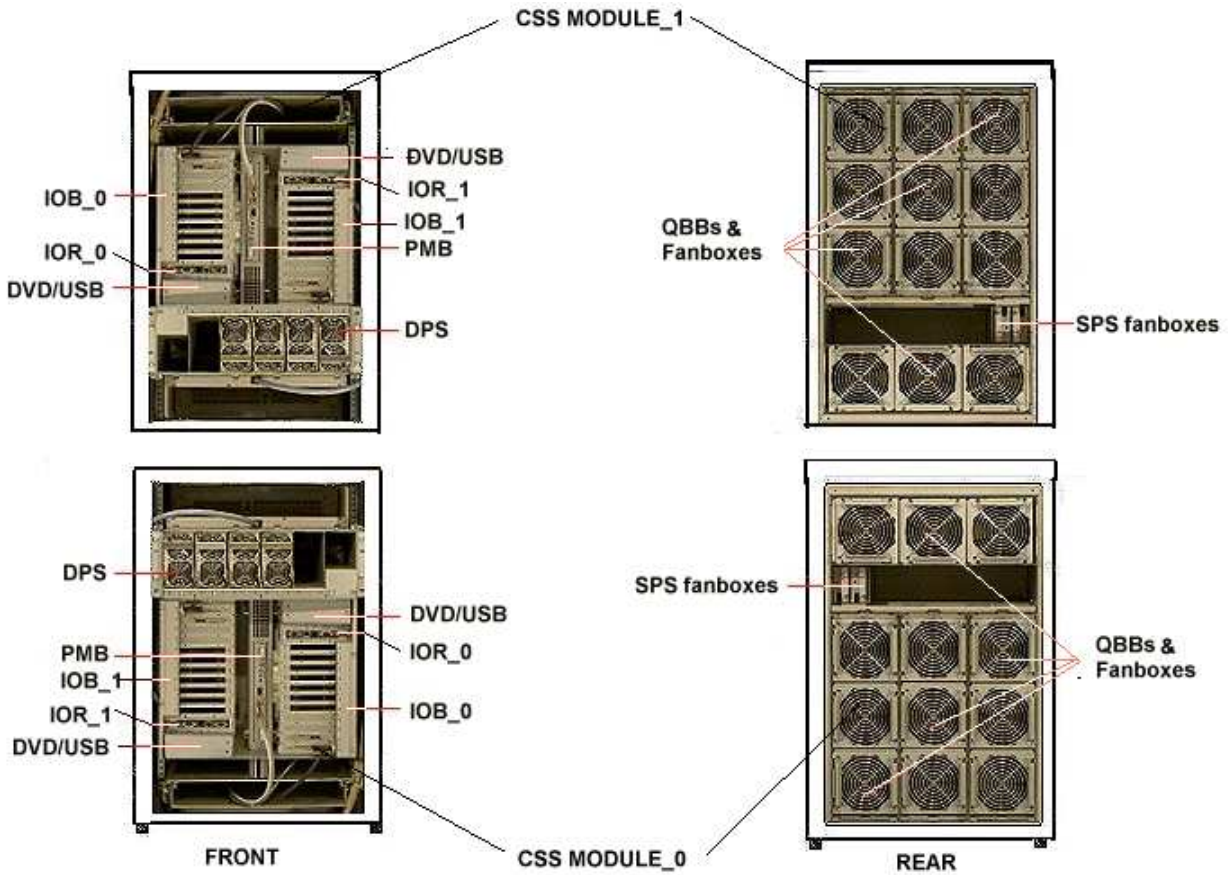

1 MidPlane (MP) 2 SPS fan boxes
1, 2, 3 or 4 QBB (Quad Brick Board) subsets 1, 2, 3 or 4 QBB fan boxes
1 or 2 IOBs (Input / Output Box)
1 PMB (Platform Management Board)



Note:

See Figure 10 for details.

Figure 11. CSS module features (NovaScale 6320 Server example)

Integrated Platform Administration Processor (PAP) Unit



Warning:

The PAP unit has been specially configured for Bull NovaScale Server administration and maintenance. **NEVER** use the PAP unit for other purposes and **NEVER** change PAP unit configuration unless instructed to do so by an authorized Customer Service Engineer.

The PAP unit is linked to the server via the Platform Management Board (PMB). It hosts Platform Administration Software (PAM). According to version, the PAP unit is located in the center of a high cabinet or at the top of a low cabinet.



Or

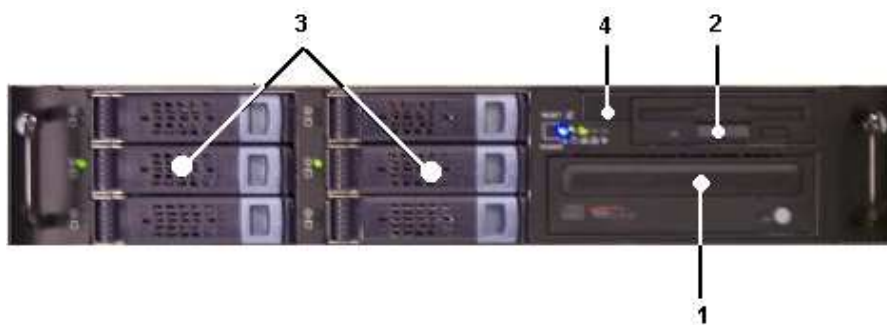

PAP Unit 1U	PAP Unit 2U
<ul style="list-style-type: none"> • 1 PIII / 1 GHz PC <ul style="list-style-type: none"> – 512 Mb RAM – 2 x 36 Gb disks (soft mirrored) (3) – 1 free disk slot (4) – 1 CD/DVD-ROM drive (1) – 1 FDD(2) – 2 serial ports – 2 PCI slots – 2 Ethernet ports (1 free) 	<ul style="list-style-type: none"> • 1 P4SCi / 2.6 GHz PC <ul style="list-style-type: none"> – 2 x 512 Mb RAM – 2 x 80 Gb disks (RAID) (3) – 4 free disk slots – 1 CD/DVD-ROM drive (1) – 1 FDD (2) – 2 serial ports – 3 PCI slots – 2 x 1 Gb Ethernet ports (1 free) – 4 USB ports (2 front (4)+ 2 rear))
<ul style="list-style-type: none"> • Microsoft Windows operating system • Internet Explorer software • PAM software • 1 power cable 	

Figure 12. PAP unit

Integrated Console

According to version, the integrated console is located in the center of a high cabinet or at the top of a low cabinet.

Slideaway Console

The Slideaway Console contains the keyboard, monitor and touch pad used for local access to the server and to the Platform Administration Processor (PAP) Unit.

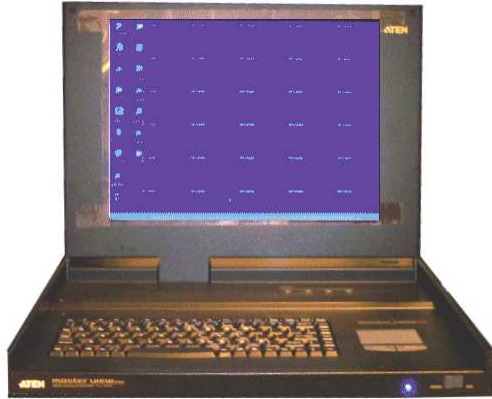

- 1 monitor
- 1 QWERTY keyboard and touch pad
- 1 power cable

Figure 13. Slideaway Console features

Console Drawer

The Console Drawer contains the keyboard, monitor and mouse used for local access to the server and to the Platform Administration Processor (PAP) Unit.



- 1 pull-out table top
- 1 monitor
- 1 QWERTY keyboard and mouse kit
- 1 power cable

Figure 14. Console drawer features

Keyboard / Video / Mouse (KVM) Switch

The KVM Switch allows the use of the integrated console for the local server and the local Platform Administration and Maintenance console.

8–Port KVM Switch

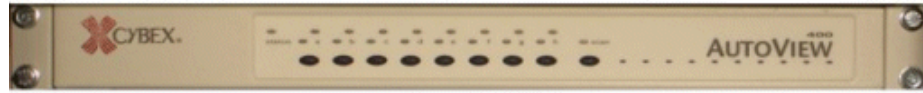

Or



- 8 ports
- 1 power cable

Figure 15. KVM switch features

16–Port KVM Switch



- 16 ports
- 1 power cable

Figure 16. KVM switch features

SR-0812 SCSI RAID / SJ-0812 SCSI JBOD Disk Racks

SR-0812 SCSI RAID / SJ-0812 SCSI JBOD Disk Racks are delivered with pre-installed system disks (two RAID#1 and one spare disk per domain). Empty slots can be used for data disks. According to version, the Disk Rack is located in the main or I/O cabinet.

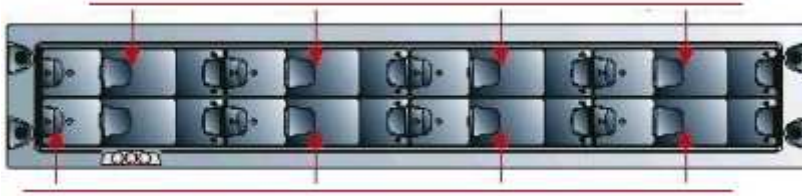

- 8 slots
- 1 RAID controller card
- 3 disks per domain (2 RAID#1 + 1 spare)
- 2 power cables (redundant power supply)

Figure 17. SR-0812 SCSI RAID / SJ-0812 SCSI JBOD disk rack features

SJ-0812 SCSI JBOD Extension Disk Rack

The SJ-0812 SCSI JBOD Extension Disk Rack offers eight empty slots for Customer data disks. According to version, the Extension Disk Rack is located in the main or I/O cabinet.

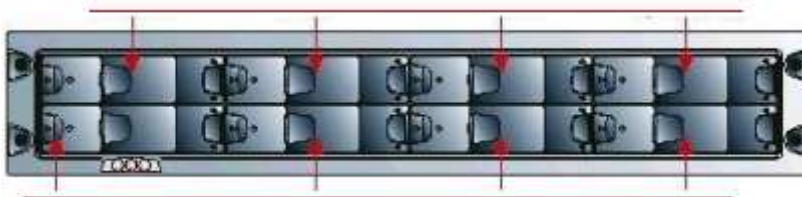

- 8 slots
- 2 power cables (redundant power supply)

Figure 18. SJ-0812 SCSI JBOD extension disk rack features

Ethernet Hub

The optional Maintenance LAN Ethernet Hub is used to connect PMB, PAP Unit and external FDA FC Disk Rack Ethernet ports.



Ethernet Hub	<ul style="list-style-type: none">- 8 ports- 1 power cable- 1 power bar
--------------	---

Figure 19. Ethernet hub features

USB Modem

The optional USB modem is used to transmit Autocalls to the Remote Maintenance Center, if your maintenance contract includes the Autocall feature.



USB Modem	<ul style="list-style-type: none">- 1 USB cable- 1 RJ11 cable
-----------	--

Figure 20. USB modem features

NPort Server

The Nport Server is used connect the administration port of the SR-0812 SCSI RAID disk rack to the PAP Unit.

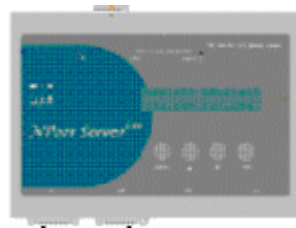

NPort Server	<ul style="list-style-type: none">- 2 DB9 to Jack cable- 1 RJ45 – RJ45 Ethernet cable
--------------	--

Figure 21. NPort Server features

Power Distribution Unit (PDU)

The PDU supplies mains power to the PAP unit, the external Disk Rack, the KVM Switch, the Integrated Console, and the Ethernet Hub. When the server is equipped with an FDA 1x00 FC or an FDA 2x00 FC, the PDU also supplies mains power to the Power Bar. The PDU is located in the top left part of the cabinet. According to version, the PDU is located in the top left part of the main or I/O cabinet.



Front Rear

- 6 (8A) sockets (front):
- 2 (1A) sockets (rear):
- 1 (20A) power cable

Figure 22. PDU features

Accessing Server Components

During normal operation, cabinet components can be accessed from the front. Customer Service Engineers may also remove the rear and side covers for certain maintenance operations.



Important:
Optimum cooling and airflow is ensured when the cabinet door is closed.

Opening the Front Door

Tools Required:

- Cabinet key

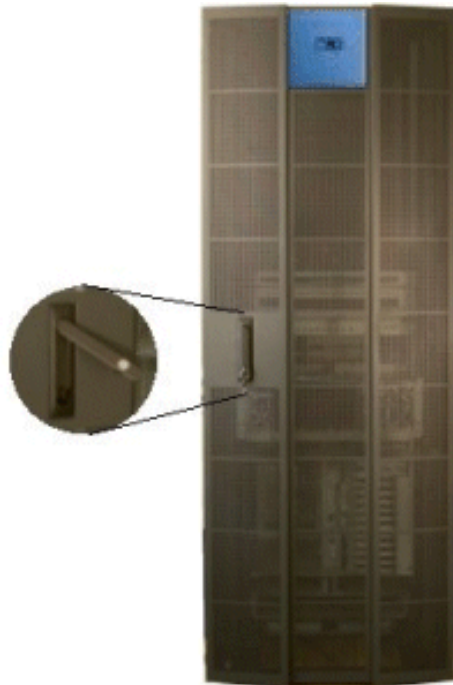

Figure 23. Opening the front door

1. Unlock the front door with the key.
2. Pull out the locking mechanism and turn to open.
3. Open the door as required (90° / 180°).

Closing the Front Door

1. Close the door.
2. Turn the locking mechanism to close and push back into place.
3. Lock the front door with the key.

Opening / Closing the Slideaway Console

The server is equipped with an integrated console for local administration and maintenance operations.



Figure 24. Slideaway console

To open the slideaway console:

1. Slide the console forward until it clicks into place.
2. Use the front bar to lift the screen panel into position.

To close the slideaway console:

1. Press the 2 buttons marked PUSH on either side of the keyboard panel to release the console.
2. Lower the front bar to close the screen panel.
3. Slide the console back into the cabinet.

Setting up the Console Drawer

The server is equipped with an integrated console for local administration and maintenance operations. To set up the system console, proceed as follows:

1. Pull out the console drawer and lower the magnetic front flap.



Figure 25. Lowering the console drawer flap

2. Pull on the tab to extend the mouse tray.



Figure 26. Extending the mouse tray

3. Manually position the monitor and check that the vacation switch on the right-hand side of the monitor is ON.



Figure 27. Positioning the monitor

4. Install the mouse on the extendable tray, ready for use.



Figure 28. Console ready for use

Closing the Console Drawer

1. Replace the mouse on the pad inside the drawer and push on the tab to replace the mouse tray in its housing.
2. Raise the magnetic front flap.
3. Manually lower the monitor.
4. Press firmly on the tabs on each side of the drawer and push the drawer back into the cabinet.



- (1) Tab (1 on each side of the drawer)

Figure 29. Closing the console drawer

Accessing the PAP Unit CD-Rom and Diskette Drives

Tools Required:

- PAP unit key

The PAP unit CD-Rom and diskette drives are located behind the front bezel. To access the CD-Rom and/or diskette drives, unlock the front bezel with the PAP unit key and remove.



Figure 30. PAP Unit CD-Rom and Diskette Drives

Bull NovaScale Server Resources



Note:

According to server configuration and version, certain features and functions described in this guide may not be accessible. Please contact your Bull Sales Representative for sales information.

System Resource and Documentation CD-Roms

The Bull NovaScale Server System Resource and Documentation CD-Roms contain all the firmware and documentation referred to in this guide.

PAM Software Package

The Bull NovaScale Server is equipped with an integrated Platform Administration and Maintenance software package, otherwise known as the PAM software package.

One part of PAM software is an embedded application (MAESTRO) running on the Platform Management Board(s) (PMB) and the other is an external application (PAM Kernel / Web User Interface) running on the Platform Administration Processor (PAP) unit under Microsoft Windows.

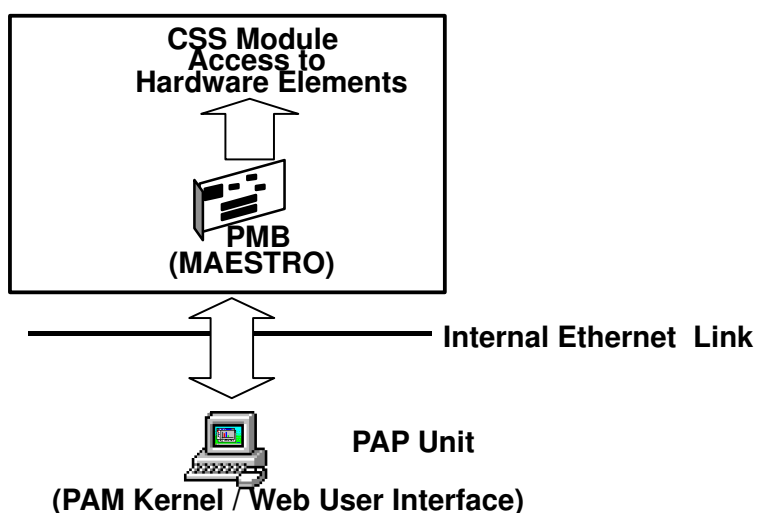

Figure 31. PAM software deployment

The PAM Web-based administration and maintenance tools give you immediate insight into system status and configuration. You will use PAM software to operate, monitor, and configure your Bull NovaScale Server.

As soon as your system is connected to the power supply, the PAP unit running Microsoft Windows and PAM software also powers up. For further information about connecting to PAM, see *Connecting to the PAM Web Site*, on page 2-2.

PAP Unit Mirroring and Failover Policy

Most configuration, administration, and maintenance activities are carried out from the PAP unit. To ensure a high level of data integrity and availability, the PAP unit is equipped with two extractable mirrored disks. Mirroring writes and updates data across both disks, creating a single logical volume with completely redundant information on each disk. If one disk fails, it can be replaced without losing data.



Note:

For enhanced data integrity and availability, the PAP unit can be equipped with a third disk. Contact your Customer Representative for details.

EFI Utilities

The Bull NovaScale Server EFI utilities provide a complete set of configuration, operation, and maintenance tools:

- EFI driver,
- EFI Shell,
- EFI system utility,
- EFI system diagnostic,
- Operating System loader.

For further details, see Chapter 5. *Tips and Features for Administrators*.

Chapter 2. Getting Started

This chapter explains how to connect to and start server domains. It includes the following topics:

- Connecting to the PAM Web Site, on page 2-2
- PAM User Interface, on page 2-5
- Setting up Users, on page 2-8
- Toggling the Local / Integrated Console Display, on page 2-8
- Powering Up / Down Server Domains, on page 2-15
- Preparing Server Domains for Remote Access via the Enterprise LAN, on page 2-19
- Preparing Server Domains for Remote Access via the Web, on page 2-21
- Connecting to a Server Domain via the Enterprise LAN, on page 2-22
- Connecting to a Server Domain via the Web, on page 2-23



Note:

Customer Administrators and Customer Operators are respectively advised to consult the *Administrator's Memorandum*, on page xxvi or the *Operator's Memorandum*, on page xxviii for a detailed summary of the everyday tasks they will perform.

For further information about user accounts and passwords, see *Setting up PAP Unit Users*, on page 5-22.

Connecting to the PAM Web Site

The server is equipped with an integrated Platform Administration and Maintenance software package, otherwise known as PAM software. One part of PAM software is an embedded application (MAESTRO) running on the Platform Management Board (PMB) and the other is an external application running on the Platform Administration Processor (PAP) unit under Microsoft Windows.

The PAM Web-based administration and maintenance tools give you immediate insight into system status and configuration. You will use PAM software to operate, monitor, and configure your server.



Notes:

Local and remote access rights to the PAP unit and to the PAM Web site must be configured by the Customer Administrator. For further details, refer to the Microsoft Windows documentation and to *Setting up PAP Unit Users*, on page 5-22. Customer Administrator rights are required for all PAM configuration tasks.

Connecting to the PAM Web Site from the Local / Integrated Console



CAUTION:

Access to the local / integrated console should be restricted to Customer / Support Administrators and Operators ONLY to avoid inadvertent damage to software and/or hardware components.

1. Check that the KVM switch is set to the **PAP Unit** port. See *Toggling the Local / Integrated Console Display*, on page 2-8.
2. From the PAP unit Microsoft Windows desktop, double-click the PAM icon (**http://localhost/PAM**).
3. When prompted, enter the appropriate Administrator or Operator **User Name** and **Password**. The PAM home page appears.

Connecting to the PAM Web Site from a Remote Computer/Workstation



Important:

Before connecting to PAM from a remote computer, you are advised to disconnect from your local Windows session on the PAP unit by clicking **Start → Log Off**.

The PAM Software utility can be accessed from any PC running Microsoft Windows with the Internet Explorer (6 or later) or browser installed and/or from any workstation running Linux with the Mozilla (1.6 or later) browser installed.



Note:

Do NOT use the Mozilla browser on the PAP unit.

Enabling Remote Access to the PAM Web Site with Internet Explorer

1. From the remote computer, configure Internet Explorer to connect directly to the PAM Web site:
 - a. From the Internet Explorer main menu bar, click **Tools → Internet Options**.
 - b. Under the **General** tab, type the PAM Web site URL defined during the PAP installation procedure in the **Home Page Address** field:
http://<PAPname>/pam
(where **<PAPname>** is the name allocated to the PAP unit during setup).
 - c. Click **Advanced → Restore Defaults** to validate default settings.
 - d. Save your changes and close Internet Explorer.
2. Launch Internet Explorer to connect directly to the PAM web site.
3. When prompted, enter the appropriate Administrator or Operator **User Name** and **Password**. The PAM home page appears.

Enabling Remote Access to the PAM Web Site with Mozilla

1. From the remote computer, configure Mozilla to connect directly to the PAM Web site:
 - a. From the Mozilla main menu bar, select **Edit → Preferences → Navigator**.
 - b. Select the **Home Page** checkbox and enter the PAM Web site URL defined during the PAP installation procedure in the location field:
http://<PAPname>/pam
(where **<PAPname>** is the name allocated to PAP unit during setup).
 - c. Select the **Restore Defaults** checkbox to validate default settings.
 - d. Save your changes and close Mozilla.
2. Launch Mozilla to connect directly to the PAM web site.
3. When prompted, enter the appropriate Administrator or Operator **User Name** and **Password**. The PAM home page appears.

Simultaneous Connection to the PAM Web Site

Several users can access the PAM Web site simultaneously.



Important:

If configuration changes are made, they may not be visible to other users unless they refresh the PAM Tree.

As Customer Administrator, you can view the list of PAM users currently logged onto the PAM Web site by clicking **Hardware Monitor** → **PAM Web Site**.

The Web site version and a list of connected users and session details are displayed in the **Control** pane.

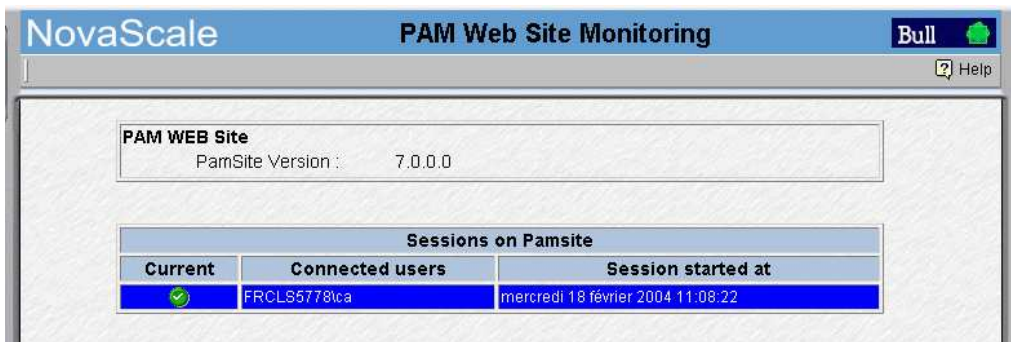

The icon indicates the current session.

Figure 32. PAM Web site session details

You can also open several browser sessions from the same computer to obtain different views of system operation. For example, as Customer Administrator, you may want to open a first session for permanent and easy access to powering on/off functions, a second session for access to system histories and archives, and a third session for access to configuration menus, as shown in the following figure.

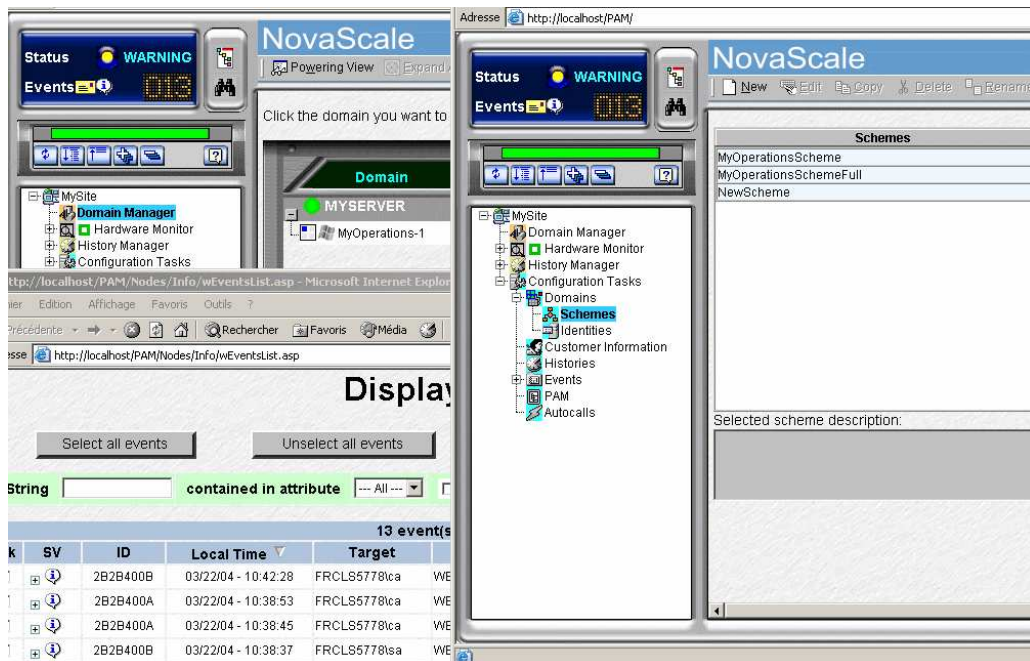

Figure 33. Multiple session example

PAM User Interface

The PAM user interface is divided into three areas in the browser window: a **Status** pane, a **PAM Tree** pane, and a **Control** pane.

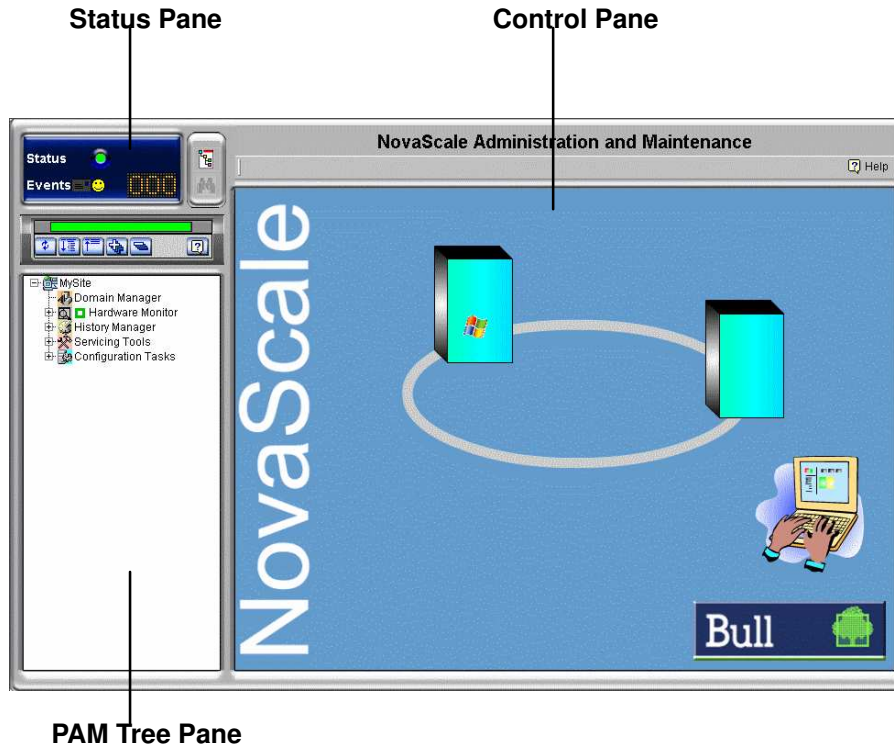

Figure 34. PAM user interface



Note:

For further details about the PAM user interface, please consult the *User's Guide*.

Checking Server Status via PAM

The PAM user interface allows you to check system status at a glance. If the **Functional Status** icon in the **Status** pane and the **CSS Availability Status** bar are green, the server is ready to be powered up.

PAM Status Pane

The **Status** pane, which is automatically refreshed every few seconds, provides quick access to the following synthetic information:

- **Functional Status:** if the system is operating correctly, the status icon is green,
- **Event Messages:** shows the number and maximum severity of pending event messages,
- **CSS Availability Status:** if the CSS Module is present, configured correctly, and is ready to operate, the status bar is green.

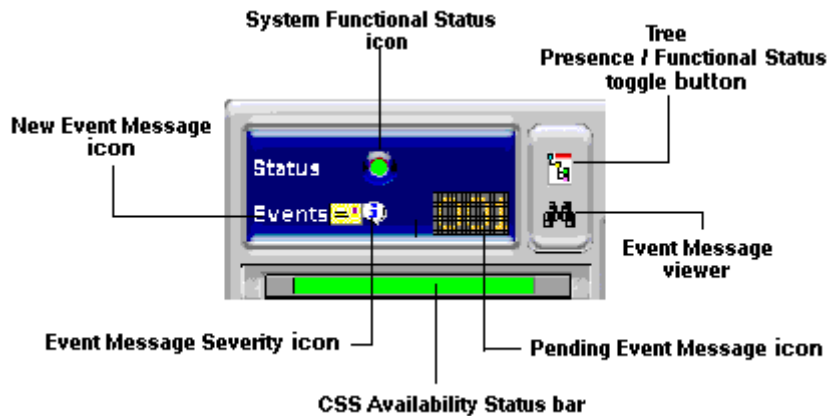

Figure 35. Status pane

CSS Availability Status

NovaScale 5080/5160 Server / NovaScale 6080/6160 Server

When the CSS Module is operating correctly, the **CSS Availability Status** bar is green. If the CSS Module is not operating correctly, the bar is red.

NovaScale 6320 Server

The **CSS Availability Status** bar is divided into two zones.

If the CSS Modules are operating correctly, the **CSS Availability Status** bar is green.

If the CSS Modules are not operating correctly, the bar is red.

If one of the CSS Modules is not operating correctly, half the bar is red.

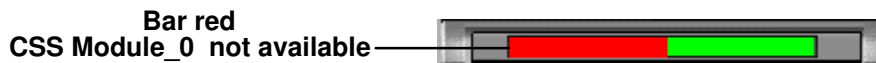

Figure 36. CSS Module availability status bar (bi-module server)

PAM Tree Pane



Note:

The PAM tree building process may take one to two minutes. The PAM tree pane is refreshed on request.

The **PAM Tree** pane provides access to server administration and maintenance features:

Tree Nodes	Function
Domain Manager	to power on / off and manage domains. See Chapter 3. Managing Domains.
Hardware Monitor	to display the status of hardware components and assemblies. See Chapter 4. Monitoring the Server.
History Manager	to view logs and manage archives. See Chapter 4. Monitoring the Server.
Configuration Tasks	to customize server features. See Chapter 5. Tips and Features for Administrators.

Table 3. PAM Tree nodes

PAM Tree Toolbar

The PAM Tree toolbar, located at the top of the PAM Tree, is used to refresh, expand, or collapse the tree display.



Toolbar Buttons	Explanation
	Refresh /rebuild the PAM Tree to view changes.
	Expand the complete tree.
	Collapse the complete tree.
	Expand selected node.
	Collapse selected node.
	View the related Help topic.

Figure 37. PAM Tree toolbar

PAM Control Pane

When an item is selected in the **PAM Tree** pane, details and related commands are displayed in the **Control** pane, which is automatically refreshed at one minute intervals.

Setting up Users

As Customer Administrator, you must set up user accounts and passwords to control access to the PAP unit. See *Setting up PAP Unit Users*, on page 5-22.

toggling the Local / Integrated Console Display

During the powering up / down sequences, you will be requested to toggle the local / integrated console from the PAP unit display to the server domain display, or vice versa, as explained below.



CAUTION:

Access to the local / integrated console should be restricted to Customer / Support Administrators and Operators ONLY to avoid inadvertent damage to software and/or hardware components.

The KVM Switch allows the integrated console to be used as the local server domain and local PAP unit console. KVM ports are configured as shown in Table 4.

NovaScale 5xx0 Server

8-Port KVM Switch (AutoView)	Console Display	Domain
Port A	PAP Unit	N/A
Port B (PS2)	Microsoft Windows Domain	N/A
Port C (USB)	Linux Domain	N/A

or

8-Port KVM Switch (MasterView)	Console Display	Domain
Port 1	PAP Unit	N/A
Port 2	Server Domain	N/A

NovaScale 6xx0 Server

8-Port KVM Switch	Console Display	Domain
Port 1	PAP Unit	N/A
Port 2	CSS0-Mod0-IO0	MyOperations-xx-1
Port 3	CSS0-Mod0-IO1	MyOperations-xx-2

or

16-Port KVM Switch	Console Display	Domain
Port 1	PAP Unit	N/A
Port 3	CSS0-Mod0-IO0	MyOperations-xx-1
Port 4	CSS0-Mod0-IO1	MyOperations-xx_2
Port 5	CSS0-Mod1-IO0	MyOperations-xx-3
Port 6	CSS0-Mod1-IO1	MyOperations-xx-4

Table 4. KVM port configuration

You can easily toggle from the server domain display to the PAP unit display, or vice versa:

1. From the keyboard, press the **Control** key twice to display the KVM Switch Command Menu.
2. Select the required port with the $\uparrow\downarrow$ keys and press **Enter**.
3. The selected display appears on the Console monitor.

Powering Up / Down Server Domains

To power up / down the server, see:

- *Powering Up / Down the NovaScale 5xx0 Server Domain*, on page 2-9
- *Powering Up / Down NovaScale 6080/6160 Server Domains*, on page 2-11
- *Powering Up / Down NovaScale 6320 Server Domains*, on page 2-15

Powering Up the NovaScale 5xx0 Server Domain

NovaScale 5xx0 Servers are designed to operate as single SMP systems and are delivered with one pre-configured domain.

When server status has been checked – functional status icon and CSS availability status bar green in the Status pane – the server domain can be powered up.

Note:

If an error dialog box appears during this sequence, see Chapter 3. *Managing Domains*.

To power up server domains:

1. From the PAM Tree, click **Domain Manager** to open the **Control** pane.
2. Select the domain. If the domain is ready to be powered up, **INACTIVE** is displayed in the **Domain State** box and the **Power On** button is accessible.
3. Click **Power On** to power up the server domain and associated hardware components.

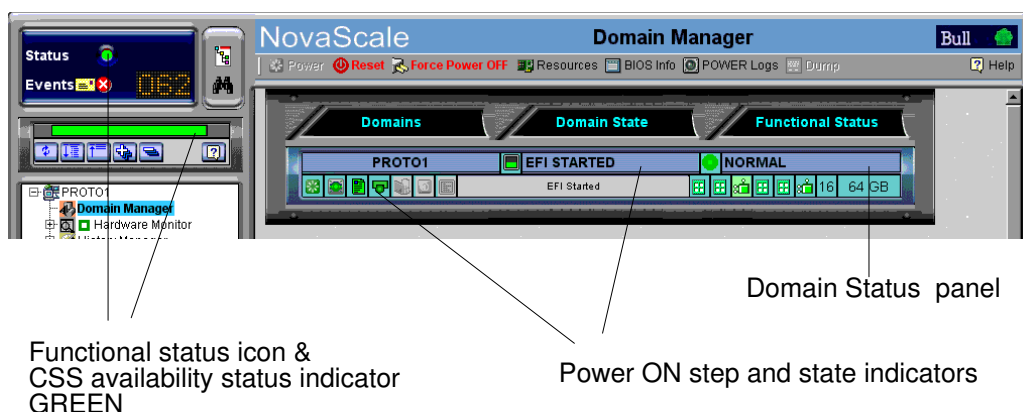

Figure 38. Domain Manager Control pane

4. Follow the power-on steps displayed in the **Domain State** box, until **RUNNING** is displayed.

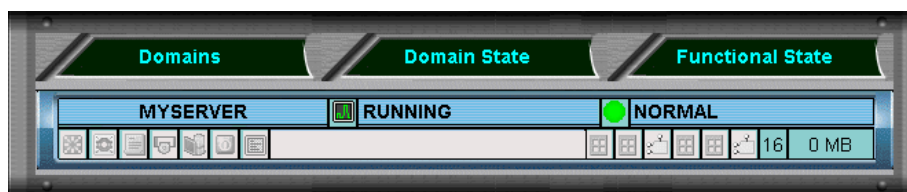

Figure 39. Domain state

5. Toggle the local / integrated console from the PAP unit display to the server display. See *Toggling the Local / Integrated Console Display*, on page 2-8.
6. Wait for the Operating System to load completely. The domain is now fully functional.

7. Check the Operating System environment pre-installed on the domain.
8. As Customer Administrator, you can now prepare each domain for remote access via the Enterprise LAN and/or via the Web. See *Preparing Server Domains for Remote Access via the Enterprise LAN*, on page 2-19 and *Preparing Server Domains for Remote Access via the Web*, on page 2-21.

Powering Down the NovaScale 5xx0 Server Domain



Note:

If an error dialog box appears during this sequence, see Chapter 3. *Managing Domains*.

1. Shut down the Operating System to power down the domain to the stand-by mode.
2. Toggle the local / integrated console to the PAP unit display. **INACTIVE** is displayed in the **Domain State** box and the **Power ON** button is accessible.



Note:

For further details about the **Power ON / OFF** sequences, see *Powering ON a Domain*, on page 3-15 and *Powering OFF a Domain*, on page 3-18.

Powering Up NovaScale 6080/6160 Server Domains

The NovaScale 6080/6160 Server is designed to operate as two hardware-independent SMP systems, or domains.



For easy configuration and optimum use of the physical and logical resources required for simultaneous operation, domains are defined by the Customer Administrator via the **PAM Domain Scheme** wizard.

For further details about domain configuration, see *Configuring Domains*, on page 5-33.





The server is delivered with a default scheme, or configuration file, called **MyOperationsScheme-xx** containing two domains, **MyOperations-xx-1** and **MyOperations-xx-2**. An Operating System instance is pre-installed on each domain boot disk (EFI LUN). According to your requirements, identical or different Operating System instances may be pre-installed on each EFI LUN. The default scheme allows domains to be booted simultaneously or independently. A brief summary of the organization of physical and logical resources in **MyOperationsScheme-xx** is given in the following table.



Notes:

- **xx** in the default Scheme and domain names represents the Central Subsystem HW identifier (from 00 to 16). For further details, refer to *PMB Code Wheel Settings*, on page 4-45.
- In the screen shots, tables, and examples in this guide:
 - **MyOperationsScheme-xx** is referred to as **MyOperationsScheme**
 - **MyOperations-xx-1** is referred to as **MyOperations-1**
 - **MyOperations-xx-2** is referred to as **MyOperations-2**
- In the screen shots in this guide, an instance of Microsoft Windows is pre-installed on **MyOperations-xx-1** and an instance of Linux is pre-installed on **MyOperations-xx-2**. Operating System type is indicated by the Microsoft Windows  or Linux  logo in the **Domain Identities** box.

MyOperationsScheme Organization

Domain Identity: MyOperations-1	
Hardware Cell	Cell_0
Operating System (customer-specific)	 Windows or  Linux
EFI LUN**	*<MyServer>_0LU0
IOB	Module0_IOB0
QBBs	Module0_QBB0, Module0_QBB1
Domain KVM Ports	***CSS0_Mod0_IO0
Domain Identity: MyOperations-2	
Hardware Cell	Cell_1
Operating System (customer-specific)	 Windows or  Linux
EFI LUN**	*<MyServer>_0LU1
IOB	Module0_IOB1
QBBs	Module0_QBB2, Module0_QBB3
Domain KVM Ports	***CSS0_Mod0_IO1

* <MyServer> = default server name, e.g.: NS6080-0, NS6160-0

** EFI LUN: xLUx = boot LUN device location (*ModxLUIOx*):

0LU0 = LUN device connected to Module0, IOB0

0LU1 = LUN device connected to Module0, IOB1

0LU2 = LUN device connected to Module1, IOB0

0LU3 = LUN device connected to Module1, IOB1

***CSSx = CSS number, Modx = Module number, IOx = IO box number



Note:

The NovaScale 6080 Server is equipped with QBB_0 and QBB_3, only.

Table 5. MyOperationsScheme organization – mono-module server



Note:

If an error dialog box appears during these sequences, see Chapter 3. *Managing Domains*.

To power up server domains:

1. From the PAM Tree, click **Domain Manager** to open the **Control** pane. You are invited to load a **Domain Scheme**.
2. Click **Schemes**. The **Schemes List** dialog opens displaying the pre-configured scheme.
3. Select **MyOperationsScheme** and click **Apply**.

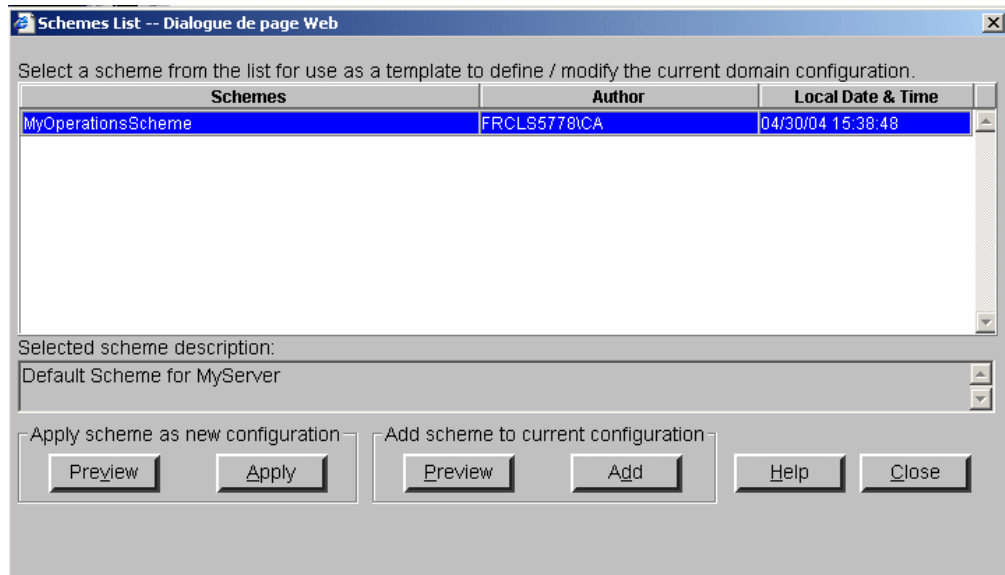

Figure 40. Domain schemes list dialog

- When requested, click **Yes** to confirm. **MyOperations–1**, **MyOperations–2**, domains are loaded in the **Control** pane.

If the domains are ready to be powered up, **INACTIVE** is displayed in the **Domain State** boxes and the **Power On** button is accessible for each domain.

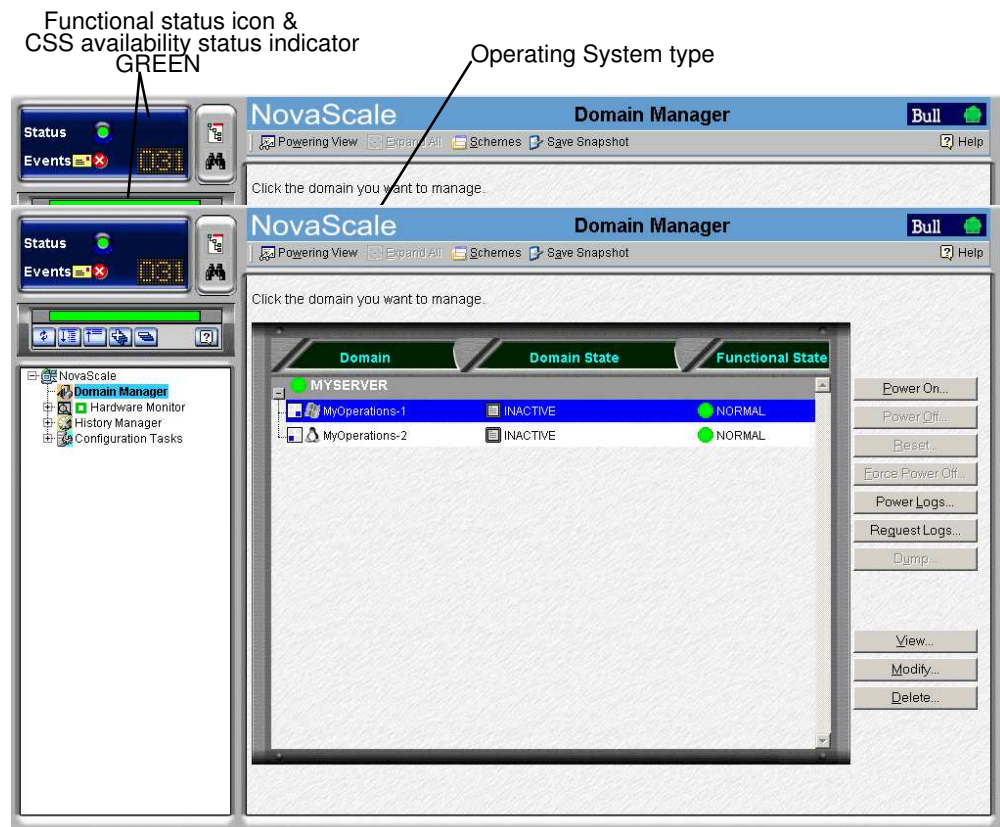

Figure 41. Domain Manager Control pane

- Select **MyOperations–1** in the **Control** pane and click **Power On** to power up the domain and associated hardware components.
- Select **MyOperations–2** in the **Control** pane and click **Power On** to power up the domain and associated hardware components.

7. Follow the power-on steps displayed in the **Domain State** boxes, until **RUNNING** is displayed in both **Domain State** boxes.

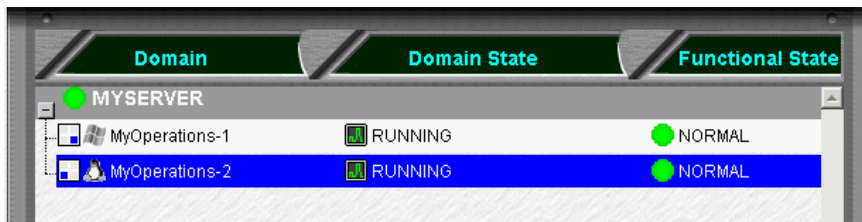

Figure 42. Domain state

8. Toggle the local / integrated console from the PAP unit display to **MyOperations-1** display. See *Toggling the Local / Integrated Console Display*, on page 2-8.
9. Wait for the Operating System to load completely. **MyOperations-1** domain is now fully functional.
10. Toggle the local / integrated console from **MyOperations-1** display to **MyOperations-2** display.
11. Wait for the Operating System to load completely. **MyOperations-2** domain is now fully functional.
12. Check the Operating System environment pre-installed on each domain.
13. As Customer Administrator, you can now prepare each domain for remote access via the Enterprise LAN and/or via the Web. See *Preparing Server Domains for Remote Access via the Enterprise LAN*, on page 2-19 and *Preparing Server Domains for Remote Access via the Web*, on page 2-21.

Powering Down NovaScale 6080/6160 Server Domains



Note:

If an error dialog box appears during this sequence, see Chapter 3. *Managing Domains*.

1. Shut down each Operating System to power down the corresponding domain to the stand-by mode.
2. Toggle the local / integrated console to the PAP unit display. **INACTIVE** is displayed in the **Domain State** boxes and the **Power ON** button is accessible for each domain.



Note:

For further details about the **Power ON / OFF** sequences, see *Powering ON a Domain*, on page 3-15 and *Powering OFF a Domain*, on page 3-18.

Powering Up NovaScale 6320 Server Domains

The NovaScale 6320 Server is designed to operate as four hardware-independent SMP systems, or domains.

For easy configuration and optimum use of the physical and logical resources required for simultaneous operation, domains are defined by the Customer Administrator via the **PAM Domain Scheme** wizard. For further details about domain configuration, see *Configuring Domains*, on page 5-33.









The server is delivered with a default scheme, or configuration file, called **MyOperationsScheme-xx**, containing up to four domains, **MyOperations-xx-1**, **MyOperations-xx-2**, **MyOperations-xx-3**, **MyOperations-xx-4**. An Operating System instance is pre-installed on each domain boot disk (EFI LUN). According to your requirements, identical or different Operating System instances may be pre-installed on each EFI LUN. The default scheme allows you to simultaneously boot all domains. A brief summary of the organization of physical and logical resources in **MyOperationsScheme-xx** is given in the following table.

Notes:

- **xx** in the default Scheme and domain names represents the Central Subsystem HW identifier (from 00 to 16). For further details, refer to *PMB Code Wheel Settings*, on page 4-45.
- In the screen shots, tables, and examples in this guide:
 - **MyOperationsScheme-xx** is referred to as **MyOperationsScheme**
 - **MyOperations-xx-1** is referred to as **MyOperations-1**
 - **MyOperations-xx-2** is referred to as **MyOperations-2**
 - **MyOperations-xx-3** is referred to as **MyOperations-3**
 - **MyOperations-xx-4** is referred to as **MyOperations-4**
- In the screen shots in this guide, an instance of Microsoft Windows is pre-installed on **MyOperations-xx-1** and **MyOperations-xx-3** and an instance of Linux is pre-installed on **MyOperations-xx-2** and **MyOperations-xx-4**.

Operating System type is indicated by the Microsoft Windows  or Linux  logo in the **Domain Identities** box.

MyOperationsScheme Organization

Domain Identity: MyOperations-1	
Hardware Cell	Cell_0
Operating System (customer-specific)	 Windows or  Linux
EFI LUN**	*<MyServer>_0LU0
IOB	Module0_IOB0
QBBs	Module0_QBB0, Module0_QBB1
Domain KVM Ports	***CSS0_Mod0_IO0
Domain Identity: MyOperations-2	
Hardware Cell	Cell_1
Operating System (customer-specific)	 Windows or  Linux
EFI LUN**	*<MyServer>_0LU1
IOB	Module0_IOB1
QBBs	Module0_QBB2, Module0_QBB3
Domain KVM Ports	***CSS0_Mod0_IO1
Domain Identity: MyOperations-3 (NovaScale 6320 Server)	
Hardware Cell	Cell_2
Operating System (customer-specific)	 Windows or  Linux
EFI LUN**	*<MyServer>_0LU2
IOB	Module1_IOB0
QBBs	Module1_QBB0, Module1_QBB1
Domain KVM Ports	***CSS0_Mod1_IO0
Domain Identity: MyOperations-4 (NovaScale 6320 Server)	
Hardware Cell	Cell_3
Operating System (customer-specific)	 Windows or  Linux
EFI LUN**	*<MyServer>_0LU3
IOB	Module1_IOB1
QBBs	Module1_QBB2, Module1_QBB3
Domain KVM Ports	***CSS0_Mod1_IO1

* <MyServer> = default server name, e.g.: NS6080-0, NS6160-0, NS6320-0

** EFI LUN: xLUx = boot LUN device location (*ModxLUIOx*):

0LU0 = LUN device connected to Module0, IOB0

0LU1 = LUN device connected to Module0, IOB1

0LU2 = LUN device connected to Module1, IOB0

0LU3 = LUN device connected to Module1, IOB1

***CSSx = CSS number, Modx = Module number, IOx = IO box number

Table 6. MyOperations Scheme organization – bi-module server



Note:

If an error dialog box appears during these sequences, see Chapter 3. *Managing Domains*.

To power up server domains:

1. From the PAM Tree, click **Domain Manager** to open the **Control** pane. You are invited to load a **Domain Scheme**.
2. Click **Schemes**. The **Schemes List** dialog opens displaying the pre-configured scheme.
3. Select **MyOperationsScheme** and click **Apply**.

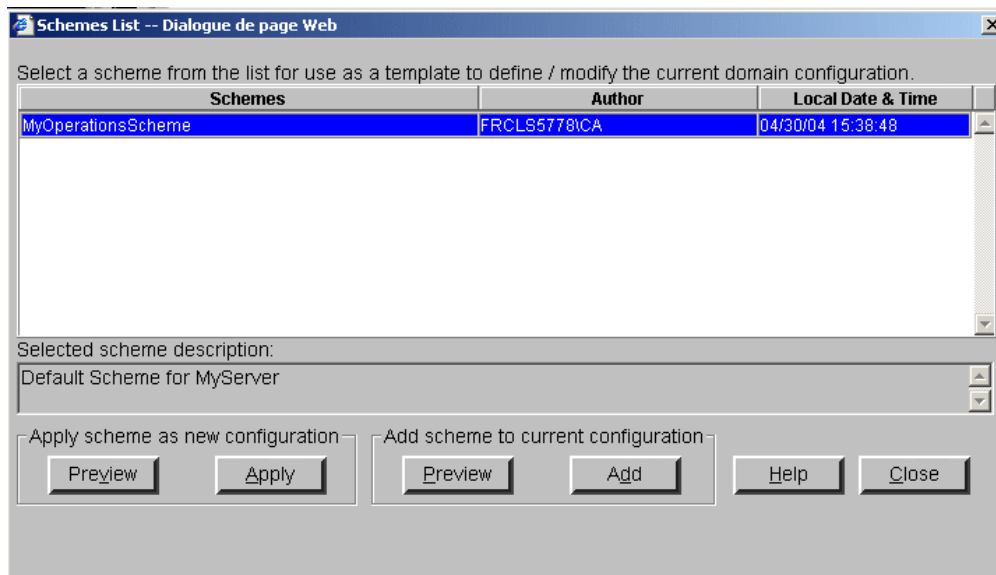

Figure 43. Domain schemes list dialog

4. When requested, click **Yes** to confirm. **MyOperations–1, MyOperations–2, MyOperations–3, and MyOperations–4** domains are loaded in the **Control** pane. If the domains are ready to be powered up, **INACTIVE** is displayed in the **Domain State** boxes and the **Power On** button is accessible for each domain.

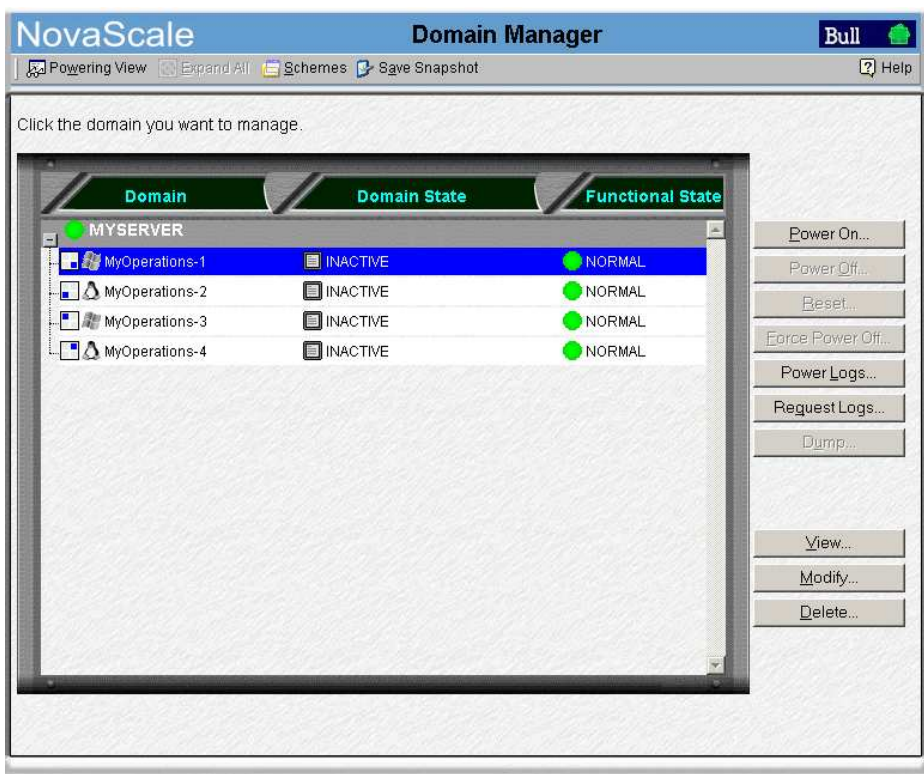

Figure 44. Domain Manager Control pane

5. Select **MyOperations–1** in the **Control** pane and click **Power On** to power up the domain and associated hardware components.
6. Repeat Step 5 for each domain in the **Control** pane.
7. Follow the power–on steps displayed in the **Domain State** boxes, until **RUNNING** is displayed in all **Domain State** boxes.

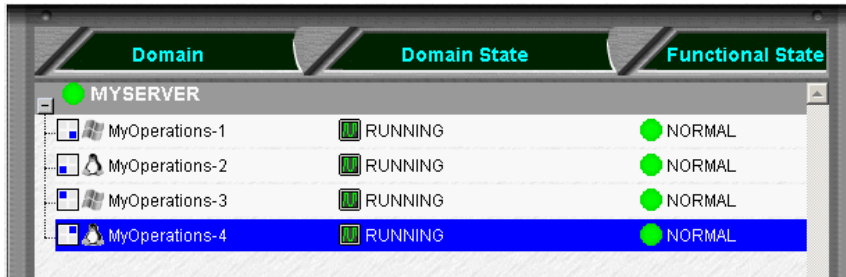

Figure 45. Domain state

8. Toggle the local / integrated console from the PAP unit display to the first domain display. See *Toggling the Local / Integrated Console Display*, on page 2-8.
9. Wait for the Operating System to load completely. The domain is now fully functional.
10. Toggle the local / integrated console from this domain display to the next domain display.
11. Wait for the Operating System to load completely. The domain is now fully functional.
12. Repeat Steps 10 and 11 for each domain.
13. Check the Operating System environment pre–installed on each domain.
14. As Customer Administrator, you can now prepare each domain for remote access via the Enterprise LAN and/or via the Web. See *Preparing Server Domains for Remote Access via the Enterprise LAN*, on page 2-19 and *Preparing Server Domains for Remote Access via the Web*, on page 2-21.

Powering Down NovaScale 6320 Server Domains



Note:

If an error dialog box appears during this sequence, see Chapter 3. *Managing Domains*.

1. Shut down each Operating System to power down the corresponding domain to the stand–by mode.
2. Toggle the local / integrated console to the PAP unit display. **INACTIVE** is displayed in the **Domain State** boxes and the **Power ON** button is accessible for each domain.



Note:

For further details about the **Power ON / OFF** sequences, see *Powering ON a Domain*, on page 3-15 and *Powering OFF a Domain*, on page 3-18.

Preparing Server Domains for Remote Access via the Enterprise LAN



CAUTION:

Access to the local / integrated console should be restricted to **Customer / Support Administrators and Operators ONLY** to avoid inadvertent damage to software and/or hardware components.



Note:

Required networking data is indicated in the *Read Me First* document delivered with the server and is also recorded under the corresponding PAM **Domain Identity**. Customer Administrator rights are required for all PAM configuration tasks.

Microsoft Windows Domain

1. Toggle the integrated console to the corresponding Windows domain port. See *Toggling the Local / Integrated Console Display*, on page 2-8.
2. From the Windows desktop, right click **My Computer** and select **Properties** → **Remote**.
3. Check the **Allow remote connection** box.
4. Share the **<system root>\system32\clients\tsclient** directory via the Explorer.
5. Toggle the integrated console to the PAP unit port.
6. From the Customer Administrator PAM tree, click **Configuration Tasks** → **Domains** → **Identities** to open the **Identities** page.
7. Select the corresponding Windows domain from the list and click **Edit** to open the **Edit an Identity** dialog.
8. Check that the **Network Name**, **IP Address**, and **URL** fields are completed. If not, complete these fields with the networking data entered during the Windows setup completion procedure and click **OK**.

Linux Redhat Domain

1. Toggle the integrated console to the corresponding Linux domain port. See *Toggling the Local / Integrated Console Display*, on page 2-8.
2. From the Linux desktop, enable remote connection via **telnet**, **rlogin**, **ftp**, ...:
3. From the PAP unit Internet Explorer or Mozilla browser, enter the Webmin URL: **http://<networkname>:10000**, where **<networkname>** is the network name given to the server domain during the Linux setup completion procedure. The **Login to Webmin** dialog box opens.
4. Click the **Networking** icon. The **Networking** main page opens.
5. Click **Extended Internet Services** to display the list of available services.
6. From the service list, check that **Yes** is displayed in the status column. If **No** is displayed in the status column, proceed as follows to enable the service:
 - a. Select the required service from the list.
 - b. Complete the fields accordingly.
 - c. Click **Yes** after **Service enabled?**
 - d. Click **Save**.
7. Repeat step 3 for each required service.

8. Click **Apply changes** to apply all changes.
9. Click **Return to index**.
10. Click **Log Out** to exit **Webmin**.
11. Toggle the integrated console to the PAP unit port.
12. From the Customer Administrator PAM tree, click **Configuration Tasks** → **Domains** → **Identities** to open the **Identities** page.
13. Select the corresponding Windows domain from the list and click **Edit** to open the **Edit an Identity** dialog.
14. Check that the **Network Name**, **IP Address**, and **URL** fields are completed. If not, complete these fields with the networking data entered during the Windows setup completion procedure and click **OK**.

Linux SuSE Domain

1. Toggle the integrated console to the corresponding Linux domain port. See *Toggling the Local / Integrated Console Display*, on page 2-8.
2. From the Linux desktop, enable remote connection via **telnet**, **rlogin**, **ftp**, ...:
3. Launch the **yast2** command to open the **Yast Control Center** screen.
4. Click the **Network/Basic** icon in the left pane.
5. Click **Start/stop services (inetd)**.
6. From the **Network Services** page, select **On with customer configuration** and click **Next** to open the **Enable/disable network services** page.
7. From the service list, check that **Active** is displayed in the status column. Proceed as follows to enable the service:
 - a. Select the required service from the list.
 - b. Click **Activate**.
8. Repeat step 5 for each required service.
9. Click **Finish** to apply all changes.
10. Click **Close** to exit **yast2**.
11. Toggle the integrated console to the PAP unit port.
12. From the Customer Administrator PAM tree, click **Configuration Tasks** → **Domains** → **Identities** to open the **Identities** page.
13. Select the corresponding Windows domain from the list and click **Edit** to open the **Edit an Identity** dialog.
14. Check that the **Network Name**, **IP Address**, and **URL** fields are completed. If not, complete these fields with the networking data entered during the Windows setup completion procedure and click **OK**.

Preparing Server Domains for Remote Access via the Web



CAUTION:

Remote access via the Web is a potential security hazard. Customers are strongly advised to protect their systems with up-to-date protection devices such as virus-prevention programs and firewalls, and to maintain a detailed record of authorized users.

Microsoft Windows Domain

1. Toggle the integrated console to the corresponding Windows domain port. See *Toggling the Local / Integrated Console Display*, on page 2-8.
2. Left click **Start** → **Control Panel** → **Add or Remove Programs**.
3. Select **Add / Remove Windows Components**.
4. Click **Web Application Services** → **Details** → **Internet Information Services** → **Details** → **World Wide Web Services** → **Details** → **Remote Desktop Web Connection**. Validate where required by clicking **OK** or **Next**.
5. Insert the the Microsoft Windows CD-ROM in the CD-ROM / DVD drive.
6. The Microsoft Windows setup wizard is launched automatically and guides you through the setup completion procedure.
7. Toggle the integrated console to the PAP unit port.
8. From the Customer Administrator PAM tree, click **Configuration Tasks** → **Domains** → **Identities** to open the **Identities** page.
9. Select the corresponding Windows domain from the list and click **Edit** to open the **Edit an Identity** dialog.
10. Check that the **Network Name**, **IP Address**, and **URL** fields are completed. If not, complete these fields with the networking data entered during the Windows setup completion procedure and click **OK**.

Linux Domain

Virtual Network Computing (VNC) remote control software allows users to interact with the server from a remote computer via Internet.

The server domain is ready for remote connection.

1. Toggle the integrated console to the PAP unit port.
2. From the Customer Administrator PAM tree, click **Configuration Tasks** → **Domains** → **Identities** to open the **Identities** page.
3. Select the corresponding Linux domain from the list and click **Edit** to open the **Edit an Identity** dialog.
4. Check that the **Network Name**, **IP Address**, and **URL** fields are completed. If not, complete these fields with the networking data entered during the Linux setup completion procedure and click **OK**.

Connecting to a Server Domain via the Enterprise LAN

Microsoft Windows Domain

1. Check that **Client for Microsoft Networks** is installed on the remote computer and that the remote computer is connected to the same LAN as the server domain.
2. Check that **Client for Remote Desktop** is installed on the remote computer. If the **Remote Desktop Connection** menu does not exist:
 - a. Click **Start** → **Run**.
 - b. Type `\\<networkname>\tsclient\win32\setup.exe` in the box, where `<networkname>` is the network name given to the server domain during the Windows setup completion procedure.
3. Connect to the server domain by running:
 - a. Microsoft Windows XP (and later):
All Programs → **Accessories** → **Communication** → **Remote Desktop Connection**.
 - b. All other versions of Microsoft Windows:
Programs → **Remote Desktop Connection** → **OK**.
4. Type **Administrator** (default administrator user name) in the **User name** field.
5. Type the administrator password defined during the Windows setup completion procedure in the **Password** field.
6. The remote computer connects to the server domain.

Linux Domain

1. Enter the following command:
ssh <networkname> -l user_name, where `<networkname>` is the network name given to the server domain during the Linux setup completion procedure.
2. The remote computer connects to the server domain.

Connecting to the Server via the Web

Microsoft Windows Domain

1. Check that **Internet Explorer** (6 or later) and **Terminal Server Client** are installed on the remote computer.
2. Launch the Internet Explorer or Netscape browser and connect to the server desktop, url: **http://<networkname>/tsweb/**, where **<networkname>** is the network name given to the server domain during the Windows setup completion procedure. See the *Read Me First* document delivered with the server.

Linux Domain

Virtual Network Computing (VNC) remote control software allows users to interact with the server from a remote computer via Internet.

1. Check that **VNC Server** is installed.
2. Execute the **vncpasswd** command to initialize the password.
3. Execute the **vncserver** command to start the process.
4. Record the **<networkname>** display number for the remote computer, where **<networkname>** is the network name given to the server domain during the Linux setup completion procedure.

Chapter 3. Managing Domains

This chapter explains how, as Customer Administrator and/or Customer Operator, you can manage server domains. It includes the following topics:

- Introducing PAM Domain Management Tools, on page 3-2
- Managing Domain Schemes, on page 3-6
- Powering On a Domain, on page 3-15
- Powering Off a Domain, on page 3-18
- Manually Resetting a Domain, on page 3-21
- Forcing a Domain Power Off, on page 3-24
- Performing a Domain Memory Dump, on page 3-27
- Viewing Domain Functional Status, on page 3-30
- Viewing Domain Power Logs, on page 3-31
- Viewing Domain Powering Sequences, on page 3-32
- Viewing Domain BIOS Info, on page 3-33
- Viewing Domain Request Logs, on page 3-34
- Viewing Domain Configuration, Resources and Status, on page 3-35
- Modifying Domain Configuration, on page 3-42
- What to Do if an Incident Occurs, on page 3-56



Note:

Customer Administrators and Customer Operators are respectively advised to consult the *Administrator's Memorandum*, on page xxvi or the *Operator's Memorandum*, on page xxviii for a detailed summary of the everyday tasks they will perform.

For further information about user accounts and passwords, see *Setting up PAP Unit Users*, on page 5-22.



Important:

Certain domain configuration and management tools are reserved for use with partitioned servers and extended systems. Please contact your Bull Sales Representative for sales information.

Introducing PAM Domain Management Tools



Important:

Certain domain configuration and management tools are reserved for use with partitioned servers and extended systems. Please contact your Bull Sales Representative for sales information.

A Bull NovaScale Server domain englobes all the hardware and software resources managed by an Operating System instance.

NovaScale 5xx0 Servers are designed to operate as single SMP systems and are delivered with one pre-configured domain.

NovaScale 6xx0 Servers are designed to operate as one, two, three or four hardware-independent SMP systems or domains, each running an Operating System instance and a specific set of applications.

The PAM **Domain Manager** is at the heart of server operation. Customer Administrators and Operators have equal access rights to **Domain Manager** functions and the Control pane is frequently used during operation. The **Domain Manager** Control pane gives access to all domain commands and domain details.

What You Can Do

Via the **Domain Manager** Control pane, you can:

- *Manage domain schemes*
- *Power on a domain*
- *Powering off a domain*
- *Perform a domain reset*
- *Perform a domain force power off*
- *Request a domain memory dump*
- *View functional status*
- *View power logs*
- *View powering sequences*
- *View BIOS info*
- *View request logs*
- *View domain configuration, resources and status*



Note:

Access to certain hardware resources, such as system disks can be limited by using the **Exclusion / Inclusion** function. See *Limiting Access to Hardware Resources*, on page 5-79 and *Excluding / Including Hardware Elements*, on page 4-22. This function must be used with care.

NovaScale 5xx0 Server Domain Manager Control Pane

From the PAM Tree, click **Domain Manager** to open the **Control** pane.

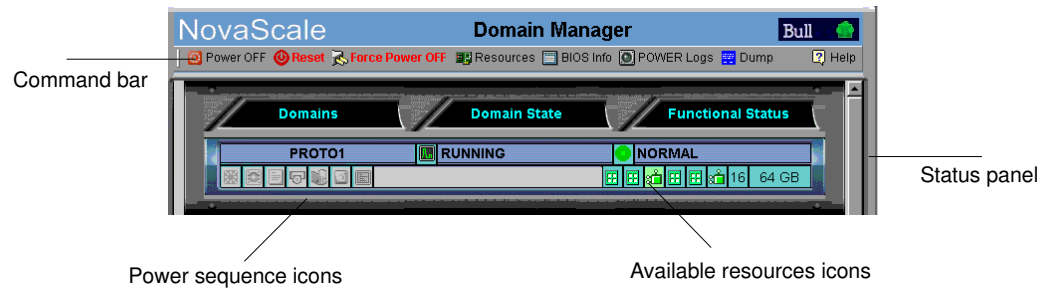

Command Bar	
<i>Power ON</i>	see details on page 3-15
<i>Power OFF</i>	see details on page 3-18
<i>Force Power OFF</i>	see details on page 3-24
<i>Reset</i>	see details on page 3-21
<i>Dump</i>	see details on page 3-27
<i>Resources, BIOS Info, Power Logs</i>	see details on page 3-31

Status Panel	
Domain Identity	The name given to the domain cellblock (configured during installation).
Domain State	Power ON/OFF state. See <i>Powering ON a Domain</i> , on page 3-15 and <i>Powering OFF a Domain</i> , on page 3-18.
Functional Status	Status of the last action performed on the domain. See <i>Viewing Domain Functional Status</i> , on page 3-30.
Power sequence	Icons representing domain power ON/OFF steps. See <i>Powering ON a Domain</i> , on page 3-15 and <i>Powering OFF a Domain</i> , on page 3-18.
Available resources	Icons representing domain resources (QBBs, IOBs, CPUs, memory). See <i>Viewing Domain Hardware Resources</i> , on page 3-35.

Figure 46. NovaScale 5xx0 Server PAM Domain Manager tools

NovaScale 6xx0 Server Domain Manager Control Pane

From the PAM Tree, click **Domain Manager** to open the **Control** pane.

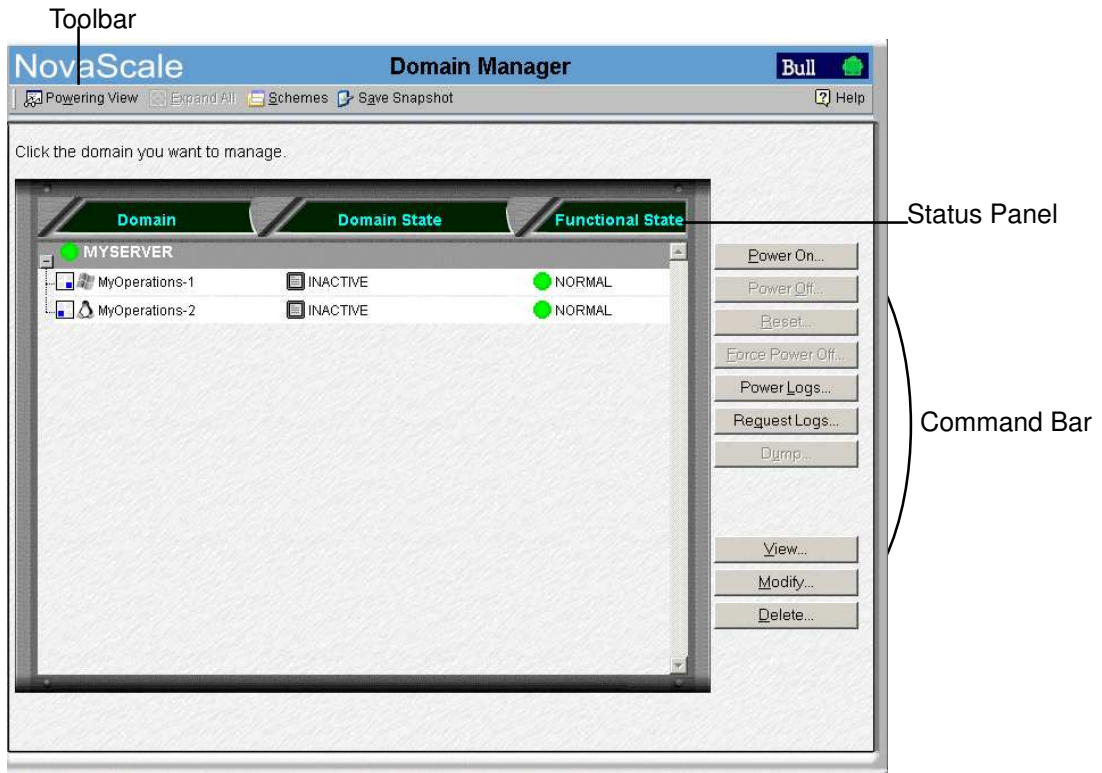

Toolbar	
Powering View	Dynamically displays domain power sequences and gives access to Power Logs , see details on page 3-31 and BIOS Info , see details on page 3-33.
Expand All	Expands the list of domains included in the current Scheme .
Schemes	Loads a selected scheme and displays Scheme Properties , see details on page 3-9.
Save Snapshot	Saves current domain configuration as a new scheme for future use, see details on page 3-12.
Status Panel	
Domain Identities	The names given to clearly identify domains, see details on page 5-33.
Domain State	Power sequence state. See <i>Powering ON a Domain</i> , on page 3-15 and <i>Powering OFF a Domain</i> , on page 3-18.
Functional Status	Status of the last action performed on a domain. See <i>Viewing Domain Functional Status</i> , on page 3-30.

Command Bar	
Power On	Powers on the selected domain, see details on page 3-15.
Power Off	Powers off the selected domain, see details on page 3-18.
Reset	Resets the selected domain, see details on page 3-21.
Force Power Off	Forcibly powers off the selected domain, see details on page 3-24.
Power Logs	Displays power sequence logs, see details on page 3-31.
Request Logs	Displays Power On, Power Off, and Reset requests and requestors, see details on page 3-34.
Dump	Performs a domain memory dump, see details on page 3-27.
View	Displays Domain Resources , see details on page 3-35 and BIOS Info , see details on page 3-33 and gives access to the Domain Modification dialog, see details on page 3-42.
Modify	Used to change current domain settings, see details on page 3-42.
Delete	Removes the selected domain from the current scheme, see details on page 3-53.

Table 7. NovaScale 6xx0 Server PAM Domain Manager tools

Managing Domain Schemes



Important:

Reserved for partitioned servers and extended systems. Please contact your Bull Sales Representative for sales information.

What You Can Do

- *View a domain scheme*
- *Load a domain scheme*
- *Add a domain scheme*
- *Replace a domain scheme*
- *Save a domain scheme snapshot*

A **Domain Scheme** is the template or configuration file used to define and manage a set of domains that can be active simultaneously. For easy configuration and optimum use of the physical and logical resources required for simultaneous operation, domains are defined via the **PAM Domain Scheme** wizard.



Note:

Server components and configuration may differ according to site requirements.

NovaScale 6080/6160 Servers

NovaScale 6080/6160 Servers are designed to operate as one or two hardware-independent domains. Servers are delivered with a pre-configured Scheme called **MyOperationsScheme** containing one or two domains, **MyOperations-1** and **MyOperations-2**, allowing you to manage and administer all server resources.

NovaScale 6320 Server

The NovaScale 6320 Server is designed to operate as one, two, three or four hardware-independent domains. The server is delivered with a pre-configured Scheme called **MyOperationsScheme** containing one to four domains, **MyOperations-1**, **MyOperations-2**, **MyOperations-3** and **MyOperations-4**, allowing you to manage and administer all server resources.

An Operating System instance is pre-installed on each domain boot disk (EFI LUN). According to your requirements, identical or different Operating System instances may be installed on each EFI LUN. A brief summary of the organization of physical and logical resources in **MyOperationsScheme** is given in *MyOperationsScheme Organization*, on page 3-13.



Note:

As Customer Administrator, you may configure other Schemes for domain management. For further details about domain configuration options, see *Configuring Domains*, on page 5-33.

To power on server domains, you must first load the required **Domain Scheme** from the **Domain Manager** Control pane. Once the domain scheme has been loaded, domains can be powered up simultaneously or independently.

Viewing a Domain Scheme

Before loading a domain scheme, you may want to know more about its scope.

To view a Scheme:

1. Click **Domain Manager** to open the Control pane.
2. Click **Schemes** in the Toolbar to open the **Schemes List** dialog.

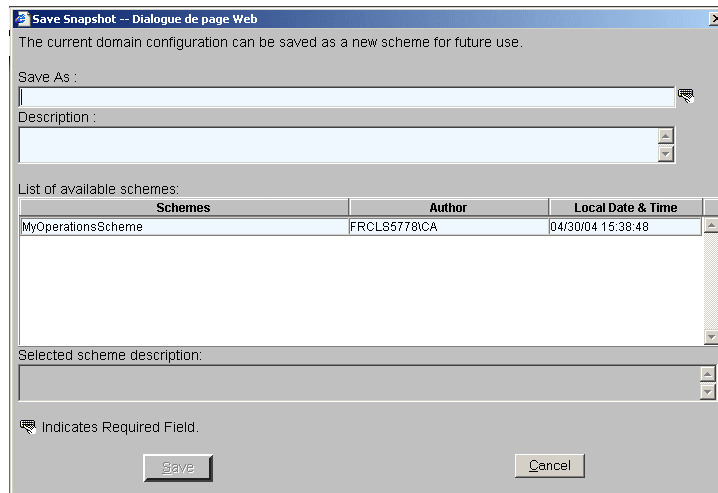
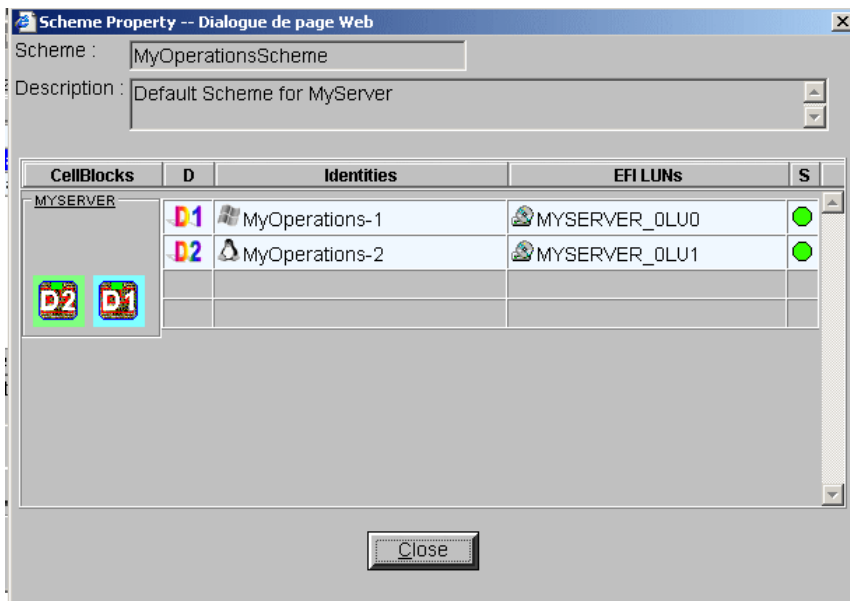

Figure 47. Domain schemes list dialog

3. Select the required **Scheme** from the list and click **Preview** to view Scheme properties.

NovaScale 6080/6160 Server



NovaScale 6320 Server

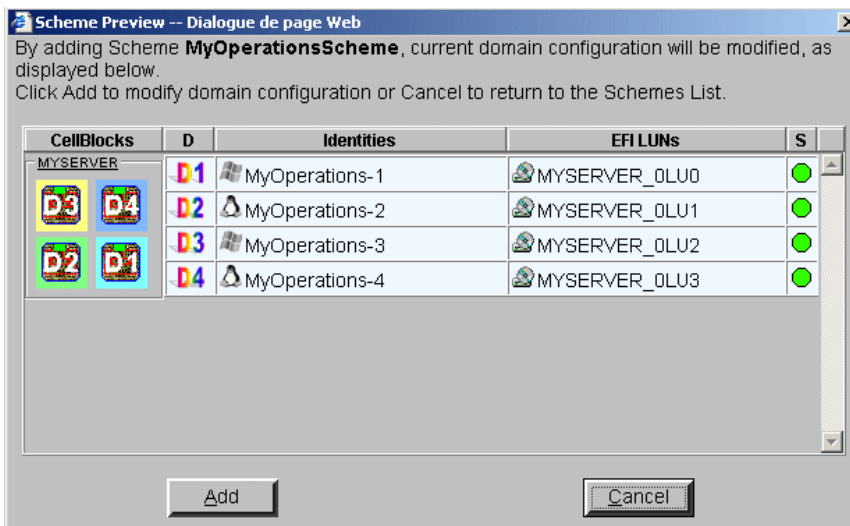

CellBlocks	Shows the Central Subsystems included in the Scheme and how they are partitioned into domains.
D	Identifies physical partitions.
Identities	Shows the Identities allocated to each domain.
EFI LUNs	Indicates the EFI LUNs used to boot each domain.
S	Indicates domain configuration status. A Green status icon indicates that the domain is configured correctly and is ready for use, a Red status icon indicates that the domain is not configured correctly and is not ready for use. If the status icon is Red, see <i>Configuring Domains</i> , on page 5-33.

Figure 48. Scheme property dialog

Loading a Domain Scheme

To power on server domains, you must first load the required **Domain Scheme** from the **Domain Manager** Control pane. Once the domain scheme has been loaded, domains can be powered up simultaneously or independently.

To load a Scheme:

1. Click **Domain Manager** to open the Control pane. If a Domain Scheme has not been previously loaded, you are invited to load a Scheme.



Note:

If the required Scheme is already loaded, it is available for domain management. If a Scheme is already loaded, but is not the required Scheme, see *Adding a Domain Scheme* and *Replacing a Domain Scheme* below.

2. Click **Schemes** in the Toolbar to open the **Schemes List** dialog.

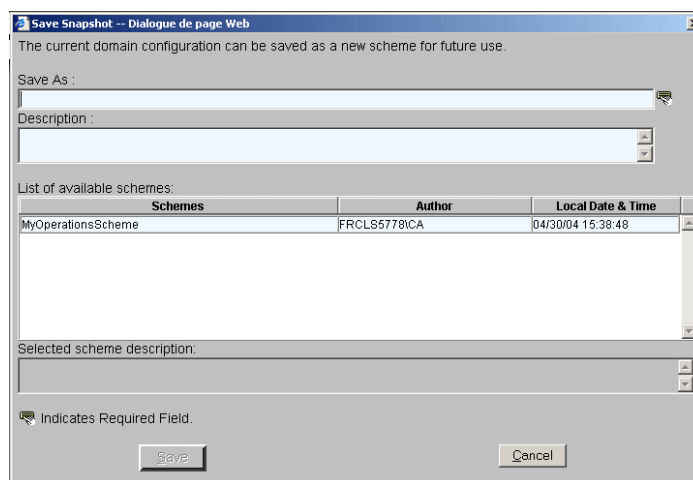
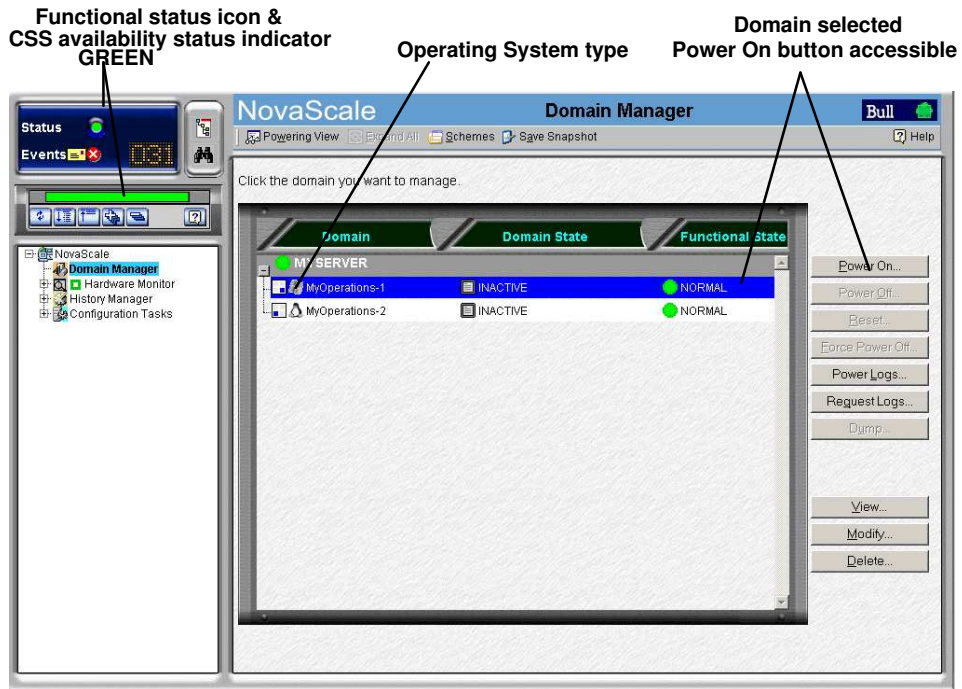

Figure 49. Domain schemes list dialog

3. Select the required **Scheme** from the list and click **Preview** to view Scheme properties. See *Viewing Domain Schemes*, on page 3-7.
4. Click **Apply**. A dialog box informs you that the selected Scheme will replace the current domain configuration.
5. Click **Yes** to confirm. All the domains included in the selected Scheme are loaded in the Control pane and are available for management.

If the domains are ready to be powered up, **INACTIVE** is displayed in the **Domain State** boxes. The **Power On** button becomes accessible once a domain has been selected.

NovaScale 6080/6160 Server



NovaScale 6320 Server

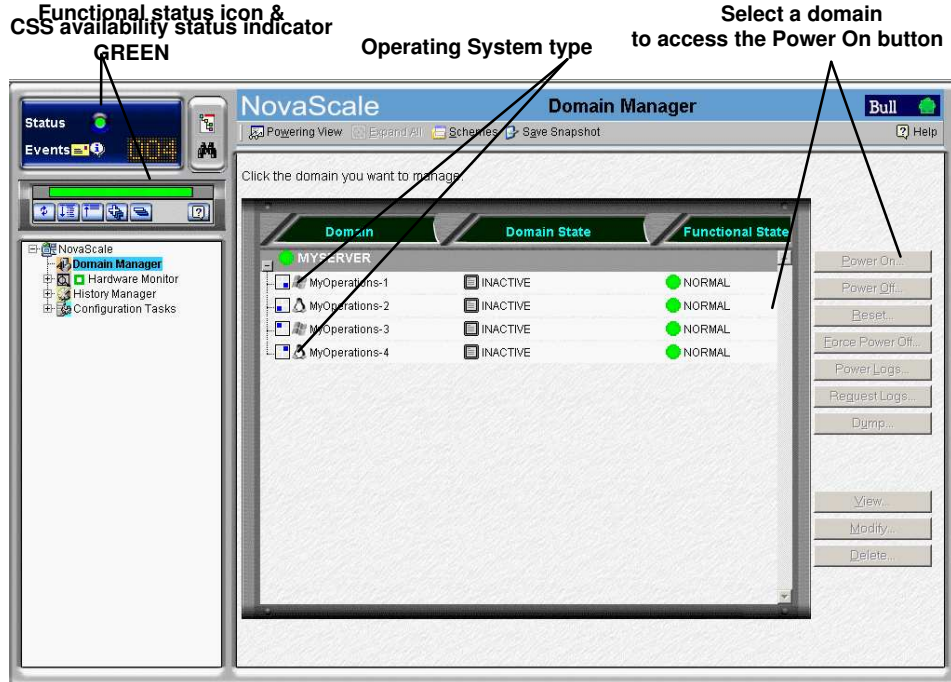

Figure 50. Domain Manager control pane

Adding a Domain Scheme to the Current Domain Scheme

A Scheme can include domains from one or more Central Subsystems. More domains can be made available for domain management by adding one or more Schemes to the current domain configuration.

Notes:

- New domains must only include resources that are not used by the current Scheme.
- New domains must be configured via **Configuration Tasks** before they are available for domain management. For further details, see *Configuring Domains*, on page 5-33.

To add a Scheme:

1. Click **Domain Manager** to open the Control pane.
2. Click **Schemes** in the Toolbar to open the **Schemes List** dialog.
3. Select the required **Scheme** from the list and click **Preview** to view Scheme properties. See *Viewing Domain Schemes*, on page 3-7.
4. Click **Add**. All the domains included in the **Scheme** added are now available for management in the Control pane.

Replacing the Current Domain Scheme

Note:

All domains must be **INACTIVE** before the current Scheme can be replaced.

To replace the current Scheme:

1. Click **Domain Manager** to open the Control pane.
2. Check that all domains are **INACTIVE**. If a domain is not **INACTIVE**, it must be powered down before the current Scheme can be replaced. See *Powering OFF a Domain*, on page 3-18.
3. If required, save the current domain configuration. See *Saving the Current Domain Scheme Snapshot*, on page 3-12.
4. Click **Schemes** in the Toolbar to open the **Schemes List** dialog.
5. Select the required **Scheme** from the list and click **Preview** to view Scheme properties. See *Viewing Domain Schemes*, on page 3-7.
6. Click **Apply**. A dialog box informs you that the selected Scheme will replace the current domain configuration.
7. Click **Yes** to confirm. All the domains included in the selected Scheme are loaded in the Control pane and are available for management.

Saving the Current Domain Scheme Snapshot

You may want to save the current **Scheme Snapshot**, in particular if more than one Scheme has been loaded and/or if you have modified domain configuration. When you save the Scheme Snapshot, you create a new Scheme which is then available for domain management.

To save the current Scheme Snapshot:









1. Click **Domain Manager** to open the Control pane.
2. Click **Save Snapshot**. The **Save Snapshot** dialog opens.

Schemes	Author	Local Date & Time
MyOperationsScheme	FRCLS5778\CA	04/30/04 15:38:48

Figure 51. Save Snapshot dialog

3. Enter a name and description for the new Scheme and click **Save**. The **Snapshot** is now available as a Scheme for domain management. For further details, see *Configuring Domains*, on page 5-33.

MyOperationsScheme Organization – NovaScale 6xx0 Servers

Domain Identity: MyOperations–1	
Hardware Cell	Cell_0
Operating System (customer–specific)	 Windows or  Linux
EFI LUN**	*<MyServer>_0LU0
IOB	Module0_IOB0
QBBs	Module0_QBB0, Module0_QBB1
Domain KVM Ports	***CSS0_Mod0_IO0
Domain Identity: MyOperations–2	
Hardware Cell	Cell_1
Operating System (customer–specific)	 Windows or  Linux
EFI LUN**	*<MyServer>_0LU1
IOB	Module0_IOB1
QBBs	Module0_QBB2, Module0_QBB3
Domain KVM Ports	***CSS0_Mod0_IO1
Domain Identity: MyOperations–3 (NovaScale 6320 Server)	
Hardware Cell	Cell_2
Operating System (customer–specific)	 Windows or  Linux
EFI LUN**	*<MyServer>_0LU2
IOB	Module1_IOB0
QBBs	Module1_QBB0, Module1_QBB1
Domain KVM Ports	***CSS0_Mod1_IO0
Domain Identity: MyOperations–4 (NovaScale 6320 Server)	
Hardware Cell	Cell_3
Operating System (customer–specific)	 Windows or  Linux
EFI LUN**	*<MyServer>_0LU3
IOB	Module1_IOB1
QBBs	Module1_QBB2, Module1_QBB3
Domain KVM Ports	***CSS0_Mod1_IO1

* <MyServer> = default server name, e.g.: NS6080–0, NS6160–0, NS6320–0

** EFI LUN: xLUx = boot LUN device location (*ModxLUIOx*):

0LU0 = LUN device connected to Module0, IOB0

0LU1 = LUN device connected to Module0, IOB1

0LU2 = LUN device connected to Module1, IOB0

0LU3 = LUN device connected to Module1, IOB1

***CSSx = CSS number, Modx = Module number, IOx = IO box number



Operating System type is indicated by the Microsoft Windows  or Linux  logo in the **Domain Identities** box.

Table 8. MyOperations Scheme organization

 **Notes:**

- In the screen shots, tables, and examples in this guide:
 - **MyOperationsScheme–xx** is referred to as **MyOperationsScheme**
 - **MyOperations–xx–1** is referred to as **MyOperations–1**
 - **MyOperations–xx–2** is referred to as **MyOperations–2**
 - **MyOperations–xx–3** is referred to as **MyOperations–3**
 - **MyOperations–xx–4** is referred to as **MyOperations–4**
- **xx** in the default Scheme and domain names represents the Central Subsystem HW identifier (from 00 to 16). For further details, refer to *PMB Code Wheel Settings*, on page 4-45.

Powering On a Domain

What You Can Do

During the domain power-on sequence, you can:

- *View functional status*
- *View power logs*
- *View powering sequences*
- *View BIOS info*
- *View request logs*
- *View domain configuration, resources and status*



Important:

Certain domain configuration and management tools are reserved for use with partitioned servers and extended systems. Please contact your Bull Sales Representative for sales information.

Once connected to the Customer's site power supply, the server initializes to the stand-by mode and the integrated PAP unit powers up. The server is not equipped with a physical power button and server domains are powered up from the PAM **Domain Manager** Control pane.

Check server functional status via the PAM **Status Pane**. If functional status is normal and the **CSS Availability** bar is green, server domains can be powered up.



Note:

Server domains may be powered up even if the server presents a minor fault. See *System Functional Status*, on page 4-4. However, you are advised to contact your Customer Service Engineer so that the fault can be repaired.

To power up a domain, see:

- NovaScale 5xx0 Servers, on page 3-16
- NovaScale 6xx0 Servers, on page 3-17

NovaScale 5xx0 Servers

1. Click **Domain Manager** to open the Control pane.
2. Select the domain. If the domain is in the stand-by mode, **INACTIVE** is displayed in the **Domain Status** panel and the **Power ON** button is accessible.



Important:

If **INACTIVE** is not displayed in the **Domain Status** panel and the **Power ON** button is not accessible, check whether another user has already launched the power-up sequence on this domain. If the power-up sequence is not already in progress, see **What To Do if an Incident Occurs**, on page 3-56.

3. Click **Power ON** to power up the domain and associated hardware components. The **Power On Confirmation** dialog opens.
4. Select the **View Power-On Logs** checkbox if you want power-on logs to be automatically displayed during the power-on sequence and click **Yes** to confirm.

Domain hardware is powered up from the stand-by mode to the main mode and the Operating System is booted. As the power-on sequence progresses, the **Power Sequence** icons sequentially light up and power-on steps and domain state are displayed in the **Domain Status** panel, as shown in the following table.

Domain States	Power-on Steps
Power ON command	Powering up Domain hardware is powered up from stand-by mode to main mode. Once domain hardware has been powered up, Powered ON is displayed in the Domain Status panel and the Reset and Force Power OFF buttons become accessible.
POWERED ON	BIOS loading
BIOS READY	Starting EFI
EFI STARTED	EFI running
RUNNING	Operating System started

Table 9. Power-on states and steps

Once the **Power ON** sequence has been successfully completed, **RUNNING** is displayed in the **Domain Status** panel and the **Power OFF**, **Reset** and **Force Power OFF** buttons become accessible.



Note:

If an error message is displayed in the **Domain Status** panel, the **Power ON** sequence has failed. See *What To Do if an Incident Occurs*, on page 3-56.

NovaScale 6xx0 Servers

1. Click **Domain Manager** to open the Control pane. If the required Domain Scheme is already loaded, the corresponding domain(s) are available for domain management. Loaded domains can be powered up simultaneously. Go to Step 2.



Notes:

- If a Scheme has not been previously loaded, you are invited to select and load a Scheme. See *Viewing Domain Schemes*, on page 3-7 and *Loading a Domain Scheme*, on page 3-9.
 - If a Scheme is already loaded, but is not the required Scheme, see *Adding a Domain Scheme* and *Replacing a Domain Scheme*, on page 3-11.
2. Select the required domain. If the domain is in the stand-by mode, **INACTIVE** is displayed in the **Domain Status** panel and the **Power On** button is accessible.



Important:

If **INACTIVE** is not displayed in the **Domain Status** panel and the **Power On** button is not accessible, check whether another user has already launched the power-up sequence on this domain. If the power-up sequence is not already in progress, see *What To Do if an Incident Occurs*, on page 3-56.

3. Click **Power On** to power up the domain and associated hardware components. The **Power On Confirmation** dialog opens.
4. Select the **View Power-On Logs** checkbox if you want power-on logs to be automatically displayed during the power-on sequence and click **Yes** to confirm.

Domain hardware is powered up from the stand-by mode to the main mode and the Operating System is booted. As the power-on sequence progresses, power-on steps and domain state are displayed in the **Domain Status** panel, as shown in the following table.

Power On States
POWERING ON
POWERED ON – LOADING BIOS
BIOS READY – STARTING EFI
EFI STARTED – BOOTING OS
RUNNING

Table 10. Power-on states

Once the **Power On** sequence has been successfully completed, **RUNNING** is displayed in the **Domain Status** panel and the **Power Off**, **Reset** and **Force Power Off** buttons become accessible.

For a detailed view of the **Power On** sequence, click **Powering View** in the Toolbar. See *Viewing Powering Sequences*, on page 3-32.

5. Repeat Steps 2 to 4 for each domain to be powered up.



Note:

If an error message is displayed in the **Domain Status** panel, the **Power On** sequence has failed. See *What To Do if an Incident Occurs*, on page 3-56.

Powering Off a Domain

What You Can Do

During the domain power-off sequence, you can:

- *View functional status*
- *View power logs*
- *View powering sequences*
- *View BIOS info*
- *View request logs*
- *View domain configuration, resources and status*

Server domains can either be powered off from the Operating System (RECOMMENDED) or from the PAM **Domain Manager**, according to Operating System power settings.

The PAM **Power Off** command is a shutdown request to the Operating System. If the Operating System is configured to accept a PAM power off request, it will save data, close open applications and shut down. Domain hardware will power down to the stand-by mode. The Operating System may also be configured to request Operator confirmation before accepting a PAM power off request. Refer to the applicable documentation delivered with the Operating System for further details.

To power off a domain from the PAM **Domain Manager**, see:

- NovaScale 5xx0 Servers, on page 3-19
- NovaScale 6xx0 Servers, on page 3-20

NovaScale 5xx0 Servers

1. Click **Domain Manager** to open the Control pane.
2. Select the domain. If the domain is in the powered-on mode, **RUNNING** is displayed in the **Domain Status** panel and the **Power OFF** button is accessible.



Important:

If **RUNNING** is not displayed in the **Domain Status** panel and the **Power OFF** button is not accessible, another user may have already launched the power-off sequence or may be working under **EFI SHELL**. If the power-off sequence is not already in progress and/or if **EFI STARTED** is not displayed in the **Domain Status** panel, see *What To Do if an Incident Occurs*, on page 3-56.

3. Click **Power OFF** to power down the domain and associated hardware components. The **Power Off Confirmation** dialog opens.
4. Select the **View Power-Off Logs** checkbox if you want power-off logs to be automatically displayed during the power-off sequence and click **Yes** to confirm.

The Operating System saves data, closes open applications and shuts down. Domain hardware is powered down from the main mode to the stand-by mode. As the power-off sequence progresses, the **Power Sequence** icons sequentially light up and power-off steps and domain state are displayed in the **Domain Status** panel, as shown in the following table.

Domain States	Power-off Steps
Power OFF command	Shutting down The Operating System saves data, closes open applications and shuts down.
POWERED OFF	Shutdown finished Domain hardware is powered down from main mode to stand-by mode. Once domain hardware has been powered down, Powered OFF is displayed in the Domain Status panel and the Power ON button become accessible.

Table 11. Power-off states and steps

Once the **Power OFF** sequence has been successfully completed, **INACTIVE** is displayed in the **Domain Status** panel and the **Power ON** button becomes accessible.



Note:

If an error message is displayed in the **Domain Status** panel, the **Power OFF** sequence has failed. See *What To Do if an Incident Occurs*, on page 3-56.

NovaScale 6xx0 Servers

1. Click **Domain Manager** to open the Control pane.
2. Select the required domain. If the domain is in the powered-on mode, **RUNNING** is displayed in the **Domain Status** panel and the **Power OFF** button is accessible.
3. Click **Power Off** to power down the domain and associated hardware components. The **Power Off Confirmation** dialog opens.
4. Select the **View Power-Off Logs** checkbox if you want power-off logs to be automatically displayed during the power-off sequence and click **Yes** to confirm.

The Operating System saves data, closes open applications and shuts down. Domain hardware is powered down from the main mode to the stand-by mode. As the power-off sequence progresses, power-off steps and domain state are displayed in the **Domain Status** panel, as shown in the following table.

Power Off States
POWERING DOWN
INACTIVE

Table 12. Power-off states

Once the **Power Off** sequence has been successfully completed, **INACTIVE** is displayed in the **Domain Status** panel and the **Power On** button becomes accessible.

For a detailed view of the **Power Off** sequence, click **Powering View** in the Toolbar. See *Viewing Powering Sequences*, on page 3-32.

5. Repeat Steps 2 to 4 for each domain to be powered down.



Note:

If an error message is displayed in the **Domain Status** panel, the **Power Off** sequence has failed. See *What To Do if an Incident Occurs*, on page 3-56.

Manually Resetting a Domain

What You Can Do

During the domain reset sequence, you can:

- *View functional status*
- *View power logs*
- *View powering sequences*
- *View BIOS info*
- *View request logs*
- *View domain configuration, resources and status*

The **Reset** command is used to restart the current Operating System without powering off/on the domain.



Warning:

The Reset command should only be used if the Operating System is not running or is not able to respond to a standard Power Off command. The Reset command may result in domain data loss and file corruption.

The Reset command does not power down domain hardware (warm reboot).

To manually reset a domain, see:

- NovaScale 5xx0 Servers, on page 3-22
- NovaScale 6xx0 Servers, on page 3-23

NovaScale 5xx0 Servers

1. Click **Domain Manager** to open the Control pane.
2. Select the domain. If **INACTIVE** is NOT displayed in the **Domain Status** panel, the **Reset** button is accessible.
3. Click **Reset** to override the Operating System and forcibly perform a warm reboot of the domain BIOS, EFI and Operating System without closing running applications and saving data. The **Reset Confirmation** dialog opens.
4. Click **Yes** to confirm the **Reset** command.

As the reset sequence progresses, the **Power Sequence** icons sequentially light up and reset steps and domain state are displayed in the **Domain Status** panel, as shown in the following table.

Domain States	Reset Steps
Reset command	Shutting down The Operating System is forcibly shut down without saving data and closing open applications and an automatic warm reboot sequence is launched.
POWERED ON	BIOS loading
BIOS READY	Starting EFI
EFI STARTED	EFI running
RUNNING	Operating System started

Table 13. Reset states and steps

Once the **Reset** sequence has been successfully completed, **RUNNING** is displayed in the **Domain Status** panel and the **Power Off**, **Reset** and **Force Power Off** buttons become accessible.



Note:

If an error message is displayed in the **Domain Status** panel, the **Reset** sequence has failed. See *What To Do if an Incident Occurs*, on page 3-56.

NovaScale 6xx0 Servers

1. Click **Domain Manager** to open the Control pane.
2. Select the required domain. If **INACTIVE** is NOT displayed in the **Domain Status** panel, the **Reset** button is accessible.
3. Click **Reset** to override the Operating System and forcibly perform a warm reboot of the domain BIOS, EFI and Operating System without closing running applications and saving data. The **Reset Confirmation** dialog opens.
4. Click **Yes** to confirm the **Reset** command.

As the reset sequence progresses, reset steps and domain state are displayed in the **Domain Status** panel, as shown in the following table.

Reset States
POWERING ON
POWERED ON – LOADING BIOS
BIOS READY – STARTING EFI
EFI STARTED – BOOTING OS
RUNNING

Table 14. Reset states

Once the **Reset** sequence has been successfully completed, **RUNNING** is displayed in the **Domain Status** panel and the **Power Off**, **Reset** and **Force Power Off** buttons become accessible.

For a detailed view of the **Reset** sequence, click **Powering View** in the Toolbar. See *Viewing Powering Sequences*, on page 3-32.

5. Repeat Steps 2 to 4 for each domain to be reset.



Note:

If an error message is displayed in the **Domain Status** panel, the **Power On** sequence has failed. See *What To Do if an Incident Occurs*, on page 3-56.

Forcing a Domain Power Off

What You Can Do

During the domain force power-off sequence, you can:

- *View functional status*
- *View power logs*
- *View powering sequences*
- *View BIOS info*
- *View request logs*
- *View domain configuration, resources and status*

The **Force Power Off** command powers down domain hardware to the standby mode independently of the Operating System. This command should only be used if the Operating System is not running or is not configured / not able to respond to a standard power off command.



Note:

A standard power off command is a shutdown request to the Operating System. Refer to the applicable documentation delivered with the Operating System for further details.

In the event of a critical fault, PAM software automatically forces a domain power off.



Warning:

The Force Power Off command may result in domain data loss and file corruption. NEVER use the Force Power Off command if a RECOVERING BIOS error message is displayed. (The BIOS recovery program automatically re-flashes the BIOS when certain problems occur during initialization).

To force a domain power off, see:

- NovaScale 5xx0 Servers, on page 3-25
- NovaScale 6xx0 Servers, on page 3-26

NovaScale 5xx0 Servers

1. Click **Domain Manager** to open the Control pane.
2. Select the domain. If the domain is powered on, the **Force Power OFF** button is accessible.
3. Click **Force Power OFF** to override the Operating System and forcibly power down the domain and associated hardware components without closing running applications and saving data. The **Force Power OFF Confirmation** dialog opens.
4. Select the **View Power-Off Logs** checkbox if you want power-off logs to be automatically displayed during the power-off sequence and click **Yes** to confirm.

Domain hardware is powered down from the main mode to the stand-by mode. As the force power-off sequence progresses, the **Power Sequence** icons sequentially light up and power-off steps and domain state are displayed in the **Domain Status** panel, as shown in the following table.

Domain States	Power-off Steps
Force Power OFF command	Shutting down The Operating System is forcibly shut down without saving data and closing open applications.
POWERED OFF	Shutdown finished Domain hardware is powered down from main mode to stand-by mode. Once domain hardware has been powered down, Powered OFF is displayed in the Domain Status panel and the Power ON button become accessible.

Table 15. Domain states / force power-off steps

Once the **Force Power OFF** sequence has been successfully completed, **INACTIVE** is displayed in the **Domain Status** panel.



Note:

If an error message is displayed in the **Domain Status** panel, the **Force Power OFF** sequence has failed. See *What To Do if an Incident Occurs*, on page 3-56.

Table 16. Force power-off error messages

NovaScale 6xx0 Servers

1. Click **Domain Manager** to open the Control pane.
2. Select the required domain. If **INACTIVE** is NOT displayed in the **Domain Status** panel, the **Force Power Off** button is accessible.
3. Click **Force Power Off** to override the Operating System and forcibly power down the domain and associated hardware components without closing running applications and saving data. The **Force Power Off Confirmation** dialog opens.
4. Select the **View Power-Off Logs** checkbox if you want power-off logs to be automatically displayed during the power-off sequence and click **Yes** to confirm.

Domain hardware is powered down from the main mode to the stand-by mode. As the force power-off sequence progresses, power-off steps and domain state are displayed in the **Domain Status** panel, as shown in the following table.

Force Power Off States
POWERING DOWN
INACTIVE

Table 17. Force power-off states

Once the **Force Power Off** sequence has been successfully completed, **INACTIVE** is displayed in the **Domain Status** panel and the **Power On** button becomes accessible.

For a detailed view of the **Force Power Off** sequence, click **Powering View** in the Toolbar. See *Viewing Powering Sequences*, on page 3-32.

5. Repeat Steps 2 to 4 for each domain to be forcibly powered down.



Note:

If an error message is displayed in the **Domain Status** panel, the **Power Off** sequence has failed. See *What To Do if an Incident Occurs*, on page 3-56.

Performing a Domain Memory Dump

The **Dump** command is used when the Operating System hangs and allows technicians to diagnose software problems by saving domain memory.



Warning:

The Dump command should only be used if the Operating System is not able to respond to a standard Power OFF command. The Dump command may result in domain data loss and file corruption.

The Dump command does not power down domain hardware (automatic warm reboot).

To perform a domain memory dump, see:

- NovaScale 5xx0 Servers, on page 3-28
- NovaScale 6xx0 Servers, on page 3-29

NovaScale 5xx0 Servers

1. Click **Domain Manager** to open the Control pane.
2. Select the domain. If **RUNNING** is displayed in the **Domain Status** panel, the **Dump** button is accessible.
3. Click **Dump** to override the Operating System and forcibly clear server core memory which will be copied to the PAP unit hard disk for analysis. The **Dump Confirmation** dialog opens.
4. Click **Yes** to confirm the **Dump** command.

The **Dump** sequence results in a warm reboot of the domain BIOS, EFI and Operating System without closing running applications and saving data.

As the dump sequence progresses, the **Power Sequence** icons sequentially light up and dump steps and domain state are displayed in the **Domain Status** panel, as shown in the following table.

Domain States	Dump Steps
Dump command	Shutting down The Operating System is forcibly shut down without saving data and closing open applications, core memory is cleared and saved to a file, and an automatic warm reboot sequence is launched.
POWERED ON	BIOS loading
BIOS READY	Starting EFI
EFI STARTED	EFI running
RUNNING	Operating System started

Table 18. Dump states and steps

Once the **Dump** sequence has been successfully completed, **RUNNING** is displayed in the **Domain Status** panel and the **Power Off**, **Reset** and **Force Power Off** buttons become accessible.



Note:

If an error message is displayed in the **Domain Status** panel, the **Dump** sequence has failed. See *What To Do if an Incident Occurs*, on page 3-56.

NovaScale 6xx0 Servers

1. Click **Domain Manager** to open the Control pane.
2. Select the required domain. If **RUNNING** is displayed in the **Domain Status** panel, the **Dump** button is accessible.
3. Click **Dump** to override the Operating System and forcibly clear domain core memory which will be copied to the PAP unit hard disk for analysis. The **Dump Confirmation** dialog opens.
4. Click **Yes** to confirm the **Dump** command.

The **Dump** sequence results in a warm reboot of the domain BIOS, EFI and Operating System (without closing running applications and saving data).

As the dump sequence progresses, dump steps and domain state are displayed in the **Domain Status** panel, as shown in the following table.

Dump States
POWERING ON
POWERED ON – LOADING BIOS
BIOS READY – STARTING EFI
EFI STARTED – BOOTING OS
RUNNING

Table 19. Dump states

Once the **Dump** sequence has been successfully completed, **RUNNING** is displayed in the **Domain Status** panel and the **Power Off**, **Reset** and **Force Power Off** buttons become accessible.

5. Repeat Steps 2 to 4 for each domain on which you want to perform a memory dump.

 **Note:**

If an error message is displayed in the **Domain Status** panel, the **Dump** sequence has failed. See *What To Do if an Incident Occurs*, on page 3-56.

Viewing Domain Functional Status

The **Domain Functional Status** indicator in the **Domain Manager** Control pane shows the functional status of the last action performed on each domain, e.g. if the last **Power ON/OFF** sequence was successful, the indicator is green.

As Customer Administrator, you can toggle the **PAM Tree** to display the synthetic functional status (round, colored indicator next to the **Domain Manager** node) of all the domains loaded in the **Domain Manager** Control pane , e.g. if the last **Power ON/OFF** sequence was successful on all domains, the indicator is green; if the last **Power ON/OFF** sequence failed on at least one domain, the indicator is red. See PAM Status Pane, on page 2-6.

Table 20 explains possible domain functional status indications.





Indicator	Status	Explanation
 Green	NORMAL	Control Pane The last command on this domain was successful. PAM Tree The last command on all domains was successful.
 Yellow	WARNING	Control Pane An automatic Recovery command has been launched on this domain. PAM Tree An automatic Recovery command has been launched on at least one domain. Note: The BIOS recovery program automatically re-flashes the BIOS when certain problems occur during initialization
 Orange	CRITICAL	Control Pane The last command on this domain was not successful (Timeout). PAM Tree The last command on at least one domain was not successful (Timeout).
 Red	FATAL	Control Pane The last command on this domain failed or the Operating System has been halted. PAM Tree The last command on at least one domain failed or the Operating System on at least one domain has been halted.

Table 20. Domain functional status indicators



Notes:

- The domain functional status indicator does NOT show the functional status of domain hardware. The synthetic functional status of CSS hardware is indicated by the **System Functional Status** icon in the **Status Pane**. See *Introducing PAM Software*, on page 2-5 for further details.
- When, as Customer Administrator, you are informed of a hardware incident, you can use the **PAM Hardware Monitor** to obtain CSS hardware presence / functional status details and to logically **Exclude** a redundant hardware element from the domain until it has been repaired or replaced. See *Viewing Server Hardware Status*, on page 4-12 and *Excluding/Including Hardware Elements*, on page 4-22.

Viewing Domain Power Logs

Power logs are recorded during domain power ON/OFF sequences. This information is particularly useful for troubleshooting. See *What To Do if an Incident Occurs*, on page 3-56.

During a Power ON/OFF Sequence

1. Click **Domain Manager** to open the Control pane.
2. Select the required domain and launch the domain power ON/OFF sequence, as required.
3. Select the **View Power Logs** checkbox in the **Power Confirmation** dialog to automatically display power logs during the powering sequence.

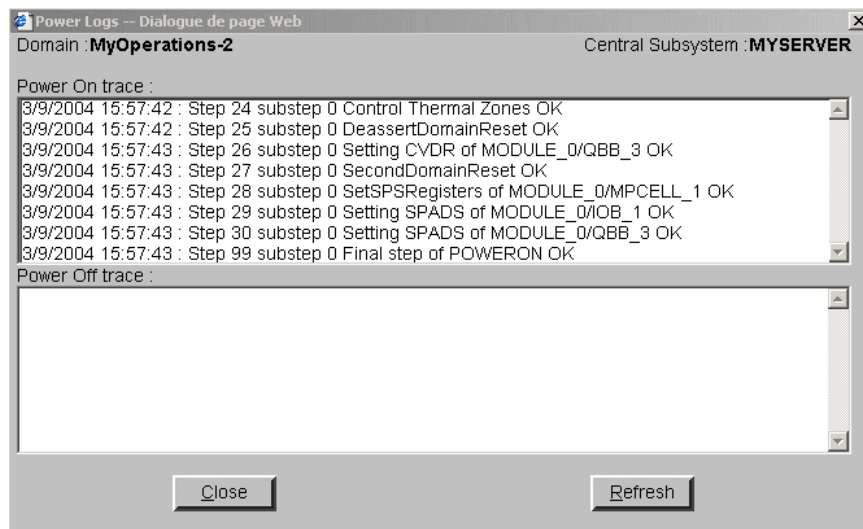

Figure 52. Power logs dialog

Outside a Power ON/OFF Sequence

NovaScale 5xx0 Servers

- Click the **Power Logs** button in the Domain Manager Command bar.

NovaScale 6xx0 Servers

- Click **Powering View** → **Power Logs** in the Domain Manager Toolbar.



Note:

Existing power logs are erased when a new power ON sequence is launched.

Viewing Domain Powering Sequences

NovaScale 5xx0 Servers

Domain powering sequence steps and states can be viewed from the **Domain Status** panel.

NovaScale 6xx0 Servers

A detailed view of powering sequences can be displayed by clicking **Powering View** in the Domain Manager Toolbar after a power request.

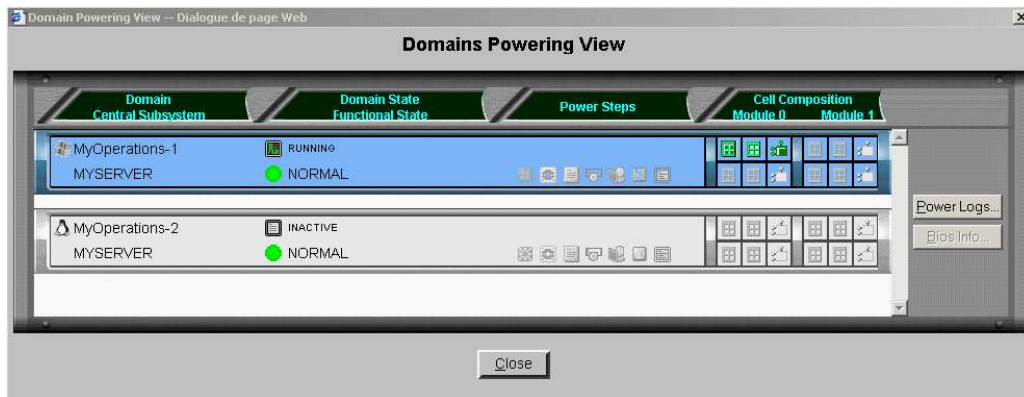

Status Panel Item	Explanation
Domain	Selected domain identity.
Central Subsystem	Name of the Central Subsystem containing the domain.
Domain State	Current power sequence step.
Functional Status	Functional status of the last action performed on the domain. See <i>Domain Functional Status Indicators</i> , on page 3-30.
Power Steps	Dynamic, graphic representation of power sequence steps.
Cell Composition	Graphic representation of the core hardware elements in each cell (hardware partition): QBB(s), IOB(s) – Master / Slave. See <i>Configuring Domain Schemes and Identities</i> , on page 5-33.

Figure 53. Powering view dialog



Note:

An Infotip can be obtained by hovering the mouse over the required element.

Viewing Domain BIOS Info

BIOS information is particularly useful for troubleshooting. See *What To Do if an Incident Occurs*, on page 3-56.

To view BIOS information:

1. Click **Domain Manager** to open the Control pane.
2. Select the required domain.
3. Click:

NovaScale 5xx0 Servers

- **View** → **BIOS Info** in the Command bar.

NovaScale 6xx0 Servers

- **Powering View** → **BIOS Info** in the Toolbar.

The **BIOS Info** dialog opens, displaying the following information:

- BIOS version used by the domain,
 - BIOS boot post codes. See *BIOS POST Codes*, on page C-1.
4. Click **Refresh** to update BIOS information.

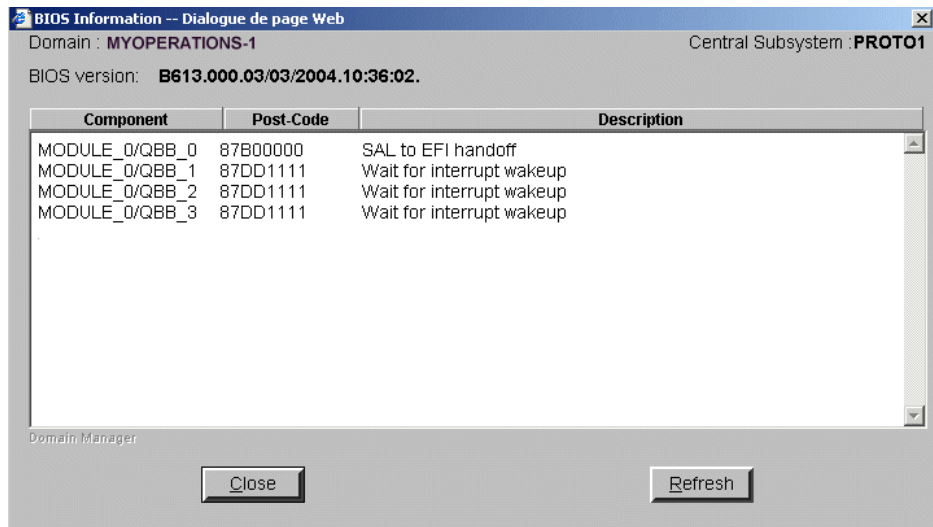

Figure 54. BIOS Info dialog

Viewing Domain Request Logs



Important:

NovaScale 6xx0 Servers ONLY. Please contact your Bull Sales Representative for sales information.

The **Request Logs** dialog gives direct access to a trace of major domain operations (requests) and indicates their initiators (requestors).

To view Request logs:

1. Click **Domain Manager** to open the Control pane.
2. Select the required domain.
3. Click **Request Logs** in the Command bar.

The **Request Logs** dialog displays the following information:

- **Power On** requests and requestors,
- **Power Off** requests and requestors,
- **Reset** requests and requestors.

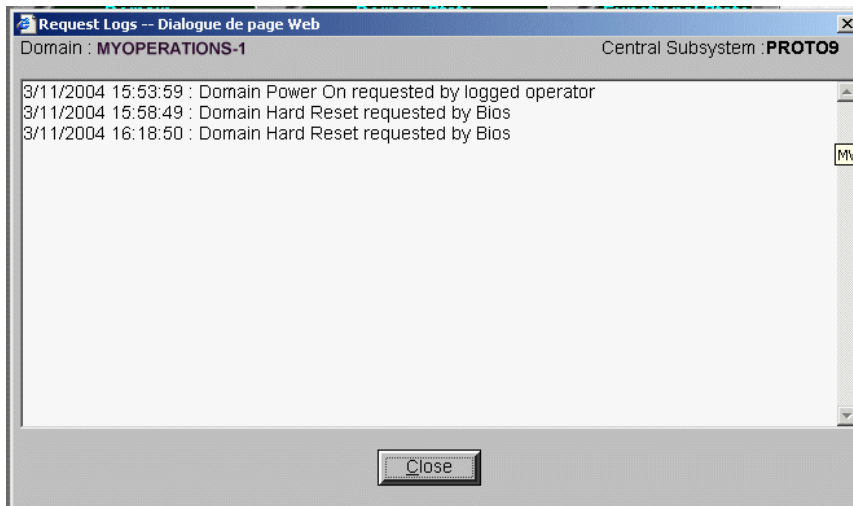

Figure 55. Request Logs dialog



Note:

Existing request logs are erased when a new power ON sequence is launched.

Viewing Domain Configuration, Resources and Status



Important:

NovaScale 6xx0 Servers ONLY. Please contact your Bull Sales Representative for sales information.



Notes:

- In the screen shots, tables, and examples in this guide:
 - **MyOperationsScheme-xx** is referred to as **MyOperationsScheme**
 - **MyOperations-xx-1** is referred to as **MyOperations-1**
 - **MyOperations-xx-2** is referred to as **MyOperations-2**
 - **MyOperations-xx-3** is referred to as **MyOperations-3**
 - **MyOperations-xx-4** is referred to as **MyOperations-4**

Information about the resources allocated to each domain is permanently accessible from the **Domain Manager** Control pane:

- Graphic representation of domain configuration.
- Non-graphic summary of the hardware resources allocated to a domain.
- Graphic summary of the hardware resources allocated to a domain and their status.

Viewing Domain Configuration

1. Click **Domain Manager** to open the Control pane.
2. Select the required domain.
3. Click **View** in the Command bar to open the **View Domain** dialog.

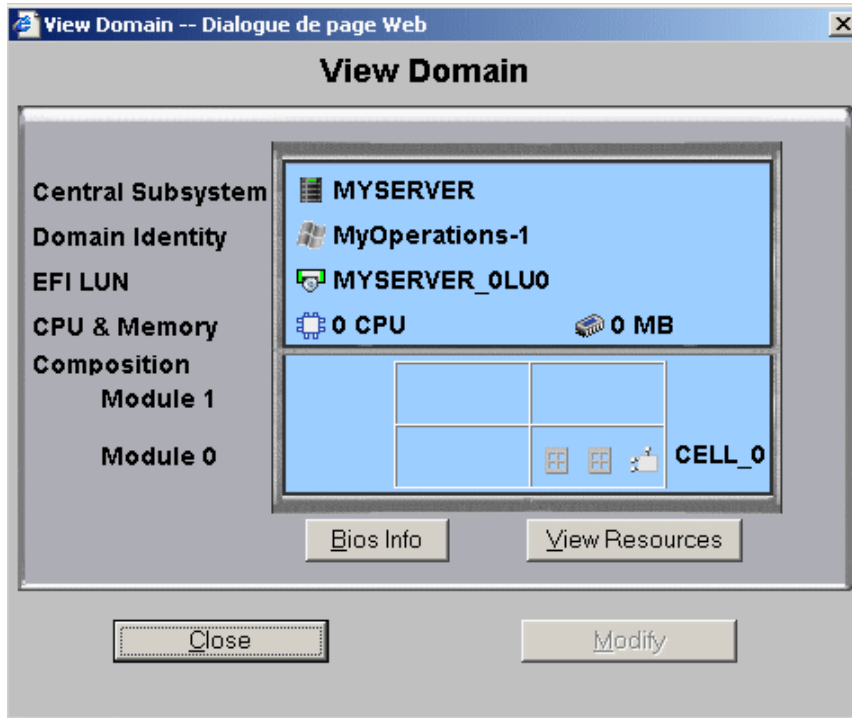

* Module 1 (Cell_2 & Cell_3): does not equip mono-module servers

Figure 56. View Domain dialog

View Domain Dialog Items

Domain Item	Explanation
Central Subsystem	Name of the Central Subsystem containing the domain.
Domain Identity	Logical name and profile given to the domain.
EFI LUN	Boot LUN device location: NovaScale 6080/6160 Server 0LU0 = LUN device connected to Module0, IOB0 0LU1 = LUN device connected to Module0, IOB1 NovaScale 6320 Server 0LU0 = LUN device connected to Module0, IOB0 0LU1 = LUN device connected to Module0, IOB1 0LU2 = LUN device connected to Module1, IOB0 0LU3 = LUN device connected to Module1, IOB1
CPU	Number of processors used by the domain.
Memory	Size of memory used by the domain.
Composition	Graphic representation of the main hardware elements used by the domain. See Note below.
Module	Module housing the cell(s) used by the domain. Module0 = Cell_0 and Cell_1 Module1 = Cell_2 and Cell_3*
Cell	Cell(s) or hardware partition(s) used by the domain. NovaScale 6080/6160 Server Cell_0 = Mod0_QBB0, Mod0_QBB1, Mod0_IOB0 Cell_1 = Mod0_QBB2, Mod0_QBB3, Mod0_IOB1 NovaScale 6320 Server Cell_0 = Mod0_QBB0, Mod0_QBB1, Mod0_IOB0 Cell_1 = Mod0_QBB2, Mod0_QBB3, Mod0_IOB1 Cell_2 = Mod1_QBB0, Mod1_QBB1, Mod1_IOB0 Cell_3 = Mod1_QBB2, Mod1_QBB3, Mod1_IOB1 See <i>Configuring Domain Schemes and Identities</i> , on page 5-33.

* Module 1 (Cell_2 & Cell_3): does not equip mono-module servers

Figure 57. View Domain dialog



Note:

When the domain is **RUNNING**, an Infotip identifying the Master QBB / IOB can be obtained by hovering the mouse over the QBB / IOB icons.

Master IOB = IOB to which the domain boot LUN device is connected.

Master QBB = QBB required to start the domain.

Viewing Domain Hardware Resources

NovaScale 5xx0 Servers

1. Click **Domain Manager** to open the Control pane.
2. Select the required domain and click **Resources** in the Command bar to open the **Domain Hardware Resources** dialog.

NovaScale 6xx0 Servers

1. Click **Domain Manager** to open the Control pane.
2. Select the required domain and click **View Resources** in the **View Domain** dialog to open the **Domain Hardware Resources** dialog.

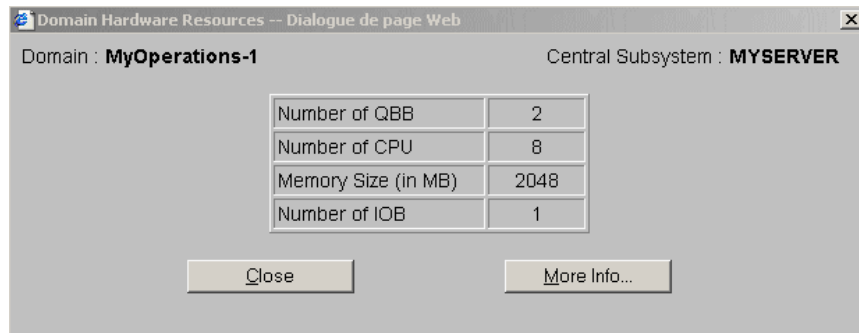

Figure 58. Domain Hardware Resources dialog

Viewing Domain Details and Status

NovaScale 5xx0 Servers

1. Click **Domain Manager** to open the Control pane.
2. Select the required domain and click **Resources** → **More Info...** in the Command bar to open the **Domain Hardware Details** dialog.

NovaScale 6xx0 Servers

1. Click **Domain Manager** to open the Control pane.
2. Click **View** → **View Resources** → **More Info...** in the Command bar to open the **Domain Hardware Details** dialog.

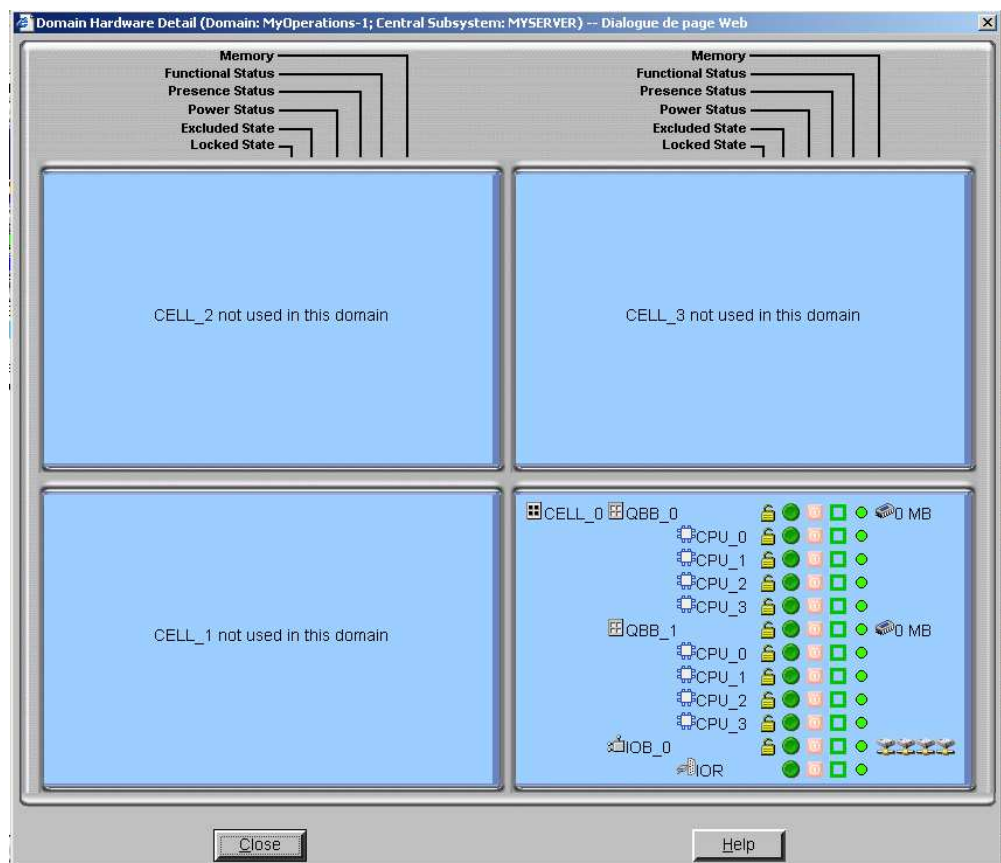

* Module 1 (Cell_2 & Cell_3): does not equip mono-module servers

Figure 59. Domain Hardware Details dialog

Domain Hardware Details icons are explained in the following table.























Item	Icon	Meaning
Memory		Memory available per QBB.
Functional Status	 Green	No problem detected, operating correctly.
	 Yellow	Minor problem reported, still operational.
	 Orange	Serious problem reported, no longer capable of operating correctly. PAM may generate an OS shutdown request.
	 Red	Major problem reported. PAM may automatically shut down the OS. System integrity is jeopardized.
	 Purple	Cannot be computed (detection circuit error).
Presence Status	 Green	Physically present and accessible.
	 Red	Was present in a previous configuration but has disappeared.
	 Purple	Cannot be computed (detection circuit error).
Power Status	 Green	Main power is ON.
	 Red	Main power is OFF. Stand-by power is ON.
	 Pink	Main power is OFF. Stand-by power is OFF.
	 Blinking red	Main power is Faulty. Stand-by power may be ON, OFF or Faulty.
	 Gray	Main power status is Unknown.
Excluded State	 Green	Logically included.
	 Red/white	Logically excluded.
	 Red/green	To be logically included at the next domain power ON.
	 Green/red	To be logically excluded at the next domain power ON.
	 Yellow	IOB HubLink logically included.
	 Red	IOB HubLink logically excluded.
Locked State	 	This feature is reserved for future use.

Table 21. Domain hardware details icons



Note:

When the domain is **INACTIVE**, the **Domain Hardware Details** dialog indicates the resources that PAM will try to initialize for the domain during the next **Power ON** sequence. When the domain is **RUNNING**, the **Domain Hardware Details** dialog indicates the resources that PAM successfully initialized for the domain during the last **Power ON** or **Reset** sequence.

For more information about domain hardware, see:

- Presence Status Indicators, on page 4-6
- Functional Status Indicators, on page 4-7
- Domain Functional Status Indicators, on page 3-30
- Viewing Server Hardware Status, on page 4-12
- Excluding/Including Hardware Elements, on page 4-22
- Limiting Access to Hardware Resources, on page 5-79

Modifying Domain Configuration



Important:

Reserved for partitioned servers and extended systems. Please contact your Bull Sales Representative for sales information.

What You Can Do

- *Add Cells to a Domain*
- *Remove Cells from a Domain*
- *Change a Domain EFI boot LUN*
- *Delete a Domain*

During operation, you may want to re-define server domains to meet variations in workload, for example. As Customer Administrator or Operator you can modify the configuration of any **INACTIVE** domain loaded in the **Domain Manager** Control pane, at any time, provided that the required resources are available (IO boxes and QBBs) and that they are supported by the domain Operating System.

The Bull NovaScale 6000 Series server is designed around a flexible, cell-based, midplane architecture for enhanced performance, scalability and availability. Each CSS Module is divided into two Cells or hardware partitions, as shown in the following table.

NovaScale 6080/6160 Server

Hardware Cell	Cell_0	Cell_1
EFI LUN	<MyServer>_0LU0	<MyServer>_0LU1
IOB	Mod0_IOB0	Mod0_IOB1
QBBs	Mod0_QBB0, Mod0_QBB1*	Mod0_QBB2*, Mod0_QBB3

* QBB1 and QBB2 only equip the NovaScale 6160 Server

NovaScale 6320 Server

Hardware Cell	Cell_0	Cell_1
EFI LUN	<MyServer>_0LU0	<MyServer>_0LU1
IOB	Mod0_IOB0	Mod0_IOB1
QBBs	Mod0_QBB0, Mod0_QBB1	Mod0_QBB2, Mod0_QBB3
Hardware Cell	Cell_2	Cell_3
EFI LUN	<MyServer>_0LU2	<MyServer>_0LU3
IOB	Mod1_IOB0	Mod1_IOB1
QBBs	Mod1_QBB0, Mod1_QBB1	Mod1_QBB2, Mod1_QBB3

Table 22. Bull NovaScale 6000 Series server cell configuration

Your server is designed to operate as:

NovaScale 6080/6160 Server

- two SMP systems, one using the hardware resources in Cell_0, the other using the hardware resources in Cell_1 (default configuration),
or
- a single SMP system, using the hardware resources in both Cell_0 and Cell_1,
or
- a single SMP system, using the hardware resources in Cell_0 only,
or
- a single SMP system, using the hardware resources in Cell_1 only.

NovaScale 6320 Server

- four SMP systems, each using the hardware resources in one cell (default configuration),
or
- a single SMP system, using the hardware resources in all cells,
or
- a single SMP system, using the hardware resources in a selection of cells.

As Customer Administrator, you are advised to configure Schemes for domain management via the **PAM Domain Scheme** wizard. For further details about domain configuration options, see *Configuring Domains*, on page 5-33.



Notes:

- **xx** in the default Scheme and domain names represents the Central Subsystem HW identifier (from 00 to 16). For further details, refer to *PMB Code Wheel Settings*, on page 4-45.
- In the screen shots, tables, and examples in this guide:
 - **MyOperationsScheme–xx** is referred to as **MyOperationsScheme**
 - **MyOperations–xx–1** is referred to as **MyOperations–1**
 - **MyOperations–xx–2** is referred to as **MyOperations–2**
 - **MyOperations–xx–3** is referred to as **MyOperations–3**
 - **MyOperations–xx–4** is referred to as **MyOperations–4**
- In the screen shots in this guide, an instance of Microsoft Windows is pre-installed on **MyOperations–xx–1** and **MyOperations–xx–3** and an instance of Linux is pre-installed on **MyOperations–xx–2** and **MyOperations–xx–4**.

Operating System type is indicated by the Microsoft Windows  or Linux  logo in the **Domain Identities** box.

Adding Cells to a Domain

Notes:

- At least one Cell, containing one IOB and one QBB, must be available.
- The Operating System must support added hardware.
- The domain must be **INACTIVE** before configuration changes can be made.
- When you add a Cell to a NovaScale 6080/6160 Server domain, the server will operate as a single SMP system, using all hardware resources.

To add Cells to a domain:

1. Click **Domain Manager** to open the Control pane.
2. Select the required domain.
3. Click **Modify** in the Command bar to open the **Modify Domain** dialog.

Note:

The **Modify Domain** dialog can also be accessed from the **View Domain** dialog.

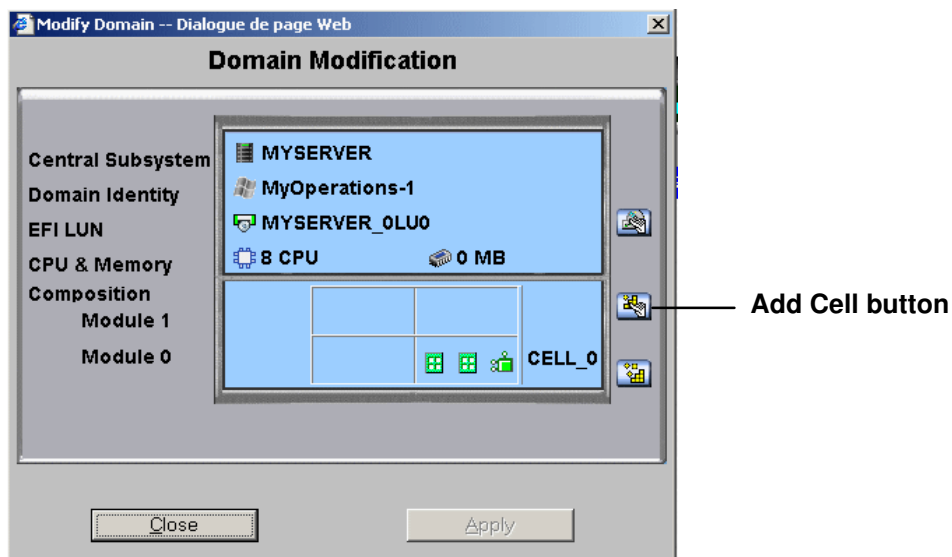

* Module 1 (Cell_2 & Cell_3): does not equip mono-module servers

Figure 60. Modify Domain – Add Cell dialog

4. Click **Add Cell**. The **Add Cells to Domain** dialog opens.

Note:

If a **No CELL available** message appears, you must first delete the domain using the cell. See *Deleting a Domain*, on page 3-53.

NovaScale 6080/6160 Server

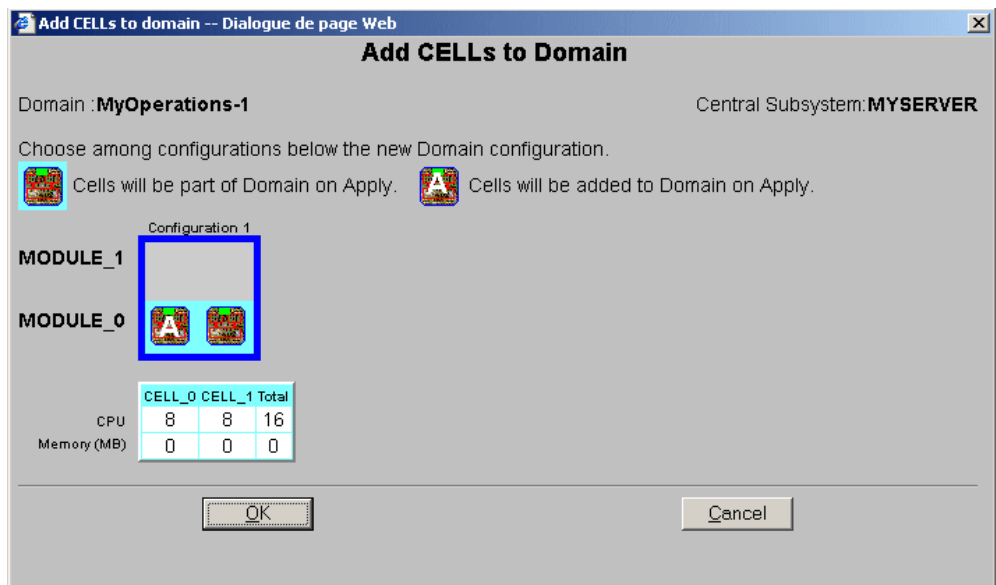

Figure 61. Add Cells to Domain dialog (mono-module server)

NovaScale 6320 Server

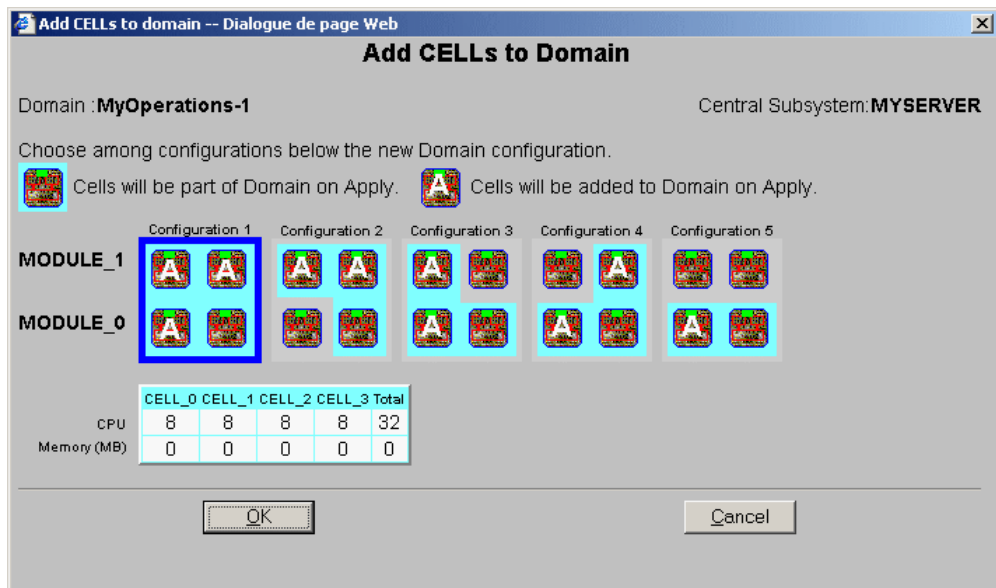
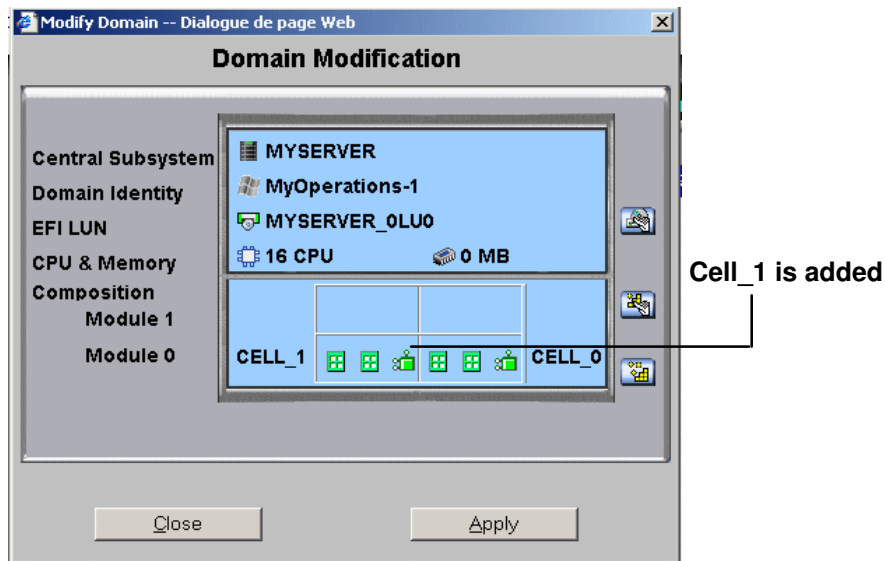

Figure 62. Add Cells to Domain dialog (bi-module server)

5. Select the required configuration and click **OK**. The letter **A** indicates the cell that will be added to the domain.

The new domain configuration is displayed in the **Modify Domain** dialog.

NovaScale 6080/6160 Server



* Module 1 (Cell_2 & Cell_3): does not equip mono-module servers

Figure 63. Modify Domain – Add Cell confirmation dialog (mono-module server)

NovaScale 6320 Server

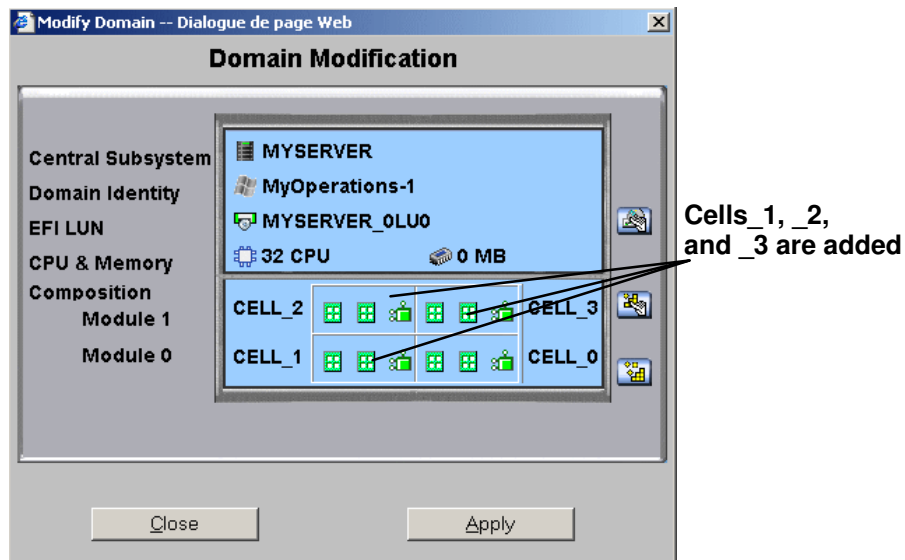

Figure 64. Modify Domain – Add Cell confirmation dialog (bi-module server)

6. If required, click **View Resources** for hardware details. See *Viewing Domain Hardware Resources*, on page 3-38.
7. Click **Apply** to apply changes. The selected domain is now extended to the specified number of Cells.



Note:

Domain modifications are not saved and are only applicable while the selected domain is loaded in the **Domain Manager** Control pane. If required, the new configuration can be saved for future use. See *Saving the Current Domain Scheme Snapshot*, on page 3-12.

Removing Cells from a Domain



Notes:

- At least one Cell, containing one IOB and one QBB, must remain.
- The domain must be **INACTIVE** before configuration changes can be made.
- When you remove a Cell from a NovaScale 6080/6160 Server domain, the server can either operate as a single SMP system, using only the hardware resources in the remaining Cell, or as two SMP systems if the removed Cell is allocated to another domain.



Warning:

When you remove a Cell from a domain, the devices attached to the corresponding IOB board are no longer available for this domain.

To remove Cells from a domain:

1. Click **Domain Manager** to open the Control pane.
2. Select the required domain.
3. Click **Modify** in the Command bar to open the **Modify Domain** dialog.



Note:

The **Modify Domain** dialog can also be accessed from the **View Domain** dialog.

NovaScale 6080/6160 Server

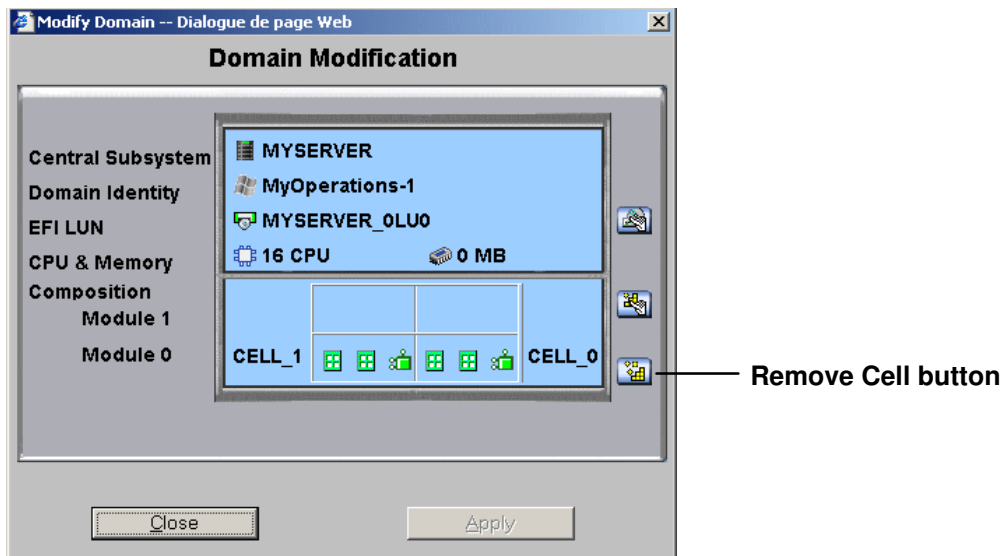

* Module 1 (Cell_2 & Cell_3): does not equip mono-module servers

Figure 65. Modify Domain – Remove Cell dialog (mono-module server)

NovaScale 6320 Server

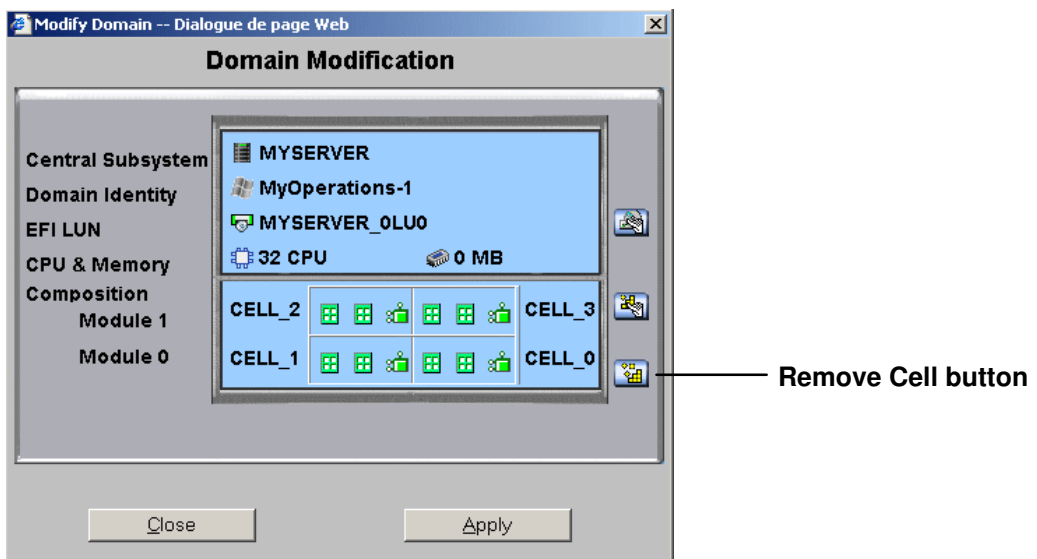

Figure 66. Modify Domain – Remove Cell dialog (bi-module server)

- Click **Remove Cell**. The **Remove Cells from Domain** dialog opens.

NovaScale 6080/6160 Server

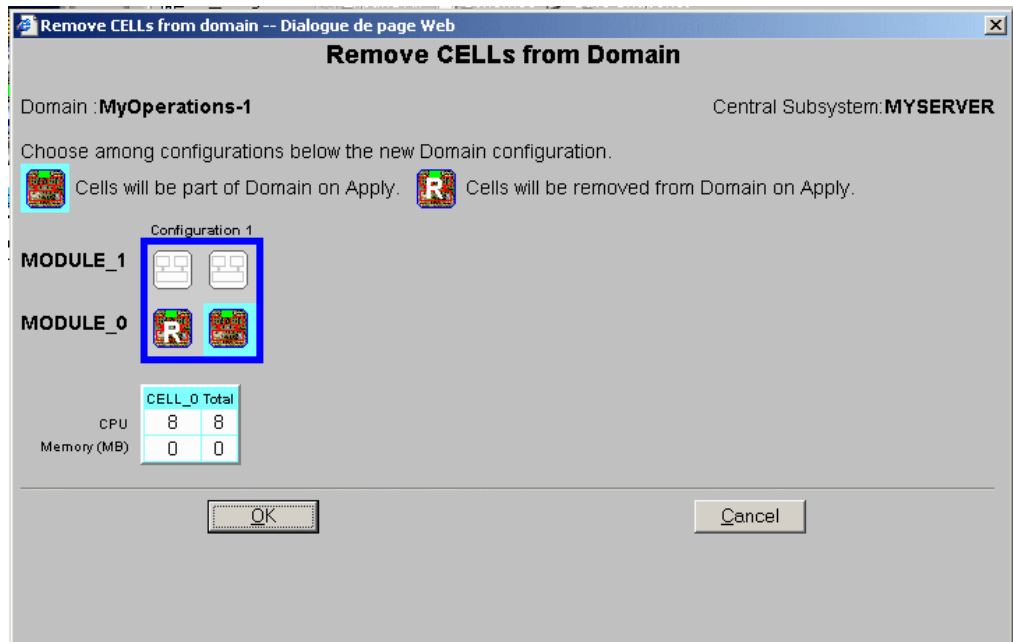

Figure 67. Remove Cells from Domain dialog (mono-module server)

NovaScale 6320 Server

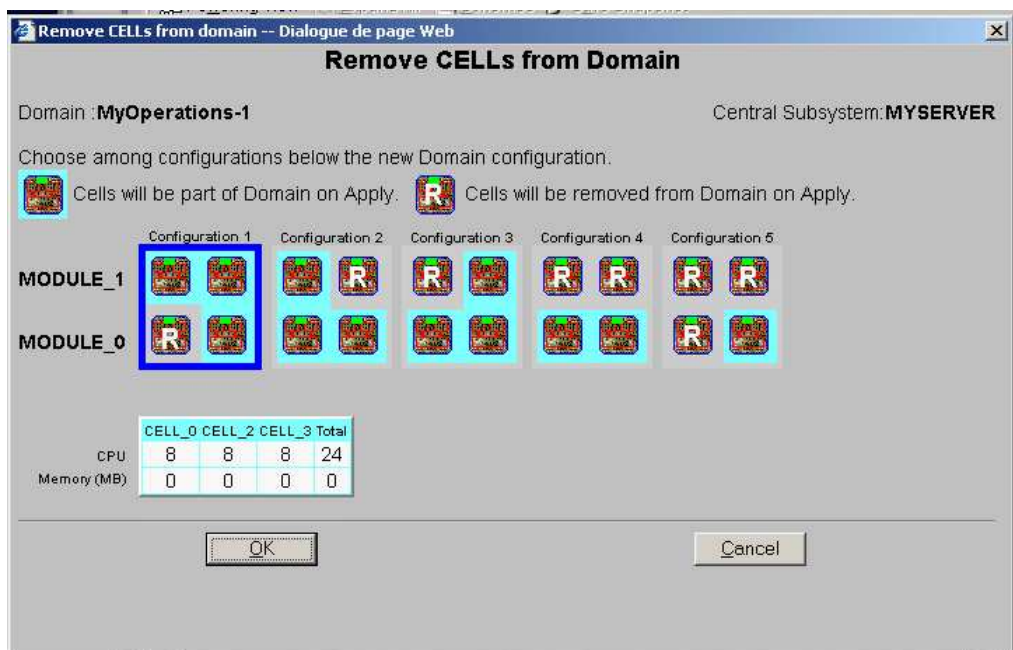
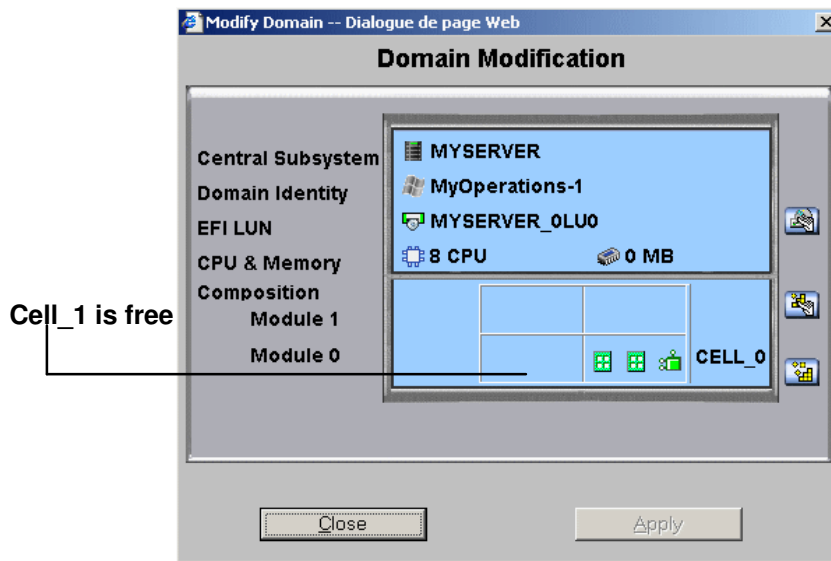

Figure 68. Remove Cells from Domain dialog (bi-module server)

- Select the required configuration and click **OK**. The letter **R** indicates the cell that will be removed from the domain.

The new domain configuration is displayed in the **Modify Domain** dialog.

NovaScale 6080/6160 Server



* Module 1 (Cell_2 & Cell_3): does not equip mono-module servers

Figure 69. Modify Domain – Remove Cell confirmation dialog (mono-module server)

NovaScale 6320 Server

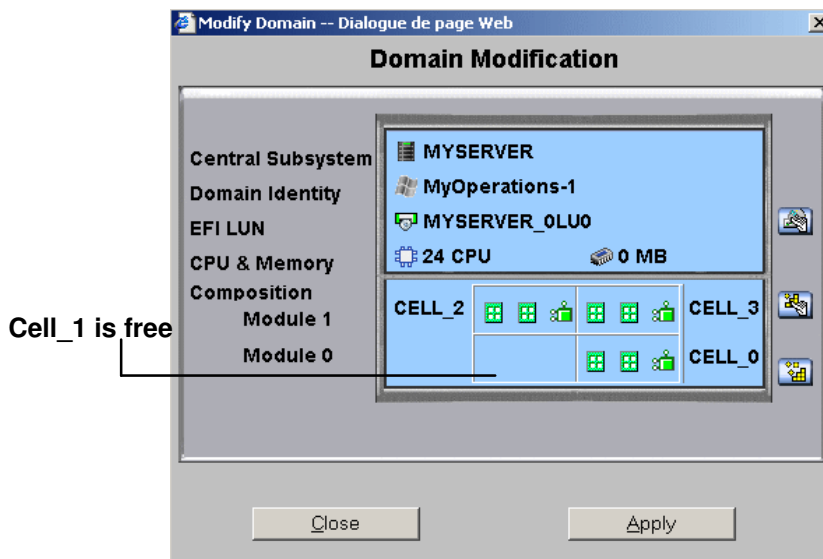

Figure 70. Modify Domain – Remove Cell confirmation dialog (bi-module server)

6. If required, click **View Resources** for hardware details. See *Viewing Domain Hardware Resources*, on page 3-38.
7. Click **Apply** to apply changes. The selected domain is now reduced to the specified number of Cells.



Note:

Domain modifications are not saved and are only applicable while the selected domain is loaded in the **Domain Manager** Control pane. If required, the new configuration can be saved for future use. See *Saving the Current Domain Scheme Snapshot*, on page 3-12.

Changing the Domain EFI Boot LUN

Notes:

- At least two Cells must be included in the Domain.
- The domain must be **INACTIVE** before configuration changes can be made.
- When you change the EFI boot LUN, you will also change the Operating System instance.

To change the domain EFI boot LUN:

1. Click **Domain Manager** to open the Control pane.
2. Select the required domain.
3. Click **Modify** in the Command bar to open the **Modify Domain** dialog.

Note:

The **Modify Domain** dialog can also be accessed from the **View Domain** dialog.

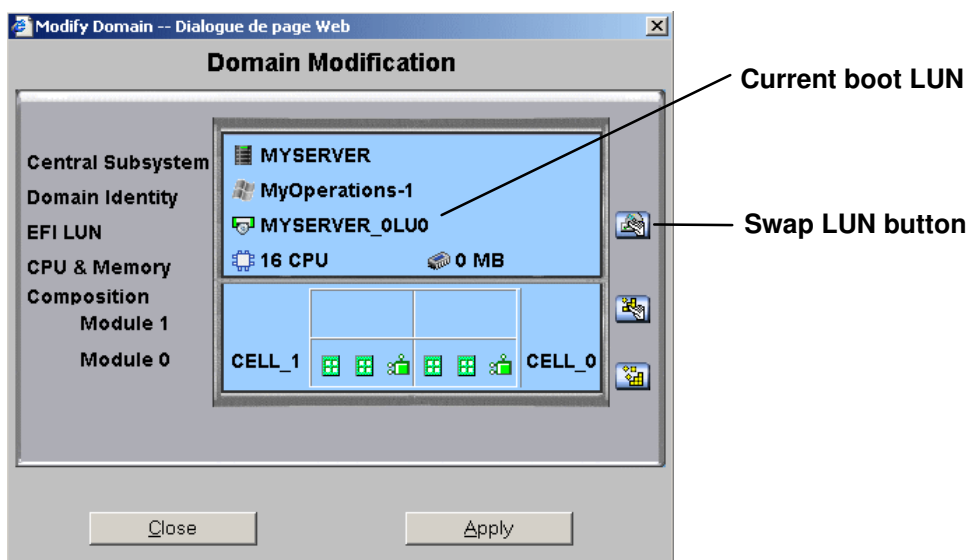

* Module 1 (Cell_2 & Cell_3): does not equip mono-module servers

Figure 71. Modify Domain – Configure LUN dialog

4. Click the top arrow to display the **LUN** menu.
5. Click **Configure LUN**. The **Select LUN** dialog opens.

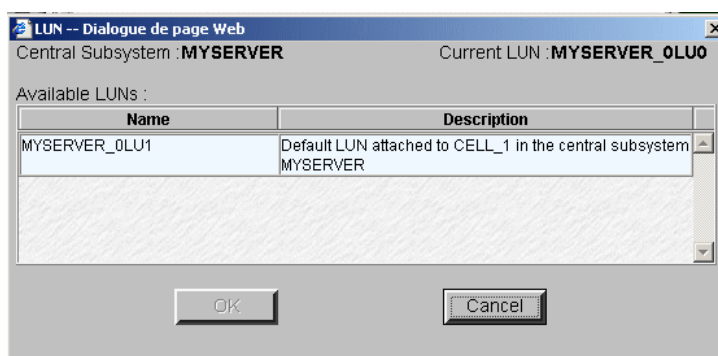
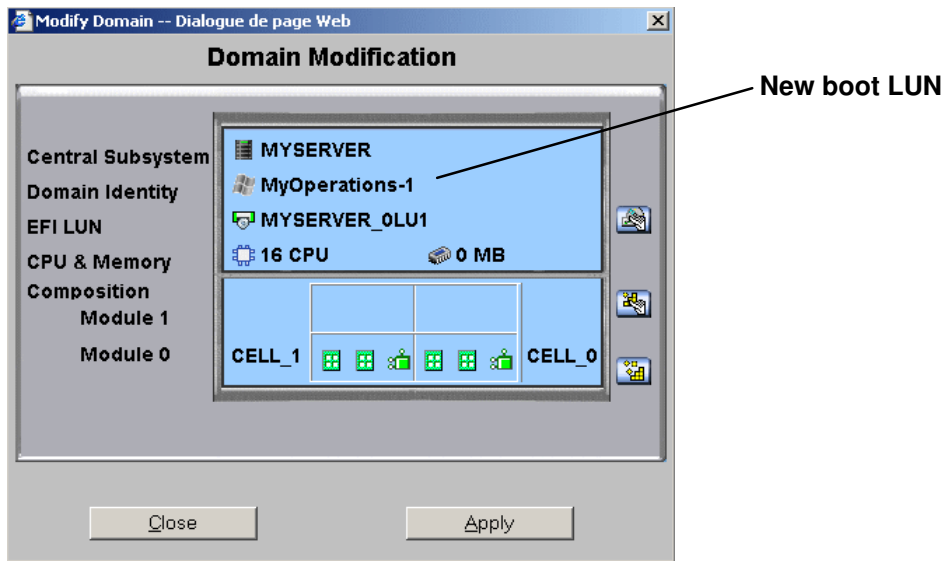

Figure 72. Select LUN dialog

6. Select the required LUN and click **OK**.

New domain configuration is displayed in the **Modify Domain** dialog.



* Module 1 (Cell_2 & Cell_3): does not equip mono-module servers

Figure 73. Modify Domain – Configure LUN confirmation dialog

7. Click **Apply** to apply changes.



Note:

Domain modifications are not saved and are only applicable while the selected domain is loaded in the **Domain Manager** Control pane. If required, the new configuration can be saved for future use. See *Saving the Current Domain Scheme Snapshot*, on page 3-12.

Deleting a Domain

Note:

The domain must be **INACTIVE** to be deleted.

Once loaded in the **Domain Manager** Control pane, a domain can be deleted from the current configuration. When the domain has been deleted, the corresponding resources can be re-allocated to another domain.

To delete a domain from the current configuration:

1. Click **Domain Manager** to open the Control pane.
2. Select the required domain.
3. Click **Delete** in the Command bar. The **Confirm Remove Domain** dialog opens.

NovaScale 6080/6160 Server

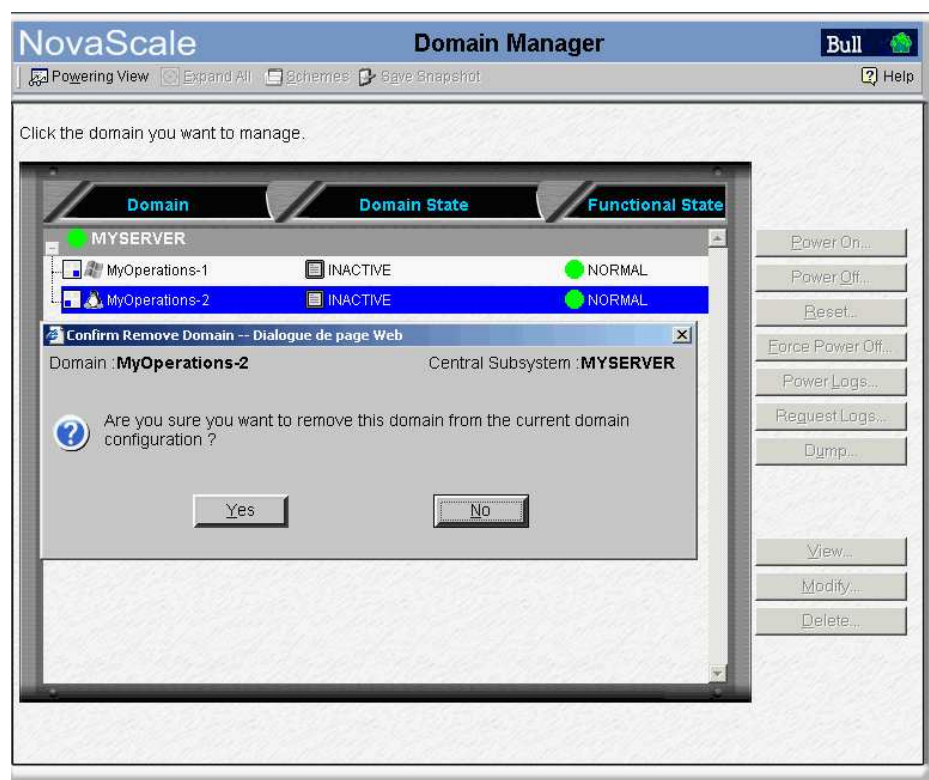

Figure 74. Delete domain dialog – mono-module server

NovaScale 6320 Server

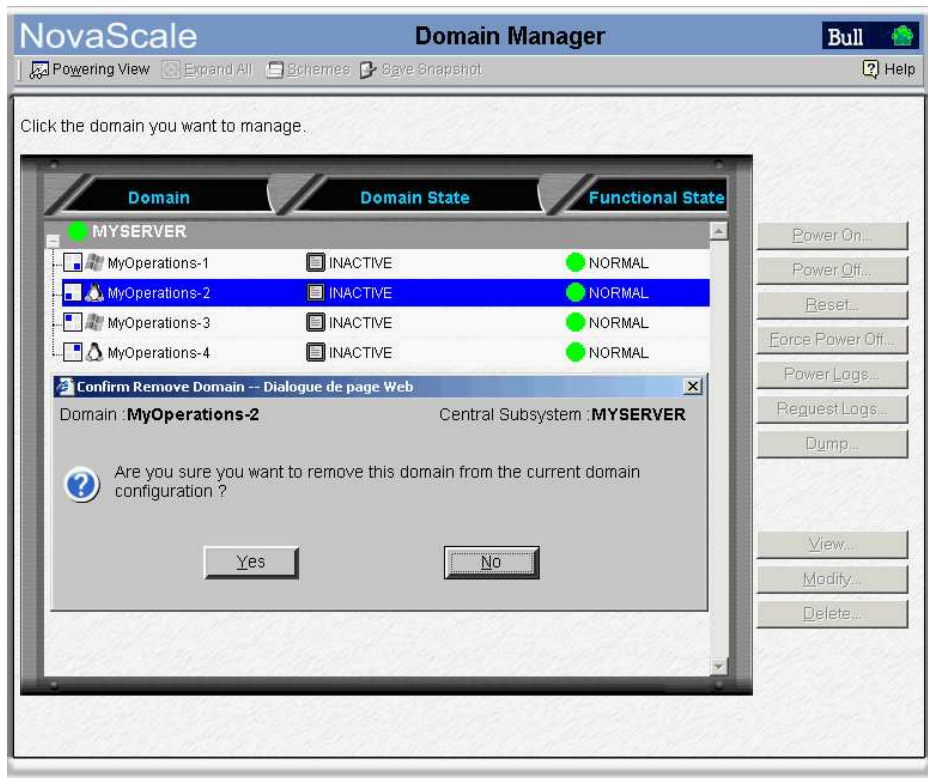

Figure 75. Delete Domain dialog – bi-module server

4. Click **Yes** to confirm deletion of the selected domain from the current configuration.

An information box opens, informing you that the domain has been successfully deleted. The domain is no longer visible in the Control pane.

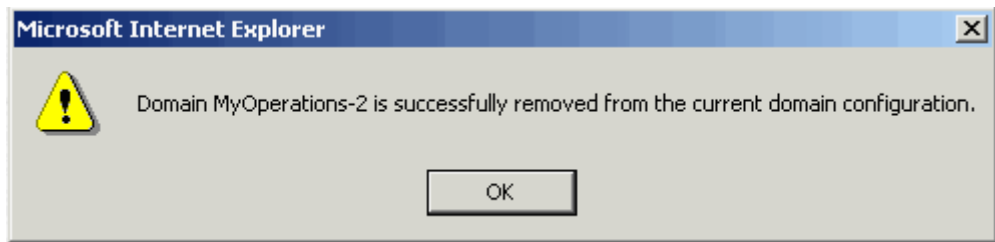

Figure 76. Domain deleted information box

5. Click **OK** to continue.

You can now re-allocate the resources of the deleted domain. See *Adding a Cell to a Domain*, on page 3-44



Note:

Domain modifications are not saved and are only applicable while the selected domain is loaded in the **Domain Manager** Control pane. If required, the new configuration can be saved for future use. See *Saving the Current Domain Scheme Snapshot*, on page 3-12.

What To Do if an Incident Occurs

When an incident occurs during a domain **Power ON / Power OFF / Force Power OFF / Reset** sequence, a message is displayed in the **Domain Status** panel and a trace is recorded in the **Domain POWER Logs**. Table 23 indicates the messages that may be displayed during an incorrect power sequence.

NovaScale 5xx0 Servers

SEQUENCE	ERROR MESSAGE
Powering up	Powering up all components failed
	Timeout during Power On
Bios loading	BIOS initialization timeout
	BIOS init timeout during recovery
Starting EFI	Timeout during starting EFI
Powering down	Powering down failed
	Powering down timeout
Force Power OFF	Terminating timeout
	Terminating KO

NovaScale 6xx0 Servers

SEQUENCE	ERROR MESSAGE
POWERING ON	POWERING ON FAILED
	TIMEOUT DURING POWER ON
	POWERING ON SUSPENDED
	DOMAIN HALTED
POWERED ON – LOADING BIOS	RECOVERING BIOS
	BIOS LOADING TIMEOUT
BIOS READY – STARTING EFI	TIMEOUT DURING START EFI
POWERING DOWN	POWER DOWN FAILED
	TIMEOUT DURING POWER DOWN

Table 23. Domain power sequence error messages

PAM software also informs connected and non-connected users via:

- the PAM Web interface (**Status Pane** and/or **User History** files),
- e-mail (users with an appropriate Event Message subscription),
- an autocal to the Bull Service Center (according to your maintenance contract) for analysis and implementation of the necessary corrective or preventive maintenance measures, where applicable.

As Customer Administrator, you have access to the **System History** files and associated **Help Files**. As Customer Operator, you have access to the **User History** and/or **Web Event Messages**, and associated **Help Files**, pre-configured by your Customer Administrator.

You will find all the advice you need in the **Help Files** associated with the **System / User History** and **Web Event Messages** you are authorized to view.

Whether you open a **Web Event Message** or a **System / User History** file, the resulting display and utilities are the same. See *Viewing and Managing Event Messages and History Files*, on page 4-26.



Note:

All incidents are systematically logged in the **System History** files, which you can view as Customer Administrator at any time.

Dealing with Incidents

When you open the incident **Help File**, you may be requested to contact your Customer Service Engineer or perform straightforward checks and actions:

Checking POST Codes

If you are requested to check POST Codes, see *Viewing Power Logs*, on page 3-33.

Checking Hardware Exclusion Status

If you are requested to check hardware exclusion status, see *Excluding / Including Hardware Elements*, on page 4-22.

Checking Hardware Connections

If you are requested to check hardware connections, use Appendix *Cabling Diagrams* to manually and visually ensure that all cables are correctly inserted in their corresponding hardware ports.

Rebooting Maestro / Resetting the PMB

If you are requested to reboot Maestro or to reset the PMB, see *Checking, Testing, and Resetting the PMB*, on page 4-43.

Rebooting the PAP Application

If you are requested to reboot the PAP application:

1. From the Microsoft Windows home page, click **Start** → **Programs** → **Administrative Tools** → **Component Services**.
2. From **Component Services**, click **Console Root** → **Component Services** → **Computers** → **My Computer** → **COM+ Applications** → **PAP**.
3. Right click **PAP** to open the shortcut menu. Click **Shutdown**.
4. Activate the required PAM version to reboot the PAP application. See *Deploying a PAM Release*, on page 5-28 and *Activating a PAM Version*, on page 5-29.

Powering OFF/ON the Domain

If you are requested to Power OFF/ON or Force Power OFF a domain, ensure that you have saved data and closed open applications. See *Powering ON a Domain*, on page 3-15, *Powering OFF a Domain*, on page 3-18, and *Forcing a Domain Power OFF*, on page 3-24.

Resetting a Domain

If you are requested to Reset a domain, see *Resetting a Domain*, on page 3-21.

Performing a Domain Memory Dump

If you are requested to perform a domain memory Dump, see *Performing a Domain Memory Dump*, on page 3-27.

Turning the Site Breaker Off

The server is not equipped with a physical power button and can only be completely powered down by turning the site breaker off.

Chapter 4. Monitoring the Server

This chapter explains how, as Customer Administrator, you can supervise server operation. It includes the following topics:

- Introducing PAM Monitoring Tools, on page 4-2
- Using the Hardware Search Engine, on page 4-9
- Viewing PAM Web Site User Information, on page 4-10
- Viewing PAM Version Information, on page 4-11
- Viewing Server Hardware Status, on page 4-12
- Displaying Detailed Hardware Information, on page 4-14
- Excluding / Including Hardware Elements, on page 4-22
- Viewing and Managing PAM Event Messages and History Files, on page 4-26
- Understanding Event Message and History Severity Levels, on page 4-27
- Consulting Event Messages, the Hardware Faults List, and History Files, on page 4-28
- Sorting and Locating Messages, on page 4-30
- What to Do if an Incident Occurs, on page 4-37



Note:

Customer Administrators and Customer Operators are respectively advised to consult the *Administrator's Memorandum*, on page xxvi or the *Operator's Memorandum*, on page xxviii for a detailed summary of the everyday tasks they will perform.

For further information about user accounts and passwords, see *Setting up PAP Unit Users*, on page 5-22.

Introducing PAM Monitoring Tools

Main Central SubSystem (CSS) hardware components are managed by the comprehensive Platform Administration and Maintenance (PAM) software specifically designed for Bull NovaScale Servers.



Note:

Peripheral devices such as disk racks, PCI adapters, KVM switch, local console, and the PAP unit are managed by the Operating System and/or by dedicated software. For details on how to monitor these devices, please refer to the user documentation provided on the Bull NovaScale Server Resource CD–Rom.

PAM software permanently monitors and regulates CSS hardware during operation, ensuring automatic cooling for compliance with environmental requirements, power ON / OFF sequences, component presence and functional status checks, and event handling and forwarding.

In–depth monitoring is a Customer Administrator function and the PAM **Hardware Monitor** is only available to users with administrator access rights. However, all connected users are permanently and automatically informed of CSS functional status via the PAM **Status** pane and of domain status via the PAM **Domain Manager Control** pane.

The PAM **Event Messaging** system offers comprehensive event message subscription options allowing both connected and non–connected users to be informed of server status. See *Customizing the PAM Event Messaging System*, on page 5-85 for details.

To refresh the PAM display:

- Click the **Refresh Tree** button in the PAM Tree toolbar to refresh the PAM Tree.
- Click a node in the PAM Tree to refresh the corresponding Control pane display.
- Click the **Refresh Web Page** button to return to the PAM Home Page.



Note:

DO NOT use the Refresh option obtained by right clicking the mouse in the browser window.

Viewing System / Component Status

What You Can Do

- Check system status
- Check CSS module availability status
- Check event message status
- View hardware presence status
- View hardware functional status
- View server hardware status
- View FRU information
- View firmware information
- View thermal status
- View power status
- View temperature status
- View fan status
- View jumper status
- View PCI slot status

PAM Status Pane

When you log onto the PAM Web site, you are able to check system status at a glance via the **Status** pane which provides quick access to CSS Module availability status, server functional status, and pending event message information.

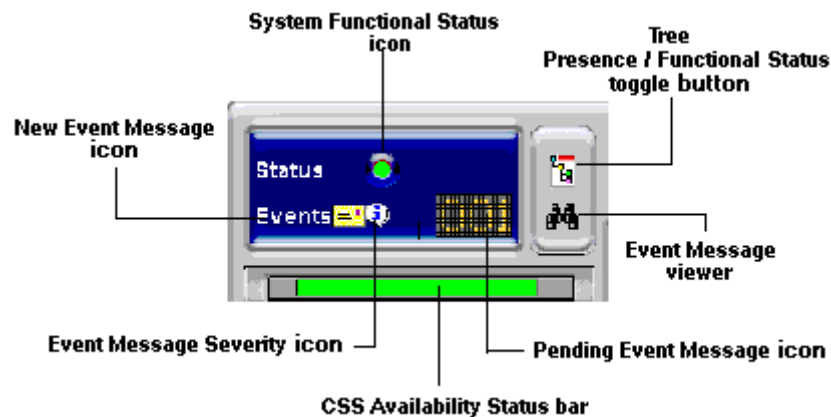

Figure 77. PAM Status pane

CSS Availability Status

NovaScale 5xx0 Servers and NovaScale 6080/6160 Servers

When the CSS Module is operating correctly, the **CSS Availability Status** bar is green. If the CSS Module is not operating correctly, the bar is red.

NovaScale 6320 Servers

The **CSS Availability Status** bar is divided into two zones.

If the CSS Modules are operating correctly, the **CSS Availability Status** bar is green.

If the CSS Modules are not operating correctly, the bar is red.

If one of the CSS Modules is not operating correctly, half the bar is red.

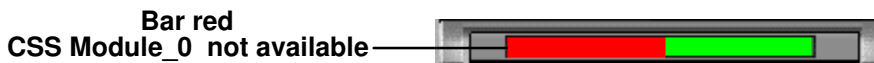

Figure 78. CSS Module availability status bar

System Functional Status

If the system is operating correctly, the **System Functional Status** icon is green. Table 24. explains possible system functional status indications.





Icon	Status	Explanation
 Green	NORMAL	No problem detected. The system is operating correctly.
 Yellow	WARNING	Minor problem reported. The system is still operational.
 Orange	CRITICAL	Serious problem reported. The system is no longer capable of operating correctly. PAM may generate an OS shutdown request.
 Red	FATAL	Major problem reported. PAM may automatically shut down the OS. The system is partially or totally stopped.
 Purple	NOT ACCESSIBLE	Status cannot be computed (detection circuit error).

Table 24. CSS hardware functional status icons



Important:

If the system functional status icon and/or CSS availability status bar is/are not green, see *What to Do if an Incident Occurs*, on page 4-37.

Event Message Status

The **New Event Message** icon informs you that new messages have arrived and that you can click the **View Event Message** icon to view them (the number of unprocessed event messages is also displayed). See *Consulting Event Messages, the Hardware Faults List, and History Files*, on page 4-28.

The **Event Message Severity** icon indicates the set maximum severity level of unprocessed event messages. See *Understanding Event Message and History Severity Levels*, on page 4-27.

PAM Tree Pane

As Customer Administrator, you can view the presence and functional status of each hardware element from the PAM Tree pane. The PAM Tree pane is refreshed at your request. Use the **Refresh PAM Tree** button to update the display when required.



Important:

To maintain a trace of transient faults, **PAM Tree functional and/or presence status indicators will not change color until the domain has been powered OFF/ON, even if the error has been corrected.**

Displaying Presence Status

When, as Customer Administrator, you log onto the PAM Web site, server hardware presence status is displayed in the PAM Tree by default (square, colored indicator next to the **Hardware Monitor** node). If you expand the PAM Tree, the presence status of all hardware elements is displayed.

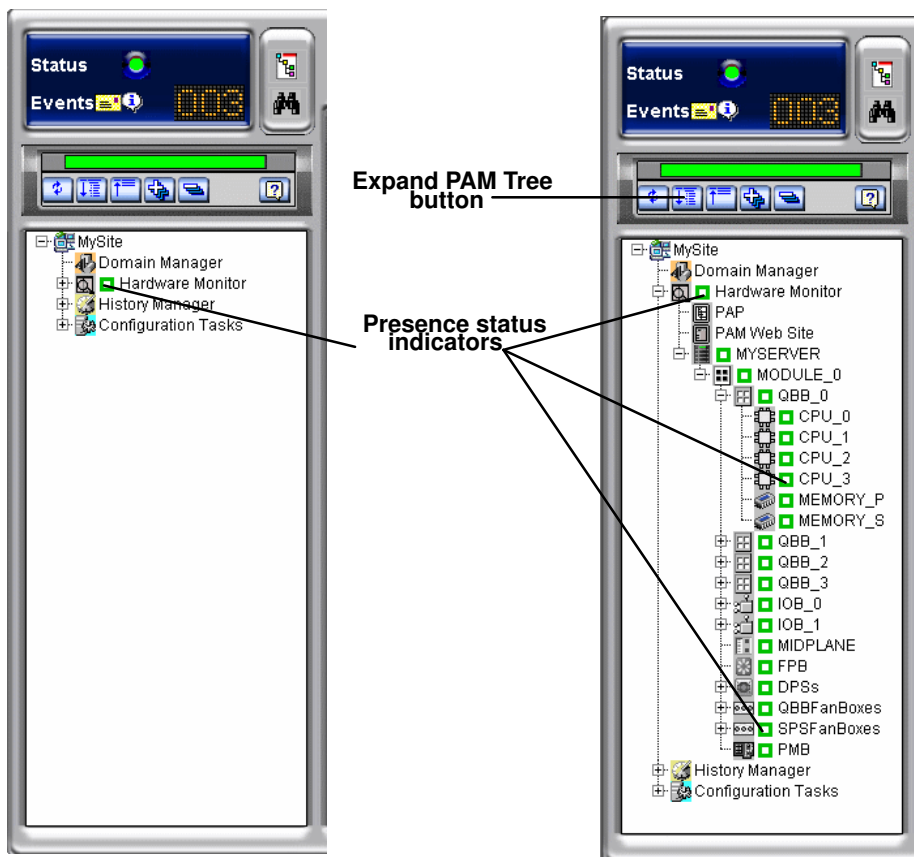

Figure 79. PAM Tree hardware presence status display

When hardware presence status is normal, all presence status indicators are green. Table 25. explains possible hardware presence status indications.

Presence Status Indicators





Indicator	Status	Explanation
 Green	NORMAL	This hardware element: – is physically present and accessible.
 Red	MISSING	This hardware element: – was present in a previous configuration but has disappeared.
 Red/white	MISSING	A sub-component of this hardware element: – was present in a previous configuration but has disappeared.
 Purple	NOT ACCESSIBLE	This hardware element: – cannot be computed (detection circuit error).
 Purple/white	NOT ACCESSIBLE	A sub-component of this hardware element: – cannot be computed (detection circuit error).

Table 25. Hardware presence status indicators



Important:

If a PAM Tree hardware presence status indicator is not green, this could be normal if a hardware element has been removed for maintenance. See *What to Do if an Incident Occurs*, on page 4-37.

Displaying Functional Status

You can toggle the PAM Tree to view system / hardware functional status (round, colored indicator next to the **Hardware Monitor** node). If you expand the PAM Tree, the functional status of all hardware elements is displayed. Functional Status is a composite indicator summarizing Failure Status, Fault Status, Power Status, and Temperature Status indicators, where applicable.

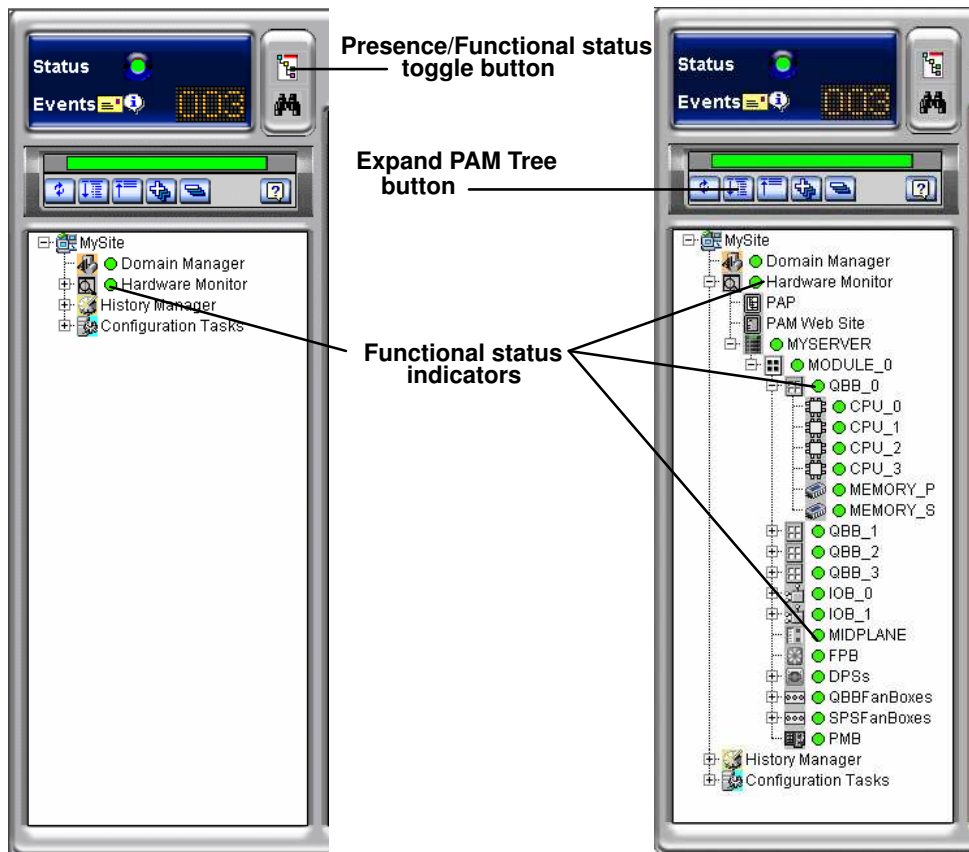

Figure 80. PAM Tree functional status display

When hardware functional status is normal, all functional status indicators are green. Table 26. explains possible hardware functional status indications.

Functional Status Indicators





Indicator	Status	Explanation
 Green	NORMAL	No problem detected. This hardware element is operating correctly.
 Yellow	WARNING	Minor problem reported. This hardware element is still operational.
 Orange	CRITICAL	Serious problem reported. This hardware element is no longer capable of operating correctly. PAM may generate an OS shutdown request.
 Red	FATAL	Major problem reported. PAM may automatically shut down the OS. System integrity is jeopardized.
 Purple	NOT ACCESSIBLE	The functional status of this hardware element cannot be computed (detection circuit error).

Table 26. Hardware functional status indicators



Important:

To maintain a trace of transient faults, PAM Tree functional and/or presence status indicators will not change color until the domain has been powered OFF/ON, even if the error has been corrected. Overall server functional status is indicated by the system Functional Status icon in the Status pane. For further details, see *What to Do if an Incident Occurs*, on page 4-37.



Note:

If, when you toggle the PAM Tree to view hardware functional status, the functional status of a hardware element is not normal, the **Hardware Monitor** node will automatically expand to the level of the malfunctioning hardware element, as shown in Figure 81.

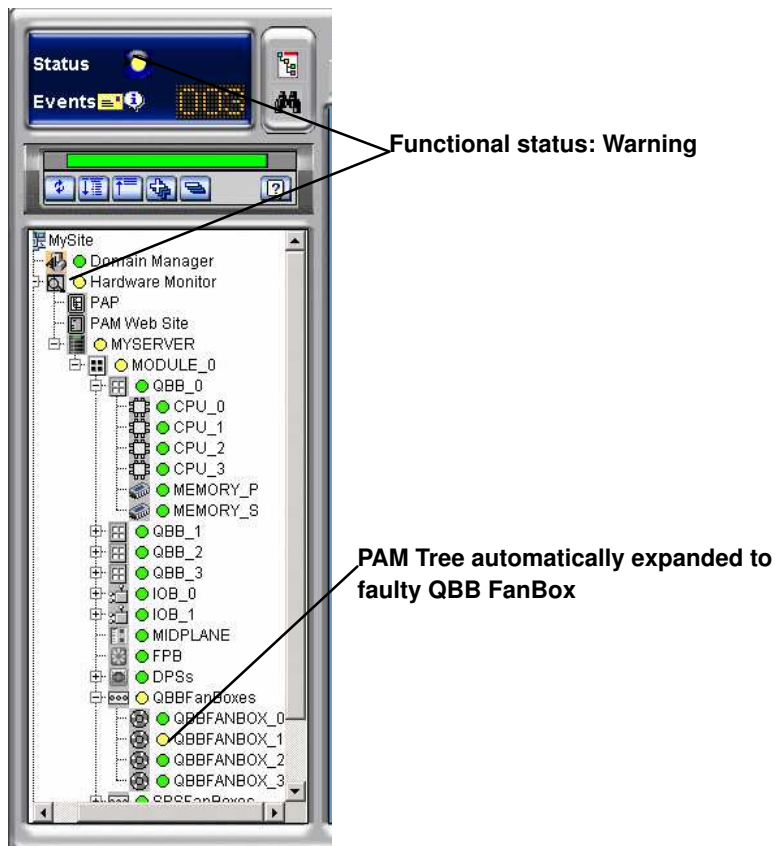

Figure 81. PAM Tree – automatically expanded functional status display

Using PAM Utilities

What You Can Do

- Search for excluded hardware elements
- Search for missing hardware elements
- View PAM Web site information
- View PAM version information
- Exclude / include hardware elements

Using the Hardware Search Engine

The **Hardware Search** engine allows you to search for and view hardware elements corresponding to selected criteria, for example **Excluded** or **Missing** hardware elements.

Notes:

- Excluded hardware elements are those that have been **logically** excluded from the server. See *Excluding / Including Hardware Elements*, on page 4-22.
- Missing hardware elements are those that have been **physically** removed from the server (e.g. for maintenance).

To search for specific hardware:

1. Click **Hardware Monitor** in the PAM tree to open the **Hardware Search** page.

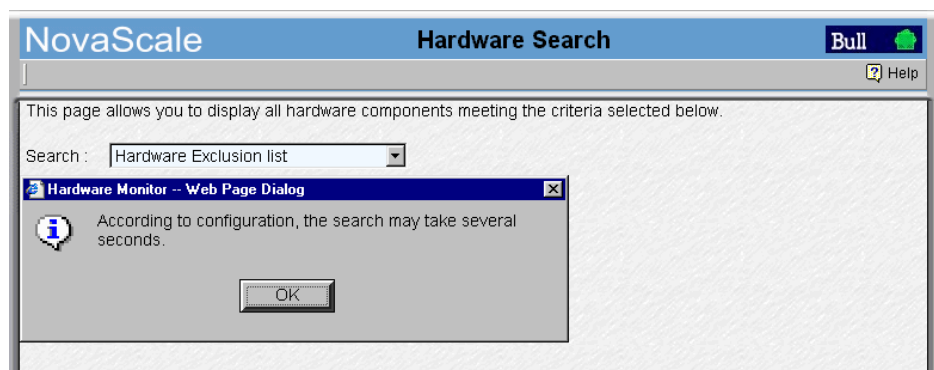

Figure 82. Hardware Search engine

2. Select the required search criteria from the dropdown box and click **OK**.

- Once the search is complete, results are displayed in the control pane.

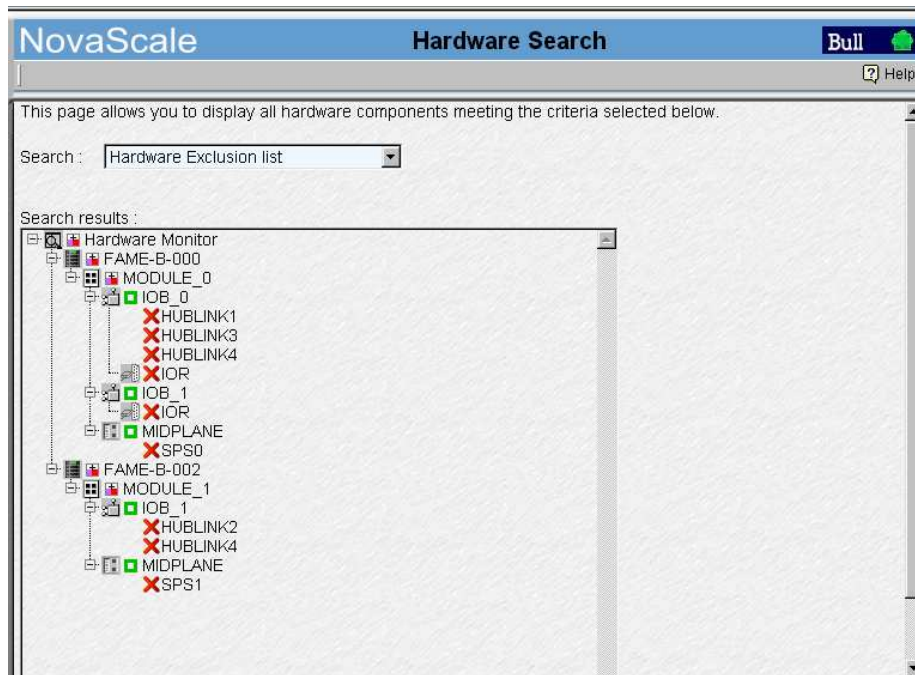

Figure 83. Hardware Search result list (example)

Viewing PAM Web Site User Information

As Customer Administrator, you can view the list of PAM users currently logged onto the PAM Web site by clicking **Hardware Monitor** → **PAM Web Site**.

The Web site version and a list of connected users and session details are displayed in the **Control** pane.



Note:

The  icon indicates the current session.

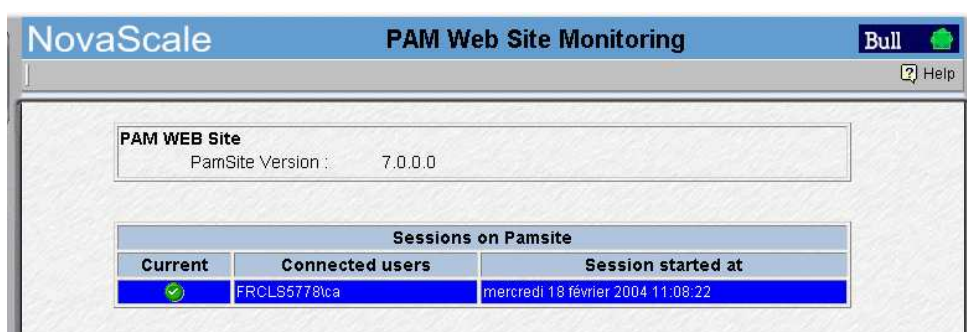
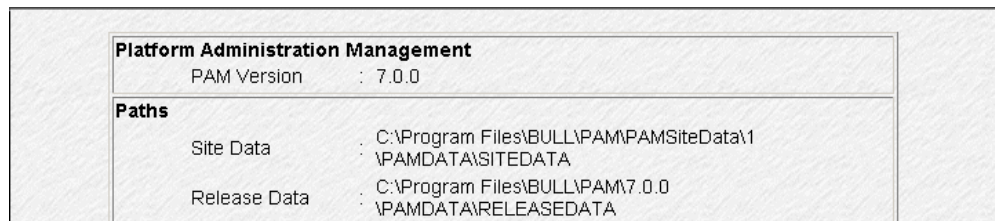

Figure 84. PAM Web Site user information

Viewing PAM Version Information

PAM version information may be useful to help your Customer Service Engineer solve software-related problems.

To view PAM version information, click **Hardware Monitor** → **PAP**. Complete PAM resource file information is displayed in the Control pane.



Platform Administration Management	
PAM Version	: 7.0.0
Paths	
Site Data	. C:\Program Files\BULL\IPAM\PAMSiteData\1 · \PAMDATA\SITEDATA
Release Data	. C:\Program Files\BULL\IPAM\7.0.0 · \PAMDATA\RELEASEDATA

Figure 85. PAM version information

The PAP unit information page indicates PAM software version details along with PAM **Site Data** and **Release Data** directory paths.

The PAM **Release Data** directory is used for all the files delivered as part of PAM software to ensure configuration consistency.

The PAM **Site Data** directory is used for all the the files produced by PAM software (history files, configuration files) concerning Customer site definition and activity.

If you want to deploy a new PAM release or activate another PAM version, see *Deploying a PAM Release*, on page 5-28 and *Activating a PAM Version*, on page 5-29.

Viewing Server Hardware Status

When you click the **CSS Name** in the PAM tree (e.g. **MYSERVER** in the figure), the **Hardware Monitor** displays a visual representation of the presence and functional status of CSS module components in the Control pane. Each primary hardware element functional status indicator is a clickable hotspot leading directly to the detailed **Hardware Status** page.

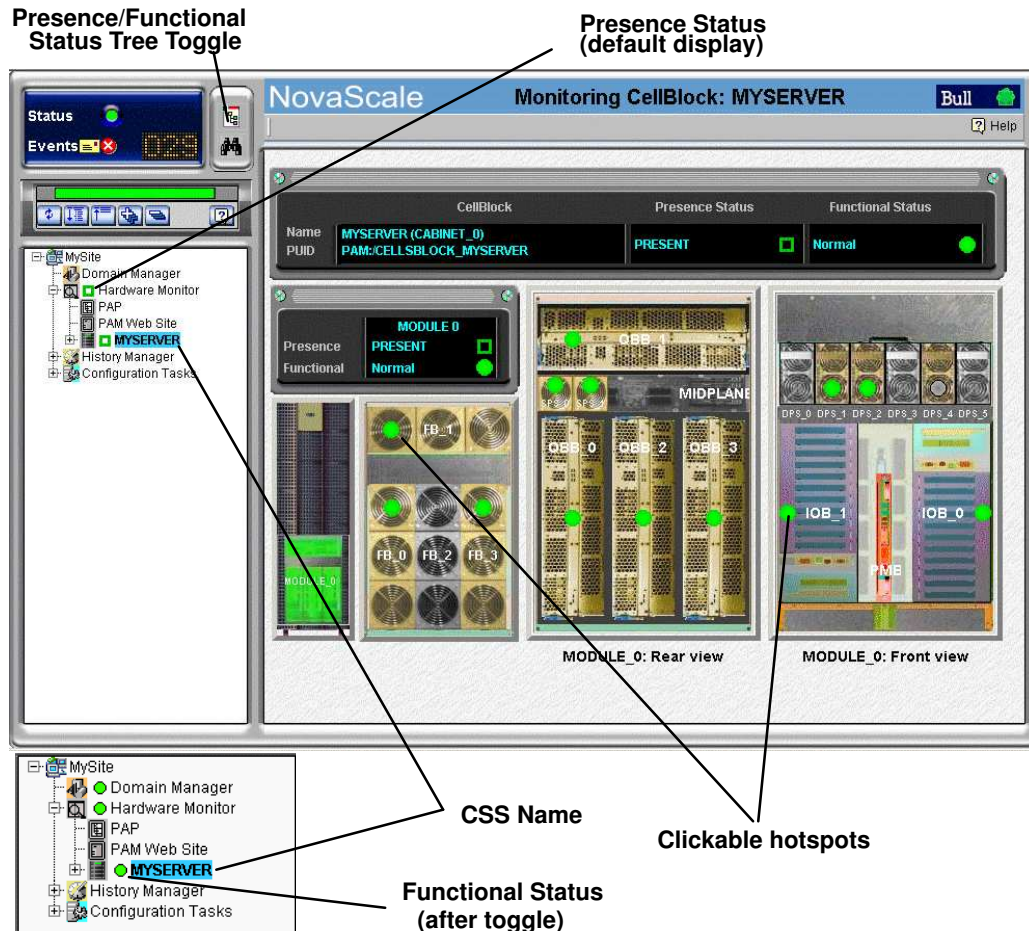

Figure 86. PAM Hardware Monitor

As you click a hardware element hotspot in the Control pane, you will notice that the PAM Tree automatically expands to the selected component level.



Note:

If a component is not part of your configuration, it is grayed out in the display. If a component is part of your configuration but has been detected as “missing”, it is displayed in red.

The meanings of presence and functional status indicators are explained in Table 25. *Hardware Presence Status Indicators*, on page 4-6 and Table 26. *Hardware Functional Status Indicators*, on page 4-7.



Important:

If a functional status indicator is not green, see *What to Do if an Incident Occurs*, on page 4-37.



Note:

The NovaScale 6320 Server Hardware Monitor Control pane displays a visual representation of the presence and functional status of the components of both CSS modules.



Figure 87. NovaScale 6320 Server Hardware Monitor display

Viewing Detailed Hardware Information

For detailed information about module / component / sub-component status, you can either click the corresponding hotspot in the **Hardware Monitor** Control pane or click the required hardware element in the PAM Tree to open the **Hardware Status** page.

General Tab



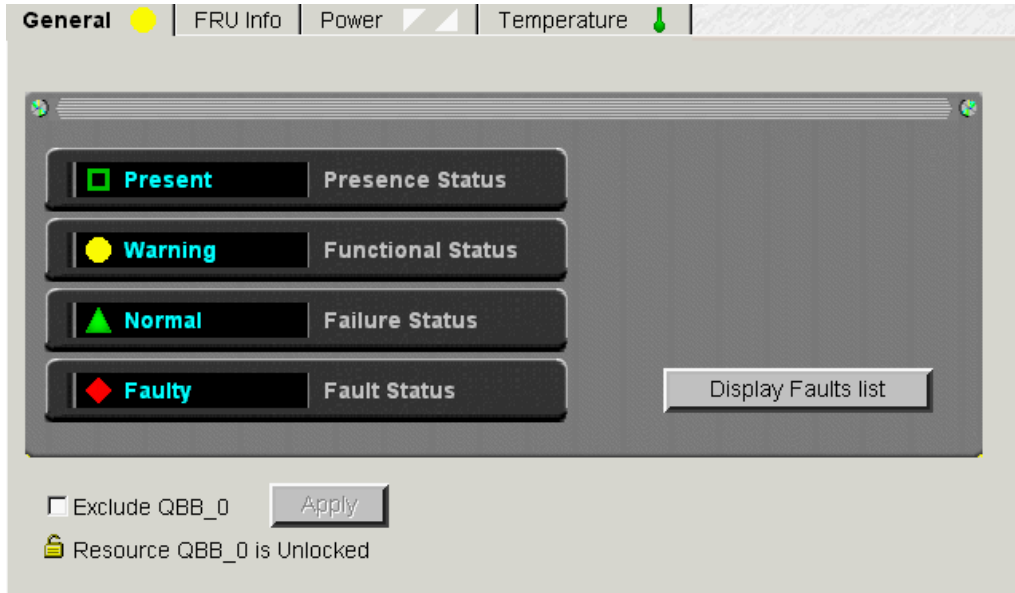

The **General** tab gives access to the following information:



Presence Status	Indicates if the hardware element is physically present and correctly configured. See <i>Presence Status Indicators</i> , on page 4-6.
Functional Status	Indicates if the hardware element is functioning correctly. See <i>Functional Status Indicators</i> , on page 4-7. NOTE: Functional Status is a composite indicator summarizing Failure Status, Fault Status, Power Status, and Temperature Status indicators, where applicable.
Failure Status	Indicates if a failure has been detected on the hardware element. NOTE: This feature is reserved for future use. See <i>Failure Status Indicators</i> , on page 4-15.
Fault Status	Indicates if a fault has been detected on the hardware element. See <i>Fault Status Indicators</i> , on page 4-15.
Display Faults List	When a fault is detected, a fault message is generated and the Display Faults List button gives direct access to the list of faults recently encountered by this hardware element. See <i>Consulting Event Messages, the Hardware Faults List, and History Files</i> , on page 4-28.
Exclude Status	The Exclude checkbox is used to logically exclude/include hardware elements from the domain. See <i>Excluding / Including Hardware Elements</i> , on page 4-22.
Locked State	This feature is reserved for future use.

Figure 88. General Hardware Status page (example)

Failure Status Indicators:

Indicator	Status	Explanation
 Green	NORMAL	PAM software has detected no failures on this hardware element.
 Orange	DEGRADED	PAM software has detected that this hardware element is running at sub-standard capacity but is not jeopardizing system performance.
 Red	FAILED	PAM software has detected a failure that may be jeopardizing system performance.
 Gray	UNKNOWN	PAM software is not receiving diagnostic information from this hardware element.

Fault Status Indicators

Fault Status, accessible via the **General** tab,



Indicator	Status	Explanation
 Green	NORMAL	PAM software has detected no faults on this hardware element.
 Red	FAULTY	PAM software has detected 1 or more fault(s) on this hardware element.
 Gray	UNKNOWN	PAM software is temporarily meaningless (e.g. hardware element missing).

Table 27. Fault status indicators

FRU Info Tab

The **FRU Info** tab gives access to Field Replaceable Unit identification data for the hardware element, such as Manufacturer's name, product name, part number, ... is accessible via the FRU Info tab.

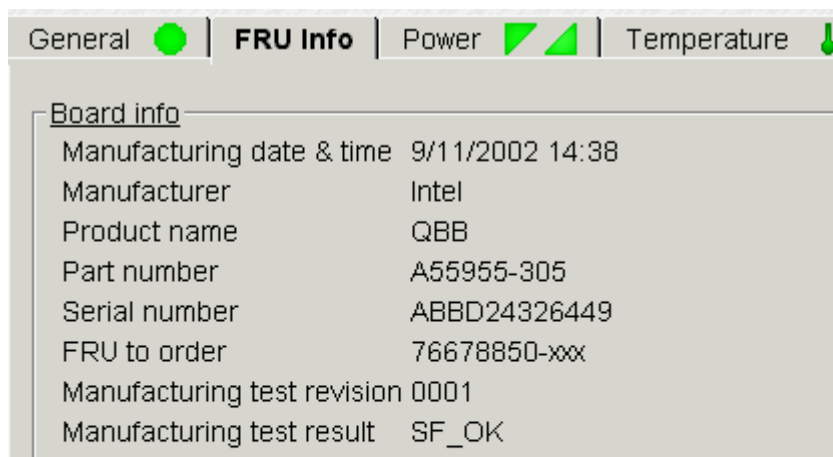

Figure 89. FRU data (example)

Firmware Tab (Midplane & PMB only)

The **Firmware** tab gives access to firmware version data for the hardware element.



Note:

Firmware versions may differ.

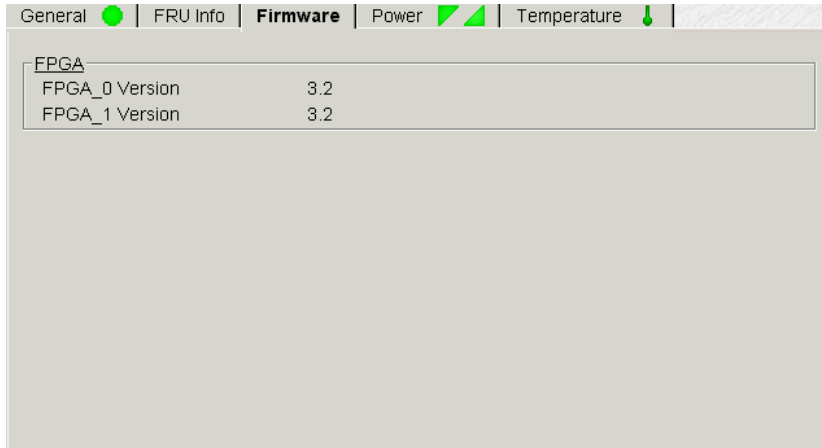

Figure 90. Firmware data (example)

Thermal Zones (CSS module only)

Thermal Zones, accessible via the **Thermal zones** tab, shows the thermal zones monitored by PAM software. A cooling error in a thermal zone will affect all the hardware elements in that zone. See *Functional Status Indicators*, on page 4-7.

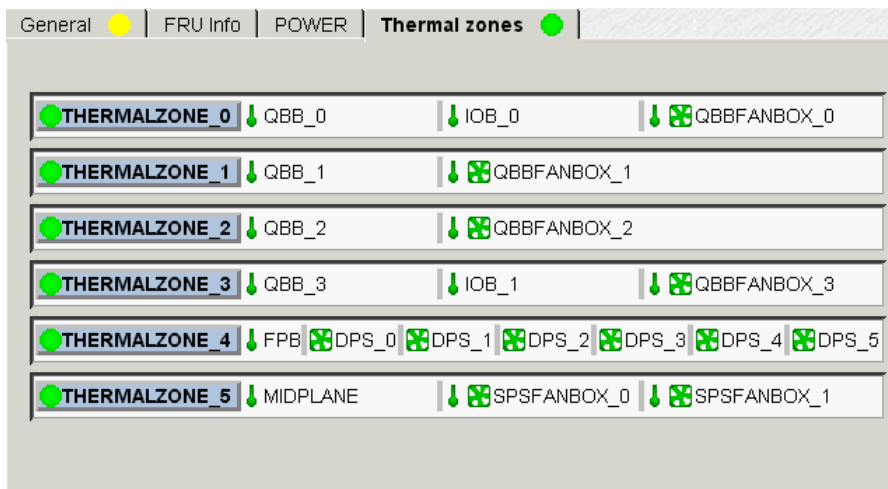

Figure 91. CSS module thermal zone details



Note:

When a thermal fault is detected, a fault message is generated and the **General** tab **Display Faults List** button gives direct access to the corresponding logs.

Power Tab

The **Power** tab gives access to power status data for the hardware element, indicating main and standby power state and/or power-specific faults for each converter. See *Functional Status Indicator*, on page 4-7.

Once connected to the Customer's site power supply, server hardware elements initialize to the stand-by mode. Server hardware elements initialize to the main mode when the domain is powered up.

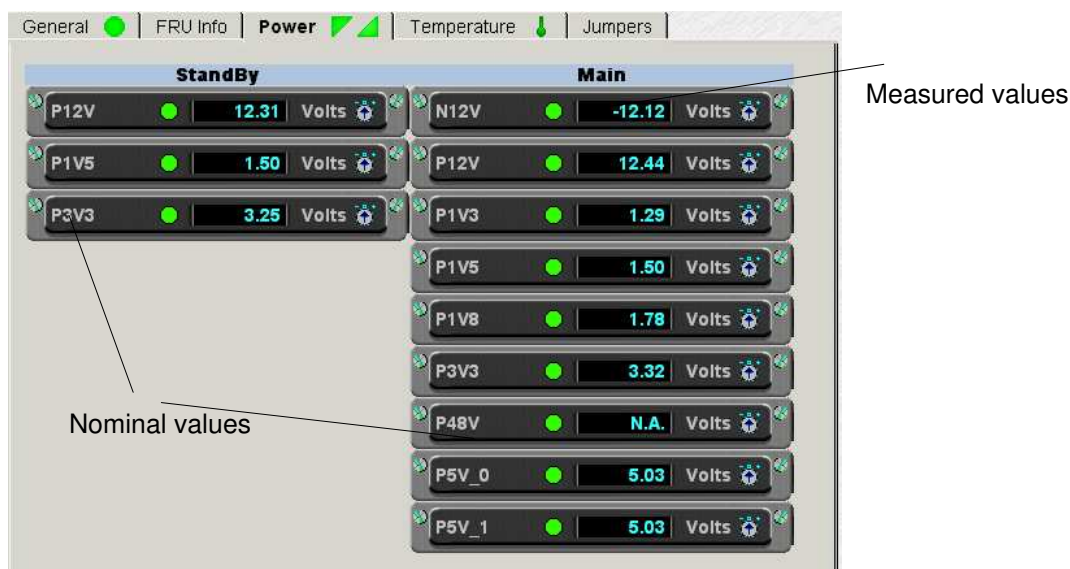

Figure 92. Converter power status details (example)

Indicator	Status	Explanation
Green	MAIN POWER ON	Hardware element main / standby power is on.
Green	STANDBY POWER ON	
White	MAIN POWER OFF	Hardware element main / standby power is off.
White	STANDBY POWER OFF	
Red	MAIN POWER FAULT/FAILED	PAM software has detected 1 or more main / standby power fault(s) on this hardware element.
Red	STANDBY POWER FAULT/FAILED	
Gray	MAIN POWER MISSING/UNKNOWN	PAM software cannot read main / standby power status on this hardware element.
Gray	STANDBY POWER MISSING/UNKNOWN	

Table 28. Power tab status indicators

CSS Module Power Tab

The **Power** tab gives access to power status data for the CSS module DPS units.



48V Presence	Meaning
PRESENT	At least 1 DPS unit is ON.
ABSENT	All DPS units are OFF.
Not Found	PAM software cannot read CSS module power status.
48V Value	Current intensity in Amperes (varies according to configuration).

Figure 93. CSS module power status details



Note:

When a power-specific fault is detected, a fault message is generated and the **General** tab **Display Faults List** button gives direct access to the corresponding logs.

Temperature Tab

The **Temperature** tab gives access to temperature status data for the hardware element, indicating overtemperature or temperature-specific faults.

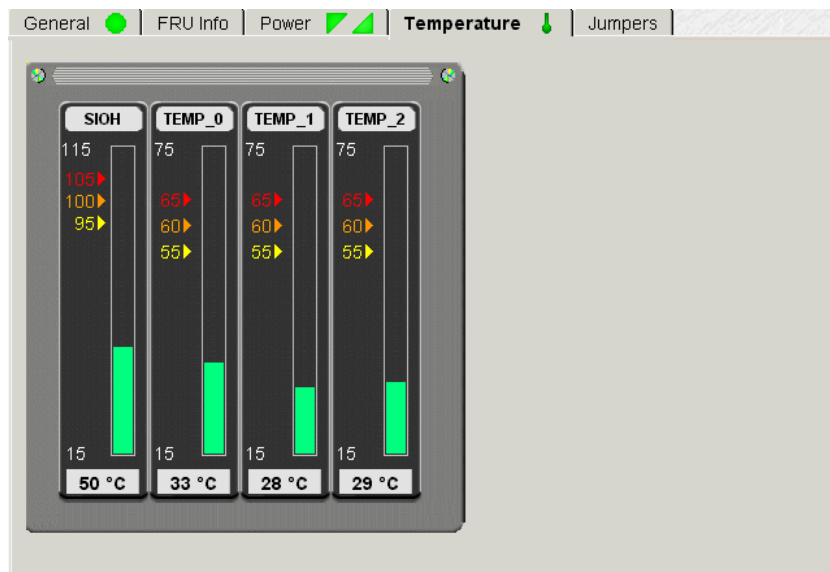

Figure 94. Temperature probe status details (example)





Indicator	Status	Explanation
 Green	NORMAL	Hardware element temperature is normal.
 Yellow	WARNING	PAM software has detected a rise in temperature on this hardware element, but it is still operational and is not jeopardizing system performance.
 Orange	CRITICAL	PAM software has detected a critical rise in temperature on this hardware element. PAM will generate an OS shutdown request.
 Red	FATAL	PAM software has detected a fatal rise in temperature on this hardware element. PAM will automatically shut down the OS.
 Gray	UNKNOWN	PAM software cannot read temperature status on this hardware element.

Table 29. Temperature tab status indicators



Note:

When a temperature-specific fault is detected, a fault message is generated and the **General** tab **Display Faults List** button gives direct access to the corresponding logs.

Fan Status (QBB Fanboxes, SPS Fanboxes and DPS units only)

Fan Status, accessible via the **Fans** tab, indicates fan status, speed and supply voltage. See *Functional Status Indicator*, on page 4-7.

During normal operation, the display depicts fan rotation.

Each fanbox is equipped with 2 hot-swap, redundant, automatically controlled fans.



Note:

If all fans are halted in the display, check that your browser allows you to play animations in Web pages.



Figure 95. Fanbox details (example)

Jumper Status (IOB only)

Reserved for Customer Service Engineers.

Jumper Status, accessible via the **Jumpers** tab, indicates the current position of BIOS Recovery, ClearCMOS, and ClearPassword jumpers. Reserved for Customer Service Engineers.

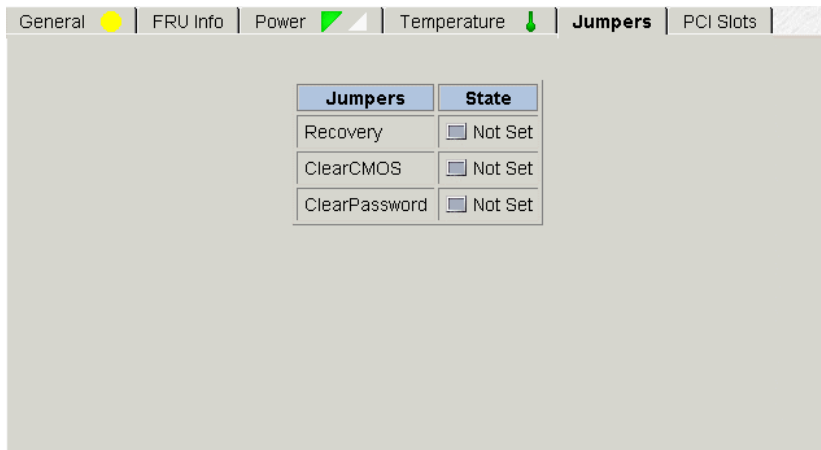
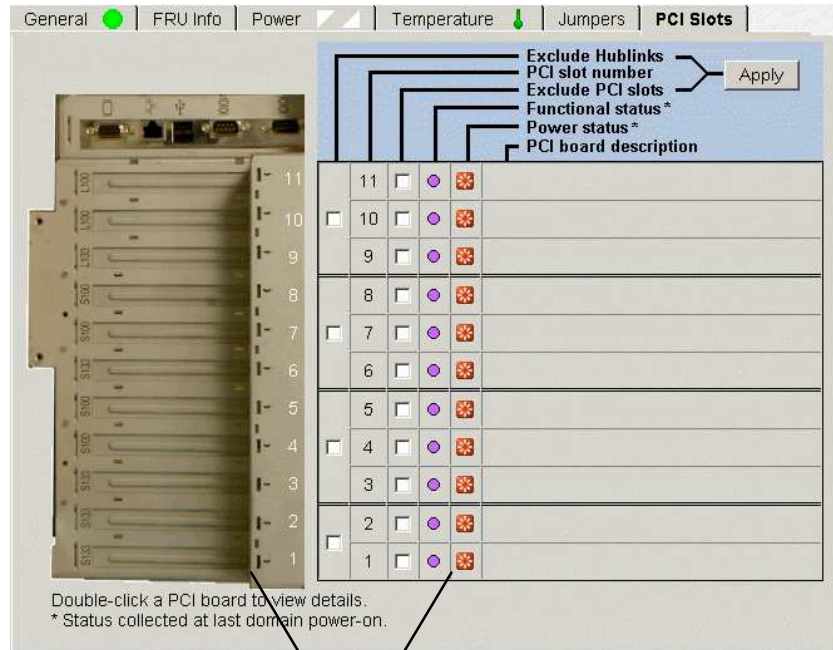

Figure 96. IOB jumpers tab

PCI Slots (IOB only)

PCI Slot Status, accessible via the **PCI Slots** tab, shows PCI board type and the functional and power status of PCI slots at the last domain power-on.

When a fault is detected on a PCI slot, a fault message is generated and an **IOB Faults List** button gives direct access to the list of faults recently encountered on the IOB. The **Exclude** checkboxes are used to exclude / include one or more PCI slots in the domain at the next power-on. See *Excluding / Including Hardware Elements*, on page 4-22.



Power status indicators

Figure 97. PCI slots tab

Clicking a PCI board gives access to **PCI Slot Details**: such as Minor and Signal status, Logical, Bus and Device numbers, Bus and Board frequencies, Vendor, Device and Revision identifiers, and Class code.

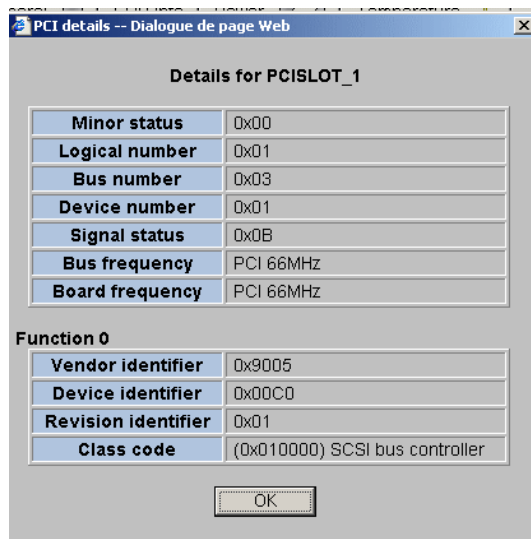

Figure 98. PCI slot details dialog (example)

Excluding / Including Hardware Elements

As Customer Administrator, if a redundant hardware element is faulty, you can logically **Exclude** it from the domain until it has been repaired or replaced. To be taken into account, exclusion requires domain power OFF/ON.

The **Exclusion / Inclusion** function can also be used to logically limit access to certain hardware resources, such as system disks. See *Limiting Access to Hardware Resources*, on page 5-79.

A complete list of logically excluded hardware elements can be obtained via the Hardware Monitor search engine. See *Using the Hardware Search Engine*, on page 4-9.



Important:

Hardware elements must be excluded with care. The exclusion of non-redundant hardware elements will prevent the server domain from booting. Exclusion guidelines are given in the Hardware exclusion guidelines table, on page 4-24.

Excluding a Hardware Element



Important:

The exclusion of a hardware element is only taken into account at the next domain power ON. A complete list of logically excluded hardware elements can be obtained via the Hardware Monitor search engine. See *Using the Hardware Search Engine*, on page 4-9.

1. Check that the hardware element is “excludable” and that exclusion will not affect domain availability. See *Hardware Exclusion Guidelines*, on page 4-24.
2. Click the required hardware element in the **PAM Tree** to open the **Hardware Status** page.

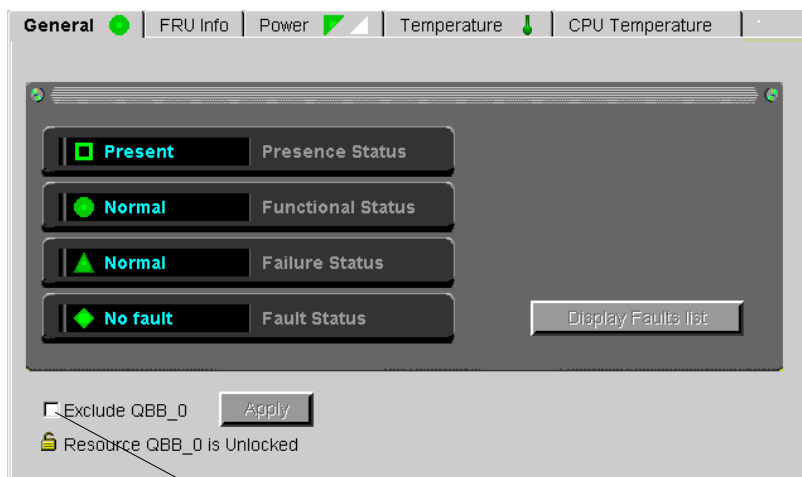

Exclude checkbox

Figure 99. Example Hardware Status page

3. Select the **Exclude** checkbox and click **Apply**. The **Exclude** dialog box opens.
4. Click **Yes** to confirm exclusion of the selected hardware element. Exclusion will be taken into account at the next domain power ON.



Note:

If you want to check domain hardware status, click **Domain Manager** → **Resources** → **More info...** to open the **Domain Hardware Details** page. Hardware elements to be logically excluded at the next domain power ON are marked with a green  icon in the **Excluded State** column. See *Viewing Domain Hardware Resources*, on page 3-35.

Including a Hardware Element



Important:

The inclusion of a hardware element is only effective once the domain has been powered OFF/ON.

1. Click the required hardware element in the **PAM Tree** to open the **Hardware Status** page.

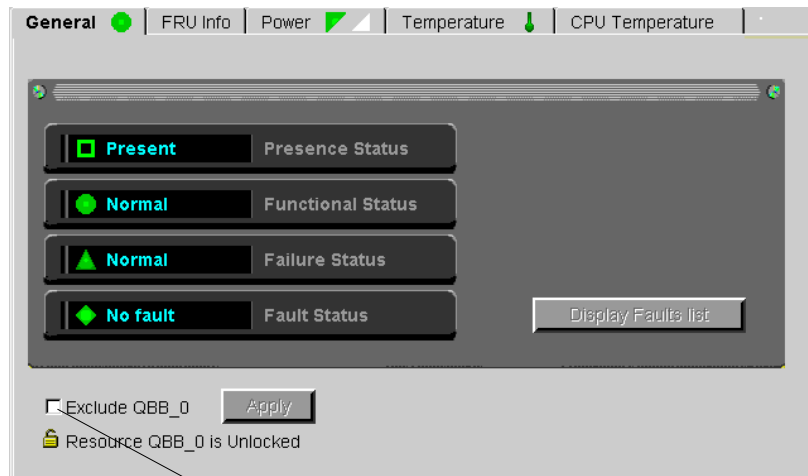

Exclude checkbox

Figure 100. Example Hardware Status page

2. Deselect the **Exclude** checkbox and click **Apply**. The **Include** dialog box opens.
3. Click **Yes** to confirm inclusion of the selected hardware element. Inclusion will be taken into account at the next domain power ON.



Note:

If you want to check domain hardware status, click **Domain Manager** → **Resources** → **More info...** to open the **Domain Hardware Details** page. Hardware elements to be logically included at the next domain power ON are marked with a red  icon in the **Excluded State** column. See *Viewing Domain Hardware Resources*, on page 3-35.

Hardware Exclusion Guidelines

Hardware Element	Exclusion Guidelines - NovaScale 5xx0 Servers
<p>IMPORTANT:</p> <p>To ensure server operation and availability, the following core hardware elements MUST NOT be excluded from the domain:</p> <ul style="list-style-type: none"> • IOB_0, • IOB_0 HubLink_1, • IOR_0, • QBB FanBox_0. 	
IOB	<ul style="list-style-type: none"> • IOB_0 CANNOT be excluded from the domain. The domain will not power up if IOB_0 is excluded. <p>Note: If IOB_0 is excluded, IOR_0 will be automatically excluded.</p> <ul style="list-style-type: none"> • IOB_1 can be excluded, but connected peripherals will no longer be accessible. <p>Note: If IOB_1 is excluded, IOR_1 will be automatically excluded.</p>
IOB HubLink	<ul style="list-style-type: none"> • All IOB HubLinks can be excluded, but connected peripherals will no longer be accessible. <p>Note: If IOB HubLink_1 is excluded, system disks will no longer be accessible.</p>
IOR	<ul style="list-style-type: none"> • IOR_0 CANNOT be excluded from the domain. The domain will not power up if IOR_0 is excluded. • IOR_1 can be safely excluded from the domain, but connected peripherals will no longer be accessible.
QBB	<ul style="list-style-type: none"> • At least one QBB must be “included” in the domain.
CPU	<ul style="list-style-type: none"> • At least one CPU must be “included” in a QBB.
DPS	<ul style="list-style-type: none"> • Only one DPS unit can be safely excluded from the domain at a given time. At least two DPS units are required to ensure server operation.
QBB FanBox	<ul style="list-style-type: none"> • QBB FanBox_0 CANNOT be excluded. If QBB FanBox_0 is excluded, QBB_0, IOB_0 and IOR_0 will be automatically excluded. The domain will not power up if IOB_0 is excluded. • If QBB FanBox_3 is excluded, QBB_3 and IOB_1 will be automatically excluded. Peripherals connected to IOB_1 will no longer be accessible. • If QBB FanBox_1 and/or QBB FanBox_2 are excluded, QBB_1 and/or QBB_2 will be automatically excluded.
SPS FanBox	<ul style="list-style-type: none"> • Only one SPS FanBox can be excluded from the domain at a given time. One SPS FanBox is required to ensure server operation.

Hardware Element	Exclusion Guideline - NovaScale 6xx0 Servers
<p>IMPORTANT: If the following hardware elements are excluded, the corresponding server domain will not power up:</p> <ul style="list-style-type: none"> • Master IOB • Master IOB HubLink 1 • Master IOB PCI Slots 1 & 2 • Master IOR • Master IOB QBB FanBox (0 or 3) <p>Note: When a domain comprises more than one cell (therefore more than one IOB), the Master IOB is the one hosting the boot disk. The other IOBs in the domain are Slave IOBs.</p>	
IOB	<ul style="list-style-type: none"> • Slave IOBs can be safely excluded from a domain, but connected peripherals will no longer be accessible. If the Master IOB is excluded, system disks will no longer be accessible and the domain will not power up.
IOB HubLink	<ul style="list-style-type: none"> • All IOB HubLinks can be safely excluded from a domain, but connected peripherals will no longer be accessible. IOB HubLinks are organized as follows: HubLink_1 controls PCI Slots 1 & 2 HubLink_2 controls PCI slots 3, 4, & 5 HubLink_3 controls PCI slots 6, 7, & 8 HubLink_4 controls PCI slots 9, 10, & 11 If Master IOB HubLink_1 is excluded, system disks will no longer be accessible and the domain will not power up.
PCI Slot	<ul style="list-style-type: none"> • All PCI slots can be safely excluded from a domain, but connected peripherals will no longer be accessible. If Master IOB PCI Slots 1, 2 are excluded, system disks will no longer be accessible and the domain will not power up. See <i>PCI Slots</i>, on page 4-21.
IOR	<ul style="list-style-type: none"> • Slave IORs can be safely excluded from a domain, but connected peripherals will no longer be accessible. If the Master IOR is excluded, the domain will not power up.
QBB	<ul style="list-style-type: none"> • At least one QBB must be “included” in a domain.
CPU	<ul style="list-style-type: none"> • At least one CPU must be “included” in a QBB. If all CPUs are excluded from a QBB, the QBB itself is excluded.
SPS	<ul style="list-style-type: none"> • At least one SPS must be “included” in a Midplane.
DPS Unit	<ul style="list-style-type: none"> • Only one DPS unit can be safely excluded at a given time. At least two DPS units are required to ensure server operation.
QBB FanBox	<ul style="list-style-type: none"> • If QBB FanBox_0 is excluded, QBB_0, IOB_0 and IOR_0 will be automatically excluded. If QBB FanBox_3 is excluded, QBB_3 and IOB_1 will be automatically excluded. If the excluded IOB is a Slave IOB, connected peripherals will no longer be accessible. If the excluded IOB is the Master IOB, system disks will no longer be accessible and the domain will not power up. • If QBB FanBox_1 and/or QBB FanBox_2 are excluded, QBB_1 and/or QBB_2 will be automatically excluded.
SPS FanBox	<ul style="list-style-type: none"> • Only one SPS FanBox can be excluded at a given time. One SPS FanBox is required to ensure server operation.

Table 30. Hardware exclusion guidelines

Viewing and Managing PAM Event Messages and History Files

What You Can Do

- *View Web event messages*
- *Acknowledge Web event messages*
- *Sort and locate Web event messages*
- *View e-mailed event messages*
- *Display the hardware faults list*
- *View history files online*
- *View archive files online*
- *View history files offline*
- *View archive files offline*
- *Manually archive history files*
- *Manually delete archive files*

A comprehensive set of Event Message subscriptions allows connected and non-connected users to be notified of system status and activity. Pre-defined **Event Message Subscriptions** forward event messages for viewing/archiving by targeted individuals and/or groups, with an appropriate subscription, via:

- the PAM Web interface (connected Customer Administrator / Operator),
- User History files (connected Customer Administrator / Operator),
- e-mail (non-connected recipients – Customer Administrator / Operator / other)
- SNMP traps (non-connected recipients – Customer Administrator / Operator / other),
- an autocall to the Bull Service Center (according to your maintenance contract).



Note:

Subscriptions can be customized to suit your working environment. For further details, see *Customizing the PAM Event Messaging System*, on page 5-85.

Understanding Message Severity Levels

Messages are graded into four severity levels as shown in the following table.





Icon	Severity Level	Explanation
	SUCCESS	An action requested by a user has been performed correctly or a function has been completed successfully. Information message, for guidance only.
	INFORMATION	System operation is normal, but status has changed. Information message, for guidance and verification.
	WARNING	An error has been detected and overcome by the system or a processed value is outside standard limits (e.g. temperature). System operation is normal, but you are advised to monitor the hardware concerned to avoid a more serious error. See <i>What to Do if an Incident Occurs</i> , on page 4-37.
	ERROR	An error has been detected and has not been overcome by the system. System integrity is jeopardized. Immediate action is required. See <i>What to Do if an Incident Occurs</i> , on page 4-37.

Table 31. Message severity levels

During normal operation, messages will be marked with the **SUCCESS** or **INFORMATION** icon.



Note:

A single message may have different severity levels. For example, the message `<Unit absent>` may be the result of a:

- **Presence Status** request, indicating component status (information level).
- **Action** request, indicating an error. The command cannot be executed because the component is absent (error level).



Important:

If a message is marked with the **WARNING** or **ERROR** symbol, see *What to Do if an Incident Occurs*, on page 4-37.

Consulting Event Messages, Hardware Faults and History/Archive Files

Whether you consult a **Web Event Message**, the **Hardware Faults List**, a **System / User History** or **Archive**, the resulting display and utilities are the same.

Button	Use
Acknowledge selected events	To remove viewed messages from the pending event list.
Select all events	To select all Ack checkboxes.
Unselect all events	To deselect all Ack checkboxes.
Help	To access context sensitive help.
Search – String – Contained in attribute – Case sensitive	To search for specific messages, according to: – Alphabetic identifier (ID), e.g. 2B2B2214 above. – Message Source, Target, String, Data attributes. – Upper case / lower case letters.
Reset	To delete the current search history.
Ack	To select the message for acknowledgement.
+	To view the message and access context sensitive help.
Help on message	To view the related help message.
Column Header*	Use
Type	To sort messages according to severity level.
ID	To sort messages according to Message Identifier, e.g. 2B2B2214 above.
Local Time	To sort messages according to message local time and date.
Target	To sort messages according to the component referred to in the message.
String	To sort messages according to message text string.

* Double click the column header to sort messages

Figure 101. Display Events page



Important:

If a message is marked with the **WARNING** or **ERROR** symbol, see *What to Do if an Incident Occurs*, on page 4-37.

Specimen Message Help File

The **Help File** explains the message and indicates related actions, where applicable, as shown in Figure 102.

Message ID: 2B2B2214	
Text	Domain < <i>domain name</i> > time out during the power-on sequence
Description	Domain status information.
Actions	<ul style="list-style-type: none">• Wait until the domain turns to the "INACTIVE" state then power ON the domain. See Powering ON a Domain If the problem persists, contact your Customer Service Engineer.
Comments	

Figure 102. Specimen message help file

Viewing and Acknowledging PAM Web Event Messages

To consult Web event messages:

1. From the **Status** pane, click the  icon to open the **Display Events** page. See Figure 101. *Display Events page*, on page 4-28.
2. Click the + sign to expand the required message.
3. Click the **Help on message <xxx>** button at the bottom of the message page for direct access to the corresponding **Help File**. See Table 102 *Specimen message help file*, on page 4-29.

In addition to standard utilities, the **Web Event Message** display allows users to acknowledge messages.



Important:

A maximum of 100 messages are accessible from the Status Pane. Users are advised to regularly acknowledge processed messages to allow the arrival of new messages. Acknowledged messages are stored in the PAMHistory file and can be viewed when required.

See *Viewing, Archiving, and Deleting History Files*, on page 4-31.

To acknowledge Web event messages:

1. Select the required checkbox(es) in the **Ack** column or click **Select all events** to automatically select all checkboxes in the **Ack** column.
2. Click **Acknowledge selected events**.
Acknowledged messages are removed from the pending event list and are no longer accessible via the **Status** pane. The **Pending Event Message Indicator** in the **Status** pane is updated automatically.

Sorting and Locating Messages

From the message display, when you hover the mouse in the **Type** column, an **InfoTip** gives a brief summary of the message allowing you to rapidly scan the list for the required message(s). Use the standard **+** and **-** signs to expand and collapse selected messages.

It may be difficult to locate a message if the list is long, the following short-cuts can be used to organize the display and to locate required messages.

Sorting Messages

Messages can be sorted by clicking a column header to sort the column, e.g. by **Severity (SV)**, **ID**, **Time**, **Target**, **String**. Once sorted, messages will be displayed according to the selected column header.

Locating messages

The **Search** engine can be used to filter the number of displayed logs according to **Source**, **Target**, **String**, **Data** attributes. All four attributes are selected by default, but a single attribute can be selected from the dropdown menu.

To search the message list:

1. If known, enter an alphanumeric message string in the **String** field.
2. Select the required attribute field from the **contained in attribute** dropdown menu.
3. **Case sensitive** is selected by default, deselect if required.
4. Click **Search** to display search results.
5. If you want to carry out another search, click **Reset** to delete the search history.

Viewing E-mailed Event Messages

These messages contain the same information as those available to connected users, but do not contain the corresponding help file. See Figure 101. *Display Events page*, on page 4-28.

Displaying the Hardware Faults List

The **Faults List** page allows you to view messages corresponding to the faults recently encountered by a given hardware element.

To access the **Faults List** page:

1. Toggle the **PAM Tree** to display hardware functional status.
2. Click the faulty element node to open the **Hardware Status** page.
3. Click **Display Faults List** to open the **Faults List** page.
4. Click the **+** sign to expand the required message.
5. Click the **Help on message <xxx>** button at the bottom of the message page for direct access to the corresponding **Help File**.

Viewing, Archiving and Deleting History Files

History and archive files are systematically stored in the **PAMSiteData** directory:

<WinDrive>:\Program Files\BULL\PAM\PAMSiteData\<DataCompatibilityRelease>

The **PAM History Manager** allows you to view, archive and delete history files online and provides you with the tools required to download and view history and archive files offline.

As Customer Administrator / Operator, you will frequently consult **PAMHistory** files for information about system operation.



Note:

System histories and/or archives are only accessible to members of the Customer Administrator group, whereas User histories and/or archives are accessible to members of both the Customer Administrator and Customer Operator groups. For further details about histories and archives, see *Creating a User History*, on page 5-93 and *Editing History Parameters*, on page 5-94.

Viewing History Files Online



Note:

Empty history files cannot be viewed.

To view a history file online:

1. From the **PAM Tree** pane, click **History Manager** to open the Control pane.
2. Select the **Histories** tab.

The screenshot shows the NovaScale History Manager interface. The title bar includes 'NovaScale', 'History Manager', and 'Bull' with a help icon. The main window has two tabs: 'Histories' (selected) and 'Archived histories'. Below the tabs, it says 'All Type Histories: 9'. A table lists the following history entries:

Archive / Basket	Name	Description	Nb Messages	Last archiving date
<input type="checkbox"/>	HistoryTrace	PAPHistory internal trace	3	22/09/04-00:00
<input type="checkbox"/>	InterventionReportHistory	Intervention Report history	0	none
<input type="checkbox"/>	IPMITrace	PAM IPMI Features Trace	0	none
<input type="checkbox"/>	MaestroHistory	Maestro history	0	none
<input type="checkbox"/>	MaestroTrace	Maestro Trace History	0	none
<input type="checkbox"/>	PAMHistory	PAM software history	2	22/09/04-00:00
<input type="checkbox"/>	PAMTrace	PAM software trace	0	22/09/04-00:00
<input type="checkbox"/>	RPCTrace	RPC internal trace history	0	none

Below the table, there are buttons for 'Archive checked histories' and 'Highlighted history'. A message states: 'Empty histories (with 0 messages) cannot be viewed, archived or downloaded.' There are 'View' and 'Properties' buttons next to the highlighted history. At the bottom, there is a section for 'Downloading history or archive files' with buttons for 'Add checked files to basket', 'Show basket details', and 'Download Compressed File'. The status shows '0 Histories, 0 Archives in basket'.

Figure 103. History Manager Control pane – Histories tab

3. Highlight the required type of history and click **View**. All the messages contained in the selected history are displayed.
4. Select the message you want to view in detail. The resulting display is the same as for event messages. See Table 101 *Display Events list*, on page 4-28.

Viewing History Properties

To view history properties:

1. From the **PAM Tree** pane, click **History Manager** to open the Control pane.
2. Select the **Histories** tab.
3. Highlight the required type of history and click **Properties**. The **History Properties** dialog opens.

Name	History name.
Description	Optional description of history contents.
Directory	Pathname of the directory used to store histories. If this field is blank, the default Histories directory is used.
Automatic Archiving Policy	
Type	<p>Number of days: The system will automatically create an archive for this history after the number of days specified in the Value field.</p> <p>Size in KBytes: The system will automatically create an archive when this history reaches the size in KBytes specified in the Value field.</p> <p>Number of Records: The system will automatically create an archive when this history reaches the number of records specified in the Value field.</p>
Value	Number of days / KBytes / records – according to archiving type.
Archive Properties	
Duration	Regular interval at which the archive is automatically deleted.

Figure 104. History properties



Note:

As Customer Administrator, you can modify History properties from the **Histories** Control pane. See *Editing History Parameters*, on page 5-94.

Manually Archiving History Files

In general, history files are automatically archived at regular periods. However, you can choose to manually archive a history file at any time, if required.



Note:

Empty history files cannot be archived.

To manually archive a history file:

1. From the **PAM Tree** pane, click **History Manager** to open the Control pane.
2. Select the **Histories** tab.
3. Select the required type of history checkbox or select the **Archive All** checkbox to archive all histories.
4. Click **Archive checked histories**. A dialog box opens, requesting you to confirm file archiving.
5. Click **OK** to confirm. The selected history(ies) are archived.

Viewing Archive Files Online



Note:

Empty archive files cannot be viewed.

To view an archive file online:

1. From the **PAM Tree** pane, click **History Manager** to open the Control pane.
1. Select the **Archived histories** tab.

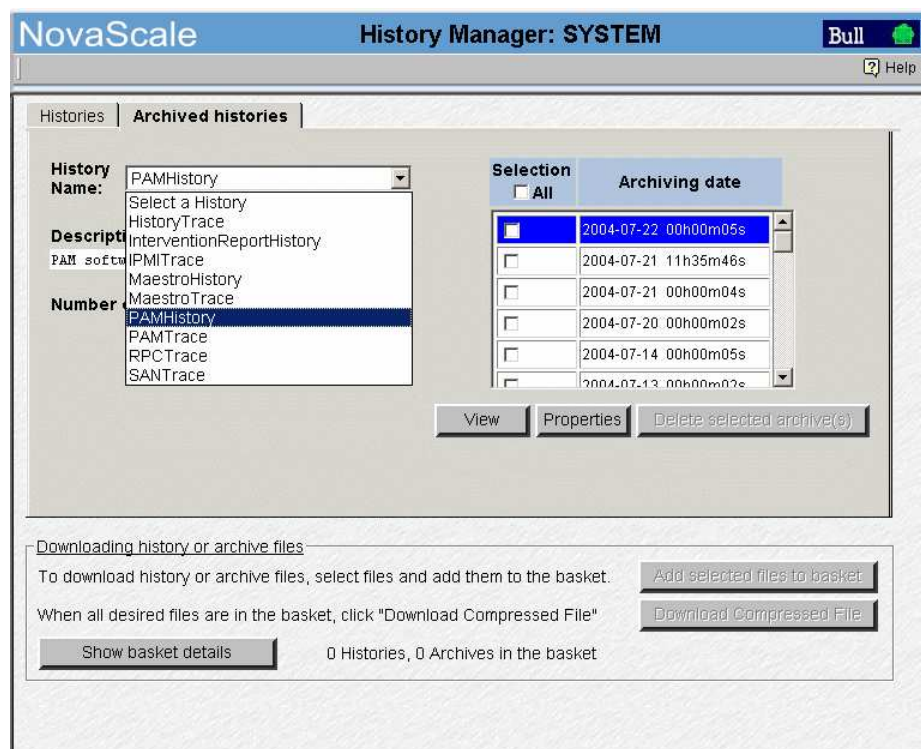

Figure 105. History Manager Control pane – Archived histories tab

2. Use the scroll-down menu to select the type of history archive you want to display. The corresponding list of archived histories appears in the **Archiving date** zone.
3. Highlight the required archiving date and click **View**. All the messages contained in the selected archive are displayed.

4. Select the message you want to view in detail. The resulting display is the same as for event messages. See Table 101 *Display Events list*, on page 4-28.

Viewing Archive Properties

To view archive properties:

1. From the **PAM Tree** pane, click **History Manager** to open the Control pane.
2. Select the **Archived histories** tab.
3. Use the scroll-down menu to select the type of history archive you want to display. The corresponding list of archived histories appears in the **Archiving date** zone.
4. Highlight the required archiving date and click **Properties**. The **Archive Properties** dialog opens.

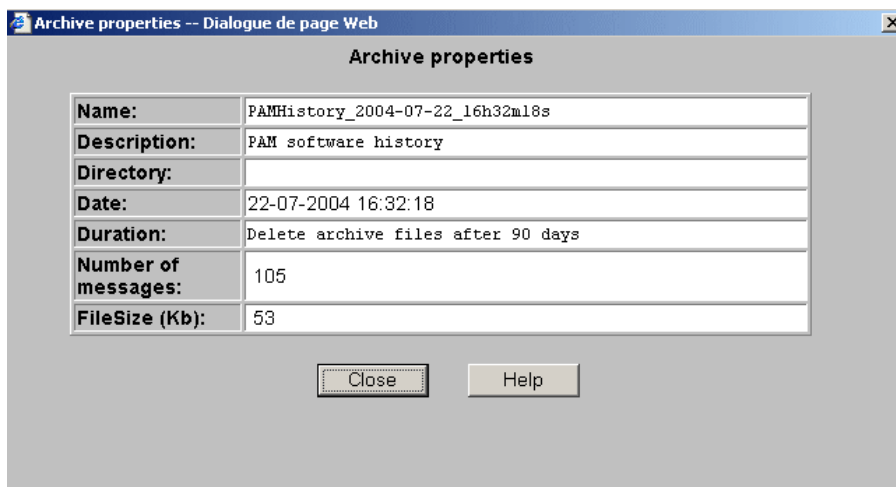

Name	History name, archiving date and time.
Description	Optional description of history contents.
Directory	Pathname of the directory used to store histories. If this field is blank, the default Histories directory is used.
Date	Archiving date and time.
Duration	Regular interval at which the archive is automatically deleted.
Number of messages	Number of messages in the archive.
File Size (Kb)	Archive size in Kb.

Figure 106. Archive properties



Note:

As Customer Administrator, you can modify Archive properties from the **Histories** Control pane. See *Editing History Parameters*, on page 5-94.

Manually Deleting a History Archive File

In general, history archive files are automatically deleted at regular periods. However, you can choose to manually archive a history archive file at any time, if required.

To manually delete a history archive file:

1. From the **PAM Tree** pane, click **History Manager** to open the Control pane.
2. Select the **Archived histories** tab.
3. Use the scroll-down menu to select the type of history archive you want to delete. The corresponding list of archived histories appears in the **Archiving date** zone.
4. Select the required archive checkbox or select the **Delete All** checkbox to delete all archives.
5. Click **OK** to confirm. The selected archives are deleted.

Downloading History / Archive Files for Offline Viewing

The **PAM History Manager** allows you to compress and download history and/or archive files to a local or network directory for offline viewing. The downloaded files can then be viewed with the **History Viewer** tool which displays all the sort options available online, but does not contain the corresponding help file.



Note:

Empty history / archive files cannot be downloaded.

Downloading History Viewer

Before downloading history and/or archive files for offline viewing, you are advised to download the **History Viewer** tool:

1. From the **PAM Tree** pane, click **History Manager** → **Tools**.
2. Click **History Viewer** to download the **HistoryViewer.zip** file.
3. Unzip all the files in the **HistoryViewer.zip** file.

Downloading History / Archive Files

To download history / archive files:

1. From the **PAM Tree** pane, click **History Manager** to open the Control pane.
2. Select the **Histories** or **Archived histories** tab, as required.
3. Select the required type of history or archive:

Histories

- Select the required history checkbox or select the **Basket All** checkbox to download all histories.

Archives

- Use the scroll-down menu to select the required archive. The corresponding list of archived histories appears in the **Archiving date** zone.
- Select the required archive checkbox or select the **Basket All** checkbox to download all archives.

4. Click **Add selected files to basket**.



Note:

Files already selected for downloading can be viewed by clicking **Show basket details**.

5. Click **Download Compressed File** to compress and download the histories/archives to the required local or network directory for offline viewing.

Viewing History / Archive Files Offline

1. Click the **HistoryViewer.htm** file to open the **View History File** page.
2. Complete the **History File Name** field and click **Read**, or click **Browse** to search for and load the required history or archive file.
3. Select the message you want to view in detail. The resulting display is the same as for event messages. See Table 101Display Events list, on page 4-28.



Note:

For further details about histories and archives, see *Creating a User History*, on page 5-93 and *Editing History Parameters*, on page 5-94.

What to Do if an Incident Occurs

Server activity is systematically logged in the **System History** files, which you can view as Customer Administrator at any time.

When an incident occurs, PAM software informs users via:

- the **Status** pane,
- **Event Message / History** file,
- e-mail / **SNMP** traps (users with an appropriate Event Message subscription),
- an **Autocall** to the Bull Service Center (according to your maintenance contract).

In most cases, PAM software handles the incident and ensures operational continuity while the Bull Service Center analyzes the incident and implements the necessary corrective or preventive maintenance measures.

Whenever you are informed of an incident:

- functional or presence status indicators / icon **NOT green**,
- event message or history file marked with the **WARNING** or **ERROR** symbol,

you are advised to connect to the PAM Web site (if you are not already connected) and to investigate the incident.

Investigating Incidents

1. Check the system functional status icon in the **Status** pane. If the icon is not green, the server is not operating correctly. See Table 33. *System Functional Status / Expected Domain State*, on page 4-38.
2. Open the **Domain Manager** Control pane and identify the domain using the faulty hardware element by hovering the mouse over the **Domain Memo**  icons to display the Cell infotip.

NovaScale 6080/6160 Server

Cell 0	Module0_IOB0, Module0_QBB0, Module0_QBB1
Cell 1	Module0_IOB1, Module0_QBB2, Module0_QBB3

NovaScale 6320 Server

Cell 0	Module0_IOB0, Module0_QBB0, Module0_QBB1
Cell 1	Module0_IOB1, Module0_QBB2, Module0_QBB3
Cell 2	Module1_IOB0, Module1_QBB0, Module1_QBB1
Cell 3	Module1_IOB1, Module1_QBB2, Module1_QBB3

Table 32. Domain cells

- If the domain is operating normally, **RUNNING** is displayed in the **Domain State** field.
- If the domain has been automatically powered down, **INACTIVE** is displayed in the **Domain State** field. See Table 33. *System Functional Status / Expected Domain State*, on page 4-38 and Chapter 3. *Managing Domains*, on page 3-1.



Warning:

If system functional status is critical (flashing red icon), immediately save data, close open applications and shut down the domain Operating System.

System Functional Status / Expected Domain State





Icon	System Functional Status	Expected Domain State
 Green	NORMAL	RUNNING
 Yellow	WARNING	RUNNING
 Orange Flashing	CRITICAL	<p>INACTIVE (auto Power OFF) / RUNNING</p> <p>An automatic Power OFF request may be sent by PAM software to the domain Operating System:</p> <ul style="list-style-type: none"> – If the domain Operating System is configured to accept PAM Power OFF requests, it automatically saves data, closes open applications and shuts down. – If the Operating System is not configured to accept PAM Power OFF requests, you are advised to manually save data, close open applications and shut down the Operating System. <p>Note: When system functional status is FATAL, the icon does not always remain red. Therefore, an orange functional status icon may indicate a FATAL hardware status.</p>
 Red Flashing	FATAL	<p>INACTIVE</p> <p>An automatic Force Power OFF command may be performed by PAM software on the domain Operating System.</p> <p>Note: The Operating System does not have time to save data and close applications before it is shut down.</p>
 Purple	NOT ACCESSIBLE	INACTIVE

Table 33. CSS functional status / domain state

3. Toggle the **PAM Tree** to view hardware functional status (round, colored indicator next to the **Hardware Monitor** node). The PAM Tree will automatically expand down to the faulty hardware element.
4. Check domain state by clicking **Domain Manager** in the PAM tree.
5. Click the faulty hardware element to open the corresponding **Hardware Status** page.
6. Check **Power** and **Temperature** tabs. If a power and/or temperature indicator is NOT green, a power– and/or temperature–specific fault has occurred. See *Power Status Indicators* and *Temperature Status Indicators*, on page 4-17.
7. Click **Display Faults List** for direct access to server logs. If the **Display Faults List** button is not accessible, click **History Manager** → **System** → **PAM History** for the corresponding log. See *Displaying Detailed Hardware Status*, on page 4-14.
8. Expand the log for direct access to the corresponding **Help File** (at the bottom of the page). The **Help File** explains the message and how to deal with the incident.



Important:

To maintain a trace of transient faults, PAM Tree functional and/or presence status indicators will not change color until the domain has been powered OFF/ON, even although the error has been corrected.

Dealing with Incidents

When you open the incident **Help File**, you may be requested to perform straightforward checks and actions or to contact your Customer Service Engineer. This section explains how to respond to the following requests:

- *Check Environmental Conditions*
- *Check Hardware Availability*
- *Check Hardware Connections*
- *Exclude a Hardware Element*
- *Check Hardware Exclusion Status*
- *Check Hardware Fault Status*
- *Check Power Status*
- *Check Temperature Status*
- *Check Histories and Events*
- *Check SNMP Settings*
- *Check Autocall Settings*
- *Check PAM Version*
- *Check MAESTRO Version*
- *Check Writing Rules*
- *Power ON/OFF the Domain*
- *Reboot the PAP Application*
- *Modify LUN Properties*
- *Check, Test, and Reset the PMB*

Checking Environmental Conditions

If you are requested to check environmental conditions, ensure that the computer room is compliant with the specifications set out in Appendix A. *Specifications*.

Checking Hardware Availability

If you are requested to check hardware availability:

1. Check that the CSS module availability status bar is green. If the status bar is not green, the CSS module has not been detected by PAM software. Check the physical PMB to PAP unit Ethernet link connection.
2. Toggle the **PAM Tree** to view hardware presence status (square, colored indicator next to the **Hardware Monitor** node).
3. Expand the **Hardware Monitor** node to view the presence status of all hardware elements. If a hardware presence status indicator is NOT green, the hardware element is either missing or not accessible.



Important:

If a PAM Tree hardware presence status indicator is not green, this could be normal if the corresponding hardware element has been removed for maintenance.

Checking Hardware Connections

If you are requested to check hardware connections, use *Cabling Diagrams* to manually and visually ensure that all cables are correctly inserted in their corresponding hardware ports.

Excluding a Hardware Element and Checking Exclusion Status

As Customer Administrator, you can logically **Exclude** a redundant hardware element from the domain until it has been repaired or replaced. Exclusion is taken into account at the next domain power ON. See *Excluding / Including Hardware Elements*, on page 4-22.

If you are requested to check hardware exclusion status, use the **Hardware Search** engine to search for and view **Excluded** hardware elements. See *Using the Hardware Search Engine*, on page 4-9.

You can also view domain hardware exclusion status from the **Domain Hardware Details** page. See *Viewing Domain Hardware Resources*, on page 3-35.

Checking Hardware Fault Status

If you are requested to check hardware fault status:

1. Click the corresponding hardware element in the PAM Tree to open the **Hardware Status** page.
2. Check the **General** tab. If the fault status indicator is NOT green, a fault has occurred. See *Fault Status Indicators*, on page 4-15.

Checking Hardware Power Status

If you are requested to check hardware power status:

1. Click the corresponding hardware element in the PAM Tree to open the **Hardware Status** page.
2. Check the **Power** tab. If a power indicator is NOT green, a power-specific fault has occurred. See *Power Status Indicators*, on page 4-17.

Checking Hardware Temperature Status

If you are requested to check temperature status:

1. Click the corresponding hardware element in the PAM Tree to open the **Hardware Status** page.
2. Check the **Temperature** tab. If a temperature indicator is NOT green, a temperature-specific fault has occurred. See *Temperature Status Indicators*, on page 4-19.

Checking Histories and Events

If you are requested to check histories / events, refer to *Viewing and Managing Event Messages and History Files*, on page 4-26.

Checking SNMP Settings

If you are requested to check SNMP settings, IP address, or server name for an event subscription:

1. From the PAM Tree, click **Configuration Tasks** → **Events** → **Channels** and check that the **SNMP Channel** is enabled.
2. Click **Subscriptions** to view configured subscriptions. Channel type is indicated in the **Channel** column.
3. Select the required **SNMP Channel** subscription from the list and click **Edit** to view / modify **SNMP** settings.

Checking Autocall Settings

If you are requested to check Autocall settings:

1. From the PAM Tree, click **Configuration Tasks** → **Autocalls** and check that the **Enable Autocalls** checkbox is selected.
2. Check dispatch modes and corresponding settings.

Checking PAM Version

If you are requested to check PAM version:

From the PAM Tree, click **PAP** to display the **PAP Unit Information** page. PAM version is displayed at the top of the page.

Checking MAESTRO Version

If you are requested to check MAESTRO version:

From the PAM Tree, click **Hardware Monitor** → **PMB** to open the **PMB Status** page. Click the **FIRMWARE** tab to view MAESTRO version.

Checking Writing Rules

If you are requested to check writing rules, see *PAM Writing Rules*, on page xxiii.

Powering OFF/ON a Domain

If you are requested to Power OFF/ON or Force Power OFF a domain, ensure that you have saved data and closed open applications. See *Managing Domains*, on page 3-1.

Rebooting the PAP Application

If you are requested to reboot the PAP application:

1. From the Microsoft Windows home page, click **Start** → **Programs** → **Administrative Tools** → **Component Services**.
2. From **Component Services**, click **Console Root** → **Component Services** → **Computers** → **My Computer** → **COM+ Applications** → **PAP**.
3. Right click **PAP** to open the shortcut menu. Click **Shutdown**.
4. Activate the required PAM version to reboot the PAP application. See *Deploying a PAM Release*, on page 5-28 and *Activating a PAM Version*, on page 5-29.

Modifying LUN Properties

If you are requested to modify LUN properties:

- Refer to *Configuring SCSI Data Disks*, on page 5-4 and to the appropriate Disk Subsystem documentation.
- Refer to *Configuring FDA Data Disks*, on page 5-8 and to the appropriate Disk Subsystem documentation.

Checking, Testing and Resetting the PMB

The PMB is located in the module at the base of the cabinet and links the server to the PAP unit via an Ethernet link. You may be required to carry out the following checks / actions:

- Check that PMB LED #0 is blinking green (PMB booted correctly):
When the system is powered on, the 7 activity and status LEDs (LED #1–LED #7) are switched off and LED #0 is blinking. See *PMB Leds and Code Wheels*, on page 4-44.
- Check PMB code wheel settings. See *PMB Leds and Code Wheels*, on page 4-44.
- Check that the Ethernet cable linking the server to the PAP unit is correctly inserted and that the Ethernet link LED is green.
- Check the PAP – PMB link by pinging the PAP and the PMB:

PAP Address	PMB 0 Address	PMB 1 Address
10.10.240.240	10.10.0.1	10.10.0.2

- Reset the PMB by pressing the RESET button. PMB firmware will be rebooted. See *PMB Leds and Code Wheels*, on page 4-44.

PMB LEDs and Code Wheels

Up to 16 Central Subsystems can be linked, via Platform Management Boards (PMBs) to a single PAP unit, to provide a single point of administration and maintenance.

Each PMB is equipped with two code wheels used to identify each Central Subsystem and each CSS module in your configuration. These code wheels are set prior to shipping (factory default setting), according to configuration.

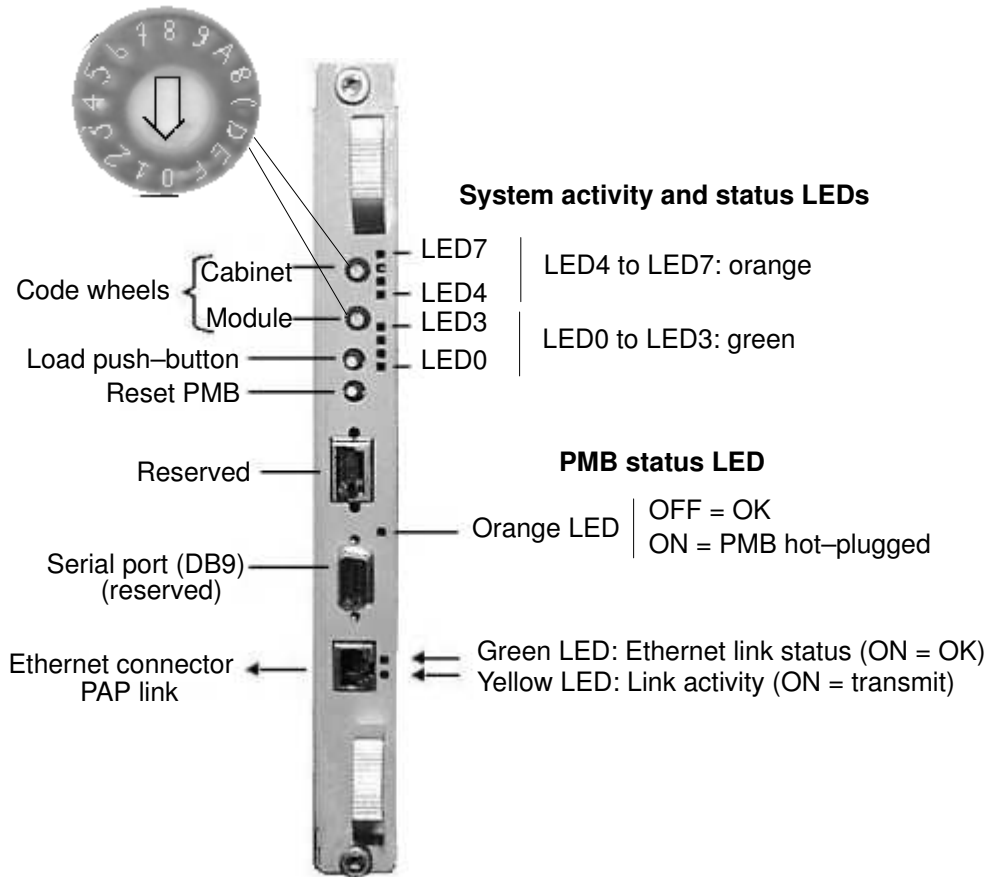

Figure 107. PMB LED location

PMB Code Wheel Settings

For guidance, PMB code wheel settings are indicated in the following table.

CSS	CSS PMB Code Wheel	CSS HW Identifier	CSS Module PMB Code Wheel	
			CSS Module 0	CSS Module 1
1st	0	00	0	1
2nd	1	01	0	1
3rd	2	02	0	1
4th	3	03	0	1
5th	4	04	0	1
6th	5	05	0	1
7th	6	06	0	1
8th	7	07	0	1
9th	8	08	0	1
10th	9	09	0	1
11th	A	10	0	1
12th	B	11	0	1
13th	C	12	0	1
14th	D	13	0	1
15th	E	14	0	1
16th	F	15	0	1

Table 34. PMB code wheel settings

Chapter 5. Tips and Features for Administrators

This chapter explains how, as Customer Administrator, you can configure the server to suit your working environment. It includes the following sections:

- Section I – Setting up Server Users and Configuring Data Disks, on page 5-2
- Section II – Using EFI Utilities, on page 5-12
- Section III – Customizing PAM Software, on page 5-21
- Section IV – Configuring Domains, see page 5-33
- Section V – Creating Event Subscriptions and User Histories, on page 5-84



Notes:

Customer Administrators and Customer Operators are respectively advised to consult the *Administrator's Memorandum*, on page xxvi or the *Operator's Memorandum*, on page xxviii for a detailed summary of the everyday tasks they will perform.

Before proceeding to configure the server, please refer to *PAM Writing Rules*, on page xxiii.

For further information about user accounts and passwords, see *Setting up PAP Unit Users*, on page 5-22.



Important:

Certain domain configuration and management tools are reserved for use with partitioned servers and extended systems. Please contact your Bull Sales Representative for sales information.

Section I – Setting up Server Users and Configuring Data Disks

This section explains how to:

- Set up Server Users, on page 5-3
- Configure SR-0812 SCSI RAID and SR-1422 SCSI RAID Data Disks, on page 5-4
- Configure FDA 1x00 FC and FDA 2x00 FC Data Disks, on page 5-8

Setting up Server Users

As Customer Administrator, you must set up user accounts and passwords to control access to the server.

The operating system pre-installed on the server provides standard security features for controlling access to applications and resources.

For further details, refer to the Microsoft Windows / Linux documentation, as applicable.



Note:

You are advised to maintain a detailed record of authorized users.

Microsoft Windows

Default user access control is not pre-configured on systems running under Microsoft Windows.

You are advised to set up the Administrator account before proceeding to set up users and groups via the standard Microsoft Windows administration tools.

Linux

Two default users are pre-configured on systems running under Linux:

	User Name	Password
Administrator	root	root
User	linux	root

You are advised to change the default Administrator name and password before proceeding to set up users and groups via the standard Linux administration tools.

Configuring SCSI Data Disks

For optimum storage, security and performance, the server is delivered with one or two pre-configured disk racks.

The addition of data disks involves the creation of a new array and new array partitions (LUNs) via the embedded **Disk Array Administrator** software.



Note:

Delivered storage sub-systems vary according to Customer requirements.

SJ-0812 SCSI JBOD Disk Rack

According to version, the server is delivered with one or two SJ-0812 SCSI JBOD disk rack(s) each containing two RAID #1 system disks per domain and one pool spare disk, and offers two free slots for data disks.

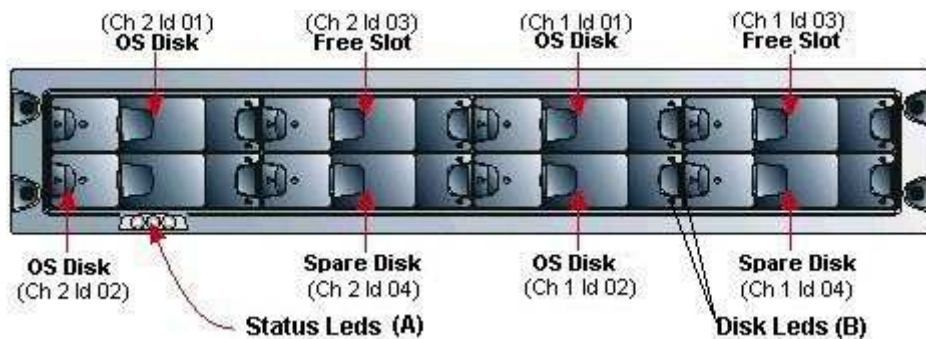

	OS Disks (RAID #1)	Spare Disks (Pool)
SJ-0812 SCSI JBOD disk rack 1 Cell 0 (CSS Module_0, IOB_0)	Ch 2 Id 01 Ch 2 Id 02	Ch 2 Id 04
SJ-0812 SCSI JBOD disk rack 1 Cell 1 (CSS Module_0, IOB_1)	Ch 1 Id 01 Ch 1 Id 02	Ch 1 Id 04
SJ-0812 SCSI JBOD disk rack 2 Cell 2 (CSS Module_1, IOB_0)	Ch 2 Id 01 Ch 2 Id 02	Ch 2 Id 04
SJ-0812 SCSI JBOD disk rack 2 Cell 3 (CSS Module_1, IOB_1)	Ch 1 Id 01 Ch 1 Id 02	Ch 1 Id 04

Figure 108. SJ-0812 SCSI JBOD disk configuration

SJ-0812 SCSI JBOD / SR-0812 SCSI RAID Disk Rack

The server is delivered with one SJ-0812 SCSI JBOD / SR-0812 SCSI RAID disk rack containing two RAID #1 system disks and two pool spare disks, and offers four free slots for data disks.

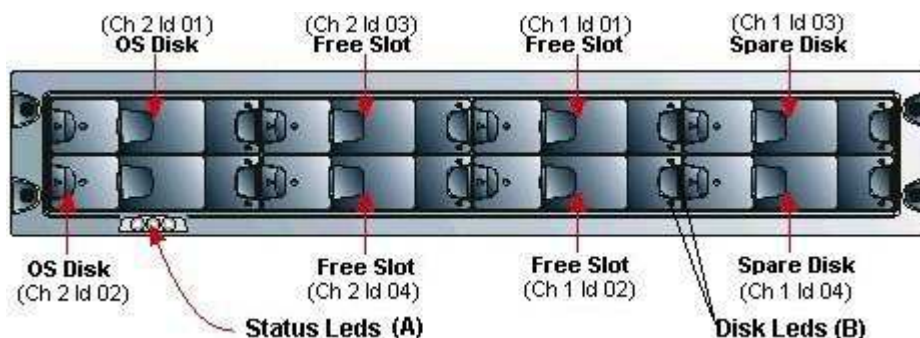

	OS Disks (RAID #1)	Spare Disk
SR-0812 SCSI RAID disk rack	Ch 2 Id 01 Ch 2 Id 02	Ch 1 Id 03 Ch 1 Id 04

Figure 109. SJ-0812 SCSI JBOD/SR-0812 SCSI RAID disk configuration

SR-0812 SCSI RAID Disk Rack

The server is delivered with two SR-0812 SCSI RAID disk racks (one per domain). Each disk rack contains two RAID #1 system disks and one pool spare disk, and offers five free slots for data disks.

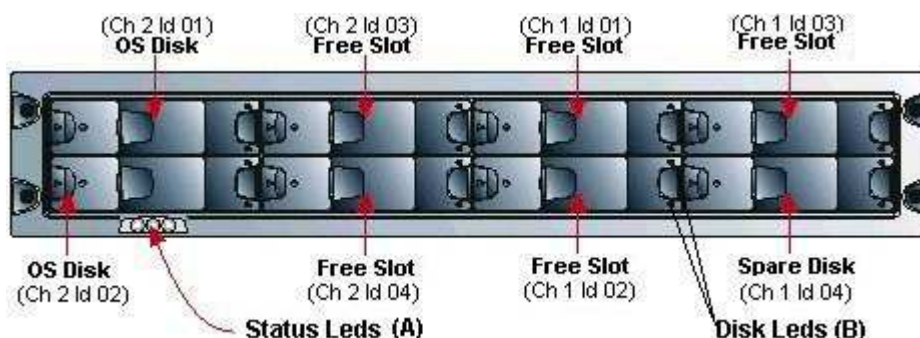

	OS Disks (RAID #1)	Spare Disk
SR-0812 SCSI RAID disk rack 1 Cell 0 (CSS Module_0, IOB_0)	Ch 2 Id 01 Ch 2 Id 02	Ch 1 Id 04
SR-0812 SCSI RAID disk rack 2 Cell 1 (CSS Module_0, IOB_1)	Ch 2 Id 01 Ch 2 Id 02	Ch 1 Id 04
SR-0812 SCSI RAID disk rack 1 Cell 2 (CSS Module_1, IOB_0)	Ch 2 Id 01 Ch 2 Id 02	Ch 1 Id 04
SR-0812 SCSI RAID disk rack 2 Cell 3 (CSS Module_1, IOB_1)	Ch 2 Id 01 Ch 2 Id 02	Ch 1 Id 04

Figure 110. SR-0812 SCSI RAID disk configuration

SR-1422 SCSI RAID Disk Rack

The server is delivered with one SR-1422 SCSI RAID disk rack containing four system disks (two RAID#1 and two spare disks) and offers ten empty slots for data disks.

The SR-1422 SCSI RAID disk rack is equipped with two RAID controller cards. If you want to separate the channels used for System and Data disks, call your Customer Service Engineer.

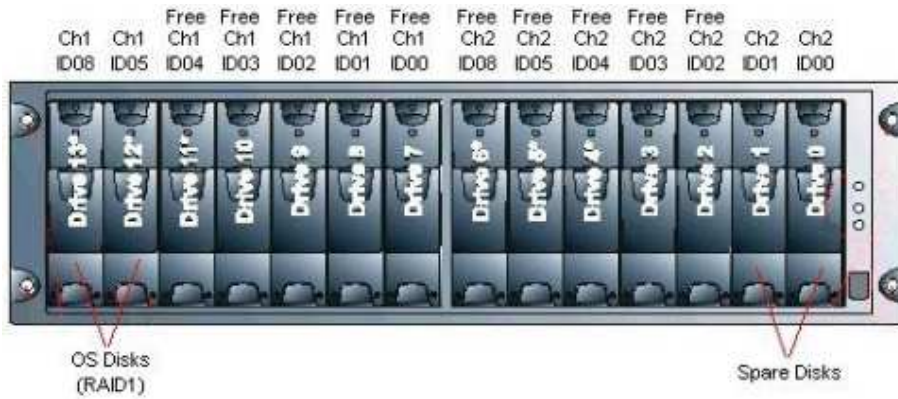

	OS Disks (RAID #1)	Spare Disks (Pool)
SR-1422 SCSI RAIDdisk rack	Ch 1 Id 08 Ch 1 Id 05	Ch 2 Id 01 Ch 2 Id 00

Figure 111. SR-1422 SCSI RAID disk rack

Creating a New Disk Array

1. From the Microsoft Windows desktop on the PAP unit, launch a HyperTerminal session with the following parameters:

Parameter	Value
Name	Disk Rack
Connect using	COM1 or COM2
Bits per second	115200
Data bits	8
Parity	None
Stop bits	1
Flow control	None
Emulation	ANSI

Table 35. HyperTerminal parameters

2. Press **CTRL-R** to refresh the screen and display the initial Disk Array Administrator screen.
3. Press **Enter** to display the System Menu.
4. Select **Add an Array**.
5. Enter the name of the Array: e.g. **Data**.
6. Enter the RAID level, number of disks and disk ID.
7. When prompted to **Create one partition now for entire Array?**, select **NO** to create a Multiple-Partition Array.
8. Select **Array parameters**.

9. Select the required number of free drives:

	Free Slots (population order)
SJ-0812 SCSI JBOD disk rack	N/A
SR-0812 SCSI RAID disk rack	Ch 2 ld 03 Ch 2 ld 04 Ch 1 ld 01 Ch 1 ld 02 Ch 1 ld 03
SR-0812 SCSI RAID disk rack	Ch 2 ld 03 Ch 2 ld 04 Ch 1 ld 01 Ch 1 ld 02
SR-1422 SCSI RAID disk rack	Ch 1 ld 04 Ch 1 ld 03 Ch 1 ld 02 Ch 1 ld 01 Ch 1 ld 00 Ch 2 ld 08 Ch 2 ld 05 Ch 2 ld 04 Ch 2 ld 03 Ch 2 ld 02

Table 36. SCSI data disk population order

10. Select **Array Init options: Offline Initialization**.

11. When prompted to confirm, enter **YES**.

Creating a New Array Partition

1. Select **Array Menu**.
2. Select **Data Array** and press **Enter**.
3. Select **Add a Partition**.
4. Enter the size of the disk partition, e.g. **10,000 MB**.
5. Enter the name of the disk partition: e.g. **USER1**.
6. Enter a LUN number or select the suggested LUN number (from 0 to 63).
7. Repeat this procedure for each new disk partition.

The new Array and associated disk partitions are now configured for use.



Note:

For further details, refer to the appropriate Disk Subsystem documentation.

Configuring FC Data Disks

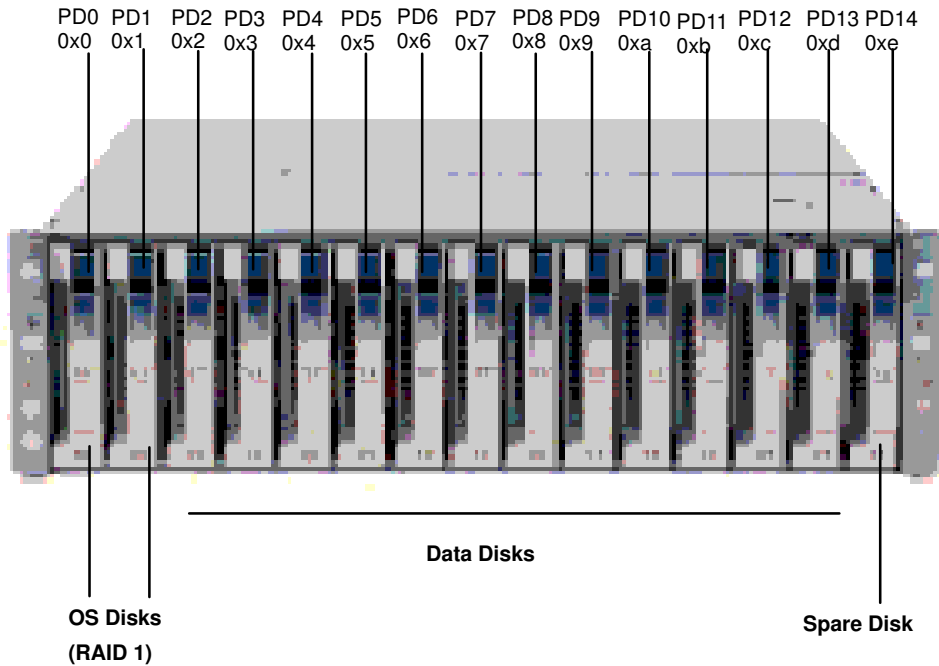

Figure 112. FDA 1x00 FC / FDA 2x00 FC disk rack

FDA 1x00 FC Disk Rack

According to version, the server is delivered with one or two FDA 1x00 FC disk rack(s) each containing two RAID #1 system disks per domain and one pool spare disk, and offers ten free slots for data disks. Slots are numbered from 0 to 14.

	OS Disks (RAID #1)	Spare Disk
NovaScale 5xx0 Server		
FDA 1x00 FC disk rack	PD0 PD1	PD14
FDA 2x00 FC disk rack	PD0 PD1	PD14

FDA 2x00 FC Disk Rack

The server is delivered with one FDA 2x00 FC disk rack containing two RAID #1 system disks per domain and one pool spare disk, and offers ten free slots for data disks. Slots are numbered from 0 to14.

	OS Disks (RAID #1)	Spare Disk
NovaScale 6080/6160 Server		
FDA 1x00 FC disk rack 1 controller #0 Cell_0, IOB_0	PD0 PD1	PD14
FDA 1x00 FC disk rack 1 controller #1 Cell_1, IOB_1	PD2 PD3	
NovaScale 6320 Server		
FDA 1x00 FC disk rack 1 controller #0 Cell_0, CSS Module_0, IOB_0	PD0 PD1	PD14
FDA 1x00 FC disk rack 1 controller #1 Cell_1, CSS Module_0, IOB_1	PD2 PD3	
FDA 1x00 FC disk rack 2 controller #0 Cell_2, CSS Module_1, IOB_0	PD0 PD1	PD14
FDA 1x00 FC disk rack 2 controller #1 Cell_3, CSS Module_1, IOB_1	PD2 PD3	
FDA 2x00 FC disk rack 1 controller #0 Cell_0, CSS Module_0, IOB_0 Cell_1, CSS Module_0, IOB_1	PD0 PD1	PD14
FDA 2x00 FC disk rack 1 controller #1 Cell_2, CSS Module_1, IOB_0 Cell_3, CSS Module_1, IOB_1	PD2 PD3	

Table 37. FDA 1x00 FC / FDA 2x00 FC disk configuration

Creating a New Logical Data Disk



Note:

For optimum storage, performance, and reliability, you are advised to use RAID level 5 for data disk configuration.

1. From the Microsoft Windows desktop on the PAP unit, launch iSM Client.

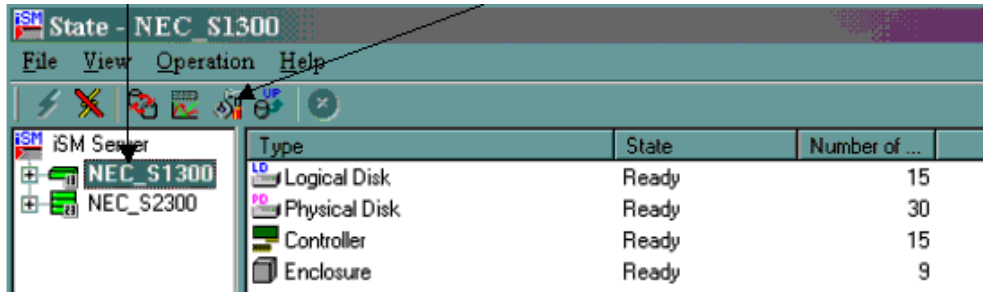

Figure 113. iSM Client interface

2. Select the disk subsystem and click the **Configuration** icon. The **Select Operation Mode** page opens.
3. Click **Setting**. The **Configuration [Setting Mode]** page opens.
4. Click **LD Bind/Unbind**. The **LD Individual Bind/Unbind** page opens.
5. Select the disks to be bound in the RANK.



Note:

At least three disks must be selected to create a RAID#5 RANK.

6. Click **RANK Bind**. The **RANK Bind** page opens.
7. Specify **RAID Type** and **Rebuild Time** and click **OK**. A confirmation dialog box opens.
8. Click **OK** to return to the **LD Individual Bind/Unbind** page.
9. Wait for the rank bind operation to finish.
10. Select the **LD** tab. Click **Unused** → **LD Bind**. The **LD Individual Bind** page opens.
11. Check the **Specify both the number of LDs and LD Capacity** radio button and enter the required values.

12. Assign LUN ownership to the required controller:

NovaScale 5xx0 Server

- Controller 1

NovaScale 6xx0 Server

- FDA 1x00 FC Disk Racks
 - . Disk Rack 1, Controller 0 for Cell 0 (CSS Module_0, IOB_0)
 - . Disk Rack 1, Controller 1 for Cell 1 (CSS Module_0, IOB_1)
 - . Disk Rack 2, Controller 0 for Cell 2 (CSS Module_1, IOB_0)
 - . Disk Rack 3, Controller 1 for Cell 3 (CSS Module_1, IOB_1)
- FDA 2x00 FC Disk Racks
 - . Disk Rack 1, Controller 0 for Cell 0 and Cell 1 (CSS Module_0, IOB_0, IOB_1)
 - . Disk Rack 1, Controller 1 for Cell 2 and Cell 3 (CSS Module_1, IOB_0, IOB_1)

13. Click **OK**. A confirmation dialog box opens.

14. Click **Yes** → **OK** to return to the **LD Individual Bind/Unbind** page and click **Close**. The new logical disk appears in the iSM Server tree.



Note:

For further details, refer to the appropriate Disk Subsystem documentation.

Section II – Using EFI Utilities

This section explains how to:

- Use the EFI Boot Manager, on page 5-13
- Use the EFI Shell, on page 5-15
- Use the EFI to Set up and Configure a Network, on page 5-19
- Use the EFI to Load FTP Server / Client, on page 5-20

Using the EFI Boot Manager

The EFI (Extensible Firmware Interface) Boot Manager allows you to control the server's booting environment. From the Boot Manager, you can choose to invoke the Extensible Firmware Interface (EFI) Shell or to go to the Boot Option Maintenance Menu.



Warning:

The EFI shell can only manage QWERTY keyboards. If you have an AZERTY keyboard, please refer to the AZERTY/QWERTY keyboard lookup table on page xxv.

To enter the EFI Boot Manager:

1. From the PAM Tree, click **Domain Manager** → **Power ON** to power up the required domain.
2. From the keyboard, press the **Control** key twice to display the KVM Switch Command Menu.
3. Select the required system channel port with the $\uparrow\downarrow$ keys, according to configuration. See Table 4. *KVM port configuration*, on page 2-8.
4. Press **Enter** to activate the required system channel and exit the Command Mode.



Note:

The system automatically boots on the first option in the list without user intervention after a timeout. To modify the timeout, use **Set Auto Boot Timeout** in the Boot Option Maintenance Menu.

5. From the Boot Manager Menu, select the EFI Shell option with the $\uparrow\downarrow$ keys and press **Enter**.

EFI Boot Manager Options

EFI Shell

A simple, interactive environment that allows EFI device drivers to be loaded, EFI applications to be launched, and operating systems to be booted. The EFI shell also provides a set of basic commands used to manage files and the system environment variables. For more information on the EFI Shell, refer to The Extensible Firmware Interface (EFI) Shell on page 5-15.

Boot Options

Files that you include as boot options. You add and delete boot options by using the Boot Maintenance Menu. Each boot option specifies an EFI executable with possible options. For information on the Boot Maintenance Menu options, refer to Table 38.

Boot Option Maintenance Menu

The EFI Boot Maintenance Manager allows the user to add boot options, delete boot options, launch an EFI application, and set the auto boot time out value.

If there are no boot options in the system (and no integrated shell), the Boot Maintenance Menu is presented. If boot options are available, then the set of available boot options is displayed, and the user can select one or choose to go to the Boot Maintenance Menu.

If the time out period is not zero, then the system will auto boot the first boot selection after the time out has expired. If the time out period is zero, then the EFI Boot Manager will wait for the user to select an option. Table 38 describes each menu item in the Boot Maintenance Menu.

**Note:**

You can use the → ← ↑↓ keys to scroll through the Boot Maintenance Menu.

Boot Option	Description
Boot from a File	<p>This option searches all the EFI System Partitions in the system.</p> <p>For each partition it looks for an EFI directory. If the EFI directory is found, it looks in each of the subdirectories below EFI.</p> <p>In each of those subdirectories, it looks for the first file that is an executable EFI Application.</p> <p>Each of the EFI Applications that meet this criteria are automatically added as a possible boot option. In addition, legacy boot options for A: and C: are also added if those devices are present.</p> <p>This option allows the user to launch an application without adding it as a boot option.</p> <p>The EFI Boot Manager will search the root directories and the \EFI\TOOLS directories of all of the EFI System Partitions present in the system for the specified EFI Application.</p>
Add a Boot Option	<p>Allows the user to specify the name of the EFI Application to add as a boot option.</p> <p>The EFI Boot Manager searches the same partitions and directories as described in <i>Boot from a File</i>, until it finds an EFI Application with the specified name.</p> <p>This menu also allows the user to provide either ASCII or UNICODE arguments to the option that will be launched.</p>
Delete Boot Options	<p>Allows you to delete a specific boot option or all boot options. Highlight the option you want to delete and enter <d>. Enter <y> to confirm.</p>
Change Boot Order	<p>Allows you to control the relative order in which the EFI Boot Manager attempts boot options. To change the boot order, highlight the boot option and enter <u> to move the item up one order, <d> to move the item down one order. For help on the control key sequences you need for this option, refer to the help menu.</p>
Manage Boot Next Setting	<p>Allows you to select a boot option to use one time (the next boot operation).</p>
Set Auto Boot Timeout	<p>Allows you to define the value in seconds that pass before the system automatically boots without user intervention. Setting this value to zero disables the timeout feature.</p>
Cold Reset	<p>Performs a platform-specific cold reset of the system. A cold reset traditionally means a full platform reset.</p>
Exit	<p>Returns control to the EFI Boot Manager main menu. Selecting this option will display the active boot devices, including a possible integrated shell (if the implementation is so constructed).</p>

Table 38. Boot Option Maintenance Menu

Using the EFI Shell

The EFI (Extensible Firmware Interface) Shell is a simple, interactive user interface that allows EFI device drivers to be loaded, EFI applications to be launched, and operating systems to be booted. In addition, the Shell provides a set of basic commands used to manage files and the system environment variables.

The EFI Shell supports command line interface and batch scripting.



Warning:

The EFI shell can only manage QWERTY keyboards. If you have an AZERTY keyboard, please refer to the AZERTY/QWERTY keyboard lookup table on page xxv.

Entering the EFI Shell

To enter the EFI Shell:

1. From the PAM Tree, click **Domain Manager** → **Power ON** to power up the required domain.
2. From the keyboard, press the **Control** key twice to display the KVM Switch Command Menu.
3. Select the required system channel port with the $\uparrow\downarrow$ keys, according to configuration. See Table 4. *KVM port configuration*, on page 2-8.
4. Press **Enter** to activate the required system channel and exit the Command Mode. After a few seconds, the Boot Manager menu is displayed.
5. From the Boot Manager Menu, select the EFI Shell option with the $\uparrow\downarrow$ keys and press **Enter**.

When the EFI Shell is invoked, it first looks for commands in the file *startup.nsh* on the execution path defined by the environment. There is no requirement for a startup file to exist. Once the startup file commands are completed, the Shell looks for commands from console input device.



Note:

The system automatically boots on the first option in the list without user intervention after a timeout. To modify timeout, use **Set Auto Boot Timeout** in the Boot Option Maintenance Menu.

EFI Shell Command Syntax

The EFI Shell implements a programming language that provides control over the execution of individual commands. When the Shell scans its input, it always treats certain characters specially: (**#**, **>**, **%**, *****, **?**, **[**, **^**, **space**, and **newline**).

When a command contains a defined alias, the Shell replaces the alias with its definition (see **alias** command in this chapter). If the argument is prefixed with the **^** character, however, the argument is treated as a literal argument and alias processing is not performed.



Note:

In interactive execution, the Shell performs variable substitution, then expands wildcards before the command is executed.

In batch script execution, the Shell performs argument substitution, then variable substitution, then expands wildcards before the command is executed.

Variable Substitution

Environment variables can be set and viewed through the use of the **set** command (see **set** command in this chapter). To access the value of an environment variable as an argument to a Shell command, delimit the name of the variable with the % character before and after the variable name; for example, **%myvariable%**.

The Shell maintains a special variable, named **lasterror**. The variable contains the return code of the most recently executed Shell command.

Wildcard Expansion

The *, ? and [characters can be used as wildcard characters in filename arguments to Shell commands.

If an argument contains one or more of these characters, the Shell processes the argument for **file meta-arguments** and expands the argument list to include all filenames matching the pattern.

These characters are part of patterns which represent file and directory names.

Character Sequence	Meaning
"*"	Matches zero or more characters in a file name
"?"	Matches exactly one character of a file name
"[chars]"	Defines a set of characters; the pattern matches any single character in the set. Characters in the set are not separated. Ranges of characters can be specified by specifying the first character in a range, then the - character, then the last character in the range. Example: [a-zA-Z]

Table 39. Wildcard character expansion

Output Redirection

Output of EFI Shell commands can be redirected to files, according to the following syntax:

Command	Output Redirection
> unicode_output_file_pathname	standard output to a unicode file
>a ascii_output_file_pathname	standard output to an ascii file
1> unicode_output_file_pathname	standard output to a unicode file
1>a ascii_output_file_pathname	standard output to an ascii file
2> unicode_output_file_pathname	standard error to a unicode file
2>a ascii_output_file_pathname	standard error to an ascii file
>> unicode_output_file_pathname	standard output appended to a unicode file
>>a ascii_output_file_pathname	standard output appended to an ascii file
1>> unicode_output_file_pathname	standard output appended to a unicode file
1>>a ascii_output_file_pathname	standard output appended to an ascii file

Table 40. Output redirection syntax

The Shell will redirect standard output to a single file and standard error to a single file. Redirecting both standard output and standard error to the same file is allowed. Redirecting Standard output to more than one file on the same command is not supported. Similarly, redirecting to multiple files is not supported for standard error.

Quoting

Quotation marks in the EFI Shell are used for argument grouping. A quoted string is treated as a single argument to a command, and any whitespace characters included in the quoted string are just part of that single argument.

Quoting an environment variable does not have any effect on the de-referencing of that variable. Double quotation marks "" are used to denote strings. Single quotation marks are not treated specially by the Shell in any way. Empty strings are treated as valid command line arguments.

Executing Batch Scripts

The EFI Shell has the capability of executing commands from a file (batch script). EFI Shell batch script files are named using the *.nsh* extension. Batch script files can be either UNICODE or ASCII format files. EFI Shell script files are invoked by entering the filename at the command prompt, with or without the filename extension.

Up to nine (9) positional arguments are supported for batch scripts. Positional argument substitution is performed before the execution of each line in the script file. Positional arguments are denoted by %n, where n is a digit between 0 and 9. By convention, %0 is the name of the script file currently being executed. In batch scripts, argument substitution is performed first, then variable substitution. Thus, for a variable containing %2, the variable will be replaced with the literal string %2, not the second argument on the command line. If no real argument is found to substitute for a positional argument, then the positional argument is ignored. Script file execution can be nested; that is, script files may be executed from within other script files. Recursion is allowed.

Output redirection is fully supported. Output redirection on a command in a script file causes the output for that command to be redirected. Output redirection on the invocation of a batch script causes the output for all commands executed from that batch script to be redirected to the file, with the output of each command appended to the end of the file.

By default, both the input and output for all commands executed from a batch script are echoed to the console. Display of commands read from a batch file can be suppressed via the `echo -off` command (see `echo`). If output for a command is redirected to a file, then that output is not displayed on the console. Note that commands executed from a batch script are not saved by the Shell for DOSkey history (up-arrow command recall).

Error Handling in Batch Scripts

By default, if an error is encountered during the execution of a command in a batch script, the script will continue to execute.

The *!asterror* Shell variable is provided allow batch scripts to test the results of the most recently executed command using the `if` command. This variable is not an environment variable, but is a special variable maintained by the Shell for the lifetime of that instance of the Shell.

Comments in Script Files

Comments can be embedded in batch scripts. The # character on a line is used to denote that all characters on the same line and to the right of the # are to be ignored by the Shell. Comments are not echoed to the console.

EFI Shell Commands

Most Shell commands can be invoked from the EFI Shell prompt. However there are several commands that are only available for use from within batch script files.



Note:

The “Batch-only” column indicates if the command is only available from within script files. The following sections provide more details on each of the individual commands. Command **help command_name** displays the details of the **command_name**.

Command	Batch only	Description
alias	No	Displays, creates, or deletes aliases in the EFI Shell
attrib	No	Displays or changes the attributes of files or directories
bcfg	No	Displays/modifies the driver/boot configuration
break	No	Executes a break point
cd	No	Displays or changes the current directory
cls	No	Clears the standard output with an optional background color
comp	No	Compares the contents of two files
connect	No	Binds an EFI driver to a device and starts the driver
cp	No	Copies one or more files/directories to another location
date	No	Displays the current date or sets the date in the system
dblk	No	Displays the contents of blocks from a block device
devices	No	Displays the list of devices being managed by EFI drivers
devtree	No	Displays the tree of devices that follow the EFI Driver Model
dh	No	Displays the handles in the EFI environment
disconnect	No	Disconnects one or more drivers from a device
dmem	No	Displays the contents of memory
dmpstore	No	Displays all NVRAM variables
drivers	No	Displays the list of drivers that follow the EFI Driver Model
drvcfg	No	Invokes the Driver Configuration Protocol
drvdiag	No	Invokes the Driver Diagnostics Protocol
echo	No	Displays messages or turns command echoing on or off
edit	No	Edits an ASCII or UNICODE file in full screen.
err	No	Displays or changes the error level
exit	No	Exits the EFI Shell
for/endifor	Yes	Executes commands for each item in a set of items
goto	Yes	Makes batch file execution jump to another location
guid	No	Displays all the GUIDs in the EFI environment
help	No	Displays commands list or verbose help of a command
hexedit	No	Edits with hex mode in full screen
if/endif	Yes	Executes commands in specified conditions
load	No	Loads EFI drivers
loadbmp	No	Displays a Bitmap file onto the screen
ls	No	Displays a list of files and subdirectories in a directory
map	No	Displays or defines mappings
memmap	No	Displays the memory map
mkdir	No	Creates one or more directories
mm	No	Displays or modifies MEM/IO/PCI
mode	No	Displays or changes the mode of the console output device
mount	No	Mounts a file system on a block device
mv	No	Moves one or more files/directories to destination
openInfo	No	Displays the protocols on a handle and the agents
pause	No	Prints a message and suspends for keyboard input
pci	No	Displays PCI devices or PCI function configuration space
reconnect	No	Reconnects one or more drivers from a device
reset	No	Resets the system
rm	No	Deletes one or more files or directories
set	No	Displays, creates, changes or deletes EFI environment variables
stall	No	Stalls the processor for some microseconds
time	No	Displays the current time or sets the time of the system
type	No	Displays the contents of a file
unload	No	Unloads a protocol image
ver	No	Displays the version information
vol	No	Displays volume information of the file system

Table 41. List of EFI Shell Commands

EFI Network Setup and Configuration

The EFI (Extensible Firmware Interface) Utilities delivered with the system provide a complete set of TCP/IPv4 network stack and configuration tools. Ethernet adapters utilizing 6 bit UNDI option ROMs are supported.



Important:

To access this feature, please connect the Enterprise network to the embedded Ethernet board on the IOR of the domain master IO board. Intel PRO 1000T and 1000F adapters are not supported.



Note:

These utilities are installed in the EFI partition of the system disk in the EFI\Tools directory. The list and respective manual pages for each utility can be found on the Bull NovaScale Server Resource CD–Rom.

Network stack configuration commands must be executed after booting to EFI Shell. To simplify network setup, these commands should be grouped, via an EFI batch script, to form a single one–line command.

Manual EFI Network Configuration

1. Load the TCP/IP protocol via the EFI **load** command.



Note:

As the **load** command does not use the search path to locate protocols, specify the path and the **.efi** extension.

```
fso:\efi\tools\tcpipv4.efi
```

2. Configure the network interfaces with the **ifconfig** command:

The simple form of the command is:

```
ifconfig <interface> inet <ip address> up
```

where *<ip address>* is the address assigned to the system. If the system is connected to a network that uses subnetting, a subnet mask would also need to be specified as follows:

```
ifconfig sni0 inet <ip address> netmask <netmask> up
```

where *<netmask>* is the network mask assigned to the network.



Note:

The TCP/IP stack contains a “*lo0*” loopback interface which can be optionally be configured with the “*sni0*” Ethernet interface if a compatible UNDI Ethernet adapter is installed. Configuration is performed with the **ifconfig** command.

3. If multiple network or subnetwork networking is required, set a gateway address for the appropriate gateway(s) attached to the network, via the **route** command as follows:

```
route add <destination> <gateway ip address>
```

where *<destination>* specifies the target network or host and *<gateway ip address>* specifies the network gateway address responsible for routing data to the destination.

If **default** is used for *<destination>*, a default route will be set.

Example Network Configuration Batch File

An example network configuration batch file named **NetConf.nsh** is installed in the EFI directory of the EFI Service Partition.

This file loads the TCP/IP, configures the Ethernet interface to the IP address given as first argument to this file, configures the optional second argument as the gateway, and loads the FTP Server (daemon).

```
echo -off
if %1empty == empty then
  echo usage netconf {local ip-addr} [router ip addr]
  goto End
endif
load fs0:\efi\tools\tcpipv4.efi
ifconfig sni0 %1 netmask 255.255.255.0
if not %2empty == empty then
  route add default %2
endif
load fs0:\EFI\Tools\ftpd.efi
:End
```



Note:

The IP addresses and netmask indicated in this file and in the following example are only examples and must be modified to reflect site network configuration:

```
fs0:\> Netconf 129.182.189.3 129.182.189.1
129.182.189.3 is the <ip address>
129.182.189.1 is the <gateway ip address>
```

File Transfer Protocol (FTP)

An FTP Client and an FTP Server are provided with the EFI Utilities.

1. Configure the network. See *Manual Network Configuration*.
2. Load the FTP Server via the EFI **load** command.
3. Load the FTP Client via the EFI **ftp** command. This Client supports most ftp directives (open, get, put, ...). Use the **help** directive if you need help.



Note:

As the **load** command does not use the search path to locate protocols, specify the path if it is not in the current working directory and the **.efi** extension.

```
load fs0:\efi\tools\ftpd.efi
```

The FTP Server is now available for use and accepts anonymous connections (one at a time).



Important:

Once the EFI drivers for the TCP/IP, the FTP Server or FTP Client are loaded, you cannot load an Operating System.

To load an Operating System, reset the domain and return to Boot Manager.

Section III – Customizing PAM Software

This section explains how to:

- Set up PAP Unit Users, on page 5-24
- Modify Customer Information, on page 5-22
- Configure Autocalls, on page 5-25
- Customize PAM Settings, on page 5-27
- Deploy a New PAM Release, on page 5-28
- Activate a PAM Version, on page 5-29
- Back up and Restore PAM Configuration Files, on page 5-31

Setting up PAP Unit Users

As Customer Administrator, you must set up user accounts and passwords to control access to the PAP unit.

The Microsoft Windows operating system pre-installed on the PAP unit provides standard security features for controlling access to applications and resources. PAM software security is based on Windows user management and you are advised to give Windows administrator rights to at least one member of the PAP Customer Administrator user group. For further details about user management, refer to the Microsoft Windows documentation on the Bull NovaScale Server System Resource CD.



Note:

You are advised to change the temporary Administrator password (**administrator**) used for setup purposes and to maintain a detailed record of authorized users.

Predefined PAP User Groups

For optimum security and flexibility, the Microsoft Windows software environment is delivered with two predefined Customer user groups:

Pap_Customer_Administrators Group (CA)

This group is designed for customer representatives responsible for the overall management, configuration, and operation of the system. Members of the Customer Administrator group are allowed to configure and administrate the server and have full access to the PAM **Domain Manager**, **Hardware Monitor**, **History Manager** and **Configuration Tasks** menus, as shown in Table 42.

Pap_Customer_Operators (CO)

This group is designed for customer representatives responsible for the daily operation of the system. Members of the Customer Operator group are allowed to operate the server and have full access to the **Domain Manager** menu and partial access to the **History Manager** menu, as shown in Table 42.



Notes:

- Group membership also conditions which Event Messages a user will receive via the PAM Web interface. See *Setting up Event Subscriptions*, on page 5-86.
- The two predefined Support user groups:
 - **Pap_Support_Administrators**
 - **Pap_Support_Operators**are reserved EXCLUSIVELY for Customer Service Engineers responsible for monitoring, servicing, and upgrading the system.
- The predefined Customer user groups have been designed to suit the needs of most Administrator and Operators. Contact your Customer Service Engineer if you require a customized user group.

PAM Tools	Associated Actions	CA	CO
Domain Manager	Load/delete domains	X	X
	Power on/off/reset domains	X	X
	View/modify domain settings	X	X
	View domain status	X	X
	View domain resources	X	X
	View BIOS info	X	X
	View BIOS version	X	X
	View loaded BIOS image	X	X
	View power logs	X	X
	View request logs	X	X
	Request a system dump	X	X
Hardware Monitor	View hardware functional/presence status	X	
	View detailed hardware status information	X	
	Use the hardware Search engine	X	
	Exclude/include hardware components	X	
	View current PAM Web site user information	X	
	View PAM version information	X	
History Manager	View system history files and messages	X	
	Manually archive system history files	X	
	View/delete system history archives	X	
	View user history files	X	X
	Manually archive user history files	X	X
	View/delete user history archives	X	X
Configuration Tasks	View/modify customer information	X	
	Modify the system history automatic archiving policy	X	
	Create/modify/delete domain schemes and identities	X	
	Modify domain schemes and identities	X	
	Create/delete user histories	X	
	Modify user history automatic archiving policy	X	
	Customize the event messaging system	X	
	View/ modify PAM parameters	X	
	Display/modify autocall parameters	X	
Status Pane	View/acknowledge WEB event messages	X	X
	Check system functional status	X	X
	Check CSS availability	X	X

Table 42. User access to PAM features

CA = Customer Administrator

CO = Customer Operator

Modifying Customer Information

Customer information is configured during the initial installation procedure, via the PAM configuration setup Wizard. This information is used by PAM software for the **PAM Tree** display and to complete Intervention Reports.

As Customer Administrator, you may modify this information.

To modify Customer information:

1. From the PAM Tree, click **Configuration Tasks** → **Customer Information**. The **Customer Information** configuration page opens.
2. Enter the new information and click **Save** to confirm changes.

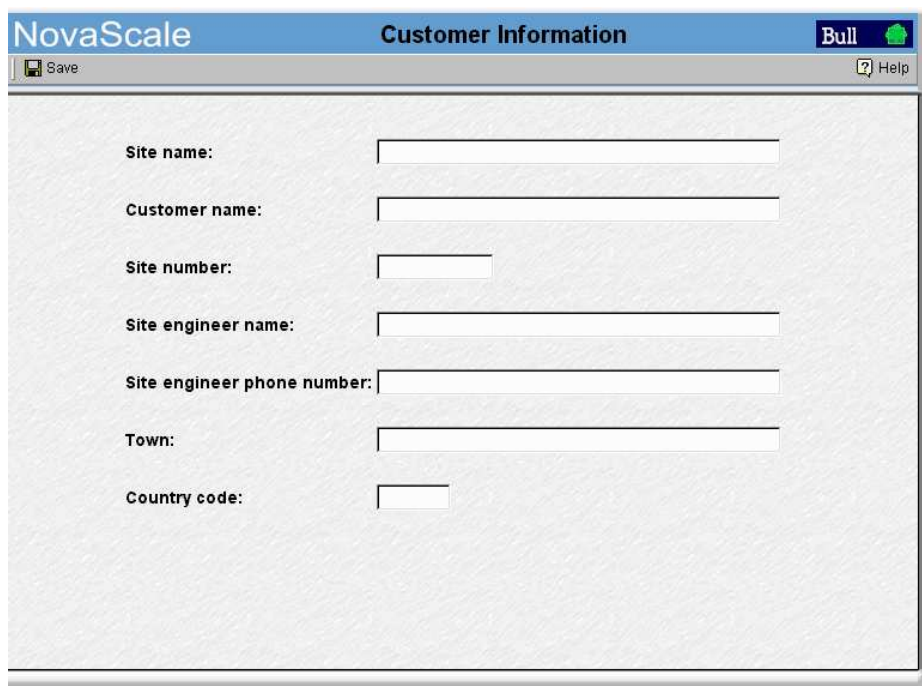

The screenshot shows a web browser window titled "NovaScale Customer Information". The page has a blue header bar with "NovaScale" on the left, "Customer Information" in the center, and "Bull" with a green bull icon on the right. Below the header is a grey bar with a "Save" button on the left and a "Help" button on the right. The main content area is white and contains seven form fields, each with a label and an input box: "Site name:", "Customer name:", "Site number:", "Site engineer name:", "Site engineer phone number:", "Town:", and "Country code:".

Figure 114. Customer Information configuration page



Note:

The value entered in the **Site name** field will be used for the PAM tree root node.

Configuring Autocalls

The **Autocall** feature is part of the BULL Remote Maintenance contract. It is used to automatically route system events to the Remote Maintenance Center. Full details are given in the BULL *Remote Maintenance Guide*.

If your maintenance contract includes the Autocall feature, configure Autocall parameters as follows:

1. Click **Configuration Tasks** → **Autocalls**. The **Autocalls** configuration page opens.

Figure 115. Autocalls Channel Settings control pane

2. Select the **Enable Autocalls** checkbox.
3. Select the the **Send Heartbeat** checkbox and enter a value “in days” for the autocall channel control in the **Period** box. Recommended value = 1.
4. Select the autocall dispatch mode :
 - **Local dispatch mode** (default mode) sends autocalls to the local target directory indicated under **Local Settings**,
 - **FTP dispatch mode** sends autocalls to the server indicated under **FTP Settings**.
5. If **Local dispatch mode** (default mode) is selected, complete the **Local Settings** field with the following information:

Field	Explanation	Value
Local target directory	Default GTS directory used to store autocalls.	c:\gts\session

6. If **FTP dispatch mode** is selected, complete the **FTP Settings** fields with the following information:

Field	Explanation	Value
Server name	Remote Maintenance Center server IP address	127.0.0.1
Server port	Default server port	21
Target directory	Default server directory	/autocall
Login	Declared authorized user name	X
Password	Declared authorized user password	X

7. If a modem connection is to be used:
- From the PAP Unit Microsoft Windows desktop, configure the dial-up connection (**Control Panel** → **Phone and Modem Options**).
 - From the PAM **Autocalls Control Pane**, select the **Use modem connection** checkbox.
 - Use the **Connection name** drop-down menu to select the required modem connection.
 - Complete the **User name** and **Password** fields with the declared authorized user name and user password.

Setting Thermal Units

By default, PAM software displays thermal measurements in degrees Celsius. As Customer Administrator, you may change the default setting to degrees Fahrenheit.

To change PAM thermal units:

1. Click **Configuration Tasks** → **PAM**. The **PAM Configuration** control pane opens.
2. Click the **Celsius** or **Fahrenheit** radio button, as required.
3. Click **Save**. A green icon appears in the top left corner of the control pane to confirm the change.

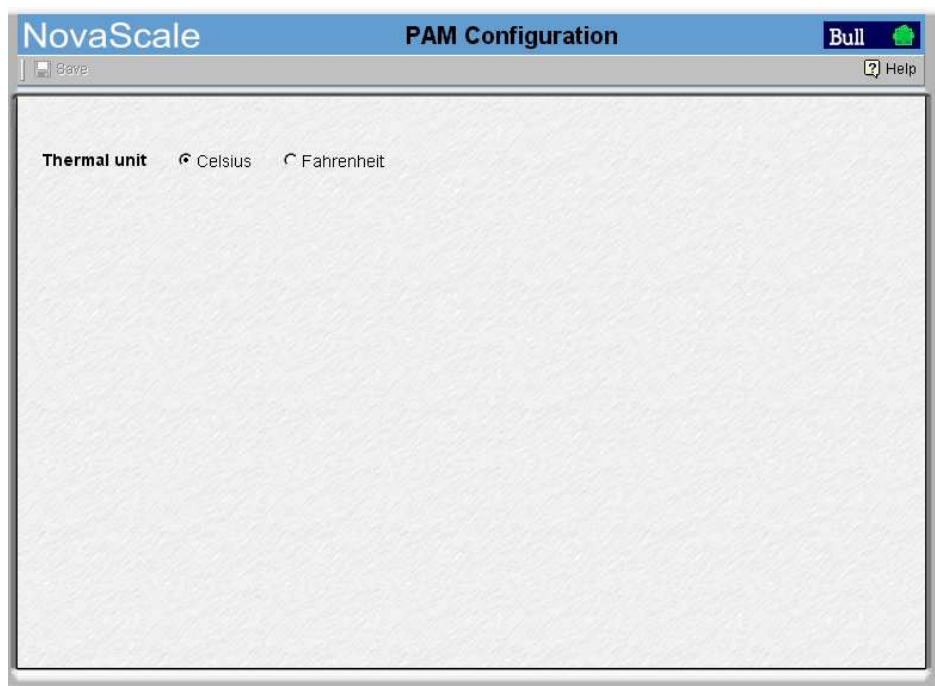

Figure 116. PAM configuration control pane

Deploying a New PAM Release

As Customer Administrator, you can deploy a new PAM release by running the new *PAM Installation package x.y.z.msi* (x.y.z being the PAM version e.g. 7.15.0 2.1.9) file.

To install a new PAM Release:

1. From the local PAP unit console, power down all server domains and close the current PAM session.
2. From the default *PAM Installation* directory, double click the **.msi file** to launch the *PAM Installation InstallShield Wizard*.
3. Select **Complete** to install all program features and to accept the default path for the installation folder:

<WinDrive>:\Program Files\BULL\PAM\installation\<Release Version>
(e.g. d:\Program Files\BULL\PAM\installation\7.15.0 2.1.9).

or, select **Custom** to select program features and to define a path for the installation folder.



Figure 117. PAM Installation InstallShield Wizard



Note:

This path is the repository for activation files. NEVER delete this folder after activation as it is required to repair and re-activate the release.

4. Click **Install** to begin setup.
5. Select the **Launch PAM Activation** utility checkbox and click **Finish**. The **PAM Activation** utility is automatically launched.

The **PAM Activation** icon is installed on the PAP unit desktop and the **Platform Administration and Maintenance** program group, giving access to the **PAM Activation** and **PAP Configuration** executable files, is installed in the **Program Files** directory.

Activating a PAM Version

The *PAM InstallShield Wizard* automatically creates a shortcut to the **PAM Activation** utility on the PAP unit desktop that can be used at any time to activate an installed PAM Version.

Note:

A previous PAM Version can be re-activated at any time, in the event of a problem with the current release.

To activate / re-activate a PAM Version:

1. From the local PAP unit console, power down all server domains and close the current PAM session.
2. From the *PAM Activation* utility on the Microsoft Windows desktop, select the required PAM Version and click **Activate** to launch the *PAM Activation InstallShield Wizard*.
3. Select **Complete** to accept the default paths for the PAM Release and PAM Site Data folders:

The default PAM **Release** directory for all the files delivered as part of PAM software is:

<WinDrive>:\Program Files\BULL\PAM\<Release Version>
(e.g. d:\Program Files\BULL\PAM\7.15.0 2.1.9).

The default PAM **Site Data** directory for all the files produced by PAM software (history files, configuration files) concerning Customer site definition and activity is:

<WinDrive>:\Program Files\BULL\PAM\PAMSiteData\<DataCompatibilityRelease>
(e.g. d:\Program Files\BULL\PAM\PAMSiteData\1).

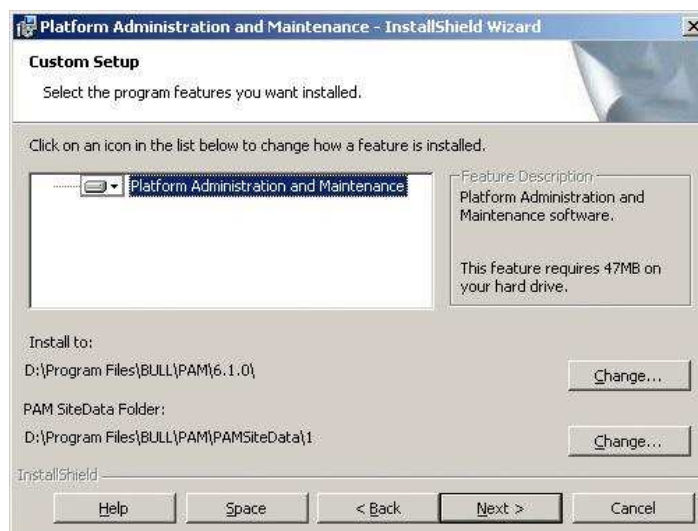

Figure 118. PAM Activation InstallShield Wizard



Important:

PAM releases use the same data directory to ensure configuration consistency. Before activating / re-activating a PAM Version, ensure that the <Data Compatibility Release> level of deployed releases is compatible. If it is NOT compatible, PAM configuration options (e.g. Event subscription options, Domain Schemes and Identities, ...) may be lost.

4. Click **Install** to begin activation.

5. Select the **Launch PAP Configuration** utility checkbox if you want to configure or reconfigure PAP unit settings. Otherwise, click **OK** to complete activation.
6. From the local PAP unit console, right click the **Microsoft Internet Explorer** icon on the desktop and click **Properties** → **General** → **Delete Files** to delete all the files in the Temporary Internet Folder.
7. Launch a new PAM session.



Important:

Notify all authorized users, connecting to PAM from a remote console, that a new PAM Version has been activated and request them to:

- a. **Close their current PAM session.**
- b. **Delete all the files in their Temporary Internet Folder.**
- c. **Launch a new PAM session.**

Backing Up and Restoring PAM Configuration Files

As Customer Administrator, you are advised to regularly save PAM configuration data to a removable media or to a network directory so that it can be rapidly restored in the event of PAP unit failure.

PAM software can be deployed on any standard PC running the appropriate version of Microsoft Windows and you can restore your configuration data to rebuild your working environment.

PAM configuration data is automatically saved to the default PAM Site Data directory on the PAP unit:

<WinDrive>:\Program Files\BULL\PAM\PAMSiteData<DataCompatibilityRelease>

To ensure carefree, reliable and regular configuration data backup, the Bull NovaScale Server Resource CD contains two scripts, **PamBackupData.js** and **PamRestoreData.js**, that can be scheduled to run via the Microsoft Windows **Task Scheduler**.



Note:

The **PamBackupData.js** and **PamRestoreData.js** scripts are also stored in the PAM Site Data directory on the PAP unit:

<WinDrive>:\Program Files\BULL\PAM\PAMSiteData\ReleaseData\Utilities



Warning:

The same PAM software release must be deployed on the PAP unit and on the backup PC to allow data restoration.

PAM releases use the same data directory to ensure configuration consistency.

Before activating / re-activating a PAM Version, ensure that the

<DataCompatibilityRelease> level of deployed releases is compatible.

Backing Up PAM Configuration Files

To create a Microsoft Windows automatic backup task:

1. Select or create the local or network directory to be used for saving configuration data, e.g. **<MyPamBackupDirectory>**.
2. Create a local directory for the **PamBackupData.js** and **PamRestoreData.js** script files, e.g. **<MyPamBackupTools>**.
3. Copy the **PamBackupData.js** and **PamRestoreData.js** script files into the **<MyPamBackupTools>** directory.
4. Create a Text File and enter the following command line:
Cscript PamBackupData.js <MyPamBackupDirectory>
5. Save the Text File as a batch file with a **.BAT** extension, e.g. **<MyPamBackupCommand>.bat**.
6. Click **Control Panel** → **Scheduled Tasks** → **Add Scheduled Task** to open the **Task Scheduler** wizard and follow the instructions. PAM configuration data will be automatically saved at the interval indicated in the wizard.



Note:

When requested to select a program, select the **<MyPamBackupCommand>.bat** batch file.

Restoring PAM Configuration Data

To restore PAM configuration data:

1. If required, install the same PAM software release on the backup PC as on the PAP unit. See *Deploying a New PAM Release*, on page 5-28 and *Activating a PAM Version*, on page 5-29.
2. From the Microsoft Windows desktop, open a command window. Browse to the **<MyPamBackupTools>** directory containing the script files and enter the following command line:

```
Cscript PamRestoreBackupData.js <MyPamBackupDirectory>
```

Saved PAM configuration data is restored.

Section IV – Configuring Domains



Important:

This section describes domain configuration and management tools that are reserved for use with partitioned servers and extended systems. Please contact your Bull Sales Representative for sales information.

This section explains how to:

- Partition your Server, on page 5-34
- Assess Configuration Requirements, on page 5-36
- Create, Edit, Copy, Delete, Rename a Domain Scheme, on page 5-37
- Update Test Schemes, on page 5-42
- Create, Edit, Delete a Domain Identity, on page 5-43
- Create a Mono–Domain Scheme using all Server Resources, on page 5-45
- Create a Mono–Domain Scheme using a Part of Server Resources, on page 5-53
- Create a Multi–Domain Scheme using all Server Resources, on page 5-61
- Create a Multi–Domain Scheme using a Part of Server Resources, on page 5-69
- Configure Extended Systems, on page 5-76
- Clear, Load, Save NVRAM Variables, on page 5-77
- Update the LUN List, on page 5-78
- Limit Access to Hardware Resources, on page 5-79
- Prepare a Scheme, Domain Identity, and Hardware Resources Checklist, on page 5-80

Partitioning your Server

Bull NovaScale Servers are designed around a flexible, cell-based, midplane architecture allowing dynamic partitioning into physically independent domains.

A domain is a coherent set of hardware and software resources managed by a single Operating System instance.

The NovaScale 6080/6160 Server is designed to operate as one or two hardware-independent SMP systems, or domains.

The NovaScale 6320 Server is designed to operate as one, two, three or four hardware-independent SMP systems, or domains.



Note:

Server components and configuration may differ according to site requirements. At least one IOB and one QBB are required for each server domain.

Partitioning allows you to optimize your server to:

- meet variations in workload – peak / off-peak periods,
- allow different time and date settings,
- use the same environment for tests and production,
- carry out software tests prior to deployment / upgrades,
- reduce downtime for servicing or re-configuration.

PAM software provides you with all the tools and features required to partition and manage your server as independent SMP systems. For easy configuration and optimum use of the physical and logical resources required for simultaneous operation, domains are defined via the **Domain Scheme** wizard. From the PAM tree, expand the **Configuration Tasks** and **Domains** nodes to display domain configuration options.

The screenshot displays two panes from the NovaScale management interface. The top pane, titled 'Schemes', contains a table with the following data:

Schemes	Author	Local Date & Time
MyBusinessScheme	FRCLS5778ICA	03/25/04 13:39:34
MyNewScheme	FRCLS5778ICA	03/29/04 15:00:17
MyOffpeakProdScheme	FRCLS5778ICA	03/25/04 17:24:13
MyOperationsScheme	FRCLS5778ICA	03/04/04 18:12:23
MyProd_PayrollScheme	FRCLS5778ICA	03/25/04 17:32:28
MYSERVER	FRCLS5778ICA	03/29/04 15:07:05

The bottom pane, titled 'Identities', contains a table with the following data:

Identities	Operating System	Version	In use	Description
MyBusiness-1	WINDOWS_64		Yes	Time zone: Central America, Boot path: EFI
MyNewIdentity-1	WINDOWS_64		No	
MyNewIdentity-2	LINUX		No	
MyOffpeakProd	LINUX		No	Time zone: Paris, Boot path: EFI 0Lun1
MyOperations-1	WINDOWS_64		No	Default identity for Domain-1. OS location: M 0, IOB-0, EFI LUN0.
MyOperations-2	LINUX		No	Default identity for Domain-2. OS location: M 0, IOB-1, EFI LUN 1.

Figure 119. Domain scheme and identity panes

A **Domain Scheme** is used to define and manage a set of domains that can be active simultaneously. The **Schemes** control pane allows you to create, edit, copy, delete, and rename domain schemes and update default test schemes.

A **Domain Identity** is used to define and manage domain context information. The **Identities** control pane allows you to create, edit, copy, and delete domain identities.

The server is delivered with a pre-configured scheme called **MyOperationsScheme**, allowing you to simultaneously manage and administer all server resources. However, as Customer Administrator, you may want to create other domain schemes and identities to suit your working environment.

Before proceeding to create a new Scheme and/or new Domain Identities, you are advised to assess your configuration requirements. See *Assessing Configuration Requirements*, on page 5-36.

Assessing Configuration Requirements

At least one IOB and one QBB are required for each server domain.

You can use the following checklist to help you make an accurate plan of how you want to partition and manage your system. For easy planning, you can print a copy of the Scheme, Domain Identity, and Resources checklist templates provided on page 5-80.

Scheme Checklist	
Name	What name do I want to use for my Scheme? Examples: <ul style="list-style-type: none"> • <i>MyFullConfigScheme</i> • <i>MyPartConfigScheme</i> • <i>MyNightScheme</i> • <i>MyDayScheme</i> • <i>MyTest_ProductionScheme</i>
Description	How can I describe my Scheme to reflect its scope? Examples: <ul style="list-style-type: none"> • <i>Central Subsystems included</i> • <i>Resources used</i> • <i>Domain Identities used</i>
Central Subsystem(s)	Which Central Subsystem(s) do I want to use?
Number of domains	How many domains do I need?
Domain size	How many cells do I want to assign to each domain?
EFI boot LUNs	Which EFI boot LUN do I want to use for each domain?
I/O resource location	Which cells host the I/O resources I want to use?
Domain Identity Checklist	
Name	What name do I want to use for my Domain Identity to reflect the tasks/jobs it will run? Examples: <ul style="list-style-type: none"> • <i>MyDataMiningIdentity</i> • <i>MyDataBaseIdentity</i> • <i>MyProductionIdentity</i> • <i>MyTestIdentity</i>
Description	How can I describe my Domain Identity to reflect its use? Examples: <ul style="list-style-type: none"> • <i>OS and applications</i> • <i>Time zone</i> • <i>Boot path</i> • <i>IP address</i> • <i>Network name</i> • <i>URL</i> • <i>Production / test conditions</i>
Operating System	Which OS do I want to run on this domain? Does this OS support assigned hardware (CPUs, DIMMs)?
Domain network name	Which network name will be used to identify this domain?
Domain IP address	Which IP address will be used to reach this domain?
Domain URL	Which URL can be used to reach my domain Web site (if any)?

Table 43. Domain configuration assessment criteria

Creating, Editing, Copying, Deleting, Renaming a Domain Scheme



Note:

Domain Identities can either be created via the Domain Scheme wizard or, independently, via the **Identities** configuration page. See *Creating a Domain Identity*, on page 5-43.

This section also provides you with a tutorial on how to create a:

- mono-domain scheme using all server resources, on page 5-45
- mono-domain scheme using a part of server resources, on page 5-53
- multi-domain scheme using all server resources, on page 5-61
- multi-domain scheme using a part of server resources, on page 5-69.

Creating a Domain Scheme



Note:

At least one IOB and one QBB are required for each server domain.

To create a domain scheme:

1. Assess your configuration requirements. See *Assessing Configuration Requirements*, on page 5-36.
2. Click **Configuration Tasks** → **Domains** → **Schemes** in the PAM tree to open the **Schemes** control pane.

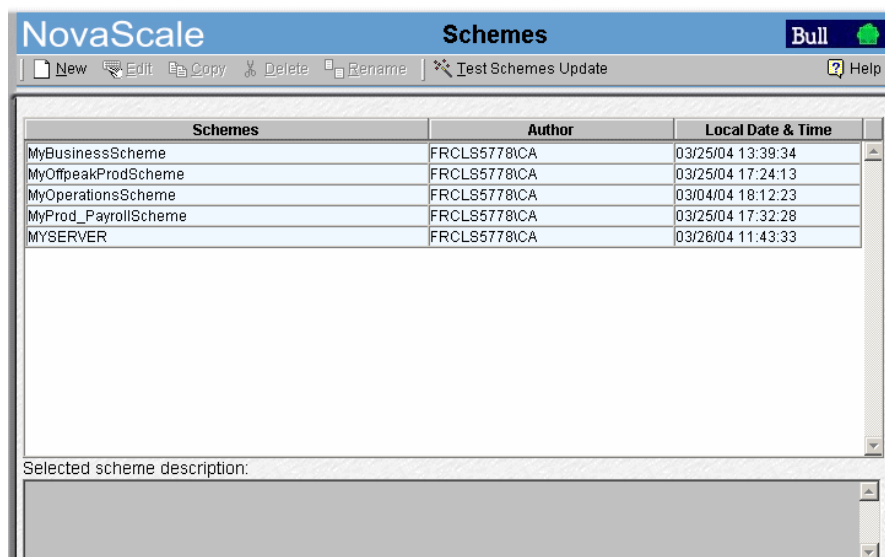
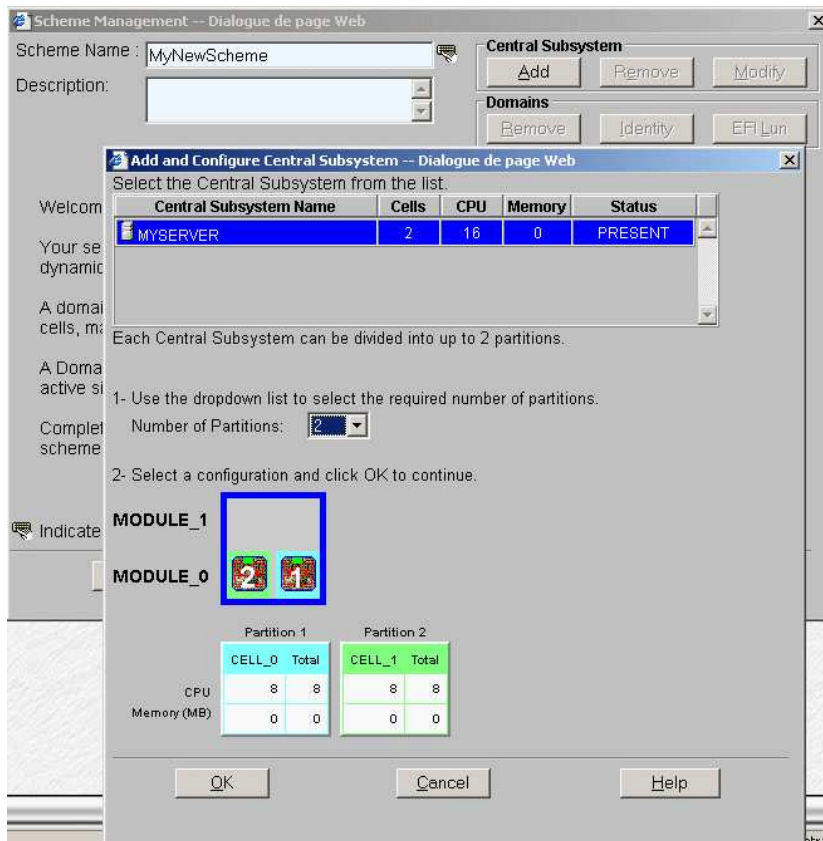

Figure 120. Schemes control pane

3. Click **New** in the toolbar to open the **Scheme Management** dialog.
4. Complete the **Scheme** and **Description** fields, as required. See *Assessing Configuration Requirements*, on page 5-36.
5. Click **Central Subsystem** → **Add** to select the Central Subsystem to be used by the Scheme. The **Central Subsystem Configuration** dialog opens.

NovaScale 6080/6160 Server



NovaScale 6320 Server

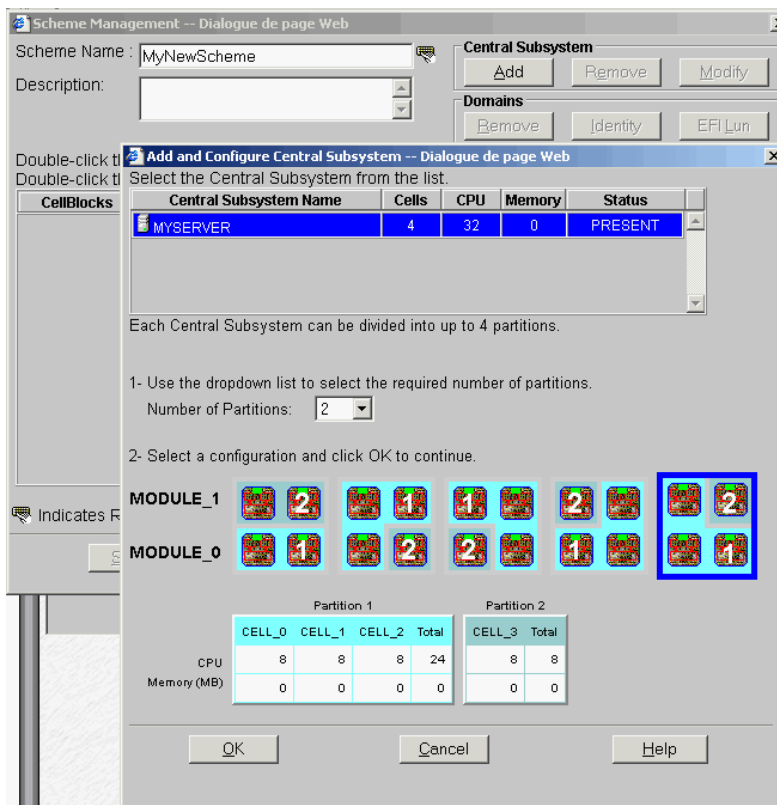
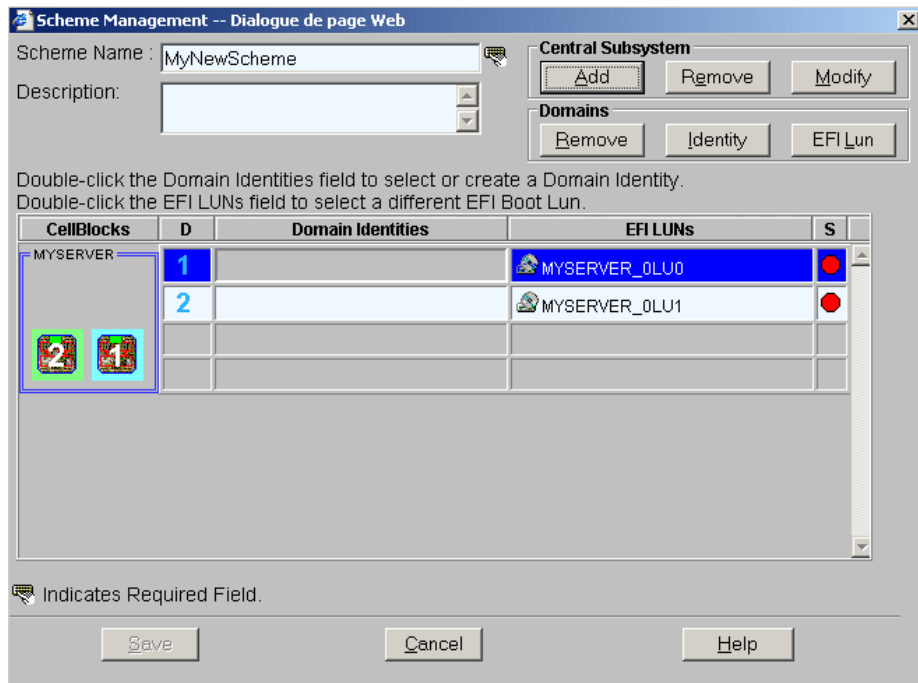

Figure 121. Scheme Creation and Central Subsystem Configuration dialogs

6. Select a Central Subsystem and use the **Number of Parts** dropdown list to select the required number of hardware partitions (2 in the example).
7. Select the required partition configuration and click **OK** to return to the **Scheme Management** dialog.

NovaScale 6080/6160 Server



NovaScale 6320 Server

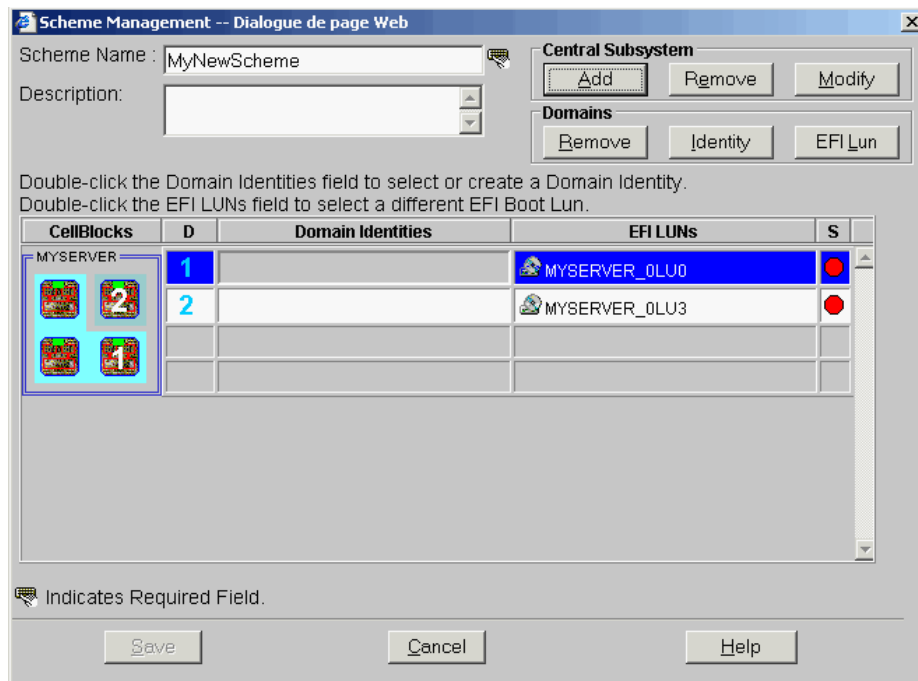

Figure 122. Scheme Management dialog

The **Status** icon is red because a **Domain Identity** is required to complete domain configuration.

8. Click **Domains** → **Identity** to open the **Identities List** dialog.

9. If the required identity is in the list, go to Step 10.
If you want to create a new identity for this domain, click **New** to open the **Create New Identity** dialog. See *Creating a Domain Identity*, on page 5-43.
10. Select the required identity from the list of available identities and click **OK** to return to the **Scheme Management** dialog. The corresponding **Status** icon turns green.
11. Check that the EFI Boot Lun is correct. If the EFI Boot Lun is correct, go to Step 13.
If the EFI Boot Lun is not correct, click **Domains** → **EFI LUN** to open the **LUN List** dialog.
12. Select the required EFI Boot Lun from the list of available Luns and click **OK** to return to the **Scheme Management** dialog.
13. Click **Save**. The domain scheme is now available for domain management.

Editing a Domain Scheme

To edit a domain scheme:

1. Assess your configuration requirements. See *Assessing Configuration Requirements*, on page 5-36.
2. Click **Configuration Tasks** → **Domains** → **Schemes** in the PAM tree to open the **Schemes** pane. See Figure 120 above.
3. Select the required scheme from the list.
4. Click **Edit** in the toolbar to open the **Edit Scheme** dialog.

NovaScale 6080/6160 Server

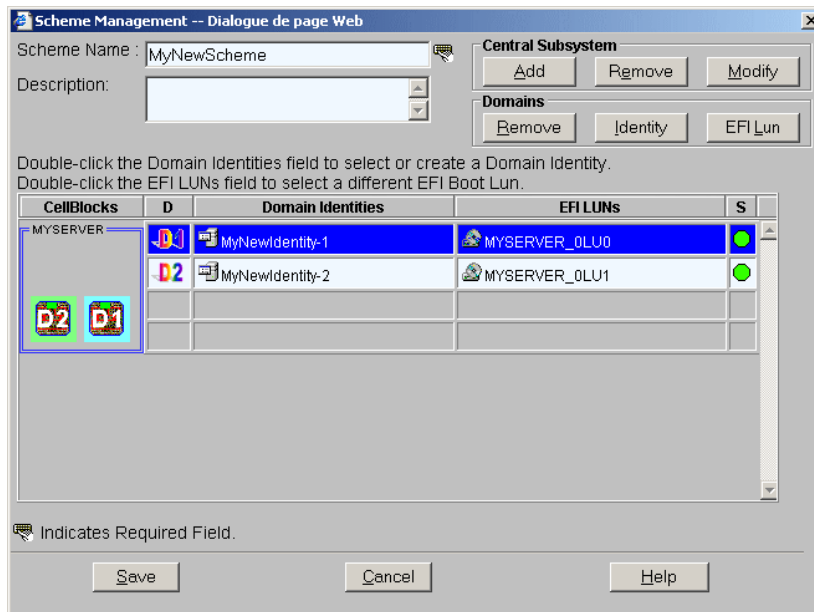

NovaScale 6320 Server

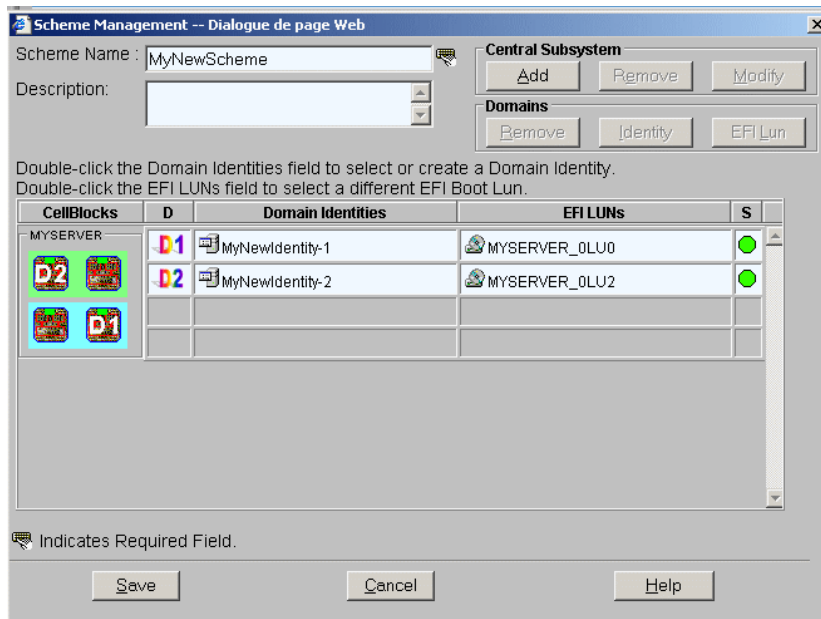

Central Subsystem	
Add	Click here to add another Central Subsystem to your scheme. See <i>Creating a Domain Scheme</i> , on page 5-37.
Remove	Click here to remove a Central Subsystem from your scheme.
Modify	Click here to change the number of hardware partitions in your scheme.
Domains	
Remove	Click here to remove the selected domain from the scheme.
Identity	Click here to select a domain identity.
EFI Lun	Click here to select an EFI Boot Lun.

Figure 123. Edit Scheme dialog

5. Make the required changes and click **Save**. The modified domain scheme is now available for domain management.

Copying a Domain Scheme

To copy a domain scheme:

1. Click **Configuration Tasks** → **Domains** → **Schemes** in the PAM tree to open the **Schemes** pane. See Figure 120 above.
2. Select the required scheme from the list.
3. Click **Copy** in the toolbar. The **Copy Scheme** dialog opens.
4. Enter a name for the new scheme and click **OK**. The new domain scheme is now available for domain management.

Deleting a Domain Scheme

To delete a domain scheme:

1. Click **Configuration Tasks** → **Domains** → **Schemes** in the PAM tree to open the **Schemes** pane. See Figure 120 above.
2. Select the required scheme from the list.
3. Click **Delete** in the toolbar. You are requested to confirm scheme deletion.
4. Click **OK** to confirm. The domain scheme is removed from the **Schemes List** and is no longer available for domain management.

Renaming a Domain Scheme

To rename a domain scheme:

1. Click **Configuration Tasks** → **Domains** → **Schemes** in the PAM tree to open the **Schemes** pane. See Figure 120 above.
2. Select the required scheme from the list.
3. Click **Rename** in the toolbar.
4. Enter a new name for the scheme and click **OK**. The renamed domain scheme is now available for domain management.

Updating Test Schemes

The **Domain Wizard** allows you to automatically generate and update a set of **Test Schemes**. These test schemes take into account all the hardware in your configuration. You may need to update your test schemes after a service intervention entailing the addition/removal of hardware elements.

To update test schemes:

1. Click **Configuration Tasks** → **Domains** → **Schemes** in the PAM tree to open the **Schemes** pane. See Figure 120 above.
2. Click **Test Schemes Update** in the toolbar. Default test schemes are automatically updated.

Creating, Editing, Copying, Deleting a Domain Identity

Note:

Domain Identities can either be created via the **Domain Scheme** wizard or, independently, via the **Identities** configuration page. See *Creating a Domain Scheme*, on page 5-37.

Creating a Domain Identity

To create a domain identity:

1. Assess your configuration requirements. See *Assessing Configuration Requirements*, on page 5-36.
2. Click **Configuration Tasks** → **Domains** → **Identities** in the PAM tree to open the **Identities Management** page.

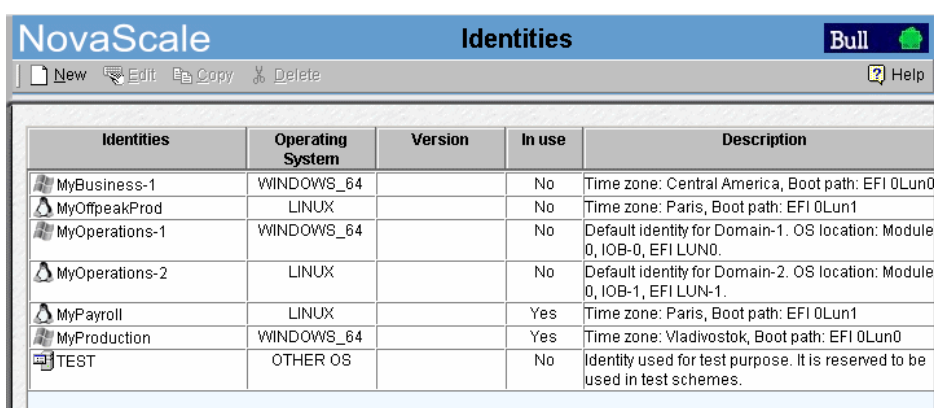

Identities	Operating System	Version	In use	Description
MyBusiness-1	WINDOWS_64		No	Time zone: Central America, Boot path: EFI 0Lun0
MyOffpeakProd	LINUX		No	Time zone: Paris, Boot path: EFI 0Lun1
MyOperations-1	WINDOWS_64		No	Default identity for Domain-1. OS location: Module 0, IOB-0, EFI LUN0.
MyOperations-2	LINUX		No	Default identity for Domain-2. OS location: Module 0, IOB-1, EFI LUN-1.
MyPayroll	LINUX		Yes	Time zone: Paris, Boot path: EFI 0Lun1
MyProduction	WINDOWS_64		Yes	Time zone: Vladivostok, Boot path: EFI 0Lun0
TEST	OTHER OS		No	Identity used for test purpose. It is reserved to be used in test schemes.

Figure 124. Identities List page

3. Click **New** in the toolbar to open the **Create New Identity** dialog.

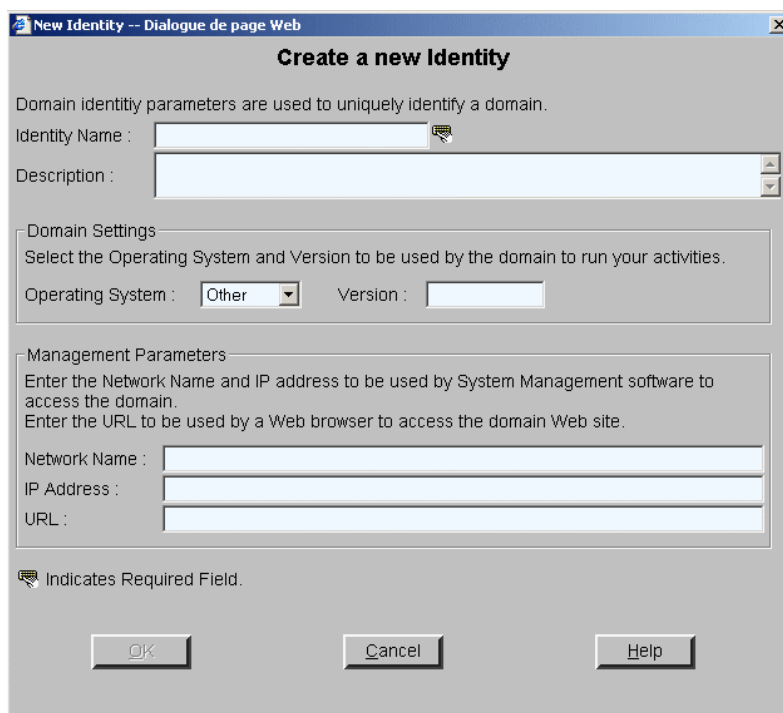

Create a new Identity

Domain identity parameters are used to uniquely identify a domain.

Identity Name :

Description :

Domain Settings

Select the Operating System and Version to be used by the domain to run your activities.

Operating System : Version :

Management Parameters

Enter the Network Name and IP address to be used by System Management software to access the domain.

Enter the URL to be used by a Web browser to access the domain Web site.

Network Name :

IP Address :

URL :

Indicates Required Field.

Figure 125. Create New Identity dialog

4. Complete the **Name**, **Description**, **Domain Settings**, and **Management Parameters** fields, as required. See *Assessing Configuration Requirements*, on page 5-36.
5. Click **OK**. The new identity appears in the **Identities List** page and can be applied to a hardware partition via the **Domain Scheme** wizard.

Editing a Domain Identity

To modify domain identity settings, management parameters and/or description:

1. Assess your configuration requirements. See *Assessing Configuration Requirements*, on page 5-36.
2. Click **Configuration Tasks** → **Domains** → **Identities** in the PAM tree to open the **Identities Management** page. See Figure 124 above.
3. Select the required identity from the list.
4. Click **Edit** in the toolbar. The **Edit an Identity** dialog opens, allowing you to modify domain identity settings, management parameters and/or description. See Figure 125 above.
5. Enter a new description in the **Description** field, and/or a new Operating System / Version in the **Domain Settings** field, and/or a new network name, IP address, URL in the **Management Parameters** field.
6. Click **OK** to confirm the modification.

Copying a Domain Identity

To copy a domain identity:

1. Click **Configuration Tasks** → **Domains** → **Identities** in the PAM tree to open the **Identities Management** page. See Figure 124 above.
2. Select the required identity from the list.
3. Click **Copy** in the toolbar. The **Copy Identity** dialog opens.
4. Enter the name for the new identity and click **OK** to confirm.
5. The new identity appears in the **Identities List** page and can be applied to a hardware partition via the **Domain Scheme** wizard.

Deleting a Domain Identity



Important:

If a Domain Identity is used in a Scheme, it cannot be deleted.

To delete a domain identity:

1. Click **Configuration Tasks** → **Domains** → **Identities** in the PAM tree to open the **Identities List** page. See Figure 124 above.
2. Select the required identity from the list.
3. Click **Delete** in the toolbar and click **OK** to confirm. The selected identity is removed from the **Identities List**.

Creating a Mono-Domain Scheme using all Server Resources

The configuration criteria set out in the following tables is used to illustrate this example.

NovaScale 6080/6160 Server

Scheme	
Name	MyBusinessScheme
Description	Mono-domain, Cells 0 & 1, Boot 0Lun0, MyBusiness-1
Central Subsystem(s)	MyServer
Number of domains	1
Domain size	2 cells: Cell0 & Cell 1
EFI boot LUNs	MyServer_0Lun0
IO resource location	0IOB0 mandatory, 0IOB1 optional
Domain Identity	
Name	MyBusiness-1
Description	Time zone: Central America, Boot path: EFI 0Lun0
Operating System	Windows
Domain network name	MyBusiness-1Net
Domain IP address	123.123.12.1
Domain URL	http://www.MyBusiness-1Web.com

Table 44. Scheme configuration criteria – example 1 – mono-module server

NovaScale 6320 Server

Scheme	
Name	MyBusinessScheme
Description	Mono-domain, Cells 0, 1, 2 & 3, Boot 0Lun0, MyBusiness-1
Central Subsystem(s)	MyServer
Number of domains	1
Domain size	4 cells: Cell0, Cell1, Cell2 & Cell 3
EFI boot LUNs	MyServer_0Lun0
IO resource location	0IOB0 mandatory, 0IOB1, 1IOB0, & 1IOB1 optional
Domain Identity	
Name	MyBusiness-1
Description	Time zone: Central America, Boot path: EFI 0Lun0
Operating System	Windows
Domain network name	MyBusiness-1Net
Domain IP address	123.123.12.1
Domain URL	http://www.MyBusiness-1Web.com

Table 45. Scheme configuration criteria – example 1 – bi-module server

Note:

A scheme can include more than one Central Subsystems. If you have more than one Bull NovaScale Server, see *Configuring Extended Systems*, on page 5-76.

To create a mono-domain scheme using all server resources:

1. Check that the required hardware resources are available (at least one IOB and one QBB are required for each server domain) and that the domain Operating System supports the required hardware resources (CPUs, DIMMs, ...).
2. From the Customer Administrator PAM tree, click **Configuration Tasks** → **Domains** → **Schemes** to open the **Schemes Management** pane.
3. Click **New** to open the **Scheme Creation** dialog.
4. Complete the **Scheme** and **Description** fields.

NovaScale 6080/6160 Server

The screenshot shows a web dialog titled "Scheme Management -- Dialogue de page Web". It features two input fields: "Scheme:" with the value "MyBusinessScheme" and "Description:" with the value "Mono-domain, Cells 0 & 1, Boot 0Lu0, MyBusiness-1". To the right, there are two sections: "Central Subsystem" with "Add", "Remove", and "Modify" buttons, and "Domains" with a "Remove" button. Below the input fields is a welcome message and instructions for creating a scheme. At the bottom, there are "Save", "Cancel", and "Help" buttons.

Scheme: MyBusinessScheme
Description: Mono-domain, Cells 0 & 1, Boot 0Lu0, MyBusiness-1

Central Subsystem
Add Remove Modify

Domains
Remove

Welcome to the creation of a new scheme.

A scheme is a list of domains. A domain is a groupment of physical and logical resources on which a selected Operating System is running.
Physical resources (QBB and IOB) are logically grouped in a cell. A domain is a groupment of cells.
You can part each Central Subsystem in domains.

1- Enter a name for this new scheme and optionally its description.
2- Click on Add button to add a new Central Subsystem to this scheme.
For each Central Subsystem, you define the number of domains, and then you configure each domain.
3- To add other Central Subsystem, follow the step 2.
4- When finishing the scheme creation, click on Save button to save the scheme.

Save Cancel Help

NovaScale 6320 Server

The screenshot shows a web dialog titled "Scheme Management -- Dialogue de page Web". It features two input fields: "Scheme Name:" with the value "MyBusinessScheme" and "Description:" with the value "Mono-domain, Cells 0, 1, 2 & 3, Boot 0Lu0, My-Business-1". To the right, there are two sections: "Central Subsystem" with "Add", "Remove", and "Modify" buttons, and "Domains" with "Remove", "Identity", and "EFI Lun" buttons. Below the input fields is a welcome message and instructions for creating a domain scheme. At the bottom, there are "Save", "Cancel", and "Help" buttons.

Scheme Name : MyBusinessScheme
Description: Mono-domain, Cells 0, 1, 2 & 3, Boot 0Lu0, My-Business-1

Central Subsystem
Add Remove Modify

Domains
Remove Identity EFI Lun

Welcome to the Domain Scheme wizard.

Your server Central Subsystem is designed around a flexible, cell-based architecture allowing dynamic partitioning into up to four physically independent domains.

A domain is a set of hardware and software resources, spanning one or more Central Subsystem cells, managed by a single Operating System instance.

A Domain Scheme is the template used to define and manage a set of domains that can be active simultaneously.

Complete the Scheme Name and optionally Description fields and click Add to begin domain scheme creation.

Indicates Required Field.

Save Cancel Help

Figure 126. Scheme creation dialog – example 1

- Click **Central Subsystem** → **Add** to select the Central Subsystem to be used by the Scheme. The **Central Subsystem Configuration** dialog opens.

NovaScale 6080/6160 Server

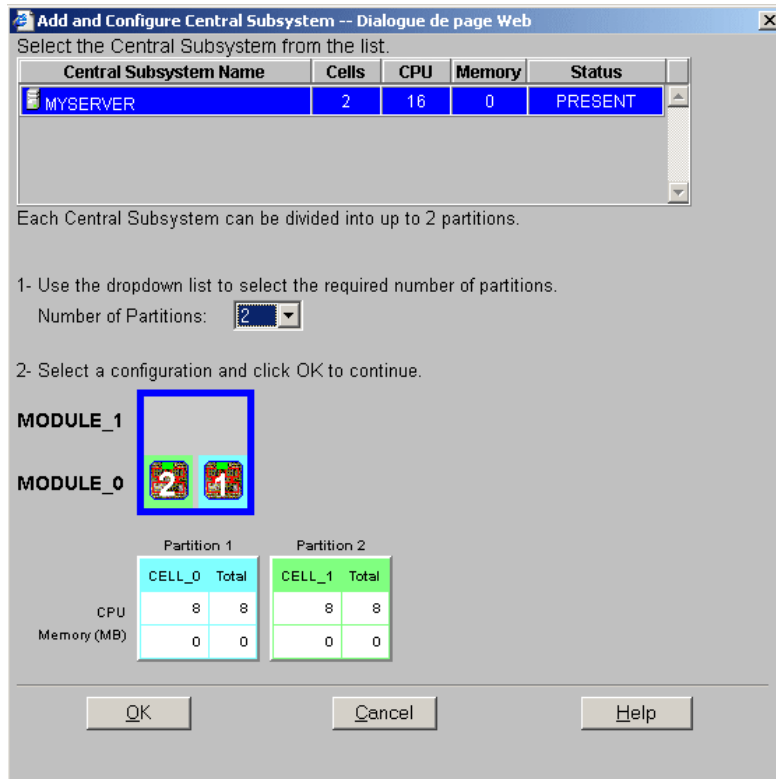

NovaScale 6320 Server

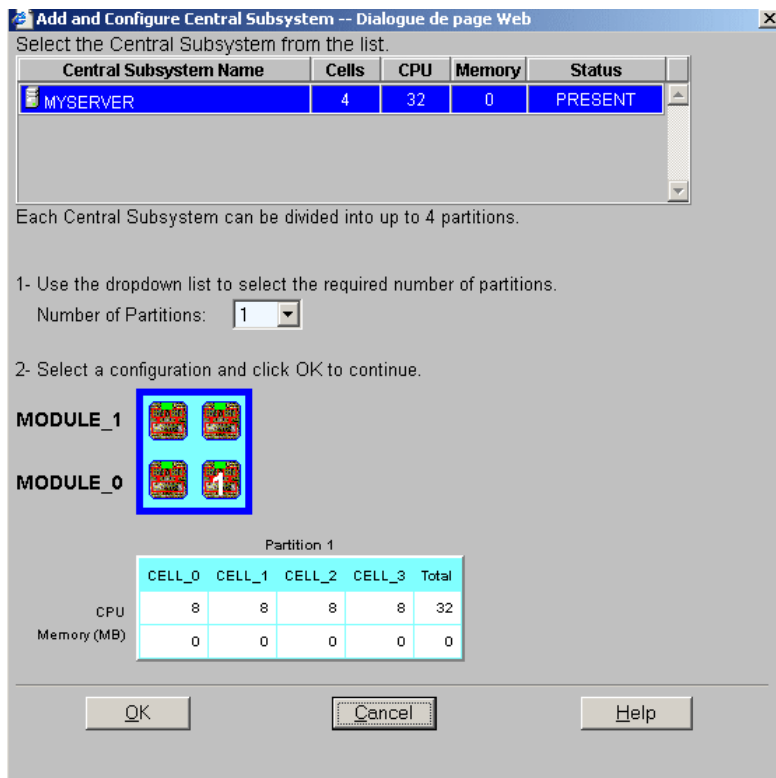
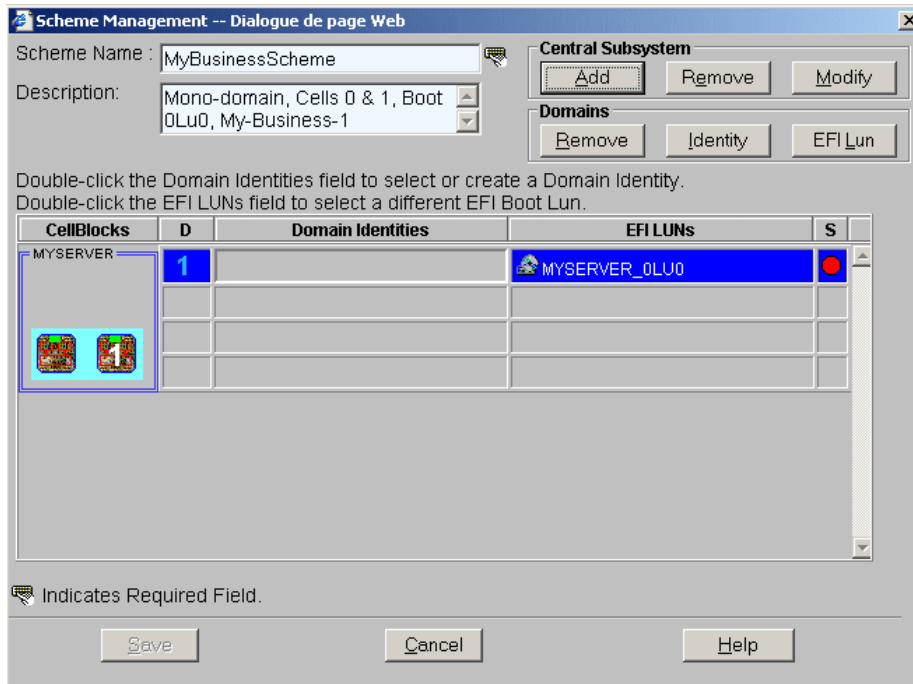

Figure 127. Central Subsystem configuration dialog – example 1

6. Check that the required Central Subsystem is highlighted and select **1** in the **Number of Parts** dropdown list.
7. Select the required partition configuration and click **OK** to return to the **Scheme Management** dialog.

The **Status** icons are red because a **Domain Identities** are required to complete domain configuration.

NovaScale 6080/6160 Server



NovaScale 6320 Server

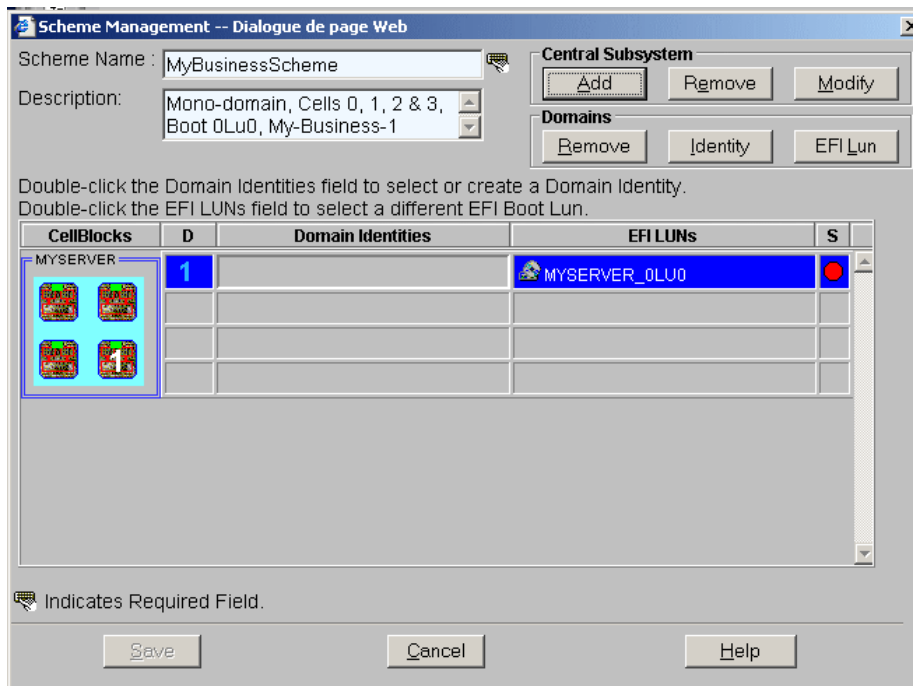
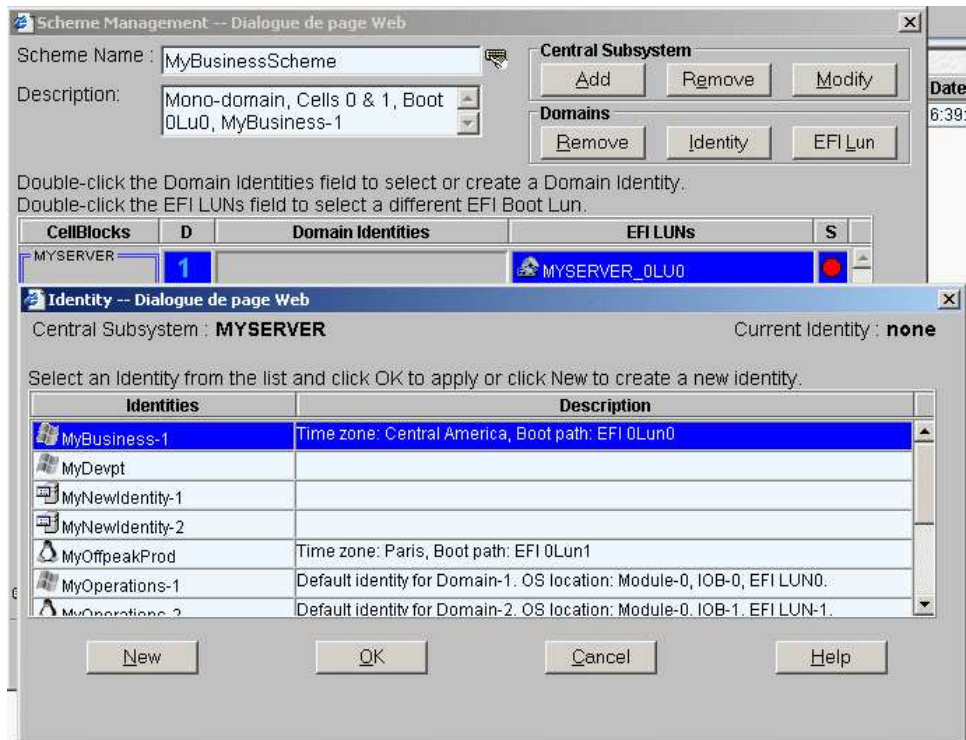

Figure 128. Scheme Management dialog – example 1

8. Double-click the empty **D1 Identities** field. The **Identities List** dialog opens.

NovaScale 6080/6160 Server



NovaScale 6320 Server

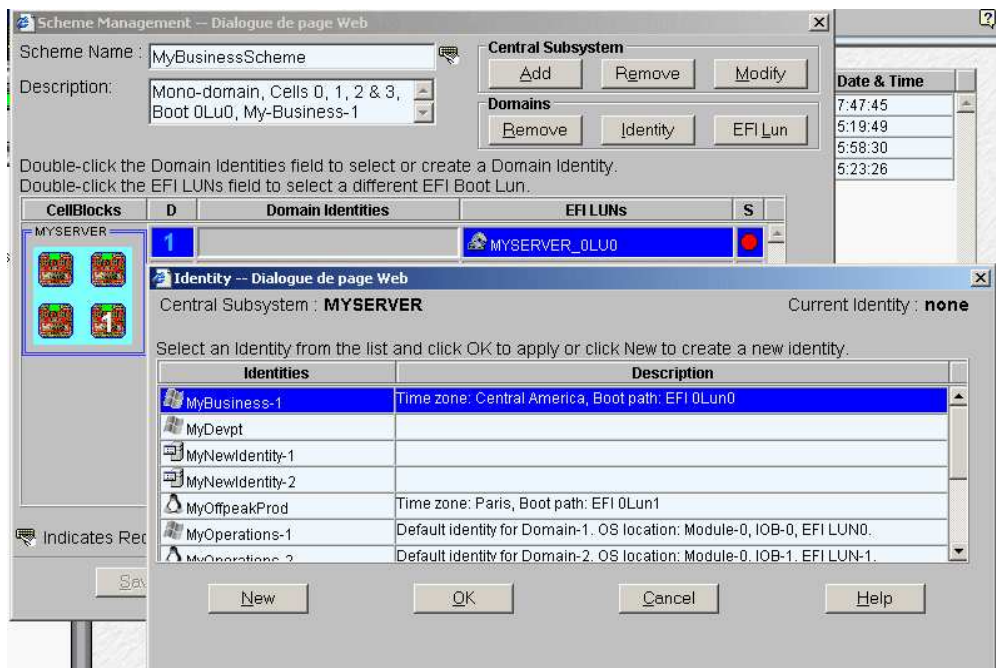

Figure 129. Identities list dialog – example 1

9. If the required identity is in the list, go to Step 12.
If you want to create a new identity for this domain, click **New** to open the **Create New Identity** dialog.

10. Complete the **Name**, **Description**, **Domain Settings**, and **Management Parameters** fields.

Create a new Identity

Domain identity parameters are used to uniquely identify a domain.

Identity Name : MyBusiness-1

Description : Time zone: Central America, Boot path: EFI 0Lun0

Domain Settings

Select the Operating System and Version to be used by the domain to run your activities.

Operating System : Windows Version :

Management Parameters

Enter the Network Name and IP address to be used by System Management software to access the domain.
Enter the URL to be used by a Web browser to access the domain Web site.

Network Name : MyBusiness-1Net

IP Address : 123.123.12.1

URL : http://www.MyBusiness-1Web.com

Indicates Required Field.

OK Cancel Help

Figure 130. Create new identity dialog – example 1

11. Click **OK**. The new identity appears in the **Identities List** dialog.
12. Select the required identity from the list of available identities and click **OK** to return to the **Scheme Management** dialog. The corresponding **Status** icon turns green.

NovaScale 6080/6160 Server

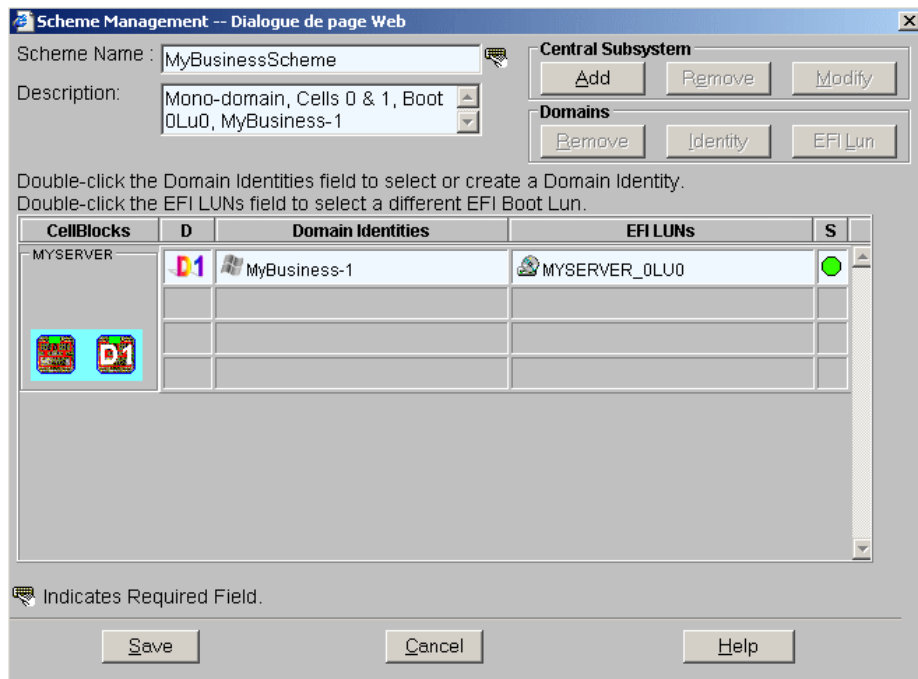

NovaScale 6320 Server

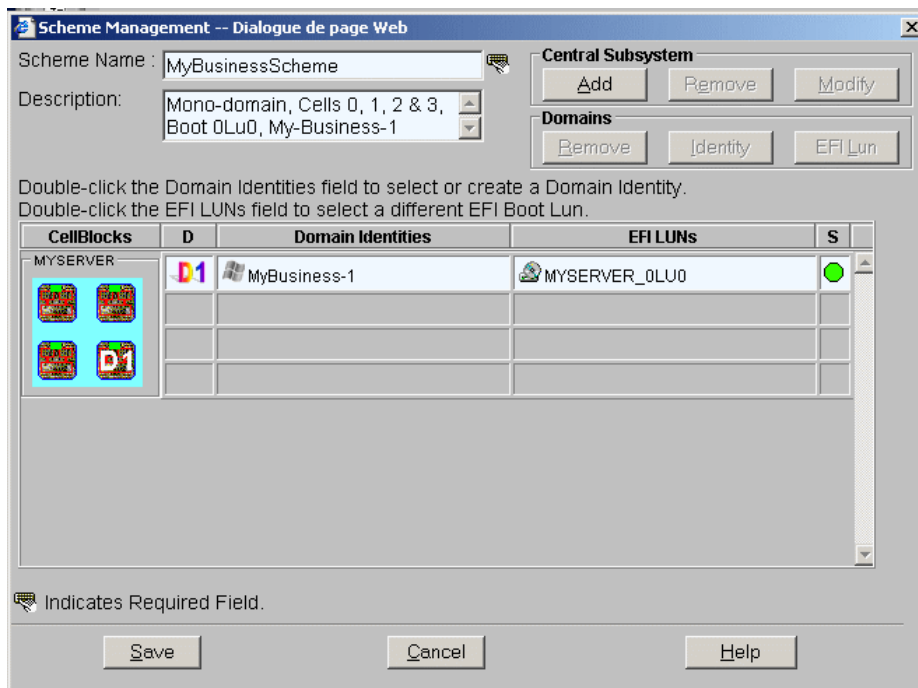
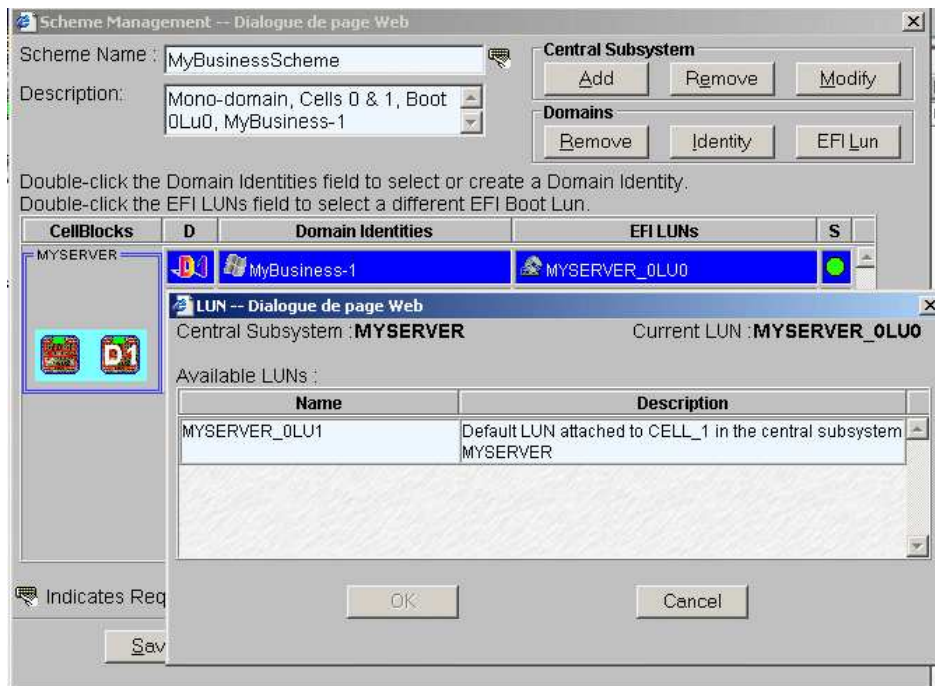

Figure 131. Scheme Management dialog – example 1

13. Check that the EFI Boot Lun for the domain is correct. If the EFI Boot Lun is correct, go to Step 14.
If the EFI Boot Lun is not correct, double-click the **EFI LUNs** field. The **LUN List** dialog opens, allowing you to choose the required EFI Boot Lun from the list of available LUNs

NovaScale 6080/6160 Server



NovaScale 6320 Server



Figure 132. Lun list dialog – example 1

14. Select the required EFI Boot Lun from the list of available Luns and click **OK** to return to the **Scheme Management** dialog.
15. Click **Save**. The domain scheme is now available for domain management.

Creating a Mono-Domain Scheme using a Part of Server Resources

The configuration criteria set out in the following tables is used to illustrate this example.

NovaScale 6080/6160 Server

Scheme	
Name	MyOffpeakProdScheme
Description	Mono-domain, Cell 1, Boot 0Lun1, MyOffpeakProd
Central Subsystem(s)	MyServer
Number of domains	1
Domain size	1 cell: Cell 1
EFI boot LUNs	0Lun1
IO resource location	0IOB1
Domain Identity	
Name	MyOffpeakProd
Description	Time zone: Paris, Boot path: EFI 0Lun1
Operating System	Linux
Domain network name	MyOffpeakProdNet
Domain IP address	124.124.1.0
Domain URL	http://www.MyOffpeakProdWeb.com

Table 46. Scheme configuration criteria – example 2 – mono-module server

NovaScale 6320 Server

Scheme	
Name	MyOffpeakProdScheme
Description	Mono-domain, Cell 1, Boot 0Lun1, MyOffpeakProd
Central Subsystem(s)	MyServer
Number of domains	1
Domain size	1 cell: Cell 1
EFI boot LUNs	0Lun1
IO resource location	0IOB1
Domain Identity	
Name	MyOffpeakProd
Description	Time zone: Paris, Boot path: EFI 0Lun1
Operating System	Linux
Domain network name	MyOffpeakProdNet
Domain IP address	124.124.1.0
Domain URL	http://www.MyOffpeakProdWeb.com

Table 47. Scheme configuration criteria – example 2 – bi-module server

**Note:**

A scheme can include more than one Central Subsystems. If you have more than one Bull NovaScale Server, see *Configuring Extended Systems*, on page 5-76.

To create a mono-domain scheme using a part of server resources:

1. Check that the required hardware resources are available (at least one IOB and one QBB are required for each server domain) and that the domain Operating System supports the required hardware resources (CPUs, DIMMs, ...).
2. From the Customer Administrator PAM tree, click **Configuration Tasks** → **Domains** → **Schemes** to open the **Schemes Management** pane.
3. Click **New** to open the **Scheme Creation** dialog.
4. Complete the **Scheme** and **Description** fields.

Scheme Management -- Dialogue de page Web

Scheme Name : MyOffpeakProdScheme

Description : Mono-domain, Cell 1, Boot 0Lun1, MyOffpeakProd

Central Subsystem

Add Remove Modify

Domains

Remove Identity EFI Lun

Welcome to the Domain Scheme wizard.

Your server Central Subsystem is designed around a flexible, cell-based architecture allowing dynamic partitioning into up to four physically independent domains.

A domain is a set of hardware and software resources, spanning one or more Central Subsystem cells, managed by a single Operating System instance.

A Domain Scheme is the template used to define and manage a set of domains that can be active simultaneously.

Complete the Scheme Name and optionally Description fields and click Add to begin domain scheme creation.

Indicates Required Field.

Save Cancel Help

Figure 133. Scheme creation dialog – example 2

5. Click **Central Subsystem** → **Add** to select the Central Subsystem to be used by the Scheme. The **Central Subsystem Configuration** dialog opens.

NovaScale 6080/6160 Server

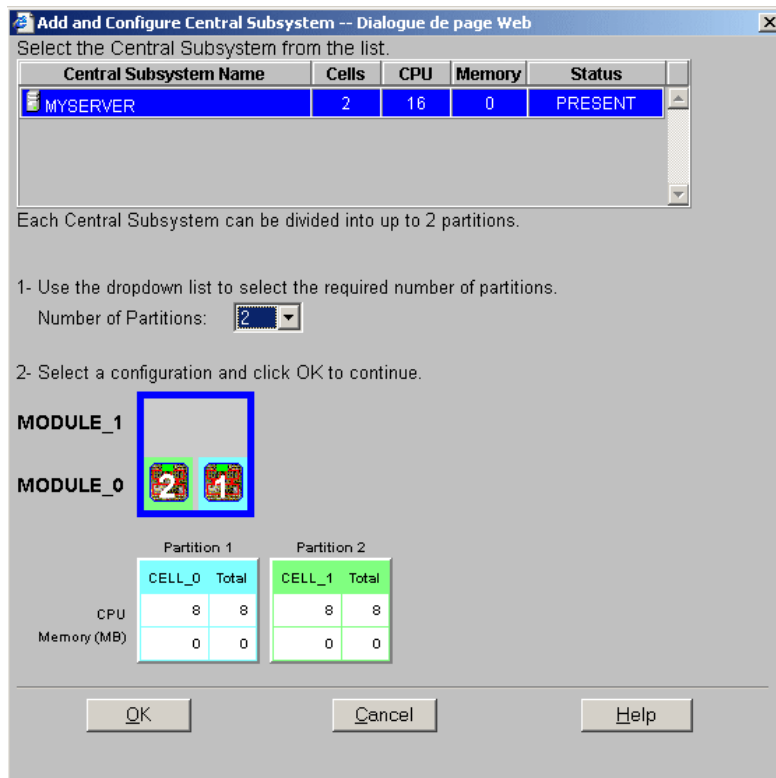

NovaScale 6320 Server

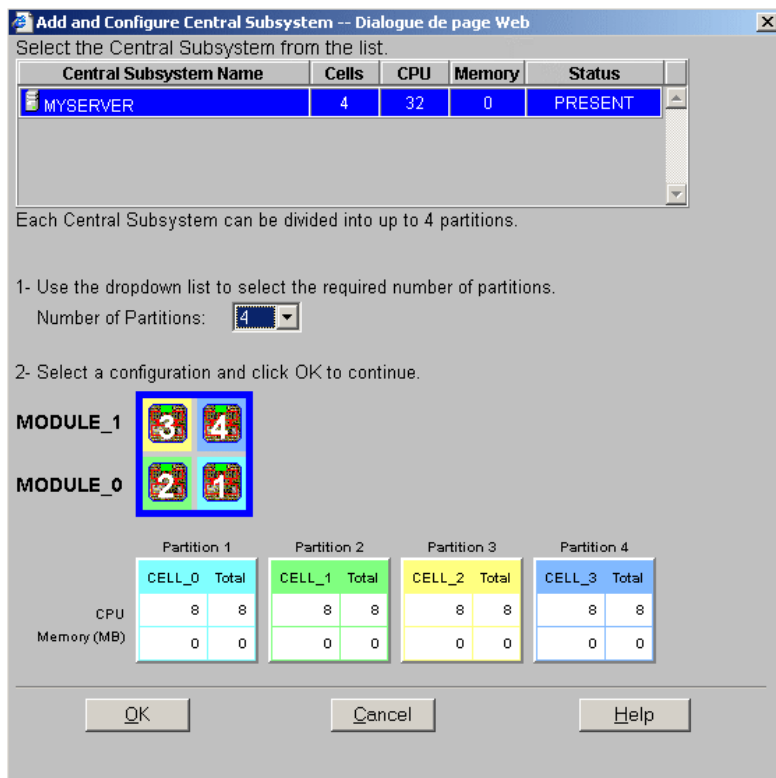
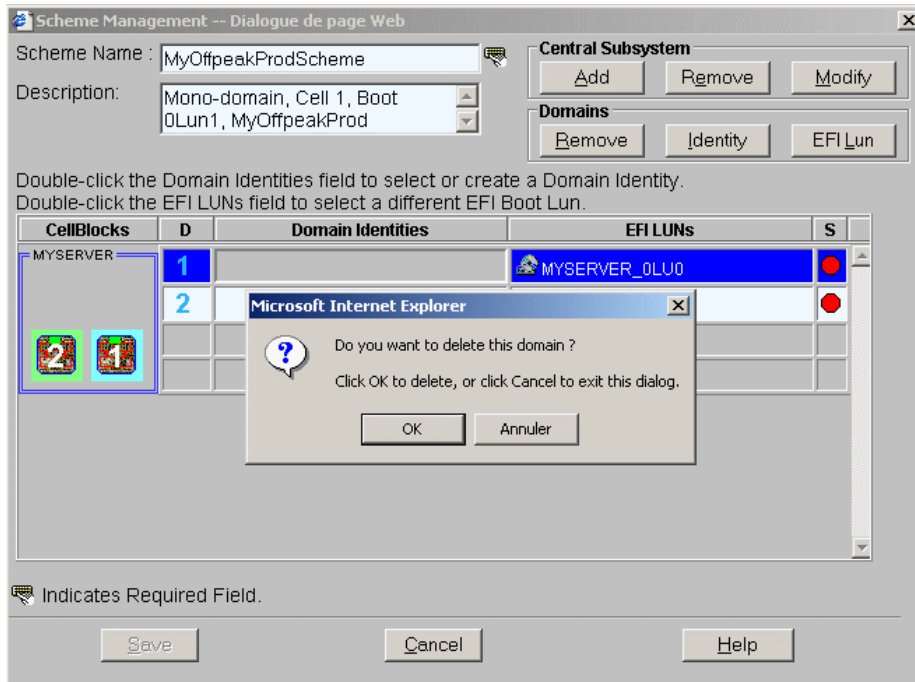

Figure 134. Central Subsystem configuration dialog – example 2

- Check that the required Central Subsystem is highlighted and select **2** (mono-module server) or **4** (bi-module server) in the **Number of Parts** dropdown list.

7. Select the required partition configuration and click **OK** to return to the **Scheme Management** dialog.
8. As you want this scheme to only use Cell 1, you must remove the domain using Cell 0 domains using the other cells. Hover the mouse over the cells represented in the **CellBlocks** diagram to identify the domain using Cell 0. **D2** is using Cell 1.
9. Click **D1** → **Domains** → **Remove** and click **OK** to remove the domain from the scheme.

NovaScale 6080/6160 Server



NovaScale 6320 Server

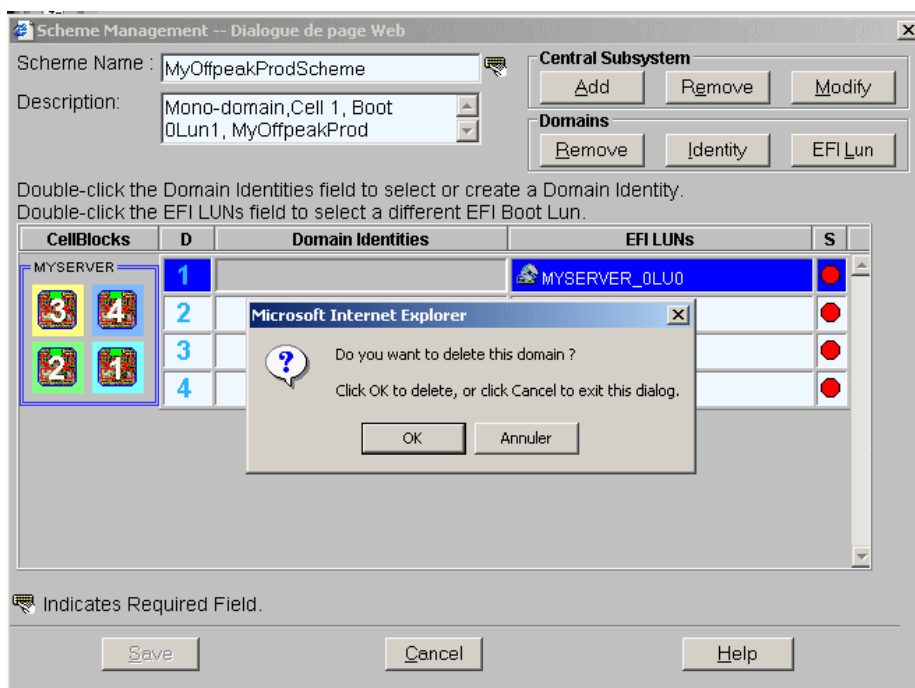
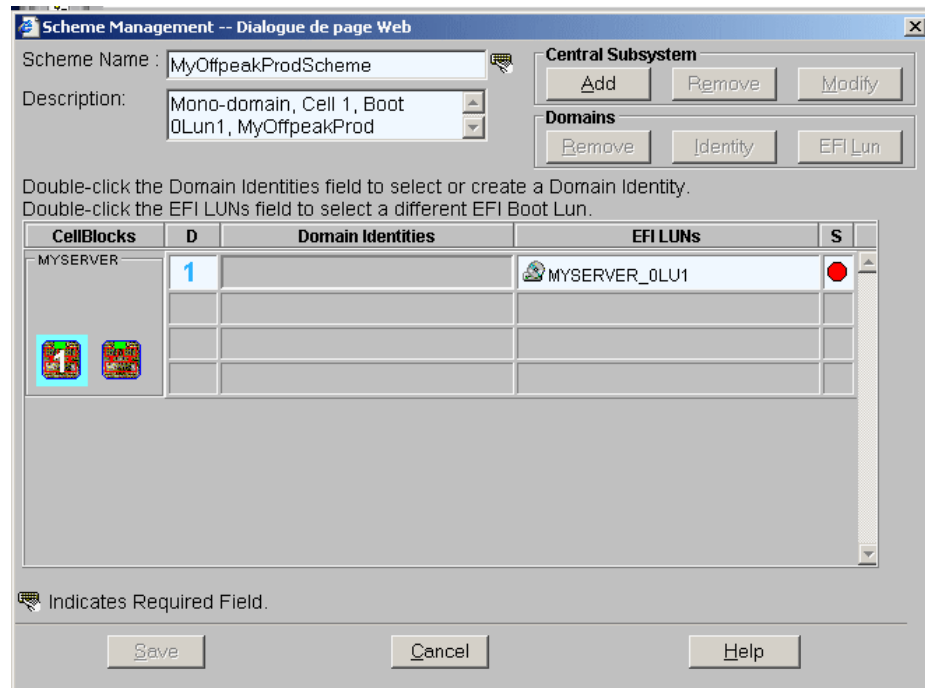

Figure 135. Remove domain confirmation dialog – example 2

10. Repeat Step 11 for **D3** and **D4**, where applicable.

12. Now, only one domain appears in the **Scheme Management** dialog. The **Status** icon is red because a **Domain Identity** is required to complete domain configuration.

NovaScale 6080/6160 Server



NovaScale 6320 Server

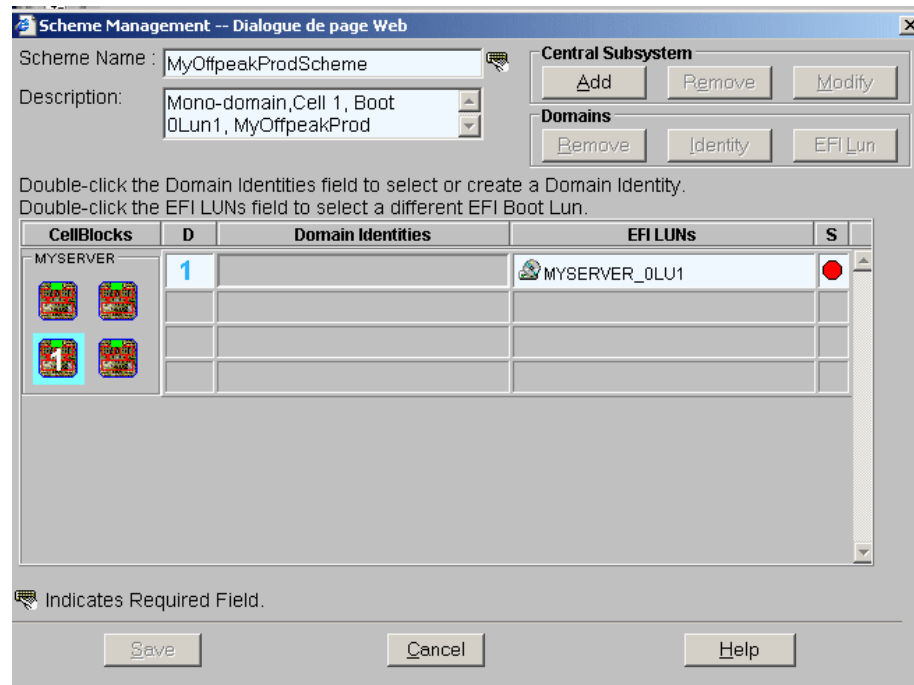
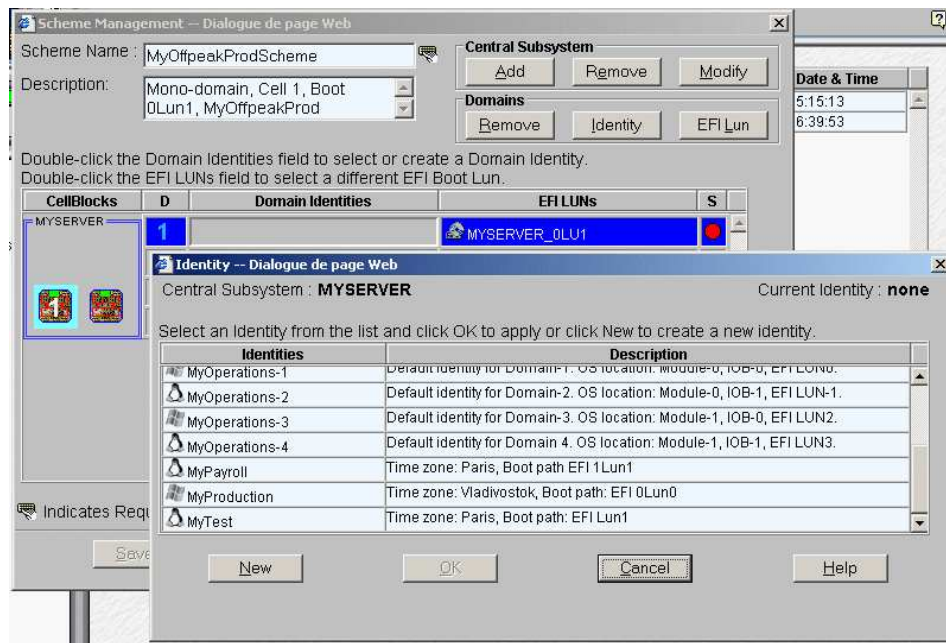

Figure 136. Scheme Management dialog – example 2

13. Double-click the empty **D1 Identities** field. The **Identities List** dialog opens.

NovaScale 6080/6160 Server



NovaScale 6320 Server

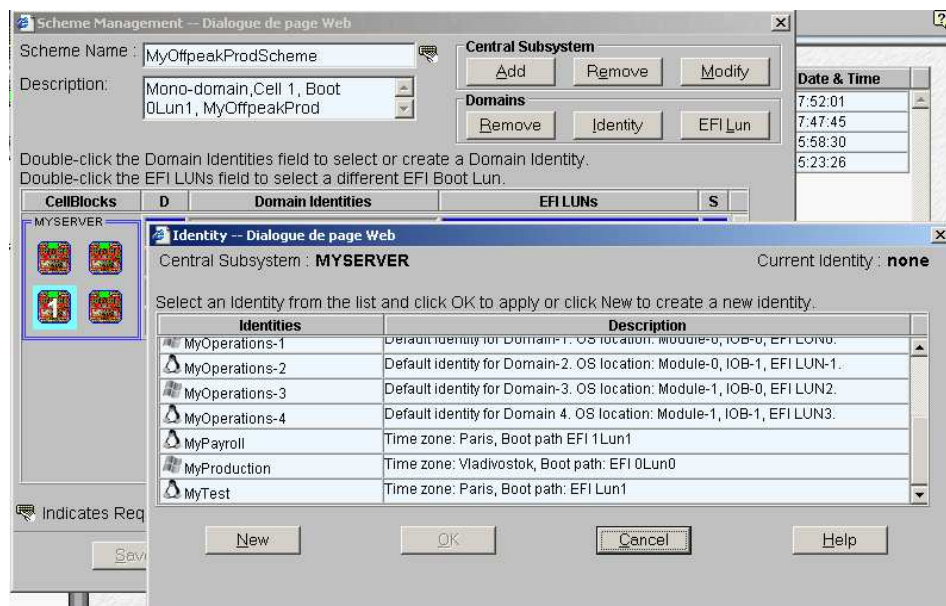

Figure 137. Identities list dialog – example 2

14. If the required identity is in the list, go to Step 17.
If you want to create a new identity for this domain, click **New** to open the **Create New Identity** dialog.

15. Complete the **Name**, **Description**, **Domain Settings**, and **Management Parameters** fields.

Create a new Identity

Domain identity parameters are used to uniquely identify a domain.

Identity Name : MyOffpeakProd

Description : Time zone: Paris, Boot path: EFI 0Lun1

Domain Settings

Select the Operating System and Version to be used by the domain to run your activities.

Operating System : Linux Version :

Management Parameters

Enter the Network Name and IP address to be used by System Management software to access the domain.

Enter the URL to be used by a Web browser to access the domain Web site.

Network Name : MyOffpeakProdNet

IP Address : 124.124.1.0

URL : http://www.MyOffpeakProdWeb.com

Indicates Required Field.

OK Cancel Help

Figure 138. Create new identity dialog – example 2

16. Click **OK**. The new identity appears in the **Identities List** dialog.
17. Select the required identity from the list of available identities and click **OK** to return to the **Scheme Management** dialog. The corresponding **Status** icon turns green.

NovaScale 6080/6160 Server

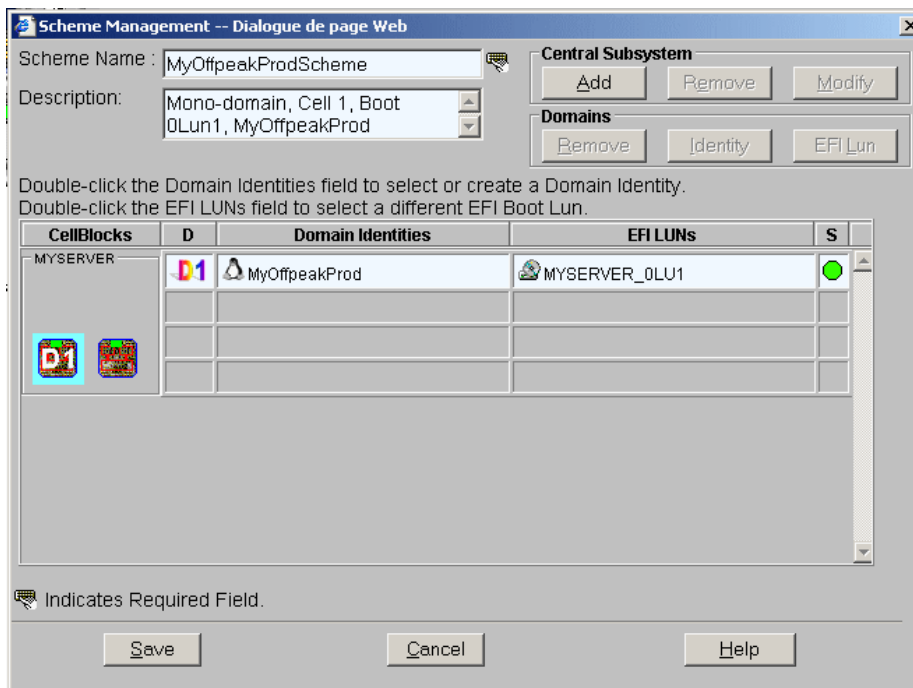

NovaScale 6320 Server

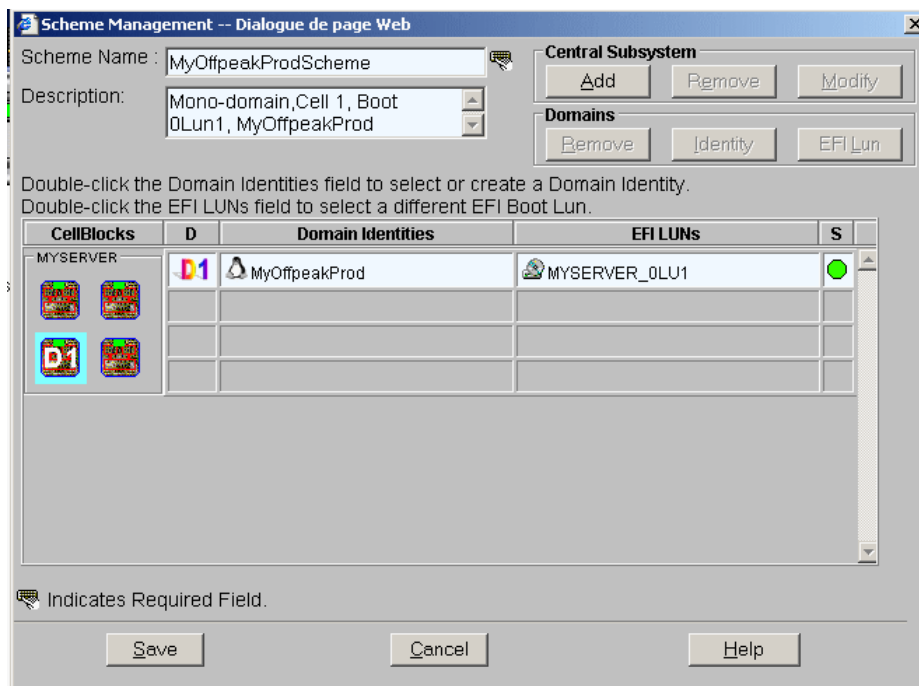

Figure 139. Scheme Management dialog – example 2

- Check that the EFI Boot Lun for the domain is correct and click **Save**. The domain scheme is now available for domain management.

Creating a Multi-Domain Scheme using all Server Resources

The configuration criteria set out in the following tables is used to illustrate this example.

NovaScale 6080/6160 Server

Scheme	
Name	MyProd_PayrollScheme
Description	Multi-domain, Cells 0 & 1, Boot 0Lun0 & 0Lun1 MyProduction & MyPayroll
Central Subsystem(s)	MyServer
Number of domains	2
Domain size	1 cell per domain: Cell 0 for Domain 1 Cell 1 for Domain 2
EFI boot LUNs	0Lun0 for MyProduction 0Lun1 for MyPayroll
IO resource location	0IOB0 mandatory for MyProduction 0IOB1 mandatory for MyPayroll
Domain Identity 1	
Name	MyProduction
Description	Time zone: Vladivostok, Boot path: EFI 0Lun0
Operating System	Windows
Domain network name	MyProductionNet
Domain IP address	121.121.12.1
Domain URL	http://www.MyProductionWeb.com
Domain Identity 2	
Name	MyPayroll
Description	Time zone: Paris, Boot path: EFI 0Lun1
Operating System	Linux
Domain network name	MyPayrollNet
Domain IP address	122.122.1.0
Domain URL	http://www.MyPayrollWeb.com

Table 48. Scheme configuration criteria – example 3 – mono-module server

NovaScale 6320 Server

Scheme	
Name	MyProd_PayrollScheme
Description	Multi-domain, Cells 0, 1, 2 & 3, Boot 0Lun0 & 0Lun3, MyProduction & MyPayroll
Central Subsystem(s)	MyServer
Number of domains	2
Domain size	Cells 0, 1 & 2 for Domain 1 Cell 3 for Domain 2
EFI boot LUNs	0Lun0 for MyProduction 0Lun3 for MyPayroll
IO resource location	0IOB0 mandatory, 0IOB1 & 1IOB0 optional, for MyProduction 1IOB1 mandatory for MyPayroll
Domain Identity 1	
Name	MyProduction
Description	Time zone: Vladivostok, Boot path: EFI 0Lun0
Operating System	Windows
Domain network name	MyProductionNet
Domain IP address	121.121.12.1
Domain URL	http://www.MyProductionWeb.com
Domain Identity 2	
Name	MyPayroll
Description	Time zone: Paris, Boot path: EFI 0Lun3
Operating System	Linux
Domain network name	MyPayrollNet
Domain IP address	122.122.1.0
Domain URL	http://www.MyPayrollWeb.com

Table 49. Scheme configuration criteria – example 3 – bi-module server



Note:

A scheme can include more than one Central Subsystems. If you have more than one Bull NovaScale Server, see *Configuring Extended Systems*, on page 5-76.

To create a multi-domain scheme using all server resources:

1. Check that the required hardware resources are available (at least one IOB and one QBB are required for each server domain) and that the domain Operating System supports the required hardware resources (CPUs, DIMMs, ...).
2. From the Customer Administrator PAM tree, click **Configuration Tasks** → **Domains** → **Schemes** to open the **Schemes Management** pane.
3. Click **New** to open the **Scheme Creation** dialog.
4. Complete the **Scheme** and **Description** fields.

NovaScale 6080/6160 Server

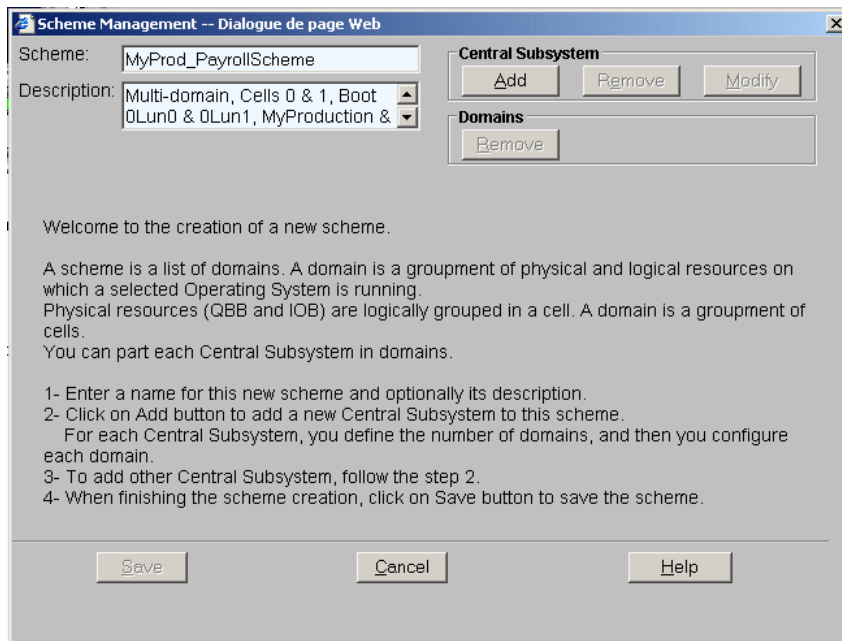

NovaScale 6320 Server

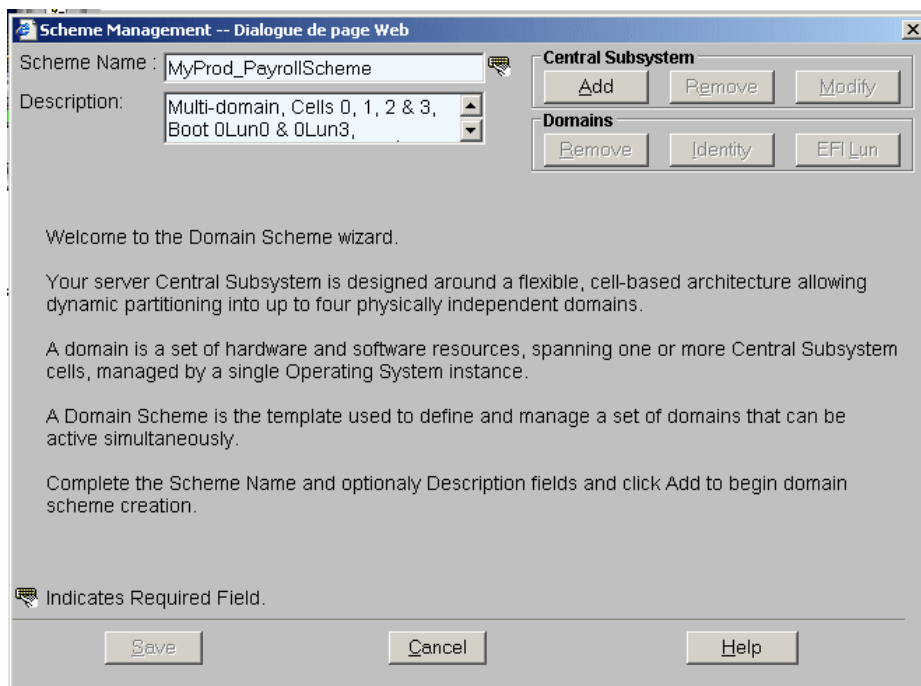
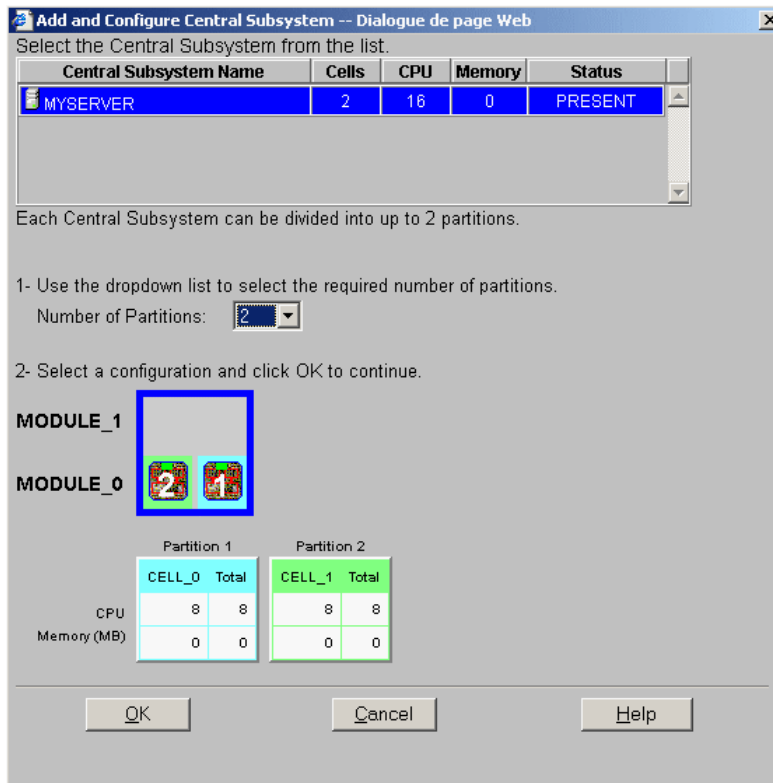

Figure 140. Scheme creation dialog – example 3

- Click **Central Subsystem** → **Add** to select the Central Subsystem to be used by the Scheme. The **Central Subsystem Configuration** dialog opens.

NovaScale 6080/6160 Server



NovaScale 6320 Server

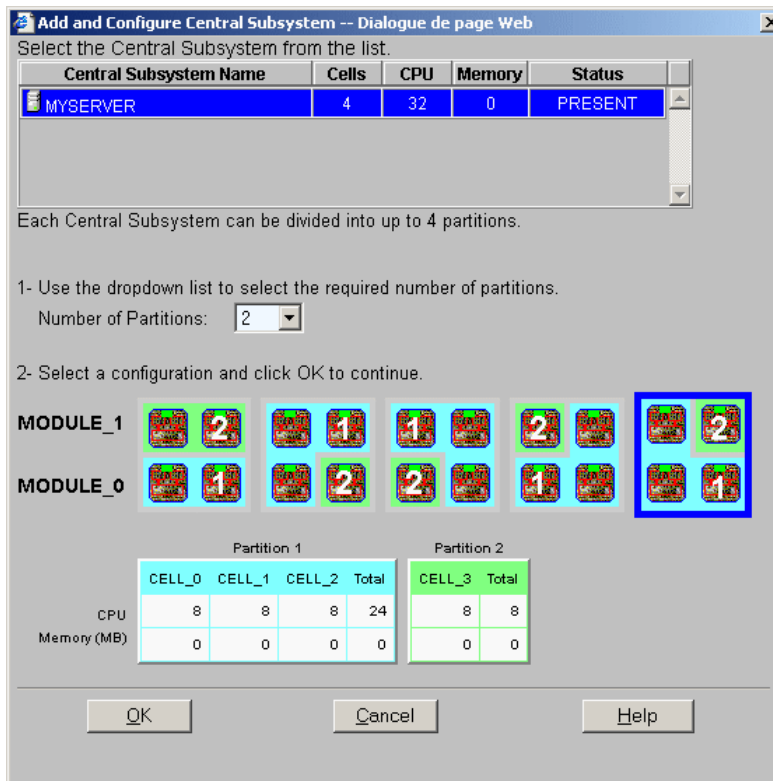
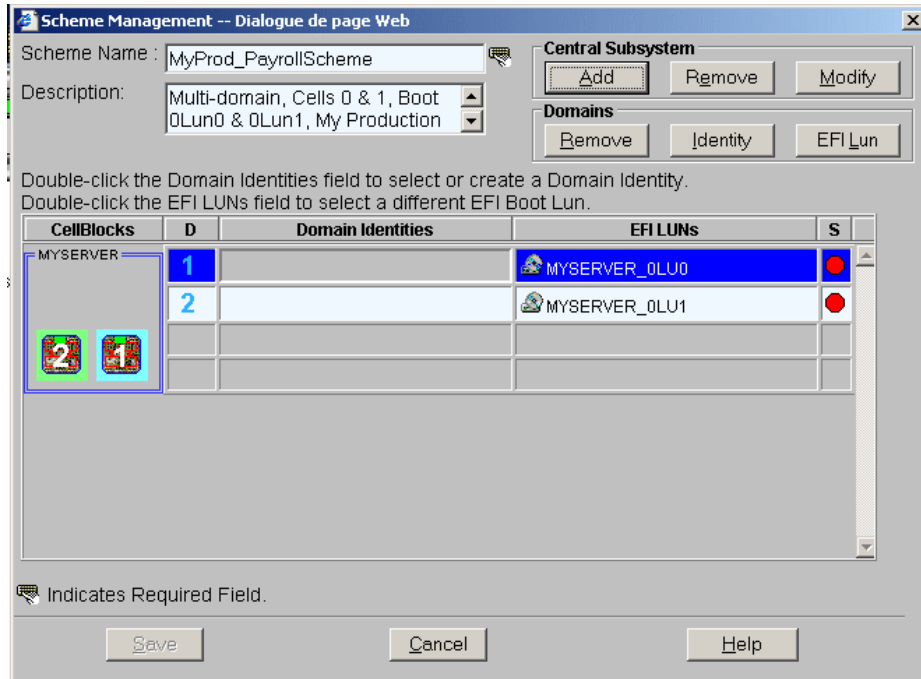

Figure 141. Central Subsystem configuration dialog – example 3

6. Check that the required Central Subsystem is highlighted and select **2** in the **Number of Parts** dropdown list.
7. Select the required partition configuration and click **OK** to return to the **Scheme Management** dialog.

The **Status** icons are red because **Domain Identities** are required to complete domain configuration.

NovaScale 6080/6160 Server



NovaScale 6320 Server

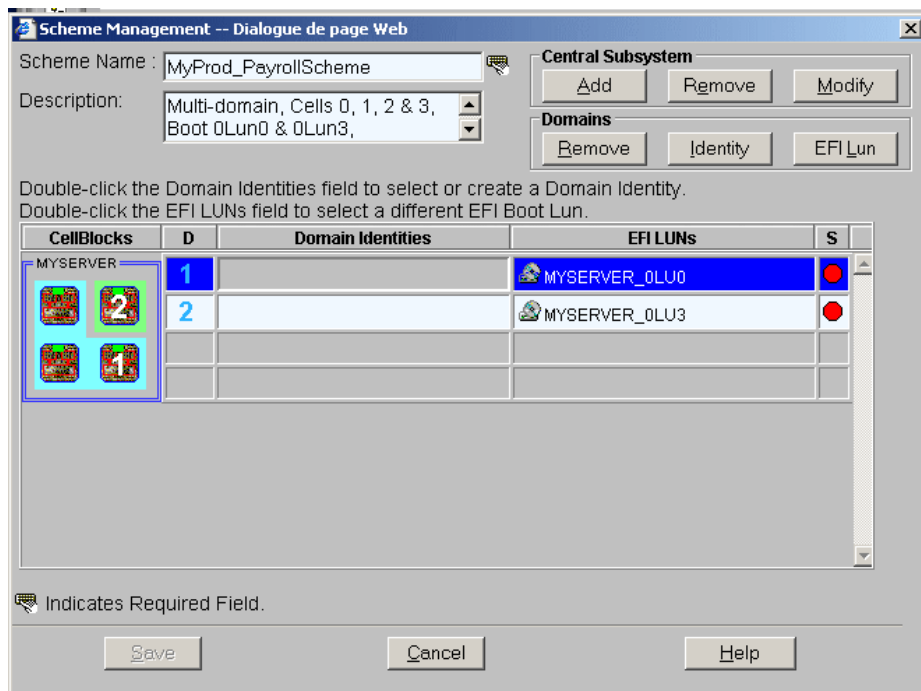
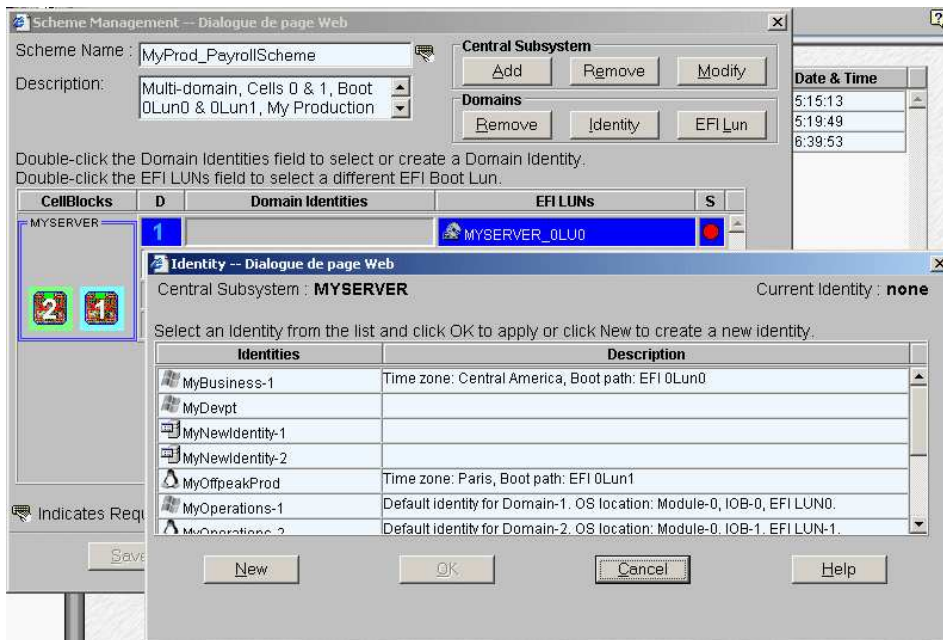

Figure 142. Scheme Management dialog – example 3

- Double-click the empty **D1 Identities** field. The **Identities List** dialog opens.

NovaScale 6080/6160 Server



NovaScale 6320 Server

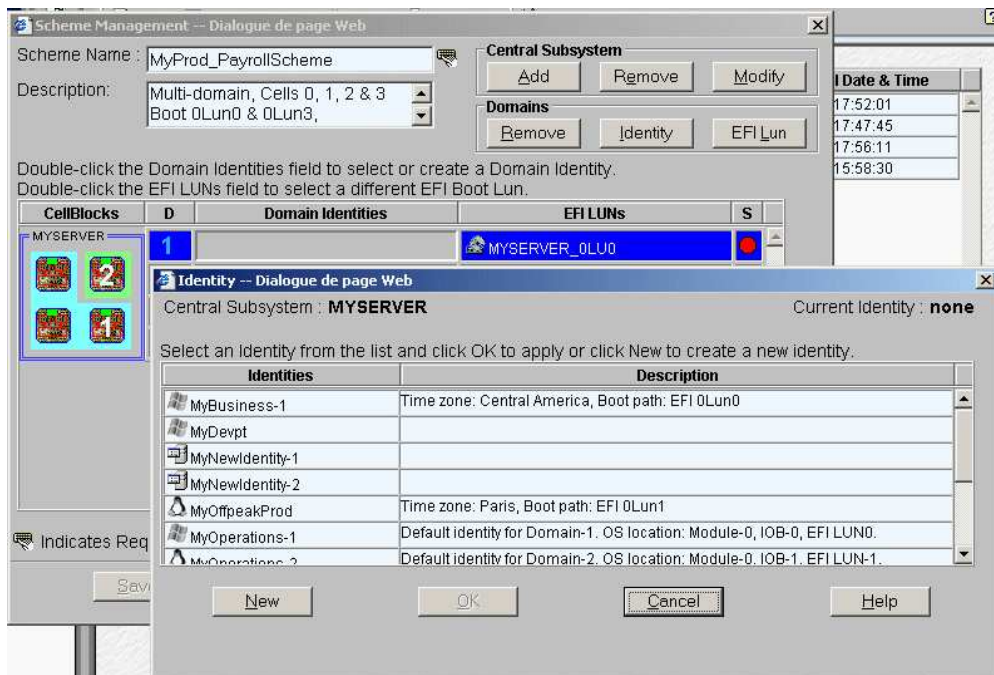

Figure 143. Identities list dialog – example 3

- If the required identity is in the list, go to Step 12.
To create a new identity for this domain, click **New** to open the **Create New Identity** dialog.

10. Complete the **Name**, **Description**, **Domain Settings**, and **Management Parameters** fields for **Domain Identity D1**.

Create a new Identity

Domain identity parameters are used to uniquely identify a domain.

Identity Name : MyProduction

Description : Time zone: Vladivostok, Boot path: EFI 0Lun0

Domain Settings

Select the Operating System and Version to be used by the domain to run your activities.

Operating System : Windows Version :

Management Parameters

Enter the Network Name and IP address to be used by System Management software to access the domain.

Enter the URL to be used by a Web browser to access the domain Web site.

Network Name : MyProductionNet

IP Address : 121.121.12.1

URL : http://MyProductionWeb.com

Indicates Required Field.

OK Cancel Help

Figure 144. Create new identity dialog – example 3

11. Click **OK**. The new identity appears in the **Identities List** dialog.
12. Select the required identity from the list of available identities and click **OK** to return to the **Scheme Management** dialog. The corresponding **Status** icon turns green.
13. Repeat Steps 8 to 12 for **Domain Identity D2**. The scheme is now completely configured.

NovaScale 6080/6160 Server

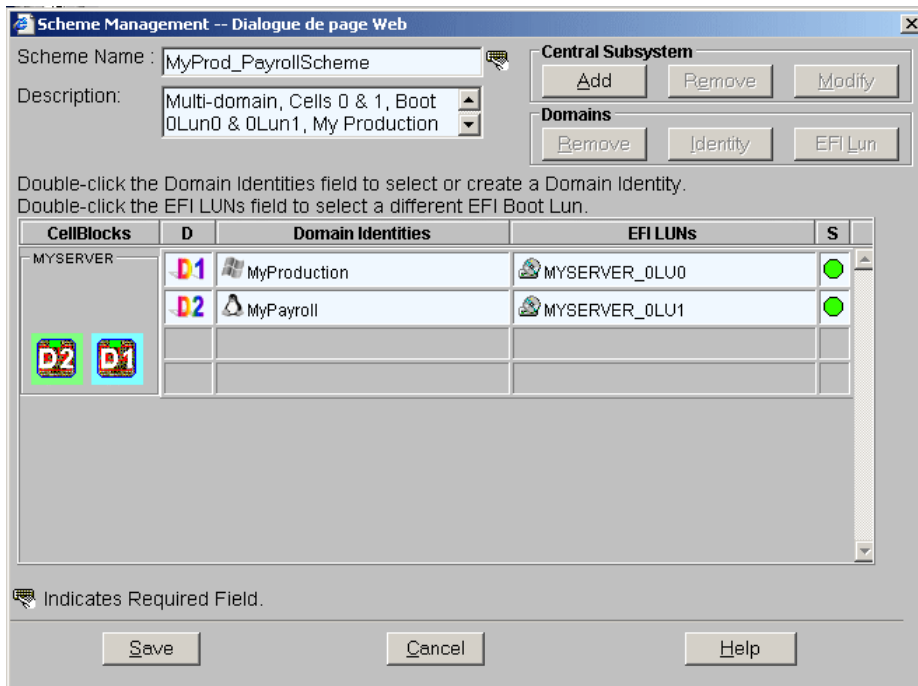

NovaScale 6320 Server

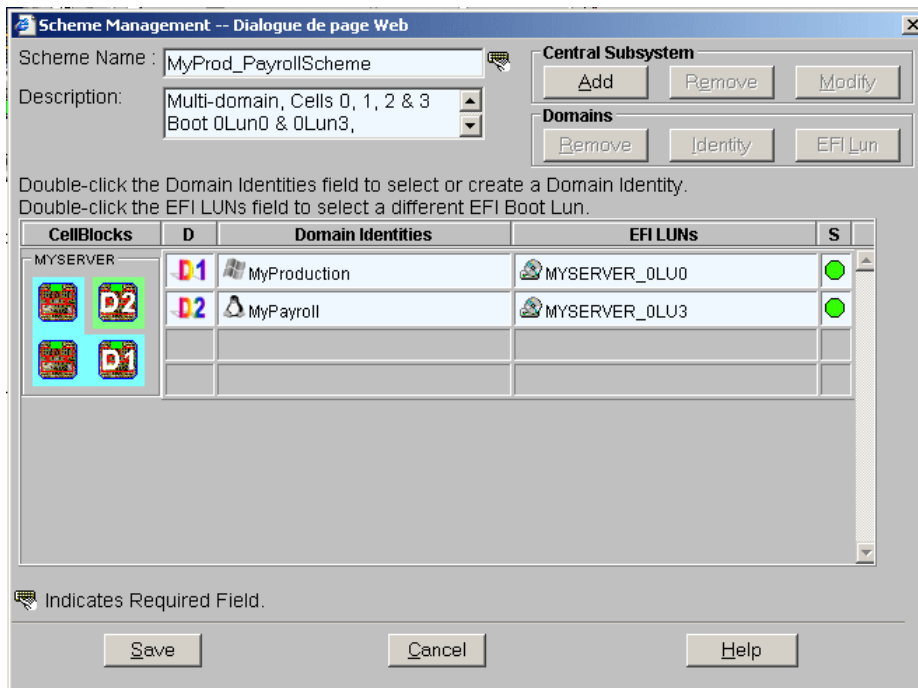

Figure 145. Scheme management dialog – example 3

14. Click **Save**. The domain scheme is now available for domain management.

Creating a Multi-Domain Scheme using a Part of Server Resources

The configuration criteria set out in the following table is used to illustrate this example.

NovaScale 6320 Server

Scheme	
Name	MyTest_DevptScheme
Description	Multi-domain, Cells 1, 2 & 3, Boot 0Lun1 & 0Lun2, MyTest & MyDevpt
Central Subsystem(s)	MyServer
Number of domains	2
Domain size	Cell 1 for Domain 1 Cells 2 & 3 for Domain 2
EFI boot LUNs	0Lun1 for MyTest 0Lun2 for MyDevpt
IO resource location	0IOB1 mandatory, for MyTest 1IOB0 mandatory, 1IOB1 optional, for MyDevpt
Domain Identity 1	
Name	MyTest
Description	Time zone: Paris, Boot path: EFI 0Lun1
Operating System	Linux
Domain network name	MyProductionNet
Domain IP address	121.121.12.1
Domain URL	http://www.MyProductionWeb.com
Domain Identity 2	
Name	MyDevpt
Description	Time zone: Paris, Boot path: EFI 0Lun2
Operating System	Windows
Domain network name	MyPayrollNet
Domain IP address	122.122.1.0
Domain URL	http://www.MyPayrollWeb.com

Table 50. Scheme configuration criteria – example 4 – bi-module server



Note:

A scheme can include more than one Central Subsystems. If you have more than one Bull NovaScale Server, see *Configuring Extended Systems*, on page 5-76.

To create a multi-domain scheme using a part of server resources:

1. Check that the required hardware resources are available (at least one IOB and one QBB are required for each server domain) and that the domain Operating System supports the required hardware resources (CPUs, DIMMs, ...).
2. From the Customer Administrator PAM tree, click **Configuration Tasks** → **Domains** → **Schemes** to open the **Schemes Management** pane.
3. Click **New** to open the **Scheme Creation** dialog.
4. Complete the **Scheme** and **Description** fields.

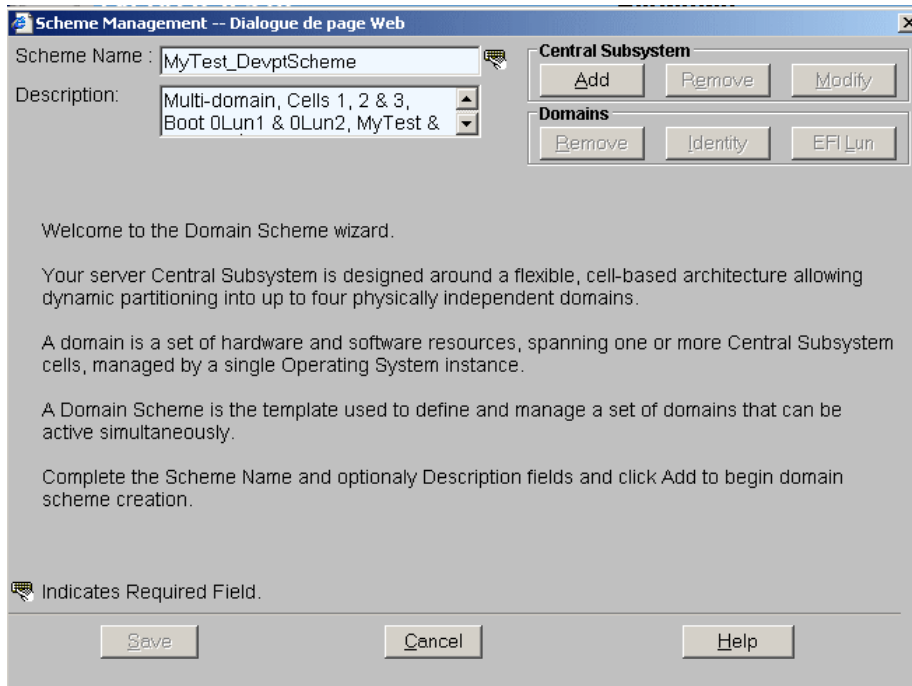

Figure 146. Scheme creation dialog – example 4

- Click **Central Subsystem** → **Add** to select the Central Subsystem to be used by the Scheme. The **Central Subsystem Configuration** dialog opens.

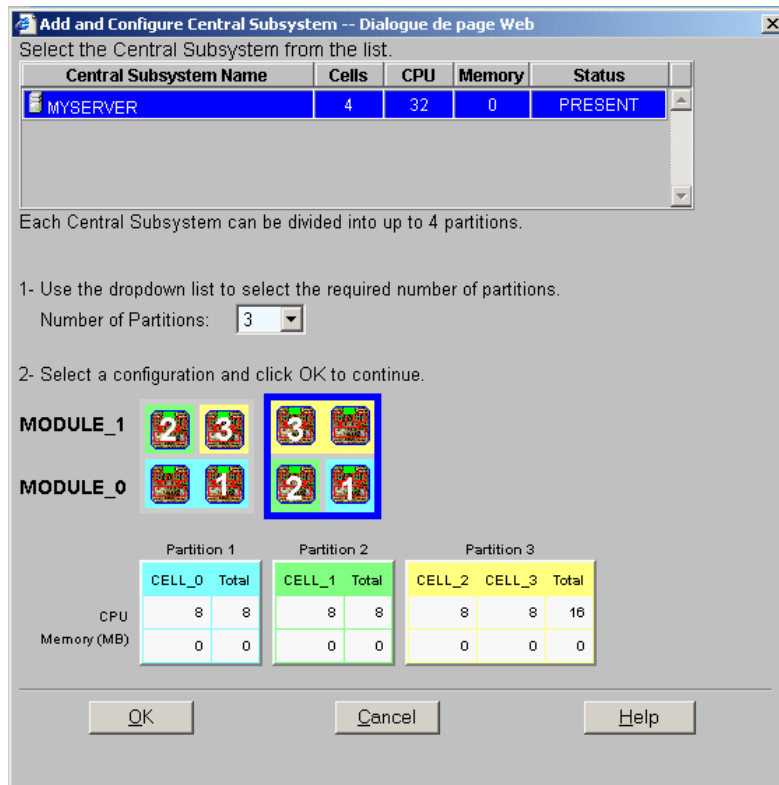

Figure 147. Central Subsystem configuration dialog – example 4

- Check that the required Central Subsystem is highlighted and select **3** in the **Number of Parts** dropdown list.
- Select the required partition configuration and click **OK** to return to the **Scheme Management** dialog.

The **Status** icons are red because **Domain Identities** are required to complete domain configuration.

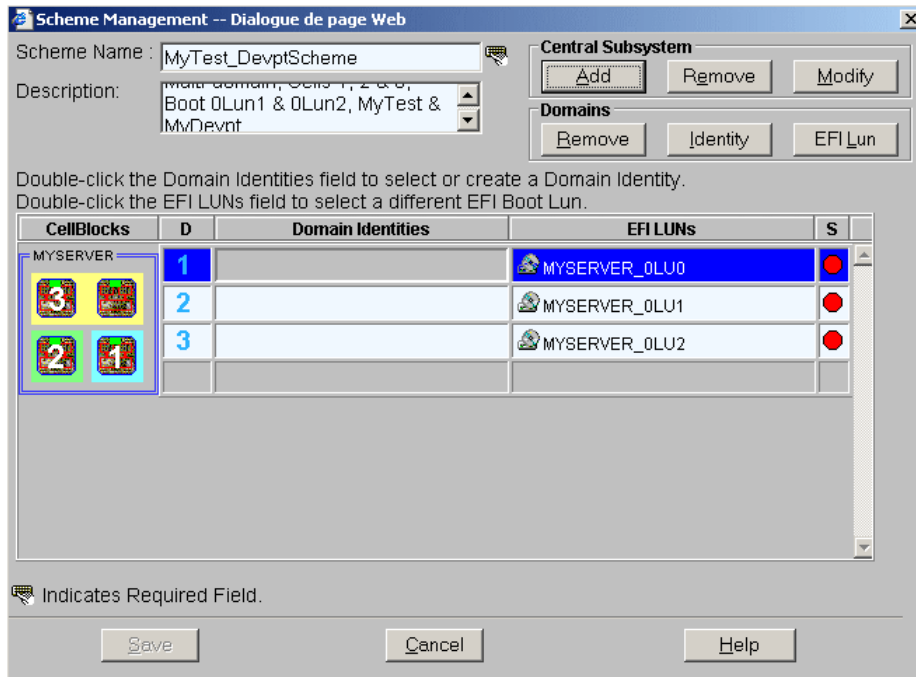

Figure 148. Scheme Management dialog – example 4

8. As you want this scheme to only use Cells 1, 2 and 3, you must remove the domain using Cell 0. Hover the mouse over the cells represented in the **CellBlocks** diagram to identify the domain using Cell 0. **D1** is using Cell 0.
9. Click **D1** → **Domains** → **Remove** and click **OK** to remove the domain from the scheme.

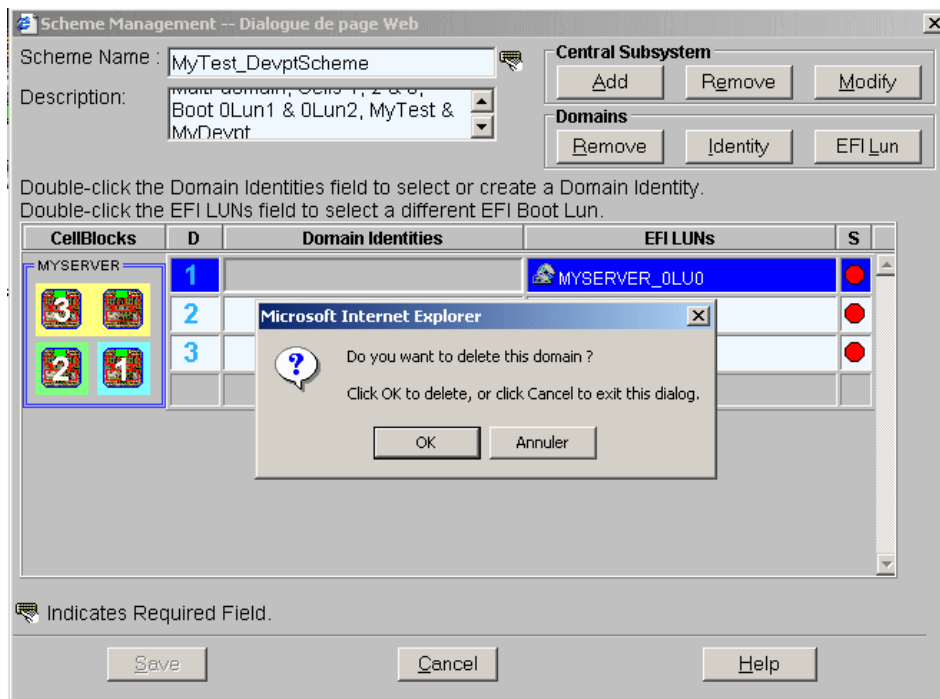

Figure 149. Remove domain confirmation dialog – example 4

10. Now, only two domains appear in the **Scheme Management** dialog. The **Status** icons are red because **Domain Identities** are required to complete domain configuration.

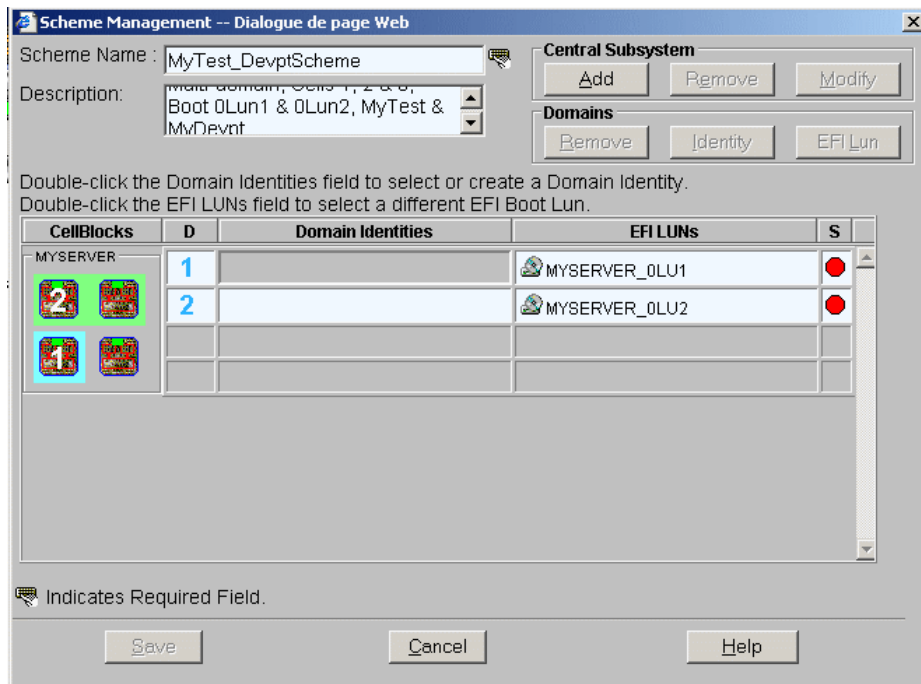

Figure 150. Scheme Management dialog – example 4

11. Double-click the empty **D1 Identities** field. The **Identities List** dialog opens.

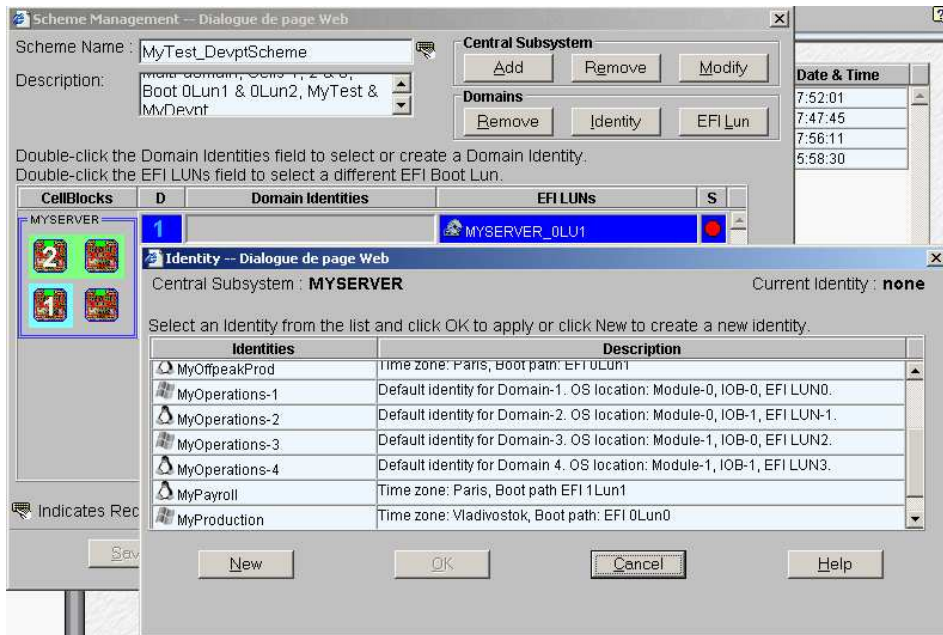

Figure 151. Identities list dialog – example 4

12. If the required identity is in the list, go to Step 15.

To create a new identity for this domain, click **New** to open the **Create New Identity** dialog.

13. Complete the **Name**, **Description**, **Domain Settings**, and **Management Parameters** fields for **Domain Identity D1**.

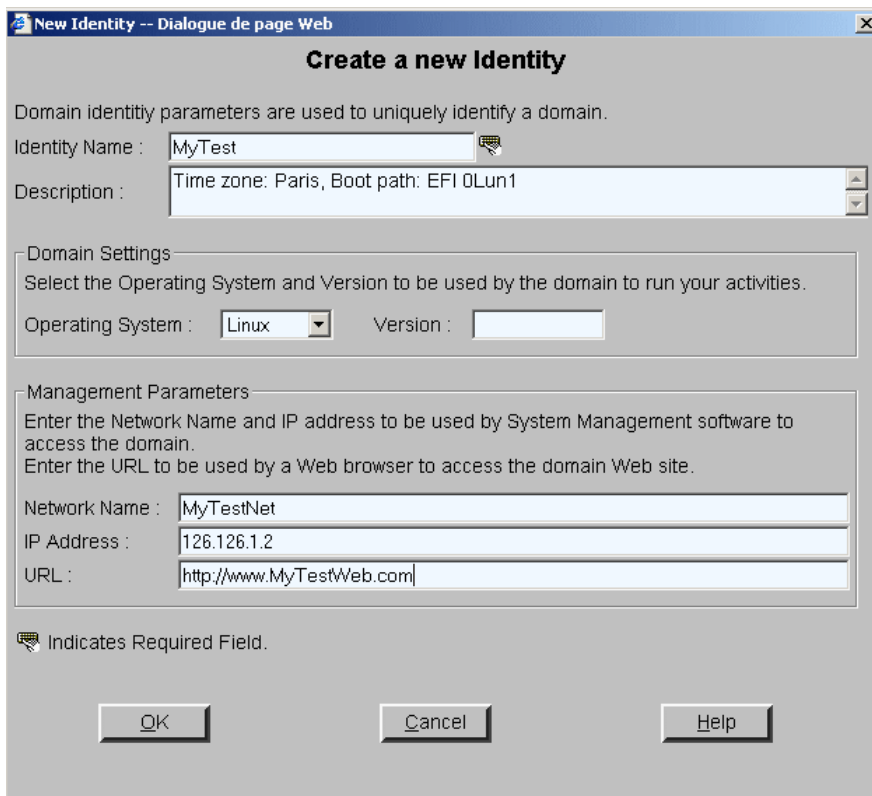

Figure 152. Create new identity dialog – example 4

14. Click **OK**. The new identity appears in the **Identities List** dialog.

15. Select the required identity from the list of available identities and click **OK** to return to the **Scheme Management** dialog. The corresponding **Status** icon turns green.
16. Repeat Steps 11 to 15 for **Domain Identity D2**. The scheme is now completely configured.

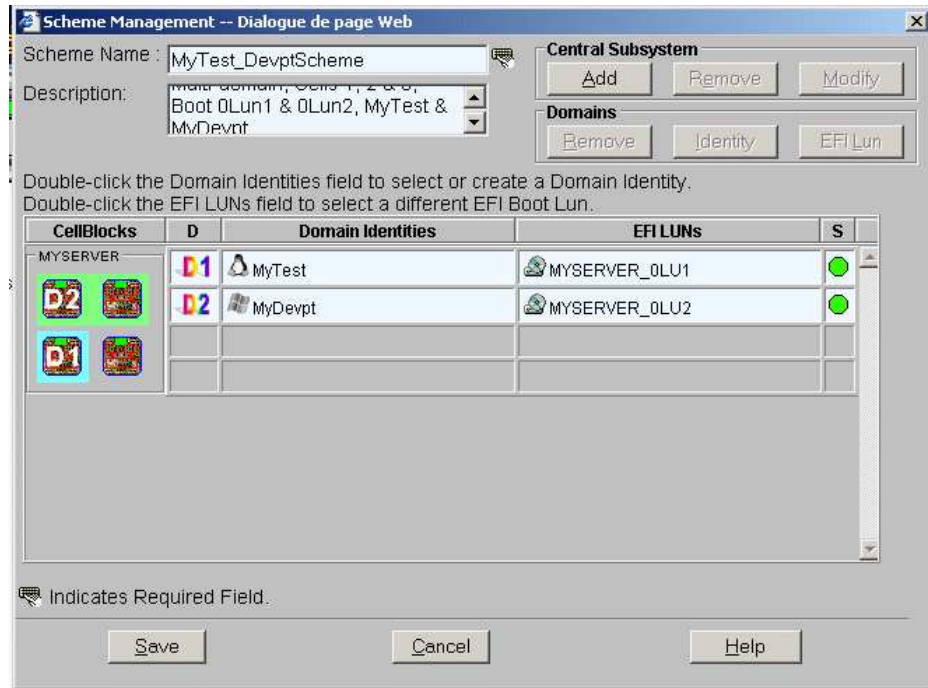

Figure 153. Scheme management dialog – example 4

17. Click **Save**. The domain scheme is now available for domain management.



Note:

Cell 0 is free and available for use by another scheme, if required.

Configuring and Managing Extended Systems

A single PAP unit can administer, monitor, and manage several Central Subsystems.

The PAM **Domain Scheme Wizard** allows easy configuration of extended systems.

Please contact your BULL Customer Sales Representative for details.

Clearing, Loading, Saving NVRAM Variables

NVRAM variables are available for each LUN. According to requirements, these variables can be cleared, saved and/or loaded.



Note:

NVRAM variables can only be saved when the corresponding domain is active.

To clear, save and/or load NVRAM variables:

1. Click **Configuration Tasks** → **Domains** → **LUNs** in the PAM tree to open the **Logical Units** page.

Name	EFI	In Use In Domain	In Use In Scheme	NVRAM	Description
MYSERVER_0LU0	EFI	Yes	Yes	No	Default LUN attached to CELL_0 in the central subsystem MYSERVER
MYSERVER_0LU1	EFI	Yes	Yes	No	Default LUN attached to CELL_1 in the central subsystem MYSERVER
MYSERVER_0LU2	EFI	Yes	Yes	No	Default LUN attached to CELL_2 in the central subsystem MYSERVER
MYSERVER_0LU3	EFI	Yes	Yes	No	Default LUN attached to CELL_3 in the central subsystem MYSERVER

Name	Default LUN name
EFI	EFI This LUN is a boot LUN. DATA This LUN is a data LUN.
In Use in Domain	Yes This LUN is used by a domain currently loaded in the Domain Manager Control pane. No This LUN is not used by a domain currently loaded in the Domain Manager Control pane.
In Use in Scheme	Yes This LUN has been allocated to a domain within a Domain Scheme. No This LUN has not been allocated to a domain within a Domain Scheme.
NVRAM	Yes NVRAM variables have been saved for this LUN. No NVRAM variables have not been saved for this LUN.
Description	Default description, indicating LUN location (Central Subsystem name and Cell).

Figure 154. Logical Units page

2. Select the required LUN from the list of available LUNs and click **NVRAM**. The **NVRAM Variables** dialog opens:
 - a. Click **Clear** to clear displayed NVRAM variables. When requested, click **OK** to confirm.
 - b. Click **Save** to save NVRAM variables for the selected LUN (currently used by an active domain). When requested, enter the name of the file to which NVRAM variables are to be saved. The NVRAM variables file is stored in the PAM SiteData directory.
 - c. Click **Load** to load previously saved NVRAM variables from the PAM SiteData directory.

Updating the LUN List

The list of available LUNs is automatically created when a Central Subsystem is declared and/or added. You can update the list of available LUNs at any time to reflect configuration changes.

To update the LUN list:

1. Click **Configuration Tasks** → **Domains** → **LUNs** in the PAM tree to open the **Logical Units** page.
2. Click **Update**. When requested, click **OK** to confirm. The new LUN list is displayed in the **Logical Units** page.

Limiting Access to Hardware Resources

As Customer Administrator, you can use the PAM software **Exclusion / Inclusion** function to logically limit access to certain hardware resources, such as:

IOBs	<p>When a domain comprises more than one cell (therefore more than one IOB), the Master IOB is the one hosting the boot disk. The other IOBs in the domain are Slave IOBs.</p> <p>Slave IOBs can be safely excluded from a domain, but connected peripherals will no longer be accessible.</p> <p>Note: If the Master IOB is excluded, system disks will no longer be accessible and the domain will not power up.</p>
IOB HubLinks	<p>All IOB HubLinks can be safely excluded from a domain, but connected peripherals will no longer be accessible.</p> <p>IOB HubLinks are organized as follows: HubLink_1 controls PCI Slots 1 & 2 HubLink_2 controls PCI slots 3, 4, & 5 HubLink_3 controls PCI slots 6, 7, & 8 HubLink_4 controls PCI slots 9, 10, & 11</p> <p>Note: If Master IOB HubLink_1 is excluded, system disks will no longer be accessible and the domain will not power up.</p>
PCI Slots	<p>All PCI slots can be safely excluded from a domain, but connected peripherals will no longer be accessible.</p> <p>Note: If Master IOB PCI Slots 1, 2 are excluded, system disks will no longer be accessible and the domain will not power up.</p>
IOBs	<p>Slave IOBs can be safely excluded from a domain, but connected peripherals will no longer be accessible.</p> <p>Note: If the Master IOB is excluded, the domain will not power up.</p>

Figure 155. Hardware exclusion options



Notes:

Hardware exclusion / inclusion is a hardware management function, not a domain management function.

To be taken into account, exclusion / inclusion requires domain power OFF/ON.

See *Excluding / Including Hardware Elements*, on page 4-22.

Scheme, Domain Identity, and Resources Checklists



Important:

At least one QBB and one IO box is required for each server domain.

Scheme Checklist	
Name	What name do I want to use for my Scheme?
Description	How can I describe my Scheme to reflect its scope?
Central Subsystem(s)	Which Central Subsystem(s) do I want to use?
Number of domains	How many domains do I need?
Domain size	How many cells do I want to assign to each domain?
EFI boot LUNs	Which EFI boot LUN do I want to use for each domain?
I/O resource location	Which cells host the I/O resources I want to use?

Table 51. Scheme configuration checklist

Domain Identity Checklist	
Name	What name do I want to use for my Domain Identity to reflect the tasks/jobs it will run?
Description	How can I describe my Domain Identity to reflect its use?
Operating System	Which OS do I want to run on this domain? Will this OS support assigned hardware (CPUs, DIMMs)?
Domain network name	Which network name will be used to identify this domain?
Domain IP address	Which IP address will be used to reach this domain?
Domain URL	Which URL can be used to reach my domain Web site (if any)?

Table 52. Domain Identity configuration checklist

Resources Checklist			
Central Subsystem:			
Cell 0		Cell 1	
QBBs	QBB0	QBBs	QBB2
	QBB1		QBB3
IO Box	IOB0	IO Box	IOB1
EFI Boot Lun	0Lu0	EFI Boot Lun	0Lu1
OS instance		OS instance	
I/O Resources		I/O Resources	
IOB0_Slot 1		IOB1_Slot 1	
IOB0_Slot 2		IOB1_Slot 2	
IOB0_Slot 3		IOB1_Slot 3	
IOB0_Slot 4		IOB1_Slot 4	
IOB0_Slot 5		IOB1_Slot 5	
IOB0_Slot 6		IOB1_Slot 6	
IOB0_Slot 7		IOB1_Slot 7	
IOB0_Slot 8		IOB1_Slot 8	
IOB0_Slot 9		IOB1_Slot 9	
IOB0_Slot 10		IOB1_Slot 10	
IOB0_Slot 11		IOB1_Slot 11	

Table 53. Resources checklist – part 1

Resources Checklist			
Central Subsystem:			
Cell 2		Cell 3	
QBBs	QBB0	QBBs	QBB2
	QBB1		QBB3
IO Box	IOB0	IO Box	IOB1
EFI Boot Lun	1Lu0	EFI Boot Lun	1Lu1
OS instance		OS instance	
I/O Resources		I/O Resources	
IOB0_Slot 1		IOB1_Slot 1	
IOB0_Slot 2		IOB1_Slot 2	
IOB0_Slot 3		IOB1_Slot 3	
IOB0_Slot 4		IOB1_Slot 4	
IOB0_Slot 5		IOB1_Slot 5	
IOB0_Slot 6		IOB1_Slot 6	
IOB0_Slot 7		IOB1_Slot 7	
IOB0_Slot 8		IOB1_Slot 8	
IOB0_Slot 9		IOB1_Slot 9	
IOB0_Slot 10		IOB1_Slot 10	
IOB0_Slot 11		IOB1_Slot 11	

Table 54. Resources checklist – part 2

Section V – Creating Event Subscriptions and User Histories

This section explains how to:

- Customize the PAM Event Messaging System, on page 5-85
- Set up Event Subscriptions, on page 5-86
- Create, Edit, Delete an E-mail Server, on page 5-88
- Create, Edit, Delete an E-mail Account, on page 5-90
- Create, Edit, Delete a User History, on page 5-92
- Enable / Disable Event Channels, on page 5-96
- Create, Edit, Delete an Event Subscription, on page 5-97
- Understand Event Message Filtering Criteria, on page 5-99
- Preselect, Create, Edit, Delete an Event Filter, on page 5-109

Customizing the PAM Event Messaging System

During operation, all Central Subsystem activity messages are automatically logged in predefined System Histories that can be viewed and archived by members of the Customer Administrator group. In addition, PAM software reports and logs environmental, command, and hardware errors.

A comprehensive set of Event Message subscriptions allows connected and non-connected users to be notified of system status and activity.

The PAM event messaging system is based on a subscription mechanism allowing the Customer Administrator to send precisely filtered event messages to targeted individuals and/or groups via four channels (WEB Interface, E-mail, User History, SNMP) as shown in Figure 156.

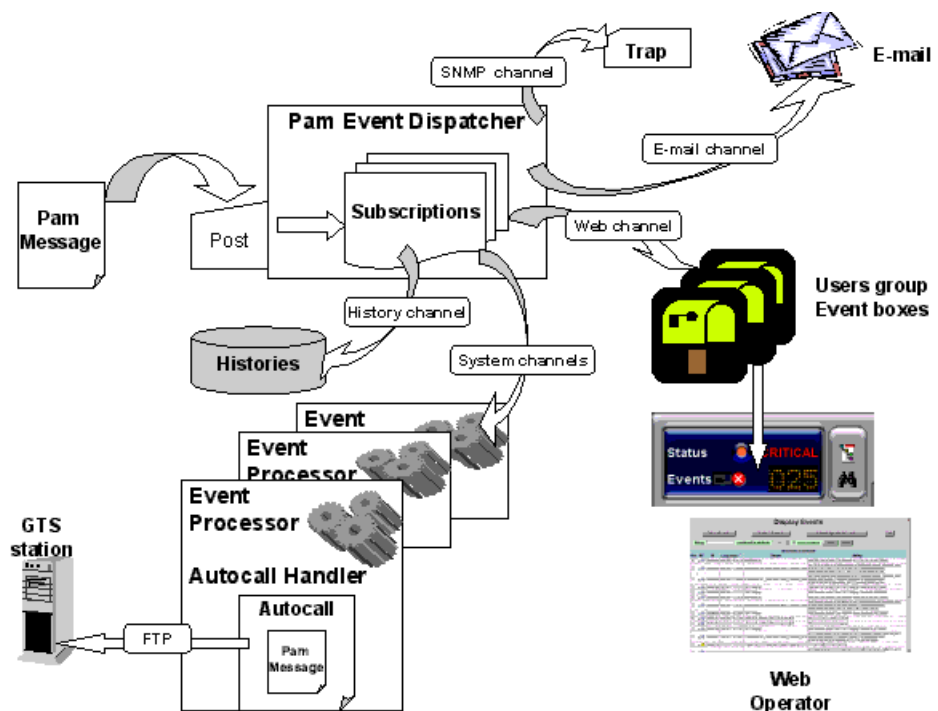

Figure 156. PAM event messaging system features



Note:

PAM software is delivered with a set of predefined subscriptions that have been designed to suit the needs of most Administrators and Operators. If required, you can use PAM **Configuration** tools to set up customized subscriptions.

From the PAM tree, expand the **Configuration Tasks** and **Events** nodes to display event configuration options.

Setting up Event Subscriptions

Before creating an event subscription, you should establish:

- the set of messages you want a user or a group of users to receive (**Filter**),
- how you want the user or group of users to receive messages (**Channel**).

Selecting a Filter

The comprehensive event message filtering system allows you to use a predefined filter or to create a specific filter, according to your needs.

See *Preselecting an Event Filter*, on page 5-109 and *Creating an Event Filter*, on page 5-110.

Selecting a Channel







Four channels can be used to forward event messages, according to targeted recipients:

Channel	Advantage
E-mail	Allows a specific user to receive system notifications/ alerts.
User history	Records specific system operations/alerts into a dedicated log file.
Web	Allows a specific group of users to be warned of system operations/alerts when connected to the PAM Web interface.
SNMP	Forwards specific messages as SNMP traps to the selected SNMP application.

Table 55. Event channels

Event Subscription Flowcharts

Once you have established who the targeted recipients are and which channel you want to use, you can use the following flowcharts as a quick guide to event subscription procedures.

E-mail Event Subscription
Allows a specific user to receive system notifications/alerts via e-mail.
<i>Preselect an Event filter, on page 5-109, or Create an Event Filter, on page 5-110.</i>

Select or <i>Create an E-mail Server</i> , on page 5-88.

Select or <i>Create an E-mail Account</i> , on page 5-90.

<i>Create the Event Subscription</i> , on page 5-97.
User History Event Subscription
Records specific system operations/alerts into a dedicated log file.
<i>Preselect an Event filter, on page 5-109, or Create an Event Filter, on page 5-110.</i>

Select or <i>Create a User History</i> , on page 5-93.

<i>Create the Event Subscription</i> , on page 5-97.
Web Event Subscription
Allows a specific group of users to be warned of system operations/alerts when connected to the PAM Web interface.
<i>Preselect an Event filter, on page 5-109, or Create an Event Filter, on page 5-110.</i>

<i>Create the Event Subscription</i> , on page 5-97.
SNMP Event Subscription
Forwards system operations/alerts as SNMP traps to the selected SNMP Manager.
<i>Preselect an Event filter, on page 5-109, or Create an Event Filter, on page 5-110.</i>

<i>Create the Event Subscription</i> , on page 5-97.

Creating, Editing, Deleting an E-mail Server

To send messages via the e-mail channel, you must first create an e-mail server. Several e-mail accounts can then be attached to the same e-mail server, see *Creating an E-mail Account*, on page 5-90.

Creating an E-mail Server

To create an e-mail server:

1. Click **Configuration Tasks** → **Events** → **E-mail servers** in the PAM tree. The e-mail servers configuration page opens.

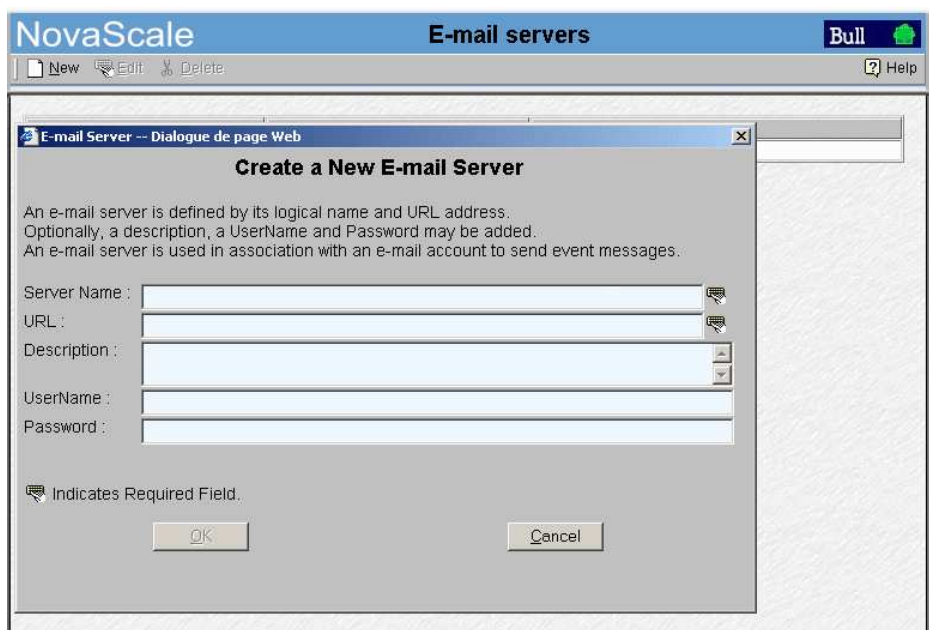

Figure 157. E-mail servers configuration page

2. Click **New** in the toolbar.
3. Enter the server name in the **Name** field, the address of the existing e-mail server you intend to use in the **URL** field, and a brief description, if required, in the **Description** field.
4. Enter a user name and password, if required and click **OK** to confirm the creation of the new e-mail server.



Note:

The **OK** button is accessible once all mandatory fields have been completed.

Editing E-mail Server Attributes

To modify an e-mail server URL / description:

1. Click **Configuration Tasks** → **Events** → **E-mail servers** in the PAM tree. The e-mail server configuration page opens. See Figure 157 above.
2. Select the required server from the e-mail servers list.
3. Click **Edit** in the toolbar to modify the server URL / description.
4. Enter a new address in the **URL** field and/or a new description in the **Description** field, as applicable.
5. Click **OK** to confirm the modification.

Deleting an E-mail Server



Important:

Before deleting an e-mail server, all the accounts attached to that server must be attached to another server, or deleted.

At least one e-mail server must be defined to send messages via the e-mail channel.

If e-mail accounts are attached to this e-mail server:

- see *Editing E-mail Account Attributes*, on page 5-89 to attach these accounts to another server, or
- see *Deleting an E-mail Account*, on page 5-91 to delete these accounts.

To delete an e-mail server:

1. Click **Configuration Tasks** → **Events** → **E-mail Servers** in the PAM tree. The e-mail server configuration page opens. See Figure 157, on page 5-88.
2. Select the required server from the e-mail servers list.
3. Click **Delete** in the toolbar.
4. Click **OK** to confirm the deletion of the selected e-mail server.

Creating, Editing, Deleting an E-mail Account

To send messages via the e-mail channel, you must first create an e-mail server and then attach an e-mail address to this e-mail server. Several e-mail accounts can be attached to the same e-mail server.

Creating an E-mail Account

To create an e-mail account:

1. Click **Configuration Tasks** → **Events** → **E-mail accounts** in the PAM tree. The e-mail accounts configuration page opens.

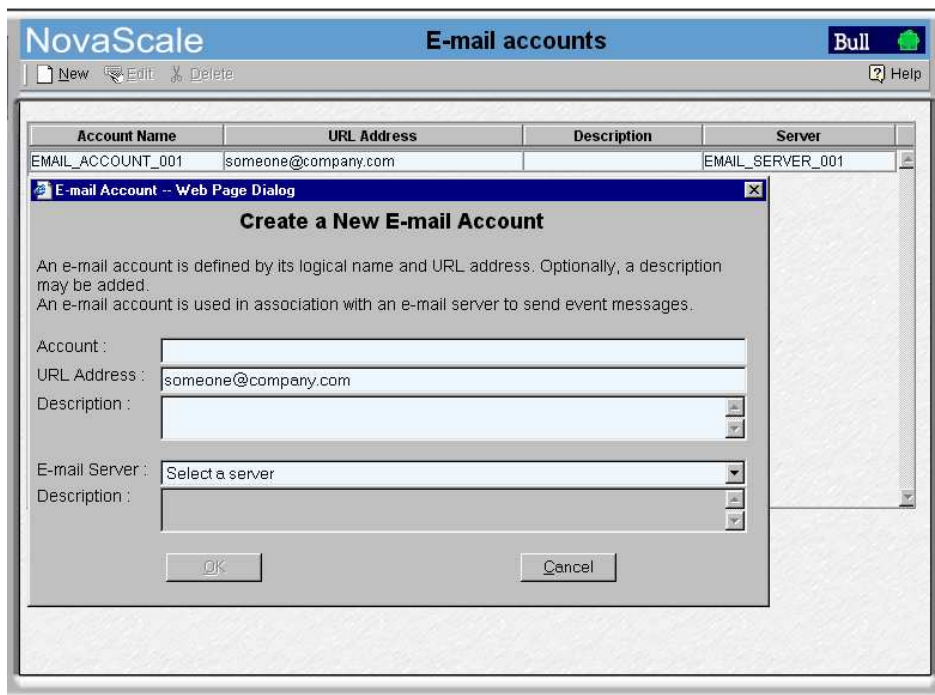

Figure 158. E-mail accounts configuration page

2. Click **New** in the toolbar.
3. Enter the new account name in the **Account** field and corresponding e-mail address in the **URL Address** field.
4. Select the server to be used to deliver messages to this address from the **E-mail Server** list. If the required e-mail server is not in the list, see *Creating an E-mail Server*, on page 5-88.
5. Enter a brief description, if required, in the **Description** field.
6. Click **OK** to confirm the creation of the new e-mail account.

The new e-mail account can now be selected when you set up an event subscription to be sent via the e-mail channel.



Note:

The **OK** button is accessible once all mandatory fields have been completed.

Editing E-mail Account Attributes

To modify an e-mail account name, address, server and/or description:

1. Click **Configuration Tasks** → **Events** → **E-mail accounts** in the PAM tree. The e-mail accounts configuration page opens. See Figure 158 above.
2. Select the required account from the e-mail accounts list.
3. Click **Edit** in the toolbar to modify the account name, address, server and/or description.
4. Enter the new attributes in the corresponding fields, as applicable. If the required e-mail server is not in the list, see *Creating an E-mail Server*, on page 5-88.
5. Click **OK** to confirm the modification.

Deleting an E-mail Account



Important:

Before deleting an e-mail account, all the event subscriptions attached to that account must be attached to another account, or deleted.

If event subscriptions are attached to this e-mail account, see:

- *Editing Event Subscription Attributes*, on page 5-98 to attach these event subscriptions to another account,
- or *Deleting an Event Subscription*, on page 5-98 to delete these event subscriptions.

To delete an e-mail account:

1. Click **Configuration Tasks** → **Events** → **E-mail accounts** in the PAM tree. The e-mail accounts configuration page opens. See Figure 158 above.
2. Select the required account from the e-mail accounts list.
3. Click **Delete** in the toolbar.
4. Click **OK** to confirm the deletion of the selected e-mail account.

Creating, Editing, Deleting a User History

There are two types of histories: System histories and User histories.

System histories cannot be modified and are only accessible to members of the Customer Administrator group.

User histories can be created, edited and deleted and are accessible to members of both the Customer Administrator and Customer Operator groups.

For guidance, System history contents are explained in the following table:

System History Contents

History Name	Contents
HistoryTrace	History Manager trace file. Logs archiving actions and history/archive processing errors.
InterventionReportHistory	Reserved for Support personnel.
IPMITrace	Reserved.
MaestroHistory	Reserved.
MaestroTrace	Reserved for Support personnel.
PAMHistory	Central PAM software history file. Logs all error or information messages concerning PAM software and all operator visible events.
PAMTrace	Logs domain power sequence trace data.
RPCTrace	Reserved for Support personnel.
SANTrace	Logs SAN-IT trace data.

Table 56. System history contents

Creating a User History



Note:

The Site Data Directory will be used, by default, if you do not specify a different directory when you create a user history. See *Viewing PAM Version Information*, on page 4-11

To create a user history:

1. Click **Configuration Tasks** → **Histories** in the PAM tree. The **Histories** control pane opens.
2. Click **New** in the toolbar. The **Create a New User History** dialog opens.

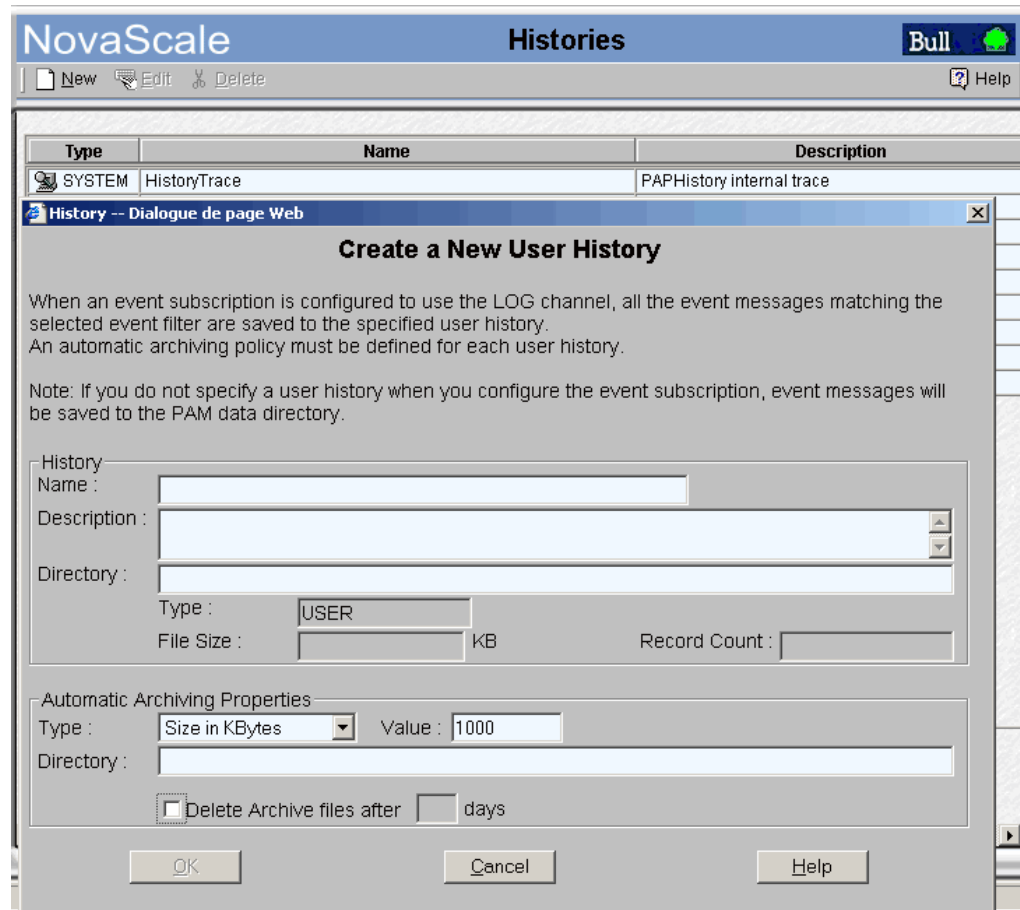

Figure 159. Create a New User History dialog

3. Enter a name in the **Name** field (mandatory) and a brief description, if required, in the **Description** field.
4. Enter a directory pathname in the **Directory** field. If this field is left blank, the default **Histories** directory will be used.

- Use the drop-down menu to select an automatic archiving policy **Type**:

Type	Automatic Archiving Policy
Number of Days	The system will automatically create an archive for this history after the number of days specified in the Value field.
Size in KBytes	The system will automatically create an archive when this history reaches the size in KBytes specified in the Value field. Note: Size in KBytes must be greater than 10.
Number of Records	The system will automatically create an archive when this history reaches the number of records specified in the Value field. Note: Number of Records must be greater than 10.

Table 57. History automatic archiving policies

- Enter the required number of days / KBytes / records in the **Value** field, as applicable.
- Enter a directory pathname in the **Directory** field. If this field is left blank, the default **Archives** directory will be used.
- If you want the archive to be automatically deleted at regular intervals, select the **Delete archive files** checkbox and enter the number of days you want to maintain the archive in the **days** field.
- Click **OK** to confirm the creation of the new history. The new history appears in the list of available histories.



Note:

The **OK** button is accessible once all mandatory fields have been completed.

Editing History Parameters

To modify the archiving parameters of system / user histories:

- Click **Configuration Tasks** → **Histories** in the PAM tree. The **Histories** control pane opens.
- Select the required History from the Histories list.
- Click **Edit** in the toolbar to modify the archiving parameters for this History. The **Edit History Parameters** page opens.
- Enter the new parameters in the corresponding fields.
- Click **OK** to confirm the modification.

Deleting a User History



Important:

Before deleting a user history, all the event subscriptions attached to that history must be attached to another history, or deleted. System histories cannot be deleted.

If event subscriptions are attached to this history:

- see *Editing Event Subscription Attributes*, on page 5-98 to attach these event subscriptions to another history, or
- see *Deleting an Event Subscription*, on page 5-98 to delete these event subscriptions.

To delete a user history:

1. Check that no event subscriptions are attached to this history.
2. Click **Configuration Tasks** → **Histories** in the PAM tree. The **Histories** control pane opens.
3. Select the required History from the Histories list.
4. Click **Delete** in the toolbar.
5. Click **OK** to confirm the deletion of the selected user history.

Enabling / Disabling Event Channels

An event channel must be selected and enabled for all event subscriptions. The following table provides the Customer Administrator with guidelines for selecting an event channel.

Channel	Target	Enabled	Disabled
EMAIL	Specific recipient.	Allows a specific recipient to directly receive specific messages.	Advanced feature: Only to be used if the system generates too many messages and maintenance actions are to be carried out.
LOG (User History)	All user groups.	Allows all users to access specific messages.	
SNMP	SNMP application.	Forwards specific messages as SNMP traps to the selected SNMP application for processing.	
WEB (PAM Interface)	Selected users.	Allows a specific group of users to view specific messages.	

Table 58. Event channel selection guidelines



Note:

When an event channel is disabled, all messages sent via that channel are lost. All event channels are enabled by default.

To enable / disable an event channel:

1. Click **Configuration Tasks** → **Events** → **Channels** in the PAM tree. The channels configuration page opens.

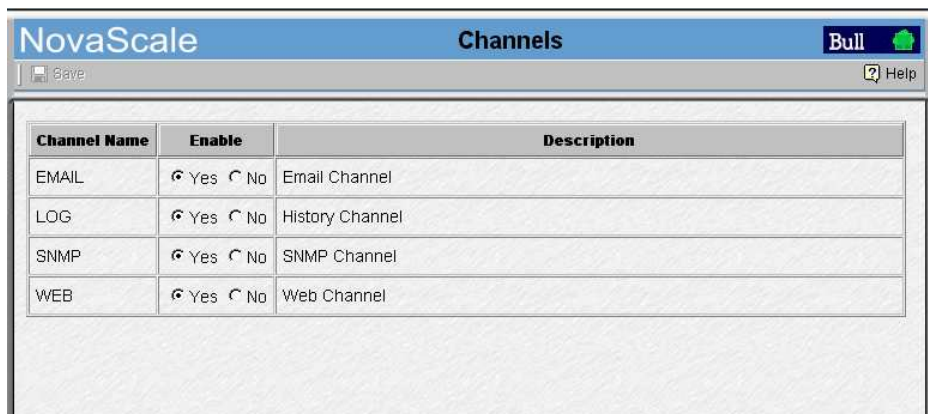

Figure 160. Event Channels configuration page

2. Select the **Yes** or **No** radio button in the **Enable** column to enable or disable the required channel.
3. Click the **Save** icon to confirm the new configuration.

Creating, Editing, Deleting an Event Subscription

Once event subscription prerequisites have been set up, you can create the event subscriptions required to send messages to their destinations. See *Event Subscription Flowcharts*, on page 5-87.

Creating an Event Subscription

To create an event subscription:

1. Click **Configuration Tasks** → **Events** → **Subscriptions** in the PAM tree. The event subscription configuration page opens.
2. Click **New** in the toolbar.

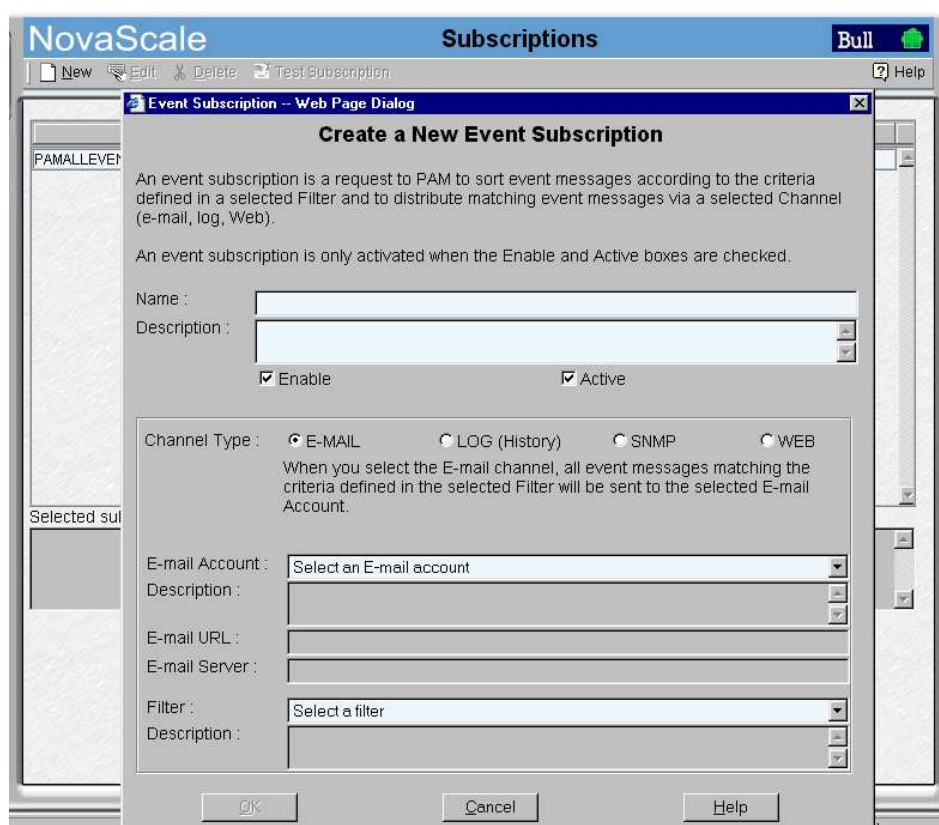

Figure 161. New Event Subscription dialog box

3. Select the **Active** and **Enable** checkboxes to activate and enable the new subscription.
4. Enter a short, readily identifiable name in the **Name** field and a brief description, if required, in the **Description** field.
5. Select the required channel radio button:
 - **E-MAIL**: to send event messages to an e-mail address.
 - **LOG**: to send event messages to a user history.
 - **SNMP**: to send event messages to the SNMP Manager.
 - **WEB**: to send event messages to the status pane in the PAM web interface.
6. Select a pre-configured E-mail Account, User History, or User Group from the drop-down menu or enter an SNMP Manager IP address or server name.
7. Select a pre-configured filter from the **Filter** drop-down menu.

8. Click **OK** to confirm the creation of the new event subscription.
9. The event subscription configuration page is automatically updated with the new subscription.
10. Click **Test Subscription** to check that the event subscription has been configured correctly. Subscription parameters will be used to send a test message.



Note:

The **OK** button is accessible once all mandatory fields have been completed.

Editing Event Subscription Attributes

To modify an event subscription description, channel, address and/or filter, or to activate / deactivate and/or enable / disable an event subscription:

1. Click **Configuration Tasks** → **Events** → **Subscriptions** in the PAM tree. The event subscription configuration page opens.
2. Select the required event subscription in the event subscription table.
3. Click **Edit** to modify the attributes of this event subscription. The **Edit Event Subscription** dialog box opens.
4. Select the new channel, E-mail Account, User History, or User Group from the drop-down menu or enter a new SNMP Manager IP address or server name.
5. Modify the description.
6. If required, activate / deactivate and/or enable / disable the event subscription by selecting / deselecting the **Active** and **Enable** checkboxes.



Warning:

If you deactivate / disable an event subscription, no events will be sent to the recipient(s) until the event subscription is reactivated / re-enabled.

7. Click **OK** to confirm the modification.
8. Click **Test Subscription** to check that the event subscription has been re-configured correctly.



Note:

The **OK** button is accessible once all mandatory fields have been completed.

Deleting an Event Subscription

To delete an event subscription:

1. Click **Configuration Tasks** → **Events** → **Subscriptions** in the PAM tree. The event subscription configuration page opens.
2. Select the required event subscription in the event subscription table.
3. Click **Delete** in the toolbar. The **Delete Subscription** dialog box opens.
4. Click **OK** to confirm the deletion of the selected event subscription.

Understanding Event Message Filtering Criteria

The set of predefined filters supplied with PAM software covers everyday event messaging requirements. However, a comprehensive filtering system allows you to finely tune event messaging criteria, if required.

Before creating a new event filter, you should get to know filtering criteria options.

1. Click **Configuration Tasks** → **Events** → **Filters** in the PAM tree. The filter configuration page opens with the list of existing event message filters.
2. Click **New** to display the **Standard Filter** page.

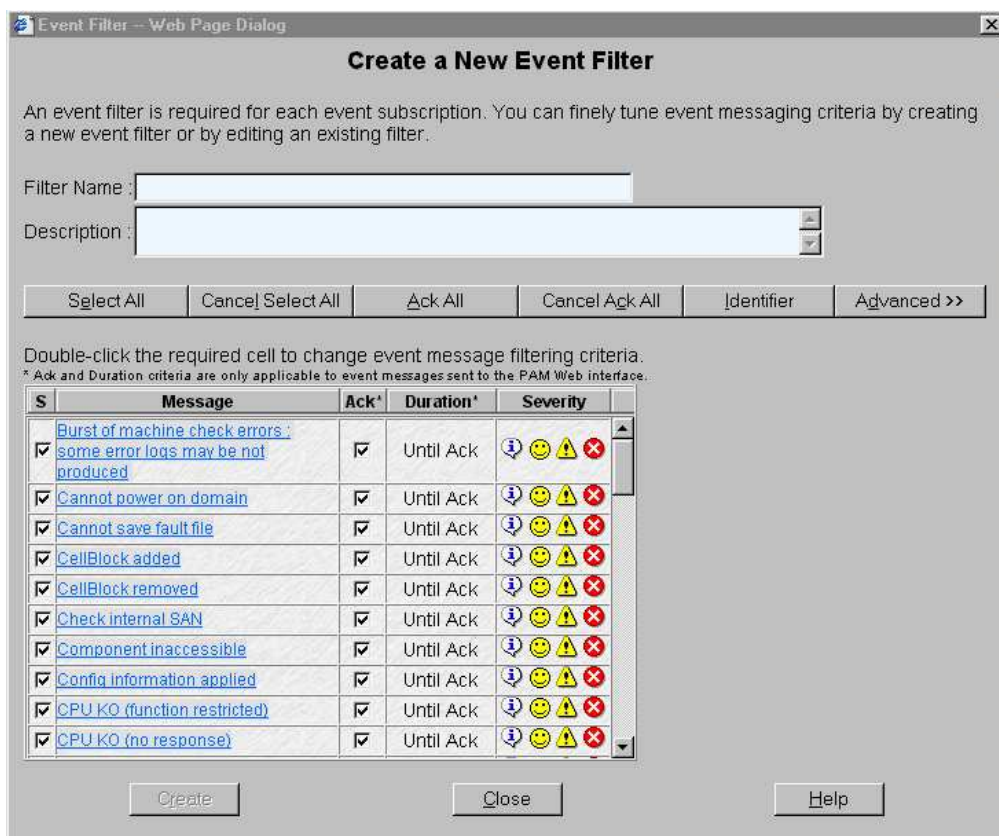

Figure 162. Event message standard filtering criteria chart

3. Click **Advanced** to display the **Advanced Filter** page.

Create a New Event Filter

An event filter is required for each event subscription. You can finely tune event messaging criteria by creating a new event filter or by editing an existing filter.

Filter Name :

Description :

Select All Cancel Select All Ack All Cancel Ack All Message << Standard

Double-click the required cell to change event message filtering criteria.
* Ack and Duration criteria are only applicable to event messages sent to the PAM Web interface.

S	Identifier	Ack'	Duration'	Severity	Threshold	Clipping	Source	Target	Keywords
<input checked="" type="checkbox"/>	2B2B100C	<input checked="" type="checkbox"/>	Until Ack		Inactive	Inactive	All	All	All
<input checked="" type="checkbox"/>	2B2B100F	<input checked="" type="checkbox"/>	Until Ack		Inactive	Inactive	All	All	All
<input checked="" type="checkbox"/>	2B2B1010	<input checked="" type="checkbox"/>	Until Ack		Inactive	Inactive	All	All	All
<input checked="" type="checkbox"/>	2B2B1012	<input checked="" type="checkbox"/>	Until Ack		Inactive	Inactive	All	All	All
<input checked="" type="checkbox"/>	2B2B1013	<input checked="" type="checkbox"/>	Until Ack		Inactive	Inactive	All	All	All
<input checked="" type="checkbox"/>	2B2B1019	<input checked="" type="checkbox"/>	Until Ack		Inactive	Inactive	All	All	All
<input checked="" type="checkbox"/>	2B2B101B	<input checked="" type="checkbox"/>	Until Ack		Inactive	Inactive	All	All	All
<input checked="" type="checkbox"/>	2B2B102A	<input checked="" type="checkbox"/>	Until Ack		Inactive	Inactive	All	All	All
<input checked="" type="checkbox"/>	2B2B102B	<input checked="" type="checkbox"/>	Until Ack		Inactive	Inactive	All	All	All
<input checked="" type="checkbox"/>	2B2B2106	<input checked="" type="checkbox"/>	Until Ack		Inactive	Inactive	All	All	All
<input checked="" type="checkbox"/>	2B2B2211	<input checked="" type="checkbox"/>	Until Ack		Inactive	Inactive	All	All	All

Create Close Help

Figure 163. Event message advanced filtering criteria chart

4. Carefully analyze Tables 59 and 60 to understand the various options.

Standard Event Message Filtering Criteria

Criteria	Description
S (Select)	<p>All the checkboxes in this column are selected by default. When an event message S checkbox is deselected, the event message is removed from the filter.</p> <p>Actions</p> <ul style="list-style-type: none"> – Select the S checkbox if you want to include the event message in the new filter. – Deselect the S checkbox if you do not want to include the event message in the new filter.
Message/Identifier	<p>Gives a message description and provides a clickable link to the associated help messages.</p> <p>Actions</p> <ul style="list-style-type: none"> – Toggle the Message/Identifier column by clicking Message or Identifier in the toolbar. – Double click the required message. The corresponding help message opens.
Ack (Acknowledge)	<p>This column is only applicable to messages sent to the PAM Web interface and is interactive with the Duration column (see below). All the checkboxes in this column are selected by default. When the message Ack checkbox is selected, the event message will be displayed in the event list until it is manually acknowledged by a user.</p> <p>Note: The PAM Web interface stores up to 150 event messages maximum per user group (100 messages by default). Once this limit has been reached, messages may be deleted in order of arrival, even if they have not been acknowledged.</p> <p>Actions</p> <ul style="list-style-type: none"> – Select the Ack checkbox if you want the event message to be displayed until it is manually acknowledged by a user. – Deselect the Ack checkbox if you want the event message to be deleted automatically after a specified period of time. The Duration dialog box opens (see below).

Criteria	Description
<p>Duration</p>	<p>This column is only applicable to messages sent to the PAM Web interface and is interactive with the Ack column (see above). When the specified duration expires, the event message is deleted automatically.</p> <p>Note: The PAM Web interface stores up to 150 event messages maximum per user group (100 by default). Once this limit has been reached, messages may be deleted in order of arrival, even if the set duration has not expired.</p> <div data-bbox="730 577 1211 981" data-label="Image"> </div> <p>Actions</p> <ul style="list-style-type: none"> – Double click the Duration cell to open the Message Display Duration dialog box. – Select the Display message until acknowledged checkbox if you want to manually acknowledge the message before it is removed from the display and click OK to apply. – Enter a value in the Duration field and use the drop-down menu to select the duration unit: seconds, minutes, hours, or days. – The Apply to this message only radio button is selected by default. If required, select another radio button to apply the duration setting to other messages included in the filter. – Click OK to set the duration. The new duration value is displayed in the Duration cell and the Ack checkbox is deselected (see above).

Criteria	Description
Severity Level	<p>This column is used to set message severity level(s): Information, Success, Warning, and Error. At least one severity level must be selected to define the filter.</p> <p>Actions</p> <ul style="list-style-type: none"> - Double click the Severity cell to open the dialog box. <div data-bbox="794 432 1321 855" style="border: 1px solid gray; padding: 5px; margin: 10px 0;"> </div> <ul style="list-style-type: none"> - All severity levels are selected by default. Deselect the required checkbox to remove a severity level from the filter. - Select the Apply to all messages checkbox to apply this severity level to all the messages included in the filter. - Click OK to set and apply the severity level. The new severity level is displayed in the corresponding Severity cell.

Table 59. Standard event message filtering criteria

Advanced Event Message Filtering Criteria



Note:

Advanced filtering criteria are reserved for advanced users and are to be used with care.

Criteria	Description
<p>Thresholding</p>	<p>Thresholding is defined on a Count / Period basis aimed at routing significant messages only. Identical messages are counted and when the number of messages indicated in the Threshold Count field is reached within the period of time indicated in the Threshold Period field, this message is selected for routing.</p> <p>Actions</p> <ul style="list-style-type: none"> - Double click the Threshold cell to open the dialog box. <div data-bbox="711 714 1248 1216" style="border: 1px solid gray; padding: 5px; margin: 10px 0;"> </div> <ul style="list-style-type: none"> - Select the Threshold Inactive radio button to deactivate thresholding. - Select the Apply to all messages checkbox to deactivate the thresholding setting on all the messages included in the filter. - Select the Threshold Active radio button to activate thresholding. - Enter the required number of messages in the Threshold Count field, the required period of time in the Threshold Period field, and use the drop-down menu to select the time unit: seconds, minutes, hours, or days. - Select the corresponding radio button to apply thresholding settings to one or more messages included in the filter. <p>Note: The Apply to this message only radio button is selected by default.</p> <ul style="list-style-type: none"> - Click OK to set thresholding. The new Threshold Count and Threshold Period settings are displayed in the Threshold cell. <p>Note: Inactive is displayed in the Threshold cell when thresholding is deactivated.</p>

Criteria	Description
<p>Clipping</p>	<p>Clipping is defined on a Count / Period basis aimed at routing a pre-defined number of messages only. Identical messages are counted and when the number of messages indicated in the Clipping Count field is reached within the period of time indicated in the Clipping Period field, no other messages will be selected for routing.</p> <p>Actions</p> <ul style="list-style-type: none"> – Double click the Clipping cell to open the dialog box. <div data-bbox="794 488 1316 987" data-label="Image"> </div> <ul style="list-style-type: none"> – Select the Clipping Inactive radio button to deactivate clipping. – Select the Apply to all messages checkbox to deactivate the thresholding setting on all the messages included in the filter. – Select the Clipping Active radio button to activate clipping. – Enter the required number of messages in the Clipping Count field, the required period of time in the Clipping Period field, and use the drop-down menu to select the time unit: seconds, minutes, hours, or days. – Select the corresponding radio button to apply clipping settings to one or more messages included in the filter. <p>Note: The Apply to this message only radio button is checked by default.</p> <ul style="list-style-type: none"> – Click OK to set clipping. The new Clipping Count and Clipping Period settings are displayed in the Clipping cell. <p>Note: Inactive is displayed in the Clipping cell when clipping is deactivated.</p>

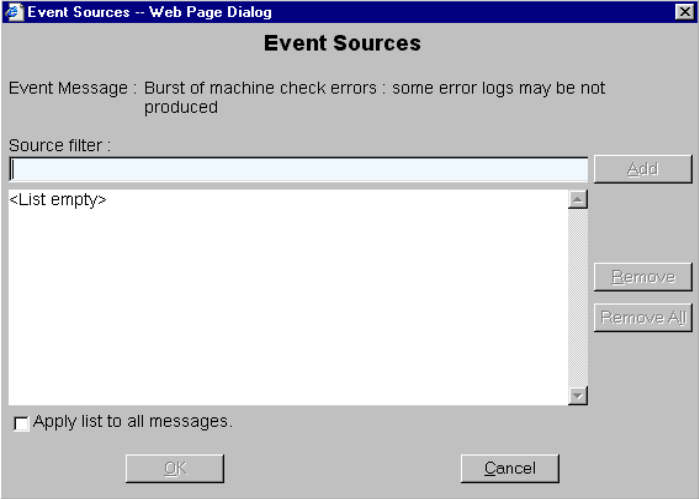
Criteria	Description
<p>Source</p>	<p>Each event message refers to a source (the component that generated the message) and a target (the component referred to in the message) (see below). This feature allows messages to be filtered according to one or more Source string(s) and is particularly useful for debugging and troubleshooting.</p> <p>Actions</p> <ul style="list-style-type: none"> - Double click the Source cell to open the dialog box. - Select a source filter from the Event Sources list. - If the list is empty, enter a source string in the Source filter field and click Add. The new source filter is displayed in the Event Sources list. (Example source strings can be viewed in history files).  <ul style="list-style-type: none"> - Click Remove or Remove All to remove one or more source strings from the Event Sources list. - Repeat for each source string to be included in the filter. - Click Apply list to all messages to apply the specified source list to all the messages included in the filter. - Click OK to apply the source list. Specified is displayed in the Source cell. <p>Note: All is displayed in the Source cell if the source is not specified.</p>

Criteria	Description
Target	<p>Each event message refers to a target (the component referred to in the message) and a source (the component that generated the message) (see above). This feature allows messages to be filtered according to one or more Target string(s) and is particularly useful for debugging and troubleshooting.</p> <p>Actions</p> <ul style="list-style-type: none"> - Double click the Target cell to open the dialog box. - Select a target filter from the Event Targets list. - If the list is empty, enter a target string in the Target filter field and click Add. The new target filter is displayed in the Event Targets list. (Example target strings can be viewed in history files). <div data-bbox="724 685 1406 1182" style="border: 1px solid gray; padding: 5px; margin: 10px 0;"> </div> <ul style="list-style-type: none"> - Click Remove or Remove All to remove one or more target strings from the Event Targets list. - Repeat for each target string to be included in the filter. - Click Apply list to all messages to apply the specified target list to all the messages included in the filter. - Click OK to apply the target list. Specified is displayed in the Target cell. <p>Note: All is displayed in the Target cell if the target is not specified.</p>

Criteria	Description
Keyword	<p>This feature allows messages to be filtered according to a Keyword contained in the messages. Any relevant word(s) contained in source / target strings can be used.</p> <p>Actions</p> <ul style="list-style-type: none"> - Double click the Keywords cell to open the dialog box. - Select a keyword filter from the Event Keywords list. - If the list is empty, enter a keyword in the Keyword filter field and click Add. The new keyword filter is displayed in the Event Keywords list. (Example keywords can be viewed in history files). <div data-bbox="639 622 1321 1122" style="border: 1px solid gray; padding: 5px; margin: 10px 0;"> </div> <ul style="list-style-type: none"> - Click Remove or Remove All to remove one or more keyword from the Event Keywords list. - Repeat for each keyword to be included in the filter. - Click Apply list to all messages to apply the specified keyword list to all the messages included in the filter. - Click OK to apply the keyword list. Specified is displayed in the Keyword cell. <p>Note: All is displayed in the Keywords cell if the keyword is not specified.</p>

Table 60. Advanced event message filtering criteria

Preselecting, Creating, Editing, Deleting an Event Filter

An event filter must be selected for all event subscriptions. The event messaging system is delivered with a set of predefined filters.

Preselecting an Event Filter

Before proceeding to set up an event subscription, you are advised to check which predefined filter is adapted to your needs:

1. Click **Configuration Tasks** → **Events** → **Filters** in the PAM tree. The filter configuration page opens.

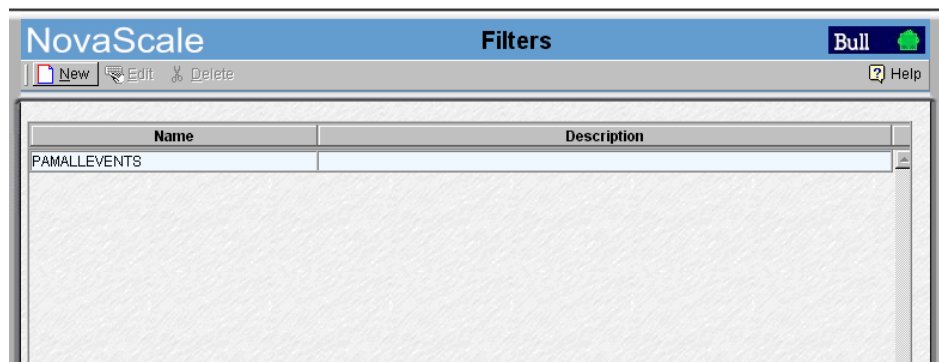

Figure 164. Filters configuration page

2. Check that the required filter is present.

You may also define a specific filter by using the comprehensive event message filtering utility. See *Creating an Event Filter*, on page 5-110.

Creating an Event Filter

Once you have established which filtering criteria you want to apply to your new filter, you can proceed to create a new event filter:

1. Click **Configuration Tasks** → **Events** → **Filters** in the PAM tree. The filter configuration page opens with the list of existing event message filters.
2. Click **New** to display the **Create a New Event Filter** page. The standard event message filtering criteria table is displayed.

Create a New Event Filter

An event filter is required for each event subscription. You can finely tune event messaging criteria by creating a new event filter or by editing an existing filter.

Filter Name:

Description:

Select All Cancel Select All Ack All Cancel Ack All Identifier Advanced >>

Double-click the required cell to change event message filtering criteria.
* Ack and Duration criteria are only applicable to event messages sent to the PAM Web interface.

S	Message	Ack*	Duration*	Severity
<input checked="" type="checkbox"/>	Burst of machine check errors: some error logs may be not produced	<input checked="" type="checkbox"/>	Until Ack	
<input checked="" type="checkbox"/>	Cannot power on domain	<input checked="" type="checkbox"/>	Until Ack	
<input checked="" type="checkbox"/>	Cannot save fault file	<input checked="" type="checkbox"/>	Until Ack	
<input checked="" type="checkbox"/>	CellBlock added	<input checked="" type="checkbox"/>	Until Ack	
<input checked="" type="checkbox"/>	CellBlock removed	<input checked="" type="checkbox"/>	Until Ack	
<input checked="" type="checkbox"/>	Check internal SAN	<input checked="" type="checkbox"/>	Until Ack	
<input checked="" type="checkbox"/>	Component inaccessible	<input checked="" type="checkbox"/>	Until Ack	
<input checked="" type="checkbox"/>	Config information applied	<input checked="" type="checkbox"/>	Until Ack	
<input checked="" type="checkbox"/>	CPU KO (function restricted)	<input checked="" type="checkbox"/>	Until Ack	
<input checked="" type="checkbox"/>	CPU KO (no response)	<input checked="" type="checkbox"/>	Until Ack	

Create Close Help

Figure 165. New Filter configuration page – standard event message filtering criteria table

3. Enter a relevant name in the **Filter Name** field and a brief description, if required, in the **Description** field.



Note:

For further details about event filtering criteria and options, see *Standard Event Filtering Criteria*, on page 5-101 and *Advanced Event Filtering Criteria*, on page 5-104.

4. Deselect the **S** checkbox for the event messages not to be included in the filter.
5. If the filter is to be used to send messages to the PAM Web interface, select the **Ack** checkbox if you want the event message to be manually acknowledged by a user; or deselect the **Ack** checkbox to enter a display value in the **Duration** cell.
6. Double click the **Severity** cell to select the message severity level.

7. If required, click **Advanced** to access advanced filtering criteria. The advanced event message filtering criteria chart is displayed.

Create a New Event Filter

An event filter is required for each event subscription. You can finely tune event messaging criteria by creating a new event filter or by editing an existing filter.

Filter Name :

Description :

Select All | Cancel Select All | Ack All | Cancel Ack All | Message | << Standard

Double-click the required cell to change event message filtering criteria.
* Ack and Duration criteria are only applicable to event messages sent to the PAM Web interface.

S	Identifier	Ack*	Duration*	Severity	Threshold	Clipping	Source	Target	Keywords
<input checked="" type="checkbox"/>	2B2B100C	<input checked="" type="checkbox"/>	Until Ack		Inactive	Inactive	All	All	All
<input checked="" type="checkbox"/>	2B2B100E	<input checked="" type="checkbox"/>	Until Ack		Inactive	Inactive	All	All	All
<input checked="" type="checkbox"/>	2B2B1010	<input checked="" type="checkbox"/>	Until Ack		Inactive	Inactive	All	All	All
<input checked="" type="checkbox"/>	2B2B1012	<input checked="" type="checkbox"/>	Until Ack		Inactive	Inactive	All	All	All
<input checked="" type="checkbox"/>	2B2B1013	<input checked="" type="checkbox"/>	Until Ack		Inactive	Inactive	All	All	All
<input checked="" type="checkbox"/>	2B2B1019	<input checked="" type="checkbox"/>	Until Ack		Inactive	Inactive	All	All	All
<input checked="" type="checkbox"/>	2B2B101B	<input checked="" type="checkbox"/>	Until Ack		Inactive	Inactive	All	All	All
<input checked="" type="checkbox"/>	2B2B102A	<input checked="" type="checkbox"/>	Until Ack		Inactive	Inactive	All	All	All
<input checked="" type="checkbox"/>	2B2B102B	<input checked="" type="checkbox"/>	Until Ack		Inactive	Inactive	All	All	All
<input checked="" type="checkbox"/>	2B2B2106	<input checked="" type="checkbox"/>	Until Ack		Inactive	Inactive	All	All	All
<input checked="" type="checkbox"/>	2B2B2211	<input checked="" type="checkbox"/>	Until Ack		Inactive	Inactive	All	All	All

Create | Close | Help

Figure 166. New Filter configuration page – advanced event message filtering criteria table

8. When you have finished configuring your event filter, click **Create**.
9. Repeat steps 3 to 8 for each new event filter you want to create.
10. Click **Close** to save changes. The new filter appears in the **Filters** list.

Editing Event Filter Attributes

1. Click **Configuration Tasks** → **Events** → **Filters** in the PAM tree. The filter configuration page opens with the list of existing event message filters. See Figure 165 above.
2. Select the required filter from the event message filter list.
3. Click **Edit** in the toolbar to modify filter attributes.
4. Click **OK** to save changes.

Deleting an Event Filter



Important:

Before deleting an event filter, all the event subscriptions using that filter must either be modified to use another filter, or deleted.

1. Click **Configuration Tasks** → **Events** → **Filters** in the PAM tree. The filter configuration page opens with the list of existing event message filters. See Figure 164 above.
2. Select the required filter from the event message filter list.
3. Click **Delete** in the toolbar.
4. Click **OK** to confirm the deletion of the selected event filter.

Appendix A. Specifications

- NovaScale 5080/5160 Server Specifications, on page A-1
- NovaScale 6080/6160 Server Specifications, on page A-3
- NovaScale 6320 Server Specifications, on page A-5

NovaScale 5080/5160 Server Specifications

The following web site may be consulted for general site preparation information:
<http://www.cs.bull.net/aise>

Dimensions / Weight	
Unpacked	Packed
Height: 177.5 cm (70 in) Width: 65.0 cm (25.6 in) Depth: 113 cm (44.5 in) Weight: 510 kg (1122 lb)	Height: 202 cm (79.5 in) Width: 80.0 cm (31.5 in) Depth: 127.5 cm (50.2 in) Weight: 550 kg (1210 lb)
Service Clearance	
Front	150 cm
Rear	100 cm
Side (left and right)	100 cm
Operating Limits	
Dry bulb temperature range	+15°C to +30°C (+59°F to +86°F) Gradient 5°C/h (41°F/h)
Relative humidity (non-condensing)	35 to 60% (Gradient 5%/h)
Max. wet bulb temperature	+24°C (+75.2°F)
Moisture content	0.019 kg water/kg dry air
Pressure / Elevation	Sea level ≤ 2500 m
Optimum Operational Reliability	
Temperature	+ 22°C (± 3°C) (+ 72°F (± 5°F)
Hygrometry	50% (± 5%)
Non-Operating Limits	
Dry bulb temperature range	+5°C to +50°C (+41°F to +122°F) Gradient 25°C/h (77°F/h)
Relative humidity (non-condensing)	5 to 95% (Gradient 30%)
Max. wet bulb temperature	+28°C (+75°F)
Moisture content	0.024 kg water/kg dry air
Shipping Limits	
Dry bulb temperature range	-35°C to +65°C (-31°F to +149°F) Gradient 25°C/h (77°F/h)
Relative humidity (non-condensing)	5 to 95% Gradient 30%/h

Acoustic Power at Room Temperature +20° C (+68° F)	
System Running	System Idle
Lw(A) 6.3 Bels	Lw(A) 6.1 Bels
Power Cables	
AC (20A)	2 per cabinet
Cable type	3 x 4mm ² / AWG # 12 (US)
Connector type	C22 Appliance Coupler
It is mandatory for power lines and terminal boxes to be located within the immediate vicinity of the system and to be easily accessible. Each power line must be connected to a separate, independent electrical panel and bipolar circuit breaker. The PDU requires an extra cable length of 1.5 meters for connection inside the cabinet.	
Electrical Specifications (power supplies are auto-sensing and auto-ranging)	
Current draw	29.5 A max. at 200 VAC input
Power consumption	3000 VA per full CSS module) 1500 VA (per PDU)
Thermal dissipation	2700 W / 9250 BTU (per full CSS module) 1300 W / 4610 BTU (per PDU)
Europe	
Nominal voltage	230 VAC (Phase / Neutral)
Voltage range	207 – 244 VAC
Frequency	50 Hz ± 1%
United States of America	
Nominal voltage	208 VAC (Phase / Neutral)
Voltage range	182 – 229 VAC
Frequency	60 Hz ± 0.3%
Japan	
Nominal voltage	200 VAC (Phase / Neutral)
Voltage range	188 – 212 VAC
Frequency	60 Hz ± 0.2%
Brazil	
Nominal voltage	220 VAC (Phase / Neutral)
Voltage range	212 – 231 VAC
Frequency	60 Hz ± 2%
Breaker Protection	
Mains power CSS module	20A Curve C
Maximum inrush current	210A / per quarter period
Mains power PDU	20A Curve C
Maximum inrush current	210A / per quarter period

Table 61. NovaScale 5080/5160 Server specifications

NovaScale 6080/6160 Server Specifications

The following web site may be consulted for general site preparation information:
<http://www.cs.bull.net/aise>

Dimensions / Weight	
Unpacked	Packed
Height: 177.5 cm (70 in) Width: 65.0 cm (25.6 in) Depth: 113 cm (44.5 in) Weight: 510 kg (1122 lb)	Height: 202 cm (79.5 in) Width: 80.0 cm (31.5 in) Depth: 127.5 cm (50.2 in) Weight: 550 kg (1210 lb)
Service Clearance	
Front Rear Side (left and right)	150 cm 100 cm 100 cm
Operating Limits	
Dry bulb temperature range Relative humidity (non-condensing) Max. wet bulb temperature Moisture content Pressure / Elevation	+15°C to +30°C (+59°F to +86°F) Gradient 5°C/h (41°F/h) 35 to 60% (Gradient 5%/h) +24°C (+75.2°F) 0.019 kg water/kg dry air Sea level ≤ 2500 m
Optimum Operational Reliability	
Temperature Hygrometry	+ 22°C (± 3°C) (+ 72°F (± 5°F) 50% (± 5%)
Non-Operating Limits	
Dry bulb temperature range Relative humidity (non-condensing) Max. wet bulb temperature Moisture content	+5°C to +50°C (+41°F to +122°F) Gradient 25°C/h (77°F/h) 5 to 95% (Gradient 30%) +28°C (+75°F) 0.024 kg water/kg dry air
Shipping Limits	
Dry bulb temperature range Relative humidity (non-condensing)	-35°C to +65°C (-31°F to +149°F) Gradient 25°C/h (77°F/h) 5 to 95% Gradient 30%/h
Acoustic Power at Room Temperature +20° C (+68° F)	
System Running	System Idle
Lw(A) 6.3 Bels	Lw(A) 6.1 Bels

Power Cables	
AC (20A)	2 per cabinet
Cable type	3 x 4mm ² / AWG # 12 (US)
Connector type	C22 Appliance Coupler
<p>It is mandatory for power lines and terminal boxes to be located within the immediate vicinity of the system and to be easily accessible. Each power line must be connected to a separate, independent electrical panel and bipolar circuit breaker. The PDU requires an extra cable length of 1.5 meters for connection inside the cabinet.</p>	
Electrical Specifications (power supplies are auto-sensing and auto-ranging)	
Current draw	29.5 A max. at 200 VAC input
Power consumption	3000 VA per full CSS module) 1500 VA (per PDU)
Thermal dissipation	2700 W / 9250 BTU (per full CSS module) 1300 W / 4610 BTU (per PDU)
Europe	
Nominal voltage	230 VAC (Phase / Neutral)
Voltage range	207 – 244 VAC
Frequency	50 Hz ± 1%
United States of America	
Nominal voltage	208 VAC (Phase / Neutral)
Voltage range	182 – 229 VAC
Frequency	60 Hz ± 0.3%
Japan	
Nominal voltage	200 VAC (Phase / Neutral)
Voltage range	188 – 212 VAC
Frequency	60 Hz ± 0.2%
Brazil	
Nominal voltage	220 VAC (Phase / Neutral)
Voltage range	212 – 231 VAC
Frequency	60 Hz ± 2%
Breaker Protection	
Mains power CSS module	20A Curve C
Maximum inrush current	210A / per quarter period
Mains power PDU	20A Curve C
Maximum inrush current	210A / per quarter period

Table 62. NovaScale 6080/6160 Server specifications

NovaScale 6320 Server Specifications

The following web site may be consulted for general site preparation information:
<http://www.cs.bull.net/aise>

Dimensions / Weight	
Unpacked	Packed
Height: 177.5 cm (70 in) Width: 65.0 cm (25.6 in) Depth: 113 cm (44.5 in) Weight: Main cabinet: 590 kg (1300 lb) I/O cabinet: 300 kg (661 lb)	Height: 202 cm (79.5 in) Width: 80.0 cm (31.5 in) Depth: 127.5 cm (50.2 in) Weight: Main cabinet: 630 kg (1390 lb) I/O cabinet: 340 kg (750 lb)
Service Clearance	
Front	150 cm
Rear	100 cm
Side (free side)	100 cm
Operating Limits	
Dry bulb temperature range	+15°C to +30°C (+59°F to +86°F) Gradient 5°C/h (41°F/h)
Relative humidity (non-condensing)	35 to 60% (Gradient 5%/h)
Max. wet bulb temperature	+24°C (+75.2°F)
Moisture content	0.019 kg water/kg dry air
Pressure / Elevation	Sea level ≤ 2500 m
Optimum Operational Reliability	
Temperature	+ 22°C (± 3°C) (+ 72°F (± 5°F)
Hygrometry	50% (± 5%)
Non-Operating Limits	
Dry bulb temperature range	+5°C to +50°C (+41°F to +122°F) Gradient 25°C/h (77°F/h)
Relative humidity (non-condensing)	5 to 95% (Gradient 30%)
Max. wet bulb temperature	+28°C (+75°F)
Moisture content	0.024 kg water/kg dry air
Shipping Limits	
Dry bulb temperature range	-35°C to +65°C (-31°F to +149°F) Gradient 25°C/h (77°F/h)
Relative humidity (non-condensing)	5 to 95% Gradient 30%/h
Acoustic Power at Room Temperature +20° C (+68° F)	
System Running	System Idle
Lw(A) 6.3 Bels	Lw(A) 6.1 Bels

Power Cables	
AC (20A)	Main cabinet: 2 (1 per CSS module) I/O cabinet: 1 per PDU
Cable type	3 x 4mm ² / AWG # 12 (US)
Connector type	C22 Appliance Coupler
<p>It is mandatory for power lines and terminal boxes to be located within the immediate vicinity of the system and to be easily accessible. Each power line must be connected to a separate, independent electrical panel and bipolar circuit breaker. The PDU requires an extra cable length of 1.5 meters for connection inside the cabinet.</p>	
Electrical Specifications (power supplies are auto-sensing and auto-ranging)	
Current draw	29.5 A max. at 200 VAC input
Power consumption	3000 VA per full CSS module) 1500 VA (per PDU)
Thermal dissipation	2700 W / 9250 BTU (per full CSS module) 1300 W / 4610 BTU (per PDU)
Europe	
Nominal voltage	230 VAC (Phase / Neutral)
Voltage range	207 – 244 VAC
Frequency	50 Hz ± 1%
United States of America	
Nominal voltage	208 VAC (Phase / Neutral)
Voltage range	182 – 229 VAC
Frequency	60 Hz ± 0.3%
Japan	
Nominal voltage	200 VAC (Phase / Neutral)
Voltage range	188 – 212 VAC
Frequency	60 Hz ± 0.2%
Brazil	
Nominal voltage	220 VAC (Phase / Neutral)
Voltage range	212 – 231 VAC
Frequency	60 Hz ± 2%
Breaker Protection	
Mains power CSS module	20A Curve C
Maximum inrush current	210A / per quarter period
Mains power PDU	20A Curve C
Maximum inrush current	210A / per quarter period

Table 63. NovaScale 6320 Server specifications

Appendix B. Cabling Diagrams

This appendix contains illustrations to supplement server cabling procedures. It includes the following sections:

- Section I – NovaScale 5080/5160 Servers Cabling Diagrams, on page B-2
- Section II – NovaScale 6080/6160 Server Cabling Diagrams, on page B-19
- Section III – NovaScale 6320 Server Cabling Diagrams, on page B-36

Section I – NovaScale 5080/5160 Server Cabling Diagrams

- ▶ Console Data Cables, on page B-3
- ▶ KVM Switch, on page B-4
- ▶ IOR, on page B-6
- ▶ PAP Unit, on page B-8
- ▶ Disk Rack (SJ-0812 SCSI JBOD), on page B-10
- ▶ Disk Rack (SR-0812 SCSI RAID), on page B-11
- ▶ Disk Rack (FDA 1x00 FC), on page B-12
- ▶ Extension Disk Rack (FDA 1x00 FC – FDA 1x00 FC), on page B-13
- ▶ PMB Data Cables, on page B-14
- ▶ Ethernet Hub Data Cables, on page B-15
- ▶ Modem Cables, on page B-16
- ▶ Power Cables (PDU), on page B-17

Integrated Console

Slideaway Console

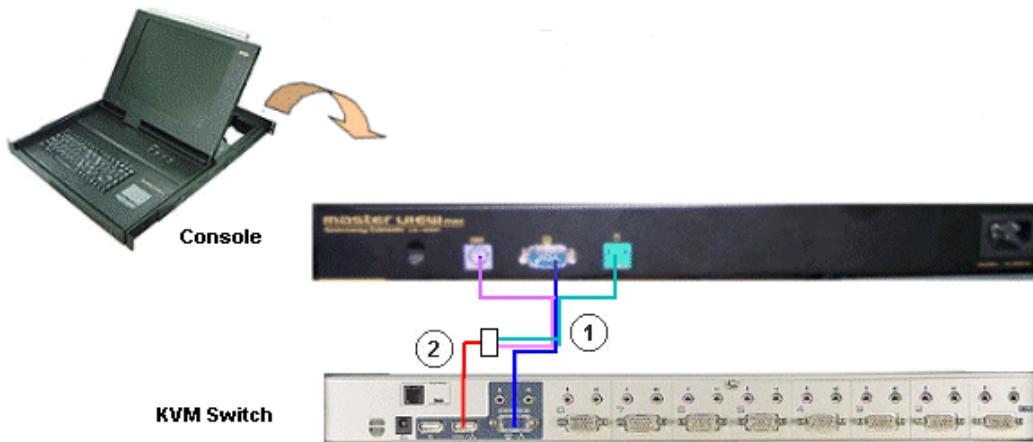

Mark	Cable Type	From	To
1	video/PS2/PS2 cable	Console (video)	KVM switch (video)
2	PS2/USB converter	Console (PS2/PS2)	KVM switch (USB)

Figure 167. Slideaway console data cabling diagram

Console Drawer

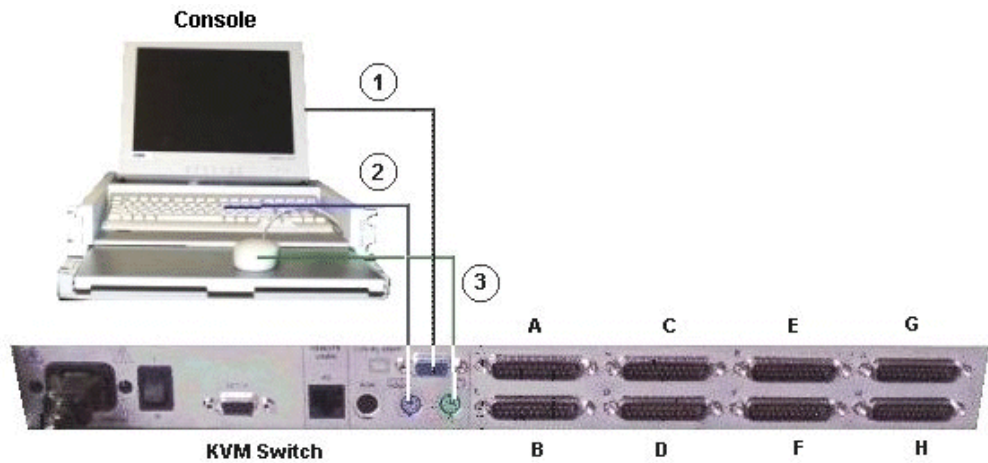

Mark	Cable Type	From	To
1	HD15 video cable	Monitor (blue)	KVM switch (blue)
2	PS2 mini-DIN6 cable + PS2/PS2 extension cable	Keyboard (mauve)	KVM switch (mauve)
3	PS2 mini-DIN6 cable + PS2/PS2 extension cable	Mouse (green)	KVM switch (green)

Figure 168. Console drawer data cabling diagram

KVM Switch

Aten 8-Port KVM Switch

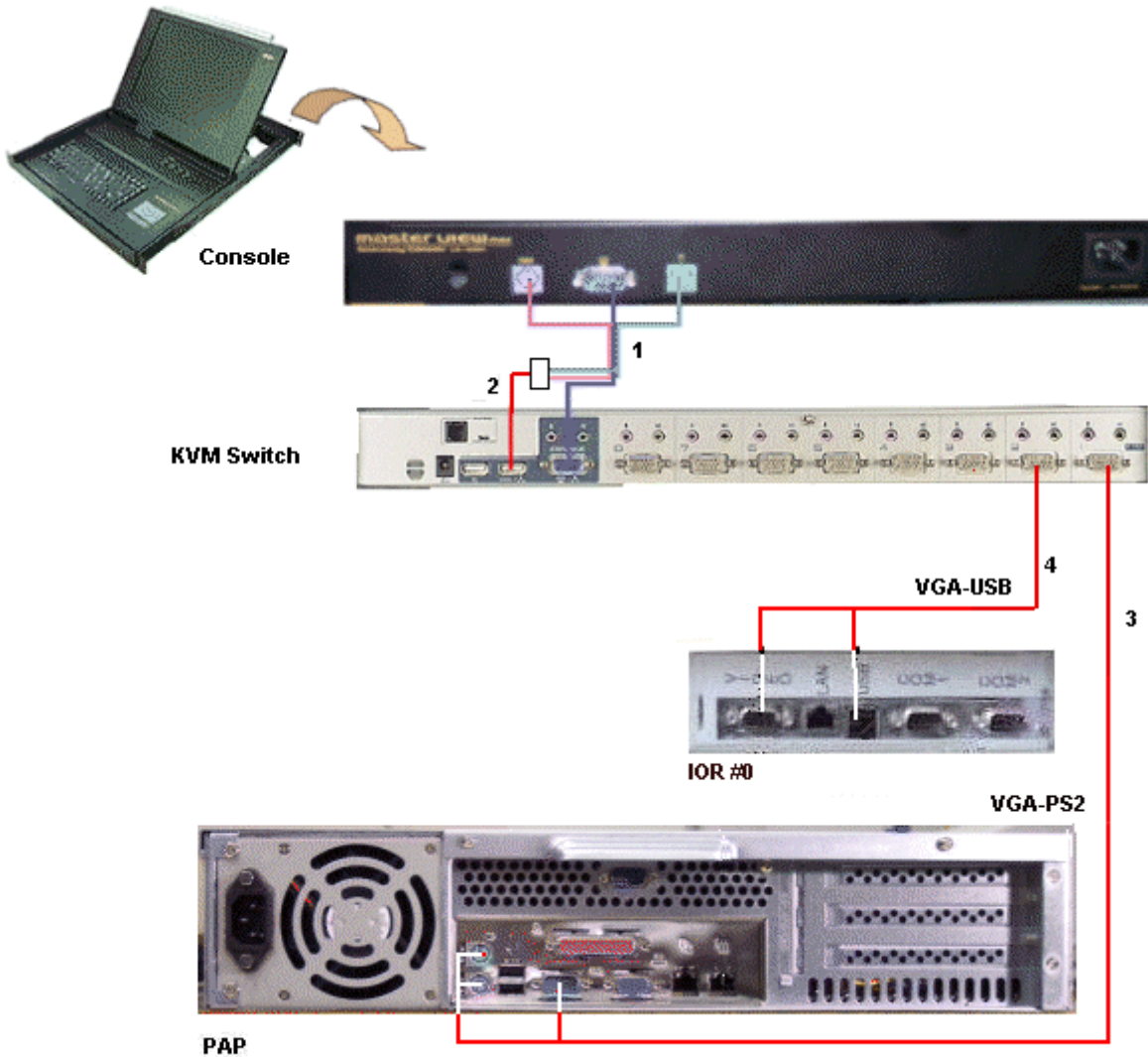

Mark	Cable Type	From	To
1	Video/PS2/PS2 cable	Console (video)	KVM switch (video)
2	PS2/USB converter	Console (PS2/PS2)	KVM switch (USB)
3	Combined PS2/VGA cable	KVM Port 1	PAP (VGA/PS2)
4	Combined USB/VGA cable	KVM Port 2	IOR (IOB0) (Video/USB)

Figure 169. 8-port KVM switch data cabling diagram (example 1)

Avocent 8-Port KVM Switch

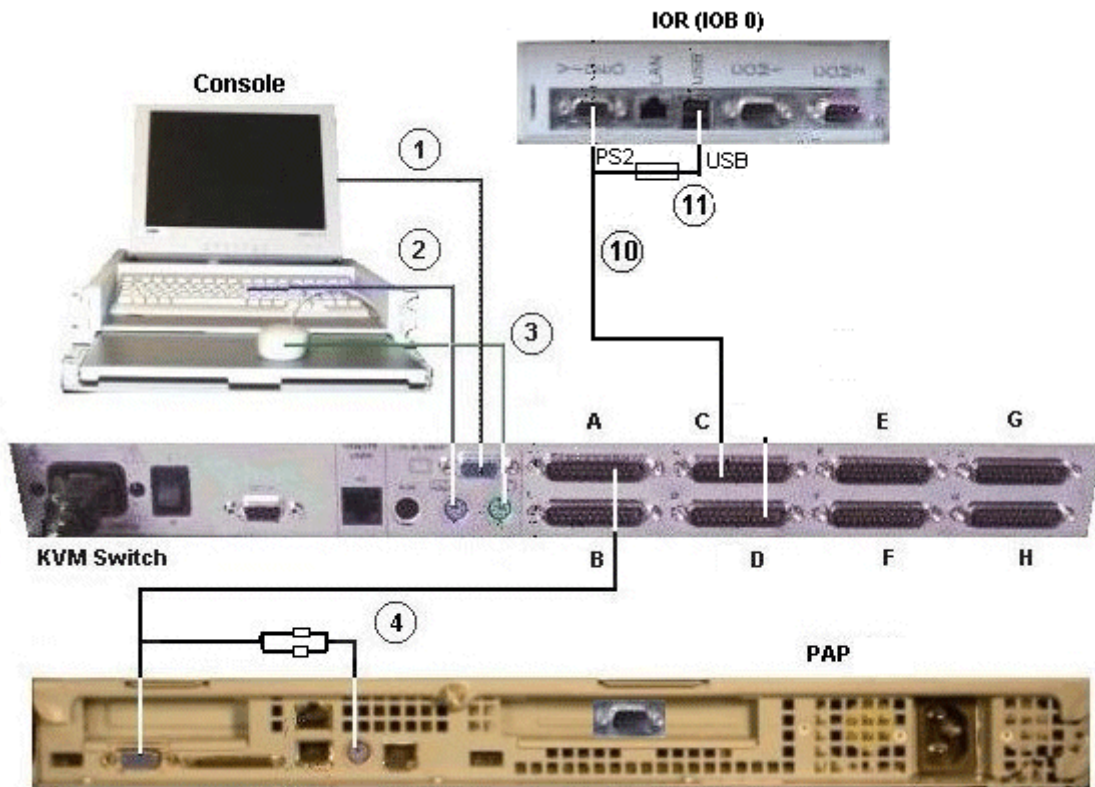

Mark	Cable Type	From	To
1	HD15 video cable	Monitor (blue)	KVM (blue)
2	PS2 mini-DIN6 cable + PS2/PS2 extension cable	Keyboard (mauve)	KVM (mauve)
3	PS2 mini-DIN6 cable + PS2/PS2 extension cable	Mouse (green)	KVM (green)
4	Combined PS2/VGA cable	KVM Port A	PAP VGA/PS2
10	Combined USB/VGA cable (Windows)	KVM Port C/D	IOR Video/USB
	Combined PS2/VGA cable (Linux)	KVM Port C/D	IOR (Video)
11	USB/PS2 converter (Linux)	PS2 cable (mark 10)	IOR (USB)

Figure 170. 8-port KVM switch data cabling diagram (example 2)

IOR

IOR – 2U PAP Unit – Aten 8-Port KVM Switch

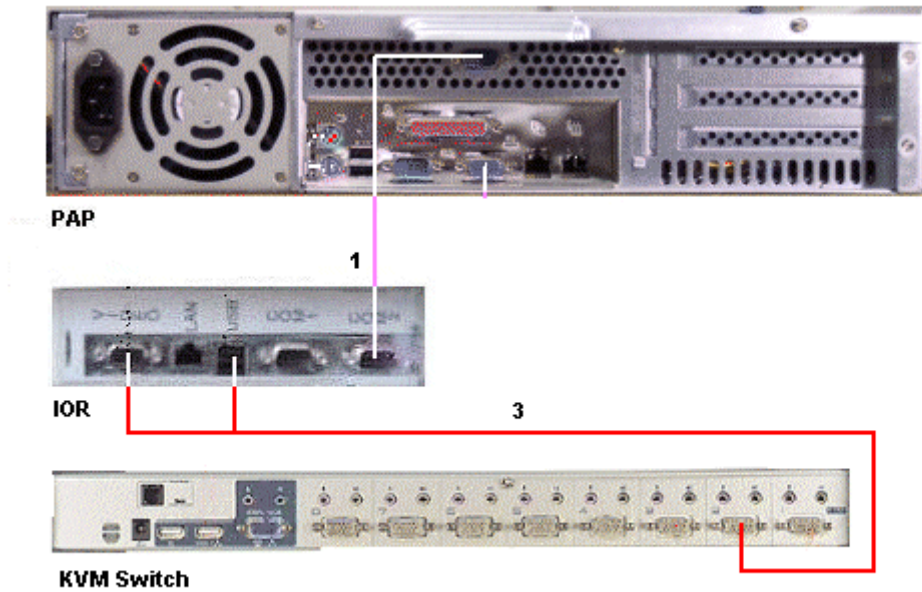

Mark	Cable Type	From	To
1	DB9 to DB9 cross cable	PAP COM 2	IOR
3	Combined USB/VGA cable	KVM Port 2	IOR Video/USB

Figure 171. IOR data cabling diagram (example 1)

IOR – 1U PAP Unit – Avocent 8-Port KVM Switch

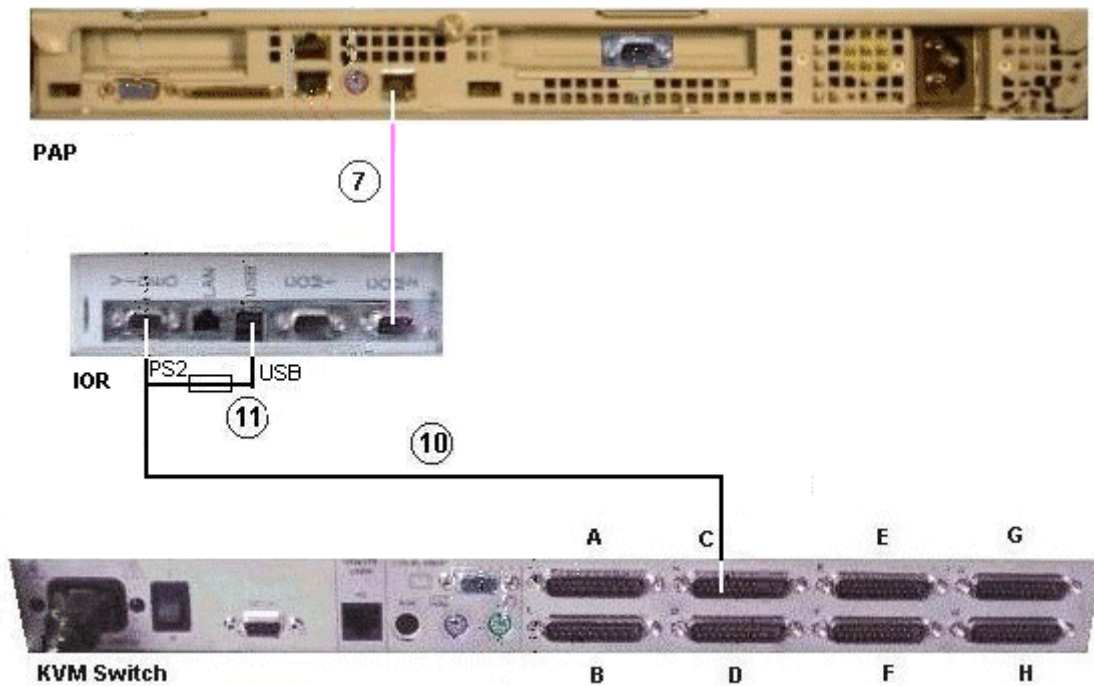

Mark	Cable Type	From	To
7	RJ45/DB9 to DB9 cross cable	PAP COM 2	IOR
10	Combined USB/VGA cable (Windows)	KVM Port C/D	IOR Video/USB
	Combined PS2/VGA cable (Linux)	KVM Port C/D	IOR (Video)
11	USB/PS2 converter (Linux)	PS2 cable (mark 10)	IOR (USB)

Figure 172. IOR data cabling diagram (example 2)

PAP Unit

2U PAP Unit

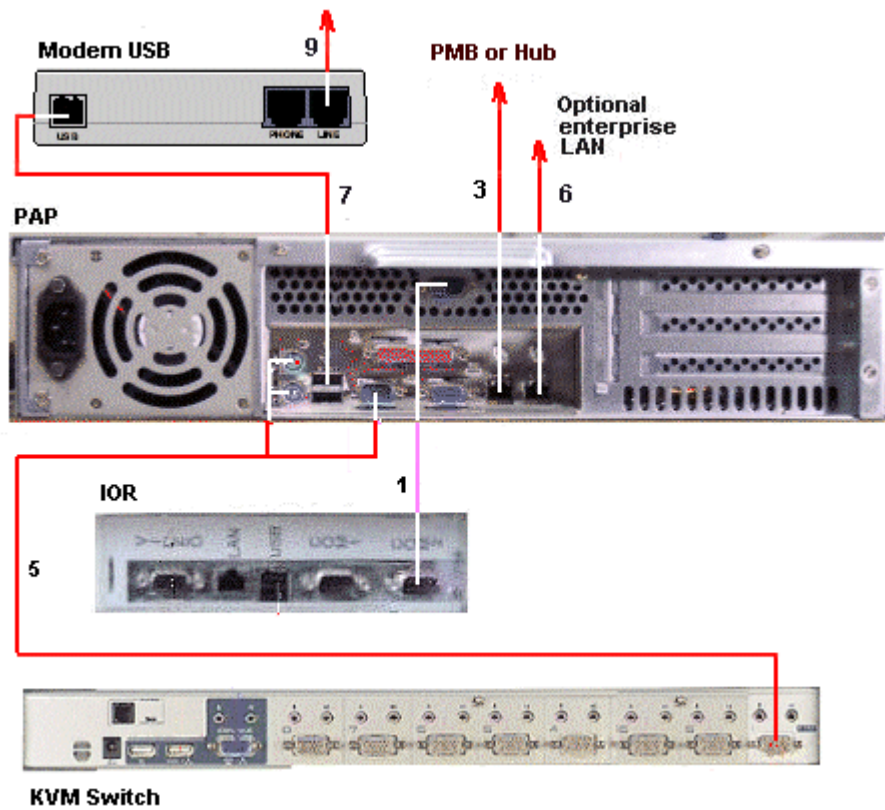

Mark	Cable Type	From	To
1	DB9 to DB9 cross cable	PAP COM 2	IOR COM2
3	RJ45 – RJ45 Ethernet cable	PAP LAN Maint	PMB or Hub
5	Combined PS2/VGA cable	PAP VGA/PS2	KVM Port 1
6	RJ45 to RJ45 Ethernet cable	PAP LAN Enter	Enterprise LAN
7	USB cable	PAP USB	Modem
9	RJ11 – RJ11 cable	Modem (Line)	Telephone network socket

Figure 173. PAP unit data cabling diagram (example 1)

1U PAP Unit

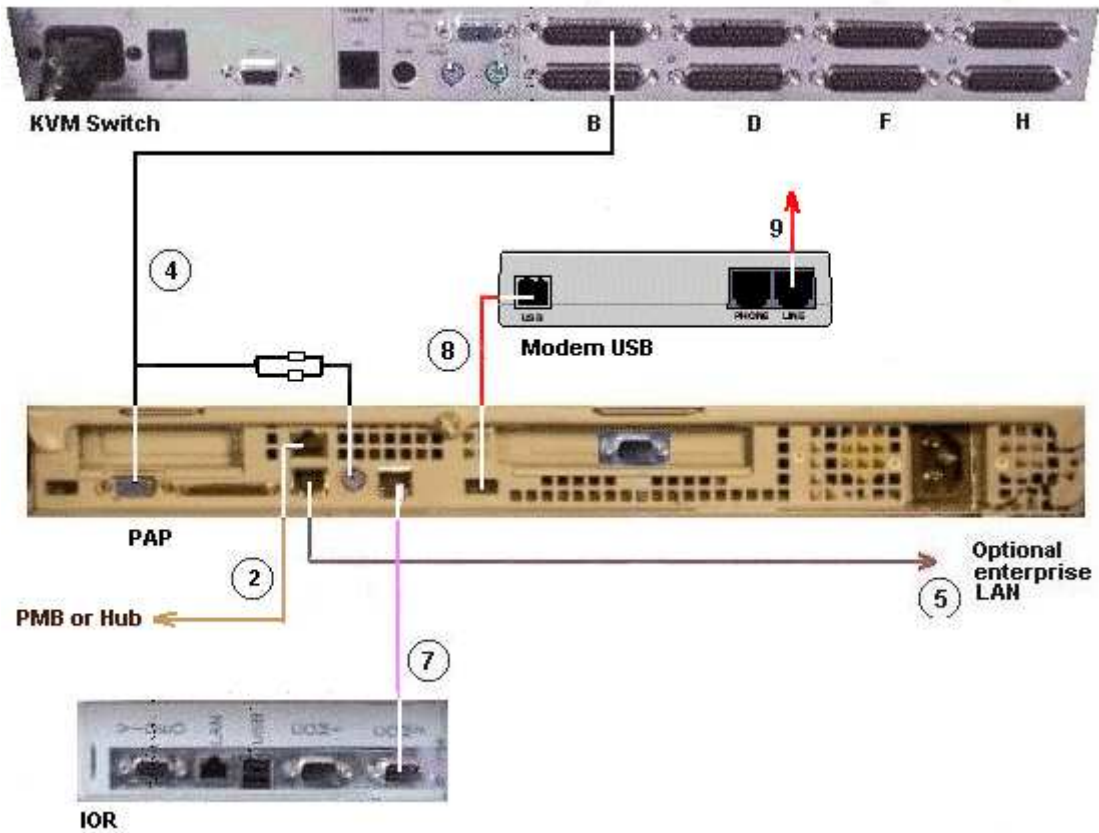

Mark	Cable Type	From	To
1	RJ45 – RJ45 Ethernet cable	PMB Ethernet	Hub port 8
2	RJ45 – RJ45 Ethernet cable	PAP LAN Maint	Hub port 7
4	Combined PS2/VGA cable	PAP VGA/PS2	KVM Port A
5	RJ45 to RJ45 Ethernet cable	PAP LAN Enter	Enterprise LAN
7	RJ45/DB9 to DB9 cross cable	PAP COM 2	IOR
8	USB cable	PAP USB	Modem
9	RJ11 – RJ11 cable	Modem (Line)	Telephone network socket

Figure 174. PAP unit data cabling diagram (example 2)

Disk Rack (SJ-0812 SCSI JBOD)

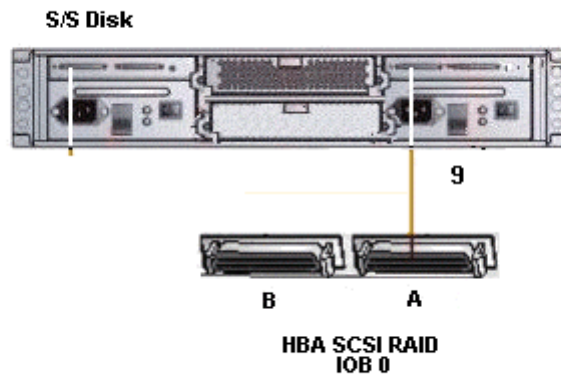

Mark	Cable Type	From	To
9	SCSI-3 68-pin VHDCI to VHDCI cable	HBA SCSI RAID	S/S Disk Extension port

Figure 175. SJ-0812 SCSI JBOD disk rack data cabling diagram

Disk Rack (SR-0812 SCSI RAID)

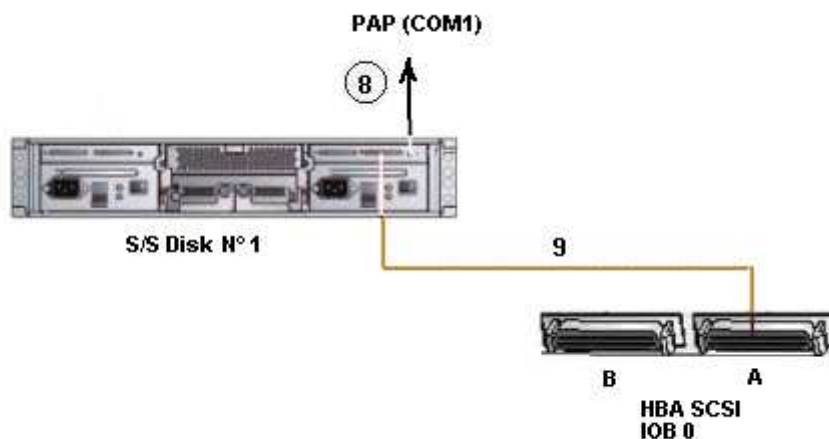

Mark	Cable Type	From	To
8*	DB9 to Jack cable	PAP COM 1	S/S Disk RS232
9	SCSI-3 68-pin VHDCI to VHDCI cable	HBA SCSI	S/S Disk Host port

* cable used to configure the disk S/S.

Figure 176. SR-0812 SCSI RAID disk rack data cabling diagram

Extension Disk Rack (SR-0812 SCSI RAID – SJ-0812 SCSI JBOD)

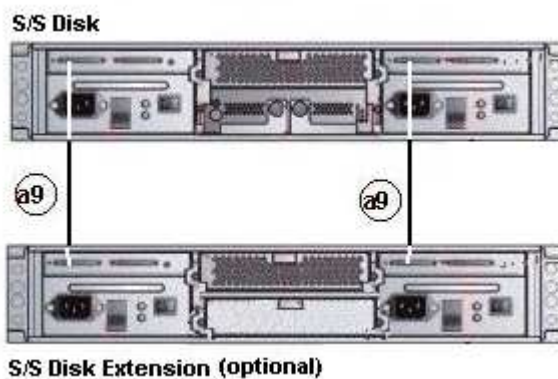

Mark	Cable Type	From	To
a9	SCSI-3 68-pin VHDCI to VHDCI cable	SR-0812 SCSI RAID extension port	SJ-0812 SCSI JBOD extension port

Figure 177. SJ-0812 SCSI JBOD extension disk rack data cabling diagram

Disk Rack (FDA 1x00 FC)

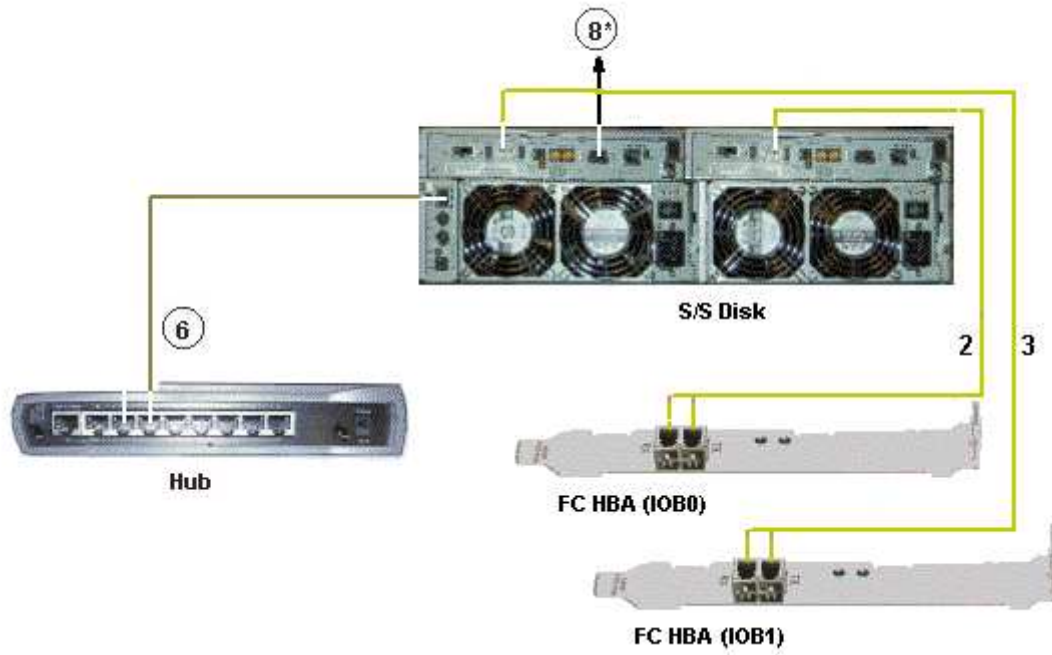

Mark	Cable Type	From	To
2	LC–LC cable	S/S Disk (CTL 0)	FC Adapter IOB 0
3	LC–LC cable	S/S Disk (CTL 1)	FC Adapter IOB 1
6	RJ45 – RJ45 Ethernet cable	S/S Disk	Hub port 6
8	DB9 to DB9 serial cable *	PAP COM 1	S/S Disk RS232

* optional cable used to configure the S/S disk.

Figure 178. FDA 1x00 FC disk rack data cabling diagram

Extension Disk Rack (FDA 1x00 FC – FDA 1x00 FC)

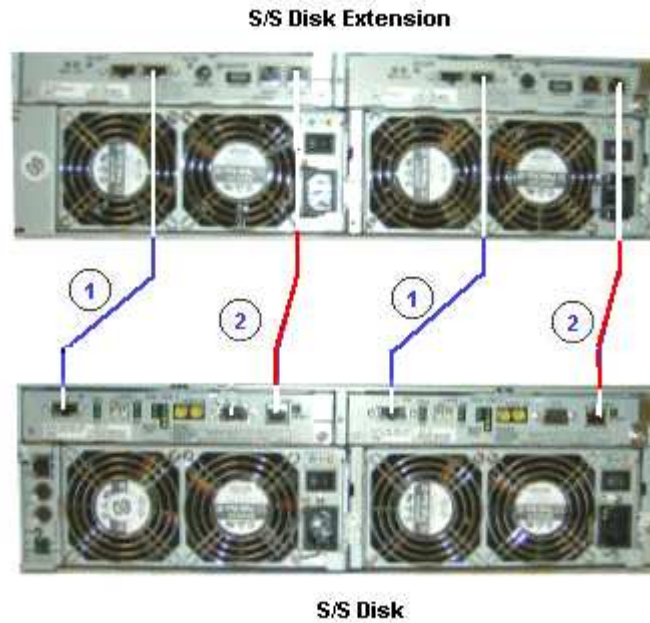

Mark	Cable Type	From	To
1	HSSDC–HSSDC cable	S/S Disk	S/S Disk Extension
2	DE diagnosis cable	S/S Disk	S/S Disk Extension

Figure 179. FDA 1x00 FC – FDA 1x00 FC extension disk rack data cabling diagram

PMB

1U PAP Unit

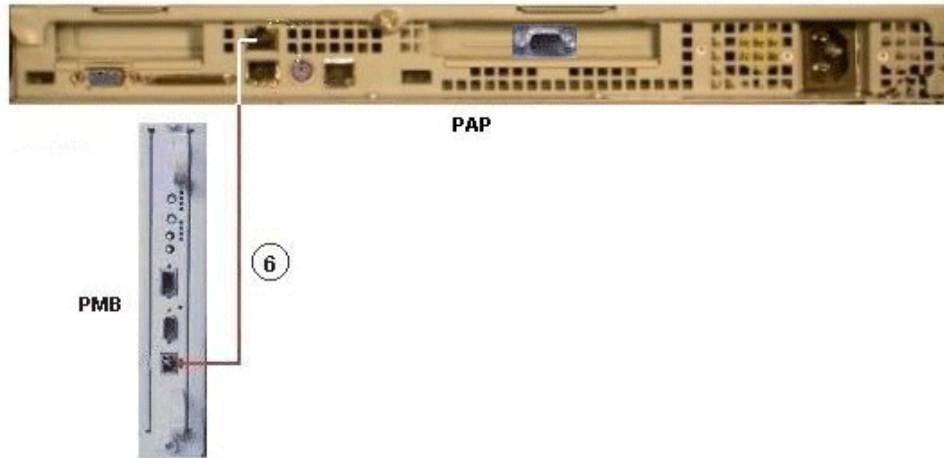

2U PAP Unit

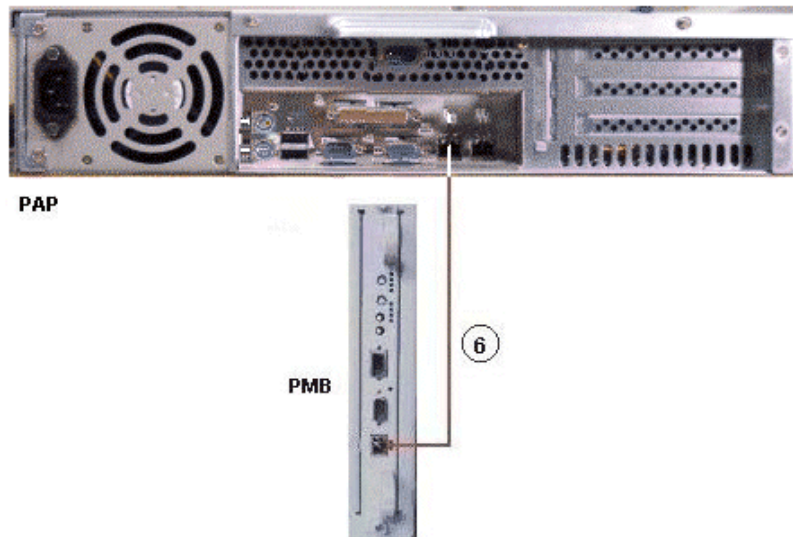

Ethernet Hub

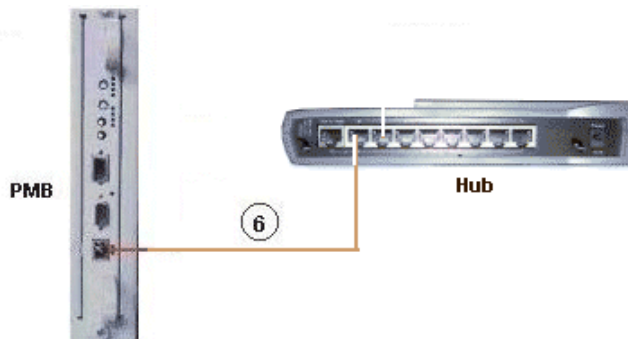

Mark	Cable Type	From	To
6	RJ45 – RJ45 Ethernet cross cable	PAP LAN Maint	PMB Ethernet or Hub

Figure 180. PMB data cabling diagram examples

Ethernet Hub

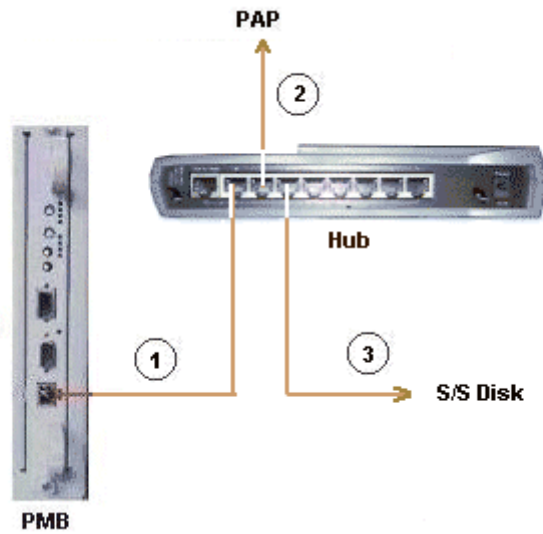

Mark	Cable Type	From	To
1	RJ45 – RJ45 Ethernet cable	Hub Ethernet port 8	PMB Ethernet
2	RJ45 – RJ45 Ethernet cable	Hub Ethernet port 7	PAPER LAN Maint
3	RJ45 – RJ45 Ethernet cable	Hub Ethernet port 6	S/S Disk FC

Figure 181. Ethernet hub data cabling diagram

Modem

1U PAP Unit

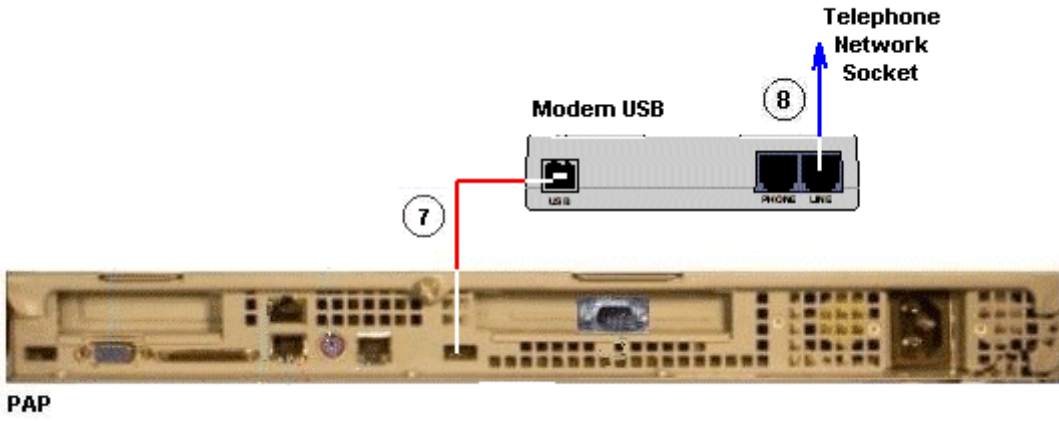

2U PAP Unit

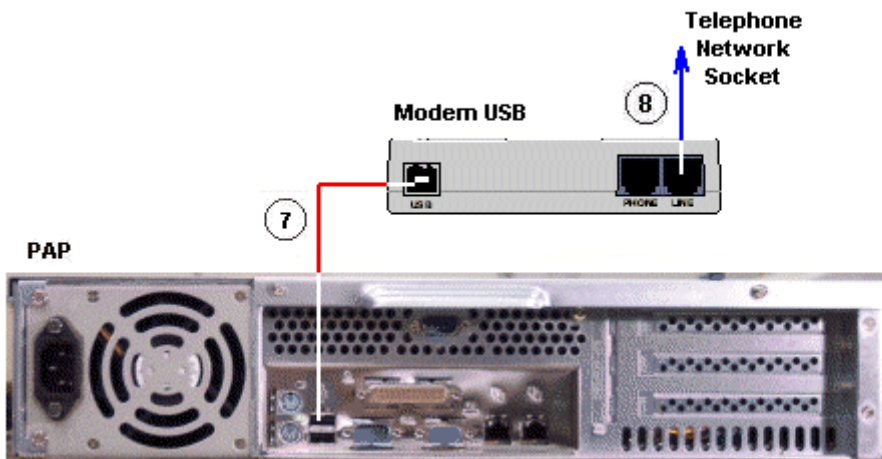

Mark	Cable Type	From	To
------	------------	------	----

Figure 182. Modem data cabling diagram

Power Cables

The CSS Module is equipped with a dedicated power supply cable. All other server component power supply cables are connected to the internal PDU, as shown below:

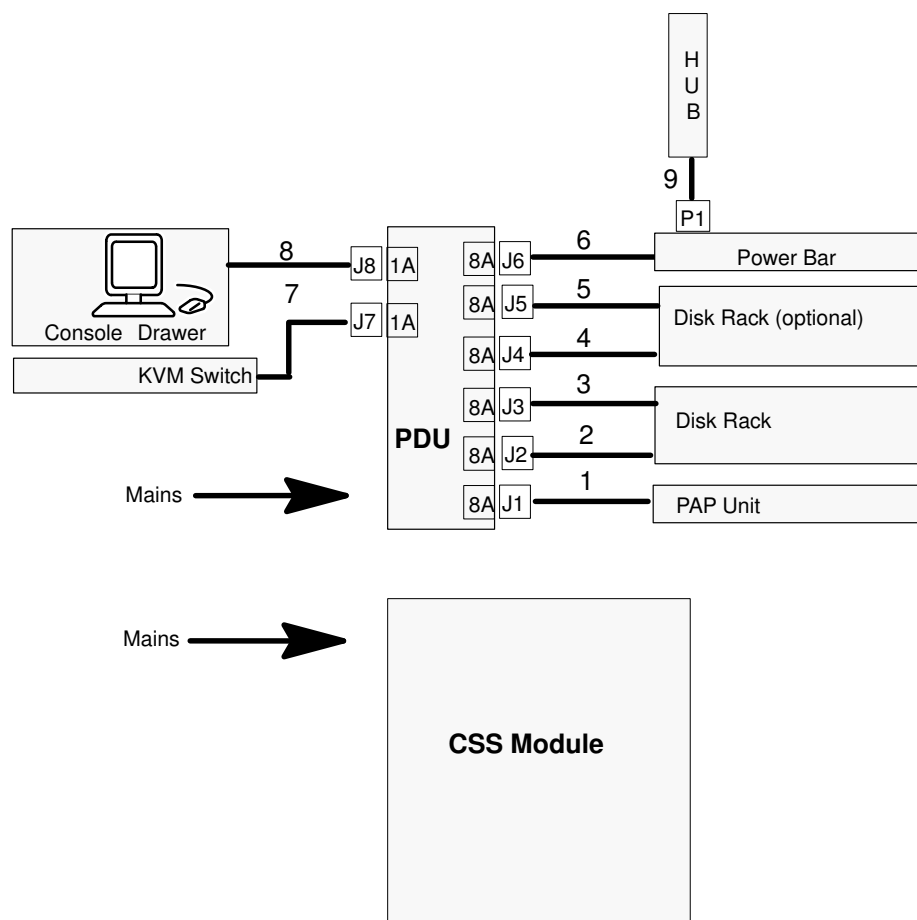

Mark	Cable Type	From	To
1	Power cable	PAP PWR	PDU J1
2	Power cable	S/S Disk PWR	PDU J2
3	Power cable	S/S Disk PWR	PDU J3
4	Power cable	Optional S/S Disk PWR	PDU J4
5	Power cable	Optional S/S Disk PWR	PDU J5
6	Power cable	Power Bar	PDU J6
7	Power cable	KVM PWR	PDU J7
8	Power cable	Monitor PWR	PDU J8
9	Power cable	Hub PWR	Power Bar P1

Figure 183. Power cabling diagram

Section II – NovaScale 6080/6160 Server Cabling Diagrams

- ▶ Console, on page B-20
- ▶ KVM Switch, on page B-21
- ▶ IOR, on page B-23
- ▶ PAP Unit, on page B-25
- ▶ Disk Rack (SJ-0812 SCSI JBOD), on page B-27
- ▶ Disk Rack (SR-0812 SCSI RAID), on page B-28
- ▶ NPort Server, on page B-29
- ▶ Disk Rack (FDA 1x00 FC), on page B-30
- ▶ Extension Disk Rack (FDA 1x00 FC – FDA 1x00 FC), on page B-31
- ▶ PMB, on page B-32
- ▶ Ethernet Hub, on page B-33
- ▶ Modem, on page B-34
- ▶ Power, on page B-35

Integrated Console

Slideaway Console

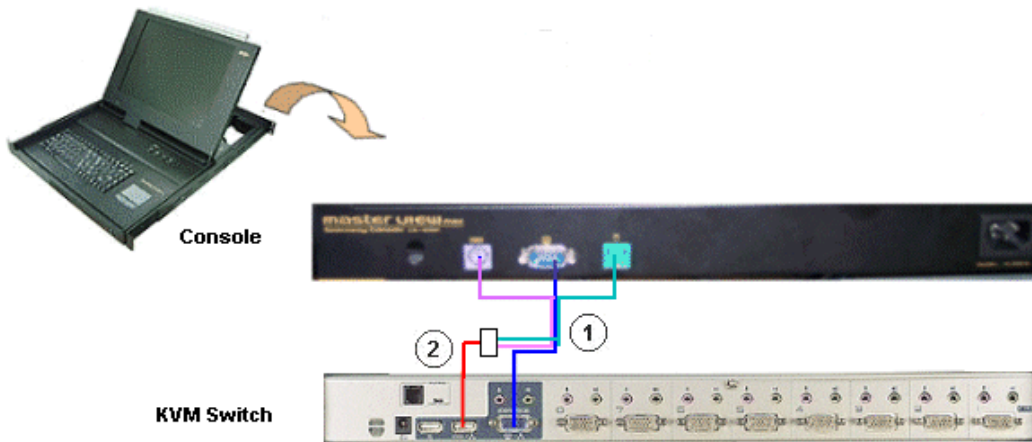

Mark	Cable Type	From	To
1	video/PS2/PS2 cable	Console (video)	KVM switch (video)
2	PS2/USB converter	Console (PS2/PS2)	KVM switch (USB)

Figure 184. Slideaway console data cabling diagram

Console Drawer

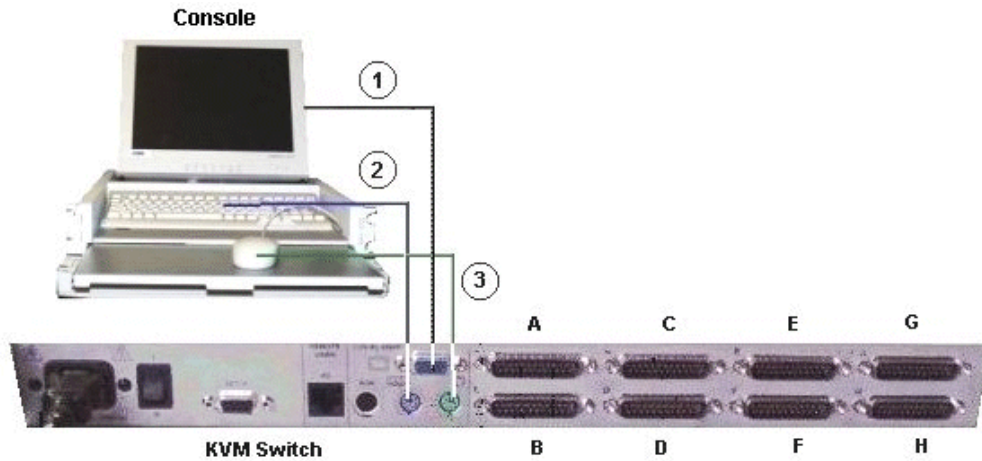

Mark	Cable Type	From	To
1	HD15 video cable	Monitor (blue)	KVM switch (blue)
2	PS2 mini-DIN6 cable + PS2/PS2 extension cable	Keyboard (mauve)	KVM switch (mauve)
3	PS2 mini-DIN6 cable + PS2/PS2 extension cable	Mouse (green)	KVM switch (green)

Figure 185. Console drawer data cabling diagram

KVM Switch

Aten 8-Port KVM Switch

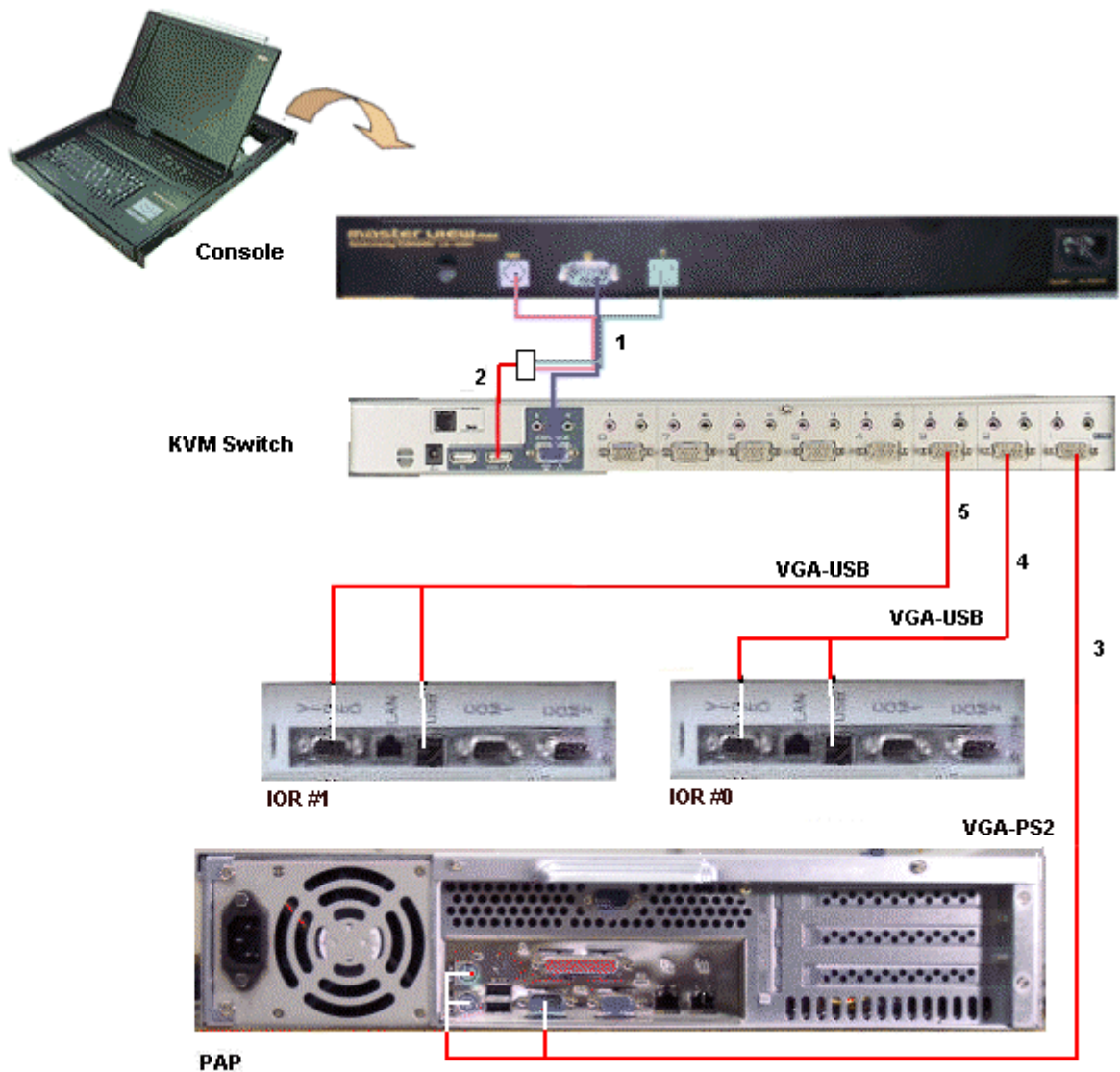

Mark	Cable Type	From	To
1	Video/PS2/PS2 cable	Console (video)	KVM switch (video)
2	PS2/USB converter	Console (PS2/PS2)	KVM switch (USB)
3	Combined PS2/VGA cable	KVM Port 1	PAP (VGA/PS2)
4	Combined USB/VGA cable	KVM Port 2	IOR (IOB0) (Video/USB)
5	Combined USB/VGA cable	KVM Port 3	IOR (IOB1) (Video/USB)

Figure 186. 8-port KVM switch data cabling diagram (example 1)

Avocent 8-Port KVM Switch

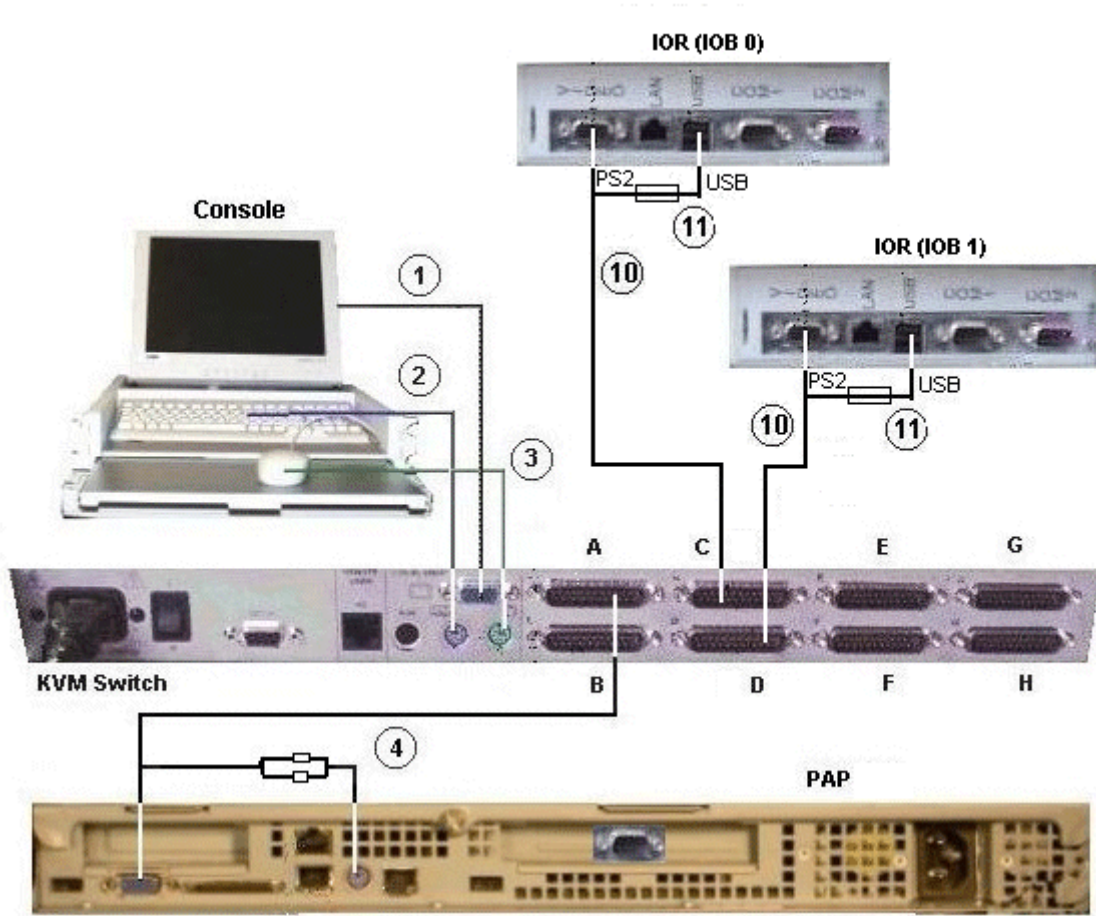

Mark	Cable Type	From	To
1	HD15 video cable	Monitor (blue)	KVM (blue)
2	PS2 mini-DIN6 cable + PS2/PS2 extension cable	Keyboard (mauve)	KVM (mauve)
3	PS2 mini-DIN6 cable + PS2/PS2 extension cable	Mouse (green)	KVM (green)
4	Combined PS2/VGA cable	KVM Port A	PAP VGA/PS2
10	Combined USB/VGA cable (Windows)	KVM Port C/D	IOR Video/USB
	Combined PS2/VGA cable (Linux)	KVM Port C/D	IOR (Video)
11	USB/PS2 converter (Linux)	PS2 cable (mark 10)	IOR (USB)

Figure 187. 8-port KVM switch data cabling diagram (example 2)

IOR

IOR – 2U PAP Unit – Aten 8-Port KVM Switch

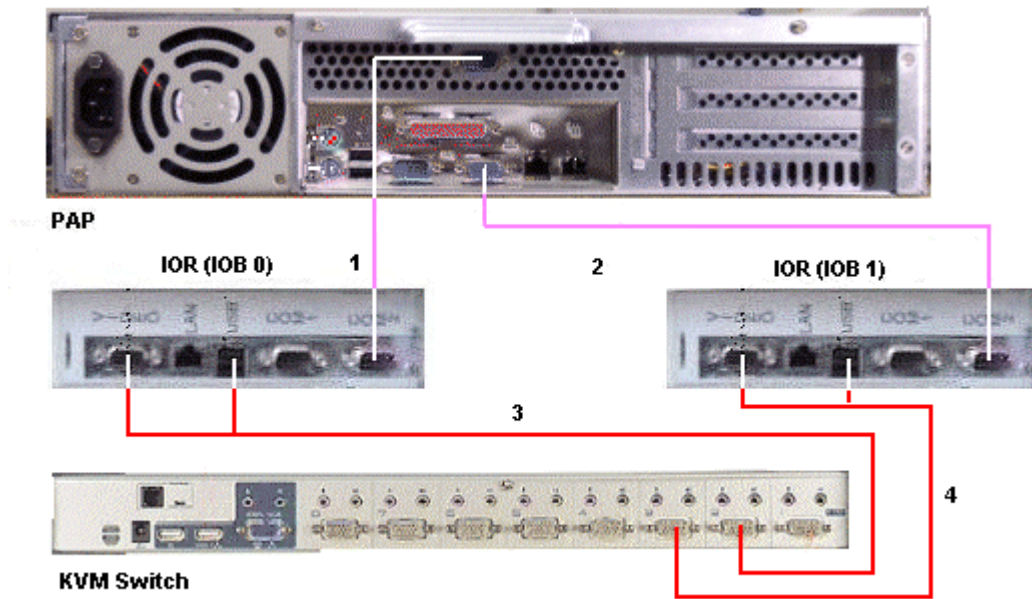

Mark	Cable Type	From	To
1	DB9 to DB9 cross cable	PAP COM 2	IOR (IOB0)
2	DB9 to DB9 cross cable	PAP COM 1	IOR (IOB1)
3	Combined USB/VGA cable	KVM Port 2	IOR (IOB0) Video/USB
4	Combined USB/VGA cable	KVM Port 3	IOR (IOB1) Video/USB

Figure 188. IOR data cabling diagram (example 1)

IOR – 1U PAP Unit – Avocent 8-Port KVM Switch

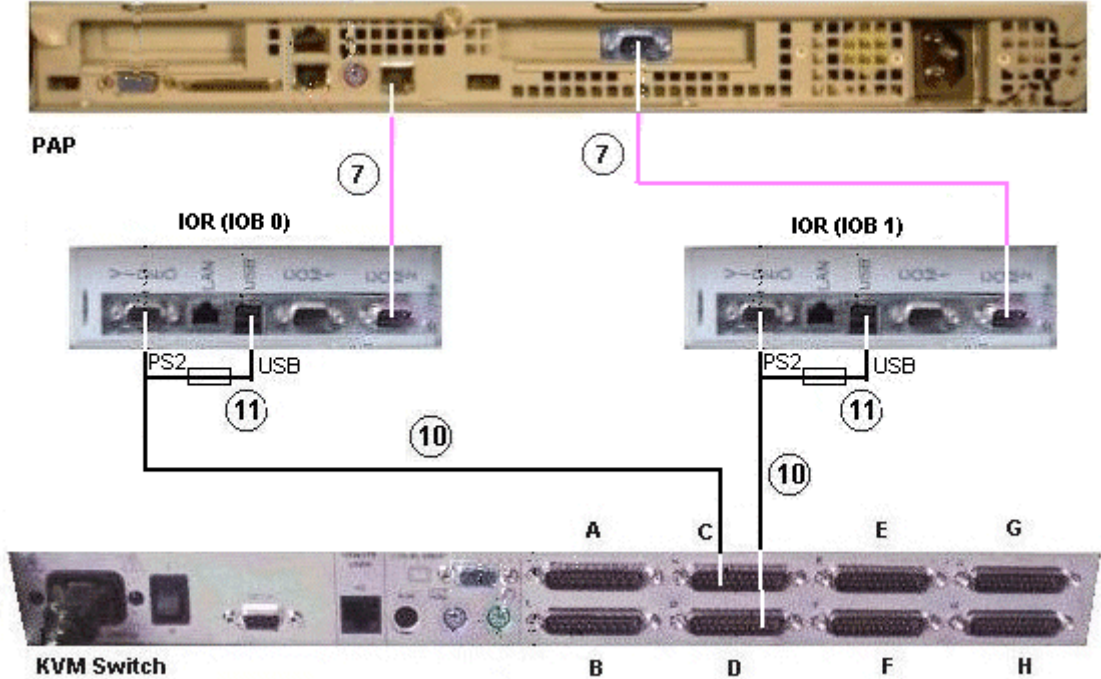

Mark	Cable Type	From	To
7	RJ45/DB9 to DB9 cross cable	PAP COM 2	IOR (IOB0)
	DB9 to DB9 cross cable	PAP COM 1	IOR (IOB1)
10	Combined USB/VGA cable (Windows)	KVM Port C/D	IOR Video/USB
	Combined PS2/VGA cable (Linux)	KVM Port C/D	IOR (Video)
11	USB/PS2 converter (Linux)	PS2 cable (mark 10)	IOR (USB)

Figure 189. IOR data cabling diagram (example 2)

PAP Unit

2U PAP Unit

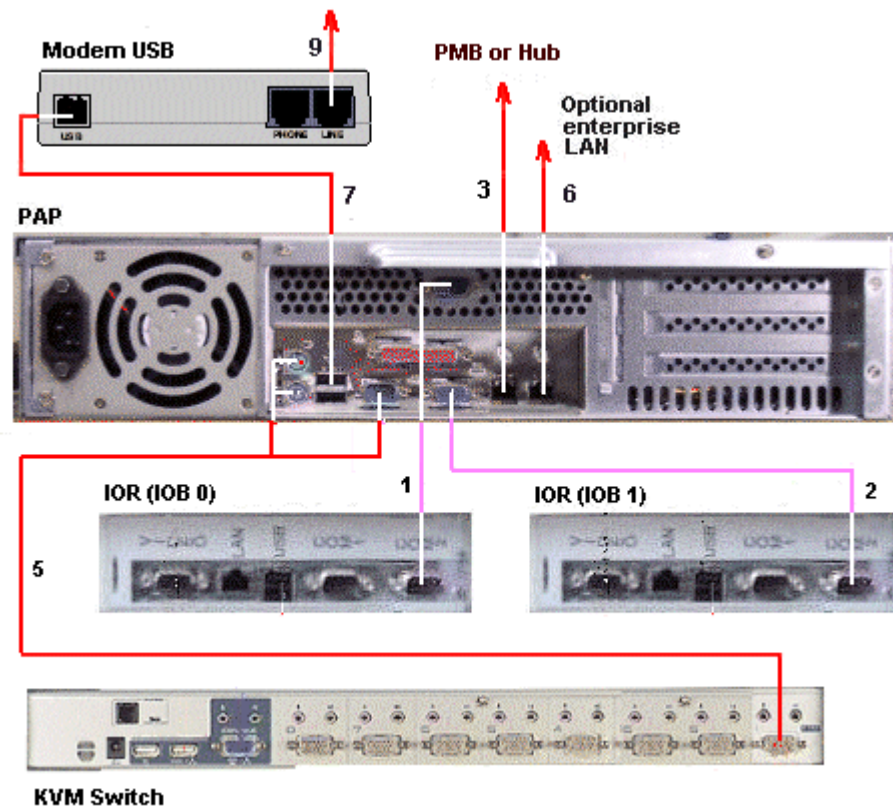

Mark	Cable Type	From	To
1	DB9 to DB9 cross cable	PAP COM 2	IOR (IOB0) COM2
2	DB9 to DB9 cross cable	PAP COM 1	IOR (IOB1) COM2
3	RJ45 – RJ45 Ethernet cable	PAP LAN Maint	PMB or Hub
5	Combined PS2/VGA cable	PAP VGA/PS2	KVM Port 1
6	RJ45 to RJ45 Ethernet cable	PAP LAN Enter	Enterprise LAN
7	USB cable	PAP USB	Modem
9	RJ11 – RJ11 cable	Modem (Line)	Telephone network socket

Figure 190. PAP unit data cabling diagram (example 1)

1U PAP Unit

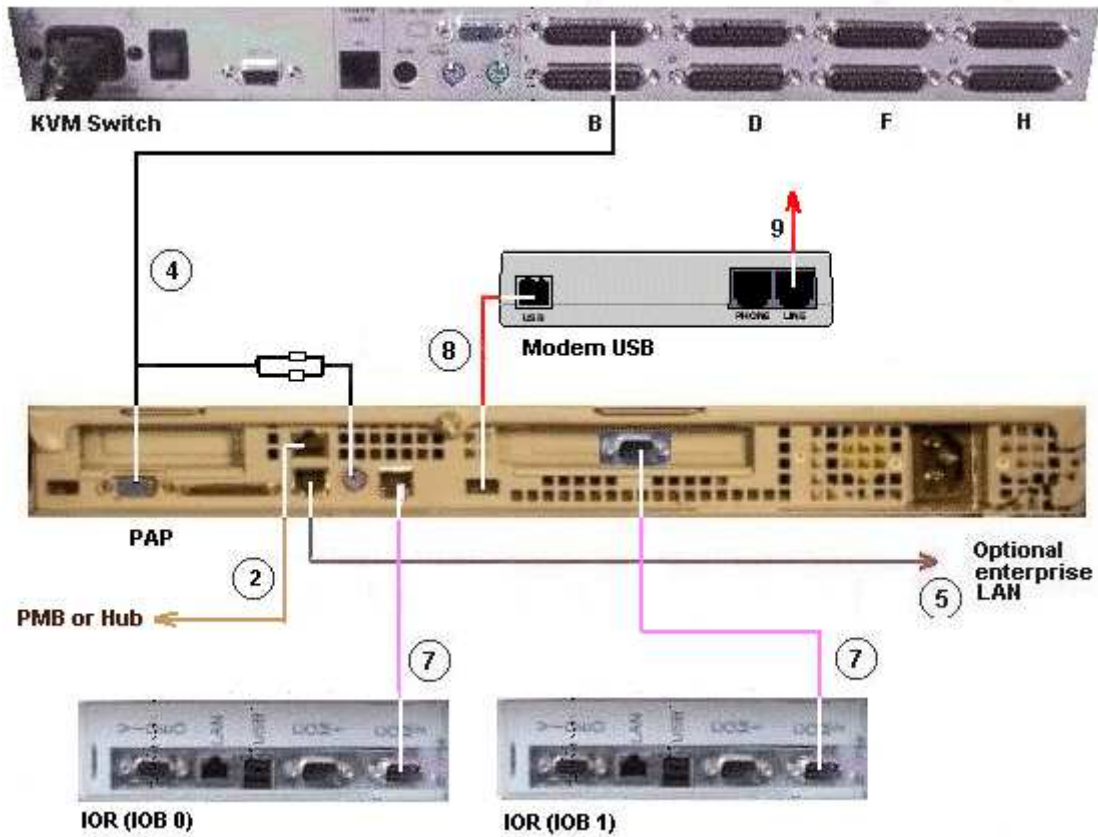

Mark	Cable Type	From	To
1	RJ45 – RJ45 Ethernet cable	PMB Ethernet	Hub port 8
2	RJ45 – RJ45 Ethernet cable	PAP LAN Maint	Hub port 7
4	Combined PS2/VGA cable	PAP VGA/PS2	KVM Port A
5	RJ45 to RJ45 Ethernet cable	PAP LAN Enter	Enterprise LAN
7	RJ45/DB9 to DB9 cross cable	PAP COM 2	IOR (IOB0)
	DB9 to DB9 cross cable	PAP COM 1	IOR (IOB1)
8	USB cable	PAP USB	Modem
9	RJ11 – RJ11 cable	Modem (Line)	Telephone network socket

Figure 191. PAP unit data cabling diagram (example 2)

Disk Rack (SJ-0812 SCSI JBOD)

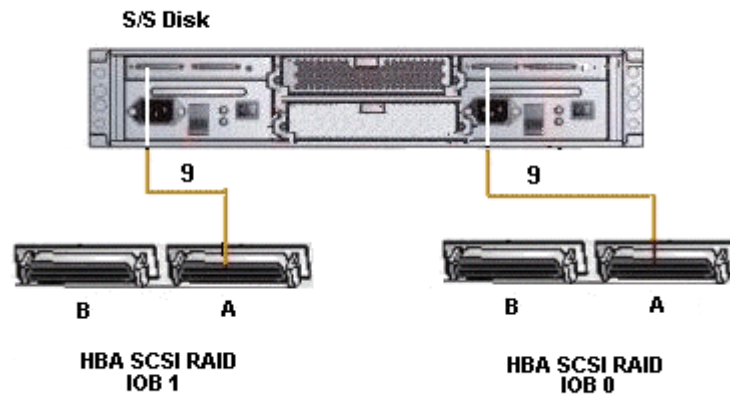

Mark	Cable Type	From	To
9	SCSI-3 68-pin VHDCI to VHDCI cable	HBA SCSI RAID	S/S Disk Extension port

Figure 192. SJ-0812 SCSI JBOD disk rack data cabling diagram

Disk Rack (SR-0812 SCSI RAID)

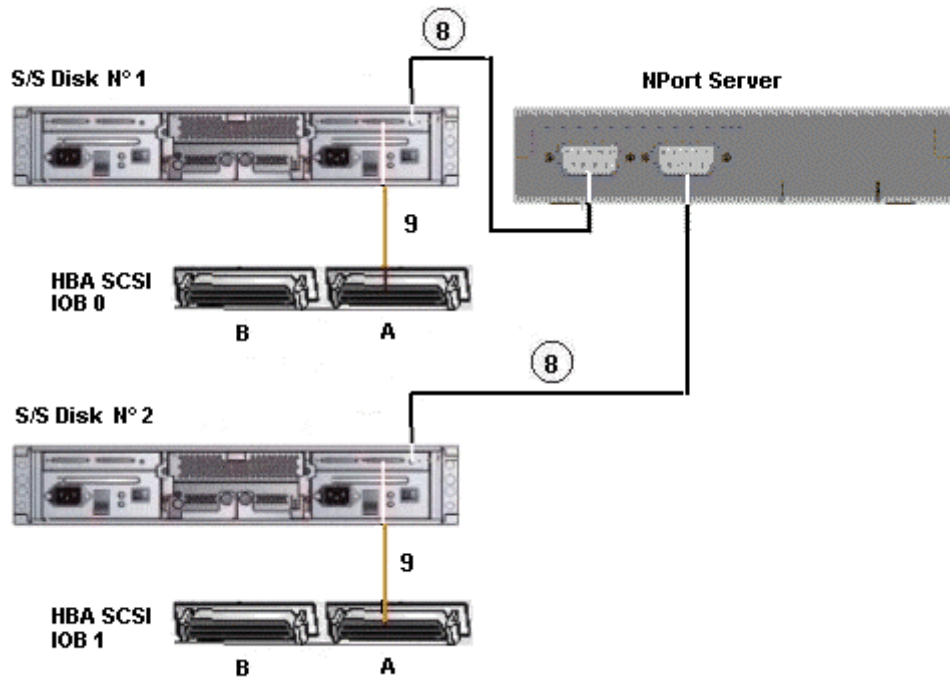

Mark	Cable Type	From	To
8*	DB9 to Jack cable	Nport server	S/S Disk RS232
9	SCSI-3 68-pin VHDCI to VHDCI cable	HBA SCSI	S/S Disk Host port

* cable used to configure the disk S/S.

Figure 193. SR-0812 SCSI RAID disk rack data cabling diagram

Extension Disk Rack (SR-0812 SCSI RAID – SJ-0812 SCSI JBOD)

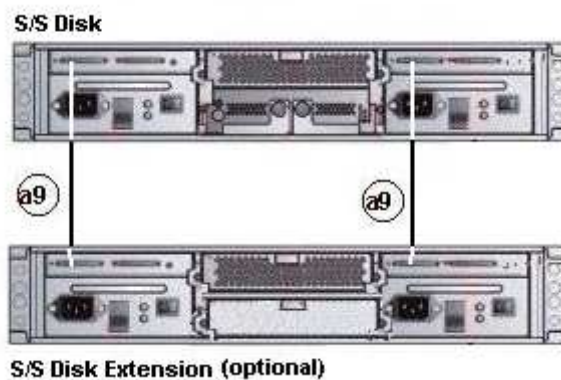

Mark	Cable Type	From	To
a9	SCSI-3 68-pin VHDCI to VHDCI cable	SR-0812 SCSI RAID extension port	SJ-0812 SCSI JBOD extension port

Figure 194. SJ-0812 SCSI JBOD extension disk rack data cabling diagram

NPort Server

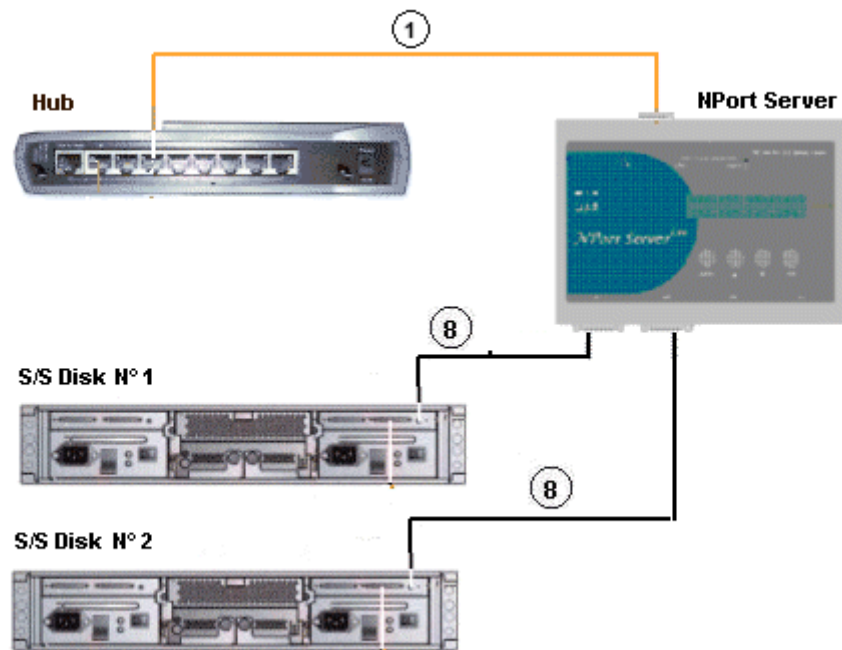

Mark	Cable Type	From	To
1	RJ45 – RJ45 Ethernet cable	Nport Server	Hub
8	DB9 to Jack cable	Nport Server	S/S Disk RS232

Figure 195. NPort Server data cabling diagram

Disk Rack (FDA 1x00 FC)

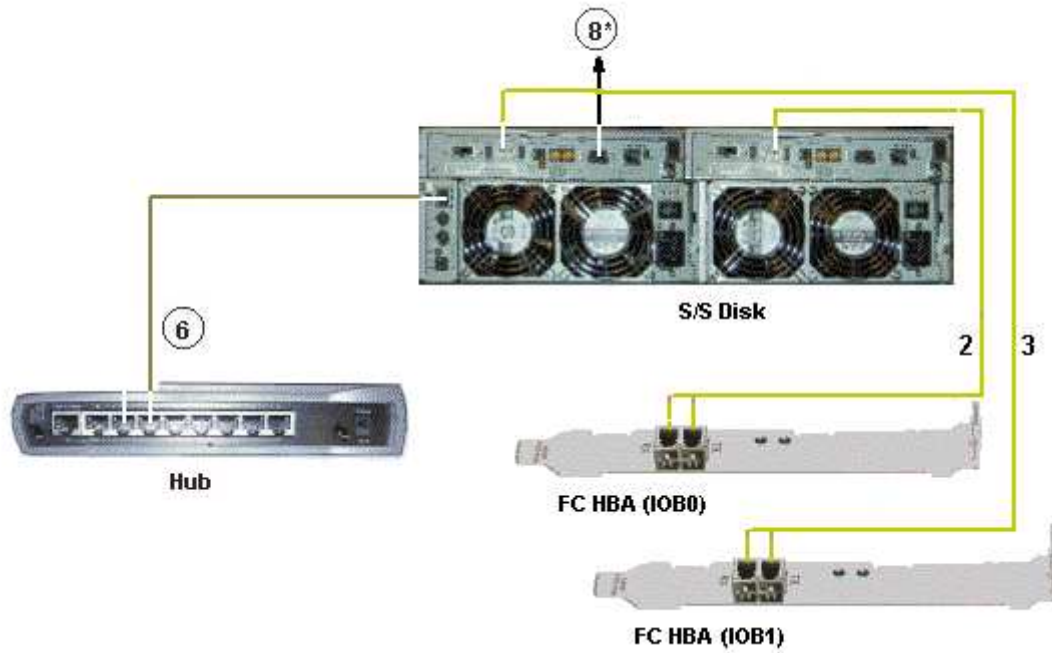

Mark	Cable Type	From	To
2	LC-LC cable	S/S Disk (CTL 0)	FC Adapter IOB 0
3	LC-LC cable	S/S Disk (CTL 1)	FC Adapter IOB 1
6	RJ45 – RJ45 Ethernet cable	S/S Disk	Hub port 6
8	DB9 to DB9 serial cable *	PAP COM 1	S/S Disk RS232

* optional cable used to configure the S/S disk.

Figure 196. FDA 1x00 FC disk rack data cabling diagram

Extension Disk Rack (FDA 1x00 FC – FDA 1x00 FC)

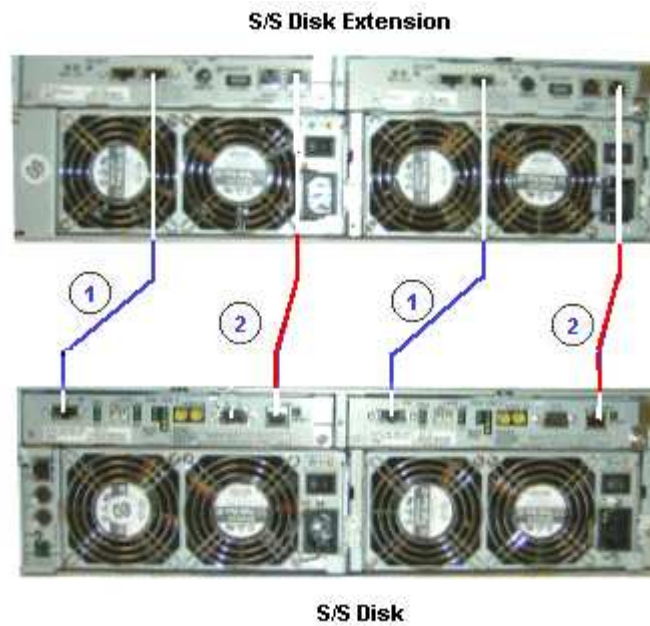

Mark	Cable Type	From	To
1	HSSDC–HSSDC cable	S/S Disk	S/S Disk Extension
2	DE diagnosis cable	S/S Disk	S/S Disk Extension

Figure 197. FDA 1x00 FC – FDA 1x00 FC extension disk rack data cabling diagram

PMB

1U PAP Unit

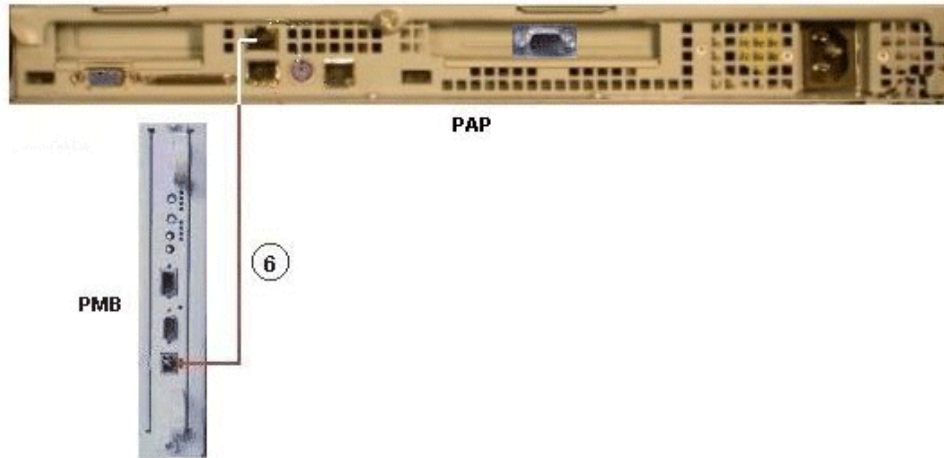

2U PAP Unit

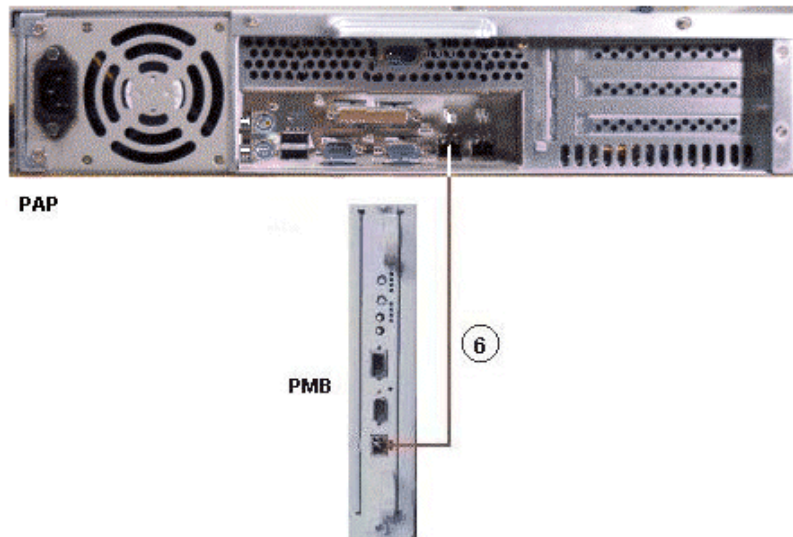

Ethernet Hub

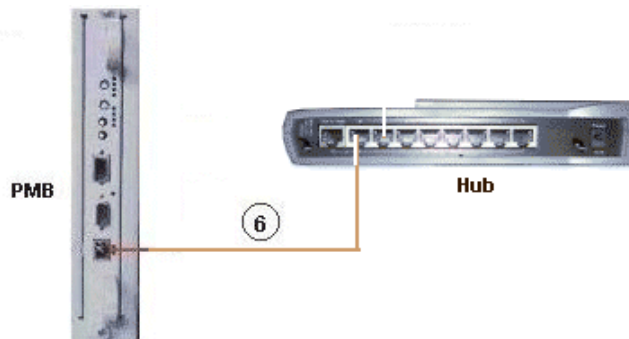

Mark	Cable Type	From	To
6	RJ45 – RJ45 Ethernet cross cable	PAP LAN Maint	PMB Ethernet or Hub

Figure 198. PMB data cabling diagram examples

Ethernet Hub

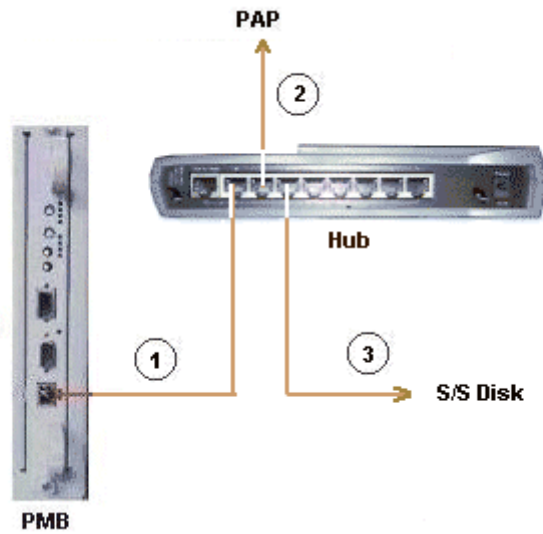

Mark	Cable Type	From	To
1	RJ45 – RJ45 Ethernet cable	Hub Ethernet port 8	PMB Ethernet
2	RJ45 – RJ45 Ethernet cable	Hub Ethernet port 7	PAP LAN Maint
3	RJ45 – RJ45 Ethernet cable	Hub Ethernet port 6	S/S Disk FC or NPort Server (SCSI RAID Disk)

Figure 199. Ethernet hub data cabling diagram

Modem

1U PAP Unit

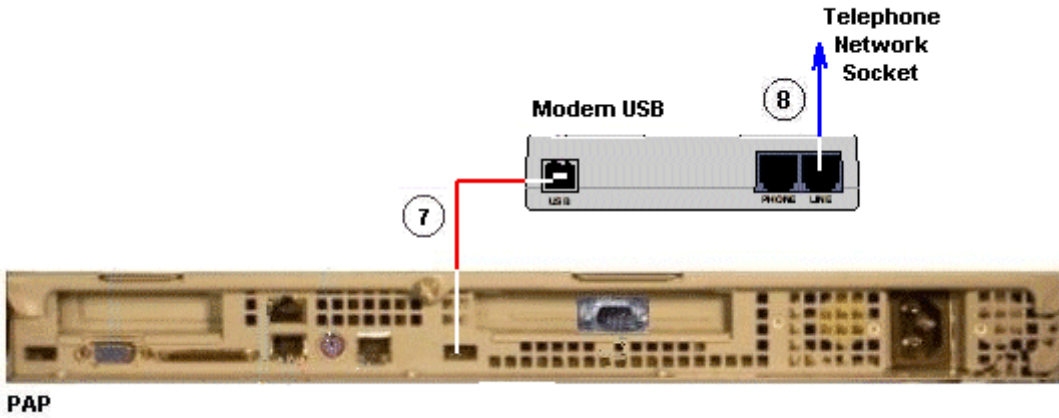

2U PAP Unit

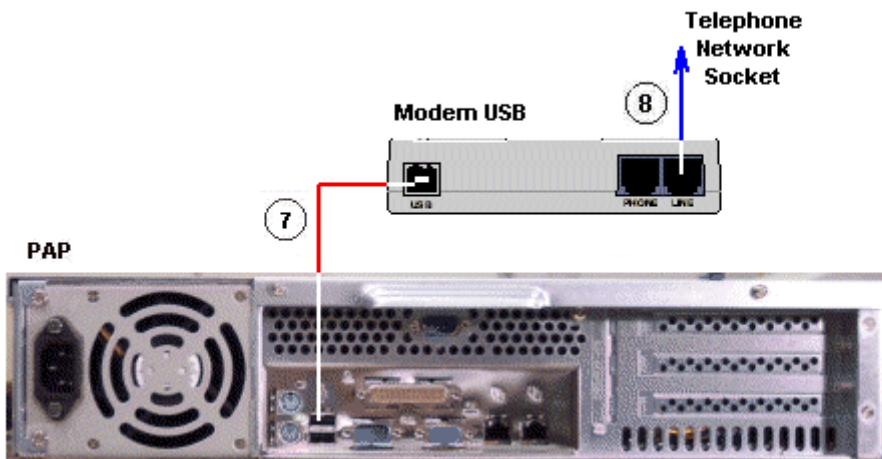

Mark	Cable Type	From	To
7	USB cable	PAP USB	Modem USB
8	RJ11 – RJ11 cable	Modem (Line)	Telephone network socket

Figure 200. Modem data cabling diagram

Power

The CSS Module is equipped with a dedicated power supply cable. All other server component power supply cables are connected to the internal PDU, as shown below:

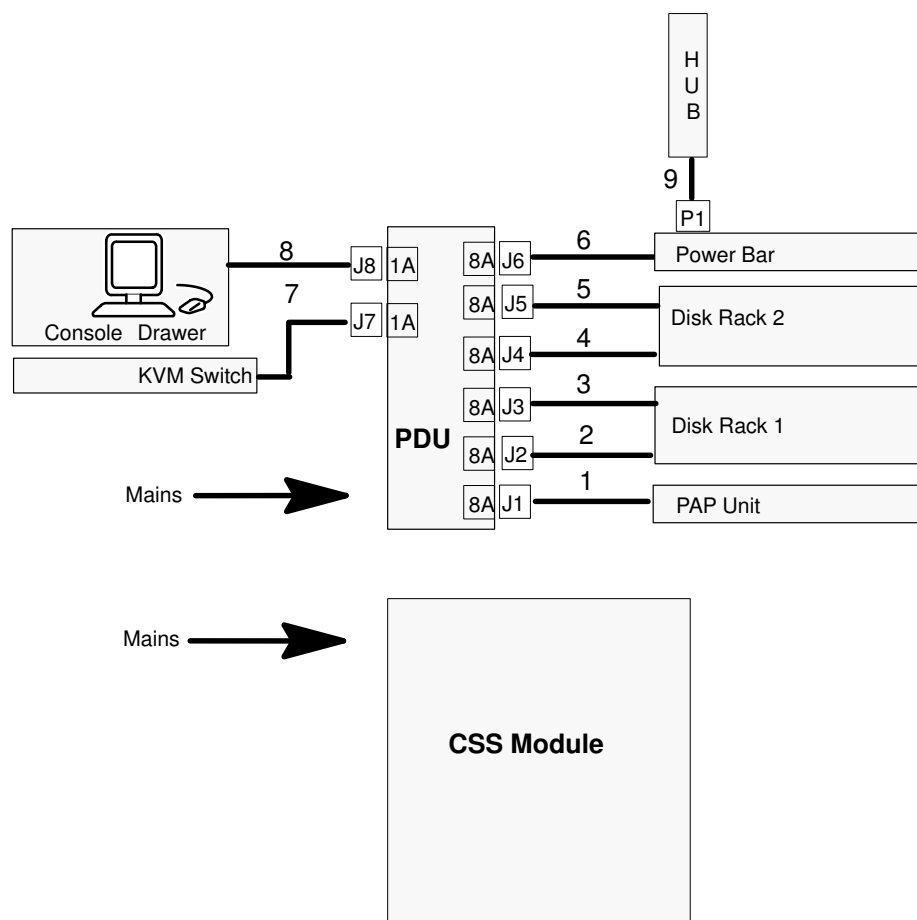

Mark	Cable Type	From	To
1	Power cable	PAP PWR	PDU J1
2	Power cable	S/S Disk 1 PWR	PDU J2
3	Power cable	S/S Disk 1 PWR	PDU J3
4	Power cable	S/S Disk 2 PWR	PDU J4
5	Power cable	S/S Disk 2 PWR	PDU J5
6	Power cable	Power Bar	PDU J6
7	Power cable	KVM PWR	PDU J7
8	Power cable	Monitor PWR	PDU J8
9	Power cable	Hub PWR	Power Bar P1

Figure 201. Power cabling diagram

Section III – NovaScale 6320 Server Cabling Diagrams

- ▶ Console, on page B-37
- ▶ KVM Switch, on page B-39
- ▶ IOR, on page B-41
- ▶ PAP Unit, on page B-42
- ▶ Disk Rack (SJ-0812 SCSI JBOD), on page B-44
- ▶ Disk Rack (SR-0812 SCSI RAID), on page B-45
- ▶ Extension Disk Rack (SR-0812 SCSI RAID – SJ-0812 SCSI JBOD), on page B-46
- ▶ NPort Server, on page B-47
- ▶ Disk Rack (FDA 1x00 FC), on page B-48
- ▶ Extension Disk Rack (FDA 1x00 FC – FDA 1x00 FC), on page B-49
- ▶ Disk Rack (FDA 2x00 FC), on page B-50
- ▶ Extension Disk Rack (FDA 2x00 FC – FDA 1x00 FC), on page B-51
- ▶ PMB – Hub – Pap Unit, on page B-52
- ▶ Ethernet Hub, on page B-53
- ▶ Modem, on page B-54
- ▶ Power, on page B-55
- ▶ Inter-Cabinet (PMB – Ethernet Hub), on page B-57
- ▶ Inter-Cabinet (IOR – KVM Switch), on page B-58
- ▶ Inter-Cabinet (IOB HBA RAID – SJ-0812 SCSI JBOD), on page B-59
- ▶ Inter-Cabinet (IOB HBA – SR-0812 SCSI RAID), on page B-60
- ▶ Inter-Cabinet (IOB HBA – FDA 1x00 FC), on page B-61
- ▶ Inter-Cabinet (IOB HBA – FDA 2x00 FC), on page B-62

Console

Slideaway Console

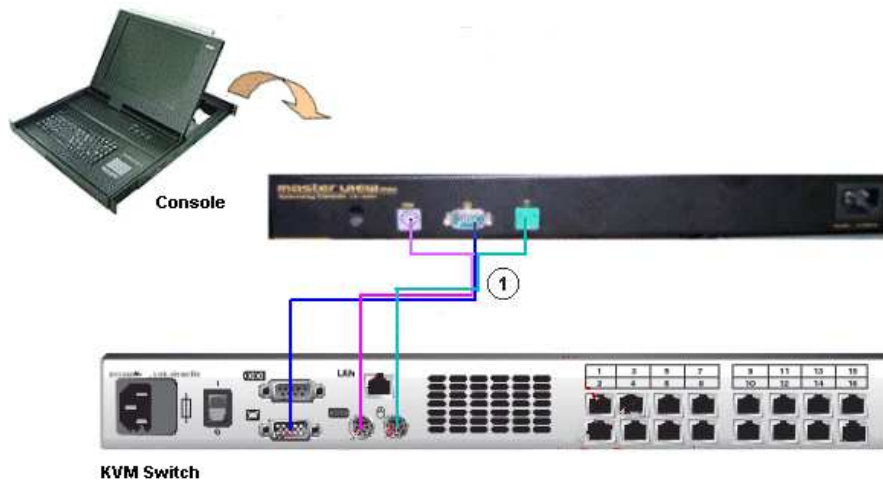

Mark	Cable Type	From	To
1	video/PS2/PS2 cable	Console	KVM switch

Figure 202. Slideaway console data cabling diagram

Console Drawer

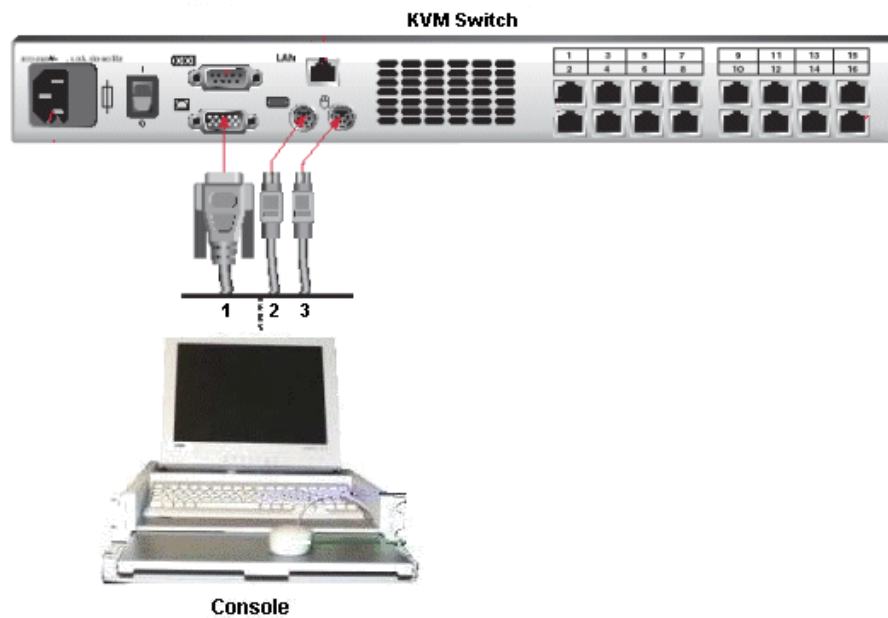

Mark	Cable Type	From	To
1	HD15 video cable	Monitor (blue)	KVM switch (blue)
2	PS2 mini-DIN6 cable + PS2/PS2 extension cable	Keyboard (mauve)	KVM switch (mauve)
3	PS2 mini-DIN6 cable + PS2/PS2 extension cable	Mouse (green)	KVM switch (green)

Figure 203. Integrated console data cabling diagram

16-Port KVM Switch

Slideaway Console – 2U PAP Unit

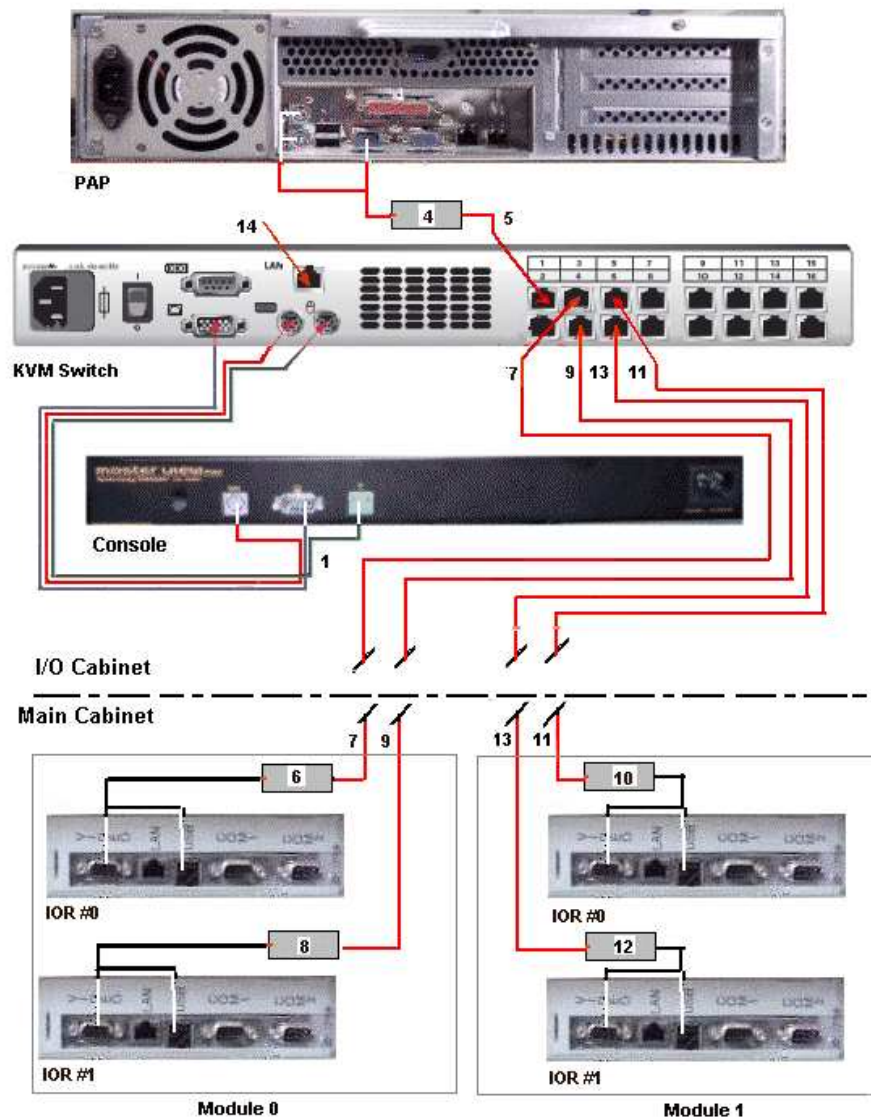

Mark	Cable Type	From	To
1	video/PS2/PS2 cable	Console	KVM switch
5	RJ45/RJ45 cable	PAP (VGA and PS2) via AVRIQ (4)	KVM Port 1
7*	RJ45/RJ45 cable	IOR #0 Module 0 VGA and USB via AVRIQ (6)	KVM Port 3
9*	RJ45/RJ45 cable	IOR #1 Module 0 VGA and USB via AVRIQ (8)	KVM Port 4
11*	RJ45/RJ45 cable	IOR #0 Module 1 VGA and USB via AVRIQ (10)	KVM Port 5
13*	RJ45/RJ45 cable	IOR #1 Module 1 VGA and USB via AVRIQ (12)	KVM Port 6
14	RJ45/RJ45 cable	KVM (LAN)	Enterprise LAN

* Inter-cabinet data cable

Figure 204. 16-port KVM switch data cabling diagram (example 1)

Console Drawer – 1U PAP Unit

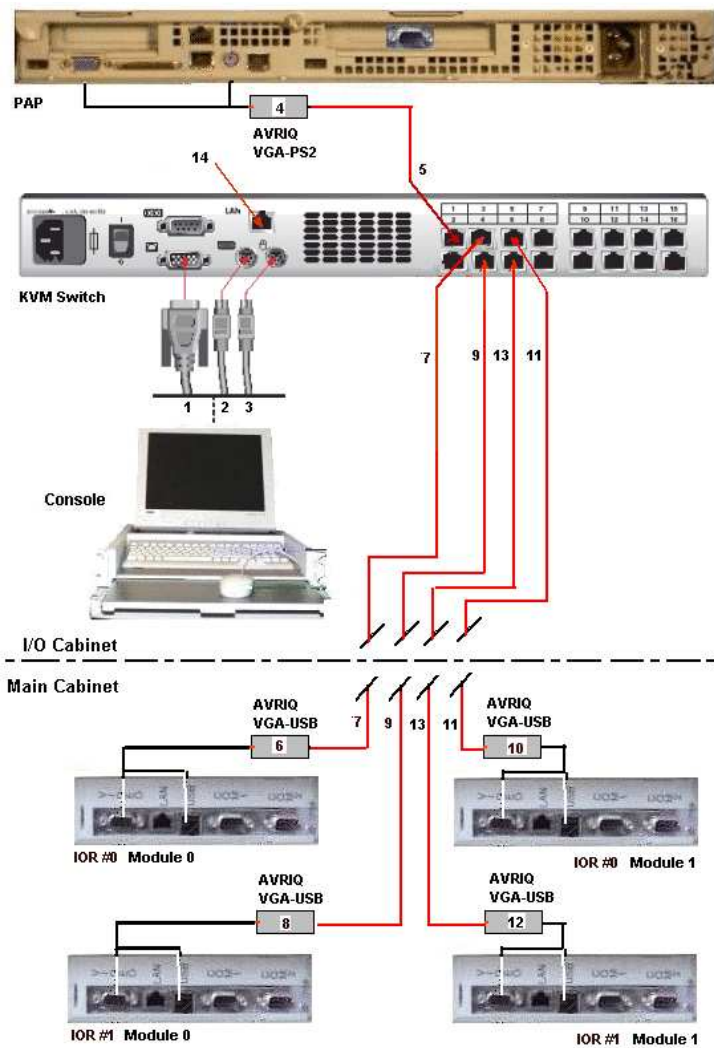

Mark	Cable Type	From	To
1	HD15 video cable	Monitor (blue)	KVM (blue)
2	PS2 mini-DIN6 cable + PS2/PS2 extension cable	Keyboard (mauve)	KVM (mauve)
3	PS2 mini-DIN6 cable + PS2/PS2 extension cable	Mouse (green)	KVM (green)
5	RJ45/RJ45 cable	PAP (VGA and PS2) via AVRIQ (4)	KVM Port 1
7*	RJ45/RJ45 cable	IOR #0 Module 0 VGA and USB via AVRIQ (6)	KVM Port 3
9*	RJ45/RJ45 cable	IOR #1 Module 0 VGA and USB via AVRIQ (8)	KVM Port 4
11*	RJ45/RJ45 cable	IOR #0 Module 1 VGA and USB via AVRIQ (10)	KVM Port 5
13*	RJ45/RJ45 cable	IOR #1 Module 1 VGA and USB via AVRIQ (12)	KVM Port 6
14	RJ45/RJ45 cable	KVM (LAN)	Enterprise LAN

* Inter-cabinet data cable

Figure 205. 16-port KVM switch data cabling diagram (example 2)

IOR

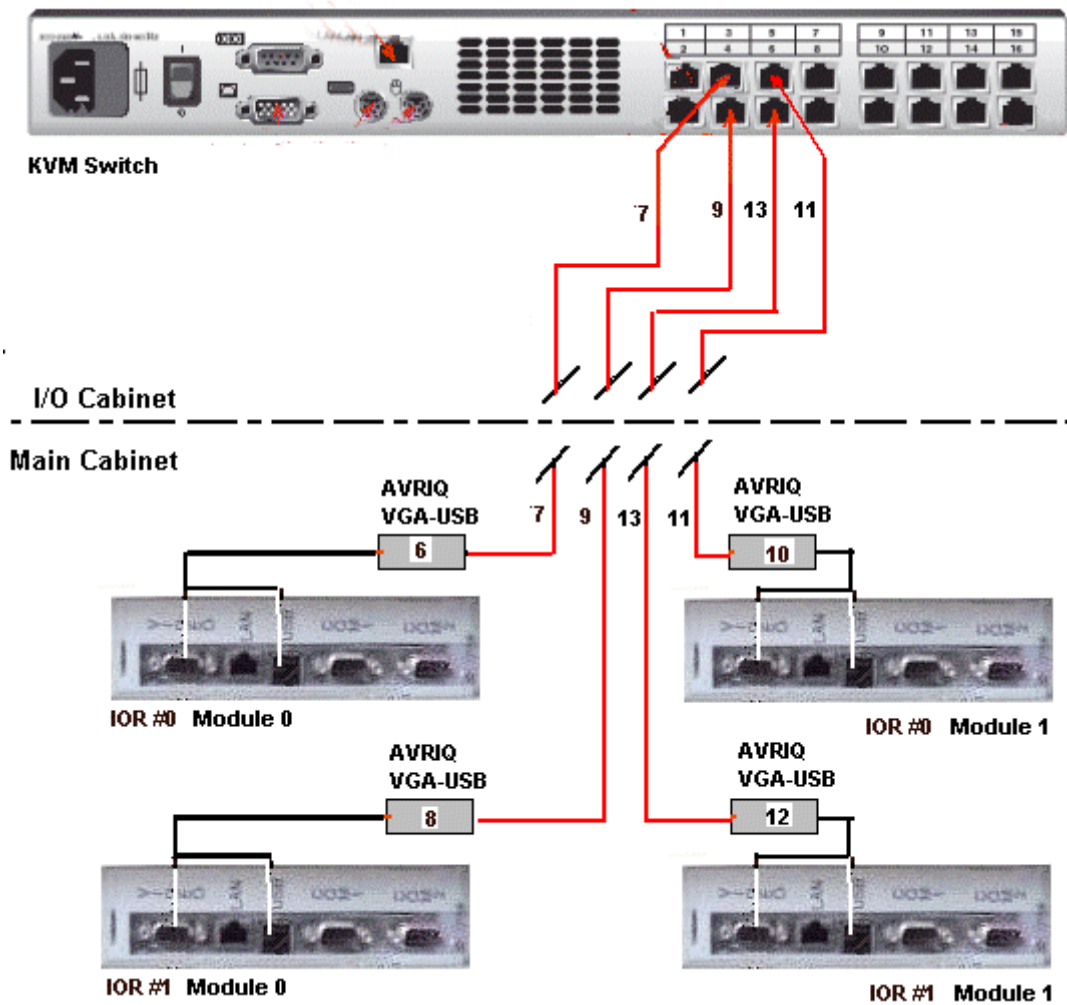

Mark	Cable Type	From	To
7*	RJ45/RJ45 cable	IOR #0 Module 0 VGA and USB via AVRIQ (6)	KVM Port 3
9*	RJ45/RJ45 cable	IOR #1 Module 0 VGA and USB via AVRIQ (8)	KVM Port 4
11*	RJ45/RJ45 cable	IOR #0 Module 1 VGA and USB via AVRIQ (10)	KVM Port 5
13*	RJ45/RJ45 cable	IOR #1 Module 1 VGA and USB via AVRIQ (12)	KVM Port 6

* Inter-cabinet data cable

Figure 206. IOR data cabling diagram (16-port KVM switch)

PAP Unit

2U PAP Unit

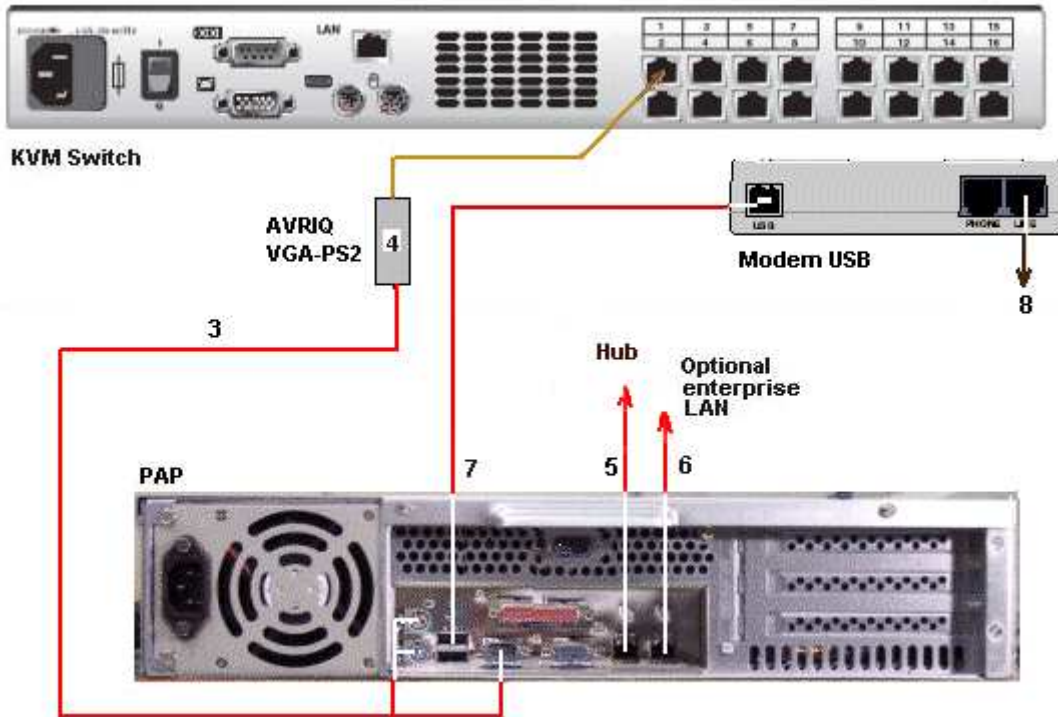

Mark	Cable Type	From	To
3	RJ45 – RJ45 Ethernet cable	PAP (VGA and PS2) via AVRIQ (4)	KVM Port 1
5	RJ45 – RJ45 Ethernet cable	PAP Ethernet	Hub Ethernet
6	RJ45 – RJ45 Ethernet cable	PAP LAN Enter	Enterprise LAN
7	USB cable	PAP USB	Modem USB
8	RJ11 – RJ11 cable	Modem (Line)	Telephone socket

* Inter-cabinet data cable

Figure 207. PAP unit (2U) data cabling diagram

1U PAP Unit

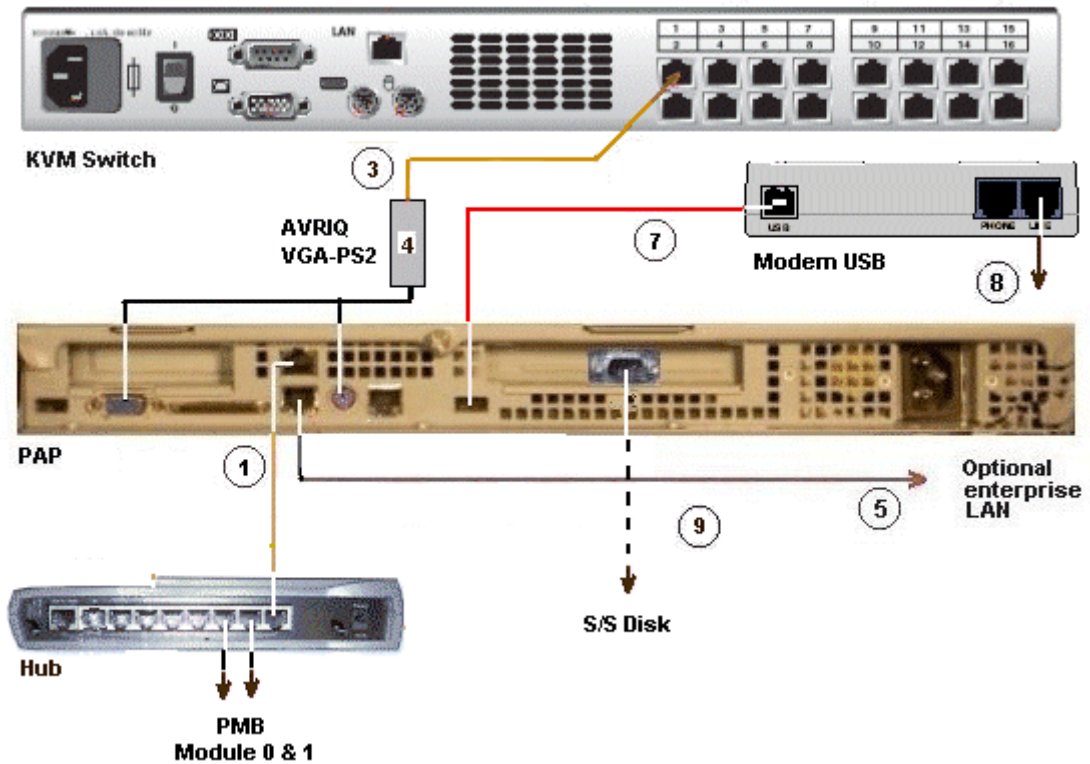

Mark	Cable Type	From	To
1	RJ45 – RJ45 Ethernet cable	PAP Ethernet	Hub Ethernet port 1
2*	RJ45 – RJ45 Ethernet cable	PMB Module 0	Hub Ethernet port 2
3	RJ45 – RJ45 Ethernet cable	PAP (VGA and PS2) via AVRIQ (4)	KVM Port 1
5	RJ45 – RJ45 Ethernet cable	PAP LAN Enter	Enterprise LAN
6*	RJ45 – RJ45 Ethernet cable	PMB Module 1	Hub Ethernet port 3
7	USB cable	PAP USB	Modem USB
8	RJ11 – RJ11 cable	Modem (Line)	Telephone socket
9 #	DB9 to DB9 serial cable *	PAP COM 1	S/S Disk RS232

* Inter-cabinet data cable

optional cable used to configure the disk S/S.

Figure 208. PAP unit (1U) data cabling diagram

Disk Rack (SJ-0812 SCSI JBOD)

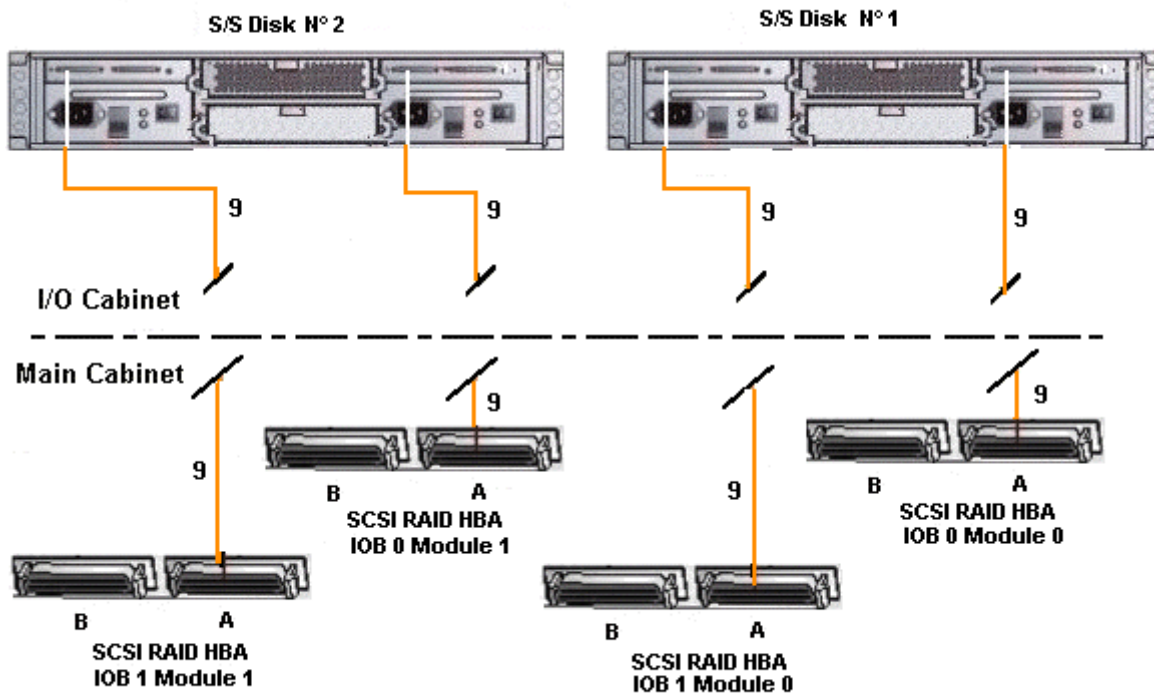

Mark	Cable Type	From	To
9	SCSI-3 68-pin VHDCI to VHDCI cable	HBA SCSI RAID	S/S Disk extension port

Figure 209. SJ-0812 SCSI JBOD disk rack data cabling diagram

Disk Rack (SR-0812 SCSI RAID)

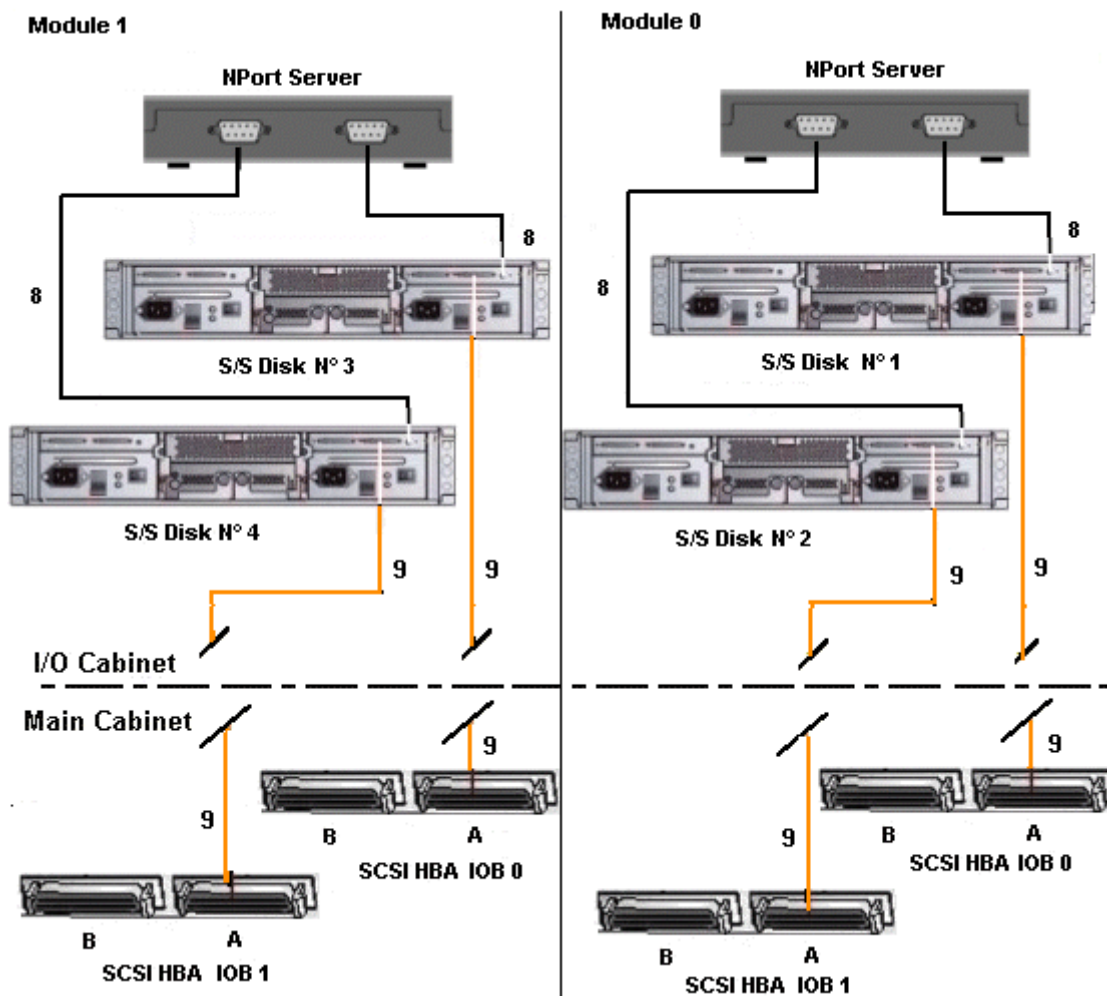

Mark	Cable Type	From	To
8*	DB9 to Jack cable	Nport server	S/S Disk RS232
9	SCSI-3 68-pin VHDCI to VHDCI cable	HBA SCSI	S/S Disk RAID Host port

*cable used to configure the disk S/S.

Figure 210. SR-0812 SCSI RAID disk rack data cabling diagram

Extension Disk Rack (SR-0812 SCSI RAID – SJ-0812 SCSI JBOD)

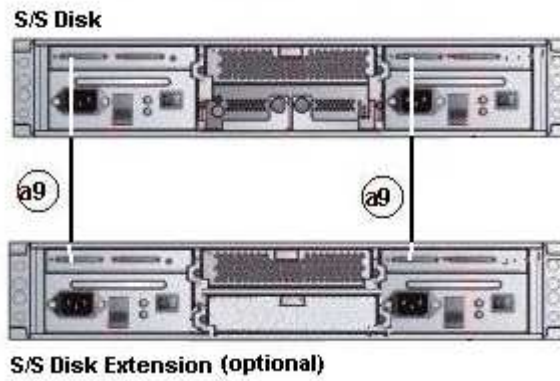

Mark	Cable Type	From	To
a9	SCSI-3 68-pin VHDCI to VHDCI cable	SR-0812 SCSI RAID extension port	SJ-0812 SCSI JBOD extension port

Figure 211. SJ-0812 SCSI JBOD extension disk rack data cabling diagram

NPort Server

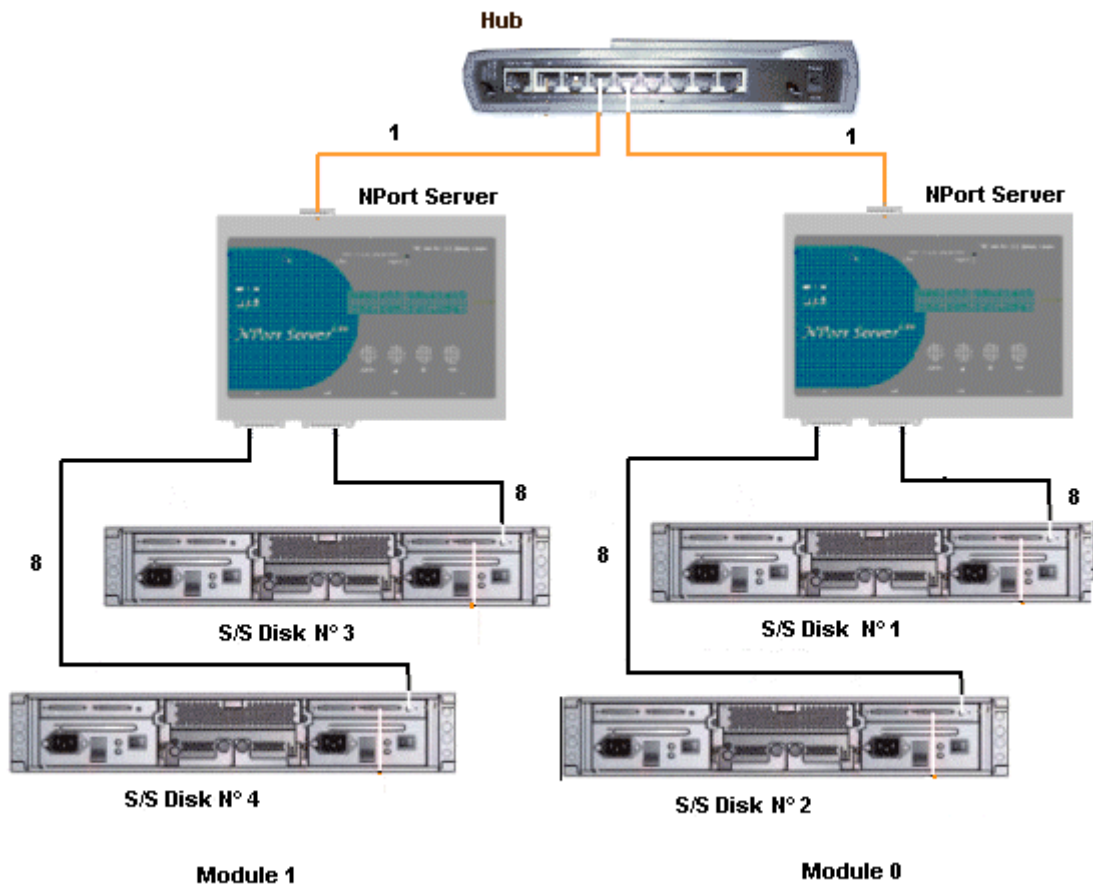

Mark	Cable Type	From	To
1	RJ45 – RJ45 Ethernet cable	Nport Server	Hub
8	DB9 to Jack cable	Nport Server	S/S Disk RS232

Figure 212. NPort Server data cabling diagram

Disk Rack (FDA 1x00 FC)

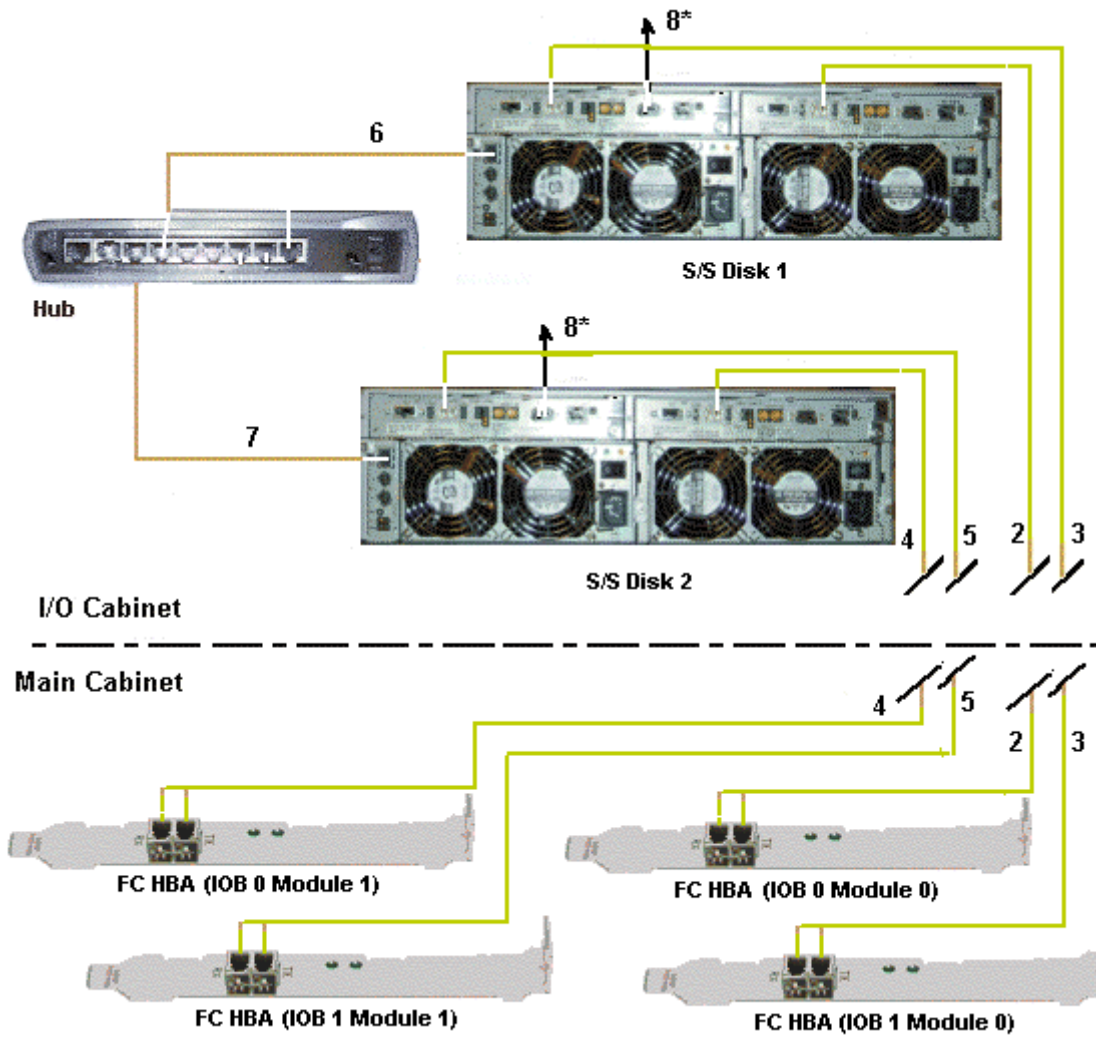

Mark	Cable Type	From	To
2**	LC-LC cable	S/S Disk (CTL 0)	FC Adapter IOB 0 Module 0
3**	LC-LC cable	S/S Disk (CTL 1)	FC Adapter IOB 1 Module 0
4**	LC-LC cable	S/S Disk (CTL 0)	FC Adapter IOB 0 Module 1
5**	LC-LC cable	S/S Disk (CTL 1)	FC Adapter IOB 1 Module 1
6	RJ45 – RJ45 Ethernet cable	S/S Disk	Hub port 6
7	RJ45 – RJ45 Ethernet cable	S/S Disk	Hub port 7
8 *	DB9 to DB9 serial cable	PAP COM 1	S/S Disk RS232

* optional cable used to configure the S/S disk.

** Inter-cabinet data cable

Figure 213. FDA 1x00 FC disk rack data cabling diagram

Extension Disk Rack (FDA 1x00 FC – FDA 1x00 FC)

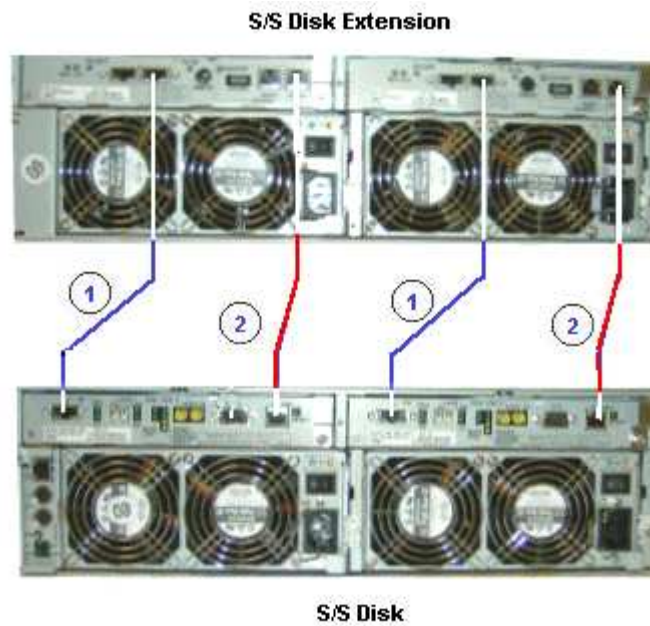

Mark	Cable Type	From	To
1	HSSDC–HSSDC cable	S/S Disk	S/S Disk Extension
2	DE diagnosis cable	S/S Disk	S/S Disk Extension

Figure 214. FDA 1x00 FC – FDA 1x00 FC extension disk rack data cabling diagram

Disk Rack (FDA 2x00 FC)

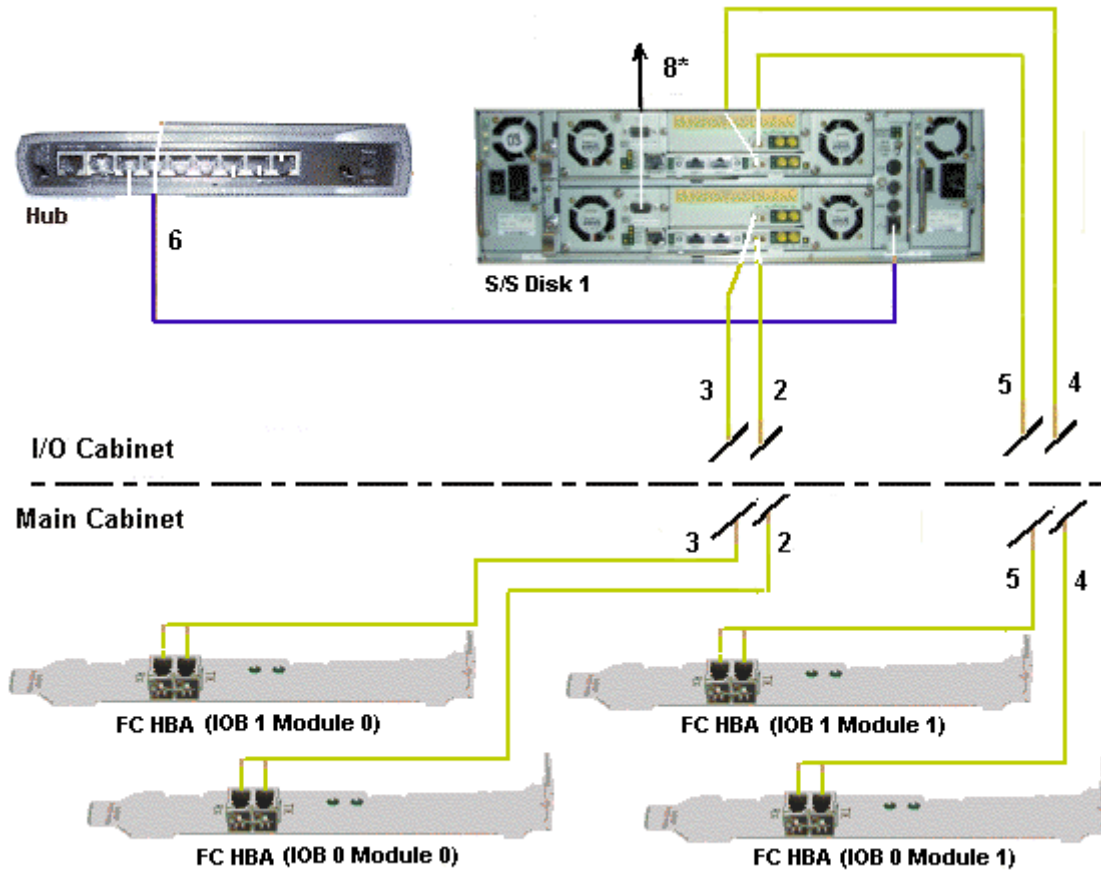

Mark	Cable Type	From	To
2**	LC-LC cable	S/S Disk (CTL0-HF0)	FC Adapter IOB 0 Module 0
3**	LC-LC cable	S/S Disk (CTL0-HF1)	FC Adapter IOB 1 Module 0
4**	LC-LC cable	S/S Disk (CTL1-HF0)	FC Adapter IOB 0 Module 1
5**	LC-LC cable	S/S Disk (CTL1-HF1)	FC Adapter IOB 1 Module 1
6	RJ45 - RJ45 Ethernet cable	S/S Disk	Hub port 6
8 *	DB9 to DB9 serial cable	PAP COM 1	S/S Disk RS232

* optional cable used to configure the S/S disk.

** Inter-cabinet data cable

Figure 215. FDA 2x00 FC disk rack data cabling diagram

Extension Disk Rack (FDA 2x00 FC – FDA 1x00 FC)

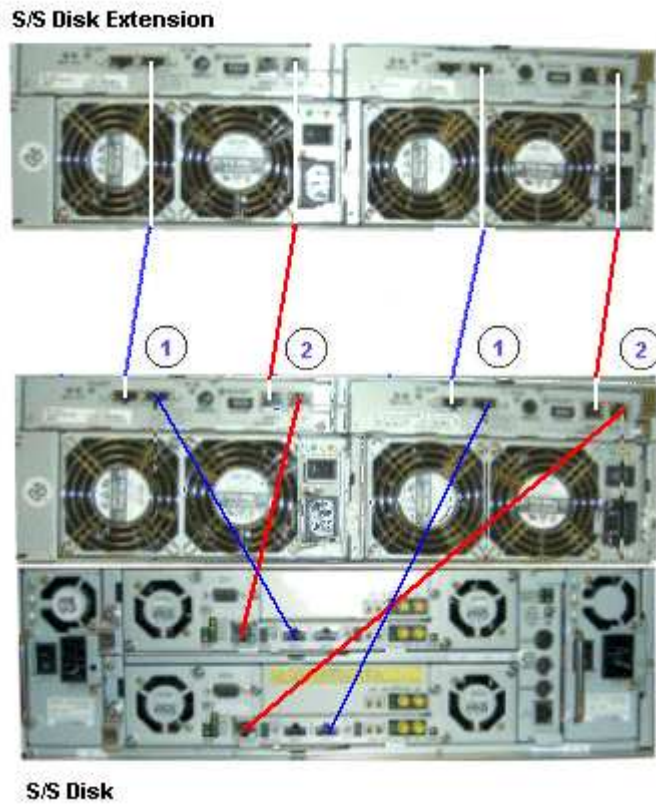

Mark	Cable Type	From	To
1	HSSDC–HSSDC cable	S/S Disk	S/S Disk Extension
2	DE diagnosis cable	S/S Disk	S/S Disk Extension

Figure 216. FDA 2x00 FC – FDA 1x00 FC extension data cabling diagram

PMB

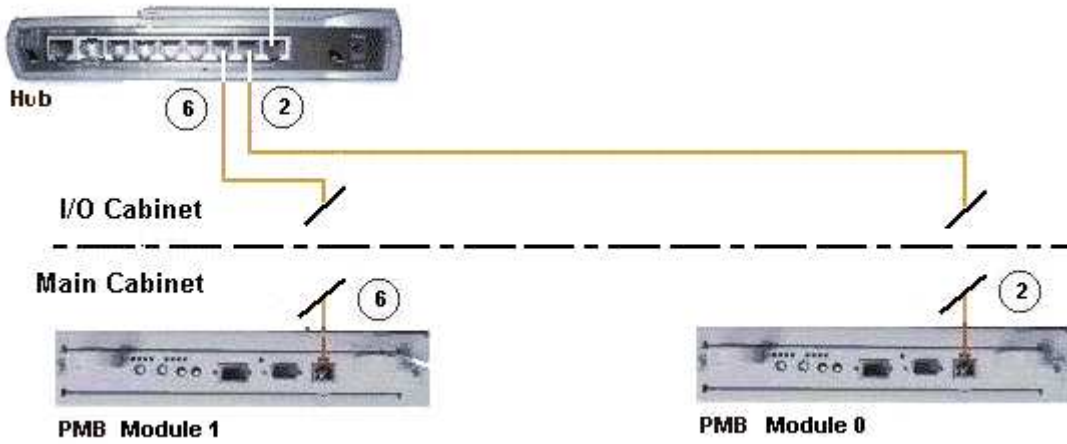

Mark	Cable Type	From	To
2*	RJ45 – RJ45 Ethernet cable	PMB Ethernet Module 0	Hub port 2
6*	RJ45 – RJ45 Ethernet cable	PMB Ethernet Module 1	Hub port 3

* Inter-cabinet data cable

Figure 217. PMB – Hub data cabling diagram

Ethernet Hub

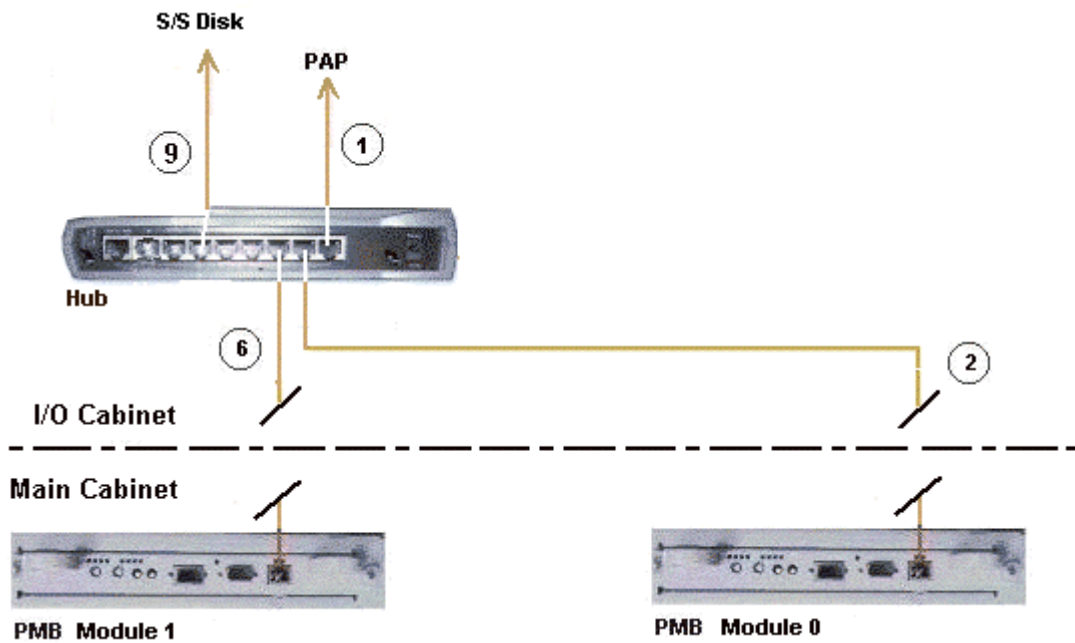

Mark	Cable Type	From	To
1	RJ45 – RJ45 Ethernet cable	PAP Ethernet	Hub port 1
2*	RJ45 – RJ45 Ethernet cable	PMB Ethernet Module 0	Hub port 2
6*	RJ45 – RJ45 Ethernet cable	PMB Ethernet Module 1	Hub port 3
9	RJ45 – RJ45 Ethernet cable	S/S Disk	Hub port 6

* Inter-cabinet data cable

Figure 218. Ethernet hub data cabling diagram

Modem

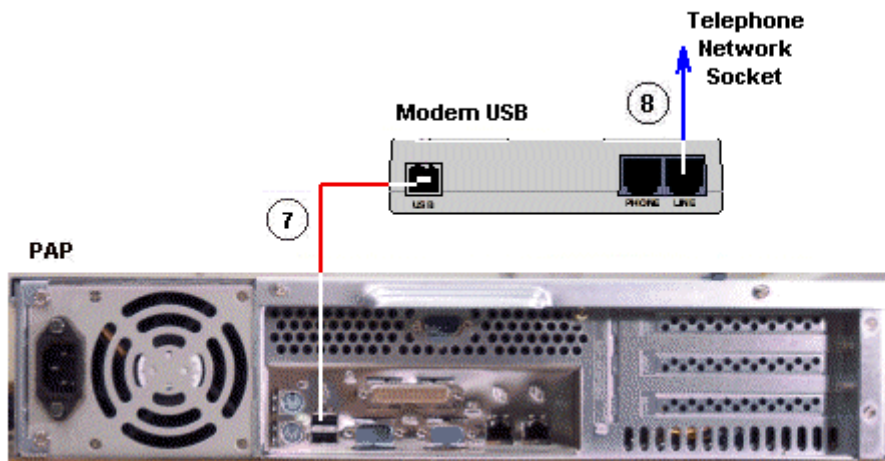
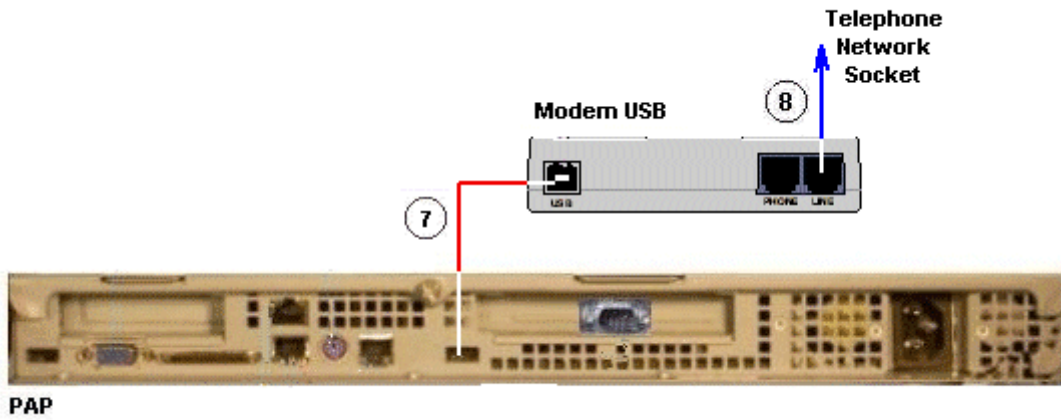

Mark	Cable Type	From	To
------	------------	------	----

Figure 219. Modem data cabling diagrams

Power

The CSS Modules in the main cabinet are equipped with dedicated power supply cables. All other server component power supply cables (in the I/O cabinet) are connected to one or two PDU(s), as shown below:

Main Cabinet

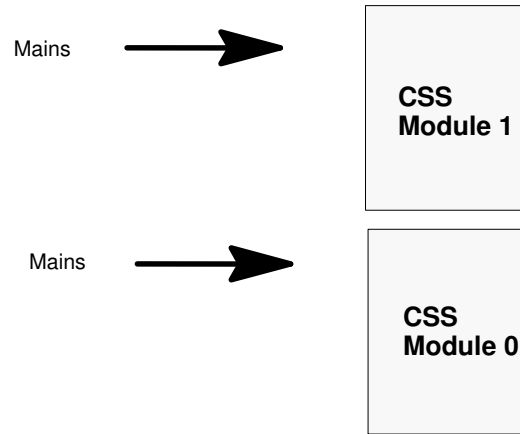
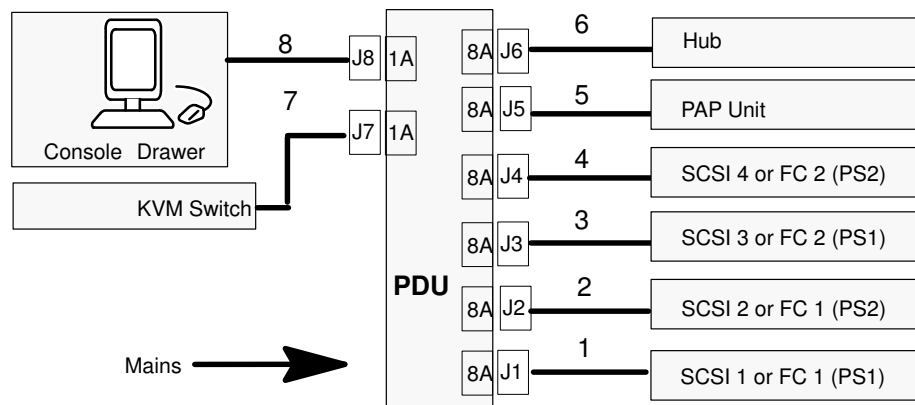

Figure 220. Main cabinet power cabling diagram

I/O Cabinet – Standard Configuration



Mark	Cable Type	From	To
1	Power cable	S/S Disk PWR	PDU J1
2	Power cable	S/S Disk PWR	PDU J2
3	Power cable	S/S Disk PWR	PDU J3
4	Power cable	S/S Disk PWR	PDU J4
5	Power cable	PAP PWR	PDU J5
6	Power cable	Hub	PDU J6
7	Power cable	KVM PWR	PDU J7
8	Power cable	Monitor PWR	PDU J8

Figure 221. I/O cabinet power cabling diagram (standard)

I/O Cabinet – Optional High Availability Configuration

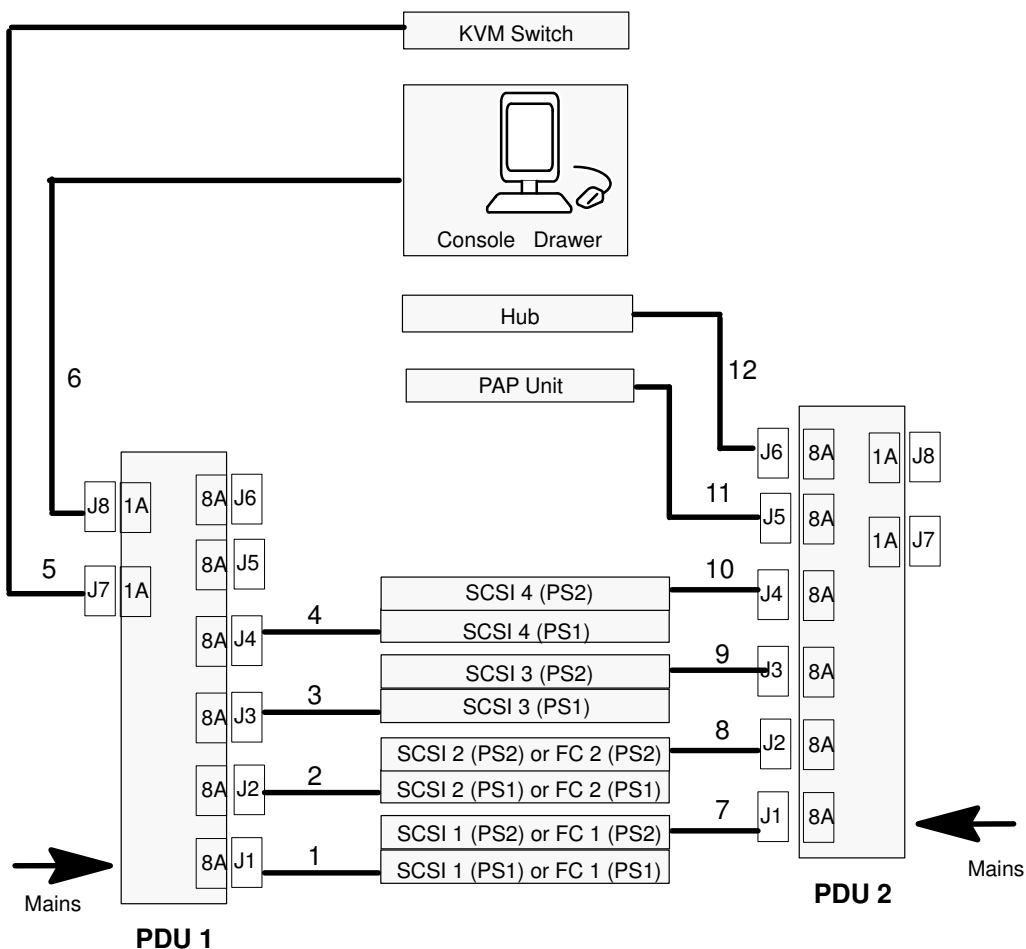

Mark	Cable Type	From	To
1	Power cable	S/S Disk PWR	PDU1 J1
2	Power cable	S/S Disk PWR	PDU1 J2
3	Power cable	S/S Disk PWR	PDU1 J3
4	Power cable	S/S Disk PWR	PDU1 J4
5	Power cable	KVM PWR	PDU1 J7
6	Power cable	Monitor PWR	PDU1 J8
7	Power cable	S/S Disk PWR	PDU2 J1
8	Power cable	S/S Disk PWR	PDU2 J2
9	Power cable	S/S Disk PWR	PDU2 J3
10	Power cable	S/S Disk PWR	PDU2 J4
11	Power cable	PAP PWR	PDU2 J5
12	Power cable	Hub	PDU2 J6

Figure 222. Power cabling diagram

Inter-Cabinet (PMB – Ethernet Hub)

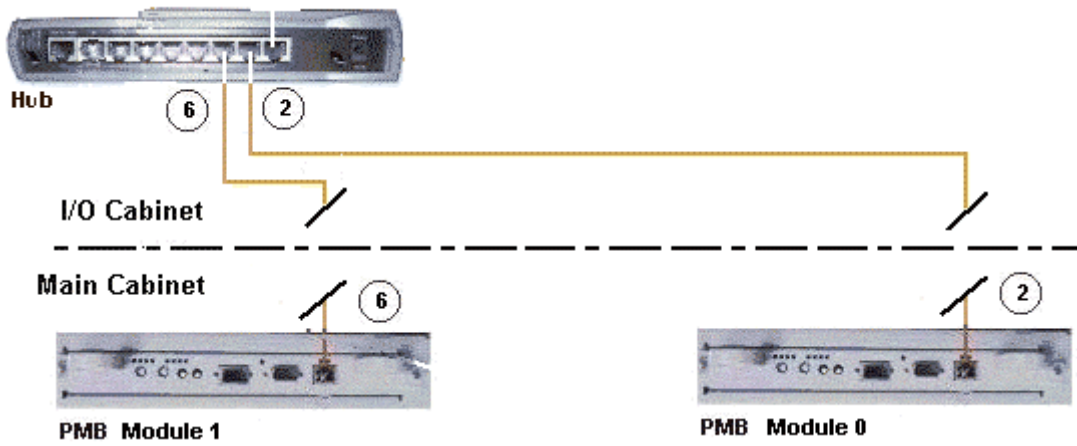

Mark	Cable Type	From	To
2	RJ45 – RJ45 Ethernet cable	PMB Ethernet Module 0	Hub port 2
6	RJ45 – RJ45 Ethernet cable	PMB Ethernet Module 1	Hub port 3

Figure 223. PMB – Ethernet Hub inter-cabinet cabling diagram

Inter-Cabinet (IOR – KVM Switch)

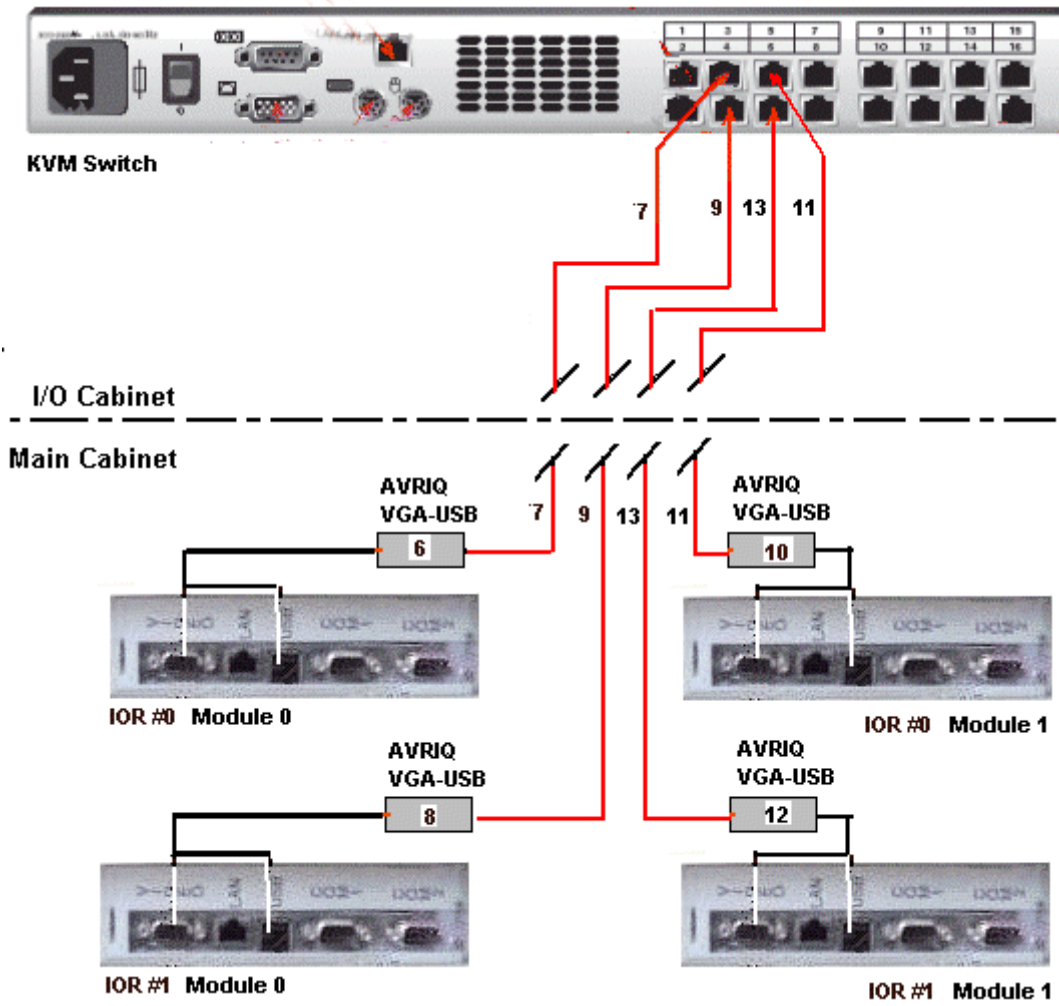

Mark	Cable Type	From	To
7	RJ45/RJ45 cable	IOR #0 Module 0 VGA and USB via AVRIQ (6)	KVM Port 3
9	RJ45/RJ45 cable	IOR #1 Module 0 VGA and USB via AVRIQ (8)	KVM Port 4
11	RJ45/RJ45 cable	IOR #0 Module 1 VGA and USB via AVRIQ (10)	KVM Port 5
13	RJ45/RJ45 cable	IOR #1 Module 1 VGA and USB via AVRIQ (12)	KVM Port 6

Figure 224. IOR – 16-port KVM switch inter-cabinet cabling diagram

Inter-Cabinet (IOB HBA RAID – SJ-0812 SCSI JBOD)

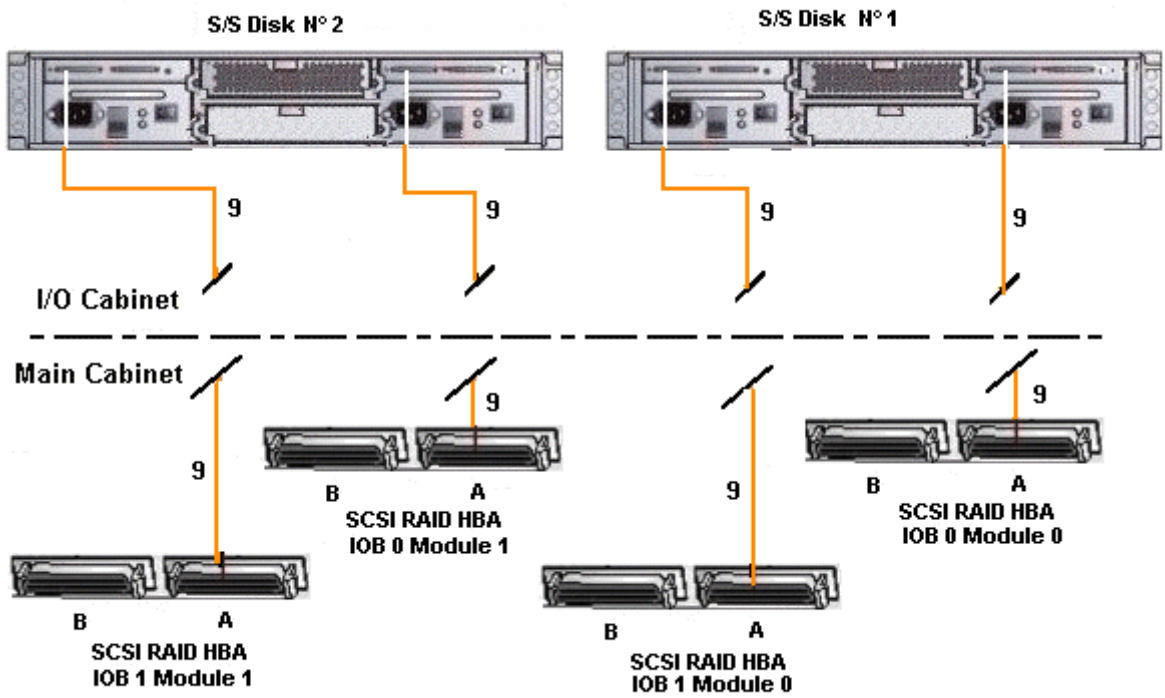

Mark	Cable Type	From	To
9	SCSI-3 68-pin VHDCI to VHDCI cable	HBA SCSI	S/S Disk Host port

Figure 225. IOB HBA RAID – SJ-0812 SCSI JBOD disk rack inter-cabinet cabling diagram

Inter-Cabinet (IOB HBA – SR-0812 SCSI RAID)

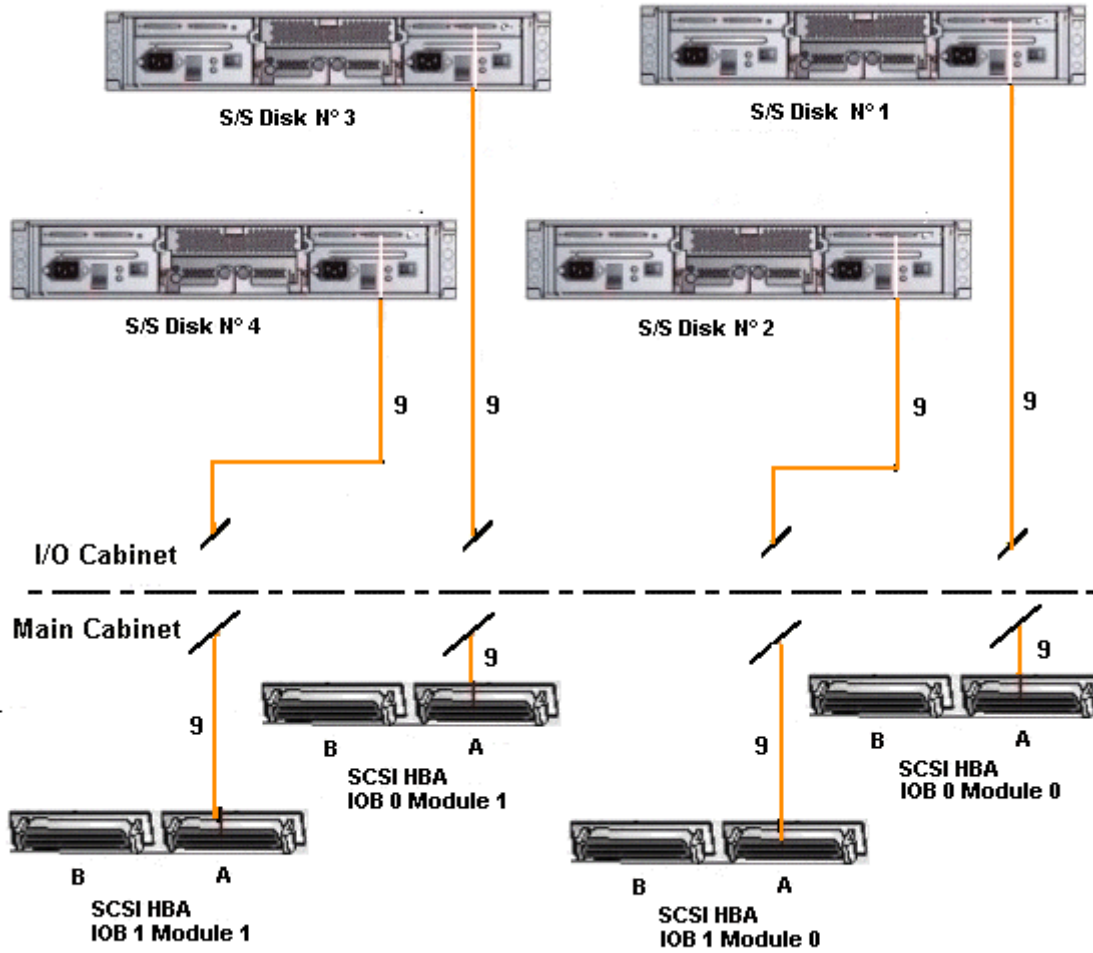

Mark	Cable Type	From	To
9	SCSI-3 68-pin VHDCI to VHDCI cable	HBA SCSI	S/S Disk Host port

Figure 226. IOB HBA – SR-0812 SCSI RAID disk rack inter-cabinet cabling diagram

Inter-Cabinet (IOB HBA – FDA 1x00 FC)

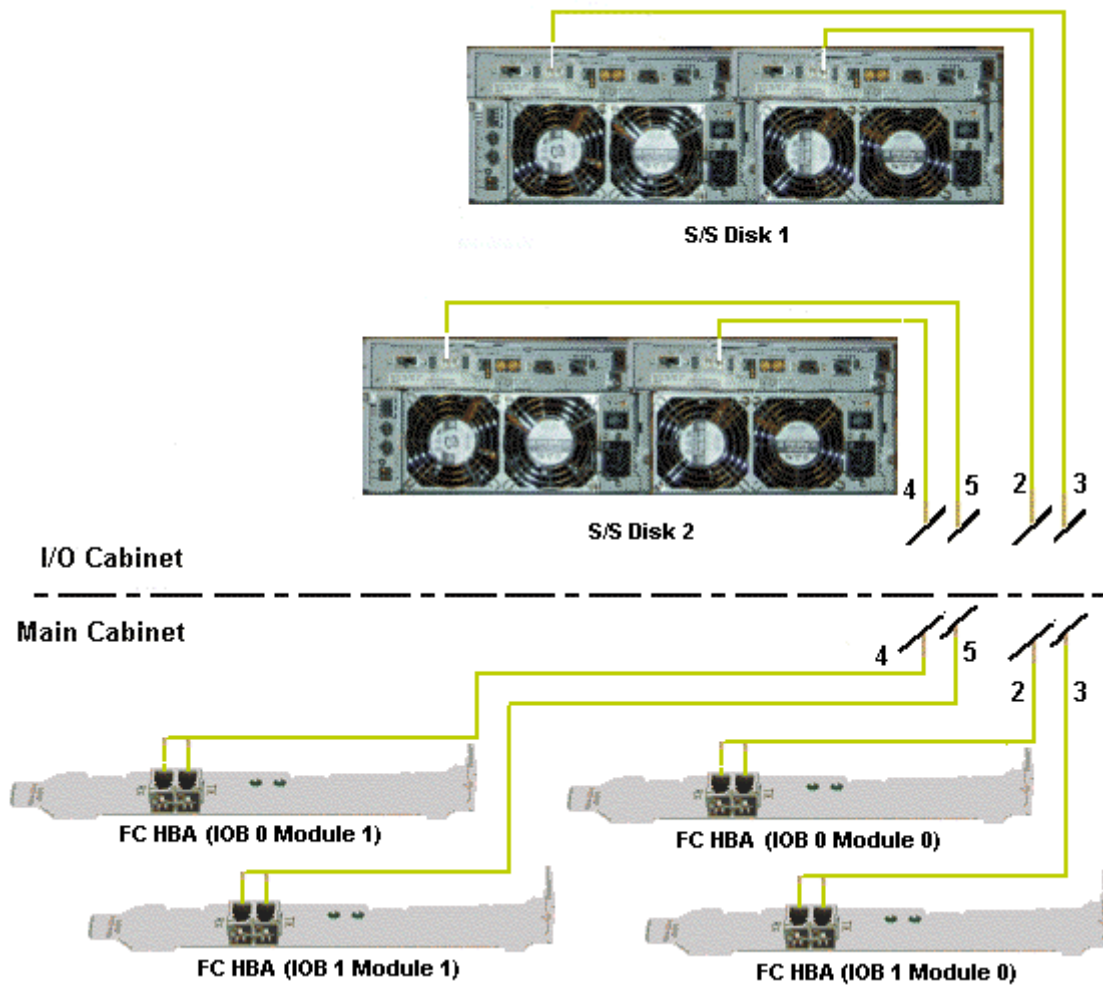

Mark	Cable Type	From	To
2	LC-LC cable	S/S Disk (CTL 0)	FC Adapter IOB 0 Module 0
3	LC-LC cable	S/S Disk (CTL 1)	FC Adapter IOB 1 Module 0
4	LC-LC cable	S/S Disk (CTL 0)	FC Adapter IOB 0 Module 1
5	LC-LC cable	S/S Disk (CTL 1)	FC Adapter IOB 1 Module 1

Figure 227. IOB HBA – FDA 1x00 FC disk rack inter-cabinet cabling diagram

Inter-Cabinet (IOB HBA – FDA 2x00 FC)

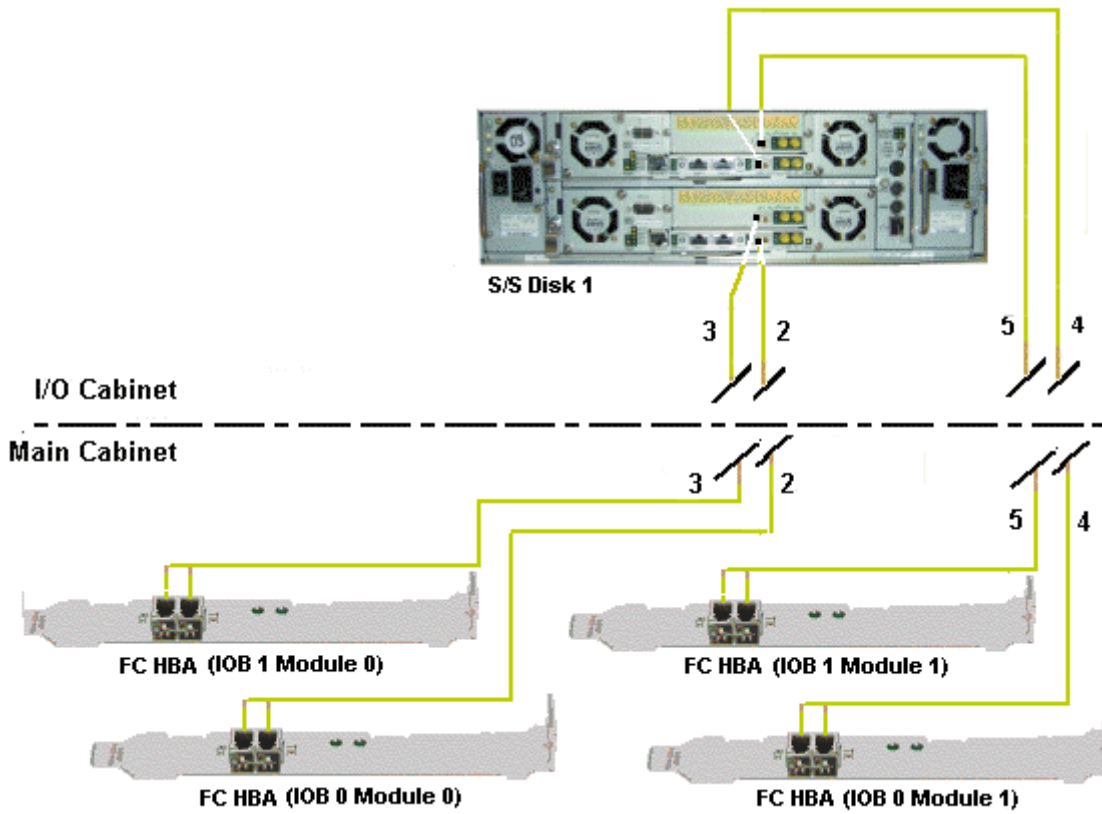

Mark	Cable Type	From	To
2	LC-LC cable	S/S Disk (CTL 0)	FC Adapter IOB 0 Module 0
3	LC-LC cable	S/S Disk (CTL 1)	FC Adapter IOB 1 Module 0
4	LC-LC cable	S/S Disk (CTL 0)	FC Adapter IOB 0 Module 1
5	LC-LC cable	S/S Disk (CTL 1)	FC Adapter IOB 1 Module 1

Figure 228. FDA 2x00 FC disk rack inter-cabinet data cabling diagram

Appendix C. Error Messages and Recovery Information

- ▶ BIOS POST codes, on page C-1
- ▶ BIOS error messages, on page C-2
- ▶ PAM message list, on page C-36

BIOS POST Codes

During initialization, POST codes are generated by the BIOS for each QBB in the configuration. These POST codes may be used for troubleshooting purposes.

Bull NovaScale Server POST codes can be viewed by clicking **BIOS Info** in the PAM **Domain Manager** and are organized as follows:

Code Range	POST Code Module	Page
0x8F80 to 0x8FFF	SAL-A	C-3
0xDEAD0100 to 0xDEAD3300	SAL-A Hang	C-7
0x87D0 to 0x87FF	SAL-B	C-9
0x07D0 to 0x07FF	SAL-B Hang	C-11
0x87B0 to 0x87BF	SAL-F	C-12
0x07B0 to 0x07BF	SAL-F Hang	C-13
0x00D0 to 0x0000	IA32	C-14
0x??2A to 0x??92	DIM Checkpoints	C-24
0x052A0000 to 0x8A2A0	PCI Diagnostic	C-25
0x50XX to 0x5FXX	EFI	C-26
0x4000 to 0x4FFF	ACPI	C-26
0xAA00 to 0xA AFF	Recovery	C-27
0xAF00 to 0xAFFF	Runtime	C-29
0xA000 to 0xA0FF	PAM BIOS commands	C-30

Table 64. BIOS POST code organization



Note:

POST codes are listed in chronological order.

BIOS Error Messages

Error messages are generated by the BIOS when errors are detected during initialization.

Bull NovaScale Server error messages can be viewed from the Windows or Linux operating system and are organized as follows:

Error Messages	Page
Boot Error Messages	C-33
Storage Device Error Messages	C-33
System Configuration Error Messages	C-34
CMOS Error Messages	C-35
Miscellaneous Error Messages	C-35

Table 65. BIOS error message organization

SAL–A POST Codes



Note:

In this document, Post Codes are presented in chronological order.

POST Codes	Meaning
0x8FED	Initialize base memory
0x8FEC	Levelization OK
0x8FEE	Enable SNC ports. Program SNC static registers
0x8FEA	System BSP election (case with SPS)
0x8FD7 (1)	Looks for PEloader (case without SPS)
0x8FD7 (2)	Looks for PEloader (case with SPS)
0x8FCE (1)	Start programming SIOH (case without SPS)
0x8FCE (2)	Start programming SPS, SIOH (case with SPS)
0x8FAE (1)	End programming SIOH (case without SPS)
0x8FAE (2)	End programming SPS, SIOH (case with SPS)
0x8FAD	Execute Autoscan
0x8FAB	Initialize ICH2
0x8FAA	Initialize SIO. Program refresh for fixed delay

Table 66. SAL–A POST codes (before release B600)

POST Codes	Meaning
0x8FFF	Node BSP has been selected
0x8FFD	CVDR/CVCR Programming: a work in progress
0x8FFB	Reset system after CVDR/CVCR programming
0x8FF9	Reset failed after CVDR/CVCR programming
0x8FF7	SNC minimum programming stepping independant
0x8FF5	SNC minimum programming stepping dependant
0x8FF3	FSS (SPS) only: enable SNC scalability ports SP0, SP1
0x8FF2	SNC Set Default SP in SNC_INCO register
0x8FEF	Enter into memory levelization
0x8FE0	Exit from memory levelization
0x8FDF	Initialize temporary backing store and memory stack
0x8FDE	Load IVT into memory, Programm IVA
0x8FDD	SPS only: serialize access thru code running in RAM
0x8FDC	SNC Initialization complete
0x8FDB	Search North Firmware Standard Fit for mandatory modules
0x8FDA	Search North Firmware Extented Fit for mandatory modules

POST Codes	Meaning
0x8FD9	Check if all mandatory modules are available in North Firmware
0x8FD8	Search for the SAL_A extension written in "C" (autoscan)
0x8FD7	Load the SAL_A "C" extension into memory
0x8FCF	Enter into SAL-A "C" extension
0x8FCE	Scan for devices behind SNC scalability ports
0x8FCD	ISPS Path: Initialize CBC registers, NID_DEF registers, Scan SPS SP ports
0x8FCC	Start of processing for SPS based platforms
0x8FCB	SPS Path: Search for SNC and SIOH devices
0x8FCA	SPS Path, SBSP: Initialize REM_CDEFs, SYS_CFGx, SP_OVERx registers (SPS); SPC registers (SNC)
0x8FC9	SPS Path, SBSP: Setup for IOs (SIOH regs, lohmap regs, CbPort regs, PSeg regs)
0x8FC8	SPS Path, SBSP: Initialize IO structure; Run Autoscan algorithm
0x8FC7	Start of processing for BSPS Based platforms
0x8FC6	BSPS Path: Search for BSPS, SNC and SIOH devices
0x8FC5	BSPS Path, SBSP: Disable unused scalability ports on BSPS device; Initialize SNC SPC regs
0x8FC4	BSPS Path, SBSP: Setup for IOs (SIOH regs, CBPort regs, VGAPort regs, PSeg regs)
0x8FC3	BSPS Path: Initialize IO structure; Run Autoscan algorithm
0x8FC2	Start of processing for SIOH based platforms
0x8FC1	SIOH Path: Initialize IO structure, Run Autoscan algorithm
0x8FC0	Exit from SAL-A "C" extension
0x8FBF	Any BSP, SPS: Set Synchronization Point SYNCSPS_C_Ext_Done
0x8FBE	Node BSP, SPS: Wait until Synchronization Point SYNCSPS_C_Ext_Done is cleared
0x8FBD	System BSP, SPS: Wait until all nodes reach Synchronization Point SYNCSPS_C_Ext_Done
0x8FBC	System BSP, SPS: Program all SNC MIR/MIT registers
0x8FBB	System BSP, SPS: Program all SPS MIR registers
0x8FBA	System BSP, SPS: Build memory map
0x8FB9	System BSP, SPS: Flush caches
0x8FB8	System BSP, SPS: Release all nodes from Synchronization Point SYNCSPS_C_Ext_Done
0x8FB7	Node BSP, BSPS: Program all SNC MIR/MIT registers
0x8FB6	Node BSP, BSPS: build memory map
0x8FB5	Node BSP, BSPS: Flush caches

POST Codes	Meaning
0x8FB4	Node BSP, BSPS: Set Synchronization Point SYNCMap_870 (in SNC SPAD register)
0x8FB3	System BSP, BSPS: Wait for NBSPs to reach Synchronization Point SYNCMap_870
0x8FB2	System BSP, BSPS: Initialize snoop filters on BSPS
0x8FB1	System BSP, BSPS: Wait for "other" SBSP to fulfil its duties
0x8FAF	System BSP, BSPS: Select Super-System-BSP (SSBSP)
0x8FAE	Super SBSP, BSPS: Search devices (SNCs, SIOHs, BSPSs)
0x8FAD	SBSP, BSPS: Init CBport and VGAport on all BSPS devices
0x8FAC	Super SBSP, BSPS: Initialize FLOOR/CEILING registers on all BSPS devices
0x8FAB	Super SBSP, BSPS: Update Memory map with data belonging to other nodes
0x8FAA	Super SBSP, BSPS: Flush caches
0x8FA9	Super SBSP, BSPS: Release all nodes from Synchronization Point SYNCMap_870
0x8FA8	Node BSP, BSPS: Wait until Synchronization Point SYNCMap_870 clears to zero
0x8FA7	Super SBSP, both: Build Dimm slot table (behind memory map)
0x8FA6	Reload IVT into memory
0x8FA5	Re-initialize r_bus_dev_snc, r_bus_dev_sncx, r_bus_dev_sps, r_bus_dev_sioh CPU regs
0x8FA4	Common code path for NAPS (procs that did not become NBSP), SAPS (NBSPs that did not become SBSP)
0x8FA3	SAPS check north fw version to south fw version
0x8F9F	Minimum initialization for ICH2/ICH4 chips
0x8F9E	Minimum initialization for LPC 47B27X chip (Super IO) Minimum initialization for 21555 Non-Transparent PCI-to-PCI Bridge
0x8F9D	Update health into memory, Set global memory available flag in SNC SPAD register
0x8F9C	SBSP checks north fw version to south fw version
0x8F9B	Check if recovery needed because of north/south fw mismatch
0x8F9A	Check if recovery forced by OEM recovery switch
0x8F99	Check if recovery jumper set on FW hub
0x8F98	Check if recovery requested thru <ctrl><home> key combination on PS2 keyboard (not used on FAME)
0x8F97	Prepare for recovery (Set flags and clean-up)
0x8F96	Go to firmware recovery
0x8F95	Return to PAL

POST Codes	Meaning
0x8F94	Reset Path: Wait for all processors (hopefully)
0x8F93	Path: Set Recovery and Rest bit in all SNC SPAD registers
0x8F92	Check if all SNCs are Bx steppings or higher
0x8F91	Program MMCFG register of all SNCs
0x8F90	BSP will reset By use of MMCFG interface
0x8F8F	APs wait loop
0x8F8E	Jump to same code in memory (BSP + APs)
0x8F8D	Get data for APs, stored by BSP (BSP + APs)
0x8F8C	Get Recovery module info (thru PELoader, BSP only)
0x8F8B	Load Recovery module into memory (thru PELoader, BSP only)
0x8F8A	Load FW North, South images into memory (thru recovery module execution, BSP only)
0x8F89	Validate FW North image (thru recovery module execution, BSP only)
0x8F88	Validate FW South image (thru recovery module execution, BSP only)
0x8F87	Enable writing into FW hubs (thru recovery module execution, BSP only)
0x8F86	Flash South firmware (thru recovery module execution, BSP only)
0x8F85	Flash North firmware (thru recovery module execution, BSP + APs)
0x8F84	Synchronize all processors, APs wait for reset
0x8F83	Disable writing into FW hubs (thru recovery module execution, BSP only)
0x8F82	Eject Media (thru recovery module execution, BSP only)
0x8F81	Generate system reset (BSP only)
0x8F80	Wait for system reset

Table 67. SAL–A POST codes (for releases B600 and later)

SAL–A Hang POST Codes

POST Codes	Meaning
0xDEAD0100	Unable to levelize local RAM
0xDEAD0200	Wrong chip under SNC (neither SPS, nor SIOH)
0xDEAD0300	PEL module not found, local firmware might be corrupted
0xDEAD0400	South Bridge Vendor ID is incorrect, expected ICH2 or ICH4
0xDEAD0500	Scalability Port 0 presence bit is not set
0xDEAD0600	Scalability Port 1 presence bit is not set
0xDEAD0700	Scalability Port 0 framing failed (Idle Flits Ack. bit is not set)
0xDEAD0800	Scalability Port 1 framing failed (Idle Flits Ack. bit is not set)
0xDEAD0900	Depending on the configuration: – if configuration WITHOUT SPS: SIOH not accessible – if configuration WITH SPS: SPS 1 Vendor ID is incorrect
0xDEAD0A00	SPS 1 Vendor ID is incorrect
0xDEAD0B00	No SIOH could be found
0xDEAD0C00	Master IOB / IOC not found, at least one IOB / IOC should have logical number 0
0xDEAD0D00	Mismatched SPS stepping, expected same stepping for both SPS chips
0xDEAD0E00	Non-transparent Bridge Vendor ID is incorrect, expected 21554 or 21555
0xDEADFF00	CVCR core-to-bus ratio is incorrect, expected 2:8, 2:9, or 2:10
0XDEAD3000	AUTOSCAN module not found, local firmware might be corrupted
0XDEAD3100	Unable to shadow AUTOSCAN module
0XDEAD3200	AUTOSCAN failed
0XDEAD3300	AUTOSCAN Memory Map has too many entries

Table 68. SAL–A hang POST codes (before release B600)

POST Codes	Meaning
0xD000	Failure on SNC SP Checking
0xD001	No Framing on SNC SP0 (idle Flit Ack missing ...)
0xD002	No Framing on SNC SP1 (idle Flit Ack missing ...)
0xD003	No Framing on SNC SP0 and SP1 (idle Flit Ack missing ...)
0xD004	Master abort on SPINCO Read and chip is not a B–SPS
0xD005	Both Scalability ports disabled on SNC
0xD006	Unknown chip found behind SNC!
0xD100	Both Scalability Ports disabled on SNC
0xD101	Neither SIOH nor I–SPS or B–SPS found behind SNC
0xD102	No Firmware Hubs found on compatibility SIOH
0xD103	Autoscan returned an error on SPS based conf

0xD104	Autoscan returned an error on B-SPS based conf.
0xD105	Autoscan returned an error on SIOH based conf.
0xD106	QBB number too large
0xD107	QBB number Multi-defined
0xD108	QBB Number not contiguous
0xD109	No SNC found in system
0xD10A	No Master QBB defined
0xD10B	IOB / IOC number too large
0xD10C	IOB / IOC number Multi-defined
0xD10D	No SIOH found in system
0xD10E	No compatibility IOB / IOC defined
0xD10F	IOBB Number not contiguous
0xD110	Mismatch at SBSP election
0xD111	Too many SNC devices found (FAME A, B, C)
0xD112	Too many BSPS devices found (FAME B, C)
0xD113	Too many SIOH devices found (FAME A, B, C)
0xD114	Unknown device found on Bus 0xfe or 0xff (FAME B, C)
0xD115	Too many BSPS devices found (FAME B, C)
0xD116	Too many SNC devices found (FAME B, C)
0xD117	QBB number too large
0xD118	QBB number Multi-defined
0xD119	Unknown device found on Bus 0xfe or 0xff (FAME A, B, C)
0xD11A	Too many SIOH devices found (FAME B, C)
0xD11B	IOB / IOC number too large
0xD11C	IOB / IOC number Multi-defined
0xD11D	QBB number not contiguous
0xD11E	IOB / IOC number not contiguous
0xD11F	Hub Interface Presence (Bit 8) not set in HLCTL0 of Master SIOH
0xD120	Disable Hub Interface (Bit 2) set in HLCTL0 of Master SIOH
0xD121	No ICH2/4 LPC Device found on Compatibility Bus
0xD122	Levelization did not find any usable memory on QBB
0xD200	Unexpected failure on SPS Scalability Port (Bit i !=0 => Failure on Port i)
0xD300	Unexpected failure on SIOH Scalability Port (Bit i !=0 => Failure on Port i)
0xD400	Unexpected failure on BSPS Scalability Port (Bit i !=0 => Failure on Port i)

Table 69. SAL-A hang POST codes (for releases B600 and later)

SAL-B POST Codes

POST Codes	Meaning
0x87FF	First check point. Initialize cr.iva/ar.eflag/ar.cflg/cr.lrr0/cr.lrr1/cr.ifa/cr.itir
0x87FE	Initialize io_base address, CPU#, health, etc. for CPU's. Initialize min_state_area for all CPUs (cpu_data_base+cpu_bspstore_base+cpu_health) cpu_data_base points to min state save area. TOM below and above 4G. Allocate sal_mp_info_table data and sal_efi stack area and legacy_stack (temp). Initialize legacy stack top and bottom for temporary use during POST only. INT_15, (FN# F788 in EM code) uses INT-8 timer tick for frequency calculation. (BSP+APs) Save ID, EID, Initialize BSPSTORE, SP.
0x87FD	Search FIT for legacy BIOS.
0x87FC	Search for legacy_nvm module (sal_legacy_nvm_module_1d).
0x87FB	Search for efi_nvm module (sal_efi_nvm_module_1e).
0x87FA	Search for acpi_dsdt module (sal_acpi_data_module_16). Ask for Address, size, type.
0x87F9	Search for addition information acpi_dsdt module. Ask for size, align, and scratch buff size.
0x87F8	Search for addition information acpi_dsdt module. Initialize scratch buffer.
0x87F7	Reserve ACPI_64 and ACPI_32 data area. Reserve MP table data area. Save SAL data base & size. SAL shadow top (PELoader + SAL_F).
0x87F6	Cache flush after PEOader shadow.
0x87F5	Search for information on SAL_F module (sal_f_module_12). By size, align, and scratch buff size.
0x87F4	Search for addition information SAL_F module. Initialize scratch buffer.
0x87F3	Cache flush after SAL shadowed.
0x87F2	Initialize SAL data top address Physical equals to virtual for runtime use and above 4G Load Call backs for byte/word checkpoint display entry and Address. SAL PMI address EFI to SAL call back address SAL procedure address SAL SST base and address SAL procedure entry base inside SST Build time address where SAL_PROC entry is stored Build time GP Runtime GP SAL SST size.
0x87F1	Load PAL module.
0x87F0	BSP Shadow PAL module, initialize PAL shadow base, size, proc ptr initialize PAL procedure address entry & checksum AP's PAL PMI base will be set.
0x87EF	Cache flush after PAL shadow.

POST Codes	Meaning
0x87EE	Find PAL shadow size + align through SAL call.
0x87ED	Find # of CPU's present in the system, # of CPU, # of IOAPIC.
0x87EC	Search for addition information EFI module (sal_efi_module_15) size, align, and scratch buff size. Initialize scratch buffer.
0x87EB	Save maximum (PAL, EFI) shadow size and alignment. Save PAL (ia32)/EFI shadow top address, size, alignment. EFI module shadow base address (virtual/Physical), size, bottom address (DATA+SAL+PAL+EFI). Update virtual address entries in translation register descriptor, addresses in MDT/
0x87EA	Cache flush shadow.
0x87E9	PAL call for memory Test for SELF-TEST (pal_mem_for_test_25).
0x87E8	PAL call for PAL test (pal_test_proc_102) and save results.
0x87E7	PAL Call for pal_bus_get_features function # (pal_bus_get_features_09).
0x87E6	Set buslock mask=1 (non-atomic) By PAL Call PAL Bus Set Feature (pal_bus_set_features_0a).
0x87E5	Set PMI entry point PAL Call (pal_pmi_entrypoint_20).
0x87E4	PAL Cache Summary by PAL Call (pal_cache_summary_04).
0x87E3	PAL Cache Information set. PAL Call cache_info_02.
0x87E2	pal_mc_register_mem_1b/find CPU min state pointer. Should be able now to initialize health, bsp/ap, cache size line size, sapic ver, and cpuid. Set minimal state save area, BSPSTORE and SP.
0x87E1	Cache flush shadow.
0x87E0	Program IVA, ITR(0) for PAL, SAL runtime code & data area cr.iva/cr.ifa/cr.itir/itr[r0].
0x87DF	Clear semaphore and wait for all CPUs to synchronize.
0x87DE	Sort CPU health. Already sorted for 2nd level BSP selection. Store BSP/AP flag for respective CPU.
0x87DD	Setup for interrupt wakeup reinitialization of BSPSTORE and SP if needed. Wait for interrupt wakeup. The low order quartets indicate the CPUs of the board which have completed the initialization – Quartet =1 if the CPU has completed its initialization – Quartet =0 if the CPU has not completed its initialization (for instance failure) or if it is CPU absent.
0x87DC	Switch to virtual address Control register programming SET in PSR bn(44), it(36), rt(27), dt(17), ic(13) . Clear task priority register=cr.tpr. Clear interruption function state register=cr.ifs. Set legacy BIOS cs.base and ss.base. Set es, ds, fs, gs=0 with 4G limit Legacy BIOS module (eip). Give control at xxxx:e05b to IA-32 code.

Table 70. SAL-B POST codes

SAL-B Hang POST Codes

POST Codes	Meaning
0x07FD	Then hang, if not found. See 0x87FD. If found copy top 64K legacy boot block ROM at xxxx:0000.
0x07FC	Then hang, if not found. See 0x87FC. Else continue by saving in RAM.
0x07FB	Then hang, if not found. See 0x87FB. Else continue by saving in RAM. Reserve 128k memory for NVM emulation.
0x07FA	Then hang, if not found. See 0x87FA. Else continue by saving in RAM.
0x07F9	Then hang, if not found. See 0x87F9. Else continue by saving in RAM.
0x07F8	Then hang, if not found. See 0x87F8. Else continue by saving in RAM.
0x07F6	Hang, on ERROR. See 0x87F6.
0x07F5	Then hang, if not found or Information ERROR. See 0x87F5. SAL shadow bottom (PELoader + SAL_F). Find SAL_F page size. Align to next 32K boundary and save address and size.
0x07F4	Then hang, if not found. See 0x87F4. Else continue by saving in RAM.
0x07F3	Hang on ERROR. See 0x87F3.
0x07F0	Hang on ERROR. See 0x87F0.
0x07EF	Hang on ERROR. See 0x87EF.
0x07EE	Hang on ERROR. See 0x87EE.
0x07ED	Hang on ERROR. See 0x87ED.
0x07EC	Hang if ERROR. See 0x87EC.
0x07EA	Hang on ERROR. See 0x87EA.
0x07E9	Hang, if Memory ERROR. See 0x87E9.
0x07E8	Hang, if late self test ERROR. See 0x87E8. NOTE: a build switch can skip this.
0x07E7	Hang if ERROR. See 0x87E7.
0x07E6	Hang if ERROR. See 0x87E6.
0x07E5	Hang if ERROR. See 0x87E5.
0x07E4	Hang if ERROR. See 0x87E4.
0x07E3	Hang, if ERROR. See 0x87E3.
0x07E1	Hang if ERROR. See 0x87E1

Table 71. SAL-B hang POST codes

SAL-F POST Codes

POST Codes	Meaning
0x87BF	First check point. Checkpoint in v6b00_83_ip2x. Update EBDA entry inside SST Create EFI memory descriptor Update SST checksum.
0x87BE	Check point near v6b00_83_5 Search FIT for ACPI module (SAL_C_module_17) and get size, align, scratch buff size.
0x87BD	Load image by module type (sal_c_module_17). Use PElLoader.
0x87BC	Load image by module type (sal_c_module_17). Flush cache.
0x87BB	Initialize memory manager (0x0) by call to SAL_C.
0x87BA	Feed system information (0x1) with call to SAL_C.
0x87B9	Initialize MP table v1.4 (0x2) with call to SAL_C
0x87B8	Initialize IA-32 ACPI v1.1 (0x3) with call to SAL_C
0x87B7	Initialize IA64 ACPI v1.1 (0x4) with call to SAL_C
0x87B6	Initialize IA-32&IA64 ACPI v2.0 (0x5) with call to SAL_C
0x87B5	Clear scratch memory (0xFFF) with call to SAL_C
0x87B4	Search FIT for EFI module with call to PElLoader. Get Size, align, and scratch buff size.
0x87B3	Load image by module type (sal_c_module_17).
0x87B2	Flush cache with PAL call.
0x87B1	Build EFI input parameter table. Get EFI stack, bspstore etc. with EFI call.
0x87B0	Build EFI input parameter table. Get EFI stack, bspstore etc. with EFI call. Store EFI stack, bspstore etc. with EFI call. Call EFI and that should be end.

Table 72. SAL-F POST codes

SAL-F Hang POST Codes

POST Codes	Meaning
0x07BE	Hang if ERROR. See 0x87BE.
0x07BD	Hang if not found. Get entry point, and GP value. See 0x87BD.
0x07BC	Hang on ERROR. Build MP & ACPI table. See 0x87BC.
0x07BB	Hang on ERROR. See 0x87BB.
0x07BA	Hang on ERROR. See 0x87BA.
0x07B9	Hang on ERROR. See 0x87B9.
0x07B8	Hang on ERROR. See 0x87B8.
0x07B7	Hang on ERROR. See 0x87B7.
0x07B6	Hang on ERROR. See 0x87B6.
0x07B5	Hang on ERROR. See 0x87B5.
0x07B4	Hang on ERROR. Get entry point, and GP value. See 0x87B4.
0x07B3	Hang on ERROR. Get entry point, and GP value. See 0x87B3.
0x07B2	Hang on ERROR. See 0x87B2.
0x07B1	Hang on ERROR. See 0x87B1.
0x07B0	Hang on ERROR if OK come back from EFI. See 0x87B0.

Table 73. SAL-F Hang POST Codes

IA-32 POST Codes

IA-32 POST Codes	Meaning
0x00D0	Starting POINT control from SAL Set direction. Create Stack. Next checkpoint 0x00D5.
0x00D5	Get address and size of legacy BIOS. Clear the BootBlock flag. Next checkpoint 0x00D6.
0x00D6	Form the ROM image in memory. Next checkpoint 0x00D7.
0x00D7	Search for compressed RUNTIME interface module. If not found HANG checkpoint 0x00DE, else next checkpoint 0x00D8.
0x00D8	Decompress RUNTIME module to RAM segment. If not found HANG checkpoint 0x00DE, else next checkpoint 0x00D9.
0x00D9	Copy uncompressed RUNTIME to F000 shadow RAM. Copy E000 ROM segment to scratch RAM segment. Copy scratch segment to E000 shadow RAM. Next, Give control to shadow with far jump to F000:FFF0 for wake-up (checkpoint 0x0003).
0x00DE	Hang for fatal error.
Reset vector	Check for hard or soft reset. If hard reset => disable NMI, go to checkpoint 03h. If soft reset => disable NMI, reset shutdown type to hard reset. Initialize interrupt controller (8259) depending on shutdown type in CMOS. Next, checkpoint 0x0003.
0x0003	Disable video. Clear base 640K memory. Enable F000 shadow RAM (ALWAYS Shadowed). Start initialization of Runtime POST Setup (RPS) module header structure. Go to checkpoint 0x0005.
0x0005	Disable USB host controller, disable all cache (CACHE is ALWAYS ON). Next, checkpoint 0x0006.
0x0006	Copy code to lower RAM segment. Copy old F000 ROM (ROM always at 4GB) to shadow RAM. Initialize PMM structures for later data memory allocation. Initialize SDSM (Setup Data Storage Manager) structure for allocating CMOS to Setup. Decompress POST module. Finish initialization. Fill in POST, runtime, and INT13 interface information into POST module header. Pass control to POST. Initialize GPNV area. Decompress Debug module if present. Decompress DIM module. Store Runtime, POST, and INT13 interfaces into RPS module header. Uncompress INT10 module. Copy DIM to shadow. Next, checkpoint 0x0008.

IA-32 POST Codes	Meaning
0x0008	Check CMOS diagnostic byte to determine if battery power is OK and set error flags if necessary. Verify CMOS checksum manually by reading storage area, if not O.K. load with power-on default values and clear password. Clear CMOS pending interrupt. Initialize Status Registers A in CMOS. Next, checkpoint 0x0007.
0x0007	Initialize the BIOS update data area (BUP), and update the communication vector between BIOS and INT13. Initialize RT_CMOS_BYTE. INITIALIZES INT13 interrupt service routine to just return. Next, checkpoint 0x000B.
0x000B	Perform any necessary initialization before the keyboard controller BAT command test. Next, checkpoint 0x000C.
0x000C	The keyboard controller input buffer is free. Next, issue BAT command and read result. If bad 8042 then HALT! Next, checkpoint 0x000Eh.
0x000E	The keyboard controller BAT command result has been verified. Next, perform any necessary initialization after the keyboard controller BAT command test. Next, checkpoint 0x000F.
0x000F	Enable keyboard controller command byte, enable mouse if supported. Next, checkpoint 0x0011
0x0011	Check if <Ins>, , or <End> key has been pressed, get POST information. Destroy CMOS checksum and set CMOS checksum error bit if indicated by POST information. Next, checkpoint 0x0012.
0x0012	Initialize CMOS and checksum with default values if END is pressed, "Initialize CMOS in every boot" flag is set, or OEM method flag is set. Disable #1 & #2 DMA controllers, disable #1 & #2 interrupt controllers, reset video display EGA and monochrome devices. Next, checkpoint 0x0013.
0x0013	Program chipset registers using POST tables, save good/bad cache status to CMOS. Check for or OEM alternate key to enter setup. The DEL key is also checked in the majority of the checkpoints from checkpoint 13h to checkpoint 85h. Initialize the chipset. Next, checkpoint 0x0014.
0x0014	8254 PIT timer test on channel 2. The checking for the key press between here and checkpoint 27h. Will determine if Setup is invoked at checkpoint 0x0087 for legacy keyboards only. USB keyboards are initialized than. Next, checkpoint 0x0019.
0x0019	Initialize system timer and check refresh toggle. HALT! If refresh toggle error. Next, checkpoint 0x001A.
0x001A	Read and compare high/low timing for refresh toggle. If not within acceptable limits, HALT! Clear parity status, if any. Next, checkpoint 0x0023.

IA-32 POST Codes	Meaning
0x0023	Read the 8042 input port and save switch setting, check for green KBC, and disable the keyboard controller password. Performing any necessary configuration before initializing the interrupt vectors. Next, checkpoint 0x0024.
0x0024	Perform any OEM specific initialization before interrupt vector initialization. Interrupt vector initialization is about to begin. Next, checkpoint 0x0025.
0x0025	Initializes interrupt vector table. Test for POST diagnostics, Clear passwords if POST flag is set. Indicate 25 video rows and monochrome display in BIOS data area. Next, checkpoint 0x0027.
0x0027	Enable USB function/clock in chipset if necessary and if configurable, initialize USB, and perform any necessary chipset or OEM initialization. Next, checkpoint 0x0028.
0x0028	Set monochrome and color mode video settings. Set 40 x 25 text / CGA color display mode. Next, checkpoint 0x0029.
0x0029	Jump to debugger hook, clear parity status (parity will be by IA64 part). Diamond VGA option ROM bug fix. Next, checkpoint 0x002A.
0x002A	Initialize different buses through DIM module. See <i>DIM Code Checkpoints</i> section of document for more information. Initialize INT 40 vector to proper location (PCI SCSI adapter fix). Initialize video. Make F00 shadow RAM write enabled (ALWAYS READ/WRITE). If VGA device was found and initialized by BIOS, go to checkpoint 0x002D, else next checkpoint 0x002B.
Note that there will be 15-bit post codes in this area. These indicate Device Initialization Manager sub-codes.	The convention for the DIM POST codes is as follows: Port 80 = 0x2A Port 81 = DIM Function number DI number
0x002B	Passing control to the video ROM to perform any required configuration before the video ROM test. Check to see if Option ROM scan should be performed. If no, go to checkpoint 0x002D. If yes, next checkpoint 0x002Ch.
0x002C	Scan video ROM segment (C000) for option ROM. If found, pass control for video initialization. Next, checkpoint 0x002D.

IA-32 POST Codes	Meaning
0x002D	<p>The video ROM has returned control to BIOS POST Performing any required processing after the video ROM had control. Uncompress and initialize ADM (Advanced Display Manager) module.</p> <p>If ADM not available HALT! Uncompress and initialize small BIOS and/or silent logos, detect and reset mouse, perform any required chipset or OEM initialization processing after video ROM initialization.</p> <p>Establish link for console Redirection.</p> <p>Next, checkpoint 0x002E.</p>
0x002E	<p>NMI off, clear parity status (IA64 now responsible), check video interrupt segment to see if video ROM found. If ROM found, check diagnostics status byte in CMOS, set new video mode. Next, checkpoint 37h. If no ROM found, check good/bad status of CMOS. If good, read display adapter type from CMOS and set in BIOS data area. If bad, assume monochrome display and set in BIOS data area.</p> <p>Next, checkpoint 0x002F.</p>
0x002F	<p>EGA/VGA controller not found, so do display memory read/write test, if error go to checkpoint 0x0031.</p> <p>Next, checkpoint 0x0030h.</p>
0x0030	<p>Horizontal and vertical refresh-retrace test. If color or monochrome card found go to checkpoint 0x0034.</p> <p>Else, next checkpoint 0x0031.</p>
0x0031	<p>The display memory read/write test or refresh-retrace test failed, so do alternate display memory read/write test, if error go to checkpoint 0x0034h.</p> <p>Next, checkpoint 0x0032.</p>
0x0032	<p>Horizontal and vertical refresh-retrace test. If card not found give memory error beep.</p> <p>Next, checkpoint 0x0034.</p>
0x0034	<p>Display check complete. Set the detected display mode and size.</p> <p>Next, checkpoint 0x0037.</p>
0x0037	<p>Displaying the power on message next. Uncompress OEM logo code/data if silent boot enabled, enable timer interrupt, display OEM logo or BIOS POST screen depending on setup.</p> <p>Next, checkpoint 0x0038.</p>
0x0038	<p>Initialize the boot input, IPL, and all other general devices. Enable writes to F000 RAM (ALWAYS READ/WRITE). Detect the presence of a USB mouse. Check NVRAM and flash part, display "O.K./fail" message. Initialize ATA channel and reset hard disk controller. Uncompress HHF module and initialize with setup selected values.</p> <p>Next, checkpoint 0x0039.</p>
0x0039	<p>Display any errors reported by DIM. See <i>DIM Code Checkpoints</i> section of document for more information. Display USB devices found. Display any chipset or OEM message strings before memory size display.</p> <p>Next, checkpoint 0x003A.</p>
<p>Note that there will be 15-bit post codes in this area. These indicate Device Initialization Manager sub-codes.</p>	<p>The convention for the DIM POST codes is as follows: Port 80 = 0x38 and 0x39 Port 81 = DIM Function number DI number</p>

IA-32 POST Codes	Meaning
0x003A	Display message to press a key Hit or OEM defined key to enter set-up. Display entering setup message "Entering Setup" if DEL key has been pressed. Next, checkpoint 0x0040.
0x0040	Check for <ESC> or keys to limit wait for key press. The DEL and ESC keys are also checked in the majority of the checkpoints from checkpoint 0x0040 to checkpoint 0x0059. Initialize the global data area with variables used during quick boot and tick sound. Next, checkpoint 0x0042.
0x0042	Check for <ESC> or key press. Next, checkpoint 0x0043.
0x0043	Check for <ESC> or key press. Enable timer interrupt if POST diagnostics disabled. Next, checkpoint 0x0045.
0x0045	Get #of 64ks below and above 1M. Next, checkpoint 0x004B.
0x004B	Check for <ESC> or key press. If found, set bit to run setup later. Check for <Ctrl Alt Del>. If found, set flag go to checkpoint 0x004C.
0x004C	Check for <ESC> or key press. Display total memory size. Delay for MAX of 5 seconds checking for <ESC> or key press every 10milliseconds. This is so one can see the Display message to press a key Hit or OEM defined key to enter setup. Display entering setup message "Entering Setup" if DEL key has been pressed Next, checkpoint 0x0052
0x0052	Store extended memory to CMOS [31], [30] in KB units. Store extended memory to CMOS [36], [35] in 1M units. Next, checkpoint 0x0053.
0x0053	Check for key press. Clear parity error bit. Next, checkpoint 0x0054.
0x0054	Disable parity and NMI. Update base memory, extended memory, and checksum in CMOS if <END> key press has been detected or initialize CMOS in every boot flag is set. Next, checkpoint 0x0057.
0x0057	Check for key press. Adjust base and/or extended memory for memory hole programming. Save extended memory size in bytes to POST Memory Manager [gs:pmm_last_extended_address]. Next, checkpoint 0x0058.
0x0058	Check for key press. Next, checkpoint 0x0059.
0x0059	Enable timer interrupt if POST diagnostics disabled. Reset DMA#1 and DMA#2; Determine if DMA controller should be tested or if DMA registers should be preserved. If testable disable DMA controllers, and test DMA controllers (Perform port pattern test on DMA registers). If DMA error found, HALT! Next, checkpoint 0x0060.

IA-32 POST Codes	Meaning
0x0060	The DMA page register test passed. Test DMA#1 Registers. If error found, display DMA error string. HALT! Next, checkpoint 0x0062.
0x0062	The DMA controller 1 base register test passed. Test DMA#2 Registers. If error found, display DMA error string. HALT! Next, checkpoint 0x0065.
0x0065	The DMA controller 2 base register test passed. Enable DMA#1, enable DMA#2, and initialize DMA #1 and DMA #2. Next, checkpoint 0x0066.
0x0066	Completed programming DMA controllers 1 and 2. Clear DMA#2 write request register. Read PIC #1 and #2 mask registers and save. Initialize 8259-interrupt controller. Restore PIC#2 mask. Restore PIC#1 mask with timer and video interrupts enabled. Next, checkpoint 0x007F.
0x007F	Check for key press. Next, checkpoint 0x0080.
0x0080	Check for key press. Mouse initialization of PS/2 mouse to program the IRQ level to edge triggered or level triggered. Next, checkpoint 0x0081.
0x0081	Check for key press. The keyboard test has started. Clearing the output buffer and checking for stuck keys. Next, checkpoint 0x0083h.
0x0083	Disable parity and NMI. Check battery/checksum status in CMOS. If battery checksum OK, go to set/reset memory expansion bit at checkpoint 0x0084. If battery/checksum error, then check for CMOS memory size mismatch error. If yes, go to checkpoint 0x0084. If no, then update base/extended memory in CMOS and checksum. Go to set/reset memory expansion bit at checkpoint 0x0084.
0x0084	Test and initialize the keyboard. Initialize keyboard circular buffer. Compare base and extended memory size with value in CMOS. Set memory error bit if memory mismatch. Set/reset memory expansion bit. Allocate EBDA. Uncompress INT13 module into memory. Give control to INT13 initialization code. Initialize ATA/ATAPI data area. Detect presence of a floppy. Call DIM module to scan and initialize BBS option ROM's. See <i>DIM</i> . Next, checkpoint 0x0085.

IA-32 POST Codes	Meaning
Note that there will be 15-bit post codes in this area. These indicate Device Initialization Manager sub-codes.	The convention for the DIM POST codes is as follows: Port 80 = 0x84 Port 81 = DIM Function number DI number
0x0085	Display error messages. Display F1/F2 message if bad CMOS Wait for F1/F2 or key press. Determine whether setup can be executed according to POST flag. Load CMOS and GPNV default values if F2 was pressed and go to checkpoint 0x0089. If F1 or pressed, go to Setup (checkpoint 0x0086). Determine if user wants and is permitted to enter setup (Check password 3 times in valid CMOS) and force display back to BIOS. Set up printer values to allow Print Screen to work in setup. Reset the mouse if a USB mouse is present. Next, checkpoint 0x0089 if not going to setup.
0x0086	Perform OEM necessary programming before CMOS SETUP. Next, checkpoint 0x0087.
0x0087	Uncompress and run CMOS SETUP program if POST diagnostics disabled. Skip Setup if POST diagnostics enabled. If Setup saved, then reboot , else readjust display mode and display wait message. Next, checkpoint 0x0088.
0x0088	Perform OEM necessary programming after CMOS SETUP. Next, checkpoint 0x0089.
0x0089	Check if KB locked, if so reboot, else enable BIOS POST display or OEM logo, whichever selected. Display "WAIT" message. Next, checkpoint 0x008B.
0x008B	De-allocate HHF (Hardware Health) memory if enabled. Initialize boot device priority order. Next, checkpoint 0x008C.
0x008C	Perform any chipset or OEM initialization after CMOS setup even if not executed. Several items initialized are the INT15 E820 table, chipset and I/O setup parameters. Next, checkpoint 0x008D.
0x008D	Call optional OEM patch. Set printer and RS232 time-out values in BIOS data area. Next, checkpoint 0x0095.
0x0095	Check and load unattended password. Restore display from silent mode to BIOS. Initialize the boot device order and associated variables. Next, checkpoint 8Eh.

IA-32 POST Codes	Meaning
0x008E	<p>Uncompress INT 13 module. If module not found, go to checkpoint 0x0093.</p> <p>Update BIOS to INT 13 communication segment. Build INT 13 module header. Update communication between POST, Runtime, and INT 13. Check whether to initialize floppy or not. Next, checkpoint 0x0093.</p>
0x0093	<p>Test for SCSI boot. If yes SCSI boot, scan for option ROMs, activate ADM if not already activated, initialize SCSI drive numbers in BIOS data area, and continue on. If no SCSI boot, pass control to INT 13 module initialization code. Next, checkpoint 0x008F.</p>
0x008F	<p>Initialize the floppy disk drive including initializing the global data area, setting interrupt vectors, and sensing drive type and setting disk state accordingly. Initialize AFD variables. Check for valid CMOS. Next, checkpoint 0x0091.</p>
0x0091	<p>Initialize ATA/ATAPI devices and associated variables. Next, checkpoint 0x0092.</p>
0x0092	<p>Initialize I2O devices and associated variables, if enabled in Setup (CMOS). Adjust AFD variables. Call DIM module to scan and initialize option ROM's. See <i>DIM Code Checkpoints</i> section of document for more information. Return control from INT 13 module. Initialize IDE drives in BIOS data area. Activate ADM if not already active. Make F000 RAM write enabled (ALWAYS READ/WRITE). Next, checkpoint 0x0096.</p>
Note that there will be 15-bit post codes in this area. These indicate Device Initialization Manager sub-codes.	<p>The convention for the DIM POST codes is as follows: Port 80 = 0x92 Port 81 = DIM Function number DI number</p>
0x0096	<p>Call hook that is available to initialize option ROM's if DIM code has not already initialized any. Next, checkpoint 0x0097.</p>
0x0097	<p>Search for and give control to the option ROM's if not already done by DIM code. Next, checkpoint 0x0098.</p>
0x0098	<p>Activate ADM if add-on ROM found (yes, again). Disable USB host controller. Restoring INT10 vector. Performing any required processing after the option ROM returned control. If any ROM cleanup or OEM ROM work needed do it. Next, checkpoint 99h.</p>
0x0099	<p>Check CMOS to verify correct time (no power failure). Set to default if CMOS bad. Set up printer base address. Next, checkpoint 0x009A.</p>

IA-32 POST Codes	Meaning
0x009A	Set the RS-232 base address. Next, checkpoint 9Bh.
0x009B	Perform any chipset or OEM initialization. If needed check Coprocessor at checkpoint 0x009C else next, checkpoint A2h.
0x009C	Coprocessor test done. Next, checkpoint 9Dh.
0x009D	Initialization after the Coprocessor test is complete. Update equipment byte in CMOS and CMOS checksum. Next, checkpoint A2h.
0x00A2	Display any SMART error messages. Test for floppy drive. Initialize POST error information for event logging. Display any soft error messages. If errors occurred, then "Run Setup" displayed if hard disk error, CMOS time error, or cache error. Else display "Press F1 to resume" and wait for F1 key to be pressed. If CMOS bad or memory error occurred then HALT! If POST diagnostic switch enabled, then reboot. Next, checkpoint 0x00A4.
0x00A4	Call hook to perform any chipset or OEM time dependent programming. Things like programming wait states (DONE by IA64), shadow RAM cacheability (ALWAYS CACHEABLE). Next, checkpoint 0x00A5.
0x00A5	Beep and set interrupt on. Next, checkpoint 0x00A7.
0x00A7	Final OEM Patch called. Prepare the final RUNTIME image in a segment for copying to F000 shadow. Test for the presence of INT 10 module in E000 segment. Initialize the start and end offset variables to aid in the copying of the final runtime segment. Next, checkpoint 0x00AE.
0x00AE	Uncompress DMI code and data modules. Initialize SMBIOS header structure. Pass control to DMI module for initialization. Copy DMI code and data into final runtime image (F000). Next, checkpoint 0x00AC.
0x00AC	Building the multiprocessor table. Next, checkpoint 0x00AB.
0x00AB	Copy device present information to POST code segment. Copy INT 13 to final runtime (F000). If not enough room in F000, copy to E000. Update pointers between Runtime and INT 13 interfaces. Next, checkpoint 0x00AD.
0x00AD	Prepare INT10 image. Update the necessary data in different modules. Update available space in SMBIOS data structure. BIOS POST complete. Enable F000 writes to RAM (ALWAYS READ/WRITE), and go to checkpoint 0x00A8.

IA-32 POST Codes	Meaning
0x00A8	Initialization before passing control to the adapter ROM at E000h completed. Pass control to the adapter ROM at E000h. Next, checkpoint 0x00A9.
0x00A9	Return control from ROM. If ROM found, enable E000 shadow and copy ROM to shadow. Next, checkpoint 0x00AA.
0x00AA	Clear screen and display system configuration if no OEM logo. Enable/disable USB according to CMOS setting. Enable/disable Num Lock according to CMOS setting. Initialize extended keyboard. Check for unattended start in CMOS. If yes, load hot key password into KBC and lock keyboard and mouse. If no, continue. If BIOS display, then display "Wait" message. Go to Big Real Mode. Initialize MSIRQ routing table header. Copy runtime language module to E000 segment. Copy runtime ADM module to E000 segment. Next, checkpoint 0x00B1.
0x00B1	Copy Runtime BIOS, program BIOS cacheability (ALWAYS CACHEABLE). Next, checkpoint 0x0000h.
0x0000	Clear stack in 0 segment. Set reset type to hard reset in BIOS data area. Copy BBS data in DIM segment to code segment. Clear from 0:500 to top of available real memory. Invalidate PMM. Release of memory used by IA32 and return to IA64.

Table 74. IA-32 POST Codes

Device Initialization Manager (DIM) Code Checkpoints

The Device Initialization Manager module gets control at various times during BIOS POST to initialize different BUSES.

The following table describes the main checkpoints where the DIM module is accessed:

DIM Codes	Meaning
0x??2A	Initialize different BUSES and perform the following functions: Reset, Detect, and Disable (function 0); Static Device Initialization (function 1); Boot Output Device Initialization (function 2). Function 0 disables all device nodes, PCI devices, and PnP ISA cards. It also assigns PCI bus numbers. Function 1 initializes all static devices that include manual configured on-board peripherals, memory, and I/O decode windows in PCI-PCI bridges, and noncompliant PCI devices. Static resources are also reserved. Function 2 searches for and initializes any PnP, PCI, or AGP video devices.
0x??38	Initialize different BUSES and perform the following functions: Boot Input Device Initialization (function 3); IPL Device Initialization (function 4); General Device Initialization (function 5). Function 3 searches for and configures PCI input devices and detects if system has standard keyboard controller. Function 4 searches for and configures all PnP and PCI boot devices. Function 5 configures all onboard peripherals that are set to an automatic configuration and configures all remaining PnP and PCI devices.
0x??39	Display error messages encountered during different BUSES initialization. Perform function 6, which return error flags that are used to display necessary error information.
0x??84	Scan and initialize BBS option ROM's. Perform function 8, which builds various IPL tables according to the boot devices present in the system.
0x??92	Scan and initialize option ROM's. Perform function 7 which gives control and shadows all present ISA, PnP ISA, and PCI option ROM's.

Table 75. DIM Code checkpoints

Functions

- 0 = func#0, disable all devices on the BUS concerned.
- 1 = func#1, static devices initialization on the BUS concerned.
- 2 = func#2, output device initialization on the BUS concerned.
- 3 = func#3, input device initialization on the BUS concerned.
- 4 = func#4, IPL device initialization on the BUS concerned.
- 5 = func#5, general device initialization on the BUS concerned.
- 6 = func#6, error reporting for the BUS concerned.
- 7 = func#7, add-on ROM initialization for all BUSES.
- 8 = func#8, BBS ROM initialization for all BUSES.

BUSES

- 0 = Generic DIM (Device Initialization Manager).
- 1 = On-board System devices.
- 2 = ISA devices.
- 3 = EISA devices.
- 4 = ISA PnP devices.
- 5 = PCI devices.

PCI Diagnostic POST Codes

POST Codes	Name	Meaning
31–16	Post code main part	See below
15–12	Ext3	Module number (0 or 1)
11–08	Ext2	IOB / IOC number (0 or 1)
07–04	Ext1	Hub link number for the PCI (1 to 4)
03–00	Ext0	P64H2 secondary bus (0x“A” or 0x“B”)

Table 76. PCI diagnostic POST code format

POST Codes	Meaning	Extensions
0x802A	Temporary PCI bus number assignment	Yes
0x812A	Initial PCI bus power-up sequence	Yes
0x822A	Disable all PCI slots	Yes
0x812A	Initial PCI bus power-up sequence	Yes
0x832A	Apply power to PCI slots	Yes
0x842A	Set PCI bus mode and frequency	Yes
0x852A	Final PCI bus power-up sequence	Yes
0x862A	One second temporization	Yes
0x872A	One second temporization	Yes
0x882A	One second temporization	Yes
0x892A	One second temporization	Yes
0x8A2A	Read Vendor ID of all PCI devices	Yes
0x052A0000	Disable all PCI devices before PCI Bus Walk	No
0x252A0000	Configure VGA card, then execute VGA option ROM	No
0x552A0000	Configure all remaining PCI devices, then look for USB devices	No

Table 77. PCI diagnostic POST codes

EFI POST Code MAP

The following rules apply to POST code encoding:

Bit 15: 1 – IA64 code being executed, 0 – IA-32 code being executed

Bit 14: 1 – system stopped due to known failure, 0 – progress indication

Bit 13: 1 – fault or trap (no change in module numbers), 0 – normal execution

In the event of a fault or trap, only bit 13 is set to allow fault detection.

Bit 12: Reserved

Bit 11–4: Module type

Bit 3–0: Sub-module type

The module number identifies major modules such as memory, PCI, ACPI, etc. The sub-module identifies sub-functions such as SPD read in progress, ECC error, and DIMM mismatch for memory module.

POST Code	Module
0x50XX to 0x5FXX	EFI

Table 78. EFI POST Codes

ACPI POST Codes

POST Code	Module
0x4000 – 0x4FFF	Reserved for ACPI

Table 79. ACPI POST Codes

Recovery Port 80 POST Codes

POST Codes	Meaning
0xAA00	BIOS image loaded OK.
0xAA10	BIOS Image File loading from the media is in progress.
0xAA11	Removable Magnetic ATAPI device has been detected.
0xAA2X	Flash update operation status. X – can have a value from 0 to 0xF. This is number of the block being updated.
0xAA80	ATAPI device has been reset to recover from a reading error. BIOS Image File loading from the media is in progress.
0xAA81	Waiting for ATAPI device ready. BIOS Image File loading from the media is in progress.
0xAAF0	Failure while loading BIOS Image file from the media.
0xAAF1	Validation of the BIOS image has failed.
0xAAF3	Flash update failure.
0xAAAA	Recovery completed without errors
0xAAE0	File system error.
0xAAE1	BIOS image file is not found on the media.
0xAAE3	Unsupported ATAPI device has been detected.
0xAAE4	Read Error.

Table 80. Recovery Port 80 POST codes (before release B600)

POST Codes	Meaning
0xAA00	BIOS image loaded OK
0xAA10	BIOS Image File loading from the media is in progress.
0xAA11	Removable Magnetic ATAPI device has been detected.
0xAA12	CD_FOUND_INFO
0xAA2X	Flash update operation status. X – can have a value from 0 to 0xF. This is number of the block being updated.
0xAA80	ATAPI device has been reset to recover from a reading error. BIOS Image File loading from the media is in progress.
0xAA81	Waiting for ATAPI device ready. BIOS Image File loading from the media is in progress.
0xAAF0	Failure while loading BIOS image file from the media
0xAAF1	Validation of the BIOS image has failed.
0xAAF3	Flash update failure.
0xAAAA	Recovery completed without errors
0xAAD0	CD_HEAD_READ_ERROR
0xAAD1	CD_BODY_READ_ERROR

POST Codes	Meaning
0xAAD2	CD_TAIL_READ_ERROR
0xAAD3	LS120_READ_ERROR
0xAAE0	FILE_SYSTEM_ERROR
0xAAE1	FILE_NOT_FOUND_ERROR
0xAAE2	UNKNOWN_DEVICE_ERROR
0xAAE3	READ_ERROR
0xAAE4	CD_BOOT_REC_READ_ERROR
0xAAE5	CD_BOOT_REC_BYTE_0_BAD
0xAAE6	CD_BOOT_REC_CD001_ERROR
0xAAE7	CD_CATALOG_READ_ERR
0xAAE8	CD_INVALID_DEFAULT_HDR_ID
0xAAE9	CD_SEARCH_BOOTABLE_IMAGE
0xAAEA	CD_SECTION_NOT_BOOTABLE
0xAAEB	CD_MEDIA_TYPE_NOT_HD
0xAAEC	CD_NO_BOOT_IMAGE_FOUND
0xAAED	CD_LOAD_MBR_FAILURE
0xAAEE	CD_NO_ACTIVE_FAT16_PART
0xAAEF	CD_NO_ACTIVE_BOOT_SECTOR
0xAAC0	PMB_BAD_MAGIC_NUMBER1
0xAAC1	PMB_TIME_OUT
0xAAC2	PMB_BAD_HW_STATUS
0xAAC3	PMB_BAD_MAGIC_NUMBER2
0xAAC4	PMB_BAD_BUFFER_NUMBER
0xAAC5	PMB_BAD_DATA_SIZE
0xAAC6	PMB_BAD_FROM_IDENT
0xAAC7	PMB_BAD_TO_IDENT
0xAAC8	PMB_BAD_GETBIOS_FCT
0xAAC9	PMB_BAD_GETBIOS_FCTVER
0xAACA	PMB_BAD_GETBIOS_CMD
0xAACB	PMB_BAD_GETBIOS_CMDVER
0xAACC	PMB_BAD_SW_STATUS1
0xAACD	PMB_BAD_SW_STATUS2
0xABnm	BIOS image read from the PAM. nm (from 0x00 to 0x64) is the number of the block being read from the PAM.

Table 81. Recovery Port 80 POST codes (for releases B600 and later)

Runtime POST Codes

POST Codes	Module
0xAFCD	IA-32 Intercept Trap due to an unsupported IA-32 instruction
0xAFE8	Normal SAL Machine Check Handling in Progress
0xAFE9	Could Not Correct MC Error, Halting CPU
0xAFEA	MCA successfully completed, passing control back to PAL (Resume)
0xAFEB	Calling OS MCA for Machine Check error handling
0xAFEC	Machine Check Handler Processing Rendezvous Request
0xAFED	OS request for SAL Clear Processor/Platform Error/State Log in progress
0xAFEE	SAL Platform OEM MCA Error Handler In Control
0xAFEF	OS request for SAL Get Processor/Platform Error/State Log in progress
0xAFF0	SAL INIT Handler is in control
0xAFF1	Passing Control to IA-32 OS Init Handler
0xAFF2	Found valid OS_INIT Ep, Passing Control to EM OS Init Handler
0xAFF3	Is a MP platform MCA condition, calling SAL_RENDZ
0xAFF4	Not a MP Platform MCA Init condition
0xAFF5	EM OS with no Init Handler or IA-32OS-BSP detected, Soft Rebooting...
0xAFF6	No OS Initialize Handle Registered, Checking OS Type...
0xAFF8	SAL PMI Handler is in Control
0xAFFA	OEM SAL PMI Handler is in Control
0xAFFB	Getting Source of PMI Event
0xAFFC	Power Management PMI Handler is in Control
0xAFFD	Platform Error PMI Handler is in Control
0xAFFE	Platform Flash Management PMI Handler is in Control
0xAFFF	Platform Emulation PMI Handler is in Control
0xAF71	Recover Reliable Update – verifies the bootblock checksum and corrects if possible.

Table 82. ACPI POST codes

PAM BIOS Interface Post Codes

These Post codes are issued on execution of the commands sent by the BIOS to the PAM.

POST Codes	Module	Display
0xA000	BIOS Ready command is to be sent	
0xA001	BIOS Ready command has been sent	
0xA002	BIOS Ready command has returned KO (status 1=-1)	PAM
0xA004	BIOS Ready command has returned No Go (status1=0, status2=1)	PAM
0xA005	BIOS Ready command has returned normal (status1=0, status2=0)	
0xA00F	No response to BIOS Ready command after time out 18 sec	PAM
0xA010	EFI Started command is to be sent	
0xA011	EFI Started command has been sent	
0xA012	EFI Started command has returned KO (status 1=-1)	PAM
0xA013	EFI Started command has returned No Change (status1= 1)	
0xA014	EFI Started command has returned No Go (status1=0, status2=1)	PAM
0xA015	EFI Started command has returned normal (status1=0, status2=0)	
0xA01F	No response to EFI Started command after time out 18 sec	PAM
0xA020	EFI Exit command is to be sent	
0xA021	EFI Exit command has been sent	
0xA022	EFI Exit command has returned KO (status 1=-1)	PAM
0xA025	EFI Exit command has returned normal (status1=0, status2=0)	
0xA02F	No response to EFI Exit command after time out 18 sec	PAM
0xA030	Send MC Log command is to be sent	
0xA031	Send MC Log command has been sent	
0xA032	Send MC Log command has returned KO (status 1=-1)	
0xA035	Send MC Log command has returned normal (status1=0, status2=0)	
0xA03F	No response to Send MC Log command after time out 18 sec	
0xA040	MC Reset command is to be sent	
0xA041	MC Reset command has been sent	
0xA042	MC Reset command has returned KO (status 1=-1)	PAM
0xA045	MC Reset command has returned normal (status1=0, status2=0)	PAM
0xA04F	No response to MC Reset command after time out 18 sec	PAM
0xA050	Reset System command is to be sent	
0xA051	Reset System command has been sent	

POST Codes	Module	Display
0xA052	Reset System command has returned KO (status 1=-1)	PAM
0xA055	Reset System command has returned normal (status1=0, status2=0)	PAM
0xA05F	No response to Reset System command after time out 18 sec	PAM
0xA060	Set Time command is to be sent	
0xA061	Set Time command has been sent	
0xA062	Set Time command has returned KO (status 1=-1)	
0xA065	Set Time command has returned normal (status1=0, status2=0)	
0xA06F	No response to Set Time command after time out 18 sec	
0xA070	Get FRU command is to be sent	
0xA071	Get FRU command has been sent	
0xA072	Get FRU command has returned KO (status 1=-1)	PAM
0xA075	Get FRU command has returned normal (status1=0, status2=0)	
0xA07F	No response to Get FRU command after time out 18 sec	PAM
0xA080	Get GUID command is to be sent	
0xA081	Get GUID command has been sent	
0xA082	Get GUID command has returned KO (status 1=-1)	PAM
0xA085	Get GUID command has returned normal (status1=0, status2=0)	
0xA08F	No response to Get GUID command after time out 18 sec	PAM
0xA090	EFI Variable Modified command is to be sent	
0xA091	EFI Variable Modified command has been sent	
0xA092	EFI Variable Modified command has returned KO (status 1=-1)	
0xA095	EFI Variable Modified command has returned normal (status1=0, status2=0)	
0xA09F	No response to EFI Variable Modified command after time out 18 sec	
0xA0A0	EFI Variable To Restore command is to be sent	
0xA0A1	EFI Variable To Restore command has been sent	
0xA0A2	EFI Variable To Restore command has returned KO (status 1=-1)	
0xA0A5	EFI Variable To Restore command has returned normal (status1=0, status2=0)	
0xA0AF	No response to EFI Variable To Restore command after time out 18 sec	

POST Codes	Module	Display
0xA0B0	Send Message command is to be sent	
0xA0B1	Send Message command has been sent	
0xA0B2	Send Message command has returned KO (status 1=-1)	
0xA0B5	Send Message command has returned normal (status1=0, status2=0)	
0xA0BF	No response to Send Message command after time out 18 sec	
0xA0C0	Notify command is to be sent	
0xA0C1	Notify command has been sent	
0xA0C2	Notify command has returned KO (status 1=-1)	
0xA0C5	Notify command has returned normal (status1=0, status2=0)	
0xA0CF	No response to Notify command after time out 18 sec	
0xA0D0	Get BIOS Image command is to be sent	
0xA0D1	Get BIOS Image command has been sent	
0xA0D2	Get BIOS Image command has returned KO (status 1=-1)	PAM
0xA0D5	Get BIOS Image command has returned normal (status1=0, status2=0)	
0xA0D6	Get BIOS Image command has returned No BIOS image (status1=0, status2=2)	PAM
0xA0DF	No response to Get BIOS Image command after time out 18 sec	PAM

Table 83. PAM – BIOS Interface POST codes (for releases B740 and later)

Boot Error Messages

Message Displayed	Description
Boot Failure ...	This is a generic message indicating the BIOS could not boot from a particular device. This message is usually followed by other information concerning the device.
Reboot and Select proper Boot device or Insert Boot Media in selected Boot device	BIOS could not find a bootable device in the system and/or removable media drive does not contain media.

Table 84. Boot error messages

Storage Device Error Messages

Message Displayed	Description
Primary Master Hard Disk Error	The IDE/ATAPI device configured as Primary Master could not be properly initialized by the BIOS. This message is typically displayed when the BIOS is trying to detect and configure IDE/ATAPI devices in POST.
Secondary Master Hard Disk Error	The IDE/ATAPI device configured as Secondary Master could not be properly initialized by the BIOS. This message is typically displayed when the BIOS is trying to detect and configure IDE/ATAPI devices in POST.
Primary Master Drive – ATAPI Incompatible	The IDE/ATAPI device configured as Primary Master failed an ATAPI compatibility test. This message is typically displayed when the BIOS is trying to detect and configure IDE/ATAPI devices in POST.
Secondary Master Drive – ATAPI Incompatible	The IDE/ATAPI device configured as Secondary Master failed an ATAPI compatibility test. This message is typically displayed when the BIOS is trying to detect and configure IDE/ATAPI devices in POST.

Table 85. Storage error messages

System Configuration Error Messages

Message Displayed	Description
DMA-2 Error	Error initializing secondary DMA controller. This is a fatal error, often indication a problem with system hardware.
DMA Controller Error	POST error while trying to initialize the DMA controller. This is a fatal error, often indication a problem with system hardware.
Checking NVRAM. Update Failed	BIOS could not write to the NVRAM block. This message appears when the FLASH part is write-protected or if there is no FLASH part (System uses a PROM or EPROM).
NVRAM Checksum Bad, NVRAM Cleared	There was an error in while validating the NVRAM data. This causes POST to clear the NVRAM data.
Resource Conflict	More than one system device is trying to use the same non-shareable resources (Memory or I/O).
NVRAM Ignored	The NVRAM data used to store Plug'n'Play (PnP) data was not used for system configuration in POST.
NVRAM Bad	The NVRAM data used to store Plug'n'Play (PnP) data was not used for system configuration in POST due to a data error.
Static Resource Conflict	Two or more Static Devices are trying to use the same resource space (usually Memory or I/O).
PCI I/O conflict	A PCI adapter generated an I/O resource conflict when configured by BIOS POST.
PCI ROM conflict	A PCI adapter generated an I/O resource conflict when configured by BIOS POST.
PCI IRQ conflict	A PCI adapter generated an I/O resource conflict when configured by BIOS POST.
PCI IRQ routing table error	BIOS POST (DIM code) found a PCI device in the system but was unable to figure out how to route an IRQ to the device. Usually this error is causing by an incomplete description of the PCI Interrupt Routing of the system.
Timer Error	BIOS POST (DIM code) found a PCI device in the system but was unable to figure out how to route an IRQ to the device. Usually this error is causing by an incomplete description of the PCI Interrupt Routing of the system.
Interrupt Controller-1 error	BIOS POST could not initialize the Master Interrupt Controller. This may indicate a problem with system hardware.
Interrupt Controller-2 error	BIOS POST could not initialize the Slave Interrupt Controller. This may indicate a problem with system hardware.

Table 86. System configuration error messages

CMOS Error Messages

Message Displayed	Description
CMOS Date/Time Not Set	The CMOS Date and/or Time are invalid. This error can be resolved by readjusting the system time in AMIBIOS Setup.
CMOS Battery Low	CMOS Battery is low. This message usually indicates that the CMOS battery needs to be replaced. It could also appear when the user intentionally discharges the CMOS battery.
CMOS Settings Wrong	CMOS settings are invalid. This error can be resolved by using AMIBIOS Setup.
CMOS Checksum Bad	CMOS contents failed the Checksum check. Indicates that the CMOS data has been changed by a program other than the BIOS or that the CMOS is not retaining its data due to malfunction. This error can typically be resolved by using AMIBIOS Setup.

Table 87. CMOS error messages

Miscellaneous Error Messages

Message Displayed	Description
Keyboard Error	Keyboard is not present or the hardware is not responding when the keyboard controller is initialized.
Keyboard/Interface Error	Keyboard Controller failure. This may indicate a problem with system hardware.
System Halted	The system has been halted. A reset or power cycle is required to reboot the machine. This message appears after a fatal error has been detected.

Table 88. Miscellaneous error messages

PAM Help Messages

- ▶ Message severity levels, on page C-36
- ▶ Message list, on page C-36

Message Severity Levels

PAM event messages or histories are graded into four severity levels as explained in *Understanding Event Message and History Severity Levels*, in the *User's Guide*.

**Note:**

According to the message severity level, the first character **2** of **2B2Bxxxx** (Success, Information or Warning level) may change to **A** (**AB2Bxxxx**) (Error level).

Message List

PAM messages can be consulted online and/or printed at the user's request. The following table indicates PAM message IDs with a brief description.

	Description	
2B2B0000	Undefined error	
2B2B1000	Successful function completion	
2B2B1001	Function not completed for an internal reason	
2B2B1002	File not found	
2B2B1003	Directory not found	
2B2B1004	File already exists	
2B2B1005	Call to function failed	
2B2B1006	Invalid argument	
2B2B1007	Missing argument	
2B2B1008	Collection item not found	
2B2B1009	Collection item already exists	
2B2B100A	Invalid collection item	
2B2B100B	Unit absent	
2B2B100C	Unit present	
2B2B100D	Functional status: Normal	
2B2B100E	Functional status: Warning	
2B2B100F	Functional status: Critical	
2B2B1010	Functional status: Fatal	
2B2B1012	CellBlock added	
2B2B1013	CellBlock removed	
2B2B1014	Cannot load XML file	
2B2B1015	Cannot save XML file	
2B2B1016	Name or field too long	
2B2B1017	Error loading XML file	
2B2B1018	Cannot delete XML file	
2B2B1019	Component not accessible	

	Description	
2B2B101A	Component irrelevant	
2B2B101B	PAM internal error	
2B2B101C	Factory Bootrom used to load MAESTRO	
2B2B101D	Updated Bootrom used to load MAESTRO	
2B2B101E	Running MAESTRO loaded from PMB flash ROM	
2B2B101F	Running MAESTRO loaded from PAP disk	
2B2B1020	MAESTRO image choice: "PMB flash ROM"	
2B2B1021	MAESTRO image choice: PAP disk	
2B2B1022	Fault status: Normal	
2B2B1023	Fault status: Faulty	
2B2B1024	Failure status: Normal	
2B2B1025	Failure status: Degraded	
2B2B1026	Failure status: Failed	
2B2B1027	Error validating XML file	
2B2B1028	Invalid length	
2B2B1029	Unable to create directory	
2B2B102A	Unit excluded	
2B2B102B	Unit reinserted	
2B2B102C	Bad clock frequency in PIROM	
2B2B102D	PIROM information not accessible	
2B2B102E	QBB clock ratio	
2B2B102F	Maintenance network adapter missing	
2B2B1030	Disk full	
2B2B1031	Cannot copy XML file	
2B2B1032	New release activated	
2B2B1033	Illegal character in object name	
2B2B2000	Method not implemented	
2B2B2001	Interface not supported	
2B2B2002	Invalid interface pointer	
2B2B2003	Operation aborted	
2B2B2004	Unspecified error	
2B2B2005	Operation failed on registry key	
2B2B2006	Operation failed on semaphore	
2B2B2007	Unexpected value for <switch name> switch	
2B2B2008	Access denied	
2B2B2009	Directory created	
2B2B200A	File created	
2B2B200B	Object created successfully	
2B2B200C	Object deleted successfully	
2B2B200D	Object written successfully	
2B2B200E	Object invalid	
2B2B200F	File not loaded	

	Description	
2B2B2010	File not saved	
2B2B2012	Operation forbidden	
2B2B2013	Element not found	
2B2B2014	Object renamed successfully	
2B2B2015	Renaming object forbidden	
2B2B2016	Method not applicable	
2B2B2017	PAM object should not be reentered	
2B2B2018	Unexpected variant type	
2B2B2019	Error detected by the PAP Operating System	
2B2B201A	Cannot create object	
2B2B201B	Command in progress	
2B2B201C	Asynchronous command not issued	
2B2B201D	Service status	
2B2B201E	File operation failed	
2B2B2100	Cannot add CellBlock	
2B2B2101	Cannot remove CellBlock	
2B2B2102	Hardware identifier out of range	
2B2B2103	Hardware identifier already assigned	
2B2B2104	PAP software started	
2B2B2105	Incorrect signature	
2B2B2106	Config information successfully applied to cellblock	
2B2B2107	Cannot apply config information using file	
2B2B2200	Object copied successfully	
2B2B2201	Object locked	
2B2B2202	Object not locked	
2B2B2203	Operation not allowed	
2B2B2204	Invalid XML string	
2B2B2205	Element missing	
2B2B2210	Domain cannot be activated	
2B2B2211	Domain inactive	
2B2B2212	Domain initializing	
2B2B2213	Domain Power-on failed	
2B2B2214	Domain time out during the power-on sequence	
2B2B2215	Domain powered on	
2B2B2216	Domain BIOS ready	
2B2B2217	Domain time out while waiting for BIOS ready state	
2B2B2218	Recovering BIOS	
2B2B2219	Domain EFI started	
2B2B221A	Domain EFI started time out	
2B2B221B	Domain running	
2B2B221C	Domain terminating	
2B2B221D	Domain power-down failed	

	Description	
2B2B221E	Domain power-down time out	
2B2B221F	Domain initialization step: <step description>	
2B2B2220	Domain termination step <step description>	
2B2B2221	Domain <domain name> Power-on started	
2B2B2222	Resource(s) unavailable for domain Power-on	
2B2B2223	Domain <domain name>, <command> failed	
2B2B2224	BIOS command received: <command name>	
2B2B2225	Reset action requested	
2B2B2226	Domain creation error	
2B2B2227	Domain not running	
2B2B2228	Domain <domain name> is already powered on	
2B2B2229	Incorrect BIOS data length	
2B2B222A	Domain group cannot be removed	
2B2B222B	Domain cannot be removed because it is not in an INACTIVE state	
2B2B222C	Domain command rejected	
2B2B222D	MAESTRO Domain <domain name> power state unknown	
2B2B222E	Domain <domain name> synchronization with MAESTRO failed	
2B2B222F	Fan box <fan box name> is not available	
2B2B2230	IOR / IOL not available	
2B2B2232	Not enough DPS	
2B2B2233	No SPS fan box is available on module	
2B2B2234	Domain <domain name> cannot be powered ON	
2B2B2235	XML EFI variable invalid	
2B2B2236	BIOS EFI variable invalid	
2B2B2237	Domain power off after time out	
2B2B2238	No CPU available for this QBB included in domain	
2B2B2239	Message from BIOS	
2B2B223A	Domain reset started	
2B2B223B	Domain identity not found	
2B2B223C	Domain powering on suspended	
2B2B223D	Domain power on resumed	
2B2B223E	Reset action unknown	
2B2B223F	Domain halted	
2B2B2240	QBB origin unexpected	
2B2B2241	CPU incompatible	
2B2B2242	Domain group cannot be added	
2B2B2243	Non compliance with configuration information	
2B2B2244	Domain definition invalid	
2B2B2245	SPS function not available	
2B2B2246	No QBB available	
2B2B2247	Master resource mismatch	

	Description	
2B2B2248	Domain clock frequency	
2B2B2249	No BIOS image reference set	
2B2B224A	Domain clock frequency should be nominal	
2B2B224B	SPS not available	
2B2B224C	Domain notification invalid	
2B2B224D	Domain power off after virtual power on	
2B2B224E	BIOS Post Code not accessible	
2B2B224F	Cannot delete BIOS image file	
2B2B2250	Cannot update an EFI variable	
2B2B2251	Cannot read recovery status	
2B2B2252	Scheme incompatible with current domain configuration	
2B2B2253	Resource missing in scheme	
2B2B2254	BIOS postcodes logged after time-out	
2B2B2255	Domain thermal alert	
2B2B2256	Domain FRU faulty	
2B2B2257	Cannot get the EFI variables	
2B2B2258	Invalid clock exclusion	
2B2B2259	BIOS stop request	
2B2B225A	Invalid link in domain	
2B2B225B	Virtual power on failed	
2B2B225C	Domain license invalid	
2B2B225D	PCI slot not available	
2B2B225E	Domain sync with Maestro	
2B2B2300	PMB not declared	
2B2B2301	PMB declared before PAM	
2B2B2302	PMB declared	
2B2B2303	PMB connection check	
2B2B2304	PMB connection error	
2B2B2305	RPC trace	
2B2B2306	RPC connection error	
2B2B2307	RPC error	
2B2B2400	Cannot add object	
2B2B2401	Cannot remove object	
2B2B2402	Object added to collection	
2B2B2403	Object removed from collection	
2B2B2404	Inconsistency in filter	
2B2B2405	Subscription test	
2B2B2406	Invalid event processor	
2B2B2407	Cannot submit event to subscription	
2B2B2408	Inconsistency in subscription	
2B2B2409	Event object in use	
2B2B240A	Error sending an autocal file	

	Description	
2B2B240B	Error sending mail	
2B2B240C	Server not configured	
2B2B240D	User not declared	
2B2B240E	Too many pending autocal files	
2B2B240F	Local directory not configured	
2B2B2410	Autocall heartbeat	
2B2B2411	Autocall handler disabled	
2B2B2500	Cannot remove unit	
2B2B2501	Maintenance procedure failed	
2B2B2502	Maintenance procedure command OK	
2B2B2503	CPU KO (Performance restricted)	
2B2B2504	CPU KO (Functionally restricted)	
2B2B2505	CPU KO (Unresponsive)	
2B2B2506	QBB KO	
2B2B2507	QBB damaged (SPS KO)	
2B2B2508	Unknown BIOS status	
2B2B2509	Unknown PIROM format	
2B2B2510	Invalid PIROM data	
2B2B2511	Invalid memory size	
2B2B2512	CPU FRU-EEPROM written	
2B2B2513	Module Power configuration: normal	
2B2B2514	Module Power configuration: critical	
2B2B2515	Module Power configuration: fatal	
2B2B2516	Module SPSFanBox configuration: normal	
2B2B2517	Module SPSFanBox configuration: critical	
2B2B2518	Module SPSFanBox configuration: fatal	
2B2B2519	FRU active	
2B2B2520	FRU inactive	
2B2B2521	FRU ready for maintenance	
2B2B2522	FRU not ready for maintenance	
2B2B2523	No maintenance procedure for this FRU	
2B2B2524	Module main off	
2B2B2525	Only x out of y Mbytes have been initialized	
2B2B2526	FRU or system EEPROM successfully written / updated	
2B2B2527	Unable to write / update FRU EEPROM	
2B2B2528	Unable to read the System EEPROM	
2B2B2529	Cannot access CPU LIDs	
2B2B2530	Unit removed	
2B2B2531	SIOH KO	
2B2B2532	PCI slot faulty	
2B2B2533	PCI slot faulty	
2B2B2534	Illegal PCI function number	

	Description	
2B2B2535	Cannot access PCI Class Codes	
	PCI class code unknown	
	QBB KO	
2B2B2538	Maintenance procedure in progress	
2B2B2539	FRU power on rejected	
2B2B253A	No maintenance procedure to close	
2B2B253B	Illegal memory row index	
2B2B253C	Memory row KO	
2B2B253D	Unable to read the FRU EEPROM	
2B2B253E	Cannot get the FPGA version	
2B2B253F	Invalid I2CFitPattern definition	
2B2B2540	No ERC reference	
2B2B2541	Check EEPROM failed	
2B2B2600	HistoryManager internal error	
2B2B2601	History internal error	
2B2B2602	Archive internal error	
2B2B2603	EVT files not available	
2B2B2604	HistoryMaster missing	
2B2B2605	XML description not found	
2B2B2606	Event Logging failed	
2B2B2607	Static History illegal operation	
2B2B2608	Current history not locked for any PUID	
2B2B2609	Current history not locked for PUID	
2B2B260A	Current history locked	
2B2B260B	EventLogConverter internal error	
2B2B260C	EventLog internal error	
2B2B260D	Current history created with PAM revision	
2B2B2700	Security internal error	
2B2B2701	MsgUtil internal error	
2B2B2703	Current call context not available	
2B2B2704	Security disabled for current object	
2B2B2705	Application not found in COM Catalog	
2B2B2706	Message index not found	
2B2B2707	Message identifier not found	
2B2B270C	FileObject internal error	
2B2B270D	FTP error	
2B2B270E	FTP session closed	
2B2B270F	FTP session opened	
2B2B2710	Engineering modes were reset to their default value	
2B2B2711	ZIP error	
2B2B2712	Zip file already created	
2B2B2713	Zip file already closed	

	Description	
2B2B2714	External Alarm	
2B2B2715	SNMP Agent error	
2B2B2716	Remote Access Server error	
2B2B2800	Incorrect FTP server configuration on PAP	
2B2B2801	Firmware version identifier not found	
2B2B2802	Remove reference firmware denied	
2B2B2803	Invalid BootRom version	
2B2B2804	Invalid reference firmware	
2B2B2805	Firmware version not found	
2B2B2806	Firmware version shared	
2B2B2807	Remove default firmware denied	
2B2B2808	FTP server not found	
2B2B2809	Invalid Hardware Type	
2B2B2900	NVRAM area modified	
2B2B2901	S@N.IT command failed	
2B2B2902	Check internal SAN – only one fabric allowed	
2B2B2903	Property or method not available	
2B2B2904	Parameter must have hexadecimal characters	
2B2B2905	method or property modification forbidden	
2B2B2906	S@N.IT discovery failed	
2B2B2907	SAN trace open string	
2B2B290A	LUN status changed	
2B2B290B	SNMP trap	
2B2B290C	SNMP error	
2B2B2A00	FRUEEPROMInfo internal error	
2B2B2A01	Checksum invalid	
2B2B2A02	FRU EEPROM Info not IPMI compliant for component <PUID>	
2B2B2A03	IPMISELDevice internal error	
2B2B2A04	Invalid network function code	
2B2B2B00	Cannot save log file	
2B2B2B01	Error notification received	
2B2B2B02	Unexpected log format	
2B2B2B03	Error report file created and saved	
2B2B2B04	Unable to create an error report file	
2B2B2C00	Information from Global Status	
2B2B2D00	Identity card created	
2B2B2D01	Identity card failed	
2B2B3000	Object not ready. Object non initialized or MAESTRO problem	
2B2B3001	Unknown PUID	
2B2B3002	Function not supported	
2B2B3005	Process in progress	
2B2B3006	Debug message	

	Description	
2B2B3007	MAESTRO component fault ON	
2B2B3008	MAESTRO component fault OFF	
2B2B3009	MAESTRO internal error	
2B2B300A	Operation failed	
2B2B300B	Method in progress	
2B2B3100	MAESTRO is starting	
2B2B3101	MAESTRO is ready	
2B2B3102	MAESTRO task launched	
2B2B3103	MAESTRO task deleted	
2B2B3104	MAESTRO task suspended	
2B2B3200	PMB firmware successfully reloaded	
2B2B3201	PMB firmware reload: failed	
2B2B3202	PMB firmware MAESTRO boot: failed	
2B2B3210	PMB firmware reload: started	
2B2B3211	MAESTRO reboot after having reloaded PMB firmware	
2B2B3212	MAESTRO reboot before reloading PMB firmware	
2B2B3213	PMB firmware: missing File or Version information	
2B2B321E	PMB firmware OK	
2B2B321F	PMB Firmware information	
2B2B3220	PMB confidence test not performed	
2B2B3221	PMB confidence test error	
2B2B3222	Midplane Type not supported	
2B2B3280	RPC connection is not opened	
2B2B3281	RPC connection is opened	
2B2B3282	RPC connection is closed	
2B2B3283	RPC portmapper failed	
2B2B3284	RPC server not found	
2B2B3285	RPC server: unknown procedure	
2B2B3286	RPC server: cannot reply to procedure	
2B2B3290	RPC call failure	
2B2B32A0	PAP request started	
2B2B32A1	PMB request started	
2B2B32A2	Remote request terminated	
2B2B32A3	Request to PAP started	
2B2B32A4	PMB request started	
2B2B32A5	Request to remote destination terminated	
2B2B32A6	Invoke error	
2B2B3300	Stand-by power device OFF	
2B2B3301	Power device OFF. The main part of device converters is OFF	
2B2B3302	Power device ON. Stand-by and main are ON	
2B2B3303	Power device Faulty	
2B2B3304	Stand-by power device Faulty	

	Description	
2B2B3305	Power converter Faulty	
2B2B3306	Stand-by power device ON	
2B2B3307	Power converter OFF	
2B2B3308	Power converter ON	
2B2B3309	Power converter Failed	
2B2B330A	Power device voltage margin: +	
2B2B330B	Power device voltage margin: OFF	
2B2B330C	Power device voltage margin: -	
2B2B331D	Fan status: Normal	
2B2B331E	Fan status: Fault.	
2B2B331F	LED: OFF	
2B2B3320	LED: ON	
2B2B3321	FPGA not correctly loaded	
2B2B3322	P64H2_<P64H2 number> hot-plug request	
2B2B3323	P64H2_<P64H2 number> hot-plug acknowledge.	
2B2B3324	ACPI signal asserted	
2B2B3325	ACPI signal deasserted	
2B2B3326	FRU connected	
2B2B3327	FRU isolated	
2B2B3328	Cabinet door opened	
2B2B3329	Cabinet door closed	
2B2B3330	Cabinet intrusion detector cable is connected	
2B2B3331	Cabinet intrusion detector cable is disconnected	
2B2B3332	Battery failed	
2B2B3333	I2C loop back error	
2B2B3334	Clock frequency unknown	
2B2B3335	PHPB/HPB fault	
2B2B3336	Chip not accessible through SM bus	
2B2B3337	Set clock frequency	
2B2B3338	Set clock source	
2B2B3339	Set clock not allowed	
2B2B333A	Invalid MSX clocks configuration	
2B2B333B	Invalid I2C fit pattern value	
2B2B3400	Device missing	
2B2B3401	Device failed	
2B2B3402	SM bus access denied	
2B2B3403	SM bus failed	
2B2B3405	I2C network failed	
2B2B3406	Chipset command aborted	
2B2B3407	Chipset status: busy	
2B2B3408	Chipset status: error	
2B2B3409	I2C loop back error	

	Description	
2B2B340A	BSPS write error	
2B2B3500	Domain already powered on	
2B2B3501	Domain already powered off	
2B2B3502	Power on in progress	
2B2B3503	Power off in progress	
2B2B3504	Remove domain KO	
2B2B3505	Master IOB / IOC not defined	
2B2B3506	Master QBB not defined	
2B2B3507	NVRAM missing	
2B2B3508	Domain <domain name> requested by <action>	
2B2B3509	Domain <domain name> requested by <action>	
2B2B3600	Command sent by Bios to PMB	
2B2B3601	Message returned to BIOS by PMB	
2B2B3602	BIOS log queue overflow control	
2B2B3700	ERC mode	
2B2B3701	ERC interrupt	
2B2B3702	Error in Machine Check processing	
2B2B3703	ERC signal configuration state	
2B2B3704	ERC log queue overflow control	
2B2B3705	BIOS log queue state	
2B2B3706	Burst of machine check errors	
2B2B3707	Burst of machine check errors terminated	
2B2B3708	ERC error reporting modified	
2B2B3800	Invalid IPMI response length	
2B2B3801	IPMI command received	
2B2B3802	IPMI response	
2B2B3803	IPMI watchdog timer expiration	
2B2B3804	IPMI invalid command length	
2B2B3805	IPMI invalid command format	
2B2B3806	IPMI cannot execute command	
2B2B3807	IPMI debug message	
2B2B3808	IPMI watchdog timer action	
2B2B3900	Trace of request received by DomainPool object	
2B2B3901	Module hardware resources left unchanged	
2B2B3902	Request rejected	
2B2B3A00	JTAG illegal command	
2B2B3A01	JTAG not supported command	
2B2B3A02	JTAG illegal end state	
2B2B3A03	JTAG cannot read	
2B2B3A04	JTAG illegal end of file	
2B2B3A05	JTAG illegal transition state	
2B2B3A06	JTAG illegal TAP state	

	Description	
2B2B3A07	JTAG TDO mismatch	
2B2B3A08	JTAG max retries	
2B2B3A09	JTAG XSVF command	
2B2B3A0A	JTAG error	
2B2B3A0B	JTAG XSVF file execution	
2B2B3A0C	JTAG XSVF file execution OK	
2B2B3A0D	JTAG cannot open XSVF file	
2B2B3A0E	JTAG method failed	
2B2B3A0F	JTAG TDO signal	
2B2B3A10	Invalid JTAG target	
2B2B4000	Remote script error	
2B2B4001	WEB Server error	
2B2B4002	XML node missing	
2B2B4003	Web session initialization error	
2B2B4004	Page loading error	
2B2B4005	Error discarded	
2B2B4006	Error loading an ASP page, generally due to a loading time limit	
2B2B4007	Error occurred on the WEB Client	
2B2B4008	Intervention report	
2B2B400A	WEB Session started	
2B2B400B	WEB Session ended	
2B2B400C	PAP shutdown	
2B2B400D	WEBServer trace	

Table 89. PAM message list

Glossary

A

AC: Alternating Current generated by the power supply. See DC.

ACPI: Advanced Configuration and Power Interface. An industry specification for the efficient handling of power consumption in desktop and mobile computers. ACPI specifies how a computer's BIOS, operating system, and peripheral devices communicate with each other about power usage.

Address: A label, name or number that identifies a location in a computer memory.

AMI: American Megatrends Incorporated.

ANSI: American National Standards Institute.

API: Application Program Interface. The specific method prescribed by a computer operating system or by an application program by which a programmer writing an application program can make requests of the operating system or another application.

Archive: (Archive file). A file that is a copy of a history file. When a history file is archived, all messages are removed from the history file.

ASCII: American National Standard Code for Information Interchange. A standard number assigned to each of the alphanumeric characters and keyboard control code keys to enable the transfer of information between different types of computers and peripherals.

B

Backup: A copy of data for safe-keeping. The data is copied from computer memory or disk to a floppy disk, magnetic tape or other media.

Backup battery: The battery in a computer that maintains real-time clock and configuration data when power is removed.

Baud rate: The speed at which data is transmitted during serial communication.

BIOS: Basic Input / Output System. A program stored in flash EPROM or ROM that controls the system startup process.

BIST: Built-In Self-Test. See POST.

Bit: Derived from Binary digit. A bit is the smallest unit of information a computer handles.

BTU: British Thermal Unit.

Byte: A group of eight binary digits (bit) long that represents a letter, number, or typographic symbol.

C

Cache Memory: A very fast, limited portion of RAM set aside for temporary storage of data for direct access by the microprocessor.

CD-ROM: Compact Disk Read-Only Memory. High-capacity read-only memory in the form of an optically readable compact disk.

Cell: The smallest set of hardware components allocated to a single OS. A cell is functionally defined by:

- the number of available processors
- memory capacity
- I/O channel capacity.

CellBlock: A group of interconnected cells within a single domain. See Central Subsystem.

Central Subsystem: A group of interconnected cells gathered within a single domain. See CellBlock.

Chip: Synonym for integrated circuit. See IC.

Clipping: A PAM Event filter criterion. Clipping is defined on a Count / Time basis aimed at routing a pre-defined number of messages only. Identical messages are counted and when the number of messages indicated in the **Count** field is reached within the period of time indicated in the **Time** field, no other messages will be selected for routing.

CMC: Corrected Memory Check.

CMOS: Complementary Metal Oxide Semiconductor. A type of low-power integrated circuits. System startup parameters are stored in CMOS memory. They can be changed via the system setup utility.

COM: Component Object Model. Microsoft technology for component based application development under Windows.

COM +: Component Object Model +. Microsoft technology for component based application development under Windows. The external part of the PAM software package is a COM+ application.

COM1 or COM2: The name assigned to a serial port to set or change its address. See Serial Port.

Command: An instruction that directs the computer to perform a specific operation.

Configuration: The way in which a computer is set up to operate. Configurable options include CPU speed, serial port designation, memory allocation, ...

Configuration Tasks: A PAM feature used to configure and customize the server.

Control Pane: One of the three areas of the PAM web page. When an item is selected in the **PAM Tree** pane, details and related commands are displayed in the **Control** pane. See PAM Tree pane and Status pane.

Core Unit: A main CSS module unit interconnecting the MIO, MQB, MSX and MFL boards. See MIO, MQB, MSX, MFL.

COS: Cluster Operating System.

CPE: Corrected PCI Error.

CPU: Central Processing Unit. See Microprocessor.

CSE: Customer Service Engineer.

CSS: Central Sub-System. See CellBlock.

CSS Module: A MidPlane with all its connected components (QBBs, IO boards, PMB) and utility devices. See Module.

D

D2D: DC to DC converter.

DC: Direct Current generated by the power supply. See AC.

Default Setting: The factory setting your server uses unless instructed otherwise.

Density: The capacity of information (bytes) that can be packed into a storage device.

Device Driver: A software program used by a computer to recognize and operate hardware.

DIB: Device Interface Board. The DIB provides the necessary electronics for the Internal Peripheral Drawer. See IPD.

DIG64: Developer Interface Guide for IA64.

DIM Code: Device Initialization Manager. Initializes different BUSes during the BIOS POST.

DIMM: Dual In-line Memory Module – the smallest system memory component.

Disk Drive: A device that stores data on a hard or floppy disk. A floppy disk drive requires a floppy disk to be inserted. A hard disk drive has a permanently encased hard disk.

DMA: Direct Memory Access. Allows data to be sent directly from a component (e.g. disk drive) to the memory on the motherboard). The microprocessor does not take part in data transfer enhanced system performance.

DMI: Desktop Management Interface. An industry framework for managing and keeping track of hardware and software components in a system of personal computers from a central location.

DNS: Domain Name Server. A server that retains the addresses and routing information for TCP/IP LAN users.

Domain: is the coherent set of resources allocated to run a customer activity, i.e. the association –at boot time– of a Partition, an OS instance (including applications) and associated LUNs and an execution context including execution modes and persistent information (e.g. time, date of the OS instance). Domain definitions and initializations are performed via PAM. A Domain can be modified to run the same OS instance on a different Partition. When a Domain is running, its resources are neither visible nor accessible to other running Domains.

Domain Identity: a PAM Domain management logical resource. This resource contains context information related to the Customer activity running in a domain. The most visible attribute of this resource is the name that the Customer gives to the activity. For each domain created, the Domain management feature allows the operator to define a new activity or choose an activity from the list of existing activities. See Domain.

Domain Manager: A PAM feature used to power on / off and manage server domains. See Domain.

DPS: Distributed Power Supply.

DRAM: Dynamic Random Access Memory is the most common type of random access memory (RAM).

E

EEPROM: Electrically Erasable Programmable Read-Only Memory. A type of memory device that stores password and configuration data. See also EPROM.

EFI: Extensible Firmware Interface.

EFIMTA: EFI Modular Test Architecture.

EFI Shell: The EFI (Extensible Firmware Interface) Shell is a simple, interactive user interface that allows EFI device drivers to be loaded, EFI applications to be launched, and operating systems to be booted. In addition, the EFI Shell provides a set of basic commands used to manage files and the system environment variables. See Shell.

EMI: Electro–Magnetic Interference.

EPROM: Erasable Programmable Read-Only Memory. A type of memory device that is used to store the system BIOS code. This code is not lost when the computer is powered off.

ERC: Error Recovery Check.

ERP: Error Recovery Procedure.

ESD: ElectroStatic Discharge. An undesirable discharge of static electricity that can damage equipment and degrade electrical circuitry.

Event: The generation of a message (event message) by a software component and that is directed to the Event Manager.

Event address: Defines the destination for a message sent over a specified event channel. An address is one of: the name of a history file (for the HISTORY channel), an e–mail address (for the EMAIL channel), the name of a user group (for the WEB channel), the SNMP Manager IP address (for the SNMP channel).

Event channel: Defines how the Event Manager sends an event message. An event channel is one of: HISTORY (the message is logged in a history file), EMAIL (the message is sent to an e–mail address), WEB (the message is stored for analysis from the PAM web user interface), SNMP (the message is sent as an SNMP trap to the selected SNMP application).

Event filter: A list of selected messages among all possible event messages. If an event message is not included in the filter, the Event Manager discards the message.

Event Manager: A PAM feature used to forward event messages over a configured event channel. See Event.

Event message: A message sent by a software component to the Event Manager for routing to a destination that is configured by an administrator.

Event subscription: An object that defines the event channel, address, and filter for sending an event message. If no such object is defined, the event message is discarded.

F

Fail–over: Failover is a backup operational mode in which the functions of a system component (such as a processor, server, network, or database, for example) are assumed by secondary system components when the primary component becomes unavailable through either failure or scheduled down time.

FAME: Flexible Architecture for Multiple Environments.

FAST WIDE: A standard 16–bit SCSI interface providing synchronous data transfers of up to 10 MHz, with a transfer speed of 20M bytes per second.

FC: Fibre Channel.

FCAL: Fibre Channel Arbitrated Loop.

FCA: Fibre Channel Adapter.

FCBQ: Fan Control Board for QBB.

FCBS: Fan Control Board for SPS.

FDA: Fibre Disk Array.

FDD: Floppy Disk Drive.

Flash EPROM: Flash Erasable Programmable Read-Only Memory. A type of memory device that is used to store the the system firmware code. This code can be replaced by an updated code from a floppy disk, but is not lost when the computer is powered off.

Firewall: A set of related programs, located at a network gateway server, that protects the resources of a private network from users from other networks.

Firmware: an ordered set of instructions and data stored to be functionally independent of main storage.

Format: The process used to organize a hard or floppy disk into sectors so that it can accept data. Formatting destroys all previous data on the disk.

FPB: FAME Power Board (FAME: Flexible Architecture for Multiple Environments).

FPGA: Field Programmable Gate Array. A gate array that can reprogrammed at run time.

FRB: Fault Resilient Boot. A server management feature. FRB attempts to boot a system using the alternate processor or DIMM.

FRU: Field Replaceable Unit. A component that is replaced or added by Customer Service Engineers as a single entity.

FSS: FAME Scalability Switch. Each CSS Module is equipped with 2 Scalability Port Switches providing high speed bi-directional links between server components. See SPS.

FTP: File Transfer Protocol. A standard Internet protocol: the simplest way of exchanging files between computers on the Internet. FTP is an application protocol that uses Internet TCP/IP protocols. FTP is commonly used to transfer Web page files from their creator to the computer that acts as their server for everyone on the Internet. It is also commonly used to download programs and other files from other servers.

FWH: FirmWare Hub.

G

GB: GigaByte: 1,073,741,824 bytes. See Byte.

GUI: Graphical User Interface.

GTS: Global Telecontrol Server.

H

HA: High Availability. Refers to a system or component that is continuously operational for a desirably long length of time.

HA CMP: High Availability Clustered MultiProcessing.

Hard Disk Drive: HDD. See Disk Drive.

Hardware: The physical parts of a system, including the keyboard, monitor, disk drives, cables and circuit cards.

Hardware Monitor: A PAM feature used to supervise server operation.

HBA: Host Bus Adapter.

HDD: Hard Disk Drive. See Disk Drive.

History File: A file in which the History Manager logs informative messages or error messages relating to system activity. Messages are sent from source components to target components.

History Manager: The component running on the PAP Windows operating system that logs messages to history files.

HPB: Hot Plug Board. This board provides an interlock switch on each IO Box PCI slot for hot-swapping PCI boards. See P-HPB.

HPC: High Performance Computing.

Hot plugging: The operation of adding a component without interrupting system activity.

Hot swapping: The operation of removing and replacing a faulty component without interrupting system activity.

HTTP: HyperText Transfer Protocol. In the World Wide Web, a protocol that facilitates the transfer of hypertext-based files between local and remote systems.

HW Identifier: Number (0 – F) used to identify Cellblock components. This number is identical to PMB code-wheel position.

I

I2C: Intra Integrated Circuit. The I2C (Inter-IC) bus is a bi-directional two-wire serial bus that provides a communication link between integrated circuits (ICs).

The I2C bus supports 7-bit and 10-bit address space devices and devices that operate under different voltages.

IA64: is a 64-bit Intel processor Architecture based on Explicitly Parallel Instruction Computing (EPIC). The Itanium processor is the first in the Intel line of IA-64 processors.

IB: Infini Band.

IC: Integrated Circuit. An electronic device that contains miniaturized circuitry. See Chip.

ICH4: I/O Control Hub.

ICMB: Intelligent Chassis Management Bus.

ID: A number which uniquely identifies a device on a bus.

IDE: Integrated Drive Electronics. A type of hard disk drive with the control circuitry located inside the disk drive rather than on a drive controller card.

Identity: See Domain Identity.

IIS: Internet Information Server. A group of Internet servers (including a Web or HTTP server and a FTP server) with additional capabilities for Microsoft Windows NT and Microsoft Windows (and later) operating systems.

I/O: Input /Output. Describes any operation, program, or device that transfers data to or from a computer.

Interface: A connection between a computer and a peripheral device enabling the exchange of data. See Parallel Port and Serial Port.

IOB: Input / Output Board. The IOB connects up to 11 PCI-X boards.

IOC: Input / Output Board Compact. The IOC connects up to 6 PCI-X boards.

IOL: I/O Board Legacy. The IOL provides:

- I/O controller Hub
- USB ports
- 10/100/1000 Ethernet controller
- Video controller
- Serial / debug port

IOR: I/O Board Riser. The IOR provides:

- I/O controller Hub
- USB ports
- 10/100/1000 Ethernet controller
- Video controller
- Serial / debug port

IP: Internet Protocol. The protocol by which data is sent from one computer to another via the Internet. Each computer (known as a host) on the Internet has at least one IP address that uniquely identifies it from all other computers on the Internet.

IPD: Internal Peripheral Drawer. The IPD houses legacy peripherals (DVD-Rom drive, USB port) and SCSI system disks.

IPF: Itanium Processor Family.

IPL: Initial Program Load. It defines the firmware functional phases during the system initialization.

IPMB: Intelligent Platform Management Bus.

IPMI: Intelligent Platform Management Interface.

ISA: Industry Standard Architecture. An industry standard for computers and circuit cards that transfer 16 bits of data at a time.

J

Jumper: A small electrical connector used for configuration on computer hardware.

K

KVM: Keyboard Video Monitor.

KVM switch: the Keyboard Video Monitor switch allows the use of a single keyboard, monitor and mouse for more than one module.

L

LAN: Local Area Network. A group of computers linked together within a limited area to exchange data.

LD: Logical Disk. A Storeway FDA 1300/2300 logical disk (or LUN) is visible to the OS as a Disk. See LUN and PD (Physical Disk).

LED: Light Emitting Diode. A small electronic device that glows when current flows through it.

Legacy Application: An application in which a company or organization has already invested considerable time and money. Typically, legacy applications are database management systems (DBMSs) running on mainframes or minicomputers.

LPT1 or LPT2: The name assigned to a parallel port to specify its address. See Parallel Port.

LS240: Laser Servo super diskette holding up to 240 Mb.

LUN: Logical Unit Number. Term used to designate Logical Storage Units (logical disks) defined through the configuration of physical disks stored in a mass storage cabinet.

LVDS: Low Voltage Differential SCSI.

M

MAESTRO: Machine Administration Embedded Software Real Time Oriented. Part of the PAM software package embedded on the PMB board.

MCA: Machine Check Abort.

Memory: Computer circuitry that stores data and programs. See RAM and ROM.

Memory bank: The minimum quantity of memory used by the system. It physically consists of four memory DIMMs.

MFL: Midplane Fan & Logistics board. The MFL houses the Fan Boxes and is connected to the MIO and MQB. See MIO, MQB.

Microprocessor: An integrated circuit that processes data and controls basic computer functions.

Midplane: Mid-Plane. All system hardware components are connected to the Midplane.

MIMD: Multiple Instruction Multiple Data

MIO: Midplane Input / Output board. The MIO connects one or two IOC boards and the PMB. See Core Unit.

Mirrored volumes: A mirrored volume is a fault-tolerant volume that duplicates your data on two physical disks. If one of the physical disks fails, the data on the failed disk becomes unavailable, but the system continues to operate using the unaffected disk.

Module: a Midplane Board with all its connected components and utility devices. See CSS Module and MP.

MQB: Midplane **QBB** board. The MQB connects one or two QBBs and one or two IPDs. See QBB and IPD.

MSX: Midplane **SPS & XPS** board. The MSX houses a B-SPS switch and is connected to the MIO and the MQB. There are two MSX boards in a CSS module. All SP connections between a QBB and an IOC use an MSX. See B-SPS, MIO, MQB.

MTBF: Mean Time Between Failure. An indicator of expected system reliability calculated on a statistical basis from the known failure rates of various components of the system. Note: MTBF is usually expressed in hours.

Multimedia: Information presented through more than one type of media. On computer systems, this media includes sound, graphics, animation and text.

Multitasking: The ability to perform several tasks simultaneously. Multitasking allows you to run multiple applications at the same time and exchange information among them.

N

NFS: Network File System. A proprietary distributed file system that is widely used by TCP/IP vendors. Note: NFS allows different computer systems to share files, and uses user datagram protocol (UDP) for data transfer.

NMI: Non-Maskable Interrupt.

NUMA: Non Uniform Memory Access. A method of configuring a cluster of microprocessors in a multiprocessing system so that they can share memory locally, improving performance and the ability of the system to be expanded.

nsh: nsh stands for new shell. See Shell and EFI Shell.

NVRAM: Non Volatile Random Access Memory. A type of RAM that retains its contents even when the computer is powered off. See RAM and SRAM.

O

OF: Open Firmware. Firmware controlling a computer prior to the Operating System.

Operating System: See OS.

OS: Operating System. The software which manages computer resources and provides the operating environment for application programs.

P

PAL: Processor Abstraction Layer. See SAL.

PAM: Platform Administration & Maintenance.

PAM software: Platform Administration & Maintenance software. One part (PAP application and the PamSite WEB site) runs on the PAP unit. The other part (MAESTRO) is embedded on the PMB board.

PAM Tree pane: One of the three areas of the PAM web page. Server hardware presence and functional status are displayed in the PAM Tree pane. See Status pane and Control pane.

PAP unit: Platform Administration Processor unit. The PC hosting all server administration software.

PAP application: Platform Administration Processor application. Part of PAM software, PAP application is a Windows COM+ application running on PAP unit.

Parallel Port: Connector allowing the transfer of data between the computer and a parallel device.

PARM request: the PARM application is designed to handle Requests issued by the CSE (Customer Service Engineer)

Partition: Division of storage space on a hard disk into separate areas so that the operating system treats them as separate disk drives.

Password: A security feature that prevents an unauthorized user from operating the system.

PCI: Peripheral Component Interconnect. Bus architecture supporting high-performance peripherals.

PD: Physical Disk. A Storeway FDA 1300/2300 physical disk is not visible to the OS. See LD.

PDU: Power Distribution Unit. Power bus used for the connection of peripheral system components.

Permanence: Property of a history file that determines whether or not the history file can be modified or deleted from the PAM user interface. Permanence is either *Static* (cannot be modified) or *Dynamic* (can be modified).

P-HPB: PCI Hot Plug Board. This board provides an interlock switch on each IO Box PCI slot for hot-swapping PCI boards. See HPB.

PIC: Platform Instrumentation Control.

ping: A basic Internet program that lets you verify that a particular IP address exists and can accept requests. The verb “to ping” means the act of using the ping utility or command.

PIROM: Processor Information ROM. Processor Information ROM (PIROM) contains information about the specific processor in which it resides. This information includes robust addressing headers to allow for flexible programming and forward compatibility, core and L2 cache electrical specifications, processor part and S-spec numbers, and a 64-bit processor number.

PMB: Platform Management Board. Links the server to the PAP unit.

PNP: Plug aNd Play. The ability to plug a device into a computer and have the computer recognize that the device is there.

POST: Power On Self Test. When power is turned on, POST (Power-On Self-Test) is the diagnostic testing sequence (or “starting program”) that a computer runs to determine if hardware is working correctly.

PROM: Programmable Read-Only Memory.

PUID: PAM Universal/Unique IDentifier. PAM software allocates a PUID (PAM Universal / Unique Identifier) to each hardware / software object to guarantee unambiguous identification. The PUID for each hardware element can be obtained by hovering the mouse over the corresponding element in the PAM tree, e.g.: PAM:/CELLSBLOCK_<NAME>/MODULE_x/QBB_y/CPU_y.

Q

QBB: Quad Brick Board. The QBB is the heart of the Bull NovaScale Server, housing 4 Itanium® 2 processors and 16 DIMMs. Each QBB communicates with other CSS Module components via 2 high-speed bidirectional Scalability Port Switches. See SPS or FSS.

R

RAID: Redundant Array of Independent Disks. A method of combining hard disk drives into one logical storage unit for disk-fault tolerance.

RAM: Random Access Memory. A temporary storage area for data and programs. This type of memory must be periodically refreshed to maintain valid data and is lost when the computer is powered off. See NVRAM and SRAM.

RAS: Reliability, Availability, Serviceability.

Real-time clock: The Integrated Circuit in a computer that maintains the time and date.

RFI: Radio Frequency Interference.

RJ45: 8-contact regular jack.

RMC: Remote Maintenance Console.

ROM: Read-Only Memory. A type of memory device that is used to store the system BIOS code. This code cannot be altered and is not lost when the computer is powered off. See BIOS, EPROM and Flash EPROM.

RS-232 Port: An industry standard serial port. See Serial Port.

RSF: Remote Service Facilities.

RTC: Real Time Clock.

S

S@N.IT: SAN Administration Tool.

SAL: System Abstraction Layer. See PAL.

SAN: Storage Area Network. A high-speed special-purpose network that interconnects different kinds of data storage devices with associated data servers on behalf of a larger network of users.

SAPIC: Streamlined Advanced Programmable Interrupt Controller message.

SBE: Single Bit Error.

Scheme: Configuration file ensuring optimum use and compatibility of the physical and logical resources used to simultaneously run multiple domains.

SCI: Scalable Coherent Interface.

SCSI: Small Computer System Interface. An input and output bus that provides a standard interface used to connect peripherals such as disks or tape drives in a daisy chain.

SDR: Sensor Data Record.

SDRAM: Synchronous Dynamic Random Access Memory. A type of DRAM that runs at faster clock speeds than conventional memory. See DRAM.

SEL: System Event Log. A record of system management events. The information stored includes the name of the event, the date and time the event occurred and event data. Event data may include POST error codes that reflect hardware errors or software conflicts within the system.

Serial Communication: Data sent sequentially, one bit at a time.

Serial Port: Connector that allows the transfer of data between the computer and a serial device. See COM1 or COM 2. Shell is a Unix term for the interactive user interface with an operating system.

SIO: Server I/O / Super I/O.

Shell: The Shell is the layer of programming that understands and executes the commands a user enters. As the outer layer of an operating system, the Shell can be contrasted with the kernel, the inmost layer or core of services of an operating system. See EFI Shell.

SIOH: Server I/O Hub.

SMBIOS: System Management BIOS.

SM-BUS: System Management Bus.

SMIC: Server Management Interface Chip.

SMP: Symmetrical Multi Processor. The processing of programs by multiple processors that share a common operating system and memory.

SNC: Scalable Node Controller.

SNM: System Network Module.

SNMP: Simple Network Management Protocol. The protocol governing network management and the monitoring of network devices and their functions.

Source: Each message refers to a source (the resource that generated the message) and a target (the component referred to in the message). This feature can be allows messages to be filtered according to one or more **Source** string(s) and is particularly useful for debugging and troubleshooting. See Target.

SPS: Scalability Port Switch. Each CSS Module is equipped with 2 Scalability Port Switches providing high speed bi-directional links between system components. See FSS.

SRAM: Static RAM. A temporary storage area for data and programs. This type of memory does not need to be refreshed, but is lost when the system is powered off. See NVRAM and RAM.

SSI: Server System Infrastructure.

Status Pane: One of the three areas of the PAM web page. Provides quick access to CSS Module availability status, server functional status, and pending event message information. See also Control pane and PAM Tree pane.

SVGA: Super Video Graphics Array.

T

Target: Each message refers to a target (the component referred to in the message), identified by its PUID, and a source (the component that generated the message). This feature allows messages to be filtered according to one or more **Target** string(s) and is particularly useful for debugging and troubleshooting. See Source and PUID.

TCP: Transmission Control Protocol. A set of rules (protocol) used along with the Internet Protocol (IP) to send data in the form of message units between computers over the Internet.

TCP/IP: Transmission Control Protocol / Internet Protocol. The basic communication language or protocol of the Internet.

T&D: Tests and Diagnostics.

Thresholding: A PAM Event filter criterion. Thresholding is defined on a Count / Time basis aimed at routing significant messages only. Identical messages are counted and when the number of messages indicated in the **Count** field is reached within the period of time indicated in the **Time** field, this message is selected for routing.

U

UART: a Universal Asynchronous Receiver Transmitter. The microchip with programming that controls a computer interface to its attached serial devices.

ULTRA SCSI: An enhanced standard 16-bit SCSI interface providing synchronous data transfers of up to 20 MHz, with a transfer speed of 40M bytes per second. It is also called Fast-20 SCSI.

UML: Unified Modeling Language. A standard notation for the modeling of real-world objects as a first step in developing an object-oriented design methodology.

UPS: Uninterruptible Power Supply. A device that allows uninterrupted operation if the primary power source is lost. It also provides protection from power surges.

URL: Uniform / Universal Resource Locator. The address of a file (resource) accessible on the Internet.

USB: **U**niversal **S**erial **B**us. A plug-and-play interface between a computer and add-on devices. The USB interface allows a new device to be added to your computer without having to add an adapter card or even having to turn the computer off.

V

VCC: **V**oltage **C**ontinuous **C**urrent.

VGA: **V**ideo **G**raphics **A**rray.

VI: **V**irtual **I**nterface.

Visibility: A property of a history file. Visibility is either *System* (the history file is predefined by the PAM software and is visible only to an administrator) or *User* (the history file is created by an administrator and is visible to both an administrator and an operator).

VLAN: **V**irtual **L**ocal **A**rea **N**etwork. A local area network with a definition that maps workstations on some other basis than geographic location (for example, by department, type of user, or primary application).

VxWORKS: Platform Management Board Operating System.

W

WAN: **W**ide **A**rea **N**etwork. Geographically dispersed telecommunications network. The term distinguishes a broader telecommunication structure from a local area network (LAN).

WBEM: **W**eb **B**ased **E**nterprise **M**anagement.

WMI: **W**indows **M**anagement **I**nterface.

WOL: A feature that provides the ability to remotely power on a system through a network connection.

X

XML: **eX**tended **M**arkUp **L**anguage. A flexible way to create common information formats and share both the format and the data on the World Wide Web, intranets, and elsewhere.

XSP: **eX**tended **S**calable **P**ort.

Y

No entries.

Z

No entries.

Index

Numbers

- 16–port KVM Switch, data cables, B-39
- 8–Port KVM Switch, data cables, B-4, B-21

A

- Access, front door, 1-21
- Alarm, tamper, 1-21
- Archive
 - history, 4-33
 - viewing, online, 4-33
- Array partition, creating, 5-7
- Autocall settings, checking, 4-42
- Autocalls
 - configuring, 5-25
 - FTP parameters, 5-25

B

- Back Up, PAM software, 5-31
- BIOS
 - error messages, C-2
 - POST codes, 3-58
 - post codes, C-1
- BIOS info, domain, 3-33
- Boot
 - error messages, C-33
 - options, 5-13
- Boot LUN, changing, 3-51
- Boot manager, EFI, 5-13

C

- CD–ROM drive, 1-15
 - accessing, 1-24
- Cell
 - adding a cell to a domain, 3-44
 - removing a cell from a domain, 3-47
- Channels, enabling / disabling, 5-96
- Checking
 - environmental conditions, 4-40
 - events, 4-41
 - fault status, 4-41
 - hardware availability, 4-40
 - hardware connections, 4-41
 - histories, 4-41
 - PMB, 4-43
 - power status, 4-41
 - SNMP settings, 4-42
 - temperature status, 4-41
- Checking
 - Autocall settings, 4-42
 - MAESTRO version, 4-42
 - PAM version, 4-42
 - writing rules, 4-42
- Checks, server status, 2-6
- Clipping, 5-104
- CMOS, error messages, C-35
- Components
 - 5080, 1-7

- 5160, 1-8
 - 6080, 1-9
 - 6320, 1-11
 - 6160, 1-10
 - Configuration, requirements, assessing, 5-36
 - Configuring, event messaging, 5-85
 - Connecting to, server domain
 - Enterprise LAN, 2-22
 - Web, 2-23
 - Connection, hardware, 3-58
 - Console, 1-16
 - data cables, B-3, B-20, B-37
 - opening / closing, 1-22
 - setting up, 1-23
 - toggleing, 2-8
 - Console drawer, closing, 1-24
 - CSS , functional status / domain state, 4-38
 - CSS hardware, functional status, 4-4
 - CSS Module, PMB, 4-44
 - CSS module, 1-13
 - availability status, 2-6, 4-4
 - power, 4-18
 - thermal zone, 4-16
 - Customer information, modifying, 5-24
 - Customizing, PAM settings, 5-27
- ## D
- Data cables
 - integrated console, B-3, B-20
 - 16–port KVM Switch, B-39
 - 8–port KVM Switch, B-4, B-21
 - console, B-37
 - Ethernet hub, B-15, B-33, B-53
 - FDA 1300 FC disk rack, B-12, B-30
 - FDA 1300 FC extension disk rack, B-13, B-31, B-49
 - FDA 2300 FC extension disk rack, B-51
 - IOR, B-6, B-23
 - IOR (KVM AV1000R), B-41
 - NPort server, B-29, B-47
 - PAP unit, B-8, B-25, B-42
 - PMB, B-14, B-32, B-52
 - SJ–0812 disk rack, B-44
 - SJ–0812 SCSI disk rack, B-10, B-27
 - SR–0812 disk rack, B-45
 - SR–0812 SCSI disk rack, B-11, B-28
 - Storeway FDA 1300 disk rack, B-48
 - Storeway FDA 2300 disk rack, B-50
 - Data disks (FC), configuring, 5-8
 - Data disks (SCSI), configuring, 5-4
 - Delivery, system, 1-2
 - Details pane, PAM, 2-7
 - DIMMs, 1-13
 - Disk array
 - creating a new array partition, 5-7
 - creating a new SCSI disk array, 5-6
 - Disk subsystem, data disks, 5-8
 - Diskette drive, accessing, 1-24

Disks, 1-15, 1-18
array partition, 5-7
configuring FC data disks, 5-8
configuring SCSI data disks, 5-4

Documentation
highlighting, xvii
preface, iii
related publications, xviii

Domain
BIOS info, 3-33
deleting, 3-53
dump, 3-27, 3-58
force power OFF, 3-58
force power off, 3-24
functional status, 3-30
hardware resources, 3-35
incidents, 3-56
modifying configuration, 3-42
power down, 2-9, 2-10, 2-11
power logs, 3-31
power OFF, 3-58
power off, 3-18
power on, 3-15
power ON , 3-58
power up, 2-9, 2-10, 2-11
powering sequences, 3-32
request logs, 3-34
reset, 3-21, 3-58

Domain configuration, 3-42
adding a cell, 3-44
removing a cell, 3-47

Domain identity. *See* identity

Domain manager, 3-2

Domain scheme. *See* scheme

Domains
configuring, 5-33
incidents, 3-58
managing, 3-1
powering ON / OFF, 4-42

Dump, domain, 3-27

DVD/CD-ROM drive, 1-13

E

E-mail

creating an e-mail account, 5-90
creating an e-mail server, 5-88
deleting an e-mail account, 5-91
deleting an e-mail server, 5-89
editing e-mail account attributes, 5-91
editing e-mail server attributes, 5-89

EFI

boot manager, 5-13
boot manager options, 5-13
file transfer protocol, 5-20
manual network configuration, 5-19
network setup and configuration, 5-19
shell, 5-15

EFI boot, options, 5-13

EFI shell

command syntax, 5-15
commands, 5-17
script, 5-17
starting, 5-15

Electrical safety, xxi

Enterprise LAN, server domain

Linux, connecting, 2-22

Windows, connecting, 2-22

Environmental conditions, checking, 4-40

Error messages

BIOS, C-2

boot, C-33

CMOS, C-35

miscellaneous, C-35

storage device, C-33

system configuration, C-34

Ethernet hub, 1-19

data cables, B-15, B-33, B-53

Ethernet ports, 1-13, 1-15

Event filter

advanced filtering criteria, 5-104

creating a new filter, 5-110

deleting, 5-111

editing filter attributes, 5-111

preselecting, 5-109

standard filtering criteria, 5-101

Event message, status, 4-4

Event messages

acknowledging, 4-29

consulting, 4-28

customizing, 5-85

e-mail, viewing, 4-30

enabling / disabling channels, 5-96

managing, 4-26

severity, 5-104

severity levels, 4-27

sorting / locating, 4-30

source, 5-104

subscription, 5-85

target, 5-104

viewing, 4-26

Event subscription

See Subscriptions, 5-97

flowchart, 5-87

Events, checking, 4-41

Example scheme

mono-domain

all resources, 5-45

part of resources, 5-53

multi-domain

all resources, 5-61

part of resources, 5-69

Exclude / include, monitoring, 4-14

Excluding

hardware, 4-22

hardware element, 4-41

Excluding , hardware, 4-22

Exclusion, hardware, 3-58

Extended system, configuring, managing, 5-76

F

Fail-over, policy, 1-25

Fault list, monitoring, 4-14

Fault status, checking, 4-41

FDA 1300 FC Disk rack, data cables, B-12, B-30

FDA 1300 FC extension Disk rack, data cables,
B-13, B-31, B-49

- FDA 2300 FC extension Disk rack, data cables, B-51
- FDD, 1-15
- Features, system, A-1
- Firmware information, 4-16
- Force power off, domain, 3-24
- Front door, opening, 1-21
- FRU information, 4-15
- Functional status, CSS hardware, 4-4
- functional status, domain, 3-30

G

- Getting to know, server, 1-7

H

- Hardware
 - connections, 3-58
 - excluding, 4-22, 4-41
 - exclusion, 3-58
 - including, 4-22, 4-23
 - limiting access, 5-79
- Hardware availability, checking, 4-40
- Hardware connections, checking, 4-41
- Hardware faults list
 - consulting, 4-28
 - displaying, 4-30
- Hardware monitor, CSS module power, 4-18
- Hardware resources
 - checklist, 5-80
 - domain, 3-35
- Highlighting, documentation, xvii
- Histories
 - checking, 4-41
 - creating a user history, 5-93
 - deleting, 5-95
 - editing parameters, 5-94
- History
 - archiving, 4-33
 - viewing, online, 4-31
- History / archive, viewing, offline, 4-35
- History file, deleting, manually, 4-35
- History files
 - archiving, 4-31
 - consulting, 4-28
 - deleting, 4-31
 - managing, 4-26
 - viewing, 4-26

I

- Identity
 - checklist, 5-80
 - copying, 5-44
 - creating, 5-43
 - deleting, 5-44
 - editing, 5-44
 - managing, 5-43
- Illegal characters, xxiii
- Incident
 - investigating, 4-37
 - what to do, 4-37, 4-40
- Incidents
 - dealing with, 3-58
 - domain, 3-56

- Include / exclude, monitoring, 4-14
- Including, hardware, 4-22, 4-23
- Indicators

- fault status, 4-14, 4-15
- failure status, 4-14, 4-15
- functional status, 4-7, 4-14
- power status, 4-17
- presence status, 4-6, 4-14
- temperature status, 4-19

- Initialization, C-16, C-22, C-23

- IOB, 1-13, 1-14

- jumper status, 4-20
- PCI slot status, 4-21

- IOR, 1-13

- data cables, B-6, B-23

- IOR (16-port KVM Switch), data cables, B-41

- iSM, 5-7, 5-10

K

- Keyboard, 1-16
- Keys, registry, xxiv
- KVM switch, 1-17

L

- Laser safety, xxii
- LEDs, PMB, 4-44
- Linux, system users, 5-3
- Linux domain, remote access, Web, 2-21
- Linux Redhat, remote access, enterprise LAN, 2-19
- Linux SuSE domain, remote access, enterprise LAN, 2-20
- LS240 drive, 1-13
- LUN
 - changing the EFI boot, 3-51
 - creating, 5-10
- LUN list, updating, 5-78
- LUN properties, modifying, 4-42

M

- MAESTRO version, checking, 4-42
- Managing
 - domain schemes, 5-37, 5-43
 - domains, 3-2
- Memory boards, 1-13
- Message, severity levels, C-36
- Messages, PAM, C-36
- Microsoft Windows, system users, 5-3
- Midplane, firmware information, 4-16
- Mirroring, PAP unit, 1-25
- Modem, 1-19
- Modifying, customer information, 5-24
- Modifying, LUN properties, 4-42
- Monitor, 1-16
- Monitoring
 - failure status, 4-14, 4-15
 - fan status, 4-20
 - fault list, 4-14
 - fault status, 4-14, 4-15
 - firmware information, 4-16
 - FRU information, 4-15
 - functional status, 4-14
 - Hardware Search engine, 4-9
 - hardware status, 4-14

- include / exclude, 4-14
- jumper status, 4-20
- PAM Tree, 4-5
- PCI slot status, 4-21
- power status, 4-17
- presence status, 4-14
- server, 4-1, 4-2
- Status pane, 4-3
- temperature status, 4-19
- thermal zones, 4-16

Mother boards, 1-13

Mouse, 1-16

MPI, 1-13, 1-14

N

Notices

- electrical safety, xxi

- laser safety, xxii

- safety, xxi

NPort Server, 1-19

- data cables, B-29, B-47

NVRAM variables, clearing, loading, saving, 5-77

O

Overview, documentation, iii

P

PAM

- connection, 2-2

- customizing, 5-85

- details pane, 2-7

- event messaging, 5-85

- messages, C-36

- simultaneous connection, 2-4

- software package, 1-25

- status pane, 2-6, 4-3

- toolbar, 2-7

- tree pane, 4-5

- user information, 4-10

- user interface, 2-5

- writing rules, xxiii

PAM settings, customizing, 5-27

PAM software

- activating a version, 5-29

- back up / restore, 5-31

- deploying a new release, 5-28

- monitoring, 4-2

PAM tree pane, 2-7

PAM version, checking, 4-42

PAM version information, viewing, 4-11

PAP application, rebooting, 3-58, 4-42

PAP unit, 1-15

- CD-ROM drive, 1-15

- data cables, B-8, B-25, B-42

- diskette drive, 1-24

- disks, 1-15

- DVD-CD Rom drive, 1-24

- Ethernet ports, 1-15

- FDD, 1-15

- mirroring, 1-25

- serial ports, 1-15

PAP users, setting up, 5-22

Partitioning, 5-34

PDU, 1-20

PHPB, 1-13

PMB, 1-13, 1-14

- checking, 4-43

- code wheels, 4-44

- data cables, B-14, B-32, B-52

- firmware information, 4-16

- rebooting, 3-58

- resetting, 4-43

- testing, 4-43

POST codes

- ACPI, C-26

- BIOS, C-1

- DIM checkpoints, C-24

- EFI, C-26

- IA-32, C-14

- PAM – BIOS interface, C-30

- PCI diagnostic, C-25

- recovery, C-27

- runtime, C-29

- SAL-A, C-3

- SAL-A hang, C-7

- SAL-B, C-9

- SAL-B hang, C-11

- SAL-F, C-12

- SAL-F hang, C-13

Power, CSS module, 4-18

Power cables, 1-15, 1-16, 1-17, 1-18, 1-20

Power down, server domain, 2-9, 2-10, 2-11

Power logs, domain, 3-31

Power off, domain, 3-18

Power on, domain, 3-15

Power sequences, domain, 3-32

Power status, checking, 4-41

Power supply cables, server, B-17, B-35, B-55

Power-up

- server domain, 2-9, 2-10, 2-11

- system domains, 2-15, 2-18

Powering ON / OFF, domains, 4-42

Processors, 1-13

Q

QBB, fan status, 4-20

QBB fan boxes, 1-13, 1-14

QBBs, 1-13, 1-14

R

RAID controller, 1-18

Rebooting, PAP application, 4-42

Related publications, documentation, xviii

Remote access

- Enterprise LAN, 2-19

- Linux Redhat Domain, 2-19

- Linux SuSE domain, 2-20

- Windows domain, 2-19

- Web, 2-21

- Linux domain, 2-21

- Windows domain, 2-21

Request logs, domain, 3-34

Reset, domain, 3-21

Resetting, PMB, 4-43

Resources, server, 1-25

Restoring, PAM software, 5-31

S

Safety, notices, xxi

Scheme

- adding to the current scheme, 3-11
- checklist, 5-80
- copying, 5-42
- creating, 5-37
- deleting, 5-42
- editing, 5-40
- loading, 3-9
- managing, 3-6, 5-37
- renaming, 5-42
- replacing the current scheme, 3-11
- saving the current scheme snapshot, 3-12
- viewing, 3-7

SCSI HBA, 1-13

SCSI JBOD rack, 1-18

SCSI rack, 1-18

Search, hardware, 4-9

Serial ports, 1-13, 1-15

Server

- See also* system
- domain, 2-9, 2-10, 2-11
- getting to know, 1-7
- monitoring, 4-1, 4-2
- partitioning, 5-34
- power supply cables, B-17, B-35, B-55
- resources, 1-25

Server components

- accessing, 1-21
- CD-ROM drive, 1-15
- console, 1-16
- CSS module, 1-13
- DIMMs, 1-13
- disks, 1-18
- Ethernet hub, 1-19
- Ethernet ports, 1-13, 1-15
- FDD, 1-15
- IOB, 1-13, 1-14
- IOR, 1-13
- keyboard, 1-16
- KVM switch, 1-17
- LS240 drive, 1-13
- memory boards, 1-13
- Midplane, 1-13, 1-14
- modem, 1-19
- monitor, 1-16
- mother boards, 1-13
- mouse, 1-16
- NPort Server, 1-19
- PAP unit, 1-15
- PAP unit disks, 1-15
- PDU, 1-20
- PHPB, 1-13
- PMB, 1-13
- power cables, 1-15, 1-16, 1-17, 1-18, 1-20
- processors, 1-13
- QBB fan boxes, 1-13, 1-14
- QBBs, 1-13, 1-14
- RAID controller, 1-18
- SCSI HBA, 1-13
- SCSI JBOD rack, 1-18
- SCSI rack, 1-18

- serial ports, 1-13, 1-15
- SPS fan boxes, 1-13, 1-14
- USB ports, 1-13
- VGA port, 1-13

Server status, checking, 2-6

Setting up

- console, 1-23
- PAP users, 5-22
- system users, 5-3

Severity

- event message, 4-27
- message, C-36

SJ-0812 disk rack, data cables, B-44

SJ-0812 SCSI disk rack, data cables, B-10, B-27

Snapshot, saving the current scheme, 3-12

SNMP settings, checking, 4-42

Specifications

- NovaScale 5080/5160 Servers, A-1
- NovaScale 6080/6160 Servers, A-3
- NovaScale 6320 Servers, A-5
- system, A-1

SPS, fan status, 4-20

SPS fan boxes, 1-13, 1-14

SR-0812 disk rack, data cables, B-45

SR-0812 SCSI disk rack, data cables, B-11, B-28

Status

- CSS module, 2-6, 4-4
- event message, 4-4
- exclude / include, 4-14
- failure indicators, 4-14, 4-15
- fans, 4-20
- fault indicators, 4-14, 4-15
- functional, 4-7
- functional indicators, 4-14
- hardware information, 4-14
- IOB jumper, 4-20
- PCI slots, 4-21
- power, 4-17
- presence, 4-5, 4-6
- presence indicators, 4-14
- temperature indicators, 4-19

Status pane, PAM, 2-6

Storage device, error messages, C-33

Storeway FDA 1300 Disk rack, data cables, B-48

Storeway FDA 2300 Disk rack, data cables, B-50

String lengths, xxiii

Subscriptions

- advanced filtering criteria, 5-104
- channels, 5-96
- creating, 5-97
- deleting, 5-98
- e-mail account, 5-90
- e-mail server, 5-88
- editing attributes, 5-98
- filter, 5-110
- filtering, 5-109
- history, 5-93
- prerequisites, 5-86
- setting up, 5-86
- standard filtering criteria, 5-101
- understanding filters, 5-99

System

- See also* server
- dimensions, A-1

- domains, 2-15, 2-18
 - weight, A-1
- System components, DVD/CD-ROM drive, 1-13
- System configuration, error messages, C-34
- System users
 - Linux, 5-3
 - Microsoft Windows, 5-3
 - setting up, 5-3

T

- Tamper alarm, 1-21
- Temperature status, checking, 4-41
- Test scheme, 5-42
- Testing, PMB, 4-43
- Thermal zone, 4-16
- Thresholding, 5-104
- Toolbar, PAM, 2-7

U

- USB ports, 1-13

- User group, PAP, 5-22
- User interface, PAM, 2-5

V

- VGA port, 1-13

W

- Web, server domain
 - Linux, connecting, 2-23
 - Windows, connecting, 2-23
- Windows domain, remote access
 - enterprise LAN, 2-19
 - Web, 2-21
- Writing rules
 - checking, 4-42
 - illegal characters, xxiii
 - string lengths, xxiii

Vos remarques sur ce document / Technical publication remark form

Titre / Title : Bull NovaScale 5xx0 & 6xx0 User's Guide

N° Référence / Reference N° : 86 A1 94EM 00

Daté / Dated : December 2004

ERREURS DETECTEES / ERRORS IN PUBLICATION

AMELIORATIONS SUGGEREES / SUGGESTIONS FOR IMPROVEMENT TO PUBLICATION

Vos remarques et suggestions seront examinées attentivement.

Si vous désirez une réponse écrite, veuillez indiquer ci-après votre adresse postale complète.

Your comments will be promptly investigated by qualified technical personnel and action will be taken as required.

If you require a written reply, please furnish your complete mailing address below.

NOM / NAME : _____ Date : _____

SOCIETE / COMPANY : _____

ADRESSE / ADDRESS : _____

Remettez cet imprimé à un responsable BULL ou envoyez-le directement à :

Please give this technical publication remark form to your BULL representative or mail to:

**BULL CEDOC
357 AVENUE PATTON
B.P.20845
49008 ANGERS CEDEX 01
FRANCE**

Technical Publications Ordering Form

Bon de Commande de Documents Techniques

To order additional publications, please fill up a copy of this form and send it via mail to:

Pour commander des documents techniques, remplissez une copie de ce formulaire et envoyez-la à :

BULL CEDOC
ATTN / Mr. L. CHERUBIN
357 AVENUE PATTON
B.P.20845
49008 ANGERS CEDEX 01
FRANCE

Phone / Téléphone : +33 (0) 2 41 73 63 96
FAX / Télécopie : +33 (0) 2 41 73 60 19
E-Mail / Courrier Electronique : srv.Cedoc@franp.bull.fr

Or visit our web sites at: / Ou visitez nos sites web à:

<http://www.logistics.bull.net/cedoc>

<http://www-frec.bull.com> <http://www.bull.com>

CEDOC Reference # N° Référence CEDOC	Qty Qté	CEDOC Reference # N° Référence CEDOC	Qty Qté	CEDOC Reference # N° Référence CEDOC	Qty Qté
__ __ __ __ __ [__]		__ __ __ __ __ [__]		__ __ __ __ __ [__]	
__ __ __ __ __ [__]		__ __ __ __ __ [__]		__ __ __ __ __ [__]	
__ __ __ __ __ [__]		__ __ __ __ __ [__]		__ __ __ __ __ [__]	
__ __ __ __ __ [__]		__ __ __ __ __ [__]		__ __ __ __ __ [__]	
__ __ __ __ __ [__]		__ __ __ __ __ [__]		__ __ __ __ __ [__]	
__ __ __ __ __ [__]		__ __ __ __ __ [__]		__ __ __ __ __ [__]	
__ __ __ __ __ [__]		__ __ __ __ __ [__]		__ __ __ __ __ [__]	

[__] : **no revision number means latest revision** / pas de numéro de révision signifie révision la plus récente

NOM / NAME : _____ Date : _____

SOCIETE / COMPANY : _____

ADRESSE / ADDRESS : _____

PHONE / TELEPHONE : _____ FAX : _____

E-MAIL : _____

For Bull Subsidiaries / Pour les Filiales Bull :

Identification: _____

For Bull Affiliated Customers / Pour les Clients Affiliés Bull :

Customer Code / Code Client : _____

For Bull Internal Customers / Pour les Clients Internes Bull :

Budgetary Section / Section Budgétaire : _____

For Others / Pour les Autres :

Please ask your Bull representative. / Merci de demander à votre contact Bull.

BULL CEDOC
357 AVENUE PATTON
B.P.20845
49008 ANGERS CEDEX 01
FRANCE

ORDER REFERENCE
86 A1 94EM 00

