

NovaScale 5xx5 User's Guide

NOVASCALÉ



REFERENCE
86 A1 41EM 05

NOVASCALE

NovaScale 5xx5 User's Guide

Hardware

February 2007

BULL CEDOC
357 AVENUE PATTON
B.P.20845
49008 ANGERS CEDEX 01
FRANCE

REFERENCE
86 A1 41EM 05

The following copyright notice protects this book under Copyright laws which prohibit such actions as, but not limited to, copying, distributing, modifying, and making derivative works.

Copyright © Bull SAS 1992, 2007

Printed in France

Suggestions and criticisms concerning the form, content, and presentation of this book are invited. A form is provided at the end of this book for this purpose.

To order additional copies of this book or other Bull Technical Publications, you are invited to use the Ordering Form also provided at the end of this book.

Trademarks and Acknowledgements

We acknowledge the right of proprietors of trademarks mentioned in this book.

Intel® and Itanium® are registered trademarks of Intel Corporation.

Windows® and Microsoft software® are registered trademarks of Microsoft Corporation.

UNIX® is a registered trademark in the United States of America and other countries licensed exclusively through the Open Group.

Linux® is a registered trademark of Linus Torvalds.

The information in this document is subject to change without notice. Bull will not be liable for errors contained herein, or for incidental or consequential damages in connection with the use of this material.

Preface

Table of Contents

Preface	iii
Intended Readers	xv
Highlighting	xv
Related Publications	xv
Regulatory Specifications and Disclaimers	xvi
Declaration of the Manufacturer or Importer	xvi
Safety Compliance Statement	xvi
European Community (EC) Council Directives	xvi
Federal Communications Commission (FCC) Statement	xvii
FCC Declaration of Conformity	xvii
Canadian Compliance Statement (Industry Canada)	xvii
Laser Compliance Notice	xvii
Definition of Safety Notices	xviii
Electrical Safety	xviii
Laser Safety Information	xix
Data Integrity and Verification	xix
Waste Management	xix
PAM Writing Rules	xx
Illegal Characters	xx
String Lengths	xxi
Registry Keys	xxi
AZERTY/QWERTY Keyboard Lookup Table	xxii
Administrator's Memorandum	xxiii
Operator's Memorandum	xxv
Chapter 1. Introducing the Server	1-1
Bull NovaScale Server Overview	1-2
Dynamic Partitioning	1-2
Extended Configurations	1-2
Cluster Configurations	1-2
Server Features	1-3
Server Hardware	1-4
Central SubSystem Module (CSS Module)	1-4
Front Unit	1-4
Core Unit	1-4
Rear Unit	1-5
Platform Administration Processor (PAP) Unit	1-5
KVM Switch	1-5
Console	1-5
Disk Subsystem	1-5
Additional Peripherals	1-5
Server Firmware and Software	1-5
Conformance to Standards	1-6
Getting to Know the Server	1-7
NovaScale 5085 Partitioned Server	1-7
NovaScale 5165 Partitioned Server	1-8

NovaScale 5245 Partitioned Server	1-9
NovaScale 5325 Partitioned Server	1-10
Server Components	1-12
Central Subsystem (CSS) Module	1-13
Integrated Platform Administration Processor (PAP) Unit	1-14
Integrated Console	1-15
Keyboard / Video / Mouse (KVM) Switch	1-16
8-Port KVM Switch	1-16
16-Port KVM Switch	1-16
KVM Extender	1-16
FDA 1x00 FC Disk Rack	1-17
FDA 2x00 FC Disk Rack	1-17
FDA 1x00 FC Extension Disk Rack	1-18
Ethernet Hub	1-19
USB Modem	1-19
NPort Server	1-19
Accessing Server Components	1-20
Opening the Front Door	1-20
Closing the Front Door	1-20
Opening / Closing the Integrated Console	1-21
Bull NovaScale Server Resources	1-22
System Resource and Documentation CD-Roms	1-22
PAM Software Package	1-22
PAP Unit Mirroring and Failover Policy	1-22
EFI Utilities	1-23
Chapter 2. Getting Started	2-1
Connecting to the PAM Web Site	2-2
Connecting to the PAM Web Site from the Local / Integrated Console	2-2
Connecting to the PAM Web Site from a Remote Computer	2-3
Simultaneous Connection to the PAM Web Site	2-4
PAM User Interface	2-5
Checking Server Status via PAM	2-6
PAM Status Pane	2-6
PAM Control Pane	2-6
CSS Availability Status Bar	2-7
PAM Tree Pane	2-7
Setting up Users	2-8
Toggling the Local / Integrated Console Display	2-9
Powering Up / Down Server Domains	2-10
Powering Up the NovaScale 5xx5 SMP Server Domain	2-10
Powering Down the NovaScale 5xx5 SMP Server Domain	2-11
Powering Up NovaScale 5xx5 Partitioned Server Domains	2-12
Powering Down NovaScale 5xx5 Partitioned Server Domains	2-15
Preparing Server Domains for Remote Access via the Enterprise LAN	2-16
Microsoft Windows Domain	2-16
Linux Redhat Domain	2-16
Linux SuSE Domain	2-17
Preparing Server Domains for Remote Access via the Web	2-18
Microsoft Windows Domain	2-18
Linux Domain	2-18
Connecting to a Server Domain via the Enterprise LAN	2-19
Microsoft Windows Domain	2-19
Linux Domain	2-19

Connecting to the Server via the Web	2-20
Microsoft Windows Domain	2-20
Linux Domain	2-20
Installing Applications	2-21
Chapter 3. Managing Domains	3-1
Introducing PAM Domain Management Tools	3-2
Managing Domain Configuration Schemes	3-5
Synchronizing NovaScale 5xx5 SMP Server Domains	3-6
Viewing a Domain Configuration Scheme	3-6
Loading a Domain Configuration Scheme	3-8
Adding Domains to the Current Domain Configuration	3-10
Replacing the Current Domain Configuration	3-10
Saving the Current Domain Configuration Snapshot	3-11
Powering On a Domain	3-14
Powering On a Single Domain	3-14
Powering On Multiple Domains	3-15
Powering Off a Domain	3-18
Powering Off a Single Domain	3-18
Powering Off Multiple Domains	3-19
Forcing a Domain Power Off	3-21
Forcibly Powering Off a Single Domain	3-22
Forcibly Powering Off Multiple Domains	3-22
Performing a Domain Memory Dump	3-24
Manually Resetting a Domain	3-25
Deleting a Domain	3-26
Viewing a Domain Fault List	3-28
Viewing Domain Functional Status	3-29
Viewing Domain Power Logs	3-31
Viewing Domain Powering Sequences	3-32
Viewing Domain BIOS Info	3-33
Viewing Domain Request Logs	3-34
Viewing Domain Configuration, Resources and Status	3-35
Viewing Domain Configuration	3-35
Viewing Domain Hardware Resources	3-38
Viewing Domain Details and Status	3-38
What To Do if an Incident Occurs	3-42
Dealing with Incidents	3-43
Chapter 4. Monitoring the Server	4-1
Introducing PAM Monitoring Tools	4-2
Viewing System / Component Status	4-3
PAM Status Pane	4-3
CSS Availability Status	4-4
System Functional Status	4-4
Event Message Status	4-4
PAM Tree Pane	4-5
Displaying Presence Status	4-5
Displaying Functional Status	4-7
Using PAM Utilities	4-10
Using the Hardware Search Engine	4-10
Viewing PAM Web Site User Information	4-12
Viewing PAM Version Information	4-13
Viewing Server Hardware Status	4-14

Viewing Detailed Hardware Information	4-15
General Tab	4-15
FRU Info Tab	4-16
Firmware Tab (Core MFL & PMB only)	4-17
Thermal Zones (CSS module only)	4-17
Power Tab	4-18
CSS Module Power Tab	4-19
Temperature Tab	4-20
Fan Status (Fanboxes only)	4-21
Jumper Status (IOC only)	4-21
PCI Slots (IOC only)	4-22
Excluding / Including Hardware Elements	4-23
Excluding a Hardware Element	4-23
Including a Hardware Element	4-24
Excluding / Including Clocks, SPS, XSP Cables and Sidebands	4-27
Excluding / Including Clocks	4-27
Excluding / Including SPS	4-28
Excluding / Including XSP Cables	4-29
Excluding / Including Sidebands	4-30
Managing PAM Messages, Histories, Archives and Fault Lists	4-31
Understanding PAM Message Severity Levels	4-32
Viewing PAM Messages and Fault Lists	4-33
Viewing and Acknowledging PAM Web Event Messages	4-34
Sorting and Locating Messages	4-35
Viewing E-mailed Event Messages	4-35
Viewing Hardware / Domain Fault Lists	4-35
Viewing, Archiving and Deleting History Files	4-36
Viewing History Files Online	4-36
Viewing History Properties	4-37
Manually Archiving History Files	4-38
Viewing Archive Files Online	4-38
Viewing Archive Properties	4-39
Manually Deleting a History Archive File	4-40
Downloading History / Archive Files for Offline Viewing	4-40
Downloading History Viewer	4-40
Downloading History / Archive Files	4-40
Viewing History / Archive Files Offline	4-41
What to Do if an Incident Occurs	4-42
Investigating Incidents	4-42
Dealing with Incidents	4-46
Checking Environmental Conditions	4-46
Checking Hardware Availability	4-46
Checking Hardware Connections	4-47
Excluding a Hardware Element and Checking Exclusion Status	4-47
Checking Hardware Fault Status	4-47
Checking Hardware Power Status	4-47
Checking Hardware Temperature Status	4-47
Checking Histories and Events	4-47
Checking SNMP Settings	4-48
Checking Autocall Settings	4-48
Checking PAM Version	4-48
Checking MAESTRO Version	4-48
Checking Writing Rules	4-48
Powering OFF/ON a Domain	4-48
Rebooting the PAP Application	4-48

Modifying LUN Properties	4-49
Checking, Testing and Resetting the PMB	4-49
PMB LEDs and Code Wheels	4-50
Creating an Action Request Package	4-51
Creating a Default Action Request Package	4-51
Creating a Filtered Action Request Package	4-52
Creating a Custom Package	4-53
Chapter 5. Tips and Features for Administrators	5-1
Setting up Server Users	5-4
Configuring System and Data Disks	5-5
Creating New FC Logical System or Data Disks	5-5
Using the EFI Boot Manager	5-7
EFI Boot Manager Options	5-7
Using the EFI Shell	5-9
Entering the EFI Shell	5-9
EFI Shell Command Syntax	5-9
Variable Substitution	5-9
Wildcard Expansion	5-10
Output Redirection	5-10
Quoting	5-10
Executing Batch Scripts	5-11
Error Handling in Batch Scripts	5-11
Comments in Script Files	5-11
EFI Shell Commands	5-11
EFI Network Setup and Configuration	5-14
Manual EFI Network Configuration	5-14
File Transfer Protocol (FTP)	5-15
Setting up PAP Unit Users	5-17
Predefined PAP User Groups	5-17
Modifying Customer Information	5-19
Configuring Autocalls	5-20
Setting Thermal Units	5-22
Deploying a PAM Release	5-23
Activating a PAM Version	5-24
Backing Up and Restoring PAM Configuration Files	5-26
Backing Up PAM Configuration Files	5-26
Restoring PAM Configuration Data	5-27
Partitioning your Server	5-29
Assessing Configuration Requirements	5-31
Managing Domain Configuration Schemes	5-33
Creating a Domain Configuration Scheme	5-33
Editing a Domain Configuration Scheme	5-48
Copying a Domain Configuration Scheme	5-49
Deleting a Domain Configuration Scheme	5-49
Renaming a Domain Configuration Scheme	5-49
Updating Default Schemes	5-49
Creating, Editing, Copying, Deleting a Domain Identity	5-50
Creating a Domain Identity	5-50
Editing a Domain Identity	5-54
Copying a Domain Identity	5-54
Deleting a Domain Identity	5-54
Managing Logical Units (Servers Not Connected to a SAN)	5-55
Updating the Local LUN Lists	5-56
Clearing, Loading, Saving NVRAM Variables	5-56

Managing Logical Units (Servers Connected to a SAN)	5-57
Updating SAN LUN Lists	5-59
Declaring Local LUNs	5-60
Deleting Local LUNs	5-61
Editing LUNs	5-62
Renaming LUNs	5-63
Clearing, Loading, Saving NVRAM Variables	5-63
Checking and Updating Fibre Channel HBA World Wide Names	5-64
Limiting Access to Hardware Resources	5-66
Locking / Unlocking Hardware Elements	5-67
Creating a Mono-Domain Scheme Using All Server Resources	5-69
Creating a Mono-Domain Scheme Using a Selection of Server Resources	5-83
Creating a Multi-Domain Scheme Using All Server Resources	5-96
Creating a Multi-Domain Scheme Using a Selection of Server Resources	5-111
Configuring and Managing Extended Systems	5-125
Scheme, Domain Identity, and Resources Checklists	5-126
Customizing the PAM Event Messaging System	5-133
Setting up Event Subscriptions	5-134
Event Subscription Flowcharts	5-135
Creating, Editing, Deleting an E-mail Server	5-136
Creating an E-mail Server	5-136
Editing E-mail Server Attributes	5-137
Deleting an E-mail Server	5-137
Creating, Editing, Deleting an E-mail Account	5-138
Creating an E-mail Account	5-138
Editing E-mail Account Attributes	5-139
Deleting an E-mail Account	5-139
Enabling / Disabling Event Channels	5-140
Creating, Editing, Deleting an Event Subscription	5-141
Creating an Event Subscription	5-141
Editing Event Subscription Attributes	5-142
Deleting an Event Subscription	5-142
Understanding Event Message Filtering Criteria	5-143
Standard Event Message Filtering Criteria	5-145
Advanced Event Message Filtering Criteria	5-148
Preselecting, Creating, Editing, Deleting an Event Filter	5-153
Preselecting an Event Filter	5-153
Creating an Event Filter	5-154
Editing Event Filter Attributes	5-155
Deleting an Event Filter	5-155
Creating, Editing, Deleting a User History	5-157
Creating a User History	5-158
Editing History Parameters	5-159
Deleting a User History	5-160
Appendix A. Specifications	A-1
NovaScale 5085 Server Specifications	A-2
NovaScale 5165 Server Specifications	A-4
NovaScale 5245 Server Specifications	A-6
NovaScale 5325 Server Specifications	A-8
Glossary	G-1
Index	X-1

List of Figures

Figure 1.	AZERTY keyboard	xxii
Figure 2.	QWERTY keyboard	xxii
Figure 3.	Bull NovaScale Server cabinets	1-2
Figure 4.	NovaScale 5085 Partitioned Server components - example	1-7
Figure 5.	NovaScale 5165 Partitioned Server components - example	1-8
Figure 6.	NovaScale 5245 Partitioned Server components - example	1-9
Figure 7.	NovaScale 5325 Partitioned Servers components - example	1-10
Figure 8.	NovaScale 5325 Partitioned Servers components - example	1-11
Figure 9.	CSS module features (full CSS module example)	1-13
Figure 10.	PAP unit	1-14
Figure 11.	Integrated console features	1-15
Figure 12.	8-port KVM switch features	1-16
Figure 13.	16-port KVM switch features	1-16
Figure 14.	KVM extender (local & remote) 300m maxi.	1-16
Figure 15.	FDA 1x00 FC disk rack features	1-17
Figure 16.	FDA 2x00 FC disk rack features	1-17
Figure 17.	FDA 1x00 FC extension disk rack features	1-18
Figure 18.	Ethernet hub features	1-19
Figure 19.	USB modem features	1-19
Figure 20.	NPort Server features	1-19
Figure 21.	Opening the front door	1-20
Figure 22.	Integrated console example	1-21
Figure 23.	PAM software deployment	1-22
Figure 24.	PAM Web site session details	2-4
Figure 25.	Multiple session example	2-4
Figure 26.	PAM user interface	2-5
Figure 27.	Status pane	2-6
Figure 28.	CSS Module availability status bar (bi-module server)	2-7
Figure 29.	PAM Tree toolbar	2-8
Figure 30.	Domain Manager Control pane	2-10
Figure 31.	Domain state	2-11
Figure 32.	Domain schemes list dialog	2-13
Figure 33.	Domain Manager Control pane - example with 4 domains	2-13
Figure 34.	Multiple power dialog - example with 4 domains	2-14
Figure 35.	Domain state - example with 4 domains	2-14
Figure 36.	Schemes list dialog	3-7
Figure 37.	Scheme properties dialog - Example with 4 domains	3-7
Figure 38.	Schemes list dialog	3-8
Figure 39.	Domain Manager control pane - Example with 4 domains	3-9
Figure 40.	Domain Infotip	3-9
Figure 41.	Save Snapshot dialog	3-11
Figure 42.	Multiple power dialog - quadri-domain example	3-16
Figure 43.	Multiple power dialog - quadri-domain example	3-19
Figure 44.	Multiple power dialog - quadri-domain example	3-23
Figure 45.	Delete domain dialog - mono-module server	3-26
Figure 46.	Delete Domain dialog - Example with 4 domains	3-26

Figure 47. Domain deleted information box	3-27
Figure 48. Domain fault list dialog - example	3-28
Figure 49. Power logs dialog	3-31
Figure 50. Powering view dialog	3-32
Figure 51. BIOS Info dialog	3-33
Figure 52. Request Logs dialog	3-34
Figure 53. View Domain dialog - example	3-35
Figure 54. View Domain dialog 1/2	3-36
Figure 55. View Domain dialog 2/2	3-37
Figure 56. Domain Hardware Resources dialog	3-38
Figure 57. Domain Hardware Details dialog	3-39
Figure 58. PAM Status pane	4-3
Figure 59. CSS Module availability status bar	4-4
Figure 60. PAM Tree hardware presence status display	4-5
Figure 61. PAM Tree functional status display	4-7
Figure 62. PAM Tree - automatically expanded functional status display	4-9
Figure 63. Hardware Search engine	4-10
Figure 64. Hardware Search result list (example)	4-11
Figure 65. PAM Web Site user information	4-12
Figure 66. PAP unit information	4-13
Figure 67. PAM Hardware Monitor	4-14
Figure 68. General Hardware Status page (example)	4-15
Figure 69. FRU data (example)	4-16
Figure 70. Firmware data (example)	4-17
Figure 71. CSS module thermal zone details	4-17
Figure 72. Converter power status details (example)	4-18
Figure 73. CSS module power status details	4-19
Figure 74. Temperature probe status details (example)	4-20
Figure 75. Fanbox details (example)	4-21
Figure 76. IO Box jumpers tab	4-21
Figure 77. PCI slot status	4-22
Figure 78. PCI slot details dialog (example)	4-22
Figure 79. Inclusion	4-23
Figure 80. Example Hardware Status page	4-24
Figure 81. Ring exclusion control pane - clock tab	4-27
Figure 82. Ring exclusion control pane - SPS tab	4-28
Figure 83. Ring exclusion control pane - XSP cable tab	4-29
Figure 84. Ring exclusion control pane - sideband tab	4-30
Figure 85. Display Events page	4-33
Figure 86. Specimen message help file	4-34
Figure 87. History Manager Control pane - Histories tab	4-36
Figure 88. History properties	4-37
Figure 89. History Manager Control pane - Archived histories tab	4-38
Figure 90. Archive properties	4-39
Figure 91. PMB LED location	4-50
Figure 92. Action Request Package control pane	4-51
Figure 93. Action Request Package details	4-52
Figure 94. Custom Package control pane	4-53
Figure 95. Custom Package Add files pane	4-53

Figure 96. Customer Information configuration page	5-19
Figure 97. Autocalls Channel Settings control pane	5-20
Figure 98. PAM configuration control pane	5-22
Figure 99. PAM Installation InstallShield Wizard	5-23
Figure 100. PAM Activation InstallShield Wizard	5-24
Figure 101. Schemes and Identites panes	5-30
Figure 102. Schemes control pane	5-34
Figure 103. Scheme Management dialog	5-35
Figure 104. Scheme Creation and Central Subsystem Configuration dialogs	5-37
Figure 105. Optimizing partitioning	5-38
Figure 106. Scheme Management dialog - Central Subsystem configured	5-40
Figure 107. Domain Identities list	5-40
Figure 108. EFI LUN selection list	5-41
Figure 109. Select Data LUN dialog - Data luns available list	5-42
Figure 110. View LUN parameters dialog	5-43
Figure 111. Select Data LUN dialog - Data luns selected list	5-44
Figure 112. Link LUNs to HBA dialog	5-44
Figure 113. Select an HBA dialog	5-45
Figure 114. Scheme Management dialog	5-47
Figure 115. Edit Scheme dialog	5-48
Figure 116. Identities List page	5-50
Figure 117. Create New Identity dialog	5-51
Figure 118. Advanced Identity Settings dialog	5-52
Figure 119. Logical Units page - servers not connected to a SAN	5-55
Figure 120. Logical Units page - servers connected to a SAN	5-58
Figure 121. SAN Update progress bar	5-59
Figure 122. Declare Local LUN dialog	5-60
Figure 123. Delete LUN dialog	5-61
Figure 124. Edit LUN dialog	5-62
Figure 125. Rename LUN dialog	5-63
Figure 126. HBA Worldwide Name page	5-64
Figure 127. Modify PCI HBA Worldwide Name dialog	5-65
Figure 128. Lock domain hardware resources dialog	5-67
Figure 129. Lock domain hardware resources dialog - PCI slot selected	5-68
Figure 130. Scheme creation dialog - example 1	5-73
Figure 131. Central Subsystem configuration dialog - example 1	5-75
Figure 132. Scheme Management dialog - example 1	5-77
Figure 133. Identity list dialog - example 1	5-78
Figure 134. Create new identity dialog - example 1	5-78
Figure 135. Create new identity advanced setting dialog - example 1	5-79
Figure 136. Select EFI LUN dialog - example 1	5-79
Figure 137. Select Data LUN dialog - example 1	5-80
Figure 138. Link LUN to HBA dialog - example 1	5-81
Figure 139. Select HBA dialog - example 1	5-81
Figure 140. Scheme creation dialog - example 2	5-87
Figure 141. Central Subsystem configuration dialog - example 2	5-89
Figure 142. Scheme Management dialog - example 2	5-91
Figure 143. Identity list dialog - example 2	5-92
Figure 144. Create new identity advanced setting dialog - example 2	5-92

Figure 145. Create new identity advanced setting dialog - example 2	5-93
Figure 146. Select EFI LUN dialog - example 2	5-93
Figure 147. Select Data LUN dialog - example 2	5-94
Figure 148. Link LUN to HBA dialog - example 2	5-95
Figure 149. Select HBA dialog - example 2	5-95
Figure 150. Scheme creation dialog - example 3	5-101
Figure 151. Central Subsystem configuration dialog - example 3	5-103
Figure 152. Scheme Management dialog - example 3	5-106
Figure 153. Identities list dialog - example 3	5-106
Figure 154. Create new identity dialog - example 3	5-107
Figure 155. Create new identity advanced setting dialog - example 3	5-107
Figure 156. Select SAN EFI LUN dialog - example 3	5-108
Figure 157. Select Local EFI LUN dialog - example 3	5-108
Figure 158. Select Data LUN dialog - example 2	5-109
Figure 159. Link LUN to HBA dialog - example 3	5-110
Figure 160. Select HBA dialog - example 3	5-110
Figure 161. Scheme creation dialog - example 4	5-115
Figure 162. Central Subsystem configuration dialog - example 4	5-117
Figure 163. Scheme Management dialog - example 4	5-119
Figure 164. Identities list dialog - example 4	5-120
Figure 165. Create new identity dialog - example 4	5-120
Figure 166. Create new identity advanced setting dialog - example 4	5-121
Figure 167. Select EFI LUN dialog - example 4	5-121
Figure 168. Select Data LUN dialog - example 4	5-122
Figure 169. Link LUN to HBA dialog - example 2	5-123
Figure 170. Select HBA dialog - example 4	5-123
Figure 171. Lock domain hardware resources - example 4	5-124
Figure 172. PAM event messaging system features	5-133
Figure 173. E-mail servers configuration page	5-136
Figure 174. E-mail accounts configuration page	5-138
Figure 175. Event Channels configuration page	5-140
Figure 176. New Event Subscription dialog box	5-141
Figure 177. Event message standard filtering criteria chart	5-143
Figure 178. Event message advanced filtering criteria chart	5-144
Figure 179. Filters configuration page	5-153
Figure 180. New Filter configuration page - standard event message filtering criteria table	5-154
Figure 181. New Filter configuration page - advanced event message filtering criteria table	5-155
Figure 182. Create a New User History dialog	5-158

List of Tables

Table 1.	PAM illegal characters	vi
Table 2.	String length rules	vii
Table 3.	PAM Tree nodes	2-7
Table 4.	KVM port configuration	2-9
Table 5.	PAM Domain Manager tools	3-4
Table 6.	MyOperations Scheme organization - NovaScale 5xx5 Partitioned Servers	3-13
Table 7.	Power-on states	3-15
Table 8.	Power-on states	3-17
Table 9.	Power-off states	3-18
Table 10.	Power-off states	3-20
Table 11.	Force power-off states	3-22
Table 12.	Power-off states	3-23
Table 13.	Dump states	3-24
Table 14.	Reset states	3-25
Table 15.	Domain functional status indicators	3-30
Table 16.	Domain hardware details icons	3-40
Table 17.	Domain power sequence error messages	3-42
Table 18.	CSS hardware functional status icons	4-4
Table 19.	Hardware presence status indicators	4-6
Table 20.	Hardware functional status indicators	4-8
Table 21.	Fault status indicators	4-16
Table 22.	Power tab status indicators	4-18
Table 23.	Temperature tab status indicators	4-20
Table 24.	Hardware exclusion guidelines - 1	4-25
Table 25.	Hardware exclusion guidelines - 2	4-26
Table 26.	Message severity levels	4-32
Table 27.	CSS functional status / domain state	4-43
Table 28.	NovaScale SMP server domain cell resources	4-44
Table 29.	NovaScale partitioned server domain cell resources	4-45
Table 30.	Boot Option Maintenance Menu	5-8
Table 31.	Wildcard character expansion	5-10
Table 32.	Output redirection syntax	5-10
Table 33.	List of EFI Shell Commands	5-13
Table 34.	User access to PAM features	5-18
Table 35.	Domain configuration assessment criteria - 1	5-31
Table 36.	Domain configuration assessment criteria - 2	5-32
Table 37.	Hardware locking options	5-66
Table 38.	Scheme configuration criteria - example 1 - mono-module server	5-69
Table 39.	Scheme configuration criteria - example 1 - 2 modules server	5-70
Table 40.	Scheme configuration criteria - example 1 - 3 modules server	5-71
Table 41.	Scheme configuration criteria - example 1 - 4 modules server	5-72
Table 42.	Scheme configuration criteria - example 2 - mono-module server	5-83
Table 43.	Scheme configuration criteria - example 2 - bi-module server	5-84
Table 44.	Scheme configuration criteria - example 2 - 3 modules server	5-85
Table 45.	Scheme configuration criteria - example 2 - 4 modules server	5-86
Table 46.	Scheme configuration criteria - example 3 - mono-module server	5-97

Table 47.	Scheme configuration criteria - example 3 - bi-module server	5-98
Table 48.	Scheme configuration criteria - example 3 - 3 modules server	5-99
Table 49.	Scheme configuration criteria - example 3 - 4 modules server	5-100
Table 50.	Scheme configuration criteria - example 4 - bi-module server	5-112
Table 51.	Scheme configuration criteria - example 4 - 3 modules server	5-113
Table 52.	Scheme configuration criteria - example 4 - 4 modules server	5-114
Table 53.	Scheme configuration checklist	5-126
Table 54.	Domain Identity configuration checklist	5-127
Table 55.	Resources checklist - part 1	5-128
Table 56.	Resources checklist - part 2	5-129
Table 57.	Resources checklist - part 3	5-130
Table 58.	Resources checklist - part 4	5-131
Table 59.	Event channels	5-134
Table 60.	Event channel selection guidelines	5-140
Table 61.	Standard event message filtering criteria	5-147
Table 62.	Advanced event message filtering criteria	5-152
Table 63.	System history contents	5-157
Table 64.	History automatic archiving policies	5-159
Table 65.	NovaScale 5085 Server specifications	A-3
Table 66.	NovaScale 5165 Server specifications	A-5
Table 67.	NovaScale 5245 Server specifications	A-7
Table 68.	NovaScale 5325 Server specifications	A-9

Intended Readers

This guide is intended for use by the Administrators and Operators of NovaScale 5xx5 Servers.

It will also prove useful to the Administrators and Operators of Bull NovaScale 7000 Series and Bull NovaScale 9000 Series servers.

Chapter 1. *Introducing the Server*
describes server hardware components and user environment.

Chapter 2. *Getting Started*
explains how to connect to and use the server.

Chapter 3. *Managing Domains*
describes how to perform straightforward server domain management tasks.

Chapter 4. *Monitoring the Server*
explains how to supervise server operation.

Chapter 5. *Tips and Features for Administrators*
explains how, as Customer Administrator, you can configure the server to suit your environment.

Appendix A. *Specifications*

Highlighting

The following highlighting conventions are used in this guide:

Bold	Identifies predefined commands, subroutines, keywords, files, structures, buttons, labels, and icons.
<i>Italics</i>	Identifies referenced publications, chapters, sections, figures, and tables.
< >	Identifies parameters to be supplied by the user.

Abbreviations, acronyms and concepts are documented in the *Glossary*.

Related Publications

Site Preparation Guide, 86 A1 87EF

explains how to prepare a Data Processing Center for Bull NovaScale Servers, in compliance with the standards in force. This guide is intended for use by all personnel and trade representatives involved in the site preparation process.

Installation Guide, 86 A1 40EM

explains how to set up and start NovaScale 5xx5 Servers for the first time. This guide is intended for use by qualified support personnel.

Cabling Guide, 86 A192ER

describes server cabling.

Bull 1300H/L & 1100H/L Cabinets, 86 A1 91EM

explains how to install and fit out rack cabinets for Bull NovaScale Servers and peripheral devices.

Note:

According to server configuration and version, certain features and functions described in this guide may not be accessible. Please contact your Bull Sales Representative for sales information.

Regulatory Specifications and Disclaimers

Declaration of the Manufacturer or Importer

We hereby certify that this product is in compliance with European Union EMC Directive 89/336/EEC, using standards EN55022 (Class A) and EN55024 and Low Voltage Directive 73/23/EEC, using standard EN60950. The product has been marked with the CE Mark to illustrate its compliance.

Safety Compliance Statement

- UL 60950 (USA)
- IEC 60950 (International)
- CSA 60950 (Canada)

European Community (EC) Council Directives

This product is in conformity with the protection requirements of the following EC Council Directives:

Electromagnetic Compatibility

- 89/336/EEC

Low Voltage

- 73/23/EEC

EC Conformity

- 93/68/EEC

Telecommunications Terminal Equipment

- 1999/5/EC

Neither the provider nor the manufacturer can accept responsibility for any failure to satisfy the protection requirements resulting from a non-recommended modification of the product.

Compliance with these directives requires:

- an EC declaration of conformity from the manufacturer
- an EC label on the product
- technical documentation

Federal Communications Commission (FCC) Statement

Note:

This equipment has been tested and found to comply with the limits for a Class A digital device, pursuant to Part 15 of the FCC Rules. These limits are designed to provide reasonable protection against harmful interference when the equipment is operated in a commercial environment. This equipment generates, uses, and can radiate radio frequency energy and, if not installed and used in accordance with the instruction manual, may cause harmful interference to radio communications. Operation of this equipment in a residential area is likely to cause harmful interference in which case the user will be required to correct the interference at his own expense.

Properly shielded and grounded cables and connectors must be used in order to meet FCC emission limits. Neither the provider nor the manufacturer are responsible for any radio or television interference caused by using other than recommended cables and connectors or by unauthorized changes or modifications to this equipment. Unauthorized changes or modifications could void the user's authority to operate the equipment.

Any changes or modifications not expressly approved by the grantee of this device could void the user's authority to operate the equipment. The customer is responsible for ensuring compliance of the modified product.

FCC Declaration of Conformity

This device complies with Part 15 of the FCC Rules. Operation is subject to the following two conditions: (1) this device may not cause harmful interference, and (2) this device must accept any interference received, including interference that may cause undesired operation.

Canadian Compliance Statement (Industry Canada)

This Class A digital apparatus meets all requirements of the Canadian Interference Causing Equipment Regulations.

Cet appareil numérique de la classe A est conforme à la norme NMB-003 du Canada.

This product is in conformity with the protection requirements of the following standards:

Electromagnetic Compatibility

- ICES-003
- NMB-003

Laser Compliance Notice

This product that uses laser technology complies with Class 1 laser requirements.

A CLASS 1 LASER PRODUCT label is located on the laser device.

<p>Class 1 Laser Product Luokan 1 Laserlaite Klasse 1 Laser Apparat Laser Klasse 1</p>
--

Definition of Safety Notices



DANGER

A *Danger* notice indicates the presence of a hazard that has the potential of causing death or serious personal injury.



CAUTION:

A *Caution* notice indicates the presence of a hazard that has the potential of causing moderate or minor personal injury.



Warning:

A *Warning* notice indicates an action that could cause damage to a program, device, system, or data.

Electrical Safety

The following safety instructions shall be observed when connecting or disconnecting devices to the system.



DANGER

The Customer is responsible for ensuring that the AC electricity supply is compliant with national and local recommendations, regulations, standards and codes of practice. An incorrectly wired and grounded electrical outlet may place hazardous voltage on metal parts of the system or the devices that attach to the system and result in an electrical shock. It is mandatory to remove power cables from electrical outlets before relocating the system.



CAUTION:

This unit has more than one power supply cable. Follow procedures for removal of power from the system when directed.

Laser Safety Information

The optical drive in this system unit is classified as a Class 1 level Laser product. The optical drive has a label that identifies its classification.

The optical drive in this system unit is certified in the U.S. to conform to the requirements of the Department of Health and Human Services 21 Code of Federal Regulations (DHHS 21 CFR) Subchapter J for Class 1 laser products. Elsewhere, the drive is certified to conform to the requirements of the International Electrotechnical Commission (IEC) 60825-1: 2001 and CENELEC EN 60825-1: 1994 for Class 1 laser products.



CAUTION:

Invisible laser radiation when open. Do not stare into beam or view directly with optical instruments.

Class 1 Laser products are not considered to be hazardous. The optical drive contains internally a Class 3B gallium-arsenide laser that is nominally 30 milliwatts at 830 nanometers. The design incorporates a combination of enclosures, electronics, and redundant interlocks such that there is no exposure to laser radiation above a Class 1 level during normal operation, user maintenance, or servicing conditions.

Data Integrity and Verification



Warning:

Bull NovaScale Servers are designed to reduce the risk of undetected data corruption or loss. However, if unplanned outages or system failures occur, users are strongly advised to check the accuracy of the operations performed and the data saved or transmitted by the system at the time of outage or failure.

Waste Management

This product has been built to comply with the Restriction of Certain Hazardous Substances (RoHS) Directive 2002/95/EC.

This product has been built to comply with the Waste Electrical and Electronic (WEEE) Directive 2002/96/EC.

PAM Writing Rules

Illegal Characters

The following table lists the illegal characters that must not be used in PAM identifiers.

Illegal Characters	
à, é, è, ù, ^, ``	Accentuated letters
/	Slash
\	Backslash
"	Double quote
'	Simple quote
`	Inverted comma
&	Ampersand
+	Plus
*	Asterisk
%	Percent
=	Equal sign
<	Less-than sign
>	Greater-than sign
:	Colon
!	Exclamation mark
?	Question mark
;	Semi-colon
,	Comma
~	Tilde
	Pipe operator
	Space. Use - (dash) or _ (underscore)

Table 1. PAM illegal characters

String Lengths

The following table lists authorized string lengths.

String Type	Length
CellBlock / System Name	16
Scheme Name	32
History Name	64
Archive Name	75 (History Name: + 11 (_JJMMAA_nnn))
LUN Name	32
Switch Name	32
Event Name	32
Description	256 (Scheme: unlimited)
Domain Identity Name	16

Table 2. String length rules

Registry Keys

PAM obtains file paths via 2 registry keys:

- **ReleaseRoot:**
Contains PAP application file paths (DLL, WEB pages, models,...).
Two versions of PAM software can be installed and used indifferently on the same machine: each new version is installed in a new directory.
- **SiteRoot:**
Contains site data file paths.
Site data remains valid when the PAM software version changes.

Registry keys are generally stored under: HKEY_LOCAL_MACHINE\SOFTWARE\BULL\PAM

AZERTY/QWERTY Keyboard Lookup Table

	1	2	3	4	5	6	7	8	9	0	°	+
z	&	é ~	" #	' { ([-	è ' _ \ ç	^ à @)] =	}				
A	Z	E	R	T	Y	U	I	O	P	^	£	*
										^	\$	*
Q	S	D	F	G	H	J	K	L	M	%	µ	*
										ù	*	
>	W	X	C	V	B	N	?	.	/	\$		
<							,	;	:	!		

Figure 1. AZERTY keyboard

~	!	@	#	\$	%	^	&	*	()	-	+
'	1	2	3	4	5	6	7	8	9	0	-	=
Q	W	E	R	T	Y	U	I	O	P	{	}	
										[]	\
A	S	D	F	G	H	J	K	L	:	*		
									:	;	,	
	Z	X	C	V	B	N	M	<	>	?		
								,	.	/		

Figure 2. QWERTY keyboard

Administrator's Memorandum

Domains

- Manage Domain Schemes, on page 3-5
 - Synchronize NovaScale 5xx5 SMP Server Domains, on page 3-6
 - Power ON a Domain, on page 3-14
 - Power OFF a Domain, on page 3-18
 - Perform a Manual Domain Reset, on page 3-25
 - Perform a Domain Force Power OFF, on page 3-21
 - Perform a Domain Memory Dump, on page 3-24
 - View Domain Functional Status, on page 3-29
 - View Domain Power Logs, on page 3-31
 - View Domain Powering Sequences, on page 3-32
 - View Domain BIOS Info, on page 3-33
 - View Domain Request Logs, on page 3-34
 - View Domain Configuration, Resources and Status, on page 3-35
 - Solve Incidents, on page 3-42
- * Reserved for partitioned servers and extended systems.

Monitoring

- Refresh the PAM Display, on page 4-2
- View CSS Availability Status and System Functional Status, on page 4-4
- View Event Message Status, on page 4-4
- Display Hardware Presence / Functional Status, on page 4-5
- View PAM Web Site User Information, on page 4-12
- View PAM Version Information, on page 4-13
- View Server Hardware Status, on page 4-14
- Use the Hardware Search Engine, on page 4-10
- Display Detailed Hardware Information, on page 4-15
- Exclude / Include Hardware Elements, on page 4-23
- Exclude / Include Clocks, SPS, XSP Links and Sidebands, on page 4-27
- Manage PAM Event Messages, History Files, Archives, Fault Lists, on page 4-31
- Understand Message Severity Levels, on page 4-32
- View, Acknowledge WEB Event Messages, on page 4-34
- Sort and Locate Messages, on page 4-35
- Solve Incidents, on page 4-42
- Create an Action Request Package, on page 4-51
- Create a Custom Package, on page 4-53

Configuration

- Set up Server Users, on page 5-4
- Configure System and Data Disks, on page 5-5
- Use the EFI Boot Manager, on page 5-7
- Use the EFI Shell, on page 5-9
- Set Up and Configure the EFI Network, on page 5-14
- Set up PAP Unit Users, on page 5-17
- Modify Customer Information, on page 5-17
- Configure PAM Autocall Parameters, on page 5-20
- Customize PAM Settings, on page 5-22
- Deploy a New PAM Release, on page 5-23
- Activate a PAM Version, on page 5-24
- Back Up and Restore PAM Configuration Files, on page 5-26
- Configure Domains, on page 5-28*
- Assess Configuration Requirements, on page 5-31 *
- Create, Edit, Copy, Delete, Rename a Domain Scheme, on page 5-33*
- Update DefaultSchemes, on page 5-49*
- Create, Edit, Copy, Delete a Domain Identity, on page 5-50*
- Manage LUNs (Servers Not Connected to a SAN), on page 5-57
- Manage LUNs (Servers Connected to a SAN), on page 5-55
- Check and Update Fibre Channel HBA World Wide Names, on page 5-64
- Limit Access to Hardware Resources, on page 5-66
- Configure Extended Systems, on page 5-125*
- Prepare Scheme, Domain Identity and Resources Checklists, on page 5-126*
- Customize the PAM Event Messaging System, on page 5-133
- Set up Event Subscriptions, on page 5-134
- Event Subscription Flowcharts, on page 5-134
- Create, Edit, Delete an E-mail Server, on page 5-136
- Create, Edit, Delete an E-mail Account, on page 5-138
- Create, Edit, Delete a User History, on page 5-158
- Enable / Disable Event Channels, on page 5-140
- Create, Edit, Delete an Event Subscription, on page 5-141
- Understand Event Message Filtering Criteria, on page 5-143
- Preselect an Event Filter, on page 5-153
- Create, Edit, Delet an Event Filter, on page 5-154
- Excluding / Including Clocks, SPS, XSP Links and Sidebands, on page 4-27

* Reserved for partitioned servers and extended systems.

Operator's Memorandum

Domains

- Synchronize NovaScale 5xx5 SMP Server Domains, on page 3-6
- Power ON a Domain, on page 3-14
- Power OFF a Domain, on page 3-18
- Perform a Domain Force Power OFF, on page 3-21
- Perform a Manual Domain Reset, on page 3-25
- Perform a Domain Memory Dump, on page 3-24
- View Domain Functional Status, on page 3-29
- View Power Logs, on page 3-31
- View Domain Powering Sequences, on page 3-32
- View BIOS Info, on page 3-33
- View Domain Request Logs, on page 3-34
- View Domain Configuration, Resources and Status, on page 3-35
- Solve Incidents, on page 3-42

Histories

- Manage PAM Event Messages, History Files, Archives, Fault Lists, on page 4-31
- Understand Event Message and History Severity Levels, on page 4-32
- Sort and Locate messages, on page 4-35

Status

- Check System Functional Status, on page 4-4
- Check CSS Availability, on page 4-4
- View, Acknowledge WEB Event Messages, on page 4-34
- Sort, Locate WEB event messages, on page 4-35

Chapter 1. Introducing the Server

This chapter describes the main hardware components and user environment for NovaScale 5xx5 Servers. It includes the following topics:

- Bull NovaScale Server Overview, on page 1-2
- Accessing Server Components, on page 1-20
- Bull NovaScale Server Resources, on page 1-22
- PAM Software Package, on page 1-22
- EFI Utilities, on page 1-23



Note:

Customer Administrators and Customer Operators are respectively advised to consult the *Administrator's Memorandum*, on page xxiii or the *Operator's Memorandum*, on page xxv for a detailed summary of the everyday tasks they will perform.

Bull NovaScale Server Overview

Bull NovaScale Servers for business and scientific applications are based upon the FAME architecture (Flexible Architecture for Multiple Environments), leveraging the latest generation of Intel Itanium 2 processors.

Servers are designed to operate as one to eight hardware-independent SMP systems or domains, each running an Operating System instance and a specific set of applications.

According to version, servers are delivered rack-mounted and ready-to-use in high or low cabinets.

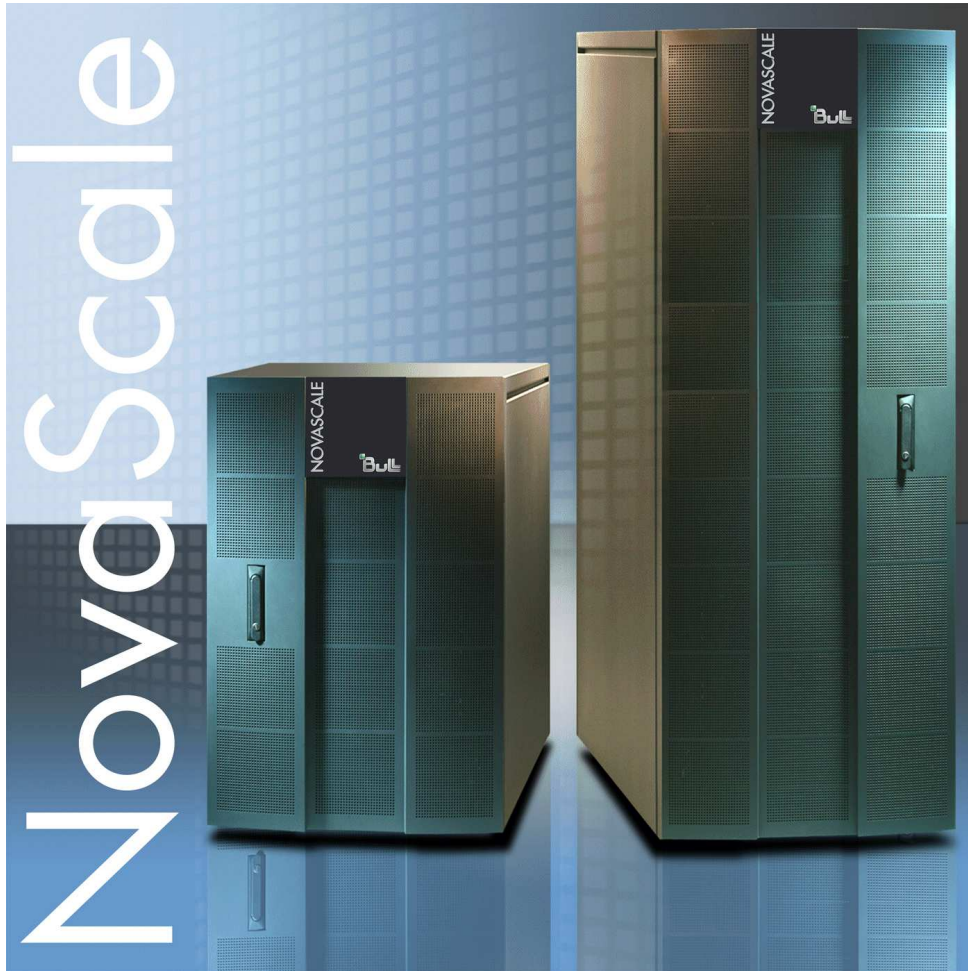

Figure 3. Bull NovaScale Server cabinets

Dynamic Partitioning

Bull NovaScale Servers can be dynamically partitioned into physically independent ccNUMA (Cache Coherent Non Uniform Memory Access) SMP systems or domains, each running an Operating System instance and a specific set of applications.

Extended Configurations

Several Bull NovaScale Servers may be administered through a single instance of PAM software.

Cluster Configurations

Several Bull NovaScale Servers may be grouped to act like a single system, enabling high availability, load balancing and parallel processing.

Server Features

The main features of Bull NovaScale Servers are:

Intel Itanium Processor Family architecture:

- Modularity, predictable performance and growth

High availability:

- Component redundancy
- Capacity to isolate or replace a faulty component without service disruption
- Global and unified system visibility
- Round-the-clock operation

Scalability:

- Dynamic partitioning
- Power on demand : capacity to dynamically adapt resources to load requirement

Simultaneous support of multiple environments:

- Microsoft Windows Server
- Linux

High performance computing capabilities:

- Technical and scientific applications:
 - . High Performance Computing (HPC)
- Business Intelligence:
 - . Datawarehousing
 - . Datamining
- Large enterprise applications:
 - . ERP
 - . CRM
 - . SCM ...
- Large database applications for Internet transactions.
- Large business sector applications:
 - . Online billing
 - . Online reservations
 - . Online banking ...

Built-in Platform Administration and Maintenance (PAM) software suite:

- Proactive administration
- Optimization of resources
- Automatic generation of corrective actions and calls to support centers
- Dynamic configuration

Bull NovaScale Master System Management (NSM) software suite:

- Windows, Linux, and Platform management
- Monitoring, Information, Control, and Event Handling
- Client / Server / Agent architecture
- WEB standard OpenSource solutions

Server Hardware



Note:

Abbreviations and acronyms are documented in the *Glossary*.

Main server hardware components are:

Central SubSystem Module (CSS Module)

Main server hardware components are housed in the CSS Module. For easy access and servicing, the CSS Module is composed of three interconnected units:

Front Unit	Core Unit	Rear Unit
1 or 2 QBBs	1 MQB	1 or 2 IOCs
1 or 2 Internal Peripheral Drawers	1 MIO	1 or 2 IOLs
	2 MSXs	1 PMB
	1 MFL	2 or 4 DPS Units
	8 Fanboxes	



Notes:

- The CSS Module can be logically divided into two **Cells**, each with one QBB and one IOC, to allow dynamic partitioning.
- According to version, servers are equipped with one, two, three, or four interconnected CSS modules.

Front Unit

Quad Brick Block (QBB)

The QBB is equipped with 2 to 4 Itanium® 2 processors and 16 DDR DIMMs. The QBB communicates with the rest of the system the high-speed bidirectional link **Scalability Port Switches (SPS)** located on the MSX.

Internal Peripheral Drawer (IPD)

The Internal Peripheral Drawer is equipped with a DVD/CD ROM drive and a USB port. The Internal Peripheral Drawer is connected to the MQB in the Core Unit via a **Device Interface Board (DIB)**.

Optionally:

- the Internal Peripheral Drawer can house 2 SCSI Disks for OS partitions or storage,
- two Internal Peripheral Drawers, in the same CSS module, can be connected together to house 4 SCSI Disks for OS partitions or storage (**Chained DIBs**).

Core Unit

Midplane QBB Board (MQB)

The QBBs and the Internal Peripheral Drawers are connected to the MQB.

Midplane IO Board (MIO)

The IOCs and the PMB are connected to the MIO.

Midplane SPS & XPS Board (MSX)

Each MSX houses 1 high-speed directional link **Scalability Port Switch (SPS)** and is connected to both the MIO and the MQB. Each QBB and IOC communicates with the rest of the system through the SPS.

Midplane Fan & Logistics Board (MFL)

16 Fans and various logistics components are implemented on the MFL. The MFL is connected to both the MIO and the MQB.

Fanboxes

8 Fanboxes, each housing 2 fans, provide redundant cooling.

Rear Unit

IO board Compact (IOC)

The IOC provides 4 x PCI -X and 2 x PCI-Express buses and a PCI Hot Plug Board (HPB). The IOC communicates with the rest of the system through the high-speed bidirectional link **Scalability Port Switches (SPS)** located on the MSX.

IO board Legacy (IOL)

The IOL is an IOC daughter board providing legacy IO connections: 2 USB ports, 1 LAN port, 2 serial ports, and 1 video port.

Platform Maintenance Board (PMB)

The PMB concentrates logistics access and links the platform to the Platform Administration Processor (PAP Unit) running Platform Administration and Maintenance (PAM) software.

Distributed Power Supply (DPS) Unit

Each DPS Unit supplies 48V AC/DC power to the server. The server is equipped with 2 or 4 DPS units for full redundancy.

Platform Administration Processor (PAP) Unit

The PAP Unit hosts all server administration software, in particular Platform Administration and Maintenance (PAM) software.

KVM Switch

The KVM Switch allows the use of a single keyboard, monitor and mouse for the local server domains and the local PAM console.

Console

The Console contains the keyboard, monitor and touch pad / mouse used for local access to the server domains and to the PAP Unit.

Disk Subsystem

If the disk slots in the Internal Peripheral Drawer are not used for OS disk partitions, a SCSI RAID or FC disk subsystem is required.

Additional Peripherals

Additional peripherals such as disk subsystems, storage area networks, communication networks, archiving peripherals etc. can be connected to the server via PCI adapters located in the IOCs. Such peripherals may either be rack-mounted in the server cabinet (if free space is available) or in external cabinets.

Server Firmware and Software

Operating Systems (OS)

The server is certified for the following Operating Systems:

- Windows Server 2003, Enterprise Edition
- Windows Server 2003, Datacenter Edition
- Linux Red Hat Enterprise Linux Advanced Server
- Novell SUSE SLES 9

BIOS

The BIOS controls the server startup process, dynamic resource allocation (Domain reconfiguration, hot-plugging), and error handling. The BIOS also includes:

- The **Extended Firmware Interface (EFI)**, which provides the OS with system services.
- The **EFI Shell**, an autonomous environment used to run Off-line Test & Diagnostic suites.

Platform Administration and Maintenance (PAM) suite

The PAM Web-based software suite is used to operate, monitor, and configure the server. PAM can be accessed locally or remotely through Microsoft Internet Explorer or Mozilla browsers, under the protection of appropriate access rights. PAM provides the administration functions needed to manage and maintain the server:

- Domain configuration and resource allocation
- Alert or maintenance requests to the Customer Service Center
- Error logging ...

Test & Diagnostics suites

The server is delivered with the following T & D suites:

- Online Test & Diagnostic suite
- Offline Test & Diagnostic suite
- Power-On Self-Test suite

NovaScale Master (NSM) Management suite

The NSM software suite allows you to monitor and manage NovaScale Windows and Linux systems.

Conformance to Standards

Intel

Bull NovaScale Servers conform to all Intel platform standards:

- ACPI (Advanced Configuration and Power Interface)
- IPMI (Intelligent Platform Management Interface)
- EFI (Extended Firmware Interface)
- SMBIOS (System Management BIOS)
- DIG64 (Developer Interface Guide for Intel® Itanium® Architecture)

Windows

Bull NovaScale Servers conform to the standards set out in the Windows Hardware Design Guide.

Getting to Know the Server

NovaScale 5085 Partitioned Server

Note:

Server components and configuration may differ according to the version chosen.

The server is delivered rack-mounted and pre-cabled in a low or high cabinet, typically containing the following components:

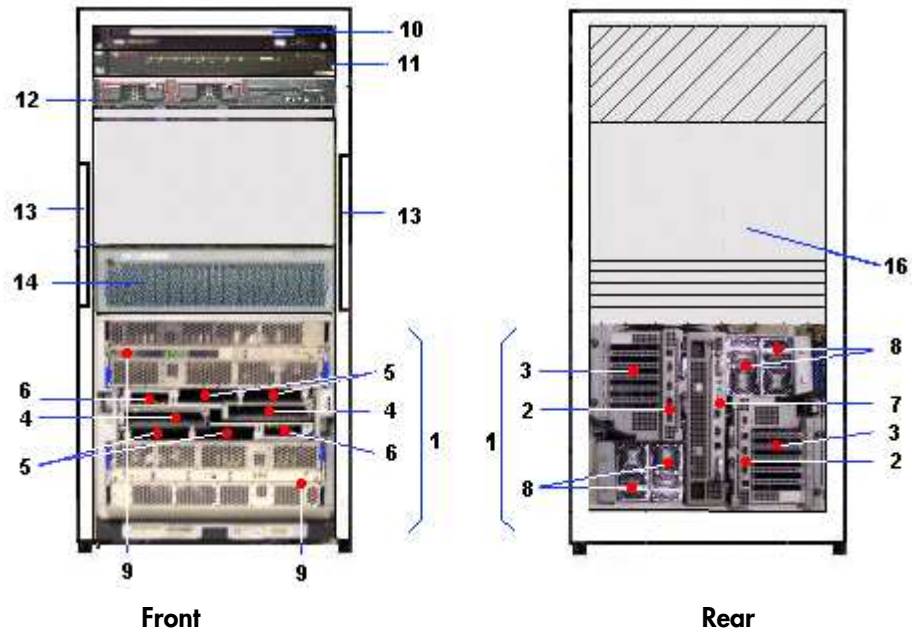

1	CSS module with core unit, power supply and AC power cable, including:		8 U
	2xIO Boxes (IOC) each with:	2 IOL board - legacy ports	
		3 4xPCI-X & 2x PCI-Express slots	
	2xInternal Peripheral Drawers each with:	4 DVD-ROM drive	
		5 2xInternal SCSI RAID disks	
		6 USB port	
	PMB board	7	
	2 or 4 DPS units	8	
	2xQBB subsets (1 to 4 CPUs each) *Multicore CPU = Socket	9	
10*	Slideaway console with monitor and keyboard		1 U
11	8-ports KVM switch		1 U
12	PAP unit with CD-ROM writer, FDD and 2 disks		1 U
13*	1 or 2 PDU(s) with AC power cable		
	*	Slideaway console. For an external console, use a KVM extender kit (150m max.).	
	**	Redundant servers are connected to 2 PDUs and have 4 DPS units.	
14	1 optional FC disk		3 U
16	Free space for additional components		4 U

Figure 4. NovaScale 5085 Partitioned Server components - example

NovaScale 5165 Partitioned Server

Note:

Server components and configuration may differ according to the version chosen.

The server is delivered rack-mounted and pre-cabled in a high cabinet, typically containing the following components:

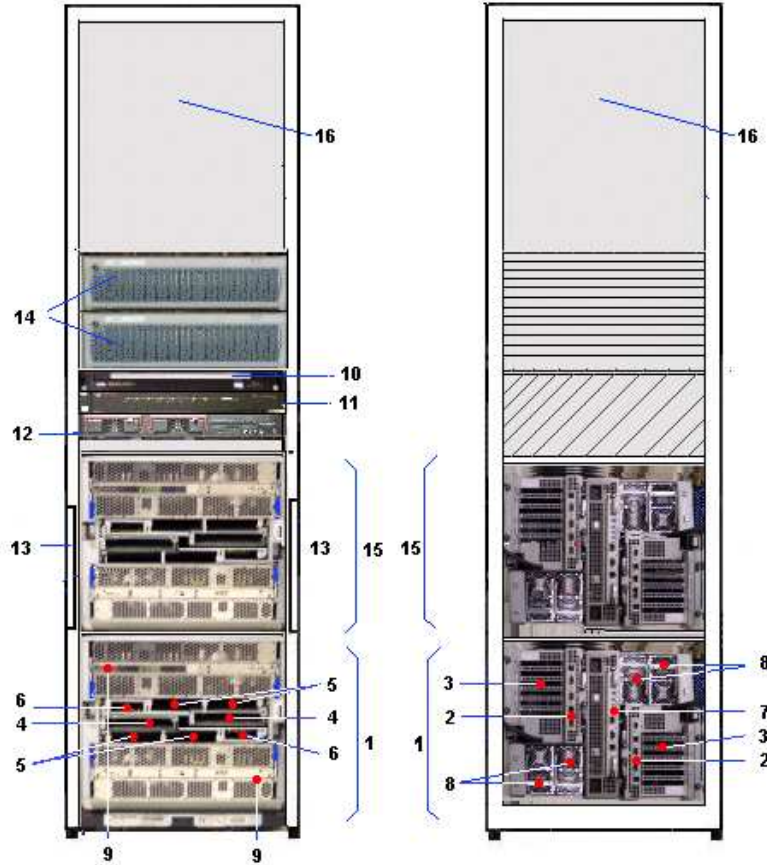

Front

Rear

1, 15	CSS module with core unit, power supply and AC power cable, including:	8 U x 2
	IO Box (IOC) with:	
	2 IOL board - legacy ports	
	3 4xPCI-X & 2x PCI-Express slots	
	Internal Peripheral Drawer with:	
	4 DVD-ROM drive	
	5 2xInternal SCSI RAID disks	
	6 USB port	
PMB board	7	
2 or 4 DPS units	8	
2xQBB subsets (1 to 4 CPUs each) *Multicore CPU = Socket	9	
10*	Slideaway console with monitor and keyboard	1 U
11	8-ports KVM switch	1 U
12	PAP unit with CD-ROM writer, FDD and 2 disks	1 U
13**	1 or 2 PDU(s) with AC power cable	
14	2 FC disks (optional)	3 U x 2
16	Free space for additional components (SCSI or FC disks)	14 U

* Slideaway console. For an external console, use a KVM extender kit (150m max.).
 ** Redundant servers are connected to 2 PDUs and have 4 DPS units.

Figure 5. NovaScale 5165 Partitioned Server components - example

NovaScale 5245 Partitioned Server



Note:

Server components and configuration may differ according to the version chosen.

The server is delivered rack-mounted and pre-cabled in a high cabinet, typically containing the following components:

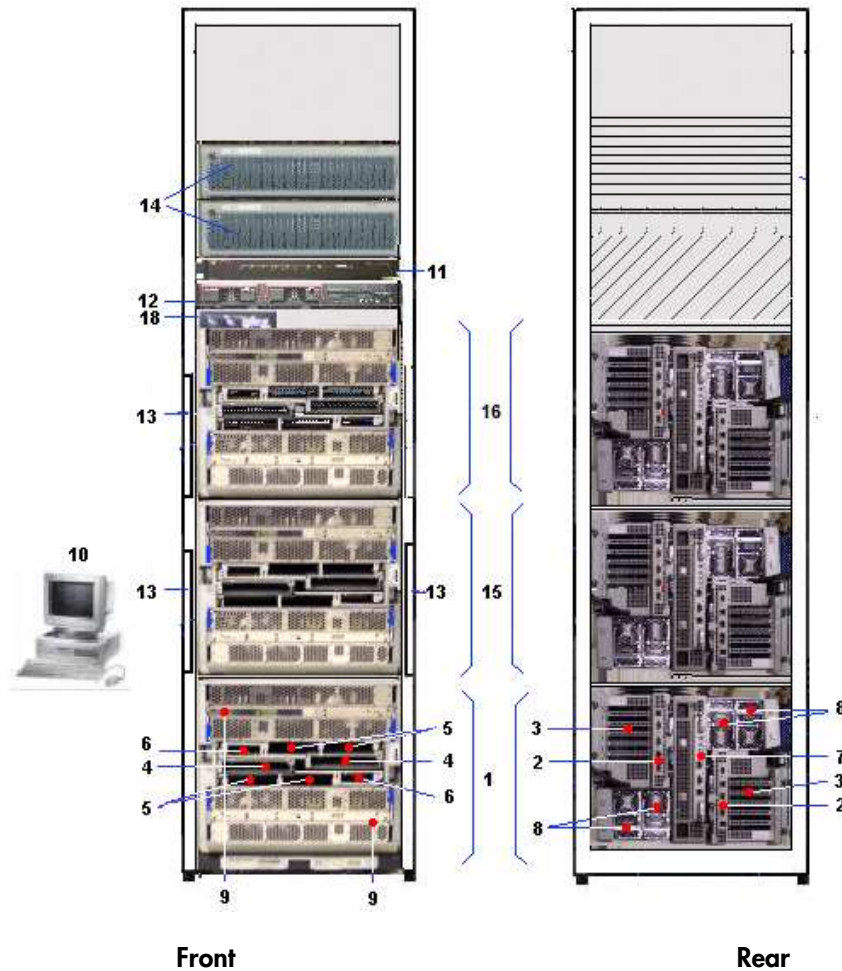

	Front	Rear	
1, 15, 16	CSS module with core unit, power supply and AC power cable, including:		8 U x 3
	IO Box (IOC) with:	2 IOL board - legacy ports	
		3 4xPCI-X & 2x PCI-Express slots	
	Internal Peripheral Drawer with:	4 DVD-ROM drive	
		5 2xInternal SCSI RAID disks	
		6 USB port	
	PMB board	7	
	2 or 4 DPS units	8	
	9		
10*	External console with monitor and keyboard		
11	8-ports KVM switch		1 U
12	PAP unit with CD-ROM writer, FDD and 2 disks		1 U
13**	1 or 2 PDU(s) with AC power cable		
14	2 FC disks		3 U x2
16	Free space for additional components (SCSI or FC disks)		14 U
18	KVM extender		1 U
* External console, use a KVM extender kit (150m max.).			
** Redundant servers are connected to 2 PDUs and have 4 DPS units.			

Figure 6. NovaScale 5245 Partitioned Server components - example

NovaScale 5325 Partitioned Server

Note:

Server components and configuration may differ according to the version chosen.

The server is delivered rack-mounted and pre-cabled in two high cabinets, typically containing the following components:

Main Cabinet

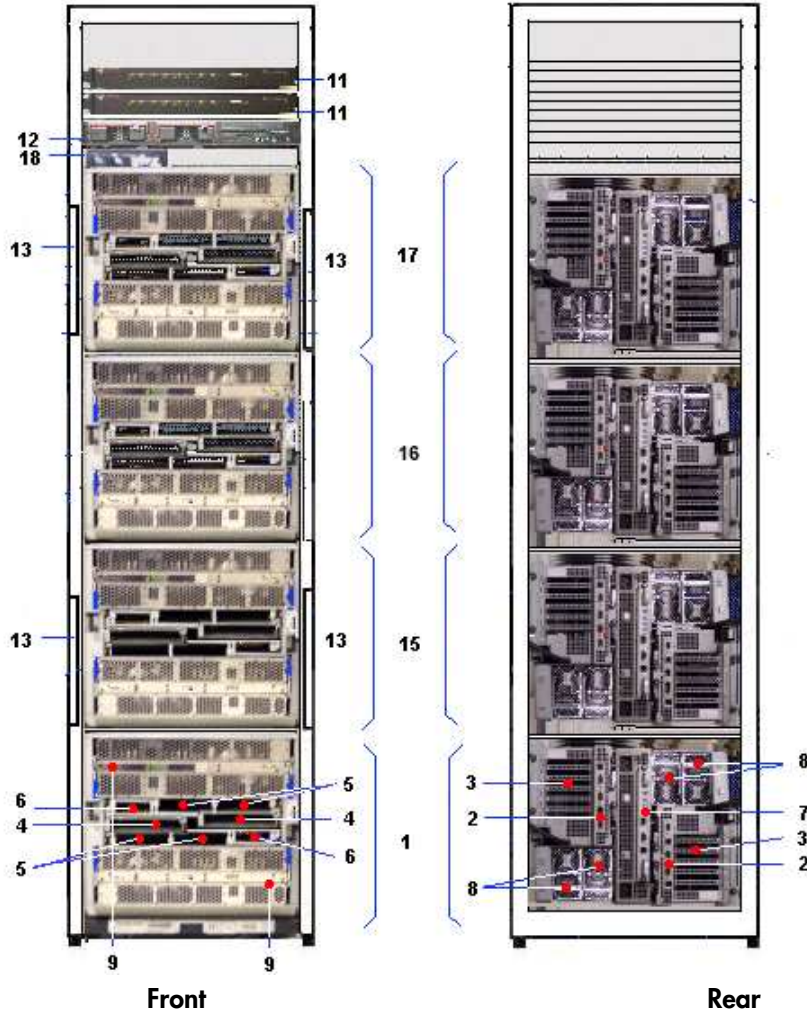

1, 15, 16, 17	CSS module with core unit, power supply and AC power cable, including:		8 U x 4
	IO Box (IOC) with:	2 IOL board - legacy ports	
	Internal Peripheral Drawer with:	3 4xPCI-X & 2x PCI-Express slots	
		4 DVD-ROM drive	
		5 2xInternal SCSI RAID disks	
	PMB board	6 USB port	
	2 or 4 DPS units	7	
2xQBB subsets (1 to 4 CPUs each) *Multicore CPU = Socket	8		
9	9		
11	2 x 8-ports KVM switch		1 U x 2
13*	2 or 4 PDU(s) with AC power cable		
18	KVM extender (local)		1 U
* Redundant servers are connected to 2 PDUs and have 4 DPS units.			

Figure 7. NovaScale 5325 Partitioned Servers components - example

I/O Cabinet

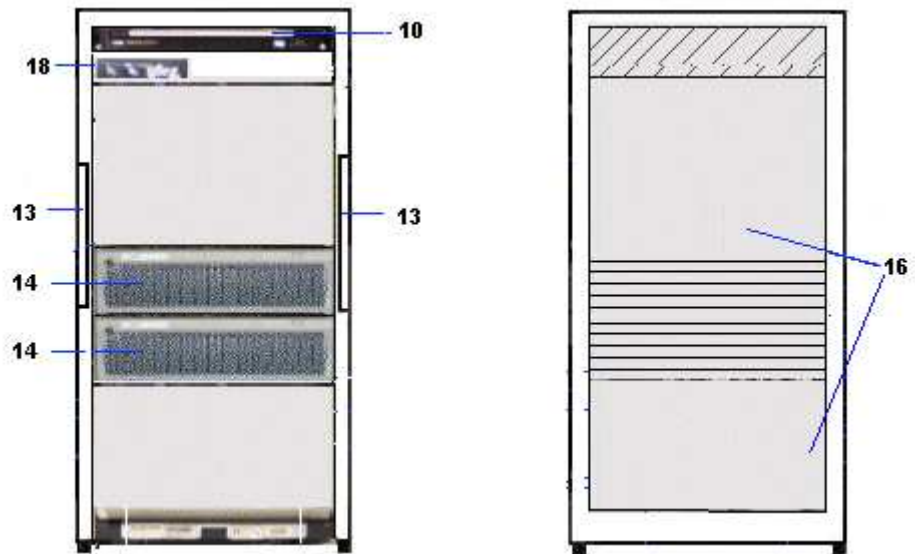

10	PAP unit with CD-ROM writer, FDD and 2 disks	1 U
13	2 PDU(s) with AC power cable	
14	2 FC disks	3x2 U
18	KVM extender (remote)	1 U

Figure 8. NovaScale 5325 Partitioned Servers components - example

Server Components



Note:

Server components and configuration may differ according to the version chosen.

The server includes the following components:

- CSS module, on page 1-13
- Integrated console, on page 1-15
- Integrated Platform Administration Processor (PAP) unit, on page 1-14
- Keyboard / Video / Mouse (KVM) switch, on page 1-16
- Fibre Channel (FC) disks, on page 1-17
- Ethernet hub, on page 1-19
- USB modem, on page 1-19
- NPort server, on page 1-19

Central Subsystem (CSS) Module

The CSS module houses main hardware components:

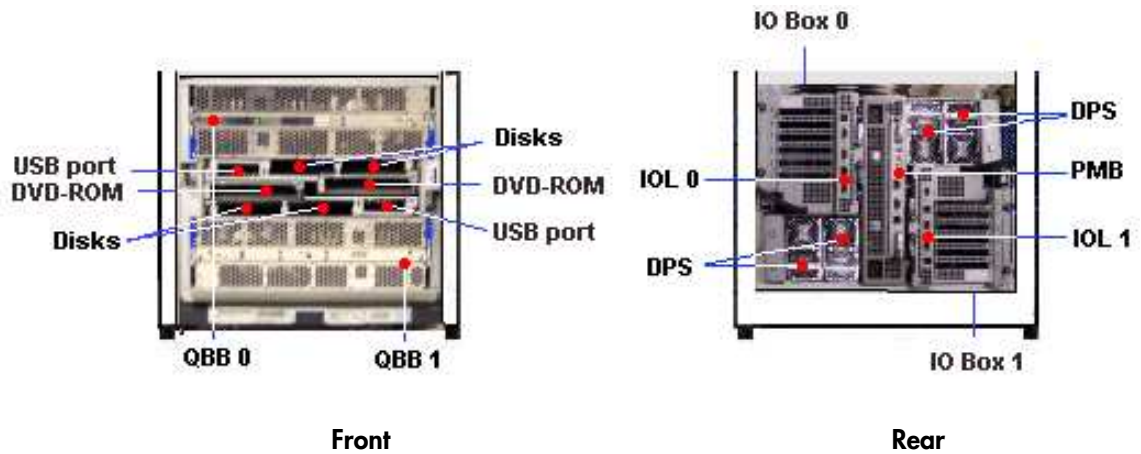

Front	<p>1 or 2 QBB (Quad Brick Board) subset(s): Each QBB subset houses:</p> <ul style="list-style-type: none"> • 1 mother board • 2 memory boards • 1 to 4 processors • 16 DIMMs <p>1 or 2 Internal Peripheral Drawer(s): Each drawer houses:</p> <ul style="list-style-type: none"> • 2 internal SCSI RAID system disks • 1 DVD-ROM drive • 1 USB port <p>Chain of DIBs: Two Internal Peripheral Drawers can be inter-connected to house:</p> <ul style="list-style-type: none"> • 4 SCSI RAID disks, 1 DVD-ROM drive, 1 USB port
Rear	<p>1 or 2 IO Box(es) (Input / Output Board Compact): Each IO Box can house:</p> <ul style="list-style-type: none"> • 1 HPB (PCI Hot Plug Board) • 6 hot-plug 133 MHz PCI-X and PCI Xpress slots (2 long, 4 short) • 1 IOL (Input / Output board Legacy): <ul style="list-style-type: none"> - 2 A-type USB ports - 1 RJ45 10/100/1000 Mbps Ethernet port - 2 DB9-M RS232 serial ports - 1 HD15-F VGA port <p>1 PMB (Platform Management Board): This active board links the server to the Platform Administration Processor (PAP) Unit (via an Ethernet link).</p>
Core	<p>1 Core unit This set of 5 active boards is used to interconnect the QBBs, IOCs, DIBs and the PMB.</p>

Figure 9. CSS module features (full CSS module example)

Integrated Platform Administration Processor (PAP) Unit



Warning:

The PAP unit has been specially configured for Bull NovaScale Server administration and maintenance. **NEVER** use the PAP unit for other purposes and **NEVER** change PAP unit configuration unless instructed to do so by an authorized Customer Service Engineer.

The PAP unit is linked to the server via the Platform Management Board (PMB). It hosts Platform Administration Software (PAM). **According to version, the PAP unit is located in the center of a high cabinet or at the top of a low cabinet.**



PAP Unit 1U	
<ul style="list-style-type: none">• 1 P4C / 3 GHz PC<ul style="list-style-type: none">- 1 GB RAM- 2 x 80 GB SATA disks (RAID1)- 1 CD/DVD-ROM drive- 1 1 FDD- 2 serial ports- 1 parallel port- 3 PCI slots- 2 Gigabit Ethernet ports (1 free)- 3 USB 2.0 ports (1 front + 2 rear)- 1 SVGA video port- 2 PS/2 ports	
	<ul style="list-style-type: none">• Microsoft Windows operating system• Internet Explorer software• PAM software• 1 power cable

Figure 10. PAP unit

Integrated Console

According to version, the console is located in the center of a high cabinet or at the top of a low cabinet.

The integrated console contains the keyboard, monitor and touch pad used for local access to the server and to the Platform Administration Processor (PAP) Unit.



or



- 1 monitor
- 1 QWERTY keyboard and touch pad
- 1 power cable

Figure 11. Integrated console features

Keyboard / Video / Mouse (KVM) Switch

The KVM Switch allows the use of the integrated console for the local server and the local Platform Administration and Maintenance console.

8-Port KVM Switch



Or



Or



- 8 ports
- 1 power cable

Figure 12. 8-port KVM switch features

16-Port KVM Switch

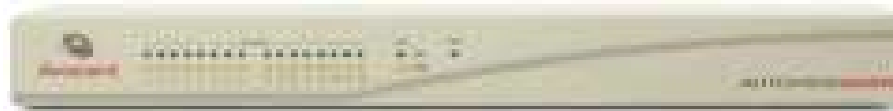

- 16 ports
- 1 power cable

Figure 13. 16-port KVM switch features

KVM Extender



Figure 14. KVM extender (local & remote) 300m maxi.

FDA 1x00 FC Disk Rack

Optionally, the FDA 1x00 FC Disk Rack is delivered with pre-installed system disks (two RAID#1 and one spare disk per domain). Empty slots can be used for data disks. According to version, the Disk Rack is located in the main or I/O cabinet.



- 15 slots
- 2 FC RAID controller cards, 1 FC port per controller
- 3 disks per domain (2 RAID#1 + 1 spare)
- 2 power cables (redundant power supply)

Figure 15. FDA 1x00 FC disk rack features

FDA 2x00 FC Disk Rack

Optionally, the FDA 2x00 FC Disk Rack is delivered with pre-installed system disks (two RAID#1 and one spare disk per domain). Empty slots can be used for data disks. According to version, the Disk Rack is located in the main or I/O cabinet.



- 1 controller unit & 1 disk unit
- 15 slots
- 2 FC RAID controller cards, 2 FC ports per controller
- 3 disks per domain (2 RAID#1 + 1 spare)
- 2 power cables (redundant power supply)

Figure 16. FDA 2x00 FC disk rack features

FDA 1x00 FC Extension Disk Rack

The FDA 1x00 FC Extension Disk Rack offers 15 empty slots for data disks. According to version, the Disk Rack is located in the main or I/O cabinet.



- 15 slots
- 2 power cables (redundant power supply)

Figure 17. FDA 1x00 FC extension disk rack features

Ethernet Hub

The optional Maintenance LAN Ethernet Hub is used to connect PMB, PAP Unit and external FDA FC Disk Rack Ethernet ports.



Ethernet Hub	- 8 ports - 1 power cable - 1 power bar
--------------	---

Figure 18. Ethernet hub features

USB Modem

The optional USB modem is used to transmit Autocalls to the Remote Maintenance Center, if your maintenance contract includes the Autocall feature.



USB Modem	- 1 USB cable - 1 RJ11 cable
-----------	---------------------------------

Figure 19. USB modem features

NPort Server

The Nport Server is used connect the administration port of the SR-0812 SCSI RAID disk rack to the PAP Unit.

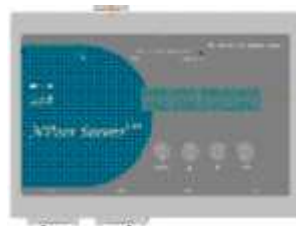

NPort Server	- 2 DB9 to Jack cable - 1 RJ45 - RJ45 Ethernet cable
--------------	---

Figure 20. NPort Server features

Accessing Server Components

During normal operation, cabinet components can be accessed from the front. Customer Service Engineers may also remove the rear and side covers for certain maintenance operations.



Important:

Optimum cooling and airflow is ensured when the cabinet door is closed.

Opening the Front Door

Tools Required:

- Cabinet key

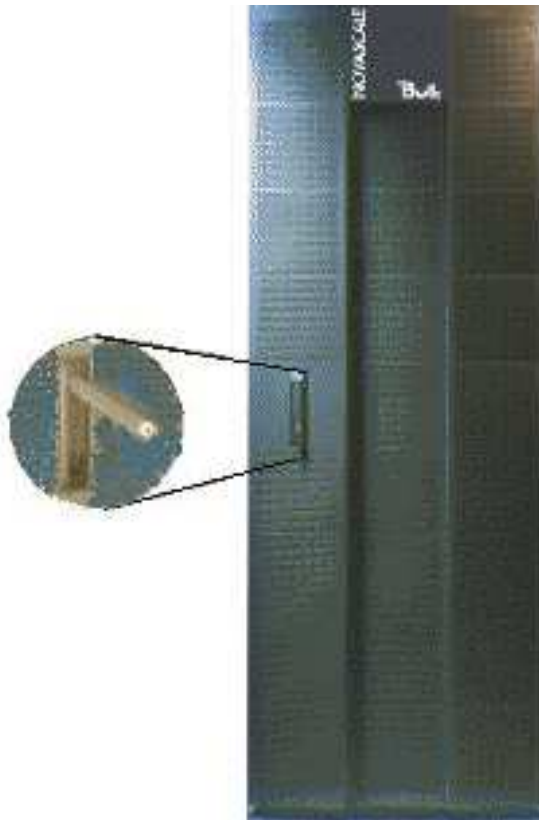

Figure 21. Opening the front door

1. Unlock the front door with the key.
2. Pull out the locking mechanism and turn to open.
3. Open the door as required.

Closing the Front Door

1. Close the door.
2. Turn the locking mechanism to close and push back into place.
3. Lock the front door with the key.

Opening / Closing the Integrated Console

The server is equipped with an integrated console for local administration and maintenance operations.



Figure 22. Integrated console example

To open the integrated console:

1. Slide the console forward until it clicks into place.
2. Use the front bar to lift the screen panel into position.

To close the integrated console:

1. Press the 2 buttons marked PUSH on either side of the keyboard panel to release the console.
2. Lower the front bar to close the screen panel.
3. Slide the console back into the cabinet.

Bull NovaScale Server Resources



Note:

According to server configuration and version, certain features and functions described in this guide may not be accessible. Please contact your Bull Sales Representative for sales information.

System Resource and Documentation CD-Roms

The Bull NovaScale Server System Resource and Documentation CD-Roms contain all the firmware and documentation referred to in this guide.

PAM Software Package

The Bull NovaScale Server is equipped with an integrated Platform Administration and Maintenance software package, otherwise known as the PAM software package.

One part of PAM software is an embedded application (MAESTRO) running on the Platform Management Board(s) (PMB) and the other is an external application (PAM Kernel / Web User Interface) running on the Platform Administration Processor (PAP) unit under Microsoft Windows.

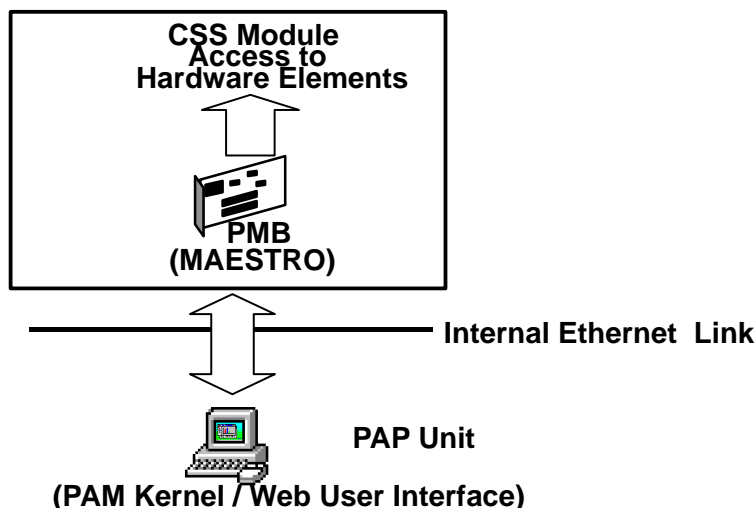

Figure 23. PAM software deployment

The PAM Web-based administration and maintenance tools give you immediate insight into system status and configuration. You will use PAM software to operate, monitor, and configure your Bull NovaScale Server.

As soon as your system is connected to the power supply, the PAP unit running Microsoft Windows and PAM software also powers up. For further information about connecting to PAM, see **Connecting to the PAM Web Site, on page 2-2**.

PAP Unit Mirroring and Failover Policy

Most configuration, administration, and maintenance activities are carried out from the PAP unit. To ensure a high level of data integrity and availability, the PAP unit is equipped with two extractable mirrored disks. Mirroring writes and updates data across both disks, creating a single logical volume with completely redundant information on each disk. If one disk fails, it can be replaced without losing data.



Note:

For enhanced data integrity and availability, the PAP unit can be equipped with a third disk. Contact your Customer Representative for details.

EFI Utilities

The Bull NovaScale Server EFI utilities provide a complete set of configuration, operation, and maintenance tools:

- EFI driver,
- EFI Shell,
- EFI system utility,
- EFI system diagnostic,
- Operating System loader.

For further details, see **Chapter 5. *Tips and Features for Administrators.***

Chapter 2. Getting Started

This chapter explains how to connect to and start server domains. It includes the following topics:

- Connecting to the PAM Web Site, on page 2-2
- 2-5PAM User Interface, on page 2-5
- Setting up Users, on page 2-8
- Toggling the Local / Integrated Console Display, on page 2-9
- Powering Up / Down the NovaScale 5xx5 SMP Server Domain, on page 2-10
- Powering Up / Down NovaScale 5xx5 Partitioned Servers Domains, on page 2-12
- Preparing Server Domains for Remote Access via the Enterprise LAN, on page 2-16
- Preparing Server Domains for Remote Access via the Web, on page 2-18
- Connecting to a Server Domain via the Enterprise LAN, on page 2-19
- Connecting to a Server Domain via the Web, on page 2-20
- Installing Applications, on page 2-21



Note:

Customer Administrators and Customer Operators are respectively advised to consult the *Administrator's Memorandum*, on page xxiii or the *Operator's Memorandum*, on page xxv for a detailed summary of the everyday tasks they will perform.

Connecting to the PAM Web Site

The server is equipped with an integrated Platform Administration and Maintenance software package, otherwise known as PAM software. One part of PAM software is an embedded application (MAESTRO) running on the Platform Management Board (PMB) and the other is an external application running on the Platform Administration Processor (PAP) unit under Microsoft Windows.

The PAM Web-based administration and maintenance tools give you immediate insight into system status and configuration. You will use PAM software to operate, monitor, and configure your server.



Note:

Local and remote access rights to the PAP unit and to the PAM Web site must be configured by the Customer Administrator. For further details, refer to the Microsoft Windows documentation and to *Setting up PAP Unit Users*, on page 5-17.

Customer Administrator rights are required for all PAM configuration tasks.

Connecting to the PAM Web Site from the Local / Integrated Console



CAUTION:

Access to the local / integrated console should be restricted to Customer / Support Administrators and Operators ONLY to avoid inadvertent damage to software and/or hardware components.

1. Check that the KVM switch is set to the **PAP Unit** port. See *Toggling the Local / Integrated Console Display*, on page 2-9.
2. From the PAP unit Microsoft Windows desktop, double-click the PAM icon (**http://localhost/PAM**).
3. When prompted, enter the appropriate Administrator or Operator **User Name** and **Password**. The PAM home page appears.

Connecting to the PAM Web Site from a Remote Computer

The PAM Software utility can be accessed from any PC running Microsoft Windows with the Internet Explorer (6 or later) browser installed and/or from any workstation running Linux with the Mozilla (1.7 or later) or Firefox (1.0) browsers installed.



Important:

Before connecting to PAM from a remote computer, you are advised to disconnect from your local Windows session on the PAP unit by clicking Start → Log Off.

If Pop-up Blocker is turned on in your Web Browser, you MUST add the PAM Web site to the list of allowed sites.

Do NOT use the Mozilla or Firefox browsers on the PAP unit.

Enabling Remote Access to the PAM Web Site with Internet Explorer, Mozilla, or Firefox

1. From the remote computer, configure the browser to connect directly to the PAM Web site by entering the PAM Web site URL defined during the PAP installation procedure in the **Home Page Address** field:
http://<PAPname>/pam
(where **<PAPname>** is the name allocated to the PAP unit during setup).
2. Launch the browser to connect directly to the PAM web site.
3. When prompted, enter the appropriate Administrator or Operator **User Name** and **Password**. The PAM home page appears.

Simultaneous Connection to the PAM Web Site

Several users can access the PAM Web site simultaneously.



Important:

If configuration changes are made, they may not be visible to other users unless they refresh the PAM Tree.

As Customer Administrator, you can view the list of PAM users currently logged onto the PAM Web site by clicking **Hardware Monitor** → **PAM Web Site**.

The Web site version and a list of connected users and session details are displayed in the **Control** pane.

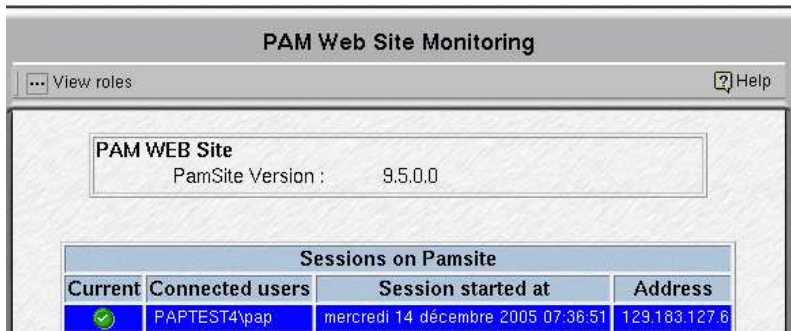

The  icon indicates the current session.

Figure 24. PAM Web site session details

You can also open several browser sessions from the same computer to obtain different views of system operation. For example, as Customer Administrator, you may want to open a first session for permanent and easy access to powering on/off functions, a second session for access to system histories and archives, and a third session for access to configuration menus, as shown in the following figure.

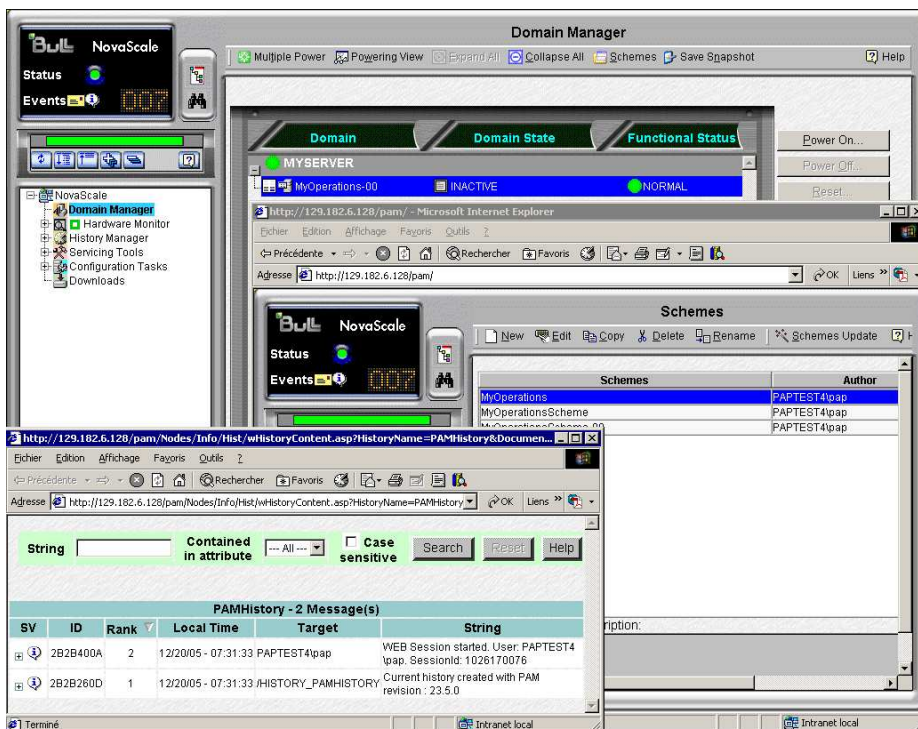
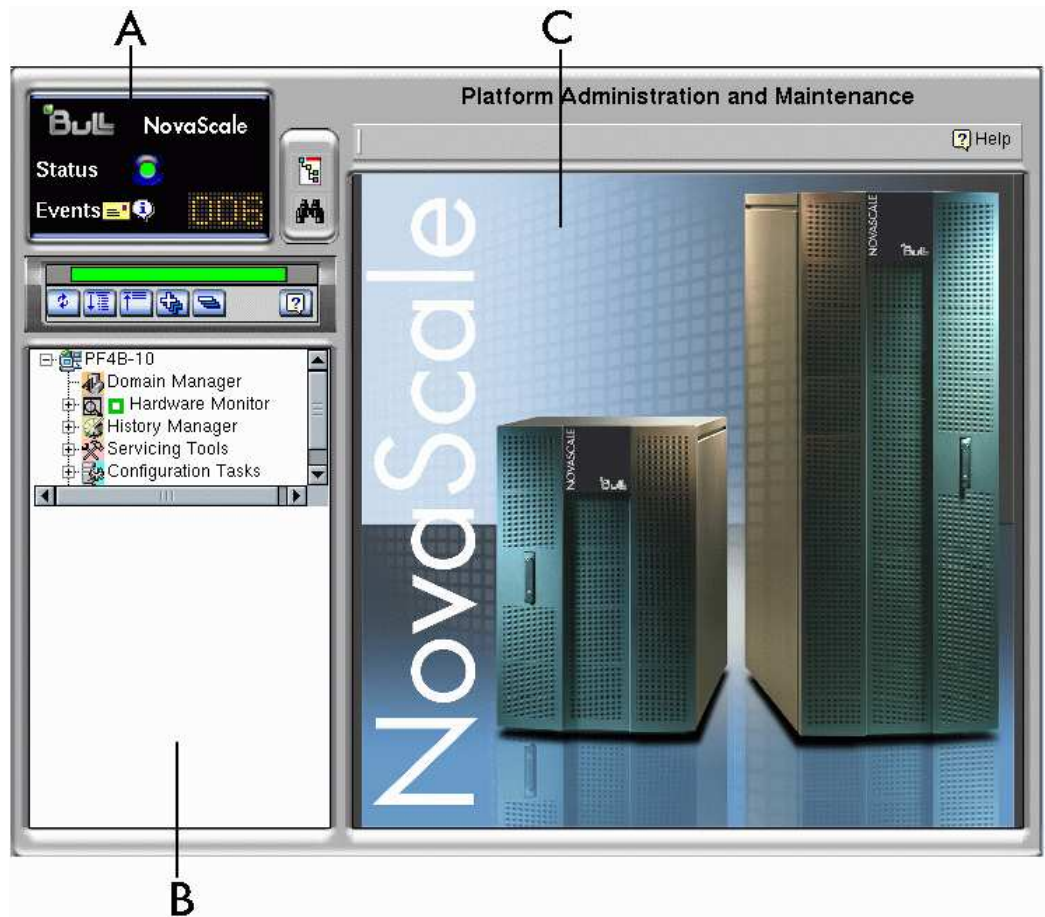

Figure 25. Multiple session example

PAM User Interface

The PAM user interface is divided into three areas in the browser window: a **Status** pane, a **PAM Tree** pane, and a **Control** pane.



A	Status pane, on page 2-6
B	PAM Tree pane, on page 2-7
C	Control pane, on page 2-6

Figure 26. PAM user interface

Checking Server Status via PAM

The PAM user interface allows you to check system status at a glance. If the **Functional Status** icon in the **Status** pane and the **CSS Availability Status** bar are green, the server is ready to be powered up.

PAM Status Pane

The **Status** pane, which is automatically refreshed every few seconds, provides quick access to the following synthetic information:

- **Functional Status:** if the system is operating correctly, the status icon is green,
- **Event Messages:** shows the number and maximum severity of pending event messages,
- **CSS Availability Status:** if the CSS Module PMB is detected as present, is configured correctly, and is ready to operate, the status bar is green.

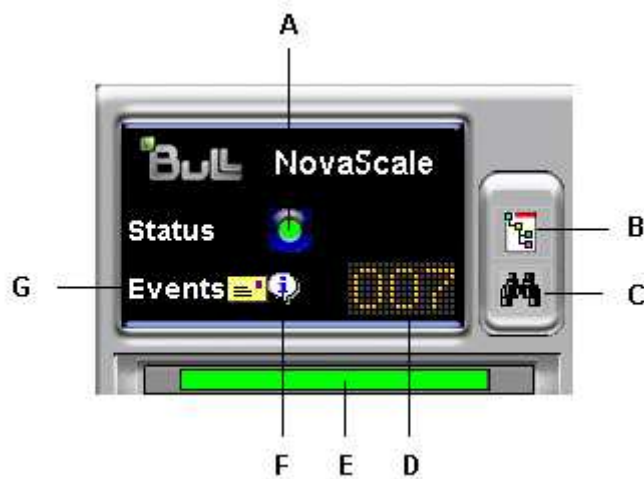

A	System Functional Status icon	E	CSS Availability Status icon
B	Presence/Functional Status toggle button	F	Event Message Severity icon
C	Event Message Viewer	G	New Event Message icon
D	Pending Event Message icon		

Figure 27. Status pane

PAM Control Pane

When an item is selected in the **PAM Tree** pane, details and related commands are displayed in the **Control** pane, which is automatically refreshed at one minute intervals.

CSS Availability Status Bar

The CSS availability status bar reflects the operational status of the data link(s) between the Platform Management Board (PMB) embedded in each CSS Module and the PAP Unit. Each CSS module is represented by a zone in the status bar.

- When a CSS Module PMB is detected as **PRESENT**, the corresponding zone in the status bar is **GREEN**.
- When a CSS Module PMB is detected as **ABSENT**, the corresponding zone in the status bar is **RED**.
- When you hover the mouse over the status bar, an **Infotip** displays the **presence status** of CSS Module PMB - PAP Unit data links.

The following figure represents the status bar for a bi-module server. One CSS Module PMB is detected as PRESENT and the other is detected as ABSENT.



A: Bar red (CSS Module_0 not available)

Figure 28. CSS Module availability status bar (bi-module server)

PAM Tree Pane



Note:

The PAM tree building process may take one to two minutes. The PAM tree pane is refreshed on request.

The **PAM Tree** pane provides access to server administration and maintenance features:

Tree Nodes	Function
Domain Manager	to power on / off and manage domains. See Chapter 3. Managing Domains.
Hardware Monitor	to display the status of hardware components and assemblies. See Chapter 4. Monitoring the Server.
History Manager	to view logs and manage archives. See Chapter 4. Monitoring the Server.
Configuration Tasks	to customize server features. See Chapter 5. Tips and Features for Administrators.

Table 3. PAM Tree nodes

PAM Tree Toolbar

The PAM Tree toolbar, located at the top of the PAM Tree, is used to refresh, expand, or collapse the tree display.









Toolbar Buttons	Explanation
	Refresh /rebuild the PAM Tree to view changes.
	Expand the complete tree.
	Collapse the complete tree.
	Expand selected node.
	Collapse selected node.
	View the related Help topic.

Figure 29. PAM Tree toolbar

Setting up Users

As Customer Administrator, you must set up user accounts and passwords to control access to the PAP unit. See **Setting up PAP Unit Users, on page 5-17**.

toggling the Local / Integrated Console Display

During the powering up / down sequences, you will be requested to toggle the local / integrated console from the PAP unit display to the server domain display, or vice versa, as explained below.



CAUTION:

Access to the local / integrated console should be restricted to Customer / Support Administrators and Operators ONLY to avoid inadvertent damage to software and/or hardware components.

The KVM Switch allows the integrated console to be used as the local server domain and local PAP unit console. KVM ports are configured as shown in Table 4.

NovaScale 5xx5 SMP Server

8-port KVM Switch	Console Display	Domain
Port 1	PAP Unit	N/A
Port 2	Server Domain	N/A

NovaScale 5xx5 Partitioned Server

16-port KVM Switch	Console Display	Domain
Port 1	PAP Unit	N/A
Port 2	CSS0-Mod0-IO0	MyOperations-xx-1
Port 3	CSS0-Mod0-IO1	MyOperations-xx-2
Port 4	CSS0-Mod1-IO0	MyOperations-xx-3
Port 5	CSS0-Mod1-IO1	MyOperations-xx-4
Port 6	CSS0-Mod2-IO0	MyOperations-xx-5
Port 7	CSS0-Mod2-IO1	MyOperations-xx-6
Port 8	CSS0-Mod3-IO0	MyOperations-xx-7
Port 9	CSS0-Mod1-IO1	MyOperations-xx-8

Table 4. KVM port configuration

You can easily toggle from the server domain display to the PAP unit display, or vice versa:

1. From the keyboard, press the **Control** key twice to display the KVM Switch Command Menu.
2. Select the required port with the $\uparrow\downarrow$ keys and press **Enter**.
3. The selected display appears on the Console monitor.

Powering Up / Down Server Domains

To power up / down the server, see:

- Powering Up / Down the NovaScale 5xx5 Partitioned Server Domains, on page 2-12

Powering Up the NovaScale 5xx5 SMP Server Domain

NovaScale 5xx5 SMP Servers are designed to operate as single SMP systems and are delivered with one pre-configured domain.

When server status has been checked - functional status icon and CSS availability status bar green in the Status pane - the server domain can be powered up.



Note:

If an error dialog box appears during this sequence, see Chapter 3. *Managing Domains*.

To power up server domains:

1. From the PAM Tree, click **Domain Manager** to open the **Control** pane. A dialog box invites you to load the server domain.
2. Click **OK** to confirm. The domain appears in the Control pane. If the domain is ready to be powered up, **INACTIVE** is displayed in the **Domain State** box and the **Power On** button is accessible.
3. Select the domain and click **Power On** to power up the server domain and associated hardware components.

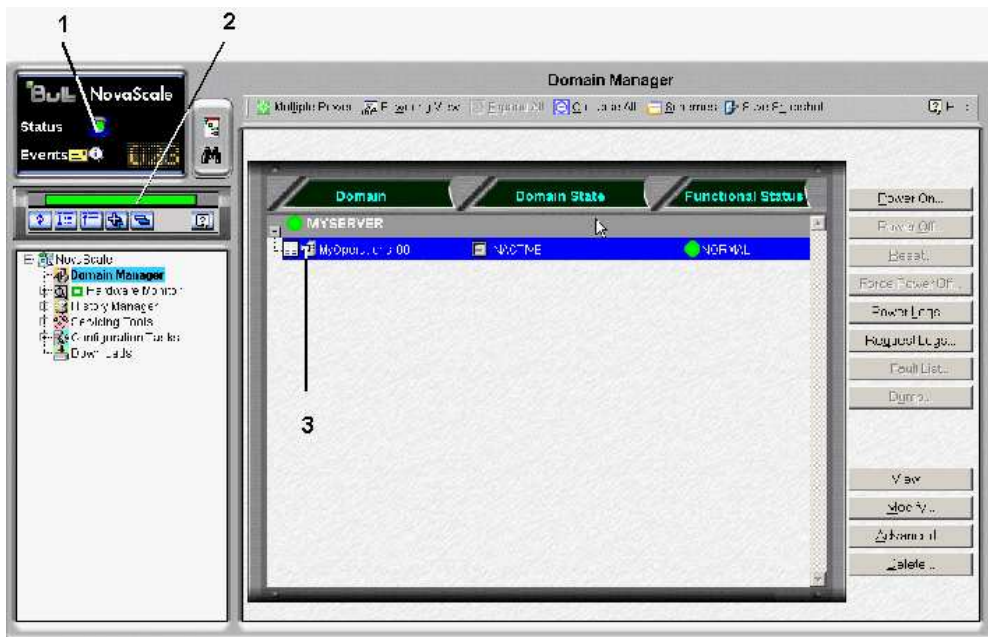

1	Functional status icon
2	CSS availability status indicator (GREEN)
3	Operating system type

Figure 30. Domain Manager Control pane

4. Follow the power-on steps displayed in the **Domain State** box, until **RUNNING** is displayed.

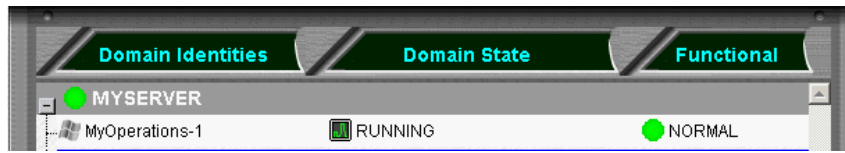

Figure 31. Domain state

5. Toggle the local / integrated console from the PAP unit display to the server display. See **toggling the Local / Integrated Console Display, on page 2-9**.
6. Wait for the Operating System to load completely. The domain is now fully functional.
7. Check the Operating System environment pre-installed on the domain.
8. As Customer Administrator, you can now **prepare each domain for remote access** via the Enterprise LAN and/or via the Web. See **Preparing Server Domains for Remote Access via the Enterprise LAN, on page 2-16** and **Preparing Server Domains for Remote Access via the Web, on page 2-18**.

Powering Down the NovaScale 5xx5 SMP Server Domain

Note:

If an error dialog box appears during this sequence, see **Chapter 3. Managing Domains**.

1. Shut down the Operating System to power down the domain to the stand-by mode.
2. **Toggle the local / integrated console** to the PAP unit display. **INACTIVE** is displayed in the **Domain State** box and the **Power ON** button is accessible.

Note:

For further details about the **Power ON / OFF** sequences, see **Powering ON a Domain, on page 3-14** and **Powering OFF a Domain, on page 3-18**.

- If the same PAP unit administers more than one server, all servers can be powered on simultaneously as follows:
 - a. Click **Multiple Power**. The **Multiple Power Domains On/Off** dialog opens.
 - b. Click **Power On All** → **Execute** to power on the servers and associated hardware components.
- For further details about the **Power ON / OFF** sequences, see **Powering ON a Domain** and **Powering OFF a Domain** in the *User's Guide*.

Powering Up NovaScale 5xx5 Partitioned Server Domains

According to version, NovaScale 5xx5 Partitioned Servers are designed to operate as up to eight hardware-independent SMP systems, or domains.

For easy configuration and optimum use of the physical and logical resources required for simultaneous operation, domains are defined by the Customer Administrator via the **PAM Domain Scheme** wizard. For further details about domain configuration, see *Configuring Domains*, on page 5-28.



The server is delivered with a default scheme, or configuration file, called **MyOperationsScheme-xx**, containing up to eight domains:

- MyOperations-xx-1
- MyOperations-xx-2
- MyOperations-xx-3
- MyOperations-xx-4
- MyOperations-xx-5
- MyOperations-xx6
- MyOperations-xx7
- MyOperations-xx-8

This default scheme allows you to simultaneously boot all domains.

According to your requirements, identical or different Operating System instances may be pre-installed on each domain boot disk (EFI LUN).

Notes:

- **xx** in the default scheme and domain names represents the Central Subsystem HW identifier (from 00 to 15). For further details, refer to For further details, refer to *PMB Leds and Code Wheels*, on page 4-50.
- Operating System type is indicated by the Microsoft Windows  or Linux  logo in the **Domain Identities** box.
- If an error dialog box appears during these sequences, see Chapter 3. *Managing Domains*.
- A Scheme comprising 4 domains is used to illustrate the following example.

To power up server domains:

1. From the PAM Tree, click **Domain Manager** to open the **Control** pane. You are invited to load a domain configuration scheme.
2. Click **Schemes**. The **Schemes List** dialog opens displaying the pre-configured scheme.
3. Select **MyOperationsScheme** and click **Apply**.

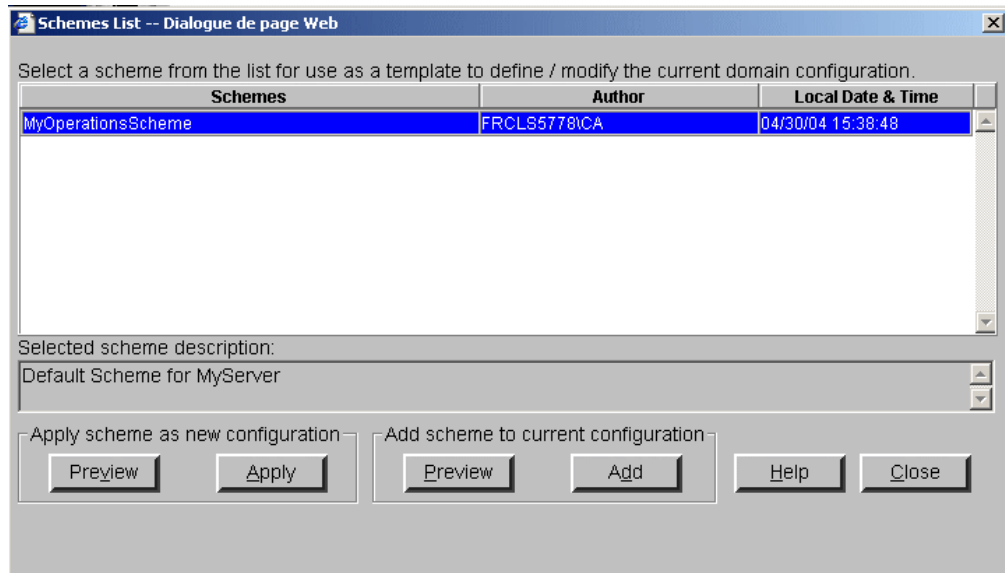
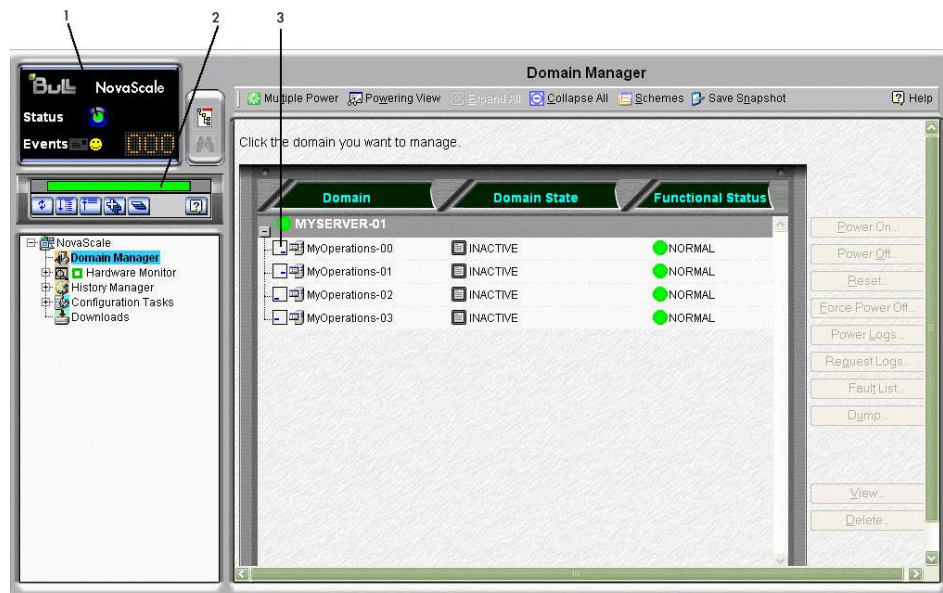

Figure 32. Domain schemes list dialog

4. When requested, click **Yes** to confirm. The default domains are loaded in the **Control** pane.
If the domains are ready to be powered up, **INACTIVE** is displayed in the **Domain State** boxes and the **Power On** button is accessible for each domain.



1	Functional status icon
2	CSS availability status indicator (GREEN)
3	Operating system type

Figure 33. Domain Manager Control pane - example with 4 domains

5. Click **Multiple Power**. The **Multiple Power Domains On/Off** dialog opens.

6. Click **Power On All** → **Execute** to simultaneously power on the domains and associated hardware components.

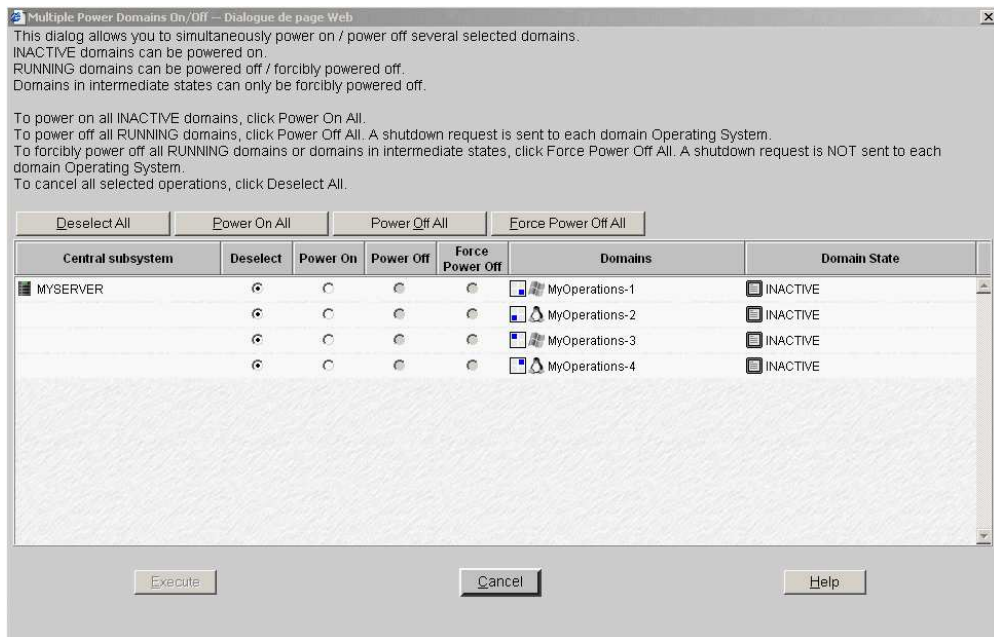

Figure 34. Multiple power dialog - example with 4 domains



Note:

- Domains can also be powered on sequentially from the **Control** pane:
- Select a domain in the **Control** pane and click **Power On** to power up the domain and associated hardware components. Repeat this step for each domain in the **Control** pane.
7. Follow the power-on steps displayed in the **Domain State** boxes, until **RUNNING** is displayed in all **Domain State** boxes.

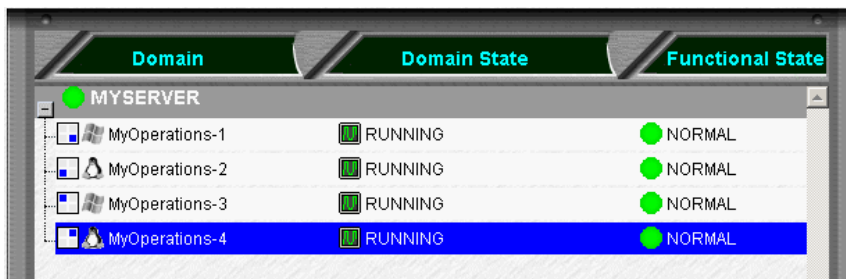

Figure 35. Domain state - example with 4 domains

8. Toggle the local / integrated console from the PAP unit display to the first domain display. See *toggling the Local / Integrated Console Display*, on page 2-9.
9. Wait for the Operating System to load completely. The domain is now fully functional.
10. Toggle the local / integrated console from this domain display to the next domain display.
11. Wait for the Operating System to load completely. The domain is now fully functional.
12. Repeat Steps 10 and 11 for each domain.
13. Check the Operating System environment pre-installed on each domain.

14. As Customer Administrator, you can now prepare each domain for remote access via the Enterprise LAN and/or via the Web. See *Preparing Server Domains for Remote Access via the Enterprise LAN*, on page 2-16 and *Preparing Server Domains for Remote Access via the Web*, on page 2-18.

Powering Down NovaScale 5xx5 Partitioned Server Domains

1. Shut down each Operating System to power down the corresponding domain to the stand-by mode.
2. Toggle the local / integrated console to the PAP unit display. **INACTIVE** is displayed in the **Domain State** boxes and the **Power ON** button is accessible for each domain.



Note:

For further details about the **Power ON / OFF** sequences, see *Powering ON a Domain*, on page 3-14 and *Powering OFF a Domain*, on page 3-18.



Note:

For further details about the **Power ON / OFF** sequences, see *Powering ON a Domain* and *Powering OFF a Domain* in the *User's Guide*.

Preparing Server Domains for Remote Access via the Enterprise LAN



CAUTION:

Access to the local / integrated console should be restricted to Customer / Support Administrators and Operators ONLY to avoid inadvertent damage to software and/or hardware components.



Note:

Required networking data is indicated in the *Read Me First* document delivered with the server and is also recorded under the corresponding PAM **Domain Identity**. Customer Administrator rights are required for all PAM configuration tasks.

Microsoft Windows Domain

1. Toggle the integrated console to the corresponding Windows domain port. See *Toggling the Local / Integrated Console Display*, on page 2-9.
2. From the Windows desktop, right click **My Computer** and select **Properties** → **Remote**.
3. Check the **Allow remote connection** box.
4. Share the `<system root>\system32\clients\tsc\client` directory via the Explorer.
5. Toggle the integrated console to the PAP unit port.
6. From the Customer Administrator PAM tree, click **Configuration Tasks** → **Domains** → **Identities** to open the **Identities** page.
7. Select the corresponding Windows domain from the list and click **Edit** to open the **Edit an Identity** dialog.
8. Check that the **Network Name**, **IP Address**, and **URL** fields are completed. If not, complete these fields with the networking data entered during the Windows setup completion procedure and click **OK**.

Linux Redhat Domain

1. Toggle the integrated console to the corresponding Linux domain port. See *Toggling the Local / Integrated Console Display*, on page 2-9.
2. From the Linux desktop, enable remote connection via **telnet**, **rlogin**, **ftp**, ...:
3. From the PAP unit Internet Explorer or Mozilla browser, enter the Webmin URL: **http://<networkname>:10000**, where **<networkname>** is the network name given to the server domain during the Linux setup completion procedure. The **Login to Webmin** dialog box opens.
4. Click the **Networking** icon. The **Networking** main page opens.
5. Click **Extended Internet Services** to display the list of available services.
6. From the service list, check that **Yes** is displayed in the status column. If **No** is displayed in the status column, proceed as follows to enable the service:
 - a. Select the required service from the list.
 - b. Complete the fields accordingly.
 - c. Click **Yes** after **Service enabled?**
 - d. Click **Save**.
7. Repeat step 3 for each required service.
8. Click **Apply changes** to apply all changes.

9. Click **Return to index**.
10. Click **Log Out** to exit **Webmin**.
11. Toggle the integrated console to the PAP unit port.
12. From the Customer Administrator PAM tree, click **Configuration Tasks** → **Domains** → **Identities** to open the **Identities** page.
13. Select the corresponding Linux domain from the list and click **Edit** to open the **Edit an Identity** dialog.
14. Check that the **Network Name**, **IP Address**, and **URL** fields are completed. If not, complete these fields with the networking data entered during the Linux setup completion procedure and click **OK**.

Linux SuSE Domain

1. Toggle the integrated console to the corresponding Linux domain port. See *Toggling the Local / Integrated Console Display*, on page 2-9.
2. From the Linux desktop, enable remote connection via **telnet**, **rlogin**, **ftp**, ...:
3. Launch the **yast2** command to open the **Yast Control Center** screen.
4. Click the **Network/Basic** icon in the left pane.
5. Click **Start/stop services (inetd)**.
6. From the **Network Services** page, select **On with customer configuration** and click **Next** to open the **Enable/disable network services** page.
7. From the service list, check that **Active** is displayed in the status column. Proceed as follows to enable the service:
 - a. Select the required service from the list.
 - b. Click **Activate**.
8. Repeat step 5 for each required service.
9. Click **Finish** to apply all changes.
10. Click **Close** to exit **yast2**.
11. Toggle the integrated console to the PAP unit port.
12. From the Customer Administrator PAM tree, click **Configuration Tasks** → **Domains** → **Identities** to open the **Identities** page.
13. Select the corresponding Windows domain from the list and click **Edit** to open the **Edit an Identity** dialog.
14. Check that the **Network Name**, **IP Address**, and **URL** fields are completed. If not, complete these fields with the networking data entered during the Linux setup completion procedure and click **OK**.

Preparing Server Domains for Remote Access via the Web



CAUTION:

Remote access via the Web is a potential security hazard. Customers are strongly advised to protect their systems with up-to-date protection devices such as virus-prevention programs and firewalls, and to maintain a detailed record of authorized users.

Microsoft Windows Domain

1. Toggle the integrated console to the corresponding Windows domain port. See *Toggling the Local / Integrated Console Display*, on page 2-9.
2. Left click **Start** → **Control Panel** → **Add or Remove Programs**.
3. Select **Add / Remove Windows Components**.
4. Click **Web Application Services** → **Details** → **Internet Information Services** → **Details** → **World Wide Web Services** → **Details** → **Remote Desktop Web Connection**. Validate where required by clicking **OK** or **Next**.
5. Insert the the Microsoft Windows CD-ROM in the CD-ROM / DVD drive.
6. The Microsoft Windows setup wizard is launched automatically and guides you through the setup completion procedure.
7. Toggle the integrated console to the PAP unit port.
8. From the Customer Administrator PAM tree, click **Configuration Tasks** → **Domains** → **Identities** to open the **Identities** page.
9. Select the corresponding Windows domain from the list and click **Edit** to open the **Edit an Identity** dialog.
10. Check that the **Network Name**, **IP Address**, and **URL** fields are completed. If not, complete these fields with the networking data entered during the Windows setup completion procedure and click **OK**.

Linux Domain

Virtual Network Computing (VNC) remote control software allows users to interact with the server from a remote computer via Internet.

The server domain is ready for remote connection.

1. Toggle the integrated console to the PAP unit port.
2. From the Customer Administrator PAM tree, click **Configuration Tasks** → **Domains** → **Identities** to open the **Identities** page.
3. Select the corresponding Linux domain from the list and click **Edit** to open the **Edit an Identity** dialog.
4. Check that the **Network Name**, **IP Address**, and **URL** fields are completed. If not, complete these fields with the networking data entered during the Linux setup completion procedure and click **OK**.

Connecting to a Server Domain via the Enterprise LAN

Microsoft Windows Domain

1. Check that **Client for Microsoft Networks** is installed on the remote computer and that the remote computer is connected to the same LAN as the server domain.
2. Check that **Client for Remote Desktop** is installed on the remote computer. If the **Remote Desktop Connection** menu does not exist:
 - a. Click **Start** → **Run**.
 - b. Type `\\<networkname>\tsclient\win32\setup.exe` in the box, where `<networkname>` is the network name given to the server domain during the Windows setup completion procedure.
3. Connect to the server domain by running:
 - a. Microsoft Windows XP (and later):
All Programs → **Accessories** → **Communication** → **Remote Desktop Connection**.
 - b. All other versions of Microsoft Windows:
Programs → **Remote Desktop Connection** → **OK**.
4. Type **Administrator** (default administrator user name) in the **User name** field.
5. Type the administrator password defined during the Windows setup completion procedure in the **Password** field.
6. The remote computer connects to the server domain.

Linux Domain

1. Enter the following command:
`ssh <networkname> -l user_name`, where `<networkname>` is the network name given to the server domain during the Linux setup completion procedure.
2. The remote computer connects to the server domain.

Connecting to the Server via the Web

Microsoft Windows Domain

1. Check that **Internet Explorer** (6 or later) and **Terminal Server Client** are installed on the remote computer.
2. Launch the Internet Explorer or Netscape browser and connect to the server desktop, url: **http://<networkname>/tsweb/**, where **<networkname>** is the network name given to the server domain during the Windows setup completion procedure. See the *Read Me First* document delivered with the server.

Linux Domain

Virtual Network Computing (VNC) remote control software allows users to interact with the server from a remote computer via Internet.

1. Check that **VNC Server** is installed.
2. Execute the **vncpasswd** command to initialize the password.
3. Execute the **vncserver** command to start the process.
4. Record the **<networkname>** display number for the remote computer, where **<networkname>** is the network name given to the server domain during the Linux setup completion procedure.

Installing Applications



Important:

Reserved for partitioned servers and extended systems. Please contact your Bull Sales Representative for sales information.

When you install an application protected by a system serial number, you are requested to supply this serial number.

For optimum flexibility, PAM software allows you to replace the physical serial number by a logical licensing number so that you can run the application on any physical partition and, in the case of extended systems, on any of the Central Subsystems within the extended configuration.

For details on how to define and manage the logical licensing number, please refer to *Creating, Editing, Copying, Deleting a Domain Identity*, on page 5-50.

Chapter 3. Managing Domains

This chapter explains how, as Customer Administrator and/or Customer Operator, you can manage server domains. It includes the following topics:

- Introducing PAM Domain Management Tools, on page 3-2
- Managing Domain Configuration Schemes, on page 3-5
- Synchronizing NovaScale 5xx5 SMP Server Domains, on page 3-6
- Powering On a Domain, on page 3-14
- Powering Off a Domain, on page 3-18
- Forcing a Domain Power Off, on page 3-21
- Performing a Domain Memory Dump, on page 3-24
- Manually Resetting a Domain, on page 3-25
- Deleting a Domain, on page 3-26
- Viewing the Domain Fault List, on page 3-28
- Viewing Domain Functional Status, on page 3-29
- Viewing Domain Power Logs, on page 3-31
- Viewing Domain Powering Sequences, on page 3-32
- Viewing Domain BIOS Info, on page 3-33
- Viewing Domain Request Logs, on page 3-34
- Viewing Domain Configuration, Resources and Status, on page 3-35
- What to Do if an Incident Occurs, on page 3-42

 **Note:**

Customer Administrators and Customer Operators are respectively advised to consult the *Administrator's Memorandum*, on page xxiii or the *Operator's Memorandum*, on page xxv for a detailed summary of the everyday tasks they will perform.

For further information about user accounts and passwords, see *Setting up PAP Unit Users*, on page 5-17.

Introducing PAM Domain Management Tools



Important:

Certain domain configuration and management tools are reserved for use with partitioned servers and extended systems. Please contact your Bull Sales Representative for sales information.

A Bull NovaScale Server domain englobes all the hardware and software resources managed by an Operating System instance.

NovaScale 5xx5 SMP Servers are designed to operate as single SMP systems and are delivered with one pre-configured domain.

NovaScale 5xx5 Partitioned Servers are designed to operate as one, two, three or four hardware-independent SMP systems or domains, each running an Operating System instance and a specific set of applications.

The PAM **Domain Manager** is at the heart of server operation and the Control pane is frequently used during operation. The **Domain Manager** Control pane gives access to all domain commands and domain details.

What You Can Do

Via the **Domain Manager** Control pane, you can:

- *Manage domain configuration schemes*
- *Power on a domain*
- *Power off a domain*
- *Perform a domain reset*
- *Perform a domain force power off*
- *Request a domain memory dump*
- *View functional status*
- *View power logs*
- *View powering sequences*
- *View BIOS info*
- *View request logs*
- *View domain configuration, resources and status*



Note:

Access to certain hardware resources, such as system disks can be limited by using the **Exclusion / Inclusion** function. See *Limiting Access to Hardware Resources*, on page 5-66 and *Excluding / Including Hardware Elements*, on page 4-23. This function must be used with care.

From the PAM Tree, click **Domain Manager** to open the **Control** pane.

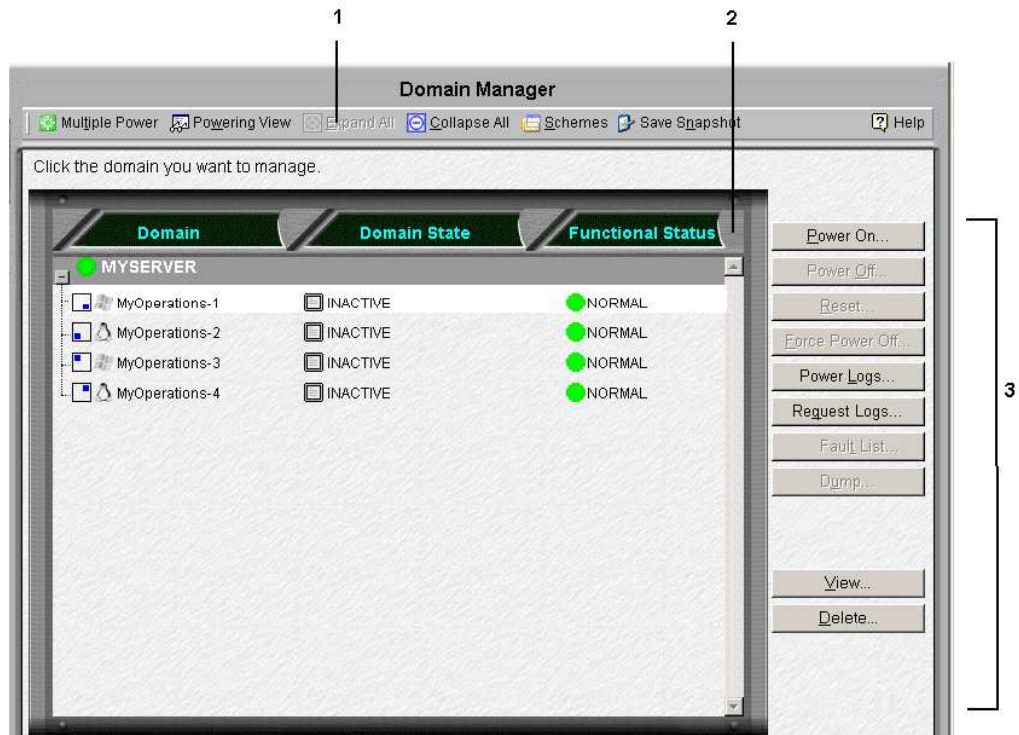

Toolbar (1)	
Multiple Power	Allows you to simultaneously power on /off several domains. See <i>Powering ON a Domain</i> , on page 3-14 and <i>Powering OFF a Domain</i> , on page 3-18.
Powering View	Dynamically displays domain power sequences and gives access to Power Logs, see details on page 3-31 and BIOS Info, see details on page 3-33.
Expand All	Expands the list of domains included in the current domain configuration.
Schemes	Loads a selected scheme and displays Scheme Properties, see details on page 3-8.
Save Snapshot	Saves current domain configuration as a new scheme for future use, see details on page 3-11.

Status Panel (2)	
Domain Identities	The names given to clearly identify domains, see details on page 5-28.
Domain State	Power sequence state. See <i>Powering ON a Domain</i> , on page 3-14 and <i>Powering OFF a Domain</i> , on page 3-18.
Functional Status	Status of the last action performed on a domain. See <i>Viewing Domain Functional Status</i> , on page 3-29.

Command Bar (3)	
Power On	Powers on the selected domain, see details on page 3-14.
Power Off	Powers off the selected domain, see details on page 3-18.
Reset	Resets the selected domain, see details on page 3-25.
Force Power Off	Forcibly powers off the selected domain, see details on page 3-21.
Power Logs	Displays power sequence logs, see details on page 3-31.
Request Logs	Displays Power On, Power Off, and Reset requests and requestors, see details on page 3-34.
Fault List	Gives access to the domain fault list, see details on page 3-28.
Dump	Performs a domain memory dump, see details on page 3-24.
View	Opens the View Domain dialog, which displays domain configuration data and gives access to Domain Resources, see details on page 3-35 and BIOS Info, see details on page 3-33.
Delete	Removes the selected domain from the current domain configuration, see details on page 3-26.

Table 5. PAM Domain Manager tools

Managing Domain Configuration Schemes



Important:

Reserved for partitioned servers and extended systems.

Certain features described below are only available if you are connected to a Storage Area Network (SAN).

Please contact your Bull Sales Representative for sales information.

What You Can Do

Via the **Schemes** tool in the **Domain Manager** Control pane toolbar, you can:

- View a domain configuration scheme
- Load a domain configuration scheme
- Add domains to the current domain configuration
- Replace the current domain configuration
- Save the current domain configuration snapshot

A **Domain Configuration Scheme** is the template or configuration file used to define and manage a set of domains that can be active simultaneously. For easy configuration and optimum use of the physical and logical resources required for simultaneous operation, domains are defined via the **PAM Domain Configuration Scheme** wizard.



Note:

Server components and configuration may differ according to site requirements.

NovaScale 5xx5 SMP Server

NovaScale 5xx5 SMP Servers are designed to operate as single SMP systems and are delivered with one pre-configured domain.

NovaScale 5085 Partitioned Server

The NovaScale 5085 Partitioned Server is designed to operate as one or two hardware-independent domains. The server is delivered with a pre-configured domain configuration scheme called **MyOperationsScheme** containing two domains, **MyOperations-1** and **MyOperations-2**, allowing you to manage and administer all server resources.

NovaScale 5165 Partitioned Server

The NovaScale 5165 Partitioned Server is designed to operate as one, two, three or four hardware-independent domains. The server is delivered with a pre-configured domain configuration scheme called **MyOperationsScheme** containing four domains, **MyOperations-1**, **MyOperations-2**, **MyOperations-3** and **MyOperations-4**, allowing you to manage and administer all server resources.

NovaScale 5245 Partitioned Server

The NovaScale 5245 Partitioned Server is designed to operate as from one to six hardware-independent domains. The server is delivered with a pre-configured domain configuration scheme called **MyOperationsScheme** containing six domains, **MyOperations-1**, **MyOperations-2**, **MyOperations-3**, **MyOperations-4**, **MyOperations-5** and **MyOperations-6**, allowing you to manage and administer all server resources.

NovaScale 5325 Partitioned Server

The NovaScale 5325 Partitioned Server is designed to operate as from one to heigh hardware-independent domains. The server is delivered with a pre-configured domain configuration scheme called **MyOperationsScheme** containing four domains, **MyOperations-1**, **MyOperations-2**, **MyOperations-3**, **MyOperations-4**, **MyOperations-5**, **MyOperations-6**, **MyOperations-7** and **MyOperations-8**, allowing you to manage and administer all server resources.



Note:

As Customer Administrator, you may configure other schemes for domain management. For further details about domain configuration options, see *Configuring Domains*, on page 5-28.

To power on server domains, you must first load the required **Domain Configuration Scheme** from the **Domain Manager** Control pane. Once the domain configuration scheme has been loaded, domains can be powered up simultaneously or sequentially.

Synchronizing NovaScale 5xx5 SMP Server Domains

The **Synchronize Domains** command is used to load the NovaScale 5xx5 SMP Server domain. Each NovaScale 5xx5 SMP Server is delivered with one pre-configured domain.

To load the server domain:

Click **Synchronize Domains** in the toolbar. The server domain(s) appear(s) in the Control pane for management.

The other **Schemes** tool options are reserved for partitioned (NovaScale 5xx5 Partitioned Servers) or extended systems. See *Configuring and Managing Extended Systems*, on page 5-125.



Note:

Extended systems: this command will load all the NovaScale 5xx5 SMP Server domains administered by your PAP unit.

Viewing a Domain Configuration Scheme

Before loading a domain configuration scheme, you may want to know more about its scope.

To view a scheme:

1. Click **Domain Manager** to open the Control pane.

- Click **Schemes** in the Toolbar to open the **Schemes List** dialog.

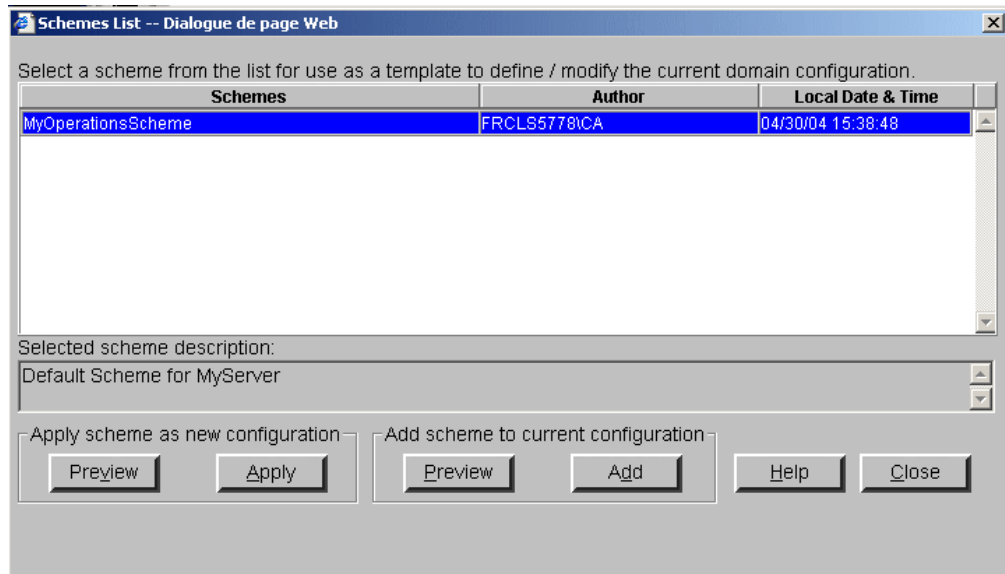
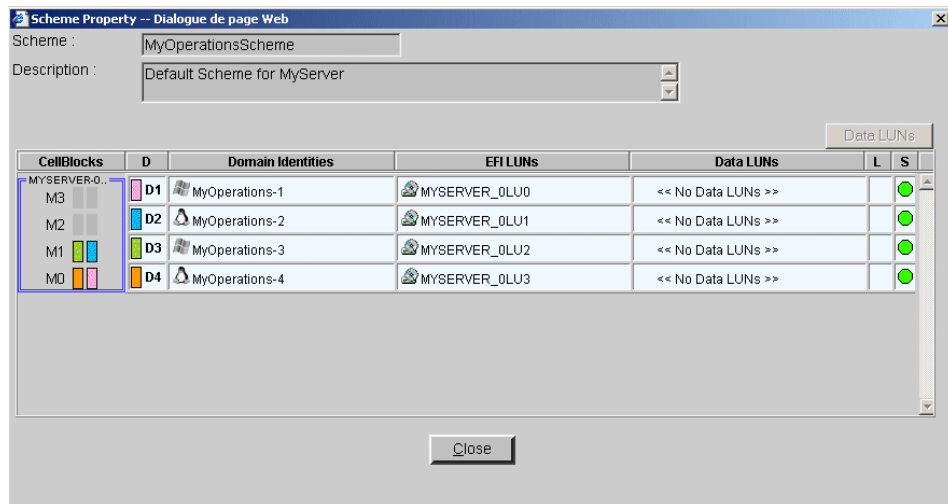

Figure 36. Schemes list dialog

- Select the required **Scheme** from the list and click **Preview** to view scheme properties.



CellBlocks	Shows the Central Subsystems included in the scheme and how they are partitioned into domains.
D	Identifies physical partitions.
Domain Identities	Shows the Identities allocated to each domain.
EFI LUNs	Indicates the EFI LUNs used to boot each domain.
Data LUNs	Indicates the Data LUNs used by each domain.
L	Indicates whether domain boot and data LUNs are linked to a fibre channel host. Reserved for systems connected to a SAN.
S	Indicates domain configuration status. A Green status icon indicates that the domain is configured correctly and is ready for use, a Red status icon indicates that the domain is not configured correctly and is not ready for use. If the status icon is Red, see <i>Configuring Domains</i> , on page 5-28.

Figure 37. Scheme properties dialog - Example with 4 domains

Loading a Domain Configuration Scheme

To power on server domains, you must first load the required **Domain Configuration Scheme** from the **Domain Manager** Control pane. Once the domain configuration scheme has been loaded, domains can be powered up simultaneously or independently.

To load a scheme:

1. Click **Domain Manager** to open the Control pane. If a scheme has not been previously loaded, you are invited to load one.



Note:

If the required scheme is already loaded, it is available for domain management. If a scheme is already loaded, but is not the required scheme, see *Adding Domains to the Current Domain Configuration* and *Replacing the Current Domain Configuration* below.

2. Click **Schemes** in the Toolbar to open the **Schemes List** dialog.

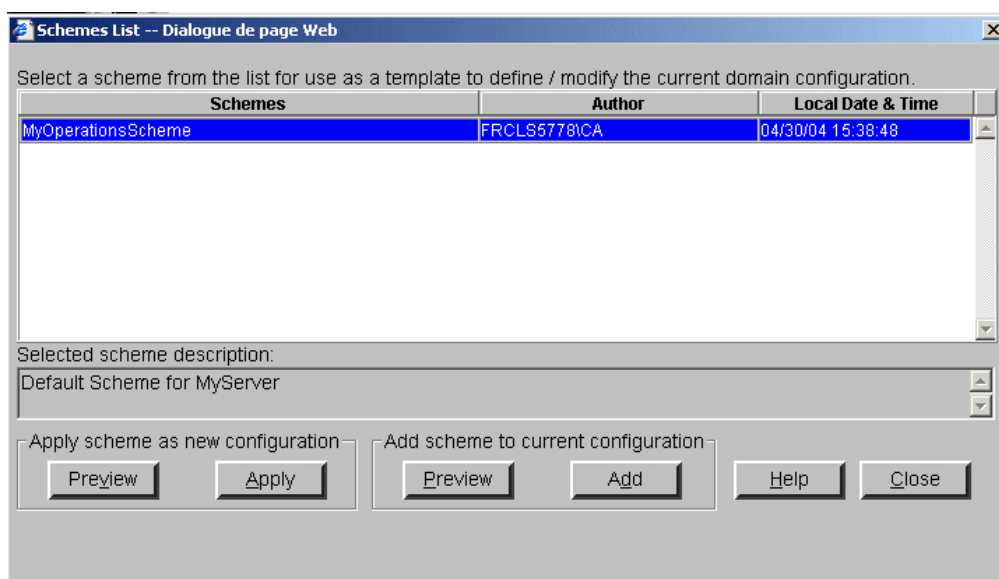

Figure 38. Schemes list dialog

3. Select the required **Scheme** from the list and click **Preview** to view scheme properties. See *Viewing a Domain Configuration Scheme*, on page 3-6.
4. Click **Apply**. A dialog box informs you that the selected scheme will replace the current domain configuration.
5. Click **Yes** to confirm. All the domains included in the selected scheme are loaded in the Control pane and are available for management.

If the domains are ready to be powered up, **INACTIVE** is displayed in the **Domain State** boxes. The **Power On** button becomes accessible once a domain has been selected.

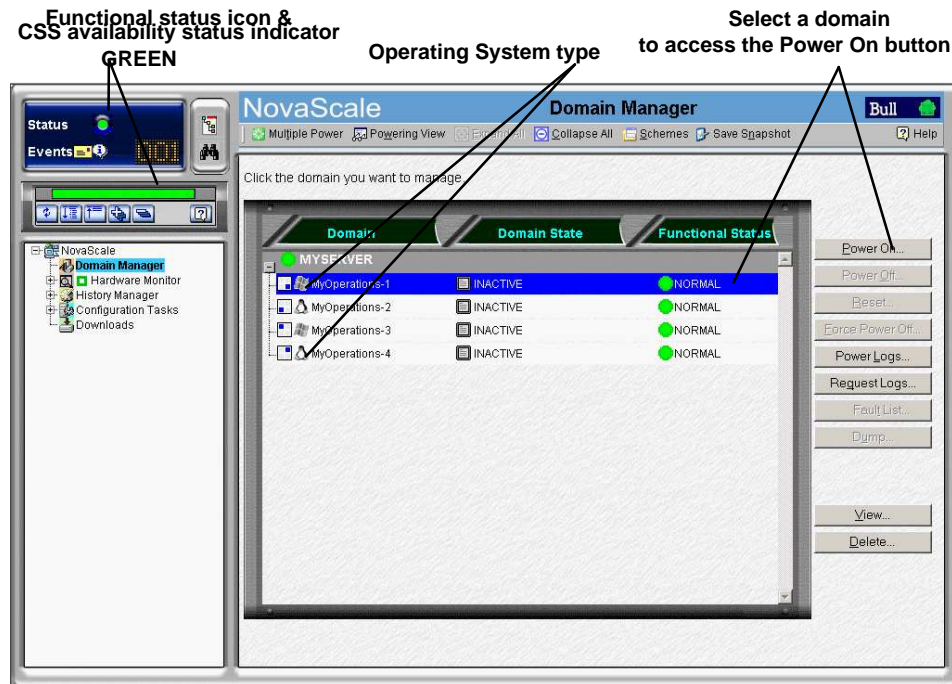



Figure 39. Domain Manager control pane - Example with 4 domains



Note:

To display an Infotip listing the domain IP address, network name, cell composition and/or EFI LUN, hover the mouse over the  icon:

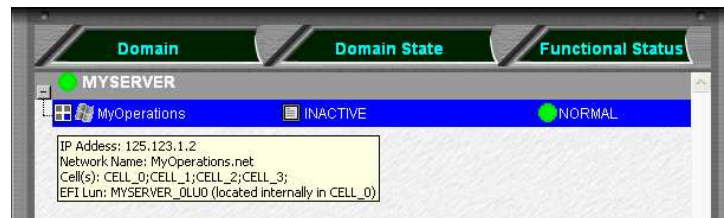

Figure 40. Domain Infotip

Adding Domains to the Current Domain Configuration

A scheme can include domains from one or more Central Subsystems. More domains can be made available for domain management by adding one or more schemes to the current domain configuration.

Notes:

- New domains can only include resources that are **INACTIVE** in the current domain configuration.
- The current domain configuration can be partially replaced by first deleting **INACTIVE** domains and then adding a new domain scheme
- New domains must be configured via **Configuration Tasks** before they are available for domain management. For further details, see *Configuring Domains*, on page 5-28.

To add domains:

1. Click **Domain Manager** to open the Control pane.
2. Click **Schemes** in the Toolbar to open the **Schemes List** dialog.
3. Select the required **Scheme** from the list and click **Preview** to view scheme properties. See *Viewing Domain Configuration Schemes*, on page 3-6.
4. Click **Add**. All the domains included in the scheme added are now available for management in the Control pane.

Replacing the Current Domain Configuration

Note:

All domains must be **INACTIVE** before the current domain configuration can be replaced.

To replace the current domain configuration:

1. Click **Domain Manager** to open the Control pane.
2. Check that all domains are **INACTIVE**. If a domain is not **INACTIVE**, it must be powered down before the current domain configuration can be replaced. See *Powering OFF a Domain*, on page 3-18.
3. If required, save the current domain configuration. See *Saving the Current Domain Configuration Snapshot*, on page 3-11.
4. Click **Schemes** in the Toolbar to open the **Schemes List** dialog.
5. Select the required scheme from the list and click **Preview** to view scheme properties. See *Viewing a Domain Configuration Scheme*, on page 3-6.
6. Click **Apply**. A dialog box informs you that the selected scheme will replace the current domain configuration.
7. Click **Yes** to confirm. All the domains included in the selected scheme are loaded in the Control pane and are available for management.

Saving the Current Domain Configuration Snapshot



Note:

Reserved for Customer Administrators.

You may want to save the current domain configuration, in particular if more than one scheme has been loaded and/or if you have modified domain configuration. When you save the current domain configuration, you create a new domain configuration scheme which is then available for domain management.

To save the current domain configuration snapshot:









1. Click **Domain Manager** to open the Control pane.
2. Click **Save Snapshot**. The **Save Snapshot** dialog opens.

Schemes	Author	Local Date & Time
MyOperationsScheme	FRCLS5778\CA	04/30/04 15:38:48

Figure 41. Save Snapshot dialog

3. Enter a name and description for the new domain configuration scheme and click **Save**. The **Snapshot** is now available as a scheme for domain management. For further details, see *Configuring Domains*, on page 5-28.

MyOperationsScheme Organization - NovaScale 5xx5 Partitioned Servers

Domain Identity: MyOperations-1	
Hardware Cell	Cell_0
Operating System (customer-specific)	 Windows or  Linux
EFI LUN**	*<MyServer>_OLU0 / <SAN>_LUN0
IOC	Module0_IOC0
QBBs	Module0_QBB0
Domain KVM Ports	***CSS0_Mod0_IO0
Domain Identity: MyOperations-2	
Hardware Cell	Cell_1
Operating System (customer-specific)	 Windows or  Linux
EFI LUN**	*<MyServer>_OLU1 / <SAN>_LUN1
IOC	Module0_IOC1
QBBs	Module0_QBB1
Domain KVM Ports	***CSS0_Mod0_IO1
Domain Identity: MyOperations-3 (NovaScale 5165 Partitioned Server)	
Hardware Cell	Cell_2
Operating System (customer-specific)	 Windows or  Linux
EFI LUN**	*<MyServer>_OLU2 / <SAN>_LUN2
IOC	Module1_IOC0
QBBs	Module1_QBB0
Domain KVM Ports	***CSS0_Mod1_IO0
Domain Identity: MyOperations-4 (NovaScale 5165 Partitioned Server)	
Hardware Cell	Cell_3
Operating System (customer-specific)	 Windows or  Linux
EFI LUN**	*<MyServer>_OLU3 / <SAN>_LUN3
IOC	Module1_IOC1
QBBs	Module1_QBB1
Domain KVM Ports	***CSS0_Mod1_IO1

* <MyServer> = default server name, e.g.: NS6085-0, NS6165-0

* <SAN> = default SAN name

** EFI LUN: xLUx = Local boot LUN device location (ModxLUIOx):

OLU0 = LUN device located in Module0_DIB0 or connected to Module0_IOC0

OLU1 = LUN device located in Module0_DIB1 or connected to Module0_IOC1

OLU2 = LUN device located in Module1_DIB0 or connected to Module1_IOC0

OLU3 = LUN device located in Module1_DIB1 or connected to Module1_IOC1

***CSSx = CSS number, Modx = Module number, IOx = IO box number

Operating System type is indicated by the Microsoft Windows  or Linux  logo in the **Domain Identities** box.

Table 6. MyOperations Scheme organization - NovaScale 5xx5 Partitioned Servers

 **Notes:**

- In the screen shots, tables, and examples in this guide:
 - **MyOperationsScheme-xx** is referred to as **MyOperationsScheme**
 - **MyOperations-xx-1** is referred to as **MyOperations-1**
 - **MyOperations-xx-2** is referred to as **MyOperations-2**
 - **MyOperations-xx-3** is referred to as **MyOperations-3**
 - **MyOperations-xx-4** is referred to as **MyOperations-4**
- **xx** in the default scheme and domain names represents the Central Subsystem HW identifier (from 00 to 16). For further details, refer to *PMB LEDs and Code Wheels*, on page 4-50.

Powering On a Domain

What You Can Do

During the domain power-on sequence, you can:

- View *functional status*
- View *power logs*
- View *powering sequences*
- View *BIOS info*
- View *request logs*
- View *domain configuration, resources and status*



Important:

Certain domain configuration and management tools are reserved for use with partitioned servers and extended systems. Please contact your Bull Sales Representative for sales information.

Once connected to the Customer's site power supply, the server initializes to the stand-by mode and the integrated PAP unit powers up. The server is not equipped with a physical power button and server domains are powered up from the PAM **Domain Manager** Control pane.

Check server functional status via the PAM **Status Pane**. If functional status is normal and the **CSS Availability** bar is green, server domains can be powered up.



Notes:

- When more than one domain is loaded in the Control pane, domains can be powered up sequentially or simultaneously. See *Powering on a Single Domain*, on page 3-14 and *Powering On Multiple Domains*, on page 3-15.
- Server domains may be powered up even if the server presents a minor fault. See *System Functional Status*, on page 4-4. However, you are advised to contact your Customer Service Engineer so that the fault can be repaired.

Powering On a Single Domain

To power up a single domain:

NovaScale 5xx5 SMP Servers

1. Click **Domain Manager** to open the Control pane:
 - If the domain is already loaded, it is available for domain management. Go to Step 2 below.
 - If the domain is not already loaded, click **Synchronize Domains** in the toolbar to load the domain.

NovaScale 5xx5 Partitioned Servers

1. Click **Domain Manager** to open the Control pane:
 - If the required domain configuration scheme is already loaded, the corresponding domain(s) are available for domain management. Go to Step 2.
 - If a scheme has not been previously loaded, you are invited to select and load a scheme. See *Viewing a Domain Configuration Scheme*, on page 3-6 and *Loading a Domain Configuration Scheme*, on page 3-8.

- If a Scheme is already loaded, but is not the required Scheme, see *Adding Domains to the current Domain Configuration* and *Replacing the current Domain Configuration*, on page 3-10.
2. Select the required domain. If the domain is in the stand-by mode, **INACTIVE** is displayed in the **Domain Status** panel and the **Power On** button is accessible.



Important:

If **INACTIVE** is not displayed in the **Domain Status** panel and the **Power On** button is not accessible, check whether another user has already launched the power-up sequence on this domain. If the power-up sequence is not already in progress, see *What To Do if an Incident Occurs*, on page 3-42.

3. Click **Power On** to power up the domain and associated hardware components. The **Power On Confirmation** dialog opens.
4. Select the **View Power-On Logs** checkbox if you want power-on logs to be automatically displayed during the power-on sequence and click **Yes** to confirm.

Domain hardware is powered up from the stand-by mode to the main mode and the Operating System is booted. As the power-on sequence progresses, power-on steps and domain state are displayed in the **Domain Status** panel, as shown in the following table.

Power On States
POWERING ON
POWERED ON - LOADING BIOS
BIOS READY - STARTING EFI
EFI STARTED - BOOTING OS
RUNNING

Table 7. Power-on states

Once the **Power On** sequence has been successfully completed, **RUNNING** is displayed in the **Domain Status** panel and the **Power Off**, **Reset** and **Force Power Off** buttons become accessible.

For a **detailed view of the Power On sequence**, click **Powering View** in the Toolbar. See *Viewing Domain Powering Sequences*, on page 3-32.

5. Repeat Steps 2 to 4 for each domain to be powered up.



Note:

If an error message is displayed in the **Domain Status** panel, the **Power On** sequence has failed. See *What To Do if an Incident Occurs*, on page 3-42.

Powering On Multiple Domains

To power up more than one domain:

NovaScale 5xx5 SMP Servers

1. Click **Domain Manager** to open the Control pane:
 - If the domains are already loaded, they are available for domain management. Go to Step 2 below.
 - If the domains are not already loaded, click **Synchronize Domains** in the toolbar to load all domains.

NovaScale 5xx5 Partitioned Servers

1. Click **Domain Manager** to open the Control pane:

- If the required domain configuration scheme is already loaded, the corresponding domain(s) are available for domain management. Go to Step 2.
- If a scheme has not been previously loaded, you are invited to select and load a scheme. See *Viewing a Domain Configuration Scheme*, on page 3-6 and *Loading a Domain Configuration Scheme*, on page 3-8.
- If a Scheme is already loaded, but is not the required Scheme, see *Adding Domains to the current Domain Configuration* and *Replacing the current Domain Configuration*, on page 3-10.

2. Click **Multiple Power**. The **Multiple Power Domains On/Off** dialog opens.

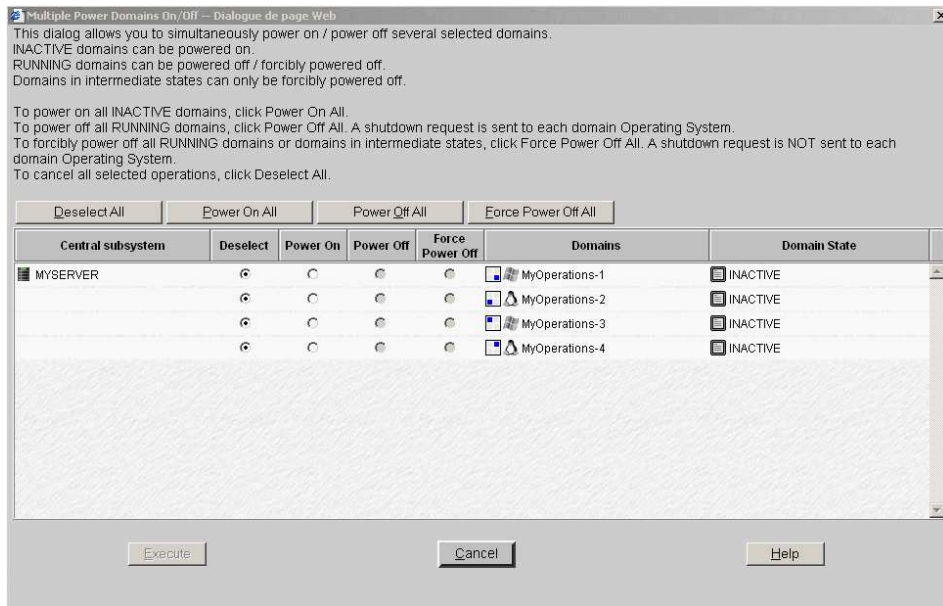

Deselect All	Cancels all selected operations.
Power On All	Powers on all INACTIVE domains.
Power Off All	Powers off all RUNNING domains.
Force Power Off All	Forcibly powers off all RUNNING or HUNG domains.
Deselect	Cancels the selected operation for this domain.
Power On	Powers on this domain if INACTIVE.
Power Off	Powers off this domain if RUNNING.
Force Power Off	Forcibly powers of this domain if RUNNING or HUNG.
Execute	Applies all selected operations.
Cancel	Cancels all selected operations.

Figure 42. Multiple power dialog - quadri-domain example

3. Click **Power On All** → **Execute** or select the required domain **Power On** radio buttons and click **Execute** to simultaneously power on the selected **INACTIVE** domains and associated hardware components.

Domain hardware is powered up from the stand-by mode to the main mode and the Operating System is booted. As the power-on sequence progresses, power-on steps and domain state are displayed in the **Domain Status** panel, as shown in the following table.

Power On States
POWERING ON

POWERED ON - LOADING BIOS
BIOS READY - STARTING EFI
EFI STARTED - BOOTING OS
RUNNING

Table 8. Power-on states

Once the **Power On** sequence has been successfully completed, **RUNNING** is displayed in the **Domain Status** panel and the **Power Off**, **Reset** and **Force Power Off** buttons become accessible.

For a **detailed view of the Power On sequence**, click **Powering View** in the Toolbar. See **Viewing Domain Powering Sequences**, on page 3-32.



Note:

If an error message is displayed in the **Domain Status** panel, the **Power On** sequence has failed. See **What To Do if an Incident Occurs**, on page 3-42.

Powering Off a Domain

What You Can Do

During the domain power-off sequence, you can:

- *View functional status*
- *View power logs*
- *View powering sequences*
- *View BIOS info*
- *View request logs*
- *View domain configuration, resources and status*

Server domains can either be powered off from the Operating System (RECOMMENDED) or from the PAM **Domain Manager**, according to Operating System power settings.

The PAM **Power Off** command is a shutdown request to the Operating System. If the Operating System is configured to accept a PAM power off request, it will save data, close open applications and shut down. Domain hardware will power down to the stand-by mode. The Operating System may also be configured to request Operator confirmation before accepting a PAM power off request. Refer to the applicable documentation delivered with the Operating System for further details.

Notes:

- When more than one domain is loaded in the Control pane, domains can be powered off sequentially or simultaneously. See *Powering Off a Single Domain*, on page 3-18 and *Powering Off Multiple Domains*, on page 3-19.
- Server domains may be powered up even if the server presents a minor fault. See *System Functional Status*, on page 4-4. However, you are advised to contact your Customer Service Engineer so that the fault can be repaired.

Powering Off a Single Domain

To power off a single domain from the PAM **Domain Manager**:

1. Click **Domain Manager** to open the Control pane.
2. Select the required domain. If the domain is in the powered-on mode, **RUNNING** is displayed in the **Domain Status** panel and the **Power OFF** button is accessible.
3. Click **Power Off** to power down the domain and associated hardware components. The **Power Off Confirmation** dialog opens.
4. Select the **View Power-Off Logs** checkbox if you want power-off logs to be automatically displayed during the power-off sequence and click **Yes** to confirm.

The Operating System saves data, closes open applications and shuts down. Domain hardware is powered down from the main mode to the stand-by mode. As the power-off sequence progresses, power-off steps and domain state are displayed in the **Domain Status** panel, as shown in the following table.

Power Off States
POWERING DOWN
INACTIVE

Table 9. Power-off states

Once the **Power Off** sequence has been successfully completed, **INACTIVE** is displayed in the **Domain Status** panel and the **Power On** button becomes accessible.

For a detailed view of the **Power Off** sequence, click **Powering View** in the Toolbar. See *Viewing Domain Powering Sequences*, on page 3-32.

- Repeat Steps 2 to 4 for each domain to be powered down.

Note:

If an error message is displayed in the **Domain Status** panel, the **Power Off** sequence has failed. See *What To Do if an Incident Occurs*, on page 3-42.

Powering Off Multiple Domains

To power off more than one domain from the PAM **Domain Manager**:

- Click **Domain Manager** to open the Control pane.
- Click **Multiple Power**. The **Multiple Power Domains On/Off** dialog opens.

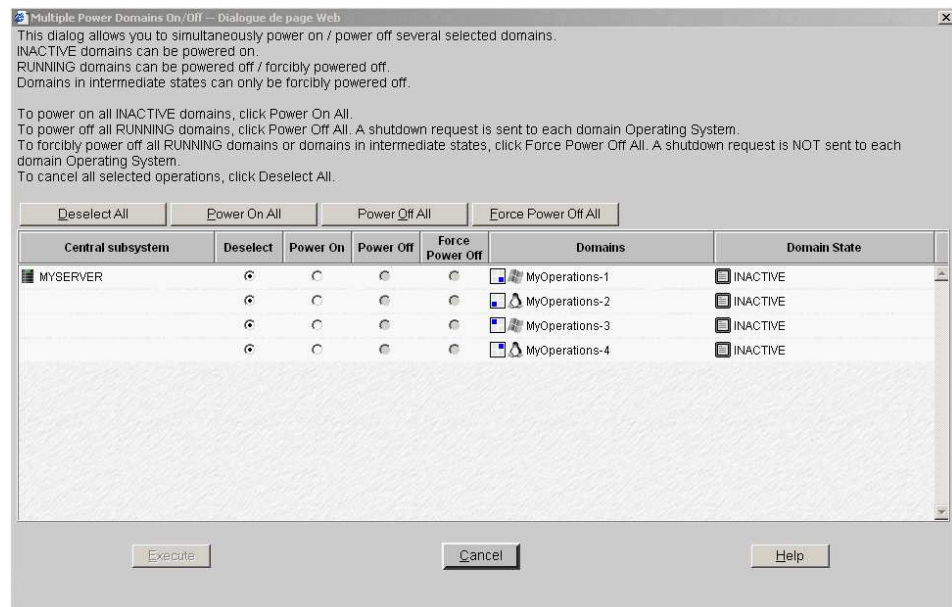

Deselect All	Cancels all selected operations.
Power On All	Powers on all INACTIVE domains.
Power Off All	Powers off all RUNNING domains.
Force Power Off All	Forcibly powers off all RUNNING or HUNG domains.
Deselect	Cancels the selected operation for this domain.
Power On	Powers on this domain if INACTIVE.
Power Off	Powers off this domain if RUNNING.
Force Power Off	Forcibly powers of this domain if RUNNING or HUNG.
Execute	Applies all selected operations.
Cancel	Cancels all selected operations.

Figure 43. Multiple power dialog - quadri-domain example

- Click **Power Off All** → **Execute** or select the required domain **Power Off** radio buttons and click **Execute** to simultaneously power off the selected **RUNNING** domains and associated hardware components.

The Operating System saves data, closes open applications and shuts down. Domain hardware is powered down from the main mode to the stand-by mode. As the power-off sequence progresses, power-off steps and domain state are displayed in the **Domain Status** panel, as shown in the following table.

Power Off States
POWERING DOWN
INACTIVE

Table 10. Power-off states

Once the **Power Off** sequence has been successfully completed, **INACTIVE** is displayed in the **Domain Status** panel and the **Power On** button becomes accessible.

For a detailed view of the **Power Off** sequence, click **Powering View** in the Toolbar. See *Viewing Domain Powering Sequences*, on page 3-32.



Note:

If an error message is displayed in the **Domain Status** panel, the **Power Off** sequence has failed. See *What To Do if an Incident Occurs*, on page 3-42.

Forcing a Domain Power Off

What You Can Do

During the domain force power-off sequence, you can:

- *View functional status*
- *View power logs*
- *View powering sequences*
- *View BIOS info*
- *View request logs*
- *View domain configuration, resources and status*

The **Force Power Off** command powers down domain hardware to the standby mode independently of the Operating System. This command should only be used if the Operating System is not running or is not configured / not able to respond to a standard power off command.



Note:

A standard power off command is a shutdown request to the Operating System. Refer to the applicable documentation delivered with the Operating System for further details.

In the event of a critical fault, PAM software automatically forces a domain power off.



Notes:

- When more than one domain is loaded in the Control pane, domains can be forcibly powered off sequentially or simultaneously. See *Forcibly Powering Off a Single Domain*, on page 3-22 and *Forcibly Powering off Multiple Domains*, on page 3-22.
- Server domains may be powered up even if the server presents a minor fault. See *System Functional Status*, on page 4-4. However, you are advised to contact your Customer Service Engineer so that the fault can be repaired.



Warning:

The Force Power Off command may result in domain data loss and file corruption. NEVER use the Force Power Off command if a RECOVERING BIOS error message is displayed. (The BIOS recovery program automatically re-flashes the BIOS when certain problems occur during initialization).

Forcibly Powering Off a Single Domain

To forcibly power off a single domain from the PAM **Domain Manager**:

1. Click **Domain Manager** to open the Control pane.
2. Select the required domain. If **INACTIVE** is NOT displayed in the **Domain Status** panel, the **Force Power Off** button is accessible.
3. Click **Force Power Off** to override the Operating System and forcibly power down the domain and associated hardware components without closing running applications and saving data. The **Force Power Off Confirmation** dialog opens.
4. Select the **View Power-Off Logs** checkbox if you want power-off logs to be automatically displayed during the power-off sequence and click **Yes** to confirm.

Domain hardware is powered down from the main mode to the stand-by mode. As the force power-off sequence progresses, power-off steps and domain state are displayed in the **Domain Status** panel, as shown in the following table.

Force Power Off States
POWERING DOWN
INACTIVE

Table 11. Force power-off states

Once the **Force Power Off** sequence has been successfully completed, **INACTIVE** is displayed in the **Domain Status** panel and the **Power On** button becomes accessible.

For a detailed view of the **Force Power Off** sequence, click **Powering View** in the Toolbar. See *Viewing Domain Powering Sequences*, on page 3-32.

5. Repeat Steps 2 to 4 for each domain to be forcibly powered down.



Note:

If an error message is displayed in the **Domain Status** panel, the **Power Off** sequence has failed. See *What To Do if an Incident Occurs*, on page 3-42.

Forcibly Powering Off Multiple Domains

To forcibly power off more than one domain from the PAM **Domain Manager**:

1. Click **Domain Manager** to open the Control pane.
2. Click **Multiple Power**. The **Multiple Power Domains On/Off** dialog opens.

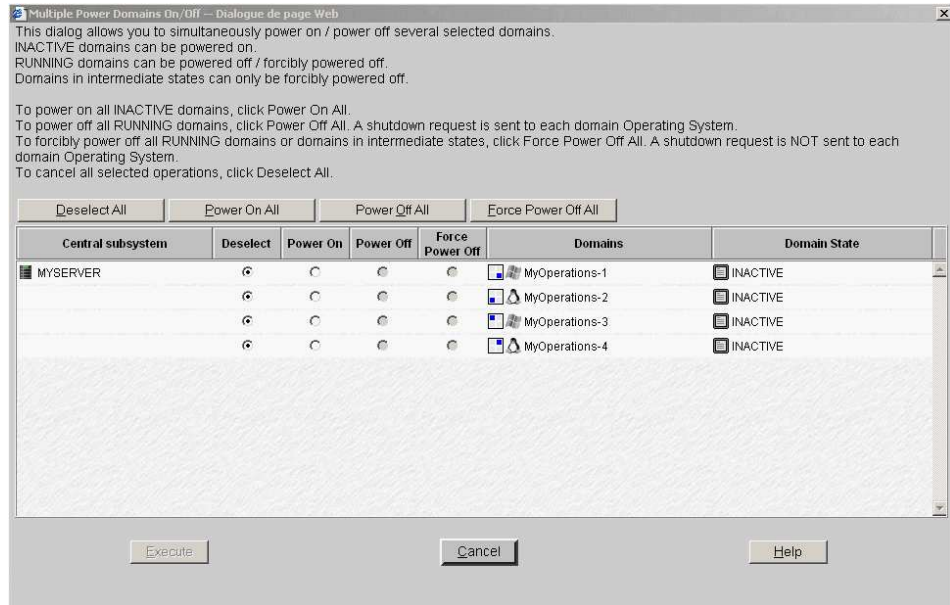

Deselect All	Cancels all selected operations.
Power On All	Powers on all INACTIVE domains.
Power Off All	Powers off all RUNNING domains.
Force Power Off All	Forcibly powers off all RUNNING or HUNG domains.
Deselect	Cancels the selected operation for this domain.
Power On	Powers on this domain if INACTIVE.
Power Off	Powers off this domain if RUNNING.
Force Power Off	Forcibly powers of this domain if RUNNING or HUNG.
Execute	Applies all selected operations.
Cancel	Cancels all selected operations.

Figure 44. Multiple power dialog - quadri-domain example

- Click **Force Power Off All** → **Execute** or select the required domain **Force Power Off** radio buttons and click **Execute** to to override the Operating System and forcibly power down the selected domains and associated hardware components without closing running applications and saving data.

Power Off States
POWERING DOWN
INACTIVE

Table 12. Power-off states

Once the **Power Off** sequence has been successfully completed, **INACTIVE** is displayed in the **Domain Status** panel and the **Power On** button becomes accessible.

For a detailed view of the **Power Off** sequence, click **Powering View** in the Toolbar. See *Viewing Domain Powering Sequences*, on page 3-32.

Note:

If an error message is displayed in the **Domain Status** panel, the **Power Off** sequence has failed. See *What To Do if an Incident Occurs*, on page 3-42.

Performing a Domain Memory Dump

The **Dump** command is used when the Operating System hangs and allows technicians to diagnose software problems by saving domain memory.



Warning:

The **Dump** command should only be used if the Operating System is not able to respond to a standard **Power OFF** command. The **Dump** command may result in domain data loss and file corruption.

The **Dump** command does not power down domain hardware (automatic warm reboot).

The Operating System must be configured to accept a dump command. Refer to the applicable documentation delivered with the Operating System for further details.

To perform a domain memory dump:

1. Click **Domain Manager** to open the Control pane.
2. Select the required domain. If **RUNNING** is displayed in the **Domain Status** panel, the **Dump** button is accessible.
3. Click **Dump** to override the Operating System and dump domain core memory which will be copied to the server hard disk for analysis. The **Dump Confirmation** dialog opens.
4. Click **Yes** to confirm the **Dump** command.

The **Dump** sequence results in a warm reboot of the domain BIOS, EFI and Operating System (without closing running applications and saving data).

As the dump sequence progresses, dump steps and domain state are displayed in the **Domain Status** panel, as shown in the following table.

Dump States
POWERED ON - LOADING BIOS
BIOS READY - STARTING EFI
EFI STARTED - BOOTING OS
RUNNING

Table 13. Dump states

Once the **Dump** sequence has been successfully completed, **RUNNING** is displayed in the **Domain Status** panel and the **Power Off**, **Reset** and **Force Power Off** buttons become accessible.

5. Repeat Steps 2 to 4 for each domain on which you want to perform a memory dump.



Note:

If an error message is displayed in the **Domain Status** panel, the **Dump** sequence has failed. See *What To Do if an Incident Occurs*, on page 3-42.

Manually Resetting a Domain

What You Can Do

During the domain reset sequence, you can:

- View functional status
- View power logs
- View powering sequences
- View BIOS info
- View request logs
- View domain configuration, resources and status

The **Reset** command is used to restart the current Operating System without powering off/on the domain.



Warning:

The **Reset** command should only be used if the Operating System is not running or is not able to respond to a standard **Power Off** command. The **Reset** command may result in domain data loss and file corruption. The **Reset** command does not power down domain hardware (warm reboot).

To manually reset a domain:

1. Click **Domain Manager** to open the Control pane.
2. Select the required domain. If **INACTIVE** is NOT displayed in the **Domain Status** panel, the **Reset** button is accessible.
3. Click **Reset** to override the Operating System and forcibly perform a warm reboot of the domain BIOS, EFI and Operating System without closing running applications and saving data. The **Reset Confirmation** dialog opens.
4. Click **Yes** to confirm the **Reset** command.

As the reset sequence progresses, reset steps and domain state are displayed in the **Domain Status** panel, as shown in the following table.

Reset States
POWERED ON - LOADING BIOS
BIOS READY - STARTING EFI
EFI STARTED - BOOTING OS
RUNNING

Table 14. Reset states

Once the **Reset** sequence has been successfully completed, **RUNNING** is displayed in the **Domain Status** panel and the **Power Off**, **Reset** and **Force Power Off** buttons become accessible.

For a detailed view of the **Reset** sequence, click **Powering View** in the Toolbar. See *Viewing Domain Powering Sequences*, on page 3-32.

5. Repeat Steps 2 to 4 for each domain to be reset.



Note:

If an error message is displayed in the **Domain Status** panel, the **Power On** sequence has failed. See *What To Do if an Incident Occurs*, on page 3-42.

Deleting a Domain

Notes:

- Reserved for Customer Administrators.
- The domain must be **INACTIVE** to be deleted.

Once loaded in the **Domain Manager** Control pane, a domain can be deleted from the current configuration. When the domain has been deleted, the corresponding resources can be re-allocated to another domain.

To delete a domain from the current configuration:

1. Click **Domain Manager** to open the Control pane.
2. Select the required domain.
3. Click **Delete** in the Command bar. The **Confirm Remove Domain** dialog opens.

Figure 45. Delete domain dialog - mono-module server

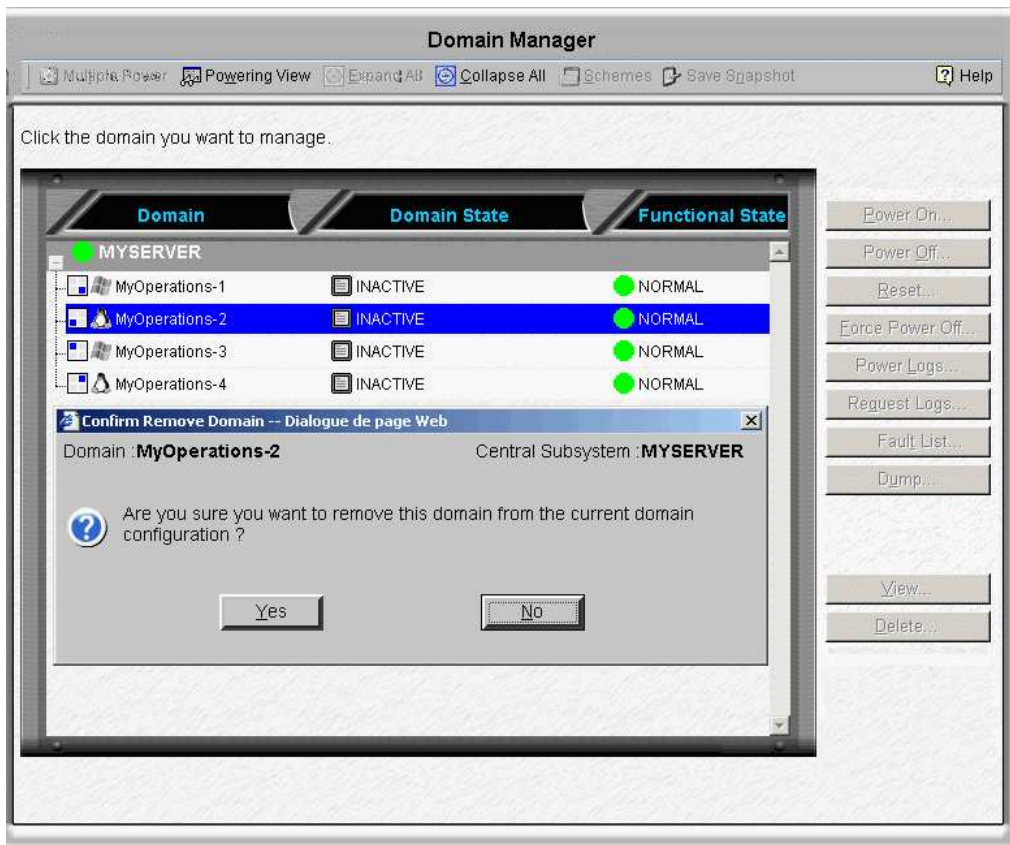

Figure 46. Delete Domain dialog - Example with 4 domains

4. Click **Yes** to confirm deletion of the selected domain from the current configuration.

An information box opens, informing you that the domain has been successfully deleted. The domain is no longer visible in the Control pane.

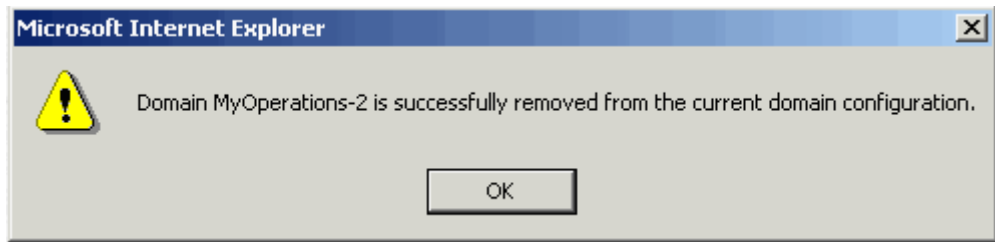

Figure 47. Domain deleted information box

5. Click **OK** to continue.

 **Note:**

Domain modifications are not automatically saved and are only applicable while the selected domain is loaded in the **Domain Manager** Control pane. If required, you can manually save the new configuration for future use. See *Saving the Current Domain Configuration Snapshot*, on page 3-11.

Viewing a Domain Fault List

The **Domain Fault List** page allows you to view messages about the faults encountered since the beginning of the last power-on sequence on the selected domain. The fault list is automatically cleared when a new domain power-on sequence is started.



Note:

For details about PAM messages, see *Viewing and Managing PAM Messages, History Files and Archives*, on page 4-31.

To view the domain fault list:

1. Click **Domain Manager** to open the Control pane.
2. Select the required domain and click **Fault List** in the Command bar to open the **Fault List** dialog.

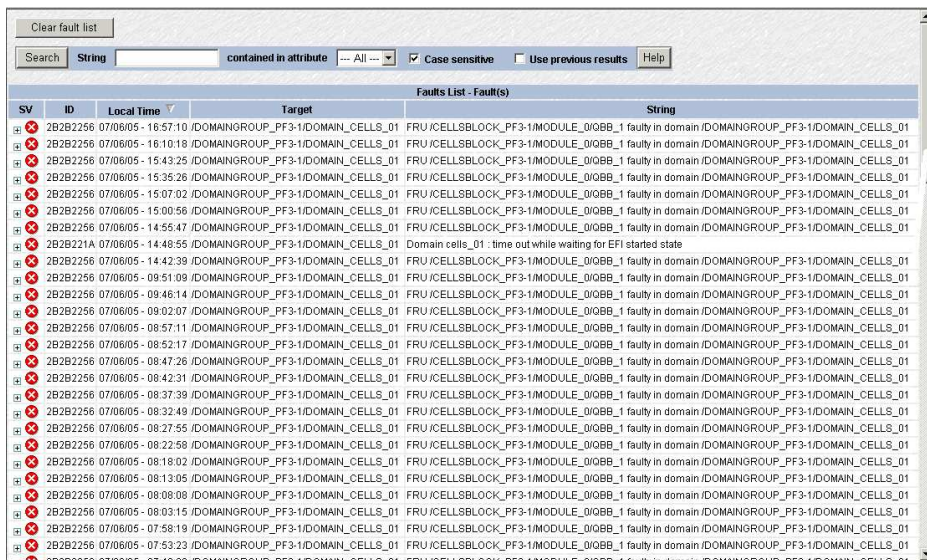

Button	Use
Clear fault list	To manually clear the fault list.
Help	To access context sensitive help.
Search - String - Contained in attribute - Case sensitive - Use previous results	To search for specific messages, according to: - Alphanumeric identifier (ID), e.g. 2B2B2214 above. - Message Source, Target, String, Data attributes. - Upper case / lower case letters. - Multiple search option used to search again from the results obtained from the previous search(es).
+	To view the message and access context sensitive help.
Help on message	To view the related help message.
Column Header	Use
SV	To sort messages according to severity level.
ID	To sort messages according to Message IDentifier.
Local Time	To sort messages according to message local time and date.
Target	To sort messages according to the component referred to in the message.
String	To sort messages according to message text string.

Figure 48. Domain fault list dialog - example

Viewing Domain Functional Status

The **Domain Functional Status** indicator in the **Domain Manager** Control pane shows the **functional status of the last action** performed on each domain, e.g. if the last **Power ON/OFF** sequence was successful, the indicator is green, and also reflects **the status of domain hardware components**.

As Customer Administrator, you can toggle the **PAM Tree** to display the synthetic functional status (round, colored indicator next to the **Domain Manager** node) of all the domains loaded in the **Domain Manager** Control pane. For example:

- If the last **Power ON/OFF** sequence was successful on all domains and the status of all domain hardware components is normal, the indicator is green
- If the last **Power ON/OFF** sequence failed on at least one domain and/or the status of at least one domain hardware component is fatal, the indicator is red.





Indicator	Status	Explanation
 Green	NORMAL	<p>Control Pane The last command on this domain was successful. or The domain fault list has been cleared.</p> <p>Note: Domain functional status is reset to NORMAL when a new domain power-on sequence is started.</p> <p>PAM Tree The last command on all domains was successful. or All domain fault lists have been cleared.</p>
 Yellow	WARNING	<p>Control Pane An automatic Recovery command has been launched on this domain. or A WARNING status for a domain hardware component has been detected by the BIOS and a warning error has been added to the domain fault list. or The domain fault list was not empty when PAM was started.</p> <p>PAM Tree An automatic Recovery command has been launched on at least one domain. or A WARNING status for at least one domain hardware component has been detected by the BIOS and a warning error has been added to the domain fault list. or At least one domain fault list was not empty when PAM was started.</p> <p>Note: The BIOS recovery program automatically re-flashes the BIOS when certain problems occur during initialization</p>
 Orange	CRITICAL	<p>Control Pane The last command on this domain was not successful and a critical error has been added to the domain fault list.</p> <p>PAM Tree The last command on at least one domain was not successful.</p>
 Red	FATAL	<p>Control Pane The last command on this domain has failed and a fatal error has been added to the domain fault list.</p> <p>PAM Tree The last command on at least one domain has failed.</p>

Table 15. Domain functional status indicators

Viewing Domain Power Logs

Power logs are recorded during domain power ON/OFF sequences. This information is particularly useful for troubleshooting. See *What To Do if an Incident Occurs*, on page 3-42.

During a Power ON/OFF Sequence

1. Click **Domain Manager** to open the Control pane.
2. Select the required domain and launch the domain power ON/OFF sequence, as required.
3. Select the **View Power Logs** checkbox in the **Power Confirmation** dialog to automatically display power logs during the powering sequence.

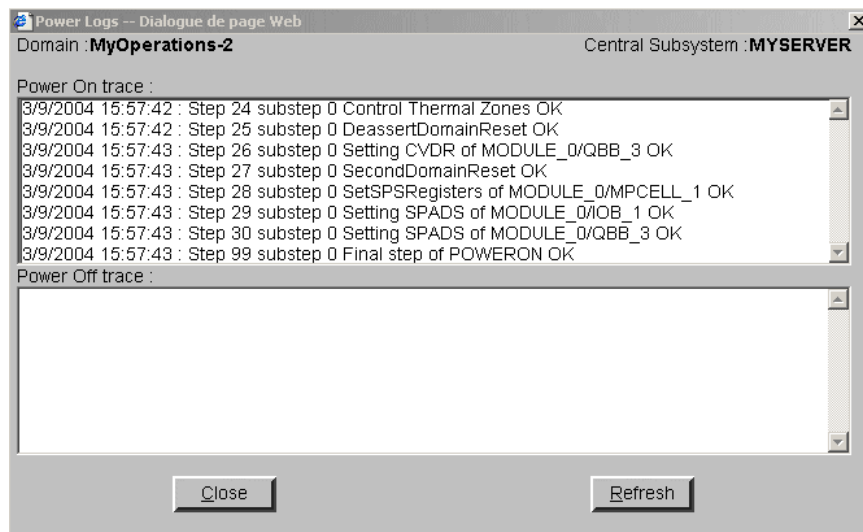

Figure 49. Power logs dialog

Outside a Power ON/OFF Sequence

Click **Powering View** → **Power Logs** in the Domain Manager Toolbar.

Note:

Existing power logs are erased when a new power ON sequence is launched.

Viewing Domain Powering Sequences

A detailed view of powering sequences can be displayed by clicking **Powering View** in the Domain Manager Toolbar after a power request.

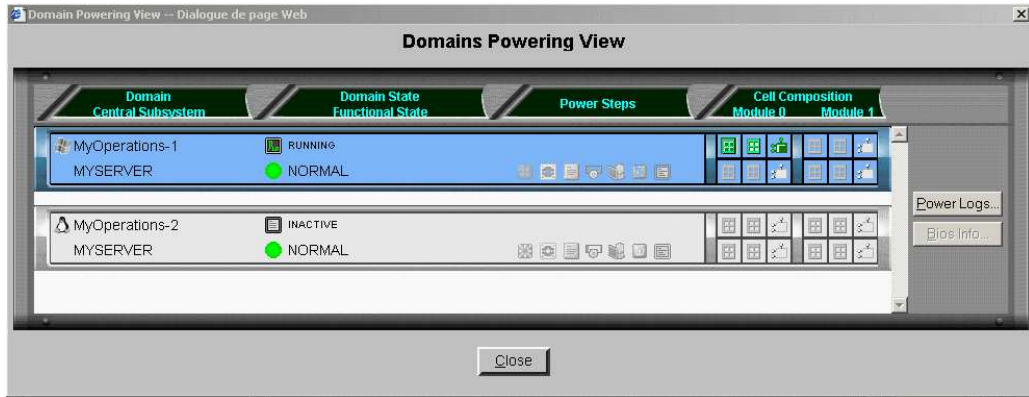

Status Panel Item	Explanation
Domain	Selected domain identity.
Central Subsystem	Name of the Central Subsystem containing the domain.
Domain State	Current power sequence step.
Functional Status	Functional status of the last action performed on the domain. See <i>Viewing Domain Functional Status</i> , on page 3-29.
Power Steps	Dynamic, graphic representation of power sequence steps.
Cell Composition	Graphic representation of the core hardware elements in each cell (hardware partition): QBB(s), IOC(s) - Master / Slave. See <i>Configuring Domains</i> , on page 5-28.

Figure 50. Powering view dialog



Note:

An Infotip can be obtained by hovering the mouse over the required element.

Viewing Domain BIOS Info

BIOS information is particularly useful for troubleshooting. See *What To Do if an Incident Occurs*, on page 3-42.

To view BIOS information:

1. Click **Domain Manager** to open the Control pane.
2. Select the required domain.
3. Click **Powering View** → **BIOS Info** in the Toolbar.

The **BIOS Info** dialog opens, displaying the following information:

- BIOS version used by the domain,
 - BIOS boot post codes. See *BIOS POST Codes*.
4. Click **Refresh** to update BIOS information.

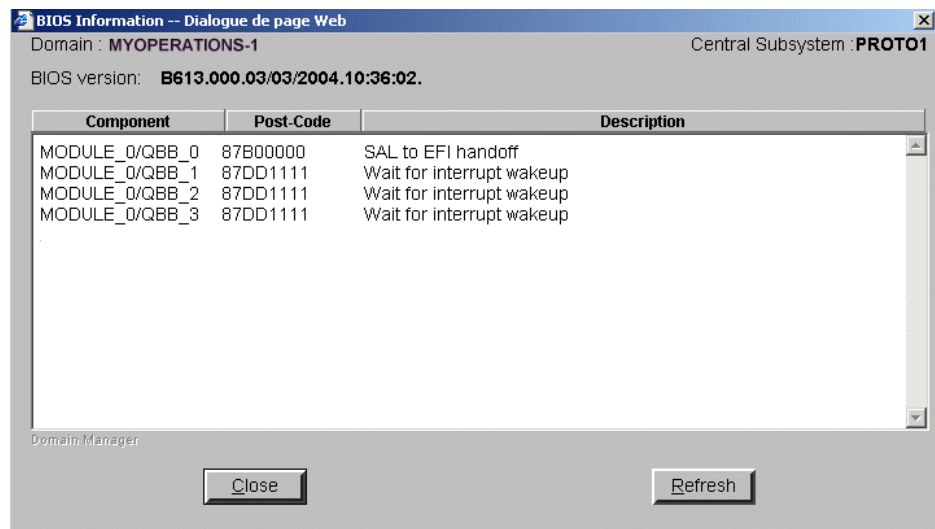

Figure 51. BIOS Info dialog

Viewing Domain Request Logs

The **Request Logs** dialog gives direct access to a trace of major domain operations (requests) and indicates their initiators (requestors).

To view Request logs:

1. Click **Domain Manager** to open the Control pane.
2. Select the required domain.
3. Click **Request Logs** in the Command bar.

The **Request Logs** dialog displays the following information:

- **Power On** requests and requestors,
- **Power Off** requests and requestors,
- **Reset** requests and requestors.

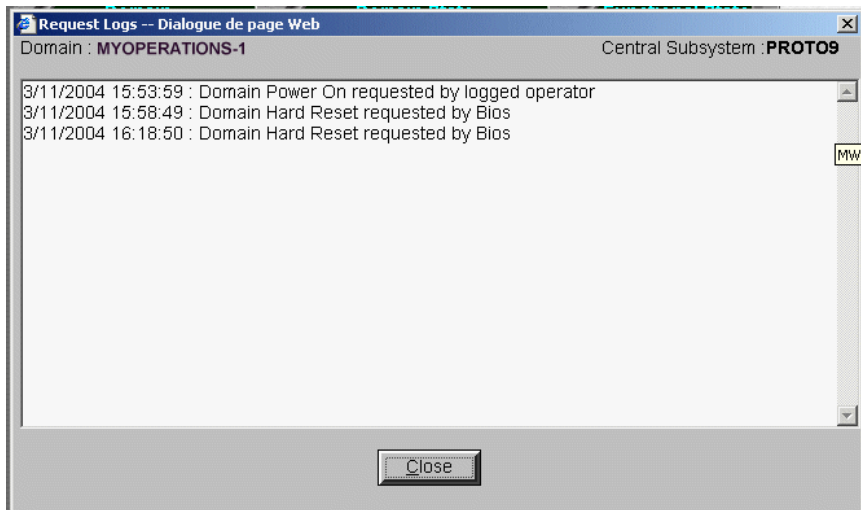

Figure 52. Request Logs dialog



Note:

Existing request logs are erased when a new power ON sequence is launched.

Viewing Domain Configuration, Resources and Status

Note:

Certain features described below are only available if you are connected to a Storage Area Network (SAN).

Please contact your Bull Sales Representative for sales information.

Information about the resources allocated to each domain is permanently accessible from the **Domain Manager** Control pane:

- Graphic representation of domain configuration.
- Non-graphic summary of the hardware resources allocated to a domain.
- Graphic summary of the hardware resources allocated to a domain and their status.

Viewing Domain Configuration

1. Click **Domain Manager** to open the Control pane.
2. Select the required domain.
3. Click **View** in the Command bar to open the **View Domain** dialog.

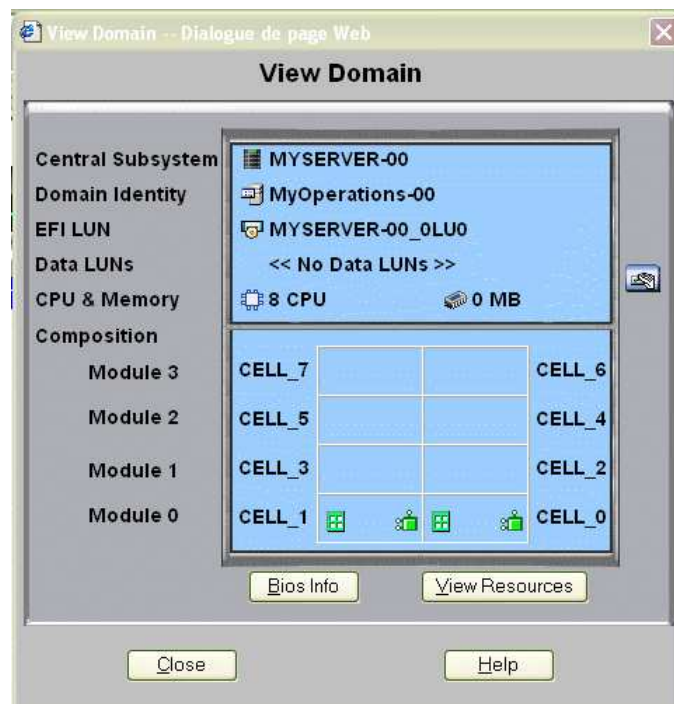

Figure 53. View Domain dialog - example

View Domain Dialog Items

Domain Item	Explanation
Central Subsystem	Name of the Central Subsystem containing the domain.
Domain Identity	Logical name and profile given to the domain.
EFI LUN	<p>Boot LUN device location:</p> <p>NovaScale 5xx5 SMP Server OLU0 located in Module0_DIB0 or connected to Module0_IOC0 NovaScale 5085 Partitioned Server OLU0 located in Module0_DIB0 or connected to Module0_IOC0 OLU1 located in Module0_DIB1 or connected to Module0_IOC1 NovaScale 5165 Partitioned Server OLU0 located in Module0_DIB0 or connected to Module0_IOC0 OLU1 located in Module0_DIB1 or connected to Module0_IOC1 OLU2 located in Module1_DIB0 or connected to Module1_IOC0 OLU3 located in Module1_DIB1 or connected to Module1_IOC1 NovaScale 5245 Partitioned Server OLU0 located in Module0_DIB0 or connected to Module0_IOC0 OLU1 located in Module0_DIB1 or connected to Module0_IOC1 OLU2 located in Module1_DIB0 or connected to Module1_IOC0 OLU3 located in Module1_DIB1 or connected to Module1_IOC1 OLU4 located in Module0_DIB0 / connected to Module2_IOC0 OLU5 located in Module0_DIB1 or connected to Module2_IOC1 NovaScale 5325 Partitioned Server OLU0 located in Module0_DIB0 or connected to Module0_IOC0 OLU1 located in Module0_DIB1 or connected to Module0_IOC1 OLU2 located in Module1_DIB0 or connected to Module1_IOC0 OLU3 located in Module1_DIB1 or connected to Module1_IOC1 OLU4 located in Module0_DIB0 / connected to Module2_IOC0 OLU5 located in Module0_DIB1 or connected to Module2_IOC1 OLU6 located in Module1_DIB0 or connected to Module3_IOC0 OLU7 located in Module1_DIB1 or connected to Module3_IOC1</p>
Data LUNs	The Data LUNs allocated to this domain. Reserved for systems connected to a SAN.
CPU	Number of processors used by the domain.
Memory	Size of memory used by the domain.
Composition	Graphic representation of the main hardware elements used by the domain. See Note below.
Module	<p>Module housing the cell(s) used by the domain.</p> <p>Module0 = Cell_0 and Cell_1 Module1 = Cell_2 and Cell_3 Module2 = Cell_4 and Cell_5 Module3 = Cell_6 and Cell_7</p>

Figure 54. View Domain dialog 1/2

Domain Item	Explanation
Cell	<p>Cell(s) or hardware partition(s) used by the domain.</p> <p>NovaScale 5085 SMP Server Cell_0 = Mod0_QBBO, Mod0_IOC0, DIB0 Cell_1 = Mod0_QBB1</p> <p>NovaScale 5165 SMP Server Cell_0 = Mod0_QBBO, Mod0_IOC0, DIB0 Cell_1 = Mod0_QBB1 Cell_2 = Mod1_QBBO Cell_3 = Mod1_QBB1</p> <p>NovaScale 5245 SMP Server Cell_0 = Mod0_QBBO, Mod0_IOC0, DIB0 Cell_1 = Mod0_QBB1 Cell_2 = Mod1_QBBO Cell_3 = Mod1_QBB1 Cell_4 = Mod2_QBBO Cell_5 = Mod2_QBB1</p> <p>NovaScale 5325 SMP Server Cell_0 = Mod0_QBBO, Mod0_IOC0, DIB0 Cell_1 = Mod0_QBB1 Cell_2 = Mod1_QBBO Cell_3 = Mod1_QBB1 Cell_4 = Mod2_QBBO Cell_5 = Mod2_QBB1 Cell_6 = Mod3_QBBO Cell_7 = Mod3_QBB1</p> <p>NovaScale 5085 Partitioned Server Cell_0 = Mod0_QBBO, Mod0_IOC0, DIB0 Cell_1 = Mod0_QBB1, Mod0_IOC1, DIB1</p> <p>NovaScale 5165 Partitioned Server Cell_0 = Mod0_QBBO, Mod0_IOC0, DIB0 Cell_1 = Mod0_QBB1, Mod0_IOC1, DIB1 Cell_2 = Mod1_QBBO, Mod1_IOC0, DIB0 Cell_3 = Mod1_QBB1, Mod1_IOC1, DIB1</p> <p>NovaScale 5245 Partitioned Server Cell_0 = Mod0_QBBO, Mod0_IOC0, DIB0 Cell_1 = Mod0_QBB1, Mod0_IOC1, DIB1 Cell_2 = Mod1_QBBO, Mod1_IOC0, DIB0 Cell_3 = Mod1_QBB1, Mod1_IOC1, DIB1 Cell_4 = Mod2_QBBO, Mod2_IOC0, DIB0 Cell_5 = Mod2_QBB1, Mod2_IOC1, DIB1</p> <p>NovaScale 5325 Partitioned Server Cell_0 = Mod0_QBBO, Mod0_IOC0, DIB0 Cell_1 = Mod0_QBB1, Mod0_IOC1, DIB1 Cell_2 = Mod1_QBBO, Mod1_IOC0, DIB0 Cell_3 = Mod1_QBB1, Mod1_IOC1, DIB1 Cell_4 = Mod2_QBBO, Mod2_IOC0, DIB0 Cell_5 = Mod2_QBB1, Mod2_IOC1, DIB1 Cell_6 = Mod3_QBBO, Mod3_IOC0, DIB0 Cell_7 = Mod3_QBB1, Mod3_IOC1, DIB1</p> <p>See <i>Configuring Domains</i>, on page 5-28.</p>

Figure 55. View Domain dialog 2/2



Note:

When the domain is **RUNNING**, an Infotip identifying the Master QBB / IOC can be obtained by hovering the mouse over the QBB / IOC icons.

Master IOC = IOC to which the domain boot LUN device is connected (where applicable).

Master QBB = QBB required to start the domain.

Viewing Domain Hardware Resources

1. Click **Domain Manager** to open the Control pane.
2. Select the required domain and click **View Resources** in the **View Domain** dialog to open the **Domain Hardware Resources** dialog.

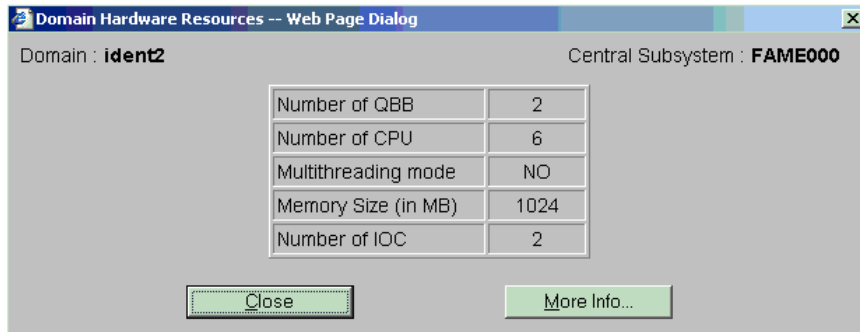

Figure 56. Domain Hardware Resources dialog

For the selected domain, this dialog indicates:

- the number of QBBs, CPUs and IOCs allocated to the domain,
- the size of the Memory allocated to the domain,
- whether the processors used by this domain are in multithreading mode or monothreading mode :
YES for **multithreading** mode,
NO for **monothreading** mode.

Notes:Multithreading mode :

- If the domain is **halted**, YES / NO indicates whether the domain is configured for multithreading or monothreading.
- If the domain is **running**, YES / NO indicates whether the domain was launched in multithreading or monothreading mode.

Viewing Domain Details and Status

1. Click **Domain Manager** to open the Control pane.
2. Click **View** → **View Resources** → **More Info...** in the Command bar to open the **Domain Hardware Details** dialog.

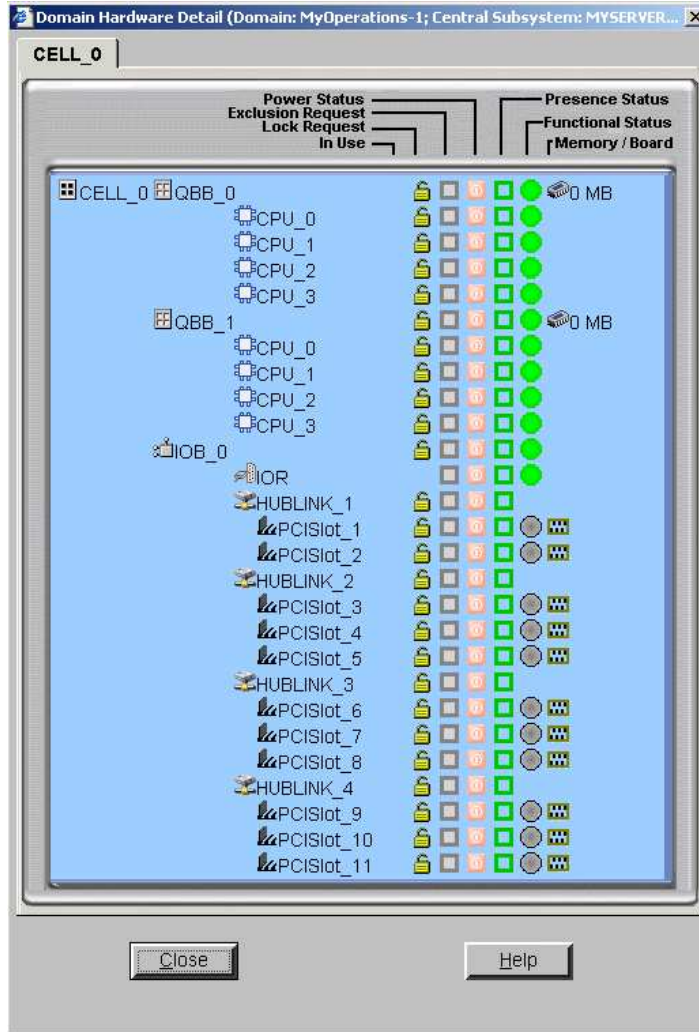

Figure 57. Domain Hardware Details dialog
Domain Hardware Details icons are explained in the following table.























Item	Icon	Meaning
Power Status	 Green	Main power is ON.
	 Red	Main power is OFF. Stand-by power is ON.
	 Pink	Main power is OFF. Stand-by power is OFF.
	 Blinking pink	Stand-by power is Faulty.
	 Blinking red	Main power is Faulty. Stand-by power may be ON, OFF or Faulty.
	 Gray	Main power status is Unknown.
Exclusion Request	 Gray	To be logically included at the next domain power ON.
	 Yellow/red	To be logically excluded at the next domain power ON.
Lock Request	 Green	To be functionally included in the domain (unlocked).
	 Red	To be functionally excluded from the domain (locked).
Used	 Green	Used by the domain.
	 Gray	Not used by the domain.
Presence Status	 Green	Physically present and accessible.
	 Red	Was present in a previous configuration but has disappeared.
	 Purple	Cannot be computed (detection circuit error).
Functional Status	 Green	No problem detected, operating correctly.
	 Yellow	Minor problem reported, still operational.
	 Orange	Serious problem reported, no longer capable of operating correctly. PAM may generate an OS shutdown request.
	 Red	Major problem reported. PAM may automatically shut down the OS. System integrity is jeopardized.
	 Purple	Cannot be computed (detection circuit error).
Memory		Memory available per QBB.
Board		PCI slot occupied.
		PCI slot empty.

Table 16. Domain hardware details icons



Note:

When the domain is **INACTIVE**, the **Domain Hardware Details** dialog indicates the resources that PAM will try to initialize for the domain during the next **Power ON** sequence. When the domain is **RUNNING**, the **Domain Hardware Details** dialog indicates the resources that PAM successfully initialized for the domain during the last **Power ON** or **Reset** sequence.

For more information about domain hardware, see:

- Presence Status Indicators, on page 4-6
- Functional Status Indicators, on page 4-8
- Viewing Server Hardware Status, on page 4-14
- Configuring Domains, on page 3-29
- Excluding/Including Hardware Elements, on page 4-23
- Limiting Access to Hardware Resources, on page 5-66

What To Do if an Incident Occurs

When an incident occurs during a domain **Power ON / Power OFF / Force Power OFF / Reset** sequence, a message is displayed in the **Domain Status** panel and a trace is recorded in the **Domain POWER Logs**. Table 17 indicates the messages that may be displayed during an incorrect power sequence.

SEQUENCE	ERROR / INFORMATION MESSAGE
POWERING ON	POWERING ON FAILED
	TIMEOUT DURING POWER ON
	POWERING ON SUSPENDED
	DOMAIN HALTED
POWERED ON - LOADING BIOS	RECOVERING BIOS
	BIOS LOADING TIMEOUT
BIOS READY - STARTING EFI	TIMEOUT DURING START EFI
POWERING DOWN	POWER DOWN FAILED
	TIMEOUT DURING POWER DOWN

Table 17. Domain power sequence error messages

PAM software also informs connected and non-connected users via:

- the PAM Web interface (**Status Pane** and/or **User History** files),
- e-mail (users with an appropriate Event Message subscription),
- an autocall to the Bull Service Center (according to your maintenance contract) for analysis and implementation of the necessary corrective or preventive maintenance measures, where applicable.

As Customer Administrator, you have access to the **System History** files and associated **Help Files**. As Customer Operator, you have access to the **User History** and/or **Web Event Messages**, and associated **Help Files**, pre-configured by your Customer Administrator.

You will find all the advice you need in the **Help Files** associated with the **System / User History** and **Web Event Messages** you are authorized to view.

Whether you open a **Web Event Message** or a **System / User History** file, the resulting display and utilities are the same. See *Viewing and Managing PAM Event Messages and History Files*, on page 4-31.



Note:

All incidents are systematically logged in the **System History** files, which you can view as Customer Administrator at any time.

Dealing with Incidents

When you open the incident **Help File**, you may be requested to contact your Customer Service Engineer or perform straightforward checks and actions:

Checking POST Codes

If you are requested to check POST Codes, see *Viewing Domain BIOS Info*, on page 3-33.

Checking Hardware Exclusion Status

If you are requested to check hardware exclusion status, see *Excluding / Including Hardware Elements*, on page 4-23.

Checking Hardware Connections

If you are requested to check hardware connections, manually and visually ensure that all cables are correctly inserted in their corresponding hardware ports. See *Cabling Guide*, 86 A1 34ER.

Rebooting Maestro / Resetting the PMB

If you are requested to reboot Maestro or to reset the PMB, see *Checking, Testing, and Resetting the PMB*, on page 4-49.

Rebooting the PAP Application

If you are requested to reboot the PAP application:

1. From the Microsoft Windows home page, click **Start** → **Programs** → **Administrative Tools** → **Component Services**.
2. From **Component Services**, click **Console Root** → **Component Services** → **Computers** → **My Computer** → **COM+ Applications** → **PAP**.
3. Right click **PAP** to open the shortcut menu. Click **Shutdown**.
4. Activate the required PAM version to reboot the PAP application. See *Deploying a PAM Release*, on page 5-23 and *Activating a PAM Version*, on page 5-24.

Powering OFF/ON the Domain

If you are requested to Power OFF/ON or Force Power OFF a domain, ensure that you have saved data and closed open applications. See *Powering ON a Domain*, on page 3-14, *Powering OFF a Domain*, on page 3-18, and *Forcing a Domain Power OFF*, on page 3-21.

Resetting a Domain

If you are requested to Reset a domain, see *Manually Resetting a Domain*, on page 3-25.

Performing a Domain Memory Dump

If you are requested to perform a domain memory Dump, see *Performing a Domain Memory Dump*, on page 3-24.

Turning the Site Breaker Off

The server is not equipped with a physical power button and can only be completely powered down by turning the site breaker off.

Chapter 4. Monitoring the Server

This chapter explains how, as Customer Administrator, you can supervise server operation and how as Customer Administrator and/or Operator you can view and manage PAM Messages, Histories, Archives and Fault Lists. It includes the following topics:

- Introducing PAM Monitoring Tools, on page 4-2
- Using the Hardware Search Engine, on page 4-10
- Viewing PAM Web Site User Information, on page 4-12
- Viewing PAM Version Information, on page 4-13
- Viewing Server Hardware Status, on page 4-14
- Displaying Detailed Hardware Information, on page 4-15
- Excluding / Including Hardware Elements, on page 4-23
- Excluding / Including Clocks, SPS, XSP Links and Sidebands, on page 4-27
- Managing PAM Messages, Histories, Archives and Fault Lists, on page 4-31
- Viewing, Archiving and Deleting History Files, on page 4-36
- What to Do if an Incident Occurs, on page 4-42
- Creating an Action Request Package, on page 4-51
- Creating a Custom Package, on page 4-53



Note:

Customer Administrators and Customer Operators are respectively advised to consult the *Administrator's Memorandum*, on page xxiii or the *Operator's Memorandum*, on page xxv for a detailed summary of the everyday tasks they will perform.

For further information about user accounts and passwords, see *Setting up PAP Unit Users*, on page 5-17.

Introducing PAM Monitoring Tools

Main Central SubSystem (CSS) hardware components are managed by the comprehensive Platform Administration and Maintenance (PAM) software specifically designed for Bull NovaScale Servers.



Note:

Peripheral devices such as disk racks, PCI adapters, KVM switch, local console, and the PAP unit are managed by the Operating System and/or by dedicated software. For details on how to monitor these devices, please refer to the user documentation provided on the Bull NovaScale Server Resource CD-Rom.

PAM software permanently monitors and regulates CSS hardware during operation, ensuring automatic cooling for compliance with environmental requirements, power ON / OFF sequences, component presence and functional status checks, and event handling and forwarding.

In-depth monitoring is a Customer Administrator function and the PAM **Hardware Monitor** is only available to users with administrator access rights. However, all connected users are permanently and automatically informed of CSS functional status via the PAM **Status** pane and of domain status via the PAM **Domain Manager Control** pane.

The PAM **Event Messaging** system offers comprehensive event message subscription options allowing both connected and non-connected users to be informed of server status. See *Customizing the PAM Event Messaging System*, on page 5-133 for details.

To refresh the PAM display:

- Click the **Refresh Tree** button in the PAM Tree toolbar to refresh the PAM Tree.
- Click a node in the PAM Tree to refresh the corresponding Control pane display.
- Click the **Refresh Web Page** button to return to the PAM Home Page.



Note:

DO NOT use the Refresh option obtained by right clicking the mouse in the browser window.

Viewing System / Component Status

What You Can Do

- Check system status
- Check CSS module availability status
- Check event message status
- View hardware presence status
- View hardware functional status
- View server hardware status
- View FRU information
- View firmware information
- View thermal status
- View power status
- View temperature status
- View fan status
- View jumper status
- View PCI slot status

PAM Status Pane

When you log onto the PAM Web site, you are able to check system status at a glance via the **Status** pane which provides quick access to CSS Module availability status, server functional status, and pending event message information.

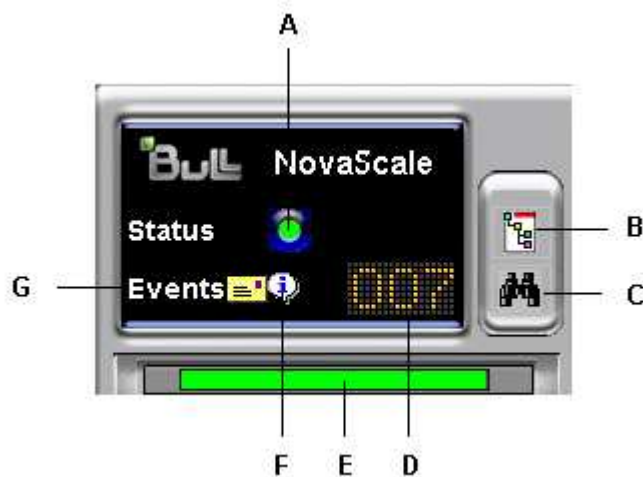

A	System Functional Status icon	E	CSS Availability Status icon
B	Presence/Functional Status toggle button	F	Event Message Severity icon
C	Event Message Viewer		New Event Message icon
D	Pending Event Message icon		

Figure 58. PAM Status pane

CSS Availability Status

The CSS availability status bar reflects the operational status of the data link(s) between the Platform Management Board (PMB) embedded in each CSS Module and the PAP Unit. Each CSS module is represented by a zone in the status bar.

- When a CSS Module PMB is detected as **PRESENT**, the corresponding zone in the status bar is **GREEN**.
- When a CSS Module PMB is detected as **ABSENT**, the corresponding zone in the status bar is **RED**.
- When you hover the mouse over the status bar, an **Infotip** displays the **presence status** of CSS Module PMB - PAP Unit data links.

The following figure represents the status bar for a bi-module server. One CSS Module PMB is detected as PRESENT and the other is detected as ABSENT.



A: Bar red (CSS Module_0 not available)

Figure 59. CSS Module availability status bar

System Functional Status

If the system is operating correctly, the **System Functional Status** icon is green. Table 18. explains possible system functional status indications.





Icon	Status	Explanation
 Green	NORMAL	No problem detected. The system is operating correctly.
 Yellow	WARNING	Minor problem reported. The system is still operational.
 Orange	CRITICAL	Serious problem reported. The system is no longer capable of operating correctly. PAM may generate an OS shutdown request.
 Red	FATAL	Major problem reported. PAM may automatically shut down the OS. The system is partially or totally stopped.
 Purple	NOT ACCESSIBLE	Status cannot be computed (detection circuit error).

Table 18. CSS hardware functional status icons



Important:

If the system functional status icon and/or CSS availability status bar is/are not green, see *What to Do if an Incident Occurs*, on page 4-42.

Event Message Status

The **New Event Message** icon informs you that new messages have arrived and that you can click the **View Event Message** icon to view them (the number of unprocessed event messages is also displayed). See *Managing Event Messages, Hardware Faults and History/Archive Files*, on page 4-31.

The **Event Message Severity** icon indicates the set maximum severity level of unprocessed event messages. See *Understanding Message Severity Levels*, on page 4-32.

PAM Tree Pane

As Customer Administrator, you can view the presence and functional status of each hardware element from the PAM Tree pane. The PAM Tree pane is refreshed at your request. Use the **Refresh PAM Tree** button to update the display when required.



Important:

To maintain a trace of transient faults, PAM Tree functional and/or presence status indicators will not change color until the domain has been powered OFF/ON, even if the error has been corrected.

Displaying Presence Status

When, as Customer Administrator, you log onto the PAM Web site, server hardware presence status is displayed in the PAM Tree by default (square, colored indicator next to the **Hardware Monitor** node). If you expand the PAM Tree, the presence status of all hardware elements is displayed.

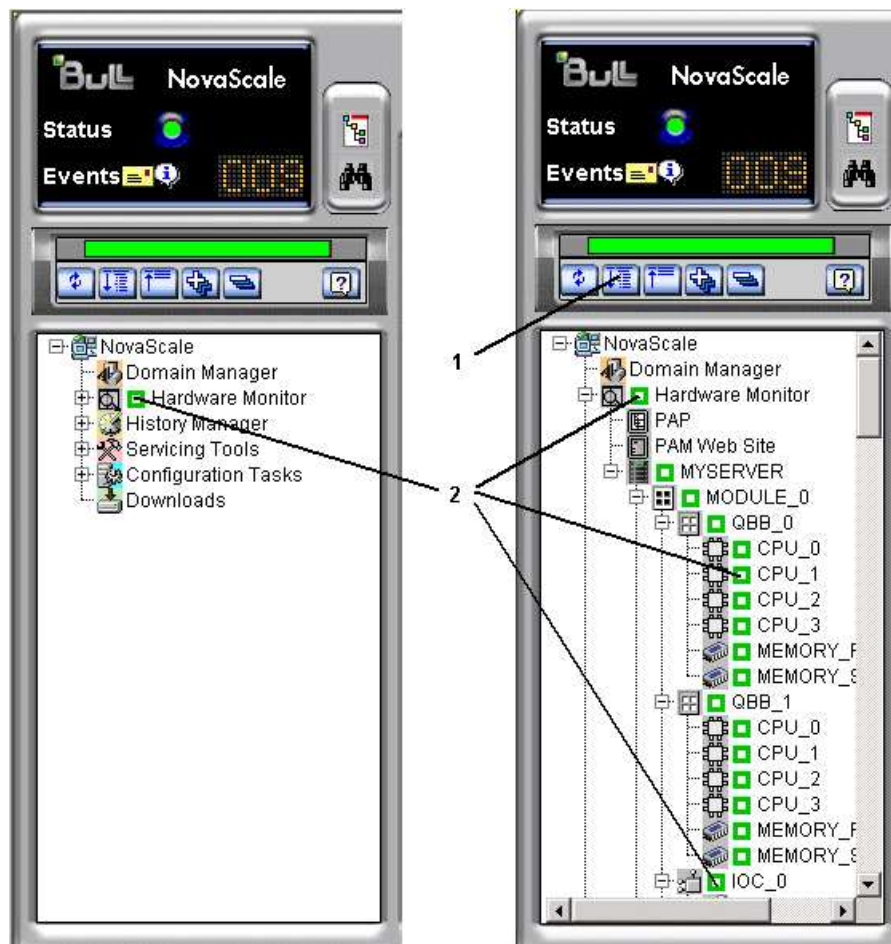

1	Expand PAM Tree button
2	Presence status indicators

Figure 60. PAM Tree hardware presence status display

When hardware presence status is normal, all presence status indicators are green. The following table explains possible hardware presence status indications.

Presence Status Indicators







Indicator	Status	Explanation
 Green	NORMAL	This hardware element: - is physically present and accessible.
 Red	MISSING	This hardware element: - was present in a previous configuration but has disappeared.
 Red/white	MISSING	A sub-component of this hardware element: - was present in a previous configuration but has disappeared.
 Purple	NOT ACCESSIBLE	This hardware element: - cannot be computed (detection circuit error).
 Purple/white	NOT ACCESSIBLE	A sub-component of this hardware element: - cannot be computed (detection circuit error).
 Purple/red	MISSING AND NOT ACCESSIBLE	A sub-component of this hardware element: - was present in a previous configuration but has disappeared. A sub-component of this hardware element: - cannot be computed (detection circuit error).

Table 19. Hardware presence status indicators



Important:

If a PAM Tree hardware presence status indicator is not green, this could be normal if a hardware element has been removed for maintenance. See *What to Do if an Incident Occurs*, on page 4-42.

Displaying Functional Status

You can toggle the PAM Tree to view system / hardware functional status (round, colored indicator next to the **Hardware Monitor** node). If you expand the PAM Tree, the functional status of all hardware elements is displayed.

Functional Status is a composite indicator summarizing Failure Status, Fault Status, Power Status, and Temperature Status indicators, where applicable.

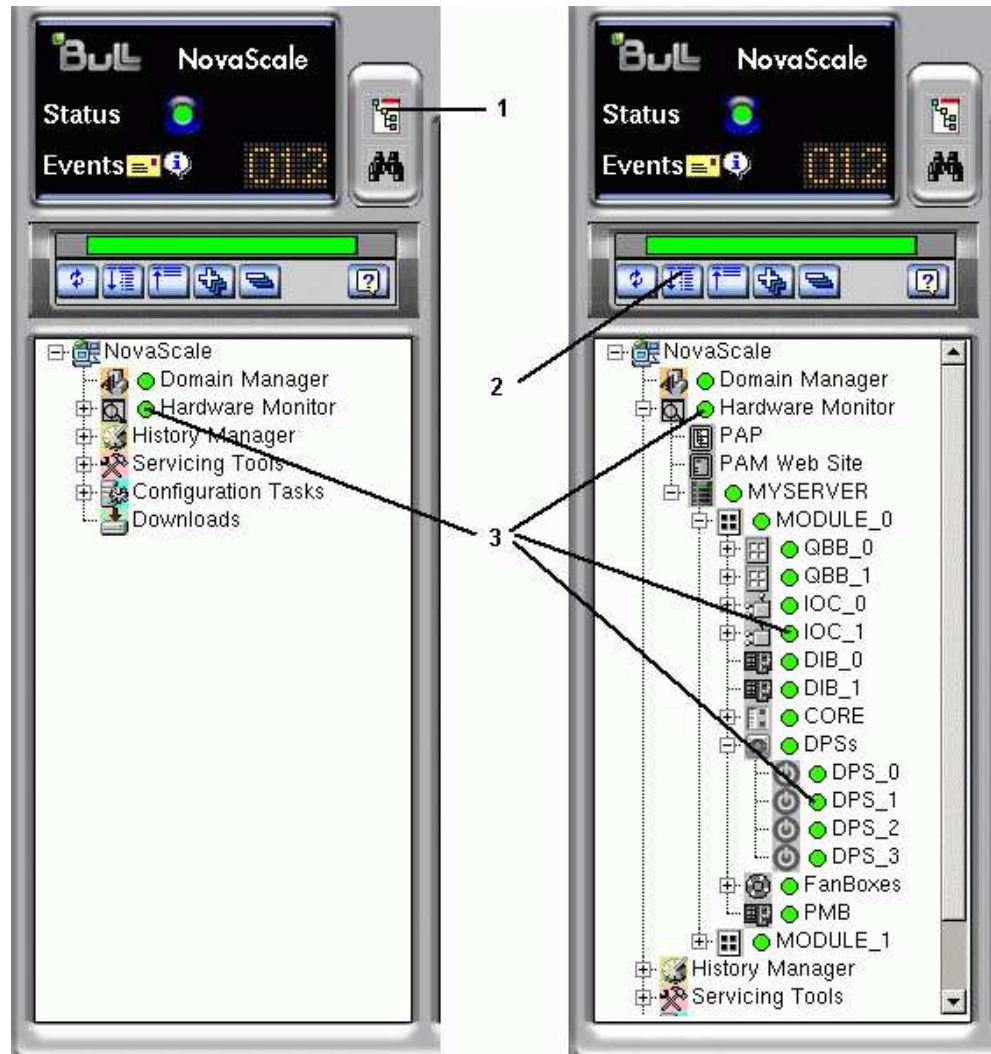

1	Presence/Functional status toggle button
2	Expand PAM Tree button
3	Functional status indicators

Figure 61. PAM Tree functional status display

When hardware functional status is normal, all functional status indicators are green. Table 20. explains possible hardware functional status indications.

Functional Status Indicators





Indicator	Status	Explanation
 Green	NORMAL	No problem detected. This hardware element is operating correctly.
 Yellow	WARNING	Minor problem reported. This hardware element is still operational.
 Orange	CRITICAL	Serious problem reported. This hardware element is no longer capable of operating correctly. PAM may generate an OS shutdown request.
 Red	FATAL	Major problem reported. PAM may automatically shut down the OS. System integrity is jeopardized.
 Purple	NOT ACCESSIBLE	The functional status of this hardware element cannot be computed (detection circuit error).

Table 20. Hardware functional status indicators



Important:

To maintain a trace of transient faults, PAM Tree functional and/or presence status indicators will not change color until the domain has been powered OFF/ON, even if the error has been corrected. Overall server functional status is indicated by the system Functional Status icon in the Status pane. For further details, see *What to Do if an Incident Occurs*, on page 4-42.



Note:

If, when you toggle the PAM Tree to view hardware functional status, the functional status of a hardware element is not normal, the **Hardware Monitor** node will automatically expand to the level of the malfunctioning hardware element, as shown in Figure 62.

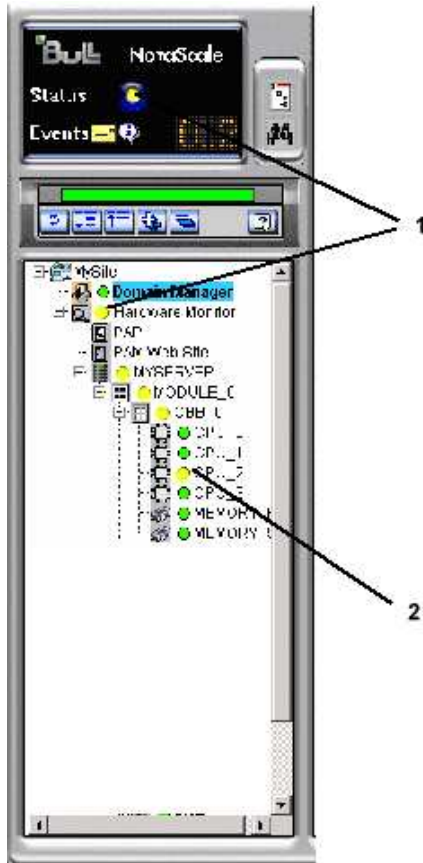

1	Functional status: Warning
2	PAM Tree automatically expanded to faulty CPU

Figure 62. PAM Tree - automatically expanded functional status display

Using PAM Utilities

What You Can Do

- Search for excluded hardware elements
- Search for missing hardware elements
- View PAM Web site information
- View PAM version information
- Exclude / include hardware elements

Using the Hardware Search Engine

The **Hardware Search** engine allows you to search for and view hardware elements corresponding to selected criteria, for example **Excluded** or **Missing** hardware elements.

Notes:

- Excluded hardware elements are those that have been **logically** excluded from the server. See *Excluding / Including Hardware Elements*, on page 4-23.
- Missing hardware elements are those that have been **physically** removed from the server (e.g. for maintenance).

To search for specific hardware:

1. Click **Hardware Monitor** in the PAM tree to open the **Hardware Search** page.

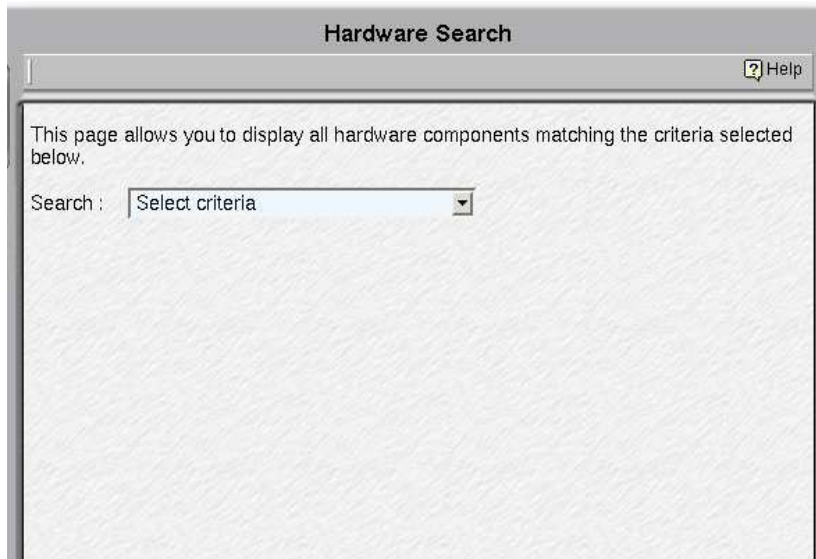

Figure 63. Hardware Search engine

2. Select the required search criteria from the dropdown box and click **OK**.

3. Once the search is complete, results are displayed in the control pane.

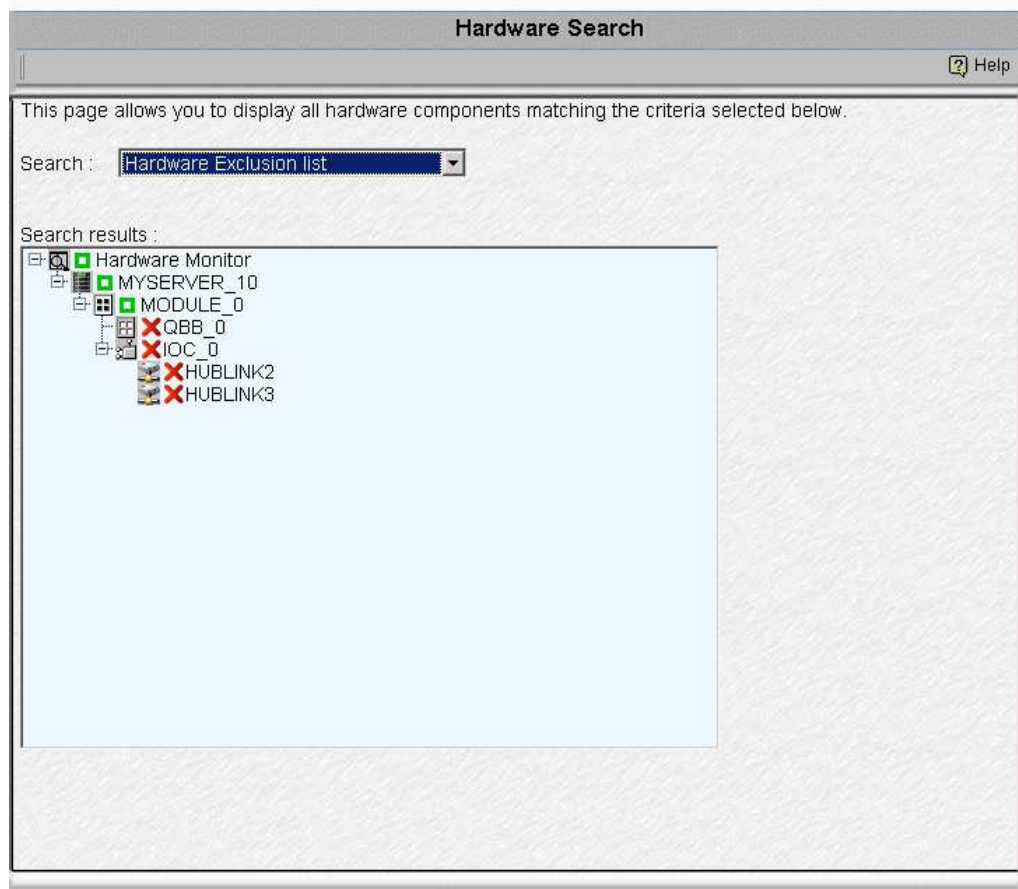



Figure 64. Hardware Search result list (example)

Viewing PAM Web Site User Information

As Customer Administrator, you can view the list of PAM users currently logged onto the PAM Web site by clicking **Hardware Monitor** → **PAM Web Site**.

The Web site version and a list of connected users and session details are displayed in the **Control** pane. The current session is indicated by the  icon.



Note:

You can view user roles by selecting a user and clicking **View Roles** in the toolbar. The roles associated with this user are displayed in the **Roles for selected session** dialog.

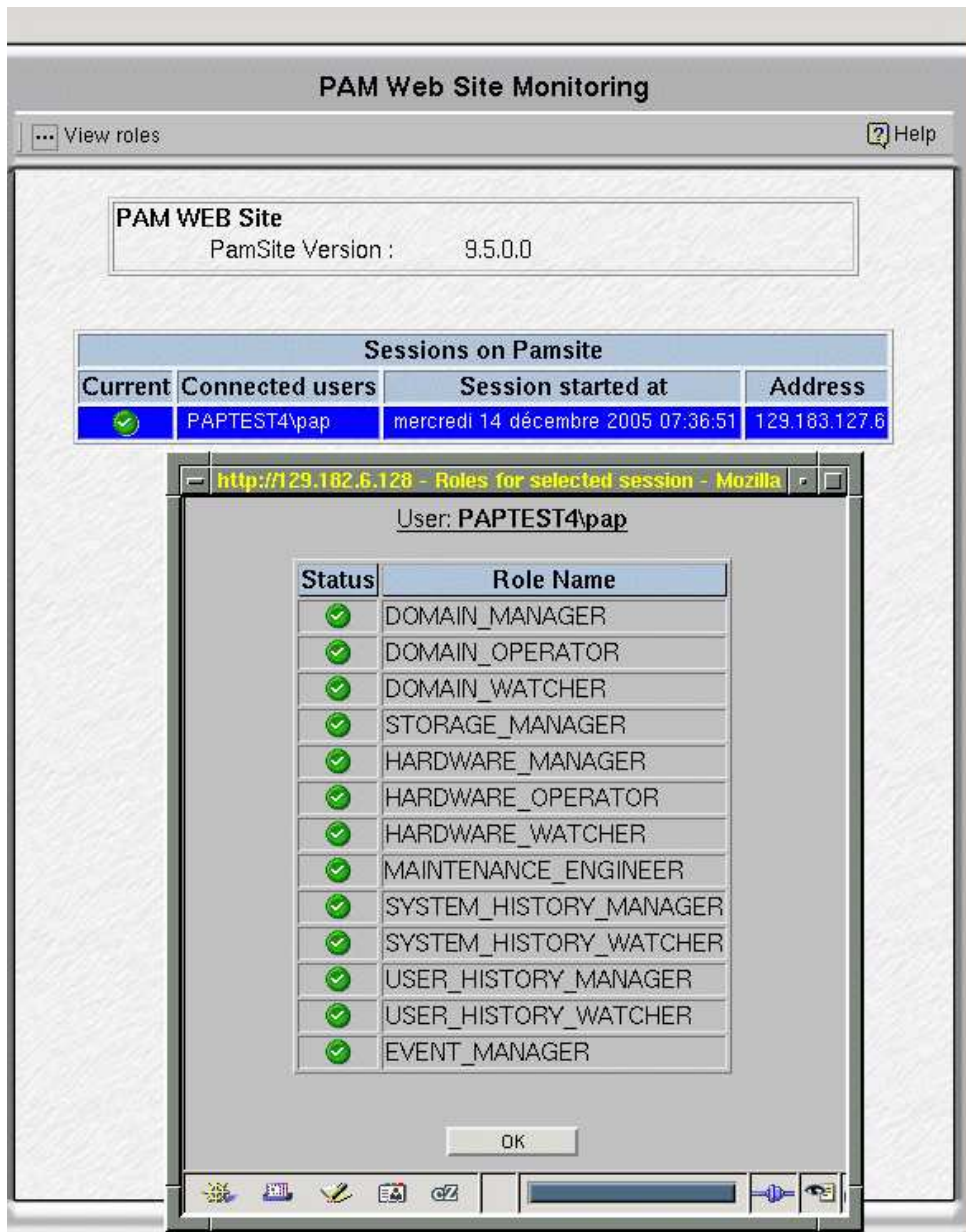

Figure 65. PAM Web Site user information

Viewing PAM Version Information

PAM version information may be useful to help your Customer Service Engineer solve software-related problems.

To view PAM version, site data and release data, click **Hardware Monitor** → **PAP**. The **PAP Unit Information** Control pane opens, indicating PAM software version details along with **PAM Site Data** and **Release Data** directory paths:

- the PAM **Release Data** directory is used for all the files delivered as part of PAM software to ensure configuration consistency.
- the PAM **Site Data** directory is used for all the files produced by PAM software (history files, configuration files) concerning Customer site definition and activity.

To view complete PAM resource file information, click **More Info**. The **PAM Versions** dialog opens.

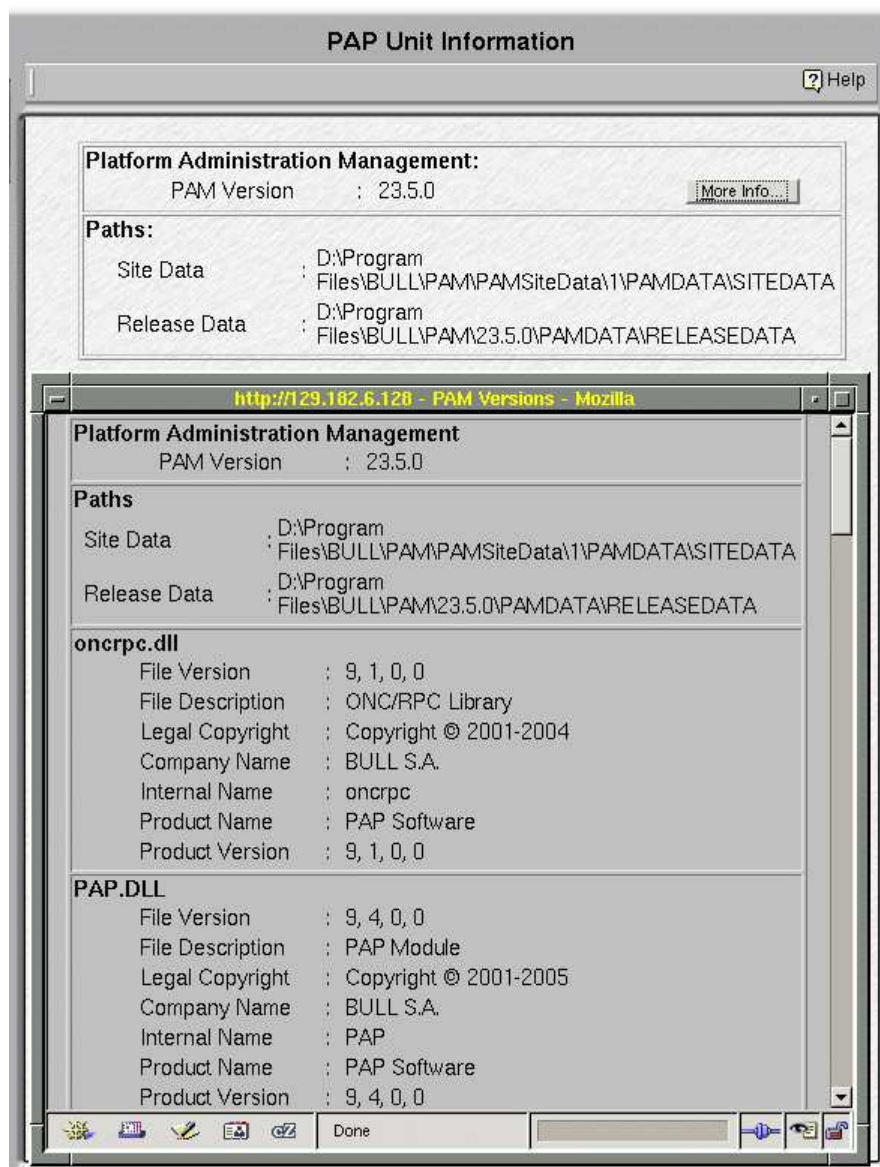
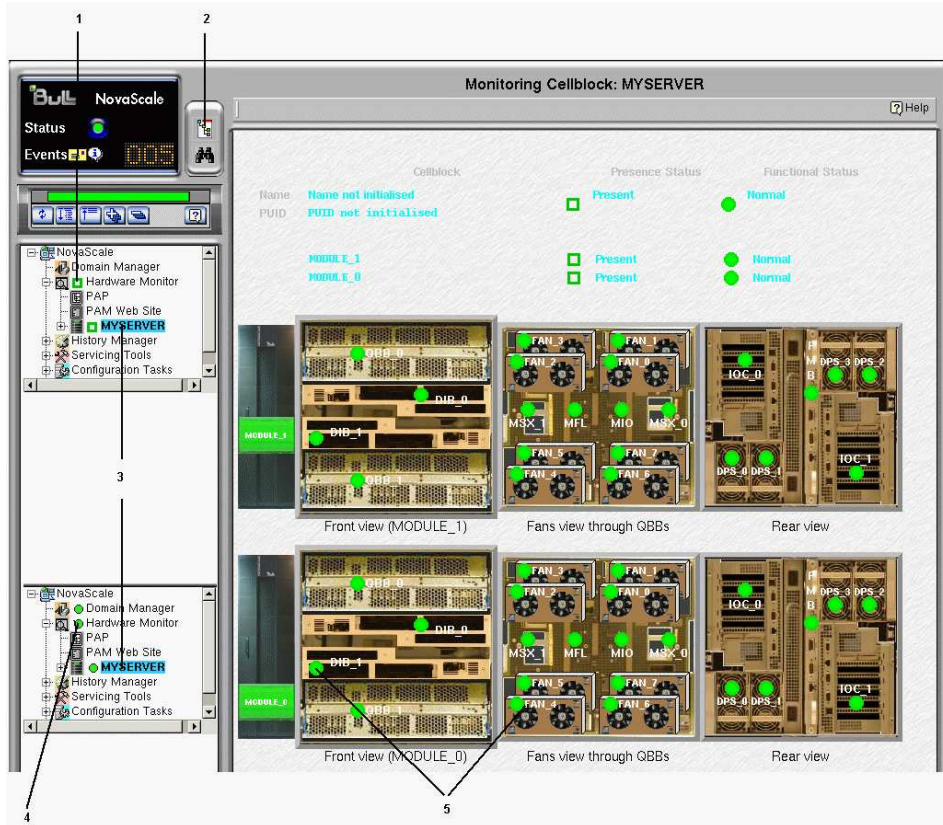

Figure 66. PAP unit information

If you want to deploy a new PAM release or activate another PAM version, see *Deploying a New PAM Release*, on page 5-23 and *Activating a PAM Version*, on page 5-24.

Viewing Server Hardware Status

When you click the **CSS Name** in the PAM tree (e.g. **MYSERVER** in the figure), the **Hardware Monitor** displays a visual representation of the presence and functional status of CSS module components in the Control pane. Each primary hardware element functional status indicator is a clickable hotspot leading directly to the detailed **Hardware Status** page.



1	Presence status (default display)
2	Presence/Functional status Tree Toggle
3	CSS name
4	Functional status (after toggle)
5	Clickable hotspots

Figure 67. PAM Hardware Monitor

As you click a hardware element hotspot in the Control pane, you will notice that the PAM Tree automatically expands to the selected component level.



Note:

If a component is not part of your configuration, it is grayed out in the display. If a component is part of your configuration but has been detected as "missing", it is displayed in red.

The meanings of presence and functional status indicators are explained in Table 19. *Presence Status Indicators*, on page 4-6 and Table 20. *Functional Status Indicators*, on page 4-8.



Important:

If a functional status indicator is not green, see *What to Do if an Incident Occurs*, on page 4-42.

Viewing Detailed Hardware Information

For detailed information about module / component / sub-component status, you can either click the corresponding hotspot in the **Hardware Monitor** Control pane or click the required hardware element in the PAM Tree to open the **Hardware Status** page.

General Tab

The **General** tab gives access to the following information:

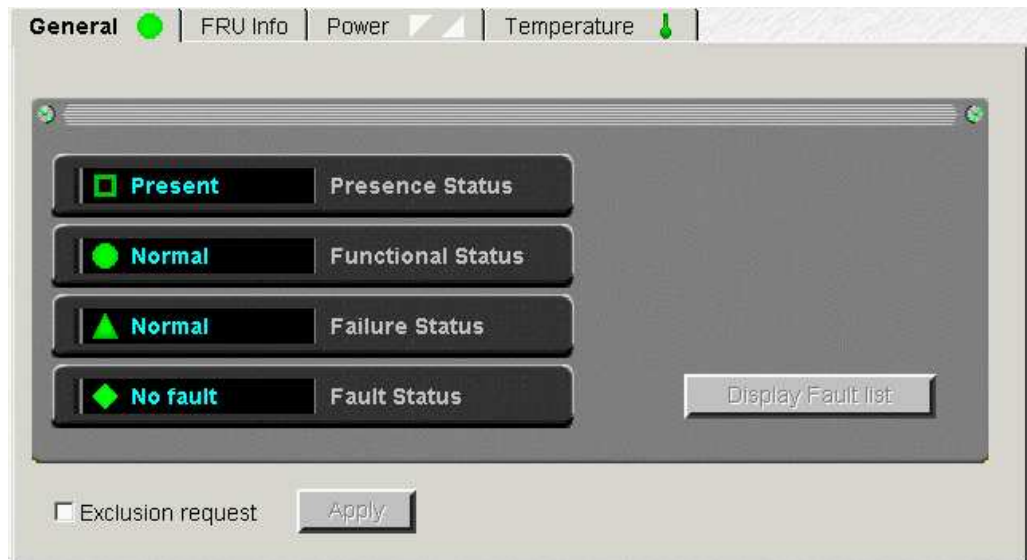





Presence Status	Indicates if the hardware element is physically present and correctly configured. See <i>Presence Status Indicators</i> , on page 4-6.
Functional Status	Indicates if the hardware element is functioning correctly. See <i>Displaying Functional Status</i> , on page 4-7. NOTE: Functional Status is a composite indicator summarizing Failure Status, Fault Status, Power Status, and Temperature Status indicators, where applicable.
Failure Status	Indicates if a failure has been detected on the hardware element. NOTE: This feature is reserved for future use. See <i>Failure Status Indicators</i> , on page 4-16.
Fault Status	Indicates if a fault has been detected on the hardware element. See <i>Fault Status Indicators</i> , on page 4-16.
Display Fault List	When a hardware fault is detected, a fault message is generated and the Display Fault List button gives direct access to the list of faults recently encountered by this hardware element. See <i>Managing PAM Messages, Histories, Archives and Fault Lists</i> , on page 4-31.
Exclusion Request	The Exclusion Request checkbox is used to logically exclude/include hardware elements from the domain at the next power-on. See <i>Excluding / Including Hardware Elements</i> , on page 4-23.

Note:

The CSS Module Hardware Status page also indicates CSS module clock frequency.

Figure 68. General Hardware Status page (example)

Failure Status Indicators:

Indicator	Status	Explanation
 Green	NORMAL	PAM software has detected no failures on this hardware element.
 Orange	DEGRADED	PAM software has detected that this hardware element is running at sub-standard capacity but is not jeopardizing system performance.
 Red	FAILED	PAM software has detected a failure that may be jeopardizing system performance.
 Gray	UNKNOWN	PAM software is not receiving diagnostic information from this hardware element.

Fault Status Indicators

Fault Status, accessible via the **General** tab,



Indicator	Status	Explanation
 Green	NORMAL	PAM software has detected no faults on this hardware element.
 Red	FAULTY	PAM software has detected 1 or more fault(s) on this hardware element.
 Gray	UNKNOWN	PAM software is temporarily meaningless (e.g. hardware element missing).

Table 21. Fault status indicators

FRU Info Tab

The **FRU Info** tab gives access to Field Replaceable Unit identification data for the hardware element, such as Manufacturer's name, product name, part number,

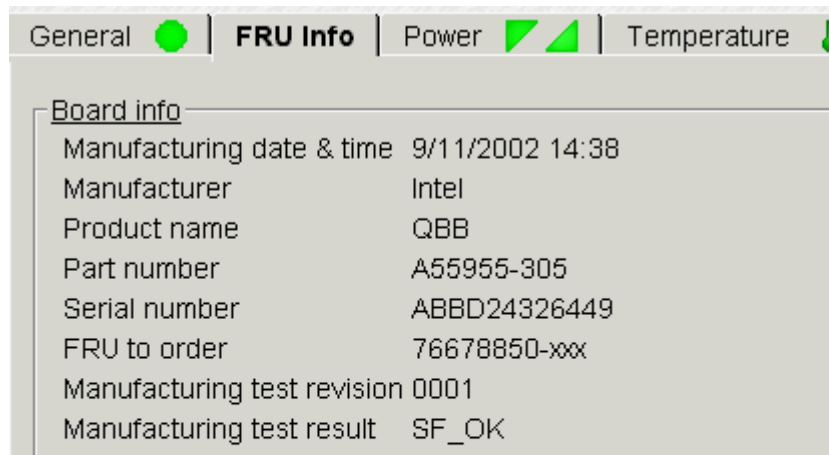

Figure 69. FRU data (example)



Note:

When two Internal Peripheral Drawers are inter-connected to house 4 SCSI RAID disks, 1 DVD-ROM drive, 1 USB port, the **FRU Info** tab indicates **Chained DIBs** in the **FRU to order** field.

Firmware Tab (Core MFL & PMB only)

The **Firmware** tab gives access to firmware version data for the hardware element.



Note:

Firmware versions may differ.

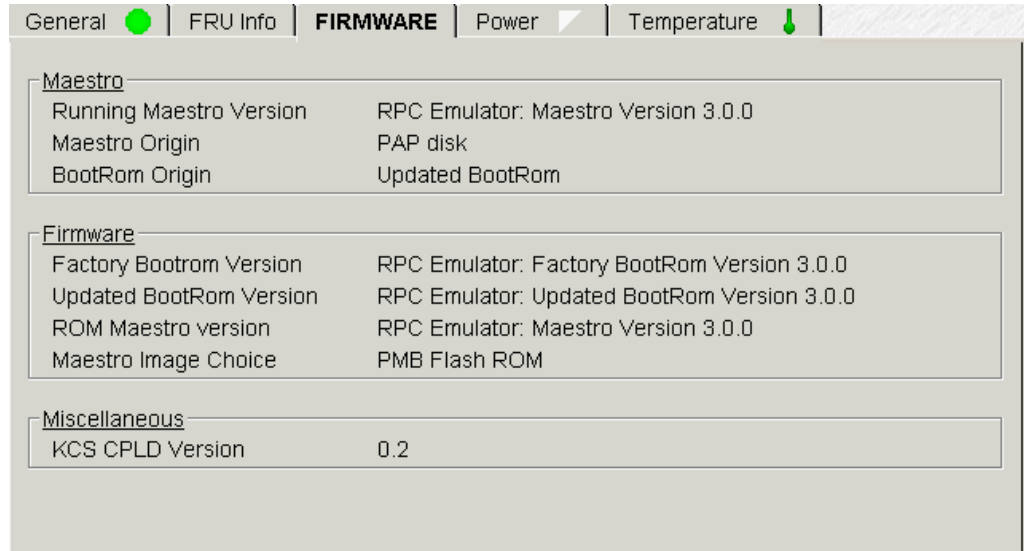

Figure 70. Firmware data (example)

Thermal Zones (CSS module only)

Thermal Zones, accessible via the **Thermal zones** tab, shows the thermal zones monitored by PAM software. A cooling error in a thermal zone will affect all the hardware elements in that zone. See *Displaying Functional Status*, on page 4-7.



Figure 71. CSS module thermal zone details

Power Tab

The **Power** tab gives access to power status data for the hardware element, indicating main and standby power state and/or power-specific faults for each converter. See *Displaying Functional Status*, on page 4-7.

Once connected to the Customer's site power supply, server hardware elements initialize to the stand-by mode. Server hardware elements initialize to the main mode when the domain is powered up.

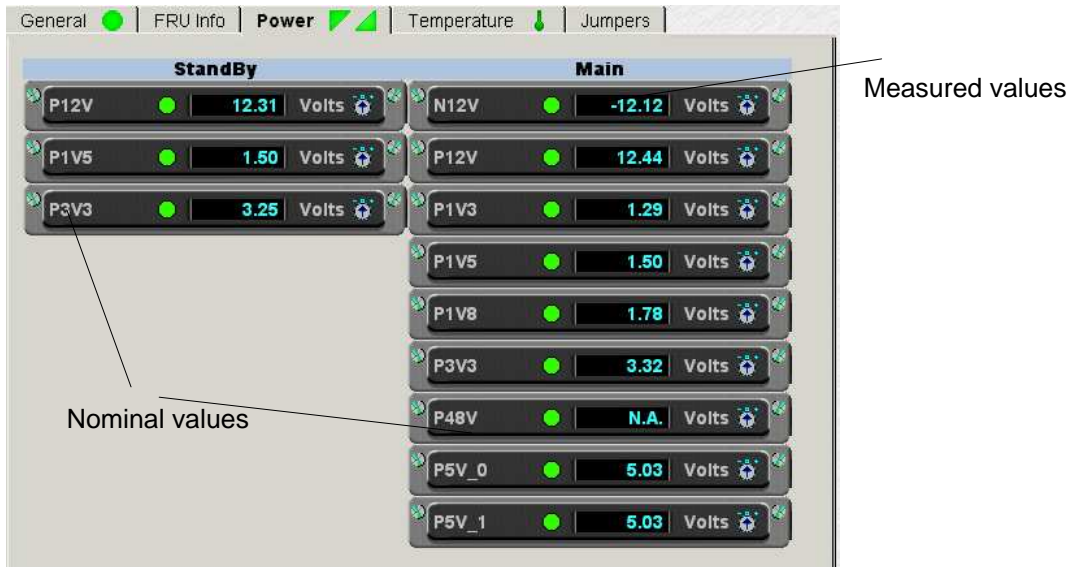

Figure 72. Converter power status details (example)

Indicator	Status	Explanation
Green	MAIN POWER ON	Hardware element main / standby power is on.
Green	STANDBY POWER ON	
White	MAIN POWER OFF	Hardware element main / standby power is off.
White	STANDBY POWER OFF	
Red	MAIN POWER FAULT/FAILED	PAM software has detected 1 or more main / standby power fault(s) on this hardware element.
Red	STANDBY POWER FAULT/FAILED	
Gray	MAIN POWER MISSING/UNKNOWN	PAM software cannot read main / standby power status on this hardware element.
Gray	STANDBY POWER MISSING/UNKNOWN	

Table 22. Power tab status indicators

CSS Module Power Tab

The **Power** tab gives access to power status data for the CSS module DPS units.

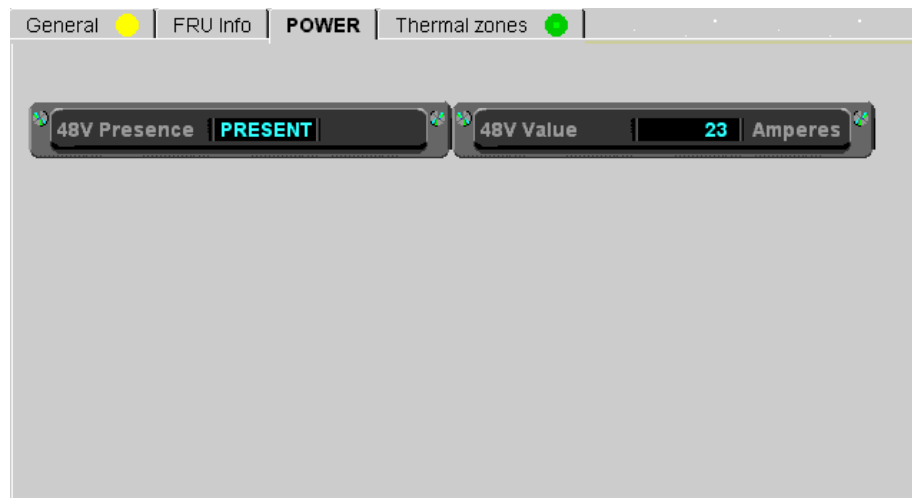

48V Presence	Meaning
PRESENT	At least 1 DPS unit is ON.
ABSENT	All DPS units are OFF.
Not Found	PAM software cannot read CSS module power status.
48V Value	Current intensity in Amperes (varies according to configuration).

Figure 73. CSS module power status details

Temperature Tab

The **Temperature** tab gives access to temperature status data for the hardware element, indicating overtemperature or temperature-specific faults.

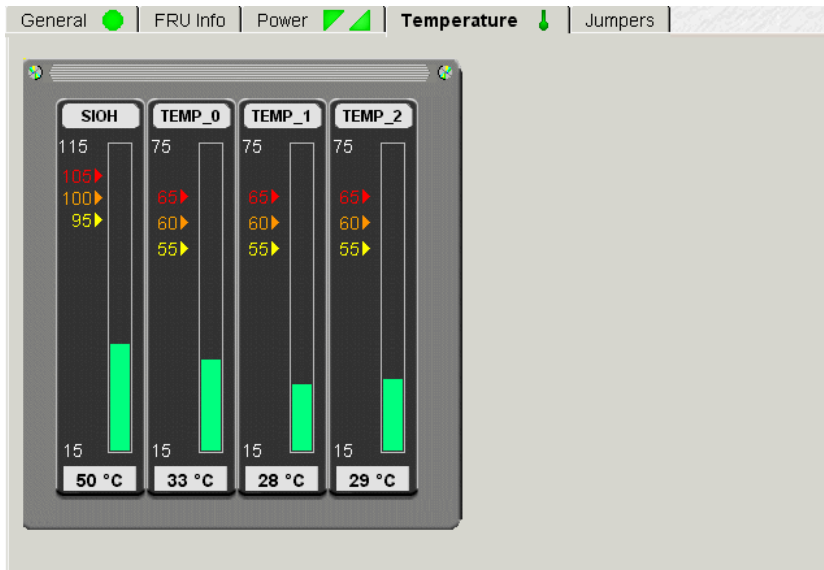

Figure 74. Temperature probe status details (example)





Indicator	Status	Explanation
 Green	NORMAL	Hardware element temperature is normal.
 Yellow	WARNING	PAM software has detected a rise in temperature on this hardware element, but it is still operational and is not jeopardizing system performance.
 Orange	CRITICAL	PAM software has detected a critical rise in temperature on this hardware element. PAM will generate an OS shutdown request.
 Red	FATAL	PAM software has detected a fatal rise in temperature on this hardware element. PAM will automatically shut down the OS.
 Gray	UNKNOWN	PAM software cannot read temperature status on this hardware element.

Table 23. Temperature tab status indicators

Fan Status (Fanboxes only)

Fan Status, accessible via the **Fans** tab, indicates fan status, speed and supply voltage. See *Displaying Functional Status*, on page 4-7.

During normal operation, the display depicts fan rotation.

Each fanbox is equipped with 2 hot-swap, redundant, automatically controlled fans.



Note:

If all fans are halted in the display, check that your browser allows you to play animations in Web pages.

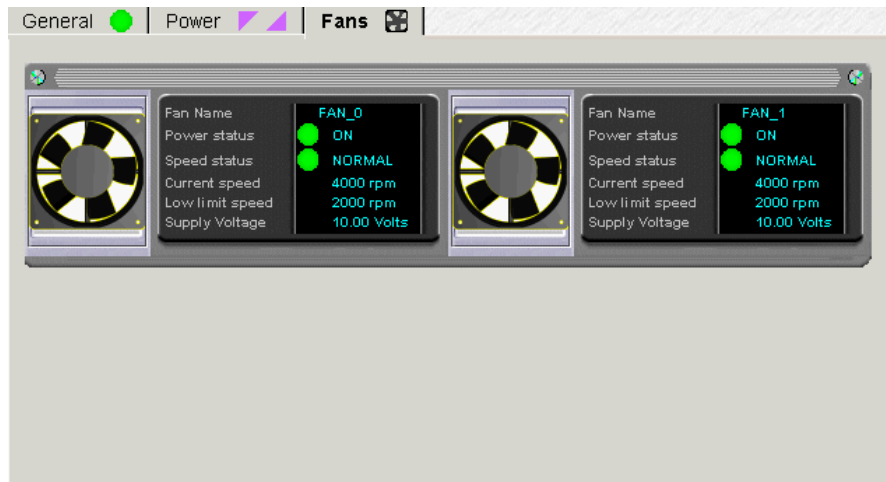

Figure 75. Fanbox details (example)

Jumper Status (IOC only)

Reserved for Customer Service Engineers.

Jumper Status, accessible via the **Jumpers** tab, indicates the current position of BIOS Recovery, ClearCMOS, and ClearPassword jumpers. Reserved for Customer Service Engineers.

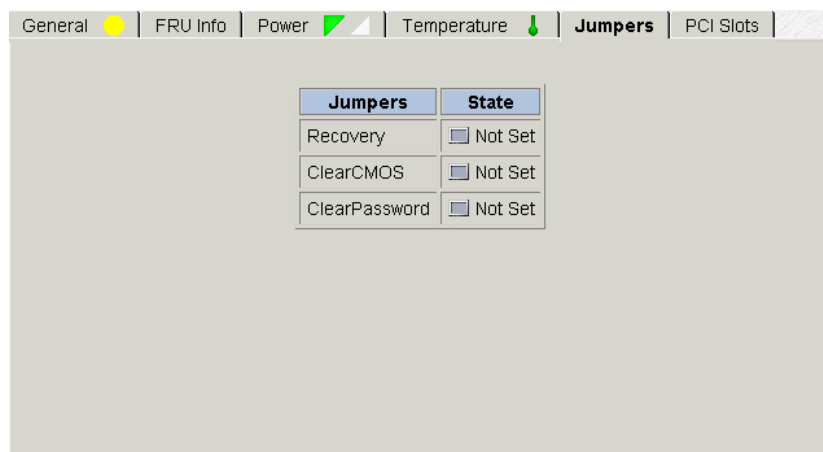



Figure 76. IO Box jumpers tab

PCI Slots (IOC only)

PCI Slot Status, accessible via the **PCI Slots** tab, shows PCI board type and the functional and power status of PCI slots at the last domain power-on. PCI-Express boards are indicated by a  symbol.

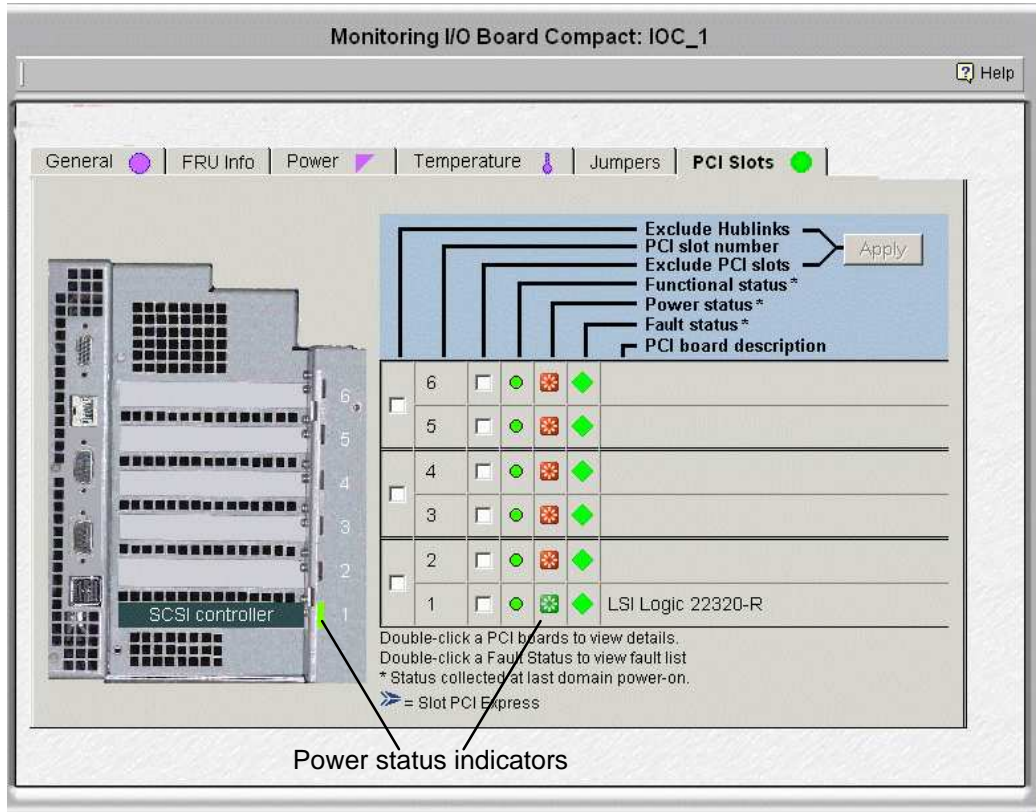

Figure 77. PCI slot status

Clicking a PCI board gives access to **PCI Slot Details**: such as Minor and Signal status, Logical, Bus and Device numbers, Bus and Board frequencies, Vendor, Device and Revision identifiers, Subsystem Vendor and Device identifiers and Class code.

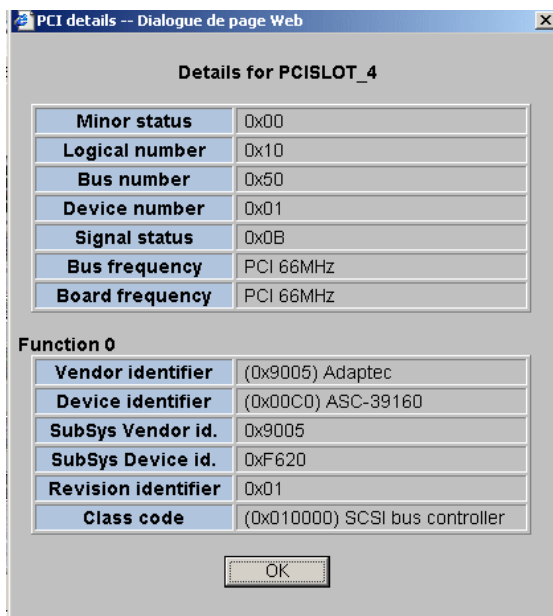

Figure 78. PCI slot details dialog (example)

Excluding / Including Hardware Elements

As Customer Administrator, if a redundant hardware element is faulty, you can logically **Exclude** it from the domain until it has been repaired or replaced. To be taken into account, exclusion requires domain power OFF/ON.

A complete list of logically excluded hardware elements can be obtained via the Hardware Monitor search engine. See *Using the Hardware Search Engine*, on page 4-10.



Important:

Hardware elements must be excluded with care. The exclusion of non-redundant hardware elements will prevent the server domain from booting. Exclusion guidelines are given in the Hardware exclusion guidelines table, on page 4-25.

Excluding a Hardware Element



Important:

The exclusion of a hardware element is only taken into account at the next domain power ON. A complete list of logically excluded hardware elements can be obtained via the Hardware Monitor search engine. See *Using the Hardware Search Engine*, on page 4-10.

1. Check that the hardware element is "excludable" and that exclusion will not affect domain availability. See *Hardware Exclusion Guidelines*, on page 4-25.
2. Click the required hardware element in the **PAM Tree** to open the **Hardware Status** page.

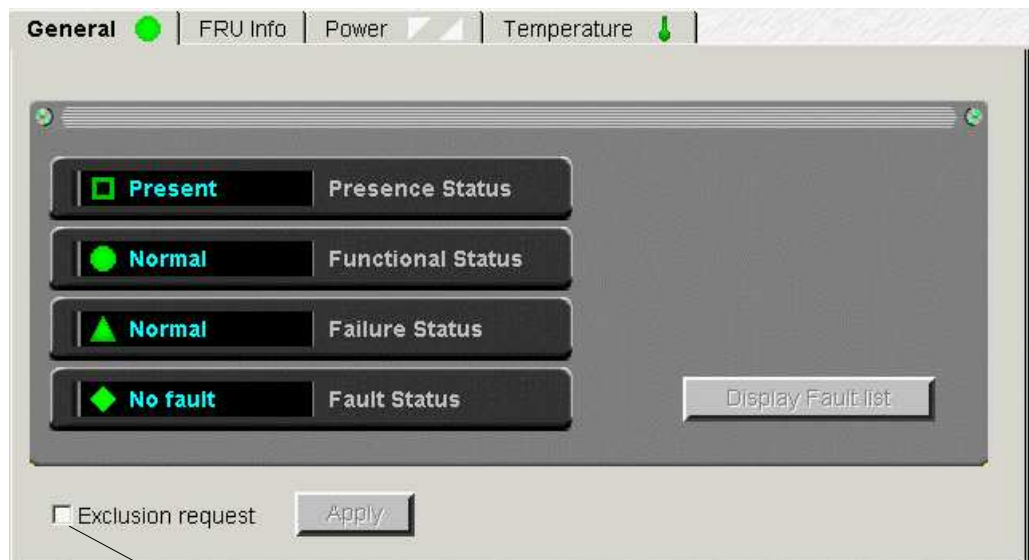

Exclusion request checkbox: select to exclude

Figure 79. Inclusion

3. Select the **Exclude** checkbox and click **Apply**. The **Exclude** dialog box opens.
4. Click **Yes** to confirm exclusion of the selected hardware element. Exclusion will be taken into account at the next domain power ON.

 **Notes:**

- If you want to check domain hardware status, click **Domain Manager** → **Resources** → **More info...** to open the **Domain Hardware Details** page.
- Hardware components to be logically excluded from the domain at the next domain power ON are marked with a red / yellow  icon in the **Lock Request** column in the **Domain Hardware Details** page.

See *Viewing Domain Configuration, Resources and Status*, on page 3-35.

Including a Hardware Element



Important:

The inclusion of a hardware element is only effective once the domain has been powered OFF/ON.

1. Click the required hardware element in the **PAM Tree** to open the **Hardware Status** page.

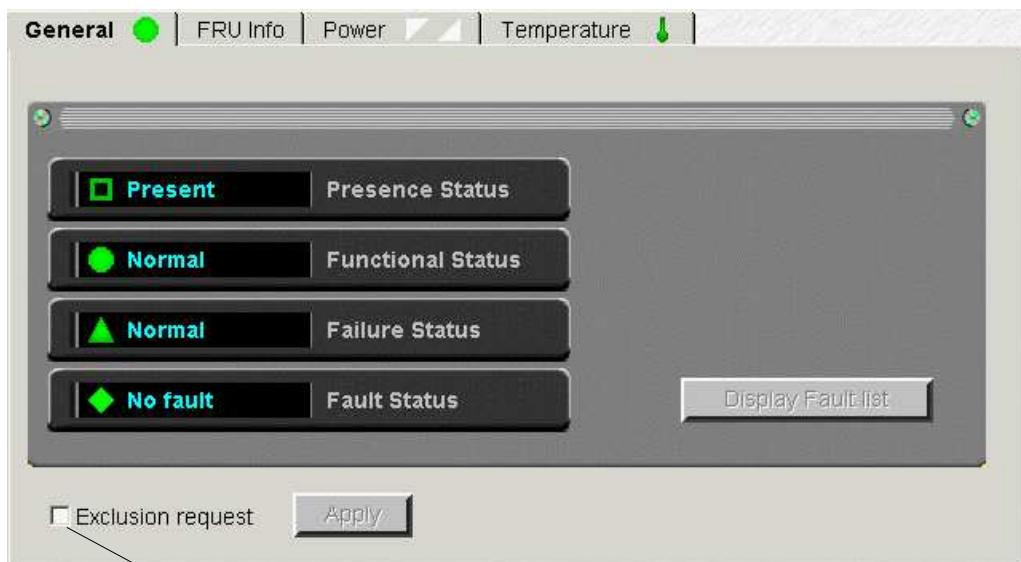

Exclusion request checkbox: deselect to include

Figure 80. Example Hardware Status page

2. Deselect the **Exclude** checkbox and click **Apply**. The **Include** dialog box opens.
3. Click **Yes** to confirm inclusion of the selected hardware element. Inclusion will be taken into account at the next domain power ON.

 **Notes:**

- If you want to check domain hardware status, click **Domain Manager** → **Resources** → **More info...** to open the **Domain Hardware Details** page.
- Hardware components to be logically included in the domain at the next domain power ON are marked with a gray  icon in the **Exclusion Request** column in the **Domain Hardware Details** page.

See *Viewing Domain Configuration, Resources and Status*, on page 3-35.

Hardware Exclusion Guidelines

Hardware Element	Exclusion Guidelines
<p>IMPORTANT: If the following hardware elements are excluded, the corresponding server domain will not power up:</p> <ul style="list-style-type: none"> • Master IOC, Master IOC HubLink 1, Master IOC PCI Slots 1 & 2, Master IOL <p>Note: When a domain comprises more than one cell (therefore more than one IOC), the Master IOC is the one hosting the boot disk. The other IOCs in the domain are Slave IOCs.</p>	
<p>IOC</p>	<ul style="list-style-type: none"> • Slave IOCs can be safely excluded from a domain, but connected peripherals will no longer be accessible. • If the Master IOC is excluded from a domain, the domain will not power up.
<p>IOC HubLink</p>	<ul style="list-style-type: none"> • All IOC HubLinks not connected to a boot disk can be safely excluded from a domain, but connected peripherals will no longer be accessible. IOC HubLinks are organized as follows: HubLink_1 controls PCI Slots 1 & 2 (Master IOC boot disk) HubLink_2 controls PCI slots 3 & 4 HubLink_3 controls PCI slots 5 & 6 <p>Note: If Master IOC HubLink_1 is excluded, the domain will not power up.</p>
<p>PCI Slot</p>	<ul style="list-style-type: none"> • All PCI slots not connected to a boot disk can be safely excluded from a domain, but connected peripherals will no longer be accessible. <p>Note: If Master IOC PCI Slots 1, 2 are excluded, system disks will no longer be accessible and the domain will not power up.</p>
<p>IOL</p>	<ul style="list-style-type: none"> • Slave IOLs can be safely excluded from a domain, but connected peripherals will no longer be accessible. <p>Note: If the Master IOL is excluded, the domain will not power up.</p>
<p>DIB</p>	<ul style="list-style-type: none"> • A DIB can be safely excluded from a domain if it does not house the boot disk. • In Chained DIB configuration, if you exclude one DIB, the other DIB will also be automatically excluded. <p>Note: If a DIB housing a boot disk is excluded, the system disk will no longer be accessible and the domain will not power up.</p>

Table 24. Hardware exclusion guidelines - 1

Hardware Element	Exclusion Guidelines
QBB	<ul style="list-style-type: none"> At least one QBB must be "included" in a domain.
Memory Rows	<ul style="list-style-type: none"> At least one Memory Row must be "included" in a QBB.
CPU	<ul style="list-style-type: none"> At least one CPU must be "included" in a QBB. <p>Note: If all CPUs are excluded from a QBB, the QBB itself is excluded.</p>
SPS	<ul style="list-style-type: none"> At least one SPS must be "included" in a Core Unit. <p>Note: If all SPS are excluded from a Core Unit, the domain will not power up.</p>
Clock	<ul style="list-style-type: none"> At least one Clock must be "included" in a Core Unit.
DPS Unit	<ul style="list-style-type: none"> Only one DPS unit can be safely excluded at a given time.
Fanbox	<ul style="list-style-type: none"> Only one Fanbox can be excluded from a domain at a given time. <p>Note: If more than one Fanbox is excluded, the domain may not power up.</p>

Table 25. Hardware exclusion guidelines - 2

Excluding / Including Clocks, SPS, XSP Cables and Sidebands

PAM software automatically manages and optimizes server ring connections. There are four types of ring connections:

- Clocks
- SPS
- XSP cables
- Sidebands (dedicated to error and reset logs)

In the event of a failure, your Customer Service Engineer may request you to logically exclude a clock, SPS, XSP cable and/or sideband until the failure has been repaired.

Excluding / Including Clocks

For high flexibility, availability and optimum performance, each CSS module is equipped with two clocks (one on each Core unit MSX board). Only one clock is required per domain. If a clock is faulty, you can logically exclude it to ensure correct server operation until replaced. Once the fault has been repaired, you can logically include the excluded clock.

To logically exclude / include a clock:

1. From the **PAM Tree** pane, click **Configuration Tasks** → **Ring Exclusion** to open the Control pane.
2. Select the **Clock** tab to display current server clock configuration.

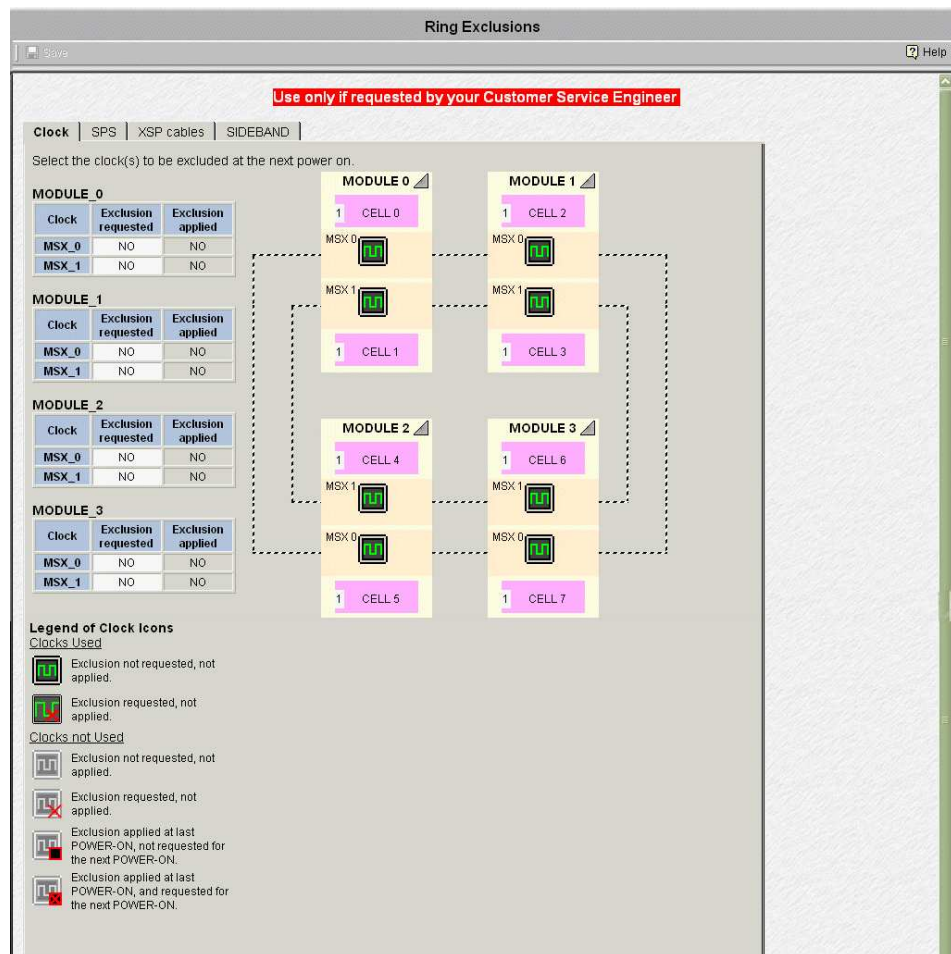

Figure 81. Ring exclusion control pane - clock tab

3. Select the required clock(s) by clicking the corresponding icon or table entry.
4. Click **Save** in the Tool bar to logically exclude / include the clock at the next power-on.

Note:

The legend at the bottom of the Control pane explains different clock states. In the above figure, no exclusions have been requested / applied.

Excluding / Including SPS

For high flexibility, availability and optimum performance, each CSS module is equipped with two SPS for inter-module communication (one on each Core unit MSX board). Only one inter-module communication link is required per domain. If an SPS is faulty, you can logically exclude it to ensure correct server operation until replaced. Once the fault has been repaired, you can logically include the excluded SPS.

To logically exclude / include an SPS:

1. From the **PAM Tree** pane, click **Configuration Tasks** → **Ring Exclusion** to open the Control pane.
2. Select the **SPS** tab to display SPS configuration.

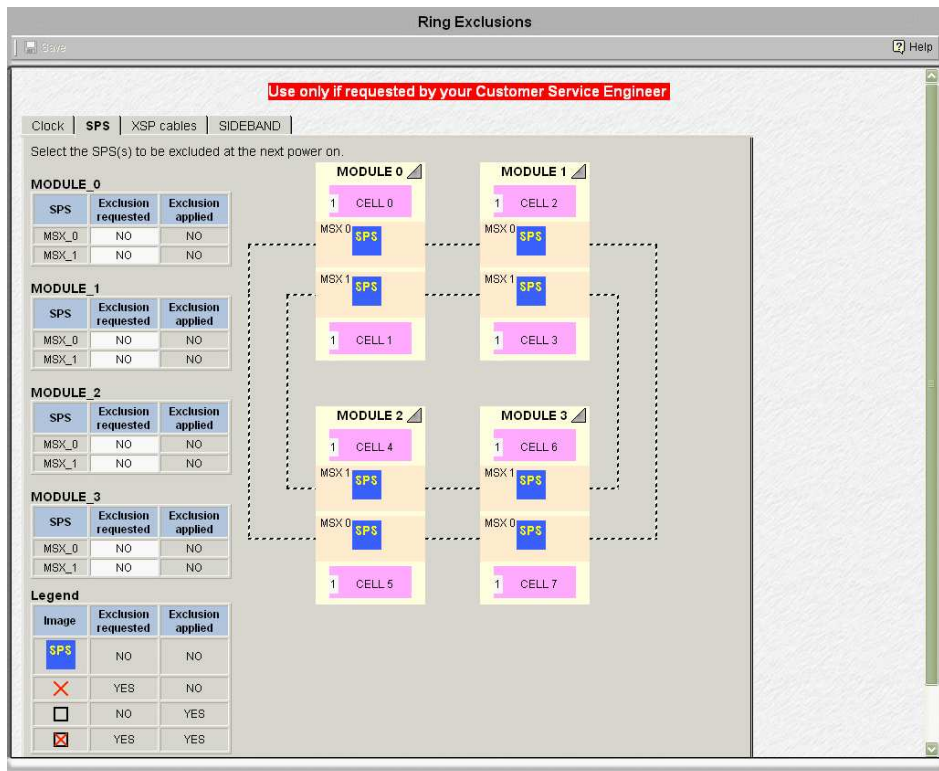

Figure 82. Ring exclusion control pane - SPS tab

3. Select the required SPS by clicking the corresponding icon or table entry.
4. Click **Save** in the Tool bar to logically exclude / include the SPS at the next power-on.

Note:

The legend at the bottom of the Control pane explains different SPS states. In the above figure, no exclusions have been requested / applied.

Excluding / Including XSP Cables

For high flexibility, availability and optimum performance, each CSS module is equipped with two XSP cables for inter-module communication. Each XSP cable routes SPS data and clock signals. If an XSP cable is faulty, you can logically exclude it to ensure correct server operation until replaced. Once the fault has been repaired, you can logically include the excluded XSP cable.

To logically exclude / include an XSP cable:

1. From the **PAM Tree** pane, click **Configuration Tasks** → **Ring Exclusion** to open the Control pane.
2. Select the **XSP cables** tab to display XSP configuration.

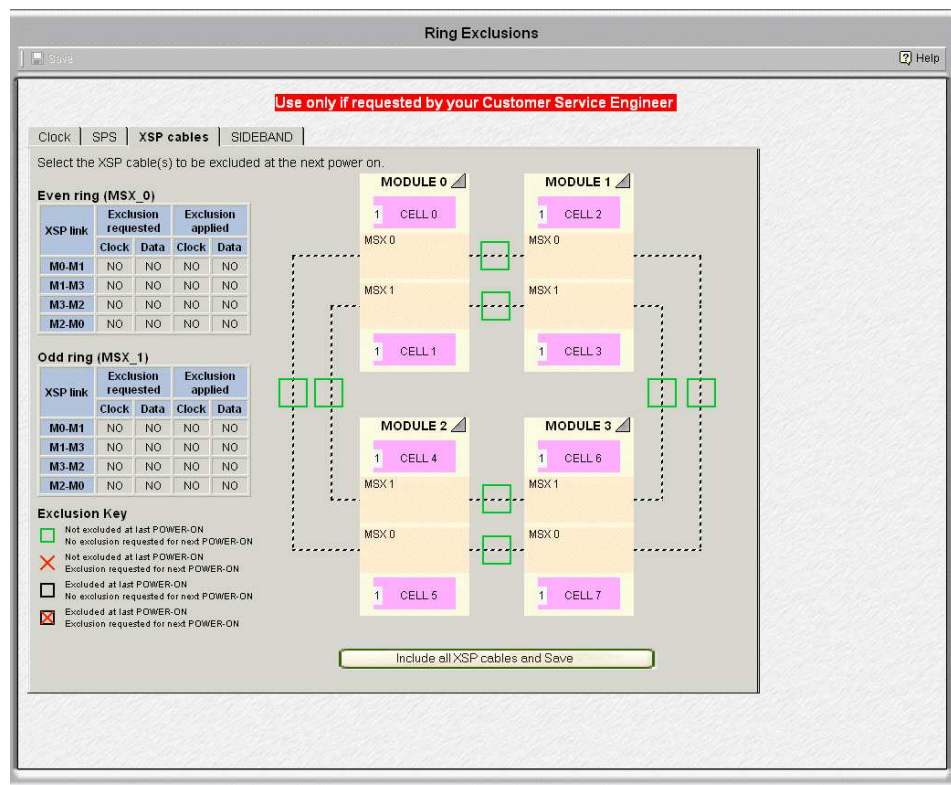

Figure 83. Ring exclusion control pane - XSP cable tab

3. Select the required XSP cable by clicking the corresponding icon or table entry.
4. Click **Save** in the Tool bar to logically exclude / include the selected XSP cable(s) at the next power-on or click the **Include all XSP cables and Save** button at the bottom of the page to logically include ALL previously excluded XSP cables at the next power-on.

Note:

The legend at the bottom of the Control pane explains different XSP cable states. In the above figure, no exclusions have been requested / applied.

Excluding / Including Sidebands

The sidebands route reset and error logs. If a sideband is faulty, you can logically exclude it to ensure correct server operation until replaced. Once the fault has been repaired, you can logically include the excluded sideband.

To logically exclude / include a sideband:

1. From the **PAM Tree** pane, click **Configuration Tasks** → **Ring Exclusion** to open the Control pane.
2. Select the **Sideband** tab to display sideband configuration.

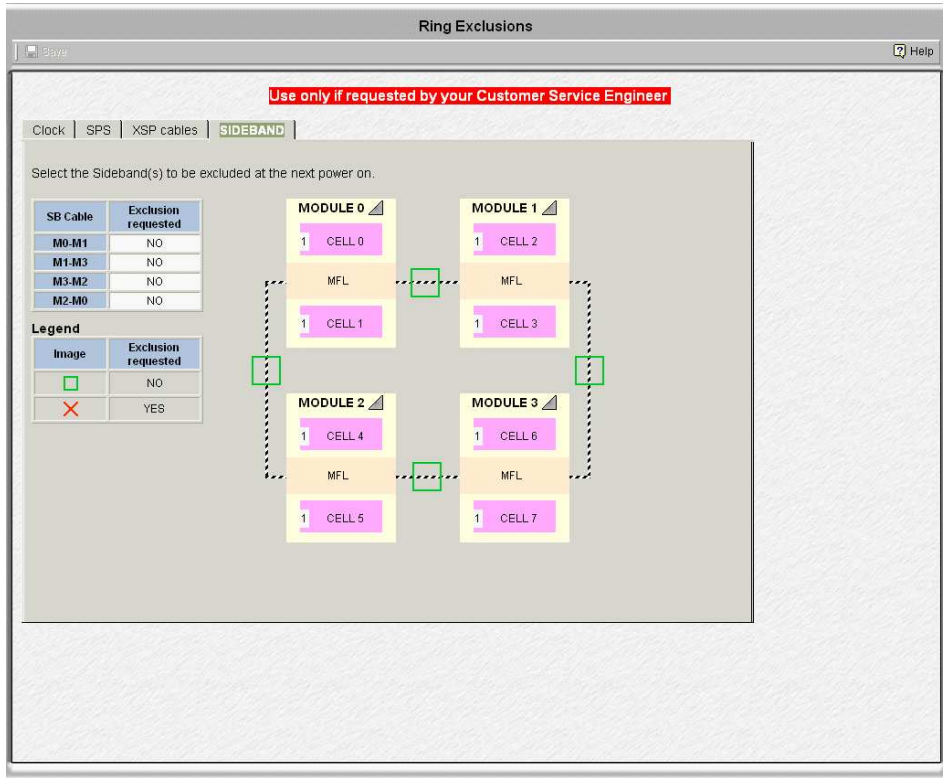

Figure 84. Ring exclusion control pane - sideband tab

3. Select the required sideband by clicking the corresponding icon or table entry.
4. Click **Save** in the Tool bar to logically exclude / include the sideband at the next power-on.



Note:

The legend at the bottom of the Control pane explains different sideband states. In the above figure, no exclusions have been requested / applied.

Managing PAM Messages, Histories, Archives and Fault Lists

What You Can Do

- *View Web event messages*
- *Acknowledge Web event messages*
- *Sort and locate Web event messages*
- *View e-mailed event messages*
- *Display the hardware faults list*
- *View history files online*
- *View archive files online*
- *View history files offline*
- *View archive files offline*
- *Manually archive history files*
- *Manually delete archive files*

A comprehensive set of Event Message subscriptions allows connected and non-connected users to be notified of system status and activity. Pre-defined **Event Message Subscriptions** forward event messages for viewing/archiving by targeted individuals and/or groups, with an appropriate subscription, via:

- the PAM Web interface (connected Customer Administrator / Operator),
- User History files (connected Customer Administrator / Operator),
- e-mail (non-connected recipients - Customer Administrator / Operator / other)
- SNMP traps (non-connected recipients - Customer Administrator / Operator / other),
- an autocall to the Bull Service Center (according to your maintenance contract).

Note:

Subscriptions can be customized to suit your working environment.
For further details, see *Customizing the PAM Event Messaging System*, on page 5-133.

Understanding PAM Message Severity Levels

Messages are graded into four severity levels as shown in the following table.





Icon	Severity Level	Explanation
	SUCCESS	An action requested by a user has been performed correctly or a function has been completed successfully. Information message, for guidance only.
	INFORMATION	System operation is normal, but status has changed. Information message, for guidance and verification.
	WARNING	An error has been detected and overcome by the system or a processed value is outside standard limits (e.g. temperature). System operation is normal, but you are advised to monitor the hardware concerned to avoid a more serious error. See <i>What to Do if an Incident Occurs</i> , on page 4-42.
	ERROR	An error has been detected and has not been overcome by the system. System integrity is jeopardized. Immediate action is required. See <i>What to Do if an Incident Occurs</i> , on page 4-42.

Table 26. Message severity levels

During normal operation, messages will be marked with the **SUCCESS** or **INFORMATION** icon.



Note:

A single message may have different severity levels. For example, the message `<Unit absent>` may be the result of a:

- **Presence Status** request, indicating component status (information level).
- **Action** request, indicating an error. The command cannot be executed because the component is absent (error level).



Important:

If a message is marked with the **WARNING** or **ERROR** symbol, see *What to Do if an Incident Occurs*, on page 4-42.

Viewing PAM Messages and Fault Lists

Whether you consult a **Web Event Message**, a **Faults List**, a **System / User History** or **Archive**, the resulting display and utilities are the same.

Display Events

Select all events Unselect all events Acknowledge selected events Help

String contained in attribute Case sensitive Search Reset

7 event(s) / 0 selected

Ack	SV	ID	Local Time	Target	String
<input checked="" type="checkbox"/>		2B2B2214	03/15/04 - 10:18:41	./DOMAIN_MYOPERATIONS-1	Domain MyOperations-1 time out during the power on sequence
		Identifier	2B2B2214		
		Index	247		
		UTCTimeStamp	1079342321434		
		UTCDate	03/15/04		
		UTCTime	09:18:41		
		LocalDate	03/15/04		
		LocalTime	10:18:41		
		Severity	ERROR		
		Source	PAM.Kernel/IPAPDomain/Thread_DomainTimeOut		
		Target	./DOMAINGROUP_MYSERVER/DOMAIN_MYOPERATIONS-1		
		String	Domain MyOperations-1 time out during the power on sequence		
		Data			

Help on message 2B2B2214

2B2B2211 03/15/04 - 10:14:57 .../DOMAIN_MYOPERATIONS-1 Domain MyOperations-1 inactive

2B2B400A 03/15/04 - 10:14:11 FRCLS5778wca WEB Session started. User: FRCLS5778wca. SessionId: 69800496

2B2B400B 03/15/04 - 10:10:20 FRCLS5778lsa WEB Session ended. User: FRCLS5778lsa. SessionId: 69800495

Button	Use
Acknowledge selected events	To remove viewed messages from the pending event list.
Select all events	To select all Ack checkboxes.
Unselect all events	To deselect all Ack checkboxes.
Help	To access context sensitive help.
Search	To search for specific messages, according to:
- String	- Alphanumeric identifier (ID), e.g. 2B2B2214 above.
- Contained in attribute	- Message Source, Target, String, Data attributes.
- Case sensitive	- Upper case / lower case letters.
Reset	To delete the current search history.
Ack	To select the message for acknowledgement.
+	To view the message and access context sensitive help.
Help on message	To view the related help message.
Column Header*	Use
Type	To sort messages according to severity level.
ID	To sort messages according to Message IDentifier, e.g. 2B2B2214 above.
Local Time	To sort messages according to message local time and date.
Target	To sort messages according to the component referred to in the message.
String	To sort messages according to message text string.

* Double click the column header to sort messages

Figure 85. Display Events page

Specimen Message Help File

The **Help File** explains the message and indicates related actions, where applicable, as shown in Figure 86.

Message ID: 2B2B2214	
Text	Domain < <i>domain name</i> > time out during the power-on sequence
Description	Domain status information.
Actions	<ul style="list-style-type: none">• Wait until the domain turns to the "INACTIVE" state then power ON the domain. See Powering ON a Domain If the problem persists, contact your Customer Service Engineer.
Comments	

Figure 86. Specimen message help file

Viewing and Acknowledging PAM Web Event Messages

To view Web event messages:

1. From the **Status** pane, click the  icon to open the **Display Events** page. See Figure 85. *Display Events page*, on page 4-33.
2. Click the + sign to expand the required message.
3. Click the **Help on message <xxx>** button at the bottom of the message page for direct access to the corresponding **Help File**. See Table 86 *Specimen message help file*, on page 4-34.

In addition to standard utilities, the **Web Event Message** display allows users to acknowledge messages.



Important:

A maximum of 100 messages are accessible from the Status Pane. Users are advised to regularly acknowledge processed messages to allow the arrival of new messages. Acknowledged messages are stored in the PAMHistory file and can be viewed when required.

See *Viewing, Archiving, and Deleting History Files*, on page 4-36.

To acknowledge Web event messages:

1. Select the required checkbox(es) in the **Ack** column or click **Select all events** to automatically select all checkboxes in the **Ack** column.
2. Click **Acknowledge selected events**.
Acknowledged messages are removed from the pending event list and are no longer accessible via the **Status** pane. The **Pending Event Message Indicator** in the **Status** pane is updated automatically.

Sorting and Locating Messages

From the message display, when you hover the mouse in the **Type** column, an **InfoTip** gives a brief summary of the message allowing you to rapidly scan the list for the required message(s). Use the standard **+** and **-** signs to expand and collapse selected messages.

It may be difficult to locate a message if the list is long, the following short-cuts can be used to organize the display and to locate required messages.

Sorting Messages

Messages can be sorted by clicking a column header to sort the column, e.g. by **Severity (SV)**, **ID**, **Time**, **Target**, **String**. Once sorted, messages will be displayed according to the selected column header.

Locating messages

The **Search** engine can be used to filter the number of displayed logs according to **Source**, **Target**, **String**, **Data** attributes. All four attributes are selected by default, but a single attribute can be selected from the dropdown menu.

To search the message list:

1. If known, enter an alphanumeric message string in the **String** field.
2. Select the required attribute field from the **contained in attribute** dropdown menu.
3. **Case sensitive** is selected by default, deselect if required.
4. Click **Search** to display search results.
5. If you want to carry out another search, click **Reset** to delete the search history.

Viewing E-mailed Event Messages

These messages contain the same information as those available to connected users, but do not contain the corresponding help file. See Figure 85. *Display Events page*, on page 4-33.

Viewing Hardware / Domain Fault Lists

The **Fault List** page allows you to view messages corresponding to the faults recently encountered by a given hardware element.

To view a **Hardware Fault List**:

1. Toggle the **PAM Tree** to display hardware functional status.
2. Click the faulty element node to open the **Hardware Status** page.
3. Click **Display Fault List** to open the **Fault List** page.
4. Click the **+** sign to expand the required message.
5. Click the **Help on message <xxx>** button at the bottom of the message page for direct access to the corresponding **Help File**.

To view a **Domain Fault List**, see *Viewing a Domain Fault List*, on page 3-28.

Viewing, Archiving and Deleting History Files

History and archive files are systematically stored in the **PAMSiteData** directory:

<WinDrive>:\Program Files\BULL\PAM\PAMSiteData\<DataCompatibilityRelease>

The **PAM History Manager** allows you to view, archive and delete history files online and provides you with the tools required to download and view history and archive files offline.

As Customer Administrator / Operator, you will frequently consult **PAMHistory** files for information about system operation.

Note:

System histories and/or archives are only accessible to members of the Customer Administrator group, whereas User histories and/or archives are accessible to members of both the Customer Administrator and Customer Operator groups. For further details about histories and archives, see *Creating a User History*, on page 5-158 and *Editing History Parameters*, on page 5-159.

Viewing History Files Online

Note:

Empty history files cannot be viewed.

To view a history file online:

1. From the **PAM Tree** pane, click **History Manager** to open the Control pane.
2. Select the **Histories** tab.

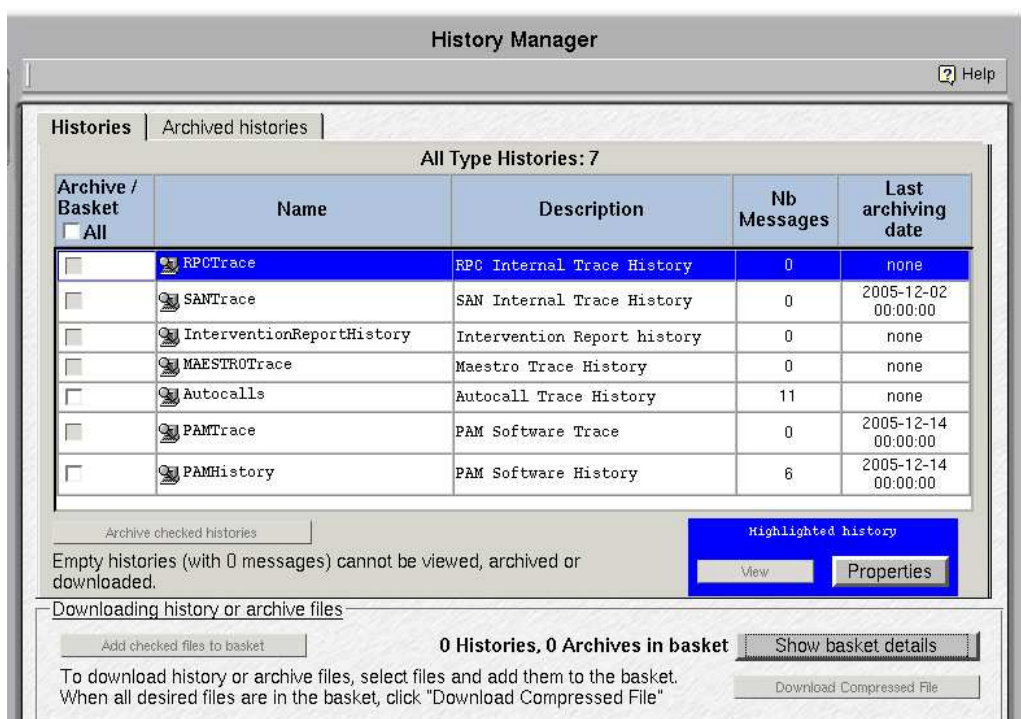

Figure 87. History Manager Control pane - Histories tab

3. Highlight the required type of history and click **View**. All the messages contained in the selected history are displayed.
4. Select the message you want to view in detail. The resulting display is the same as for event messages., on page 4-33

Viewing History Properties

To view history properties:

1. From the **PAM Tree** pane, click **History Manager** to open the Control pane.
2. Select the **Histories** tab.
3. Highlight the required type of history and click **Properties**. The **History Properties** dialog opens.

Name	History name.
Description	Optional description of history contents.
Directory	Pathname of the directory used to store histories. If this field is blank, the default Histories directory is used.
Automatic Archiving Policy	
Type	<p>Number of days: The system will automatically create an archive for this history after the number of days specified in the Value field.</p> <p>Size in KBytes: The system will automatically create an archive when this history reaches the size in KBytes specified in the Value field.</p> <p>Number of Records: The system will automatically create an archive when this history reaches the number of records specified in the Value field.</p>
Value	Number of days / KBytes / records - according to archiving type.
Archive Properties	
Duration	Regular interval at which the archive is automatically deleted.

Figure 88. History properties

 **Note:**

As Customer Administrator, you can modify History properties from the **Histories** Control pane. See *Editing History Parameters*, on page 5-159.

Manually Archiving History Files

In general, history files are automatically archived at regular periods. However, you can choose to manually archive a history file at any time, if required.



Note:

Empty history files cannot be archived.

To manually archive a history file:

1. From the **PAM Tree** pane, click **History Manager** to open the Control pane.
2. Select the **Histories** tab.
3. Select the required type of history checkbox or select the **Archive All** checkbox to archive all histories.
4. Click **Archive checked histories**. A dialog box opens, requesting you to confirm file archiving.
5. Click **OK** to confirm. The selected history(ies) are archived.

Viewing Archive Files Online



Note:

Empty archive files cannot be viewed.

To view an archive file online:

1. From the **PAM Tree** pane, click **History Manager** to open the Control pane.
2. Select the **Archived histories** tab.

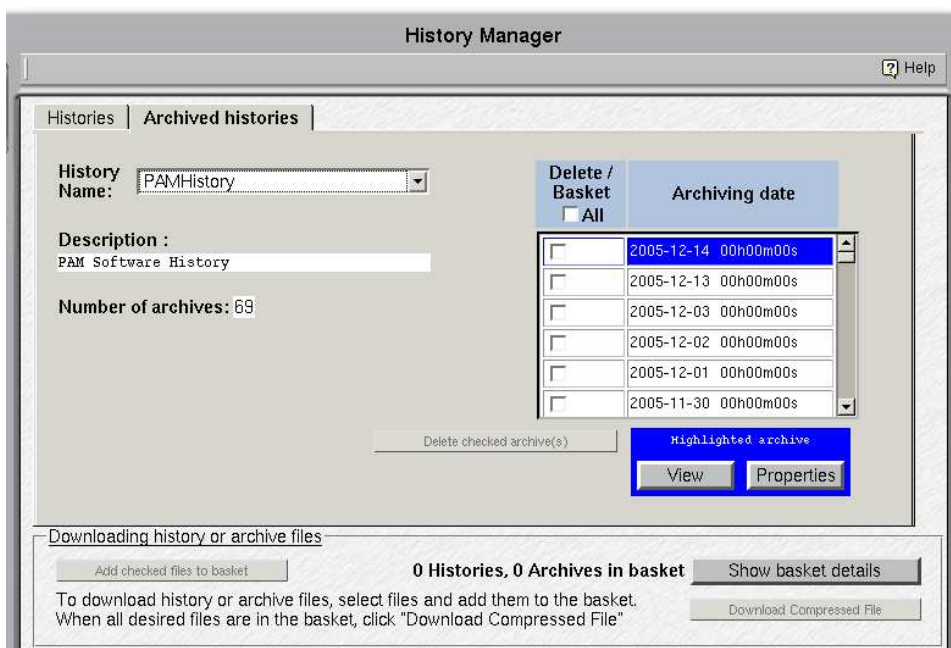

Figure 89. History Manager Control pane - Archived histories tab

3. Use the scroll-down menu to select the type of history archive you want to display. The corresponding list of archived histories appears in the **Archiving date** zone.
4. Highlight the required archiving date and click **View**. All the messages contained in the selected archive are displayed.
5. Select the message you want to view in detail. The resulting display is the same as for event messages., on page 4-33

Viewing Archive Properties

To view archive properties:

1. From the **PAM Tree** pane, click **History Manager** to open the Control pane.
2. Select the **Archived histories** tab.
3. Use the scroll-down menu to select the type of history archive you want to display. The corresponding list of archived histories appears in the **Archiving date** zone.
4. Highlight the required archiving date and click **Properties**. The **Archive Properties** dialog opens.

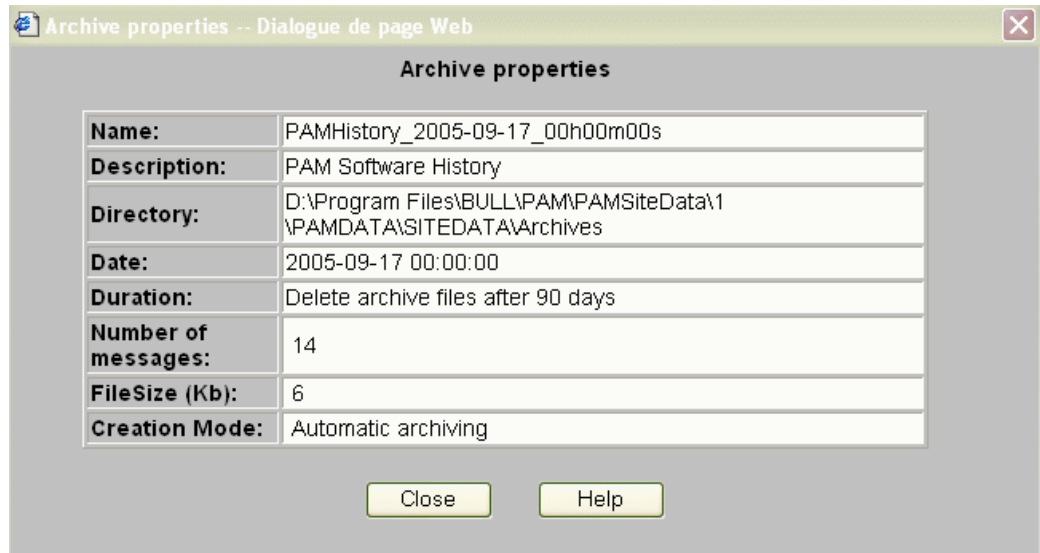

Name	History name, archiving date and time.
Description	Optional description of history contents.
Directory	Pathname of the directory used to store histories. If this field is blank, the default Histories directory is used.
Date	Archiving date and time.
Duration	Regular interval at which the archive is automatically deleted.
Number of messages	Number of messages in the archive.
File Size (Kb)	Archive size in Kb.
Creation Mode	Mode used to create the archive: <input type="radio"/> Automatic archiving <input type="radio"/> Manual archiving <input type="radio"/> History error

Figure 90. Archive properties

Note:

As Customer Administrator, you can modify Archive properties from the **Histories** Control pane. See *Editing History Parameters*, on page 5-159.

Manually Deleting a History Archive File

In general, history archive files are automatically deleted at regular periods. However, you can choose to manually delete a history archive file at any time, if required.

To manually delete a history archive file:

1. From the **PAM Tree** pane, click **History Manager** to open the Control pane.
2. Select the **Archived histories** tab.
3. Use the scroll-down menu to select the type of history archive you want to delete. The corresponding list of archived histories appears in the **Archiving date** zone.
4. Select the required archive checkbox or select the **Delete All** checkbox to delete all archives.
5. Click **OK** to confirm. The selected archives are deleted.

Downloading History / Archive Files for Offline Viewing

The **PAM History Manager** allows you to compress and download history and/or archive files to a local or network directory for offline viewing. The downloaded files can then be viewed with the **History Viewer** tool which displays all the sort options available online, but does not contain the corresponding help file.



Note:

Empty history / archive files cannot be downloaded.

Downloading History Viewer

Before downloading history and/or archive files for offline viewing, you are advised to download the **History Viewer** tool:

1. From the **PAM Tree** pane, click **Downloads** → **History Viewer** to download the **HistoryViewer.zip** file.
2. Unzip all the files in the **HistoryViewer.zip** file to a directory of your choice.
3. Select the **HistoryViewer.htm** file and create a shortcut on your desktop. The History Viewer tool is now ready for use.

Downloading History / Archive Files

To download history / archive files:

1. From the **PAM Tree** pane, click **History Manager** to open the Control pane.
2. Select the **Histories** or **Archived histories** tab, as required.
3. Select the required type of history or archive:

Histories

- Select the required history checkbox or select the **Basket All** checkbox to download all histories.

Archives

- Use the scroll-down menu to select the required archive. The corresponding list of archived histories appears in the **Archiving date** zone.
- Select the required archive checkbox or select the **Basket All** checkbox to download all archives.

4. Click **Add selected files to basket**.



Note:

Files already selected for downloading can be viewed by clicking **Show basket details**.

5. Click **Download Compressed File** to compress and download the histories/archives to the required local or network directory for offline viewing.

Viewing History / Archive Files Offline

1. Unzip all the files in the **History.zip** file to a directory of your choice.
2. Click the **HistoryViewer.htm** file to open the **View History File** page.
3. Complete the **History File Name** field and click **Read**, or click **Browse** to search for and load the required history or archive file.
4. Select the message you want to view in detail. The resulting display is the same as for event messages., on page 4-33



Note:

For further details about histories and archives, see *Creating a User History*, on page 5-158 and *Editing History Parameters*, on page 5-159.

What to Do if an Incident Occurs

Server activity is systematically logged in the **System History** files, which you can view as Customer Administrator at any time.

When an incident occurs, PAM software informs users via:

- the **Status** pane,
- **Event Message / History** file,
- e-mail / **SNMP** traps (users with an appropriate Event Message subscription),
- an **Autocall** to the Bull Service Center (according to your maintenance contract).

In most cases, PAM software handles the incident and ensures operational continuity while the Bull Service Center analyzes the incident and implements the necessary corrective or preventive maintenance measures.

Whenever you are informed of an incident:

- functional or presence status indicators / icon **NOT green**,
- event message or history file marked with the **WARNING** or **ERROR** symbol,

you are advised to connect to the PAM Web site (if you are not already connected) and to investigate the incident.

Investigating Incidents

1. Check the system functional status icon in the **Status** pane. If the icon is not green, the server is not operating correctly. See Table 27. *System Functional Status / Expected Domain State*, on page 4-43.
2. Open the **Domain Manager** Control pane and identify the domain using the faulty hardware element by hovering the mouse over the **Domain Memo**  icons to display the Cell infotip.

See Table 28 *NovaScale SMP Server Domain Cell Resources*, on page 4-44 and Table 29 *NovaScale Partitioned Server Domain Cell Resources*, on page 4-45.

- If the domain is operating normally, **RUNNING** is displayed in the **Domain State** field.
- If the domain has been automatically powered down, **INACTIVE** is displayed in the **Domain State** field.

See Table 27. *System Functional Status / Expected Domain State*, on page 4-43 and Chapter 3. *Managing Domains*, on page 3-1.



Warning:

If system functional status is critical (flashing red icon), immediately save data, close open applications and shut down the domain Operating System.

3. Toggle the **PAM Tree** to view hardware functional status (round, colored indicator next to the **Hardware Monitor** node). The PAM Tree will automatically expand down to the faulty hardware element.
4. Check domain state by clicking **Domain Manager** in the PAM tree.

System Functional Status / Expected Domain State





Icon	System Functional Status	Expected Domain State
 Green	NORMAL	RUNNING
 Yellow	WARNING	RUNNING
 Orange Flashing	CRITICAL	<p>INACTIVE (auto Power OFF) / RUNNING An automatic Power OFF request may be sent by PAM software to the domain Operating System:</p> <ul style="list-style-type: none"> - If the domain Operating System is configured to accept PAM Power OFF requests, it automatically saves data, closes open applications and shuts down. - If the Operating System is not configured to accept PAM Power OFF requests, you are advised to manually save data, close open applications and shut down the Operating System. <p>Note: When system functional status is FATAL, the icon does not always remain red. Therefore, an orange functional status icon may indicate a FATAL hardware status.</p>
 Red Flashing	FATAL	<p>INACTIVE An automatic Force Power OFF command may be performed by PAM software on the domain Operating System.</p> <p>Note: The Operating System does not have time to save data and close applications before it is shut down.</p>
 Purple	NOT ACCESSIBLE	INACTIVE

Table 27. CSS functional status / domain state

5. Click the faulty hardware element to open the corresponding **Hardware Status** page.
6. Check **Power** and **Temperature** tabs. If a power and/or temperature indicator is NOT green, a power- and/or temperature-specific fault has occurred. See *Power Status Indicators* and *Temperature Status Indicators*, on page 4-18.
7. Click **Display Faults List** for direct access to server logs. If the **Display Faults List** button is not accessible, click **History Manager** → **System** → **PAM History** for the corresponding log. See *Viewing Detailed Hardware Status*, on page 4-15.
8. Expand the log for direct access to the corresponding **Help File** (at the bottom of the page). The **Help File** explains the message and how to deal with the incident.



Important:

To maintain a trace of transient faults, PAM Tree functional and/or presence status indicators will not change color until the domain has been powered OFF/ON, even although the error has been corrected.

The following tables list server domain cell resources.

NovaScale SMP Server Domain Cell Resources

NovaScale 5085 SMP Server	
Cell 0	Module0_IOC0, Module0_QBB0, Module0_DIB0
Cell 1	Module0_QBB1
NovaScale 5165 SMP Server	
Cell 0	Module0_IOC0, Module0_QBB0, Module0_DIB0
Cell 1	Module0_QBB1
Cell 2	Module1_QBB0
Cell 3	Module1_QBB1
NovaScale 5245 SMP Server	
Cell 0	Module0_IOC0, Module0_QBB0, Module0_DIB0
Cell 1	Module0_QBB1
Cell 2	Module1_QBB0
Cell 3	Module1_QBB1
Cell 4	Module2_QBB0
Cell 5	Module2_QBB1
NovaScale 5325 SMP Server	
Cell 0	Module0_IOC0, Module0_QBB0, Module0_DIB0
Cell 1	Module0_QBB1
Cell 2	Module1_QBB0
Cell 3	Module1_QBB1
Cell 4	Module2_QBB0
Cell 5	Module2_QBB1
Cell 6	Module3_QBB0
Cell 7	Module3_QBB1

Table 28. NovaScale SMP server domain cell resources

NovaScale Partitioned Server Domain Cell Resources

NovaScale 5085 Partitioned Server	
Cell 0	Module0_IOC0, Module0_QBB0, Module0_DIB0
Cell 1	Module0_IOC1, Module0_QBB1, Module0_DIB1
NovaScale 5165 Partitioned Server	
Cell 0	Module0_IOC0, Module0_QBB0, Module0_DIB0
Cell 1	Module0_IOC1, Module0_QBB1, Module0_DIB1
Cell 2	Module1_IOC0, Module1_QBB0, Module0_DIB0
Cell 3	Module1_IOC1, Module1_QBB1, Module0_DIB1
NovaScale 5245 Partitioned Server	
Cell 0	Module0_IOC0, Module0_QBB0, Module0_DIB0
Cell 1	Module0_IOC1, Module0_QBB1, Module0_DIB1
Cell 2	Module1_IOC0, Module1_QBB0, Module0_DIB0
Cell 3	Module1_IOC1, Module1_QBB1, Module0_DIB1
Cell 4	Module2_IOC0, Module2_QBB0, Module0_DIB0
Cell 5	Module2_IOC1, Module2_QBB1, Module0_DIB1
NovaScale 5325 Partitioned Server	
Cell 0	Module0_IOC0, Module0_QBB0, Module0_DIB0
Cell 1	Module0_IOC1, Module0_QBB1, Module0_DIB1
Cell 2	Module1_IOC0, Module1_QBB0, Module0_DIB0
Cell 3	Module1_IOC1, Module1_QBB1, Module0_DIB1
Cell 4	Module2_IOC0, Module2_QBB0, Module0_DIB0
Cell 5	Module2_IOC1, Module2_QBB1, Module0_DIB1
Cell 6	Module3_IOC0, Module3_QBB0, Module0_DIB0
Cell 7	Module3_IOC1, Module3_QBB1, Module0_DIB1

Table 29. NovaScale partitioned server domain cell resources

Dealing with Incidents

When you open the incident **Help File**, you may be requested to perform straightforward checks and actions or to contact your Customer Service Engineer. This section explains how to respond to the following requests:

- *Check Environmental Conditions*
- *Check Hardware Availability*
- *Check Hardware Connections*
- *Exclude a Hardware Element*
- *Check Hardware Exclusion Status*
- *Check Hardware Fault Status*
- *Check Power Status*
- *Check Temperature Status*
- *Check Histories and Events*
- *Check SNMP Settings*
- *Check Autocall Settings*
- *Check PAM Version*
- *Check MAESTRO Version*
- *Check Writing Rules*
- *Power ON/OFF the Domain*
- *Reboot the PAP Application*
- *Modify LUN Properties*
- *Check, Test, and Reset the PMB*
- *Create an Action Request Package*

Checking Environmental Conditions

If you are requested to check environmental conditions, ensure that the computer room is compliant with the specifications set out in **Appendix A.Specifications**.

Checking Hardware Availability

If you are requested to check hardware availability:

1. Check that the CSS module availability status bar is green. If the status bar is not green, the CSS module has not been detected by PAM software. Check the physical PMB to PAP unit Ethernet link connection.
2. Toggle the **PAM Tree** to view hardware presence status (square, colored indicator next to the **Hardware Monitor** node).
3. Expand the **Hardware Monitor** node to view the presence status of all hardware elements. If a hardware presence status indicator is NOT green, the hardware element is either missing or not accessible.



Important:

If a PAM Tree hardware presence status indicator is not green, this could be normal if the corresponding hardware element has been removed for maintenance.

Checking Hardware Connections

If you are requested to check hardware connections, manually and visually ensure that all cables are correctly inserted in their corresponding hardware ports. See *Cabling Guide*, 86 A1 34ER.

Excluding a Hardware Element and Checking Exclusion Status

As Customer Administrator, you can logically **Exclude** a redundant hardware element from the domain until it has been repaired or replaced. Exclusion is taken into account at the next domain power ON. See *Excluding / Including Hardware Elements*, on page 4-23.

If you are requested to check hardware exclusion status, use the **Hardware Search** engine to search for and view **Excluded** hardware elements. See *Using the Hardware Search Engine*, on page 4-10.

You can also view domain hardware exclusion status from the **Domain Hardware Details** page. See *Viewing Domain Configuration, Resources and Status*, on page 3-35.

Checking Hardware Fault Status

If you are requested to check hardware fault status:

1. Click the corresponding hardware element in the PAM Tree to open the **Hardware Status** page.
2. Check the **General** tab. If the fault status indicator is NOT green, a fault has occurred. See *Fault Status Indicators*, on page 4-16.

Checking Hardware Power Status

If you are requested to check hardware power status:

1. Click the corresponding hardware element in the PAM Tree to open the **Hardware Status** page.
2. Check the **Power** tab. If a power indicator is NOT green, a power-specific fault has occurred. See *Power Status Indicators*, on page 4-18.

Checking Hardware Temperature Status

If you are requested to check temperature status:

1. Click the corresponding hardware element in the PAM Tree to open the **Hardware Status** page.
2. Check the **Temperature** tab. If a temperature indicator is NOT green, a temperature-specific fault has occurred. See *Temperature Status Indicators*, on page 4-20.

Checking Histories and Events

If you are requested to check histories / events, refer to *Viewing and Managing PAM Event Messages and History Files*, on page 4-31.

Checking SNMP Settings

If you are requested to check SNMP settings, IP address, or server name for an event subscription:

1. From the PAM Tree, click **Configuration Tasks** → **Events** → **Channels** and check that the **SNMP Channel** is enabled.
2. Click **Subscriptions** to view configured subscriptions. Channel type is indicated in the **Channel** column.
3. Select the required **SNMP Channel** subscription from the list and click **Edit** to view / modify **SNMP** settings.

Checking Autocall Settings

If you are requested to check Autocall settings:

1. From the PAM Tree, click **Configuration Tasks** → **Autocalls** and check that the **Enable Autocalls** checkbox is selected.
2. Check dispatch modes and corresponding settings.

Checking PAM Version

If you are requested to check PAM version:

From the PAM Tree, click **PAP** to display the **PAP Unit Information** page. PAM version is displayed at the top of the page.

Checking MAESTRO Version

If you are requested to check MAESTRO version:

From the PAM Tree, click **Hardware Monitor** → **PMB** to open the **PMB Status** page. Click the **FIRMWARE** tab to view MAESTRO version.

Checking Writing Rules

If you are requested to check writing rules, see *PAM Writing Rules, on page xx*.

Powering OFF/ON a Domain

If you are requested to Power OFF/ON or Force Power OFF a domain, ensure that you have saved data and closed open applications.

See *Managing Domains, on page 3-1*.

Rebooting the PAP Application

If you are requested to reboot the PAP application:

1. From the Microsoft Windows home page, click **Start** → **Programs** → **Administrative Tools** → **Component Services**.
2. From **Component Services**, click **Console Root** → **Component Services** → **Computers** → **My Computer** → **COM+ Applications** → **PAP**.
3. Right click **PAP** to open the shortcut menu. Click **Shutdown**.
4. Activate the required PAM version to reboot the PAP application.
See *Deploying a New PAM Release, on page 5-23* and *Activating a PAM Version, on page 5-24*.

Modifying LUN Properties

If you are requested to modify LUN properties:

- Refer to **Configuring Disks, on page 5-5** and to the appropriate Disk Subsystem documentation.

Checking, Testing and Resetting the PMB

The PMB is located in the module at the base of the cabinet and links the server to the PAP unit via an Ethernet link. You may be required to carry out the following checks / actions:

- **Check that PMB LED #0 is blinking green** (PMB booted correctly):
When the system is powered on, the 7 activity and status LEDs (LED #1-LED #7) are switched off and LED #0 is blinking. **See *PMB Leds and Code Wheels, on page 4-50.***
- **Check PMB code wheel settings.** **See *PMB Leds and Code Wheels, on page 4-50.***
- Check that the Ethernet cable linking the server to the PAP unit is correctly inserted and that the Ethernet link LED is green.
- Check the PAP - PMB link by pinging the PAP and the PMB:

PAP Address	PMB 0 Address	PMB 1 Address	PMB 2 Address	PMB 3 Address
10.10.240.240	10.10.0.1	10.10.0.2	10.10.0.3	10.10.0.4

- Reset the PMB by pressing the RESET button. PMB firmware will be rebooted. **See *PMB Leds and Code Wheels, on page 4-50.***

PMB LEDs and Code Wheels

Up to 16 Central Subsystems can be linked, via Platform Management Boards (PMBs) to a single PAP unit, to provide a single point of administration and maintenance.

Each PMB is equipped with two code wheels used to identify each Central Subsystem and each CSS module in your configuration. These code wheels are set prior to shipping (factory default setting), according to configuration.

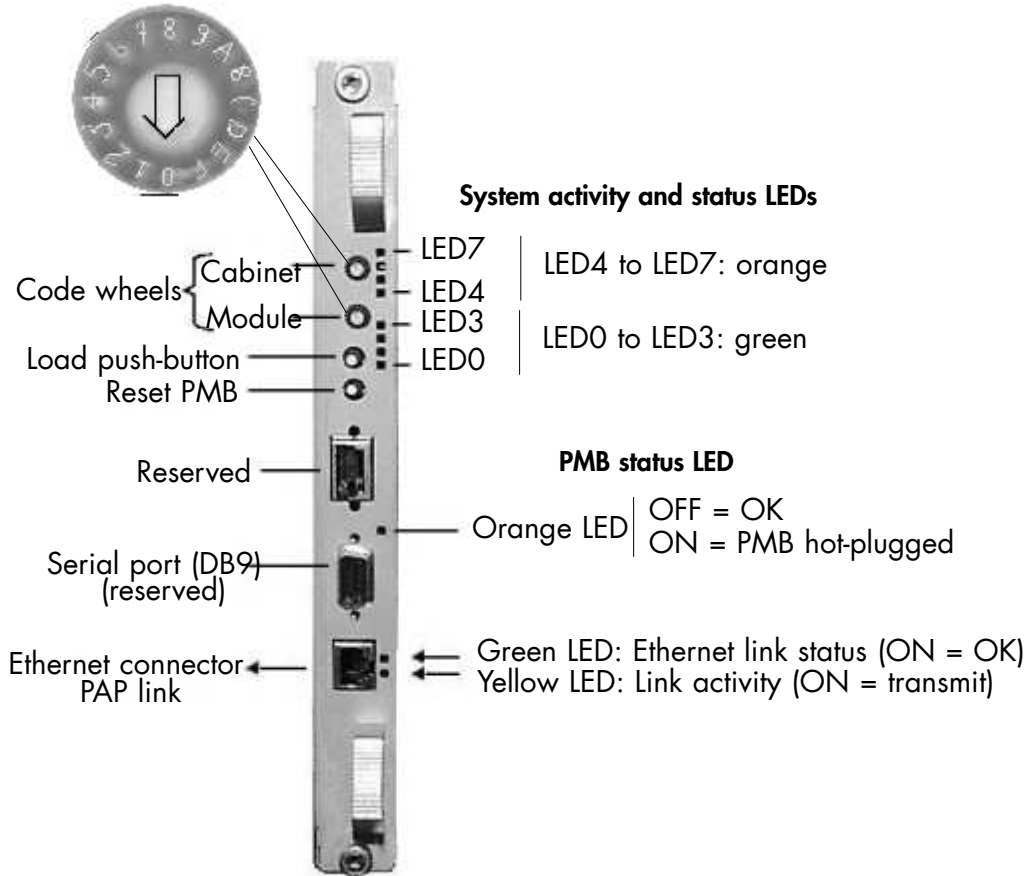

For guidance, PMB code wheel settings are indicated in the following table:

CSS	CSS PMB Code Wheel	PAM CSS HW Identifier	CSS Module PMB Code Wheel	
			CSS Module 0	CSS Module 1
1st	0	00	0	1
2nd	1	01	0	1
3rd	2	02	0	1
4th	3	03	0	1
5th	4	04	0	1
6th	5	05	0	1
7th	6	06	0	1
8th	7	07	0	1
9th	8	08	0	1
10th	9	09	0	1
11th	A	10	0	1
12th	B	11	0	1
13th	C	12	0	1
14th	D	13	0	1
15th	E	14	0	1
16th	F	15	0	1

Figure 91. PMB LED location

Creating an Action Request Package

PAM software allows you to collect all the files required to troubleshoot a Bull NovaScale Server via the **Action Request Package** tool. Once collected, files are compressed to ZIP format for easy transfer to the BULL Remote Maintenance Center.



Note:

Before PAM Release 8, use the **BackUpRestore** utility to copy and restore the files stored in the **PAM SiteData** directory.

Creating a Default Action Request Package

1. From the **PAM Tree** pane, click **Downloads** to open the Control pane.

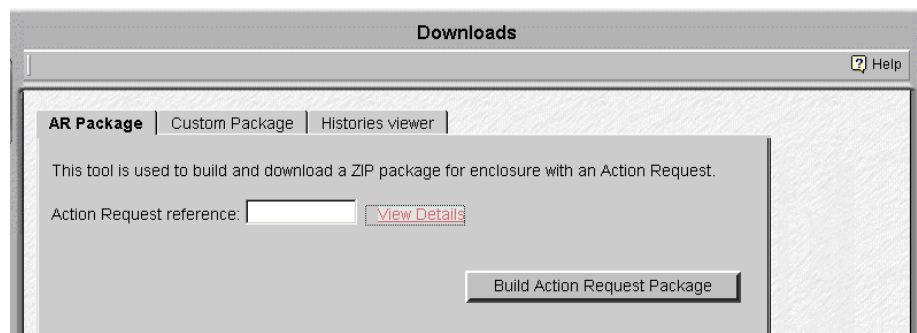

Figure 92. Action Request Package control pane

2. Select the **AR Package** tab and enter the **Action Request reference** given by the Customer Support Center.
3. Click **Build Action Request package** to collect, compress and download ALL the files contained in the various directories.
4. Transfer the ZIP to the BULL Remote Maintenance Center for analysis.

Creating a Filtered Action Request Package



Important:

To ensure the consistency of Action Request Package contents, you are advised to only use filtering options if specifically required.

1. From the **PAM Tree** pane, click **Downloads** to open the Control pane.
2. Select the **AR Package** tab and enter the **Action Request reference** given by the Customer Support Center.
3. Click **Show Details** to display filtering options.

The screenshot shows a window titled 'Downloads' with a 'Help' button. Inside, there are tabs for 'AR Package', 'Custom Package', and 'Histories viewer'. The 'AR Package' tab is active. Below the tabs, there is a text area for 'AR description' and a text box for 'AR reference' with a 'Hide Details' link. A table-like structure is used to organize filtering options:

Current Files	Archived Files
<input checked="" type="checkbox"/> Windows Event Log : Application* <input checked="" type="checkbox"/> Windows Event Log : Security* <input checked="" type="checkbox"/> Windows Event Log : System* <input checked="" type="checkbox"/> Current History files <small>* Requires Administrator privileges</small>	From (MM-DD-YYYY) <input type="text" value="2/21/2006"/> To (MM-DD-YYYY) <input type="text" value="2/24/2006"/> <input checked="" type="checkbox"/> Archived History files <input checked="" type="checkbox"/> Logs <input checked="" type="checkbox"/> Error Report

At the bottom of the form are buttons for 'Set Default Values' and 'Build Action Request Package'.

Filterable File Types	Action	Dates
Current Files		
Windows Event Log: Application	These files are selected by default. If you do not want to include these files, deselect the corresponding checkboxes.	All current Windows Event Log files.
Windows Event Log: Security		
Windows Event Log: System		
Current History Files		All history files in the PAM Site Directory.
Archived Files		
Archived History Files	These files are selected by default. If you do not want to include these files, deselect the corresponding checkboxes.	Default dates: Today + 3 preceding days. Enter new From / To dates to include archives outside the default dates.
Logs		
Error Reports		

Figure 93. Action Request Package details

4. Clear filterable checkboxes as required and/or change archive collection dates.
5. Click **Build Action Request package** to collect, compress and download files.
6. Transfer the ZIP file to the BULL Remote Maintenance Center for analysis.

Creating a Custom Package

PAM software allows you to collect one or more selected files from the PAM Site Data Directory via the **Custom Package** tool. Once collected, files are compressed to ZIP format.

This option allows you to precisely select the files you want to collect and download for analysis.

To create a Custom Package:

1. From the **PAM Tree** pane, click **Downloads** to open the Control pane.

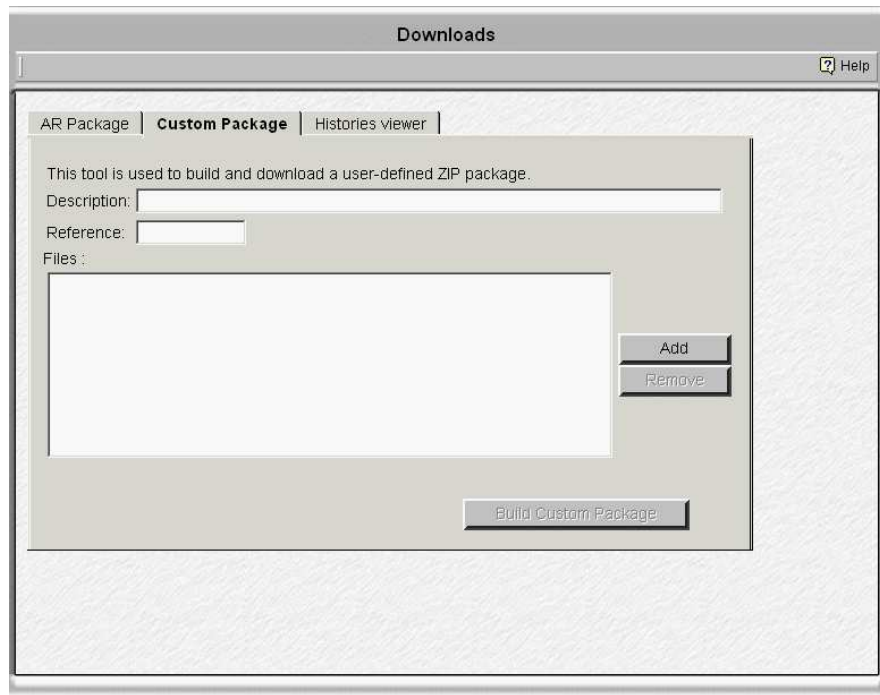

Figure 94. Custom Package control pane

2. Select the **Custom Package** tab and enter the **Custom Package reference**.
3. Click **Add** to select the PAM Site Data files to be included in the package.

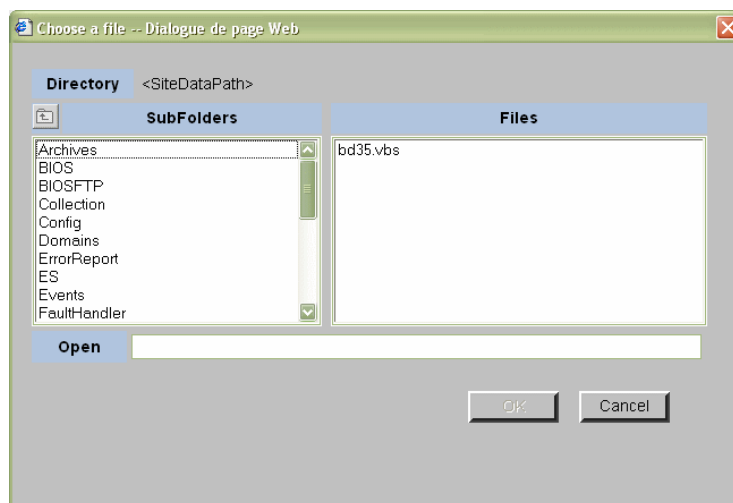

Figure 95. Custom Package Add files pane

4. Click **Build Custom Package** to collect, compress and download the selected files.
5. Save the resulting ZIP file as required.

Chapter 5. Tips and Features for Administrators

This chapter explains how, as Customer Administrator, you can configure the server to suit your working environment. It includes the following sections:

- Section I - Setting up Server Users and Configuring Disks, on page 5-3
- Section II - Using EFI Utilities, on page 5-6
- Section III - Customizing PAM Software, on page 5-16
- Section IV - Configuring Domains, see page 5-28
- Section V - Creating Event Subscriptions and User Histories, on page 5-132



Notes:

Customer Administrators and Customer Operators are respectively advised to consult the *Administrator's Memorandum*, on page xxiii or the *Operator's Memorandum*, on page xxv for a detailed summary of the everyday tasks they will perform.

Before proceeding to configure the server, please refer to *PAM Writing Rules*, on page xx.

For further information about user accounts and passwords, see *Setting up PAP Unit Users*, on page 5-17.



Important:

Certain domain configuration and management tools are reserved for use with partitioned servers, extended systems and/or a Storage Area Network(SAN).

Please contact your Bull Sales Representative for sales information.

Section I - Setting up Users and Configuring Data Disks

This section explains how to:

- Set up Server Users, on page 5-4
- Configure System and Data Disks, on page 5-5

Setting up Server Users

As Customer Administrator, you must set up user accounts and passwords to control access to the server.

The operating system pre-installed on the server provides standard security features for controlling access to applications and resources.

For further details, refer to the Microsoft Windows / Linux documentation, as applicable.



Note:

You are advised to maintain a detailed record of authorized users.

Microsoft Windows

Default user access control is not pre-configured on systems running under Microsoft Windows.

You are advised to set up the Administrator account before proceeding to set up users and groups via the standard Microsoft Windows administration tools.

Linux

Two default users are pre-configured on systems running under Linux:

	User Name	Password
Administrator	root	root
User	linux	root

You are advised to change the default Administrator name and password before proceeding to set up users and groups via the standard Linux administration tools.

Configuring System and Data Disks

Optionally, for optimum storage, security and performance, the server may be delivered with pre-configured disk racks.

New system and/or data disks can be created via the utility delivered with the storage sub-system.



Note:

For further details about configuring system and data disks, refer to the appropriate Disk Subsystem documentation.

Creating New FC Logical System or Data Disks

Optionally, the server may be delivered with one or two disk rack(s) each containing two RAID #1 system disks per domain and one pool spare disk, and offering ten free slots for data disks. Slots are numbered from 0 to 14 (from left to right).

For optimum storage, performance, and reliability, you are advised to use RAID level 1 for system disk configuration and RAID level 5 for data disk configuration.

To create a new logical system or data disk:

1. From the Microsoft Windows desktop on the PAP unit, launch iSM Client.
2. Follow the instructions on the screen.

Section II - Using EFI Utilities

This section explains how to:

- Use the EFI Boot Manager, on page 5-7
- Use the EFI Shell, on page 5-9
- Use the EFI to Set up and Configure a Network, on page 5-14
- Use the EFI to Load FTP Server / Client, on page 5-15

Using the EFI Boot Manager

The EFI (Extensible Firmware Interface) Boot Manager allows you to control the server's booting environment. From the Boot Manager, you can choose to invoke the Extensible Firmware Interface (EFI) Shell or to go to the Boot Option Maintenance Menu.

To enter the EFI Boot Manager:

1. From the PAM Tree, click **Domain Manager** → **Power ON** to power up the required domain.
2. From the keyboard, press the **Control** key twice to display the KVM Switch Command Menu.
3. Select the required system channel port with the ↑↓ keys, according to configuration. See *KVM port configuration*, in the User's Guide.
4. Press **Enter** to activate the required system channel and exit the Command Mode.



Note:

The system automatically boots on the first option in the list without user intervention after a timeout. To modify the timeout, use **Set Auto Boot Timeout** in the Boot Option Maintenance Menu.

5. From the Boot Manager Menu, select the EFI Shell option with the ↑↓ keys and press **Enter**.

EFI Boot Manager Options

EFI Shell

A simple, interactive environment that allows EFI device drivers to be loaded, EFI applications to be launched, and operating systems to be booted. The EFI shell also provides a set of basic commands used to manage files and the system environment variables. For more information on the EFI Shell, refer to **Using the EFI Shell on page 5-9**.

Boot Options

Files that you include as boot options. You add and delete boot options by using the Boot Maintenance Menu. Each boot option specifies an EFI executable with possible options. For information on the Boot Maintenance Menu options, refer to **Table 30**.

Boot Option Maintenance Menu

The EFI Boot Maintenance Manager allows the user to add boot options, delete boot options, launch an EFI application, and set the auto boot time out value.

If there are no boot options in the system (and no integrated shell), the Boot Maintenance Menu is presented. If boot options are available, then the set of available boot options is displayed, and the user can select one or choose to go to the Boot Maintenance Menu.

If the time out period is not zero, then the system will auto boot the first boot selection after the time out has expired. If the time out period is zero, then the EFI Boot Manager will wait for the user to select an option. **Table 30** describes each menu item in the Boot Maintenance Menu.



Note:

You can use the → ← ↑↓ keys to scroll through the Boot Maintenance Menu.

Boot Option	Description
Boot from a File	<p>This option searches all the EFI System Partitions in the system.</p> <p>For each partition it looks for an EFI directory. If the EFI directory is found, it looks in each of the subdirectories below EFI.</p> <p>In each of those subdirectories, it looks for the first file that is an executable EFI Application.</p> <p>Each of the EFI Applications that meet this criteria are automatically added as a possible boot option. In addition, legacy boot options for A: and C: are also added if those devices are present.</p> <p>This option allows the user to launch an application without adding it as a boot option.</p> <p>The EFI Boot Manager will search the root directories and the \EFI\TOOLS directories of all of the EFI System Partitions present in the system for the specified EFI Application.</p>
Add a Boot Option	<p>Allows the user to specify the name of the EFI Application to add as a boot option.</p> <p>The EFI Boot Manager searches the same partitions and directories as described in <i>Boot from a File</i>, until it finds an EFI Application with the specified name.</p> <p>This menu also allows the user to provide either ASCII or UNICODE arguments to the option that will be launched.</p>
Delete Boot Options	<p>Allows you to delete a specific boot option or all boot options. Highlight the option you want to delete and enter <d>. Enter <y> to confirm.</p>
Change Boot Order	<p>Allows you to control the relative order in which the EFI Boot Manager attempts boot options. To change the boot order, highlight the boot option and enter <u> to move the item up one order, <d> to move the item down one order. For help on the control key sequences you need for this option, refer to the help menu.</p>
Manage Boot Next Setting	<p>Allows you to select a boot option to use one time (the next boot operation).</p>
Set Auto Boot Timeout	<p>Allows you to define the value in seconds that pass before the system automatically boots without user intervention. Setting this value to zero disables the timeout feature.</p>
Cold Reset	<p>Performs a platform-specific cold reset of the system. A cold reset traditionally means a full platform reset.</p>
Exit	<p>Returns control to the EFI Boot Manager main menu. Selecting this option will display the active boot devices, including a possible integrated shell (if the implementation is so constructed).</p>

Table 30. Boot Option Maintenance Menu

Using the EFI Shell

The EFI (Extensible Firmware Interface) Shell is a simple, interactive user interface that allows EFI device drivers to be loaded, EFI applications to be launched, and operating systems to be booted. In addition, the Shell provides a set of basic commands used to manage files and the system environment variables.

The EFI Shell supports command line interface and batch scripting.

Entering the EFI Shell

To enter the EFI Shell:

1. From the PAM Tree, click **Domain Manager** → **Power ON** to power up the required domain.
2. From the keyboard, press the **Control** key twice to display the KVM Switch Command Menu.
3. Select the required system channel port with the ↑↓ keys, according to configuration. See *KVM port configuration*, in the User's Guide.
4. Press **Enter** to activate the required system channel and exit the Command Mode. After a few seconds, the Boot Manager menu is displayed.
5. From the Boot Manager Menu, select the EFI Shell option with the ↑↓ keys and press **Enter**.

When the EFI Shell is invoked, it first looks for commands in the file *startup.nsh* on the execution path defined by the environment. There is no requirement for a startup file to exist. Once the startup file commands are completed, the Shell looks for commands from console input device.

Note:

The system automatically boots on the first option in the list without user intervention after a timeout. To modify timeout, use **Set Auto Boot Timeout** in the Boot Option Maintenance Menu.

EFI Shell Command Syntax

The EFI Shell implements a programming language that provides control over the execution of individual commands. When the Shell scans its input, it always treats certain characters specially: (**#**, **>**, **%**, *****, **?**, **[**, **^**, **space**, and **newline**).

When a command contains a defined alias, the Shell replaces the alias with its definition (see **alias** command in this chapter). If the argument is prefixed with the **^** character, however, the argument is treated as a literal argument and alias processing is not performed.

Note:

In interactive execution, the Shell performs variable substitution, then expands wildcards before the command is executed.

In batch script execution, the Shell performs argument substitution, then variable substitution, then expands wildcards before the command is executed.

Variable Substitution

Environment variables can be set and viewed through the use of the **set** command (see **set** command in this chapter). To access the value of an environment variable as an argument to a Shell command, delimit the name of the variable with the **%** character before and after the variable name; for example, **%myvariable%**.

The Shell maintains a special variable, named **!asterror**. The variable contains the return code of the most recently executed Shell command.

Wildcard Expansion

The *, ? and [characters can be used as wildcard characters in filename arguments to Shell commands.

If an argument contains one or more of these characters, the Shell processes the argument for **file meta-arguments** and expands the argument list to include all filenames matching the pattern.

These characters are part of patterns which represent file and directory names.

Character Sequence	Meaning
"*"	Matches zero or more characters in a file name
"?"	Matches exactly one character of a file name
"[chars]"	Defines a set of characters; the pattern matches any single character in the set. Characters in the set are not separated. Ranges of characters can be specified by specifying the first character in a range, then the - character, then the last character in the range. Example: [a-zA-Z]

Table 31. Wildcard character expansion

Output Redirection

Output of EFI Shell commands can be redirected to files, according to the following syntax:

Command	Output Redirection
> unicode_output_file_pathname	standard output to a unicode file
>a ascii_output_file_pathname	standard output to an ascii file
!> unicode_output_file_pathname	standard output to a unicode file
!>a ascii_output_file_pathname	standard output to an ascii file
2> unicode_output_file_pathname	standard error to a unicode file
2>a ascii_output_file_pathname	standard error to an ascii file
>> unicode_output_file_pathname	standard output appended to a unicode file
>>a ascii_output_file_pathname	standard output appended to an ascii file
!>> unicode_output_file_pathname	standard output appended to a unicode file
!>>a ascii_output_file_pathname	standard output appended to an ascii file

Table 32. Output redirection syntax

The Shell will redirect standard output to a single file and standard error to a single file. Redirecting both standard output and standard error to the same file is allowed. Redirecting Standard output to more than one file on the same command is not supported. Similarly, redirecting to multiple files is not supported for standard error.

Quoting

Quotation marks in the EFI Shell are used for argument grouping. A quoted string is treated as a single argument to a command, and any whitespace characters included in the quoted string are just part of that single argument.

Quoting an environment variable does not have any effect on the de-referencing of that variable. Double quotation marks "" are used to denote strings. Single quotation marks are not treated specially by the Shell in any way. Empty strings are treated as valid command line arguments.

Executing Batch Scripts

The EFI Shell has the capability of executing commands from a file (batch script). EFI Shell batch script files are named using the `.nsh` extension. Batch script files can be either UNICODE or ASCII format files. EFI Shell script files are invoked by entering the filename at the command prompt, with or without the filename extension.

Up to nine (9) positional arguments are supported for batch scripts. Positional argument substitution is performed before the execution of each line in the script file. Positional arguments are denoted by `%n`, where `n` is a digit between 0 and 9. By convention, `%0` is the name of the script file currently being executed. In batch scripts, argument substitution is performed first, then variable substitution. Thus, for a variable containing `%2`, the variable will be replaced with the literal string `%2`, not the second argument on the command line. If no real argument is found to substitute for a positional argument, then the positional argument is ignored. Script file execution can be nested; that is, script files may be executed from within other script files. Recursion is allowed.

Output redirection is fully supported. Output redirection on a command in a script file causes the output for that command to be redirected. Output redirection on the invocation of a batch script causes the output for all commands executed from that batch script to be redirected to the file, with the output of each command appended to the end of the file.

By default, both the input and output for all commands executed from a batch script are echoed to the console. Display of commands read from a batch file can be suppressed via the `echo -off` command (see `echo`). If output for a command is redirected to a file, then that output is not displayed on the console. Note that commands executed from a batch script are not saved by the Shell for DOSkey history (up-arrow command recall).

Error Handling in Batch Scripts

By default, if an error is encountered during the execution of a command in a batch script, the script will continue to execute.

The `!asterror` Shell variable allows batch scripts to test the results of the most recently executed command using the `if` command. This variable is not an environment variable, but is a special variable maintained by the Shell for the lifetime of that instance of the Shell.

Comments in Script Files

Comments can be embedded in batch scripts. The `#` character on a line is used to denote that all characters on the same line and to the right of the `#` are to be ignored by the Shell. Comments are not echoed to the console.

EFI Shell Commands

Most Shell commands can be invoked from the EFI Shell prompt. However there are several commands that are only available for use from within batch script files.

Note:

The "Batch-only" column indicates if the command is only available from within script files. The following sections provide more details on each of the individual commands. Command `help command_name` displays the details of the `command_name`.

Command	Batch only	Description
alias	No	Displays, creates, or deletes aliases in the EFI Shell
attrib	No	Displays or changes the attributes of files or directories
bcfg	No	Displays/modifies the driver/boot configuration
break	No	Executes a break point
cd	No	Displays or changes the current directory
cls	No	Clears the standard output with an optional background color
comp	No	Compares the contents of two files
connect	No	Binds an EFI driver to a device and starts the driver
cp	No	Copies one or more files/directories to another location
date	No	Displays the current date or sets the date in the system
dblk	No	Displays the contents of blocks from a block device
devices	No	Displays the list of devices being managed by EFI drivers
devtree	No	Displays the tree of devices that follow the EFI Driver Model
dh	No	Displays the handles in the EFI environment
disconnect	No	Disconnects one or more drivers from a device
dmem	No	Displays the contents of memory
dmpstore	No	Displays all NVRAM variables
drivers	No	Displays the list of drivers that follow the EFI Driver Model
drvcfg	No	Invokes the Driver Configuration Protocol
drvdiag	No	Invokes the Driver Diagnostics Protocol
echo	No	Displays messages or turns command echoing on or off
edit	No	Edits an ASCII or UNICODE file in full screen.
err	No	Displays or changes the error level
exit	No	Exits the EFI Shell
for/endfor	Yes	Executes commands for each item in a set of items
goto	Yes	Makes batch file execution jump to another location
guid	No	Displays all the GUIDs in the EFI environment
help	No	Displays commands list or verbose help of a command
hexedit	No	Edits with hex mode in full screen
if/endif	Yes	Executes commands in specified conditions
load	No	Loads EFI drivers
loadbmp	No	Displays a Bitmap file onto the screen
ls	No	Displays a list of files and subdirectories in a directory
map	No	Displays or defines mappings
memmap	No	Displays the memory map
mkdir	No	Creates one or more directories
mm	No	Displays or modifies MEM/IO/PCI
mode	No	Displays or changes the mode of the console output device

Command	Batch only	Description
mount	No	Mounts a file system on a block device
mv	No	Moves one or more files/directories to destination
openInfo	No	Displays the protocols on a handle and the agents
pause	No	Prints a message and suspends for keyboard input
pci	No	Displays PCI devices or PCI function configuration space
reconnect	No	Reconnects one or more drivers from a device
reset	No	Resets the system
rm	No	Deletes one or more files or directories
set	No	Displays, creates, changes or deletes EFI environment variables
stall	No	Stalls the processor for some microseconds
time	No	Displays the current time or sets the time of the system
type	No	Displays the contents of a file
unload	No	Unloads a protocol image
ver	No	Displays the version information
vol	No	Displays volume information of the file system

Table 33. List of EFI Shell Commands

EFI Network Setup and Configuration

The EFI (Extensible Firmware Interface) Utilities delivered with the system provide a complete set of TCP/IPv4 network stack and configuration tools. Ethernet adapters utilizing 6 bit UNDI option ROMs are supported.



Important:

To access this feature, please connect the Enterprise network to the embedded Ethernet board on the IOR of the domain master IO board. Intel PRO 1000T and 1000F adapters are not supported.



Note:

These utilities are installed in the EFI partition of the system disk in the EFI\Tools directory. The list and respective manual pages for each utility can be found on the Bull NovaScale Server Resource CD-Rom.

Network stack configuration commands must be executed after booting to EFI Shell. To simplify network setup, these commands should be grouped, via an EFI batch script, to form a single one-line command.

Manual EFI Network Configuration

1. Load the TCP/IP protocol via the EFI **load** command.



Note:

As the **load** command does not use the search path to locate protocols, specify the path and the **.efi** extension.

```
fso:\efi\tools\tcpipv4.efi
```

2. Configure the network interfaces with the **ifconfig** command:

The simple form of the command is:

```
ifconfig <interface> inet <ip address> up
```

where *<ip address>* is the address assigned to the system. If the system is connected to a network that uses subnetting, a subnet mask would also need to be specified as follows:

```
ifconfig sni0 inet <ip address> netmask <netmask> up
```

where *<netmask>* is the network mask assigned to the network.



Note:

The TCP/IP stack contains a "lo0" loopback interface which can be optionally be configured with the "sni0" Ethernet interface if a compatible UNDI Ethernet adapter is installed. Configuration is performed with the **ifconfig** command.

3. If multiple network or subnetwork networking is required, set a gateway address for the appropriate gateway(s) attached to the network, via the **route** command as follows:

```
route add <destination> <gateway ip address>
```

where *<destination>* specifies the target network or host and *<gateway ip address>* specifies the network gateway address responsible for routing data to the destination.

If **default** is used for *<destination>*, a default route will be set.

Example Network Configuration Batch File

An example network configuration batch file named **NetConf.nsh** is installed in the EFI directory of the EFI Service Partition.

This file loads the TCP/IP, configures the Ethernet interface to the IP address given as first argument to this file, configures the optional second argument as the gateway, and loads the FTP Server (daemon).

```
echo -off
if %1empty == empty then
  echo usage netconf {local ip-addr} [router ip addr]
  goto End
endif
load fs0:\efi\tools\tcpipv4.efi
ifconfig sni0 %1 netmask 255.255.255.0
if not %2empty == empty then
  route add default %2
endif
load fs0:\EFI\Tools\ftpd.efi
:End
```

Note:

The IP addresses and netmask indicated in this file and in the following example are only examples and must be modified to reflect site network configuration:

```
fs0:\> Netconf 129.182.189.3 129.182.189.1
129.182.189.3 is the <ip address>
129.182.189.1 is the <gateway ip address>
```

File Transfer Protocol (FTP)

An FTP Client and an FTP Server are provided with the EFI Utilities.

1. Configure the network. See *Manual Network Configuration*.
2. Load the FTP Server via the EFI **load** command.
3. Load the FTP Client via the EFI **ftp** command. This Client supports most ftp directives (open, get, put, ...). Use the **help** directive if you need help.

Note:

As the **load** command does not use the search path to locate protocols, specify the path if it is not in the current working directory and the **.efi** extension.

```
load fs0:\efi\tools\ftpd.efi
```

The FTP Server is now available for use and accepts anonymous connections (one at a time).



Important:

Once the EFI drivers for the TCP/IP, the FTP Server or FTP Client are loaded, you cannot load an Operating System.

To load an Operating System, reset the domain and return to Boot Manager.

Section III - Customizing PAM Software

This section explains how to:

- Set up PAP Unit Users, on page 5-17
- Modify Customer Information, on page 5-19
- Configure Autocalls, on page 5-20
- Set Thermal Units, on page 5-22
- Deploy a New PAM Release, on page 5-23
- Activate a PAM Version, on page 5-24
- Back up and Restore PAM Configuration Files, on page 5-26

Setting up PAP Unit Users

As Customer Administrator, you must set up user accounts and passwords to control access to the PAP unit.

The Microsoft Windows operating system pre-installed on the PAP unit provides standard security features for controlling access to applications and resources. PAM software security is based on Windows® user management and you are advised to give Windows® administrator rights to at least one member of the PAP Customer Administrator user group. For further details about user management, refer to the Microsoft Windows documentation on the Bull NovaScale Server System Resource CD.



Note:

You are advised to change the temporary Administrator password (**administrator**) used for setup purposes and to maintain a detailed record of authorized users.

Predefined PAP User Groups

For optimum security and flexibility, the Microsoft Windows software environment is delivered with two predefined Customer user groups:

Pap_Customer_Administrators Group (CA)

This group is designed for customer representatives responsible for the overall management, configuration, and operation of the system. Members of the Customer Administrator group are allowed to configure and administrate the server and have full access to the PAM **Domain Manager**, **Hardware Monitor**, **History Manager** and **Configuration Tasks** menus, as shown in Table 34.

Pap_Customer_Operators (CO)

This group is designed for customer representatives responsible for the daily operation of the system. Members of the Customer Operator group are allowed to operate the server and have partial access to the **Domain Manager** and **History Manager** menus, as shown in Table 34.



Notes:

- Group membership also conditions which Event Messages a user will receive via the PAM Web interface. See *Setting up Event Subscriptions*, on page 5-134.
- The predefined Customer user groups have been designed to suit the needs of most Administrator and Operators. Contact your Customer Service Engineer if you require a customized user group.



Warning:

The two predefined Support user groups:

- **Pap_Support_Administrators**
- **Pap_Support_Operators**

are reserved EXCLUSIVELY for authorized Customer Service Engineers in charge of monitoring, servicing, and upgrading the system.

PAM Tools	Associated Actions	CA	CO
Domain Manager	Synchronize domains	X	X
	View/load a domain configuration scheme	X	X
	Add domains to the current domain configuration	X	X
	Replace the current domain configuration	X	X
	Delete domains from the current domain configuration	X	
	Save the current domain configuration snapshot	X	
	Power on/off and reset domains	X	X
	Forcibly power off domains	X	X
	Perform a domain memory dump	X	X
	View domain settings	X	X
	View domain configuration, resources and status	X	X
	View domain BIOS info and version	X	X
	View domain fault lists	X	X
	View domain power and request logs	X	X
View domain powering sequences	X	X	
Hardware Monitor	View hardware functional/presence status	X	
	View detailed hardware status information	X	
	Use the hardware Search engine	X	
	Exclude/include hardware components	X	
	View current PAM Web site user information	X	
	View PAM version information	X	
History Manager	View system history files, messages and fault lists	X	
	Manually archive system history files	X	
	View/delete system history archives	X	
	View user history files	X	X
	Manually archive user history files	X	X
	View/delete user history archives	X	X
Configuration Tasks	View/modify customer information	X	
	Create/modify/delete domain schemes and identities	X	
	Manage Logical Units	X	
	Check/update FC HBA World Wide Names	X	
	Limit access to hardware resources	X	
	Modify the system history automatic archiving policy	X	
	Create/delete user histories	X	
	Modify the user history automatic archiving policy	X	
	Customize the event messaging system	X	
	View/ modify PAM parameters	X	
	Display/modify autocall parameters	X	
	Exclude / include ring connections	X	
Status Pane	View/acknowledge WEB event messages	X	X
	Check system functional status/CSS availability	X	X

CA = Customer Administrator / CO = Customer Operator

Table 34. User access to PAM features

Modifying Customer Information

Customer information is configured during the initial installation procedure, via the PAM configuration setup Wizard. This information is used by PAM software:

- for the **PAM Tree** display: the name entered in the **Site name** field will be used for the PAM tree root node,
- to complete Customer Service Engineer Intervention Reports,
- to configure the Email server used to send messages via the e-mail channel. See *Creating an E-mail Server*, on page 5-136.

As Customer Administrator, you may modify this information.

To modify Customer information:

1. From the PAM Tree, click **Configuration Tasks** → **Customer Information**. The **Customer Information** configuration page opens.
2. Enter the new information and click **Save** to confirm changes.



Customer Information	
Site name:	<input type="text" value="Beausite"/>
Customer name:	<input type="text" value="mol"/>
Site number:	<input type="text" value="001"/>
Site engineer name:	<input type="text" value="lui"/>
Site engineer phone number:	<input type="text" value="123456789"/>
Site engineer email account:	<input type="text" value="site.engineer@customer.net"/>
Town:	<input type="text"/>
Country code:	<input type="text"/>

Figure 96. Customer Information configuration page

Configuring Autocalls

The **Autocall** feature is part of the BULL Remote Maintenance contract. It is used to automatically route system events to the Remote Maintenance Center. Full details are given in the *BULL Remote Maintenance Guide*.

If your maintenance contract includes the Autocall feature, configure Autocall parameters as follows:

3. Click **Configuration Tasks** → **Autocalls**. The **Autocalls** configuration page opens.

Figure 97. Autocalls Channel Settings control pane

4. Select the **Enable Autocalls** checkbox.
5. Select the **Send Heartbeat** checkbox and enter a value "in days" for the autocall channel control in the **Period** box. Recommended value = 1.
6. Select the autocall dispatch mode :
 - **Local dispatch mode** (default mode) sends autocalls to the local target directory indicated under **Local Settings**,
 - **FTP dispatch mode** sends autocalls to the server indicated under **FTP Settings**.
7. If **Local dispatch mode** (default mode) is selected, complete the **Local Settings** field with the following information:

Field	Explanation	Value
Local target directory	Default GTS directory used to store autocalls.	c:\gts\session

8. If **FTP dispatch mode** is selected, complete the **FTP Settings** fields with the following information:

Field	Explanation	Value
Server name	Remote Maintenance Center server IP address	127.0.0.1
Server port	Default server port	21
Target directory	Default server directory	/autocall
Login	Declared authorized user name	X
Password	Declared authorized user password	X
Passive mode	FTP connection mode	check box

9. If a modem connection is to be used:
- a. From the PAP Unit Microsoft Windows desktop, configure the dial-up connection (**Control Panel** → **Phone and Modem Options**).
 - b. From the PAM **Autocalls Control Pane**, select the **Use modem connection** checkbox.
 - c. Use the **Connection name** drop-down menu to select the required modem connection.
 - d. Complete the **User name** and **Password** fields with the declared authorized user name and user password.

Setting Thermal Units

By default, PAM software displays thermal measurements in degrees Celsius. As Customer Administrator, you may change the default setting to degrees Fahrenheit.

To change PAM thermal units:

1. Click **Configuration Tasks** → **PAM**. The **PAM Configuration** control pane opens.
2. Click the **Celsius** or **Fahrenheit** radio button, as required.
3. Click **Save**. A green icon appears in the top left corner of the control pane to confirm the change.

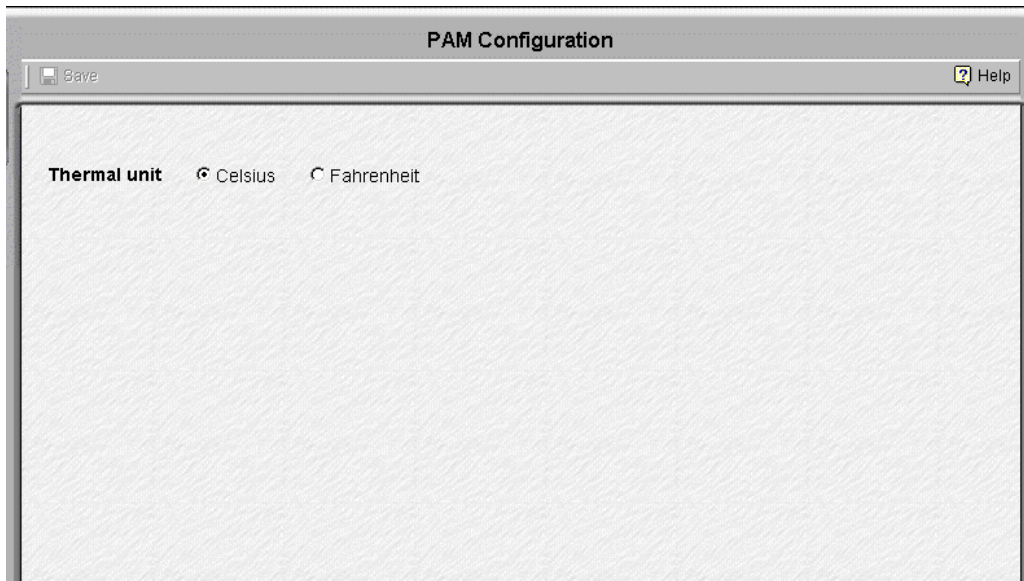

Figure 98. PAM configuration control pane

Deploying a PAM Release

As Customer Administrator, you can re-deploy a PAM release on a backup PAP Unit by running the *PAM Installation package x.y.z. msi* (x.y.z being the PAM version e.g. **2.1.9**) file.



Important:

This procedure should only be used to re-deploy a current PAM Release on a backup PAP Unit. PAM software can only be updated by authorized Customer Service Engineers.

To install a PAM Release:

1. From the local PAP unit console, power down all server domains and close the current PAM session.
2. From the default *PAM Installation* directory, double click the **.msi file** to launch the *PAM Installation InstallShield Wizard*.
3. Select **Complete** to install all program features and to accept the default path for the installation folder:
<WinDrive>:\Program Files\BULL\PAM\installation\<Release Version>
(e.g. d:\Program Files\BULL\PAM\installation\ 2.1.9).

or, select **Custom** to select program features and to define a path for the installation folder.



Figure 99. PAM Installation InstallShield Wizard



Note:

This path is the repository for activation files. NEVER delete this folder after activation as it is required to repair and re-activate the release.

4. Click **Install** to begin setup.
5. Select the **Launch PAM Activation** utility checkbox and click **Finish**. The **PAM Activation** utility is automatically launched.

The **PAM Activation** icon is installed on the PAP unit desktop and the **Platform Administration and Maintenance** program group, giving access to the **PAM Activation** and **PAP Configuration** executable files, is installed in the **Program Files** directory.

Activating a PAM Version

The *PAM InstallShield Wizard* automatically creates a shortcut to the **PAM Activation** utility on the PAP unit desktop that can be used at any time to activate an installed PAM Version.



Note:

A previous PAM Version can be re-activated at any time, in the event of a problem with the current release.

To activate / re-activate a PAM Version:

1. From the local PAP unit console, power down all server domains and close the current PAM session.
2. From the *PAM Activation* utility on the Microsoft Windows desktop, select the required PAM Version and click **Activate** to launch the *PAM Activation InstallShield Wizard*.
3. Select **Complete** to accept the default paths for the PAM Release and PAM Site Data folders:

The default PAM **Release** directory for all the files delivered as part of PAM software is:

<WinDrive>:\Program Files\BULL\PAM\<Release Version>
(e.g. d:\Program Files\BULL\PAM\).

The default PAM **Site Data** directory for all the files produced by PAM software (history files, configuration files) concerning Customer site definition and activity is:

<WinDrive>:\Program Files\BULL\PAM\PAMSiteData\<DataCompatibilityRelease>
(e.g. d:\Program Files\BULL\PAM\PAMSiteData\1).

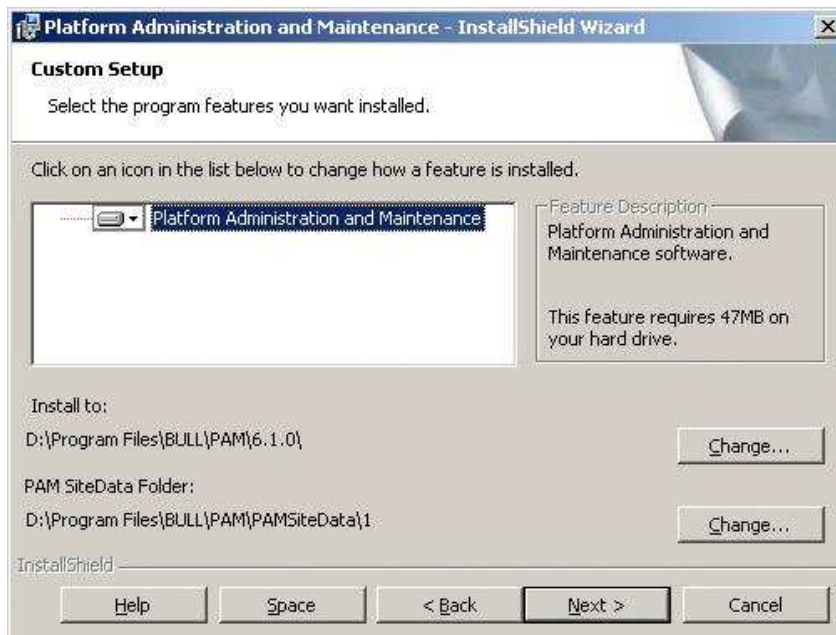

Figure 100. PAM Activation InstallShield Wizard



Important:

PAM releases use the same data directory to ensure configuration consistency. Before activating / re-activating a PAM Version, ensure that the <Data Compatibility Release> level of deployed releases is compatible. If it is NOT compatible, PAM configuration options (e.g. Event subscription options, ...) may be lost.

4. Click **Install** to begin activation.
5. Select the **Launch PAP Configuration** utility checkbox if you want to configure or reconfigure PAP unit settings. Otherwise, click **OK** to complete activation.
6. From the local PAP unit console, right click the **Microsoft Internet Explorer** icon on the desktop and click **Properties** → **General** → **Delete Files** to delete all the files in the Temporary Internet Folder.
7. Launch a new PAM session.



Important:

Notify all authorized users, connecting to PAM from a remote console, that a new PAM Version has been activated and request them to:

- a. Close their current PAM session.
- b. Delete all the files in their Temporary Internet Folder.
- c. Launch a new PAM session.

Backing Up and Restoring PAM Configuration Files

As Customer Administrator, you are advised to regularly save PAM configuration data to a removable media or to a network directory so that it can be rapidly restored in the event of PAP unit failure.

PAM software can be deployed on any standard PC running the appropriate version of Microsoft Windows and you can restore your configuration data to rebuild your working environment.

To ensure carefree, reliable and regular configuration data backup, the Bull NovaScale Server Resource CD contains two scripts, **PamBackupData.js** and **PamRestoreData.js**, that can be scheduled to run via the Microsoft Windows **Task Scheduler** to save and restore PAM configuration data.

Notes:

- PAM configuration data is automatically saved to the default PAM Site Data directory on the PAP unit:

<WinDrive>:\Program Files\BULL\PAM\PAMSiteData\<DataCompatibilityRelease>

- The **PamBackupData.js** and **PamRestoreData.js** scripts are stored in the PAM Site Data directory on the PAP unit:

<WinDrive>:\Program Files\BULL\PAM\PAMSiteData\ReleaseData\Utilities

Backing Up PAM Configuration Files

To create a Microsoft Windows automatic backup task:

1. Select or create the local or network directory to be used for saving configuration data, e.g. **<MyPamBackupDirectory>**.
2. Create a local directory for the **PamBackupData.js** and **PamRestoreData.js** script files, e.g. **<MyPamBackupTools>**.
3. Copy the **PamBackupData.js** and **PamRestoreData.js** script files into the **<MyPamBackupTools>** directory.

4. Create a Text File and enter the following command line:

Cscript PamBackupData.js <MyPamBackupDirectory>

5. Save the Text File as a batch file with a **.BAT** extension, e.g. **<MyPamBackupCommand>.bat**.
6. Click **Control Panel** → **Scheduled Tasks** → **Add Scheduled Task** to open the **Task Scheduler** wizard and follow the instructions. PAM configuration data will be automatically saved at the interval indicated in the wizard.

Restoring PAM Configuration Data



Warning:

The same PAM software release must be deployed on the PAP unit and on the backup PC to allow data restoration.

See *Deploying a New PAM Release*, on page 5-23 and *Activating a PAM Version*, on page 5-24.

PAM releases use the same data directory to ensure configuration consistency.

Before activating / re-activating a PAM Version, ensure that the <DataCompatibilityRelease> level of deployed releases is compatible.

To restore PAM configuration data:

1. From the Microsoft Windows desktop, open a command window. Browse to the <MyPamBackupTools> directory containing the script files and enter the following command line:

```
Cscript PamRestoreBackupData.js <MyPamBackupDirectory>
```

Saved PAM configuration data is restored.

Section IV - Configuring Domains



Important:

This section describes domain configuration and management tools that are reserved for use with partitioned servers and extended systems. Please contact your BullSales Representative for sales information.

This section explains how to:

- Partition your Server, on page 5-29
- Assess Configuration Requirements, on page 5-31
- Manage Domain Configuration Scheme, on page 5-33
- Update Test Schemes, on page 5-49
- Create, Edit, Copy, Delete a Domain Identity, on page 5-50
- Manage LUNs (Servers Not Connected to a SAN), on page 5-57
- Manage LUNs (Servers Connected to a SAN), on page 5-55
- Check and Update Fibre Channel HBA World Wide Names, on page 5-64
- Limit Access to Hardware Resources, on page 5-66
- Create a Mono-Domain Scheme using all Server Resources, on page 5-69
- Create a Mono-Domain Scheme using a Part of Server Resources, on page 5-83
- Create a Multi-Domain Scheme using all Server Resources, on page 5-96
- Create a Multi-Domain Scheme using a Part of Server Resources, on page 5-111
- Configure and Manage Extended Systems, on page 5-125
- Prepare a Scheme, Domain Identity, and Hardware Resources Checklist, on page 5-126

Partitioning your Server



Important:

Reserved for partitioned servers and extended systems. Please contact your Bull Sales Representative for sales information.

Bull NovaScale Servers are designed around a flexible, cell-based, midplane architecture allowing dynamic partitioning into physically independent domains. A domain is a coherent set of hardware and software resources managed by a single Operating System instance.

The NovaScale 5085 Partitioned Server is designed to operate as one or two hardware-independent SMP systems, or domains.

The NovaScale 5165 Partitioned Server is designed to operate as one, two, three or four hardware-independent SMP systems, or domains.

The NovaScale 5245 Partitioned Server is designed to operate as one or up to six hardware-independent SMP systems, or domains.

The NovaScale 5325 Partitioned Server is designed to operate as one or up to eight SMP systems, or domains.



Note:

Server components and configuration may differ according to site requirements. At least one IOC and one QBB are required for each server domain.

Partitioning allows you to optimize your server to:

- meet variations in workload - peak / off-peak periods,
- allow different time and date settings,
- use the same environment for tests and production,
- carry out software tests prior to deployment / upgrades,
- reduce downtime for servicing or re-configuration.

PAM software provides you with all the tools and features required to partition and manage your server as independent SMP systems. For easy configuration and optimum use of the physical and logical resources required for simultaneous operation, domains are defined via the **Domain Configuration Scheme** wizard. From the PAM tree, expand the **Configuration Tasks** and **Domains** nodes to display domain configuration options.

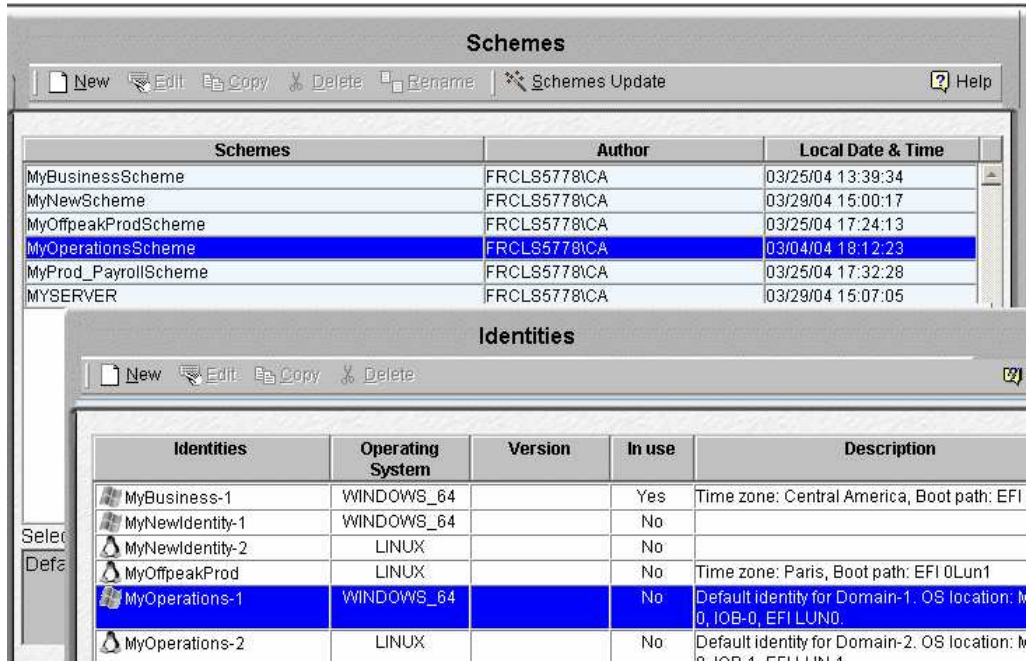

Figure 101. Schemes and Identities panes

A **Domain Configuration Scheme** is used to define and manage a set of domains that can be active simultaneously. The **Schemes** control pane allows you to create, edit, copy, delete, and rename domain configuration schemes and update default test schemes.

A **Domain Identity** is used to define and manage domain context information. The **Identities** control pane allows you to create, edit, copy, and delete domain identities.

The server is delivered with a pre-configured domain configuration scheme called **MyOperationsScheme**, allowing you to simultaneously manage and administer all server resources. However, as Customer Administrator, you may want to create other schemes and identities to suit your working environment.

Before proceeding to create a new Scheme and/or new Domain Identities, you are advised to assess your configuration requirements. See *Assessing Configuration Requirements*, on page 5-31.

Assessing Configuration Requirements



Important:

Reserved for partitioned servers and extended systems.

Certain features described below are only available if you are connected to a Storage Area Network (SAN).

Please contact your Bull Sales Representative for sales information.

At least one IOC and one QBB are required for each server domain.

You can use the following checklist to help you make an accurate plan of how you want to partition and manage your system. For easy planning, you can print a copy of the Scheme, Domain Identity, and Resources checklist templates provided on page 5-126.

Scheme Checklist	
Name	What name do I want to use for my Scheme? Examples: <ul style="list-style-type: none"> • <i>MyFullConfigScheme</i> • <i>MyPartConfigScheme</i> • <i>MyNightScheme</i> • <i>MyDayScheme</i> • <i>MyTest_ProductionScheme</i>
Description	How can I describe my Scheme to reflect its scope? Examples: <ul style="list-style-type: none"> • <i>Central Subsystems included</i> • <i>Resources used</i> • <i>Domain Identities used</i>
Central Subsystem(s)	Which Central Subsystem(s) do I want to use?
Number of Domains	How many domains do I need?
Domain Size	How many cells do I want to assign to each domain?
EFI Boot LUNs	Which EFI boot LUN do I want to use for each domain? Do I need to create a new EFI boot LUN from the disk subsystem utility before defining my new scheme?
Data LUNs *	Which data LUNs do I want to assign to each domain? Do I need to create a new data LUN from the disk subsystem utility before defining my new scheme?
Fibre Channel Hosts *	Which fibre channel host do I want to use to access LUNs?
I/O Resource Location	Which cells host the I/O resources I want to use?
Resource Access	Do I want to limit access to certain hardware resources?

* Reserved for systems connected to a Storage Area Network (SAN).

Table 35. Domain configuration assessment criteria - 1

Domain Identity Checklist	
Name	What name do I want to use for my Domain Identity to reflect the tasks/jobs it will run? Examples: <ul style="list-style-type: none"> • <i>MyDataMiningIdentity</i> • <i>MyDataBaseIdentity</i> • <i>MyProductionIdentity</i> • <i>MyTestIdentity</i>
Description	How can I describe my Domain Identity to reflect its use? Examples: <ul style="list-style-type: none"> • <i>OS and applications</i> • <i>Time zone</i> • <i>Boot path</i> • <i>IP address</i> • <i>Network name</i> • <i>URL</i> • <i>Production / test conditions</i>
Operating System	Which OS do I want to run on this domain? Does this OS support assigned hardware (CPUs, DIMMs)?
Domain Network Name	Which network name will be used to identify this domain?
Domain IP Address	Which IP address will be used to reach this domain?
Domain URL	Which URL can be used to reach my domain Web site (if any)?
Multithreading Mode	Do the CPUs used by this domain support the multithreading mode? Do I want to enable the multithreading mode for this domain?
High Memory IO Space	Do I need more than 4GB PCI gap space for the PCI boards used by this domain?
Machine Check	Do I want this domain to halt or to automatically reset if a machine check error occurs?
Licensing number	Do I intend to install an application protected by a system serial number on this domain? Do I want to substitute the physical system serial number with the logical licensing number for optimum flexibility?
Force Halt on Machine Check Reset	Has my Customer Service Engineer requested me to check this box to troubleshoot my server?

Table 36. Domain configuration assessment criteria - 2

Managing Domain Configuration Schemes



Important:

Reserved for partitioned servers and extended systems.

Certain features described below are only available if you are connected to a Storage Area Network (SAN).

Please contact your Bull Sales Representative for sales information.

What You Can Do

From the **Schemes** Control pane, you can:

- Create a domain configuration scheme
- Edit a domain configuration scheme
- Copy a domain configuration scheme
- Delete a domain configuration scheme
- Rename a domain configuration scheme

Creating a Domain Configuration Scheme

Pre-requisites

- Required EFI LUNs and Data LUNs must be created from the utility delivered with the storage subsystem.
See *Configuring System and Data Disks*, on page 5-5.
- SAN LUN and/or Local LUN lists must be updated from the **Logical Units** page.
See *Updating SAN LUNs*, on page 5-59 and/or *Updating Local LUNs*, on page 5-60 and on page 5-56.
- SAN Fibre Channel HBA World Wide Name (WWN) parameters must be up-to-date.
See *Checking and Updating Fibre Channel HBA World Wide Names*, on page 5-64.
- Domain Identities can either be created via the Domain Scheme wizard or, independently, via the **Identities** configuration page. See *Creating a Domain Identity*, on page 5-50.
- At least one IOC and one QBB are required for each server domain.

Steps

- Assess requirements
- Create EFI and/or Data LUNs
- Update the LUN lists
- Update Fibre Channel World Wide Name (WWN) parameters*
- Select the Central Subsystem(s)
- Define the number of domains

For each domain in the scheme:

- Select / create a domain identity
- Select an EFI LUN
- Select Data LUNs*
- Link LUNs to the Fibre Channel Host*
- Lock access to hardware resources

* Reserved for systems connected to a Storage Area Network (SAN)

To create a domain configuration scheme:

1. Assess your configuration requirements. See *Assessing Configuration Requirements*, on page 5-31.
2. If required:
 - Create EFI and/or Data LUNs from the utility delivered with the storage subsystem. You are advised to use **RAID level 1** for **EFI LUNs** and **RAID level 5** for **Data LUNs**.
 - Update the SAN LUN and/or Local LUN lists from the Logical Units page. See *Updating SAN LUNs*, on page 5-59 and/or *Updating Local LUNs*, on page 5-60 and on page 5-56.
 - Update Fibre Channel HBA World Wide Name (WWN) parameters.
3. Click **Configuration Tasks** → **Domains** → **Schemes** in the PAM tree to open the **Schemes** control pane.

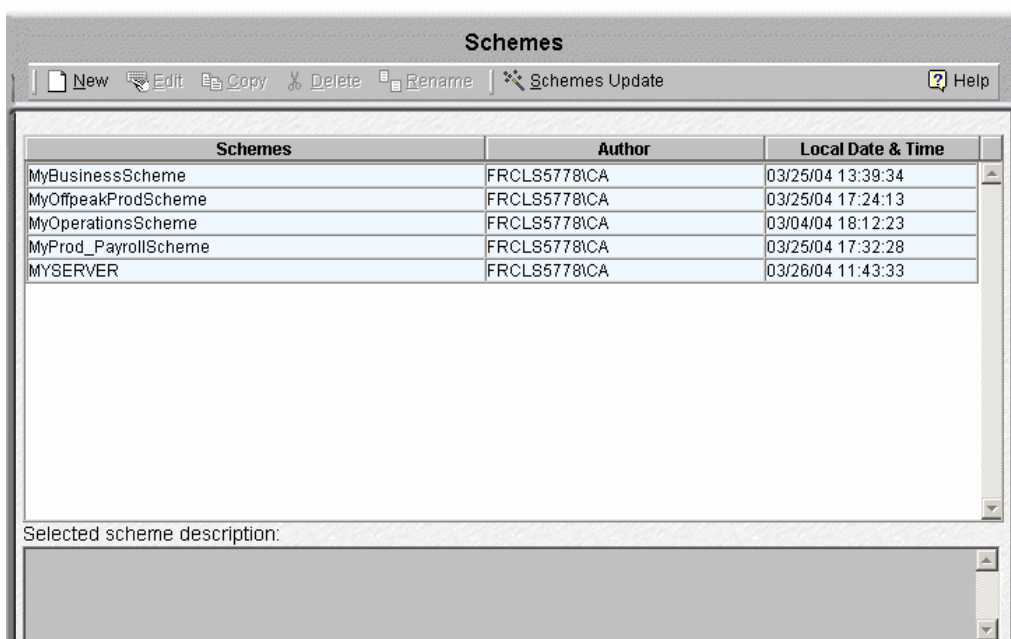

Figure 102. Schemes control pane

4. Click **New** in the toolbar to open the **Scheme Management** dialog.



Central Subsystem	
Scheme Name	Name used to identify the scheme.
Description	Brief description of scheme configuration.
Add	Select the Central Subsystem used in the scheme.
Remove	Remove a Central Subsystem from the scheme.
Modify	Select the number of hardware partitions in the scheme.
Domains	
Remove	Remove the selected domain from the scheme.
Identity	Select a domain identity.
EFI LUNs	Select an EFI Boot LUN.
Data LUNs *	Assign Data LUNs to the domain.
Link *	Define the fibre channel host to be used to access LUNs.
Lock Hardware	Limit access to certain hardware resources.

* Reserved for systems connected to a Storage Area Network (SAN)

Figure 103. Scheme Management dialog

5. Complete the **Scheme Name** and **Description** fields, as required. See *Assessing Configuration Requirements*, on page 5-31.
6. Click → **Add** to select the Central Subsystem to be used by the domain configuration scheme. The **Central Subsystem Configuration** dialog opens.

NovaScale 5085 Server

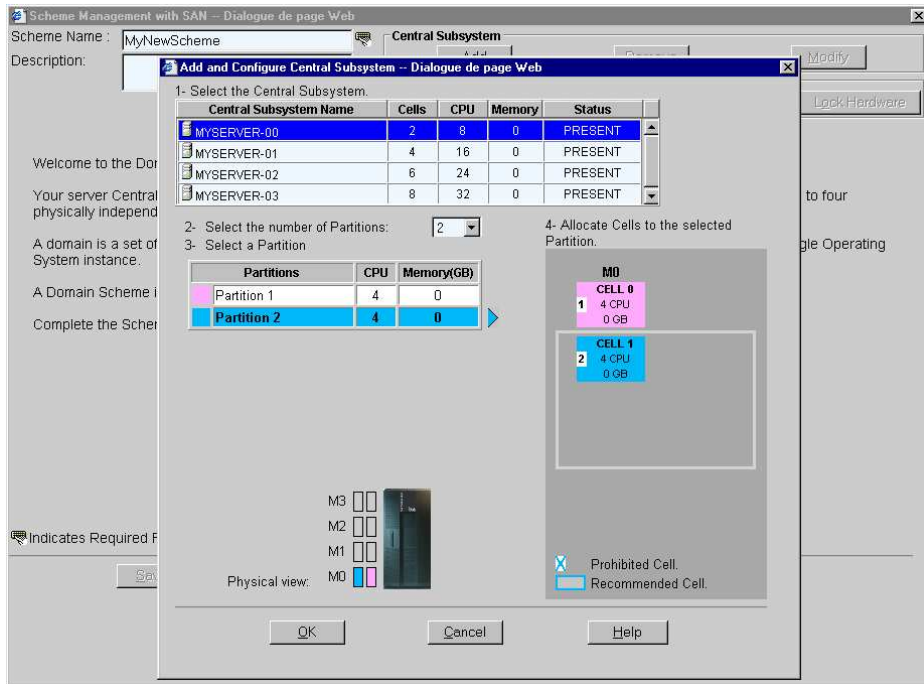

NovaScale 5165 Server

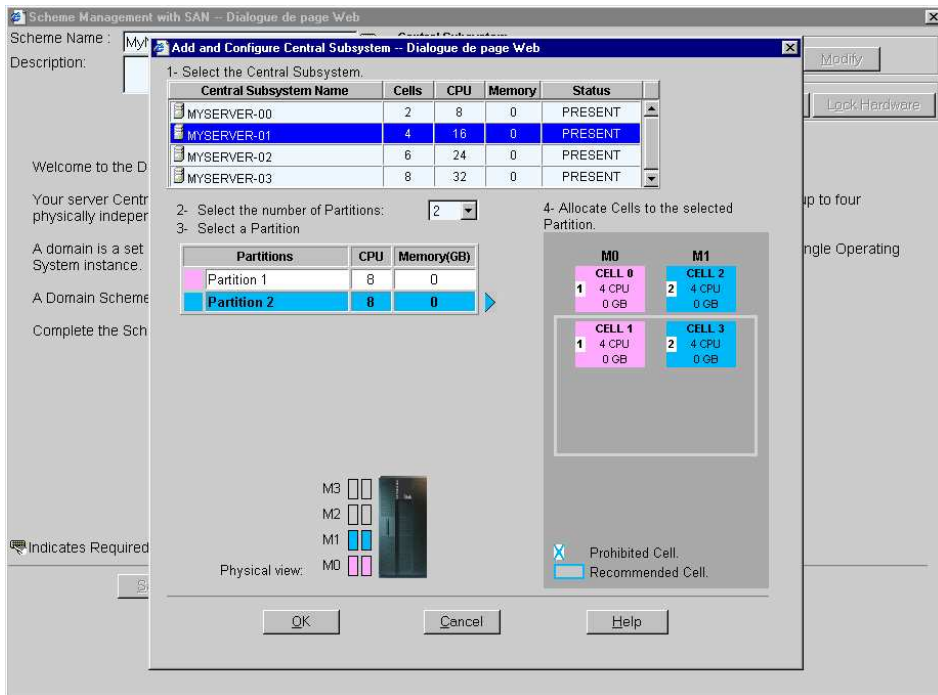

Note:

If two CSS Module cells are linked by a **Chained DIBs** icon , you cannot partition this module.

NovaScale 5245 Server

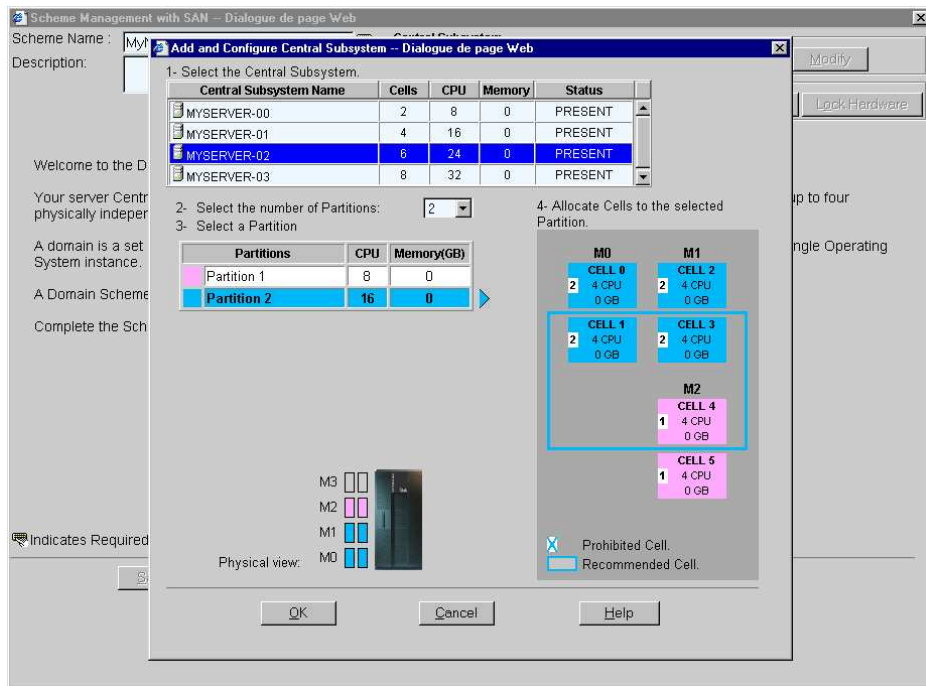

NovaScale 5325 Server

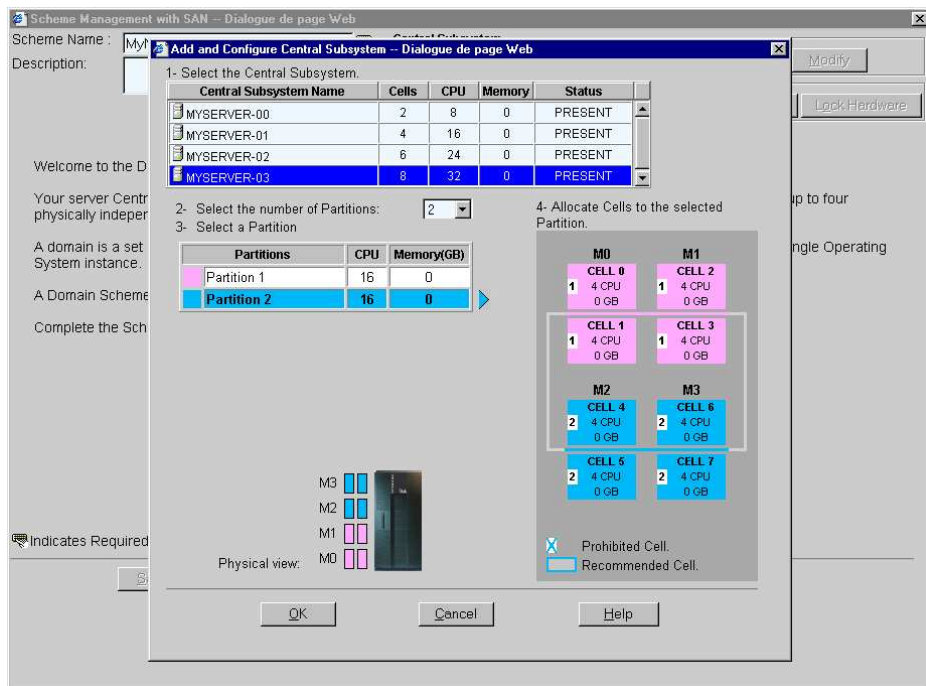

Figure 104. Scheme Creation and Central Subsystem Configuration dialogs

Note:

If two CSS Module cells are linked by a **Chained DIBs** icon , you cannot partition this module.

7. In the Central Subsystem list, select the required Central Subsystem.

The graphic representation of the selected Central Subsystem appears in the bottom right part of the window.

8. Use the **Number of Partitions** dropdown list to select the required number of hardware partitions (**2** in the examples). The partitions appear in the partition list.
9. Click the first partition in the list and select the cells to be included in this partition. Repeat this step for each partition in the list.



Important:

For optimum performance, selected cells should be contiguous, as shown in the following figure.

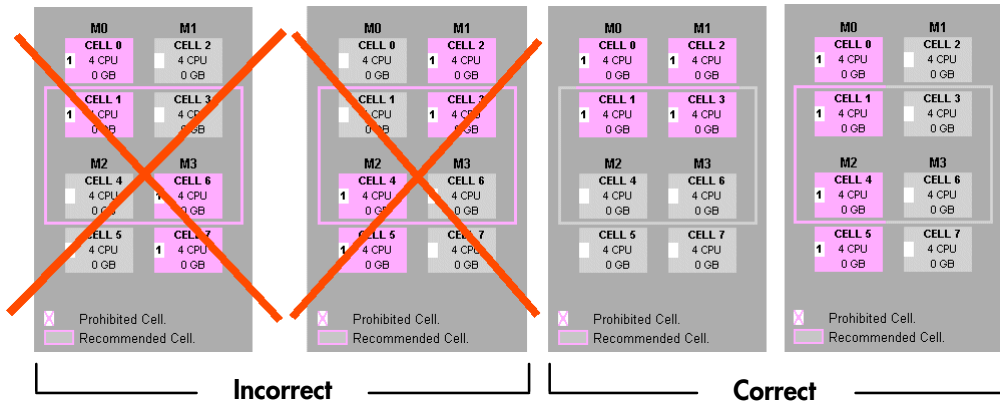

Figure 105. Optimizing partitioning

10. Click **OK** to return to the **Scheme Management** dialog.

Status icons are red because **Domain Identities** and **EFI LUNs** are required to complete domain configuration.

NovaScale 5085 Server

CellBlocks	D	Domain Identities	EFI LUNs	Data LUNs	L	S
MYSERVER00	P1			<< No Data LUNs >>		●
M3	P2			<< No Data LUNs >>		●
M2						
M1						
M0						

NovaScale 5165 Server

Scheme Name : MyNewScheme

Description :

Central Subsystem
 Add Remove Modify

Domains
 Remove Identity EFI LUNs Data LUNs Link Lock Hardware

A Scheme is a collection of fully configured Domains. A Domain must have an Identity and an EFI Boot LUN.
 Optionally, a Domain may also include one or more Data LUNs.
 When a LUN is connected to the SAN (Storage Area Network), it must be linked to a Fibre Channel Host plugged into one of the Domain's PCI slots.

To select or create a Domain Identity, double-click the Domain Identity field or select a domain and click the Identities button.
 To select a EFI boot lun, double-click the EFI LUNs field or select a domain and click the EFI LUNs button.
 To add data luns, double-click the Data LUNs field or select a domain and click the Data LUNs button.
 To define links between fiber channel hosts and luns connected through the SAN, select a domain and click the Link button.
 To temporarily exclude some hardware components from a domain, select the domain and click the Lock Hardware button.

CellBlocks	D	Domain Identities	EFI LUNs	Data LUNs	L	S
M3	P1			<< No Data LUNs >>		
M2	P2			<< No Data LUNs >>		

Indicates Required Field.

Save Cancel Help

NovaScale 5245 Server

Scheme Name : MyNewScheme

Description :

Central Subsystem
 Add Remove Modify

Domains
 Remove Identity EFI LUNs Data LUNs Link Lock Hardware

A Scheme is a collection of fully configured Domains. A Domain must have an Identity and an EFI Boot LUN.
 Optionally, a Domain may also include one or more Data LUNs.
 When a LUN is connected to the SAN (Storage Area Network), it must be linked to a Fibre Channel Host plugged into one of the Domain's PCI slots.

To select or create a Domain Identity, double-click the Domain Identity field or select a domain and click the Identities button.
 To select a EFI boot lun, double-click the EFI LUNs field or select a domain and click the EFI LUNs button.
 To add data luns, double-click the Data LUNs field or select a domain and click the Data LUNs button.
 To define links between fiber channel hosts and luns connected through the SAN, select a domain and click the Link button.
 To temporarily exclude some hardware components from a domain, select the domain and click the Lock Hardware button.

CellBlocks	D	Domain Identities	EFI LUNs	Data LUNs	L	S
M3	P1			<< No Data LUNs >>		
M2	P2			<< No Data LUNs >>		

Indicates Required Field.

Save Cancel Help

NovaScale 5325 Server

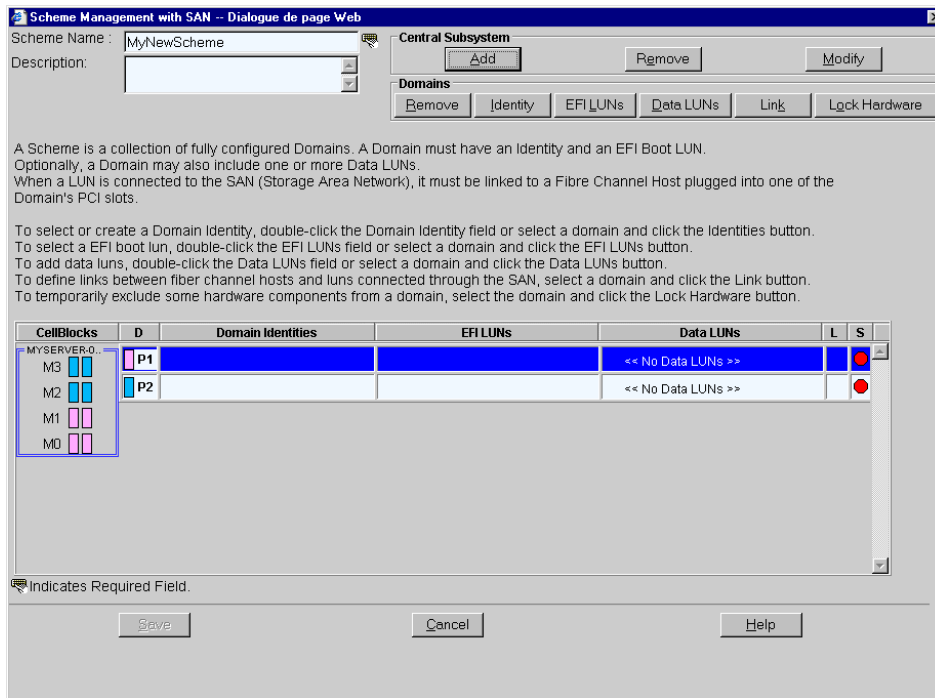

Figure 106. Scheme Management dialog - Central Subsystem configured

11. Click **Domains** → **Identity** to open the **Identities List** dialog.

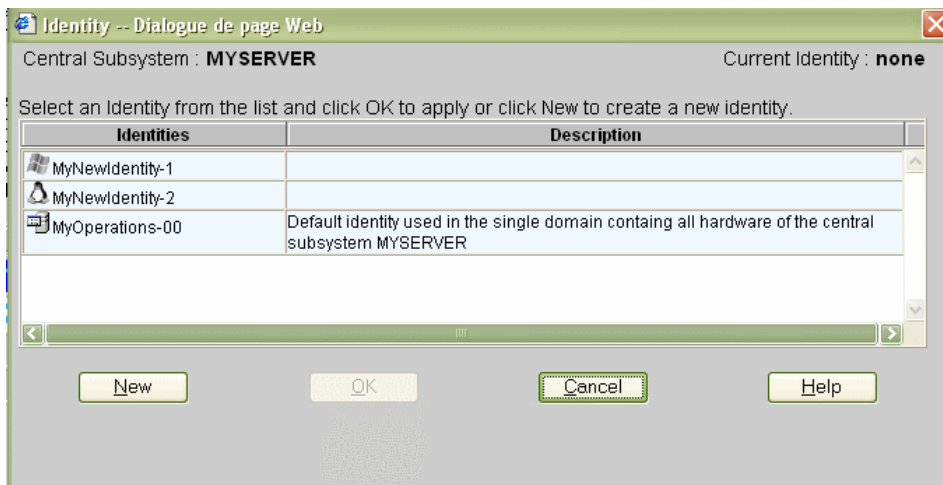
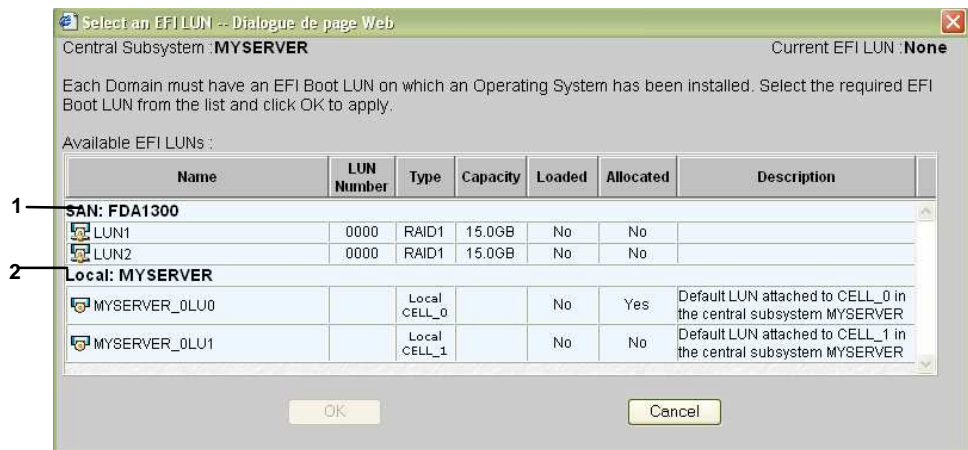

Figure 107. Domain Identities list

12. If the required identity is in the list, go to Step 13.
 If you want to create a new identity for this domain, click **New** to open the **Create New Identity** dialog. See *Creating a Domain Identity*, on page 5-50.
13. Select the required identity from the list of available identities and click **OK** to return to the **Scheme Management** dialog. The selected identity is now displayed in the **Domain Identities** field.

14. Click **Domains** → **EFI LUNs** to open the **Select EFI LUN** dialog.



1 SAN storage subsystem

2 Local storage subsystem

Figure 108. EFI LUN selection list

15. If the required EFI LUN is in the list, go to Step 16.

If the required EFI LUN is not in the list, you must exit the Domain Scheme wizard to configure the EFI LUN. See *Pre-requisites*, on page 5-33.

16. Select the required EFI Boot Lun from the list of available Luns and click **OK** to return to the **Scheme Management** dialog. The selected LUN is now displayed in the **EFI LUNs** field.

17. If the EFI LUN is a Local LUN, the **Status** icon turns green, go to Step 18.

If the EFI LUN is a SAN LUN, the **Status** icon remains red and the **No Link** icon  appears.

18. If the EFI LUN is a Local LUN and you do not want to add one or more Data LUNs to the domain, go to Step 28.
 If the EFI LUN is a SAN LUN and you do not want to add one or more Data LUNs to the domain, go to Step 22.
 If the EFI LUN is a Local or SAN LUN and you want to add one or more SAN Data LUNs to the domain, click **Domains** → **Data LUNs** to open the **Select Data LUN** dialog.

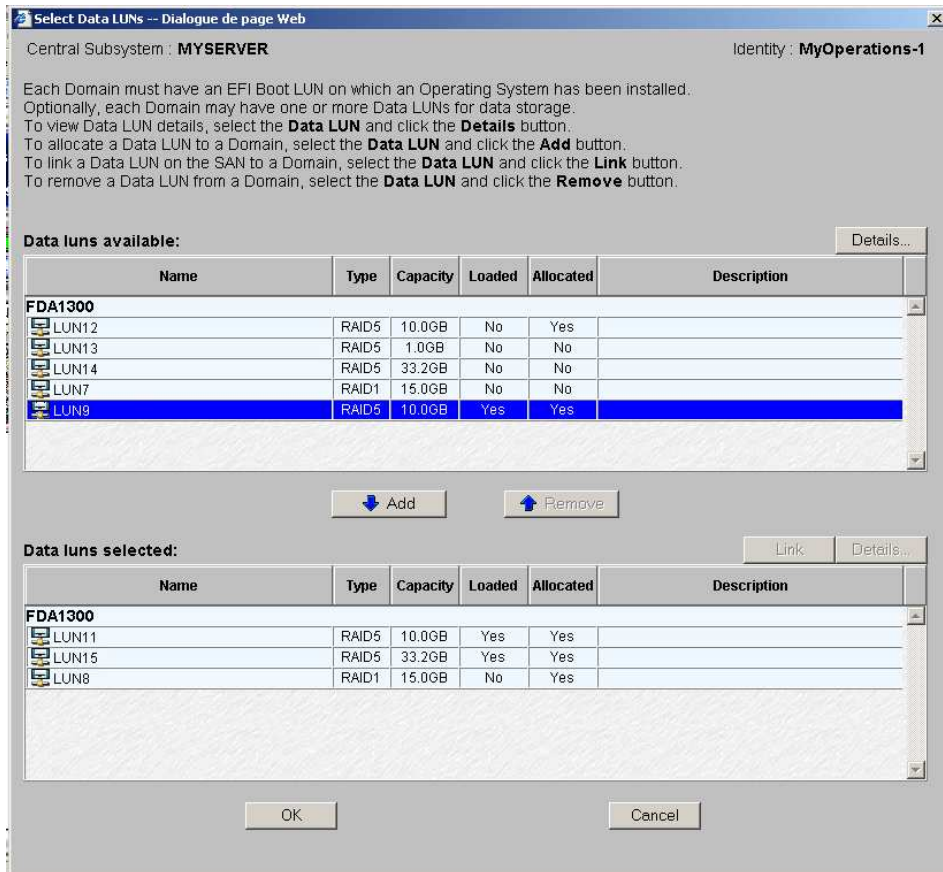

Figure 109. Select Data LUN dialog - Data luns available list

19. Select the LUN you want to add to the domain in the **Data LUNs available** list and click **Details** to view LUN parameters, if required.

The screenshot shows a web-based dialog box titled "Edit LUN parameters -- Dialogue de page Web". It contains several input fields and checkboxes. The "Name" field is set to "LUN9". The "Description" field is empty. The "LUN Number" is "0001", "Type" is "RAID5", and "Size" is "10.0GB". The "LUN State" is "ready". The "Subsystem Name" is "FDA1300", "Subsystem Model" is "FDA", and "Serial Number" is "0000000928303375". There are four checkboxes: "EFI LUN", "Present", "Loaded", and "Allocated", all of which are currently unchecked. There is an "NVRAM..." button to the right of the "Allocated" checkbox. A "Cancel" button is located at the bottom center of the dialog.

Name	Name given to the LUN when created.
Description	Brief description of the LUN.
LUN Number	Number allocated to the LUN when created.
LUN State	If the LUN is ready for use, READY is displayed.
Type	LUN configuration mode.
Size	LUN size.
Subsystem Name	Name of the subsystem containing the LUN.
Subsystem Model	Type of subsystem containing the LUN.
Serial Number	Serial number of the subsystem containing the LUN.
EFI LUN	If this box is checked, the LUN is an EFI boot LUN. If this box is not checked, the LUN is a Data LUN.
Present	If this box is checked, the LUN is detected. If this box is not checked, the LUN is not detected.
Loaded	If this box is checked, the LUN is loaded in the Domain Manager Control pane. If this box is not checked, the LUN is not loaded in the Domain Manager Control pane.
Allocated	If this box is checked, the LUN is already allocated to a scheme. If this box is not checked, the LUN is not allocated to a scheme.

Figure 110. View LUN parameters dialog

20. Click **Add**. The selected Data LUN is moved to the **Data LUNs selected** list.

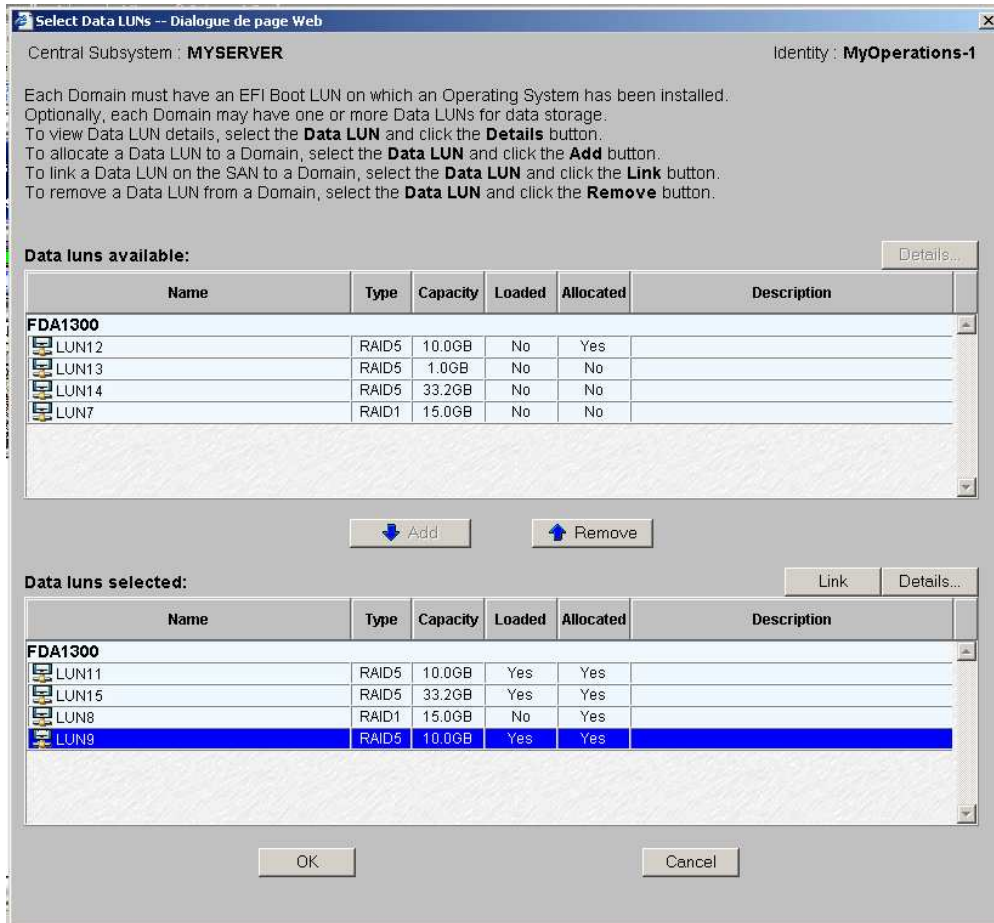

Figure 111. Select Data LUN dialog - Data luns selected list

21. Repeat Steps 19 and 20 for each Data LUN you want to add to the domain and click **OK** to return to the **Scheme Management** dialog. **Data LUN set** is now displayed in the **Data LUNs** field.

The **Status** icon remains red and the **No Link** icon  is displayed. You must now link the selected EFI and Data LUNs to the Fibre Channel Host you want to use to access these LUNs.

22. Click **Domains** → **Link** to open the **Link LUNs to HBA** dialog.

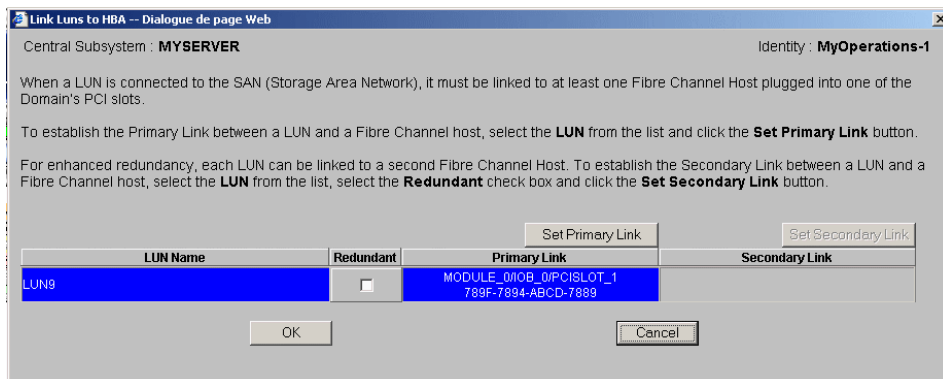

Figure 112. Link LUNs to HBA dialog

23. Select the **Redundant** checkbox if you want to define two links to the LUN.

 **Note:**

If you select the **Redundant** mode, you will be informed that dedicated software is required to enable this mode and you will be requested to confirm your choice.

24. Click **Set Primary Link** to define the main access path to the SAN. The **Select HBA** dialog opens, allowing you to select the domain PCI slot you want to use to access the LUN.

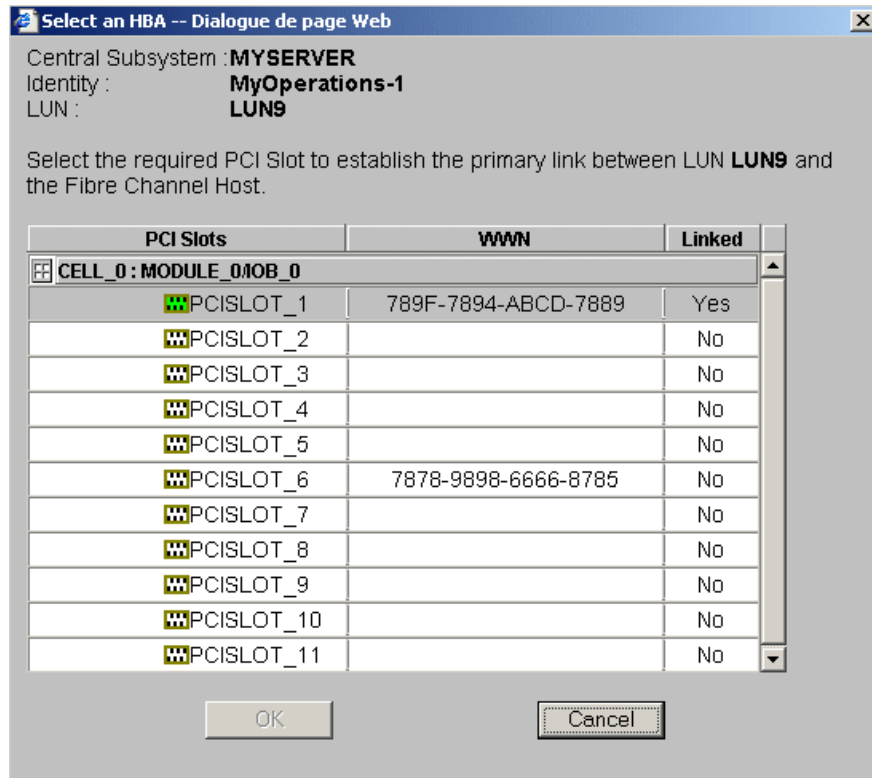



Figure 113. Select an HBA dialog

25. Select the PCI slot containing the HBA to be used as the primary link to the SAN and click **OK**. The primary link is now set.

26. Where applicable, click **Set Secondary Link** to define the backup access path to the SAN. Select the PCI slot containing the HBA to be used as the secondary link to the SAN and click **OK**. The secondary link is now set.

27. Click **OK** → **Apply** to return to the **Scheme Management** dialog. The **Status** icon turns green and the **Linked** icon  appears.

28. Repeat Steps 11 to 27 for the other domains. All **Status** icons turn green.

NovaScale 5085 Server

Scheme Management with SAN -- Dialogue de page Web

Scheme Name : MyNewScheme
 Description:

Central Subsystem

Domains

A Scheme is a collection of fully configured Domains. A Domain must have an Identity and an EFI Boot LUN.
 Optionally, a Domain may also include one or more Data LUNs.
 When a LUN is connected to the SAN (Storage Area Network), it must be linked to a Fibre Channel Host plugged into one of the Domain's PCI slots.

To select or create a Domain Identity, double-click the Domain Identity field or select a domain and click the Identities button.
 To select a EFI boot lun, double-click the EFI LUNs field or select a domain and click the EFI LUNs button.
 To add data luns, double-click the Data LUNs field or select a domain and click the Data LUNs button.
 To define links between fiber channel hosts and luns connected through the SAN, select a domain and click the Link button.
 To temporarily exclude some hardware components from a domain, select the domain and click the Lock Hardware button.

CellBlocks	D	Domain Identities	EFI LUNs	Data LUNs	L	S
MYSERVER-0...	D1	MyNewIdentity-1	LUN1	<< Data LUN set >>	<input type="checkbox"/>	<input type="checkbox"/>
M3	D2	MyNewIdentity-2	LUN2	<< Data LUN set >>	<input checked="" type="checkbox"/>	<input checked="" type="checkbox"/>
M2						
M1						
M0						

Indicates Required Field.

NovaScale 5165 Server

Scheme Management with SAN -- Dialogue de page Web

Scheme Name : MyNewScheme
 Description:

Central Subsystem

Domains

A Scheme is a collection of fully configured Domains. A Domain must have an Identity and an EFI Boot LUN.
 Optionally, a Domain may also include one or more Data LUNs.
 When a LUN is connected to the SAN (Storage Area Network), it must be linked to a Fibre Channel Host plugged into one of the Domain's PCI slots.

To select or create a Domain Identity, double-click the Domain Identity field or select a domain and click the Identities button.
 To select a EFI boot lun, double-click the EFI LUNs field or select a domain and click the EFI LUNs button.
 To add data luns, double-click the Data LUNs field or select a domain and click the Data LUNs button.
 To define links between fiber channel hosts and luns connected through the SAN, select a domain and click the Link button.
 To temporarily exclude some hardware components from a domain, select the domain and click the Lock Hardware button.

CellBlocks	D	Domain Identities	EFI LUNs	Data LUNs	L	S
MYSERVER-0...	D1	MyNewIdentity-1	LUN1	<< Data LUN set >>	<input type="checkbox"/>	<input type="checkbox"/>
M3	D2	MyNewIdentity-2	LUN2	<< Data LUN set >>	<input checked="" type="checkbox"/>	<input checked="" type="checkbox"/>
M2						
M1						
M0						

Indicates Required Field.

NovaScale 5245 Server

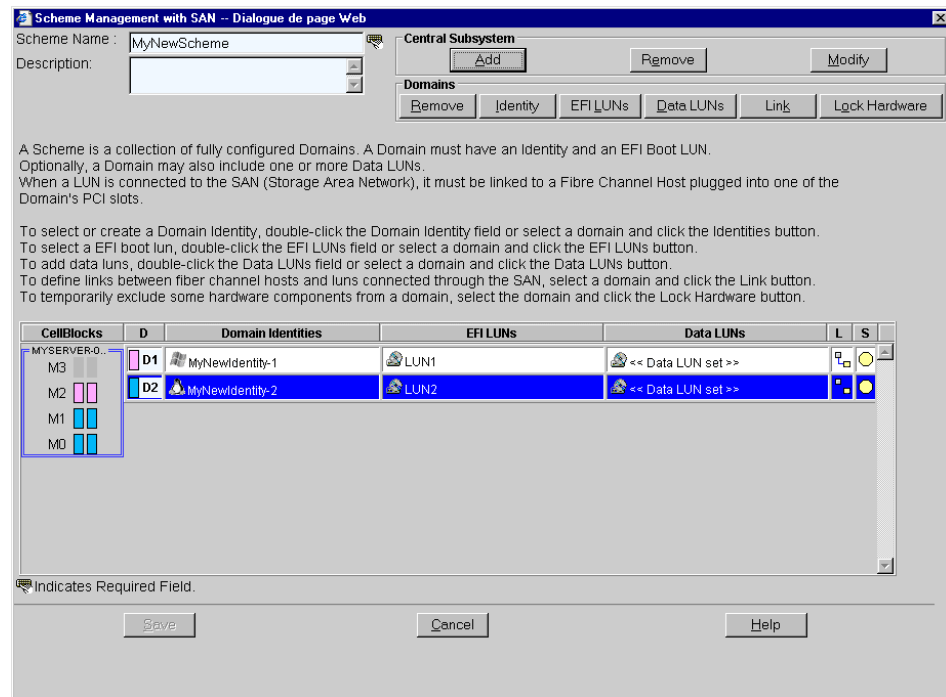

NovaScale 5325 Server

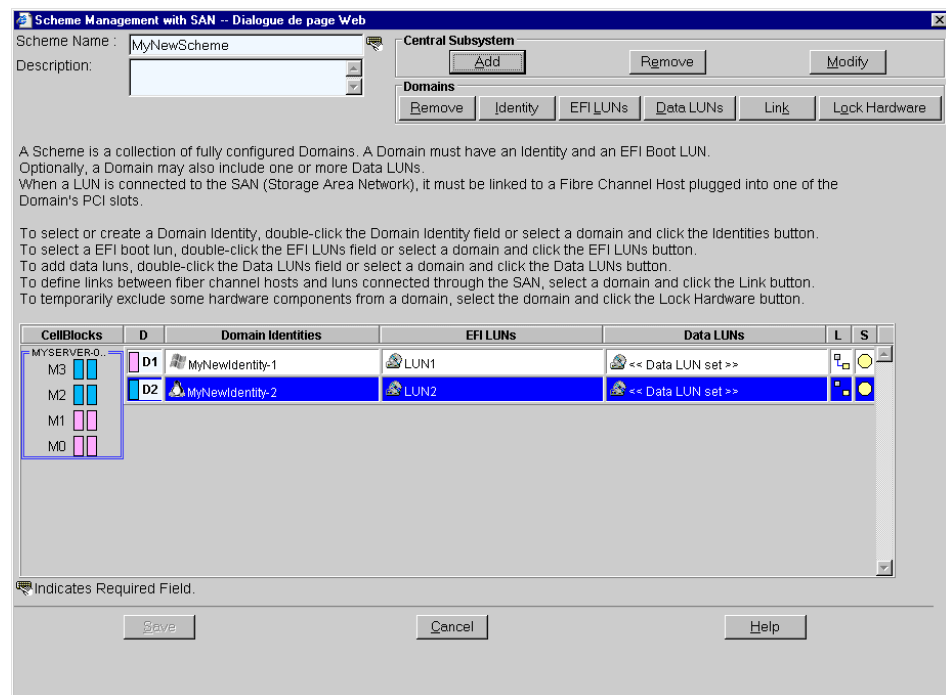

Figure 114. Scheme Management dialog

29. If you do not want to functionally limit access to certain hardware elements, go to Step 30.

If you want to functionally limit domain access to certain hardware elements, click **Domains** → **Lock Hardware** to open the **Lock Domain Hardware Resources** dialog. See *Limiting Access to Hardware Resources*, on page 5-66.

30. Click **Save**. The domain configuration scheme is now available for domain management.

Editing a Domain Configuration Scheme

To edit a domain configuration scheme:

1. Assess your configuration requirements. See *Assessing Configuration Requirements*, on page 5-31.
2. Click **Configuration Tasks** → **Domains** → **Schemes** in the PAM tree to open the **Schemes** pane. See Figure 102 above.
3. Select the required scheme from the list.
4. Click **Edit** in the toolbar to open the **Edit Scheme** dialog.

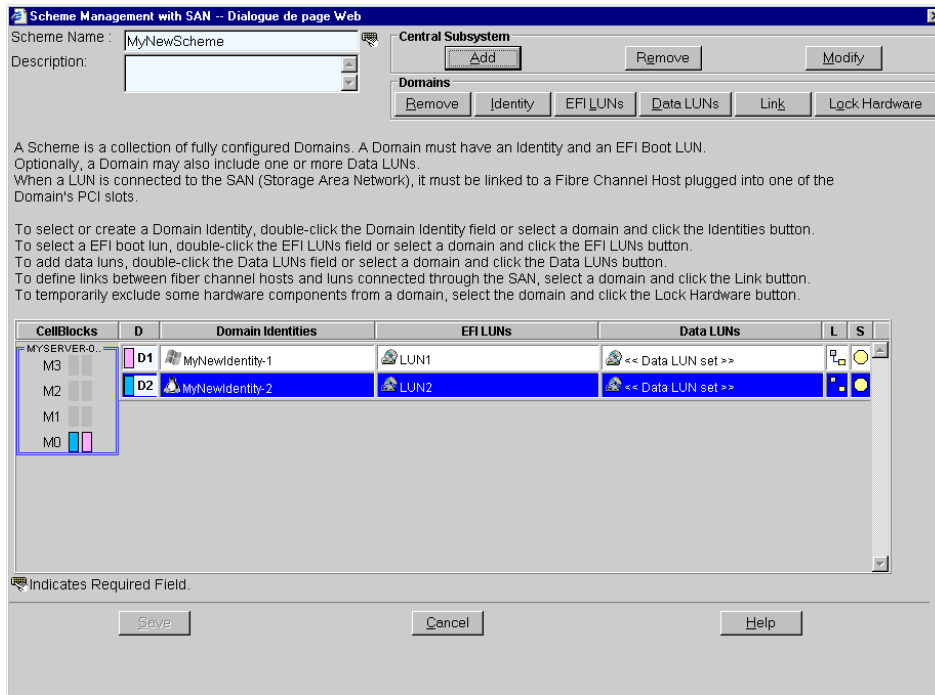

Central Subsystem	
Add	Click here to add another Central Subsystem to your scheme. See <i>Creating a Domain Configuration Scheme</i> , on page 5-33.
Remove	Click here to remove a Central Subsystem from your scheme.
Modify	Click here to change the number of hardware partitions in your scheme.
Domains	
Remove	Click here to remove the selected domain from the scheme.
Identity	Click here to select a domain identity.
EFI LUNs	Click here to select an EFI Boot LUN.
Data LUNs *	Click here to assign Data LUNs to the domain.
Link *	Click here to define the fibre channel host to be used to access LUNs.
Lock Hardware	Click here to limit access to certain hardware resources.

* Reserved for systems connected to a Storage Area Network (SAN).

Figure 115. Edit Scheme dialog

5. Make the required changes and click **Save**. The modified domain configuration scheme is now available for domain management.

Copying a Domain Configuration Scheme

To copy a domain configuration scheme:

1. Click **Configuration Tasks** → **Domains** → **Schemes** in the PAM tree to open the **Schemes** pane. See Figure 102 above.
2. Select the required scheme from the list.
3. Click **Copy** in the toolbar. The **Copy Scheme** dialog opens.
4. Enter a name for the new scheme and click **OK**. The new domain configuration scheme is now available for domain management.

Deleting a Domain Configuration Scheme

To delete a domain configuration scheme:

1. Click **Configuration Tasks** → **Domains** → **Schemes** in the PAM tree to open the **Schemes** pane. See Figure 102 above.
2. Select the required scheme from the list.
3. Click **Delete** in the toolbar. You are requested to confirm scheme deletion.
4. Click **OK** to confirm. The domain configuration scheme is removed from the **Schemes List** and is no longer available for domain management.

Renaming a Domain Configuration Scheme

To rename a domain configuration scheme:

1. Click **Configuration Tasks** → **Domains** → **Schemes** in the PAM tree to open the **Schemes** pane. See Figure 102 above.
2. Select the required scheme from the list.
3. Click **Rename** in the toolbar.
4. Enter a new name for the scheme and click **OK**. The renamed domain configuration scheme is now available for domain management.

Updating Default Schemes

The **Domain Wizard** allows you to automatically generate and update a set of **Default Schemes**. These default schemes take into account all the hardware in your configuration. You may need to update your default schemes after a service intervention entailing the addition/removal of hardware elements.

To update default schemes:

1. Click **Configuration Tasks** → **Domains** → **Schemes** in the PAM tree to open the **Schemes** pane. See Figure 102 above.
2. Click **Schemes Update** in the toolbar. Default schemes are automatically updated.

Creating, Editing, Copying, Deleting a Domain Identity



Important:

Reserved for partitioned servers and extended systems. Please contact your Bull Sales Representative for sales information.



Note:

Domain Identities can either be created via the **Domain Configuration Scheme** wizard or, independently, via the **Identities** configuration page. See *Creating a Domain Configuration Scheme*, on page 5-33.

Creating a Domain Identity

To create a domain identity:

1. Assess your configuration requirements. See *Assessing Configuration Requirements*, on page 5-31.
2. Click **Configuration Tasks** → **Domains** → **Identities** in the PAM tree to open the **Identities Management** page.

The screenshot shows a window titled "Identities" with a toolbar containing "New", "Edit", "Copy", "Delete", and "Help". Below the toolbar is a table with the following data:

Identities	Operating System	Version	In use	Description
MyBusiness-1	WINDOWS_64		No	Time zone: Central America, Boot path: EFI 0Lun0
MyOffpeakProd	LINUX		No	Time zone: Paris, Boot path: EFI 0Lun1
MyOperations-1	WINDOWS_64		No	Default identity for Domain-1. OS location: Module 0, IOB-0, EFI LUN0.
MyOperations-2	LINUX		No	Default identity for Domain-2. OS location: Module 0, IOB-1, EFI LUN-1.
MyPayroll	LINUX		Yes	Time zone: Paris, Boot path: EFI 0Lun1
MyProduction	WINDOWS_64		Yes	Time zone: Vladivostok, Boot path: EFI 0Lun0
TEST	OTHER OS		No	Identity used for test purpose. It is reserved to be used in test schemes.

Figure 116. Identities List page

3. Click **New** in the toolbar to open the **Create New Identity** dialog.

Name	Name reflecting the tasks/jobs to be run by the domain.
Description	Brief description reflecting domain use.
Operating System Version	OS and OS version to be run on this domain. Note: Check that the selected OS supports assigned hardware (CPUs, DIMMs)?
Domain Network Name	Network name used to identify this domain.
Domain IP Address	IP address used to reach this domain.
Domain URL	URL used to reach the domain Web site (if any).

Figure 117. Create New Identity dialog

4. Complete the **Name**, **Description**, **Domain Settings** and **Management Parameters** fields as required.

- Click **Advanced Settings** to open the **Advanced Identity Settings** dialog.

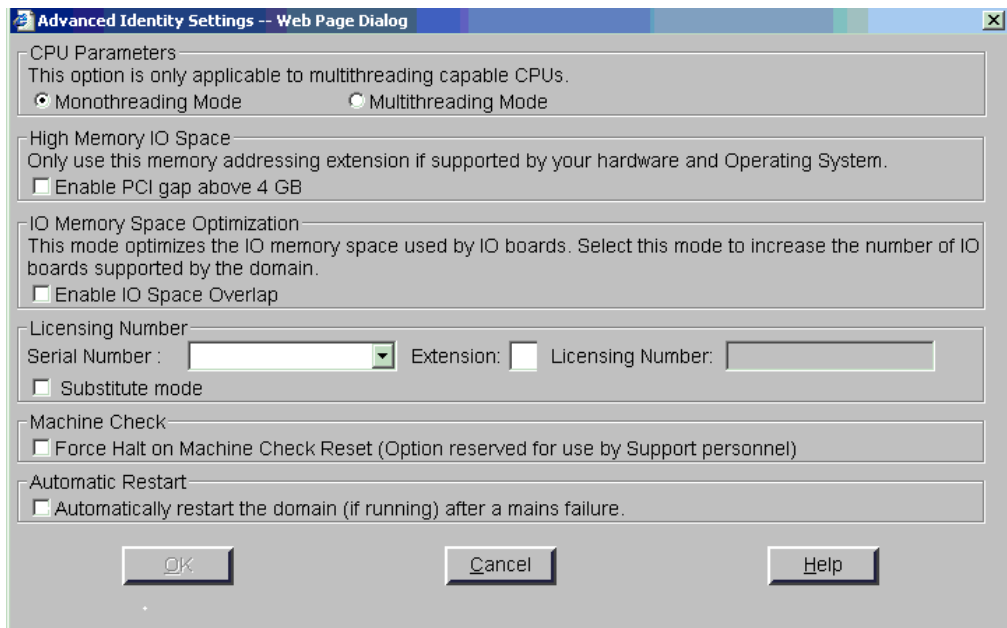

CPU Parameters	Enable / disable multithreading. Note: Check that the CPUs used by this domain support the multithreading mode.
High Memory IO Space	Enable / disable extended PCI gap memory space. Note: Only use if this domain uses PCI boards requiring more than 4GB PCI gap space. Compatibility problems may arise under Windows.
IO Memory Space Optimization	Enable / disable IO space overlap. Note: Check this box to increase the number of PCI boards supported by the domain (from 14 to 29 maximum).
Licensing Number	Licensing number used by protected applications, created by adding a two digit extension to the system serial number. Enable / disable substitute mode. Note: Check this box to substitute the physical system serial number with the logical licensing number for optimum flexibility.
Machine Check	Enable / disable automatic domain reset when a machine check error occurs. Note: Check this box when requested by your Customer Service Engineer.
Automatic Restart	Enable / disable automatic domain restart after a mains power failure. Note: Check this box to automatically restart the domain (if previously running or EFI started) after a mains power failure.

Figure 118. Advanced Identity Settings dialog

6. Complete the **Advanced Identity Settings** dialog fields as required:
 - a. **CPU Parameters:**
 - Select **Multithreading Mode** if you want this domain to use multithreading features (if the CPUs used by the domain support the multithreading mode)
 - Select **Monothreading Mode** if you do not want this domain to use multithreading features or if the CPUs used by the domain do not support the multithreading mode.
 - b. **High Memory IO Space:**

 **Note:**
Please read the documentation delivered with your PCI boards for details about features and requirements.

Select **Enable PCI gap above 4 GB** if the PCI boards used by the domain require more than 4 GB PCI gap space.
 - c. **IO Memory Space Optimization**

 **Note:**
Please read the documentation delivered with your PCI boards for details about features and requirements.

Select **Enable IO Space Overlap** if you need to increase the number of PCI boards supported by the domain (from 14 to 29 maximum).
 - d. **Licensing Number:**

 **Note:**
Please read the documentation delivered with your application for details about licensing requirements.

 - Select a system **Serial Number** from the scroll-down list and add a two digit extension to automatically create the **Licensing Number** to be used by protected applications running on this domain.
 - Select **Substitute Mode** if you want to substitute the physical system serial number with the logical licensing number for optimum flexibility.
 - e. If requested by your Customer Service Engineer, select **Force Halt on Machine Check Reset** to halt the domain when a machine check error occurs.

 **Note:**
If this box is NOT checked, the domain will automatically reset when a machine check error occurs.
 - f. **Automatic Restart:**
 - Check this box to automatically restart the domain (if previously running or EFI started) after a mains power failure.

 **Note:**
An error message (2B2B221F) may be displayed although the domain has been successfully restarted. This error message, generated following the loss of the mains power supply, is not significant.
7. Click **OK**. The new identity appears in the **Identities List** page and can be applied to a hardware partition via the **Domain Configuration Scheme** wizard.

Editing a Domain Identity

To modify domain identity settings, management parameters and/or description:

1. Assess your configuration requirements. See *Assessing Configuration Requirements*, on page 5-31.
2. Click **Configuration Tasks** → **Domains** → **Identities** in the PAM tree to open the **Identities Management** page. See Figure 116 above.
3. Select the required identity from the list.
4. Click **Edit** in the toolbar. The **Edit an Identity** dialog opens, allowing you to modify domain identity settings, management parameters and/or description. See Figure 117 above.
5. Change settings as required.
6. Click **OK** to confirm the modification.

Copying a Domain Identity

To copy a domain identity:

1. Click **Configuration Tasks** → **Domains** → **Identities** in the PAM tree to open the **Identities Management** page. See Figure 116 above.
2. Select the required identity from the list.
3. Click **Copy** in the toolbar. The **Copy Identity** dialog opens.
4. Enter the name for the new identity and click **OK** to confirm.
5. The new identity appears in the **Identities List** page and can be applied to a hardware partition via the **Domain Configuration Scheme** wizard.

Deleting a Domain Identity



Important:

If a Domain Identity is used in a Scheme, it cannot be deleted.

To delete a domain identity:

1. Click **Configuration Tasks** → **Domains** → **Identities** in the PAM tree to open the **Identities List** page. See Figure 116 above.
2. Select the required identity from the list.
3. Click **Delete** in the toolbar and click **OK** to confirm. The selected identity is removed from the **Identities List**.

Managing Logical Units (Servers Not Connected to a SAN)

Your server is delivered with default EFI Boot LUNs. You can use the software delivered with your storage subsystem to define data LUNs.

What You Can Do

- **Clear, Load, Save NVRAM Variables**
- **Update the Local LUN Lists**

To open the Logical Units management page:

1. Click **Configuration Tasks** → **Domains** → **LUNs** in the PAM tree.

The screenshot shows a window titled "Managing Logical Units" with a toolbar containing "NVRAM", "Update", and "Help" icons. Below the toolbar is a table with the following data:

Name	EFI	In Use In Domain	In Use In Scheme	NVRAM	Description
MYSERVER_0LU0	EFI	Yes	Yes	No	Default LUN attached to CELL_0 in the central subsystem MYSERVER
MYSERVER_0LU1	EFI	Yes	Yes	No	Default LUN attached to CELL_1 in the central subsystem MYSERVER
MYSERVER_0LU2	EFI	Yes	Yes	No	Default LUN attached to CELL_2 in the central subsystem MYSERVER
MYSERVER_0LU3	EFI	Yes	Yes	No	Default LUN attached to CELL_3 in the central subsystem MYSERVER

Name	Default LUN name
EFI	EFI This LUN is a boot LUN. DATA This LUN is a data LUN.
In Use in Domain	Yes This LUN is used by a domain currently loaded in the Domain Manager Control pane. No This LUN is not used by a domain currently loaded in the Domain Manager Control pane.
In Use in Scheme	Yes This LUN has been allocated to a domain within a Domain Configuration Scheme. No This LUN has not been allocated to a domain within a Domain Configuration Scheme.
NVRAM	Yes NVRAM variables have been saved for this LUN. No NVRAM variables have not been saved for this LUN.
Description	Default description, indicating LUN location (Central Subsystem name and Cell).

Figure 119. Logical Units page - servers not connected to a SAN

Updating the Local LUN Lists

The lists of available local LUNs are automatically created when a Central Subsystem is declared and/or added. You can update the lists of available local LUNs at any time to reflect configuration changes.

To update the local LUN lists:

1. Click **Configuration Tasks** → **Domains** → **LUNs** in the PAM tree to open the **Logical Units** page.
2. Click **Update**. When requested, click **OK** to confirm. The new LUN lists are displayed in the **Logical Units** page.

Clearing, Loading, Saving NVRAM Variables

NVRAM variables are available for each EFI boot LUN. According to requirements, these variables can be cleared, saved and/or loaded.

1. Click **Configuration Tasks** → **Domains** → **LUNs** in the PAM tree to open the **Logical Units** page.
2. Select the required LUN from the list of available EFI Boot LUNs and click **NVRAM**. The **NVRAM Variables** dialog opens.
 - a. Click **Clear** to clear displayed NVRAM variables. When requested, click **OK** to confirm.
 - b. Click **Save** to save NVRAM variables for the selected EFI Boot LUN (currently used by an active domain). When requested, enter the name of the file to which NVRAM variables are to be saved. The NVRAM variables file is stored in the PAM SiteData directory.
 - c. Click **Load** to load previously saved NVRAM variables from the PAM SiteData directory.

Managing Logical Units (Servers Connected to a SAN)



Important:

Certain features described below are only available if you are connected to a Storage Area Network (SAN).

Please contact your Bull Sales Representative for sales information.

What You Can Do

- Update SAN LUN Lists
- Declare Local LUNs
- Delete Local LUNs
- Edit LUNs
- Rename LUNs
- Clear, Load, Save NVRAM Variables



Note:

EFI LUNs and Data LUNs must be created from the utility delivered with the storage subsystem. See *Configuring System and Data Disks*, on page 5-5.

To open the Logical Units management page:

1. Click **Configuration Tasks** → **Domains** → **LUNs** in the PAM tree.

Managing Logical Units

SAN Update | Edit LUN | Rename LUN | Delete LUN | NVRAM | Declare local LUN | Help

This page allows you to manage the LUNs you have created from the utility delivered with your storage subsystem(s).

List of EFI Boot LUNs (Operating System).

Name	LUN Number	Type	Capacity	Loaded	Allocated	Description
SAN: FDA1300						
LUN1	0000	RAID1	15.0GB	No	No	
LUN2	0000	RAID1	15.0GB	No	No	
Local: MYSERVER						
MYSERVER_OLU0		Local CELL_0		Yes	Yes	Default LUN attached to CELL_0 of the central subsystem MYSERVER
MYSERVER_OLU1		Local CELL_1		No	No	Default LUN attached to CELL_1 of the central subsystem MYSERVER
MYSERVER_OLU2		Local		No	No	Default LUN attached to CELL_2 of the central subsystem MYSERVER

List of Data LUNs (Data storage).

Name	LUN Number	Type	Capacity	Loaded	Allocated	Description
SAN: FDA1300						
LUN10	0005	RAID5	33.2GB	No	No	
LUN3	0000	RAID1	15.0GB	No	No	
LUN4	0001	RAID5	10.0GB	No	No	
LUN5	0002	RAID5	10.0GB	No	No	
LUN6	0001	RAID5	10.0GB	No	No	
LUN7	0002	RAID5	10.0GB	No	No	
LUN8	0003	RAID5	1.0GB	No	No	

1 SAN storage subsystem 2 Local storage subsystem



Notes:

- **EFI Boot LUNs**, on which Operating Systems are installed, are listed at the top of the pane.

- **Data LUNs**, on which data can be stored, are listed at the bottom of the pane.

Command Bar

SAN Update	Update the lists of SAN LUNs.
Edit LUN	Modify the LUN name, description, and change a Data LUN into an EFI LUN and vice-versa.
Rename LUN	Modify the LUN name.
NVRAM	Clear, load and save EFI Boot LUN NVRAM variables.
Declare Local LUN	Declare a new local LUN.
Delete Local LUN	Delete a non-allocated local LUN.

LUN List

Name	LUN name.
LUN Number	Number allocated to the LUN.
Type	RAID configuration type. RAID1 is recommended for EFI LUNs and RAID5 for Data LUNs.
Capacity	LUN storage capacity.
Loaded	Yes LUN used by a currently loaded domain. No LUN not used by a currently loaded domain.
Allocated	Yes LUN allocated to a domain within a Domain Configuration Scheme. No LUN not allocated to a domain within a Domain Configuration Scheme.
Description	Description, indicating LUN location (Central Subsystem name and Cell and/or storage subsystem name).

Figure 120. Logical Units page - servers connected to a SAN

Updating SAN LUN Lists



Important:

**Reserved for systems connected to a Storage Area Network (SAN).
Please contact your Bull Sales Representative for sales information.**

When new LUNs are added to / removed from your Storage Area Network, they can be automatically added to / removed from the list of available LUNs by using the **PAM SAN Update** command, which allows you to update the lists of available LUNs on the SAN at any time.



Notes:

- This command **CANNOT** be used to update the lists of local LUNs.
- This command is automatically performed when a PAM session is launched on the PAP unit and when a disk subsystem change takes place.
- When a new LUN is found, PAM considers it as a Data LUN by default. If you want to change this LUN into an EFI Boot LUN, use **Edit LUN**.

To update the lists of available SAN LUNs:

1. Create the required LUNs from the utility delivered with the storage subsystem(s).
2. Click **Configuration Tasks** → **Domains** → **LUNs** in the PAM tree to open the **Logical Units** page.
3. Click **SAN Update**. A confirmation dialog opens.
4. Click **Yes** to update the lists of available LUNs. The **SAN Update Progress Bar** is displayed.

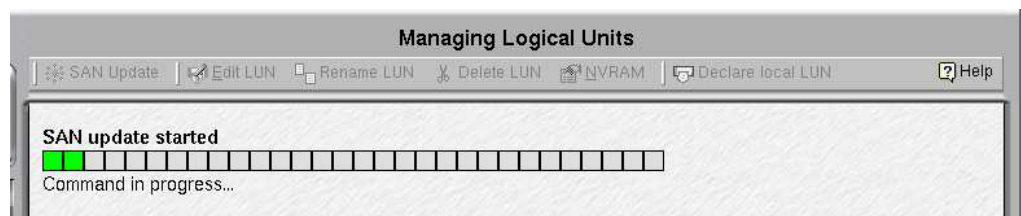

Figure 121. SAN Update progress bar

Once the process is complete, the LUN lists are updated to reflect configuration changes.

Declaring Local LUNs

When you create a new LUN via the software delivered with your local storage subsystem, you must also declare this new LUN by using the PAM **Declare Local LUN** command.



Note:

This command **CANNOT** be used to declare new SAN LUNs.

To update the list of available local LUNs:

1. Create the required LUNs from the utility delivered with the storage subsystem(s).
2. Click **Configuration Tasks** → **Domains** → **LUNs** in the PAM tree to open the **Logical Units** page.
3. Click **Declare local LUN** to open the **Declare Local LUN** dialog.

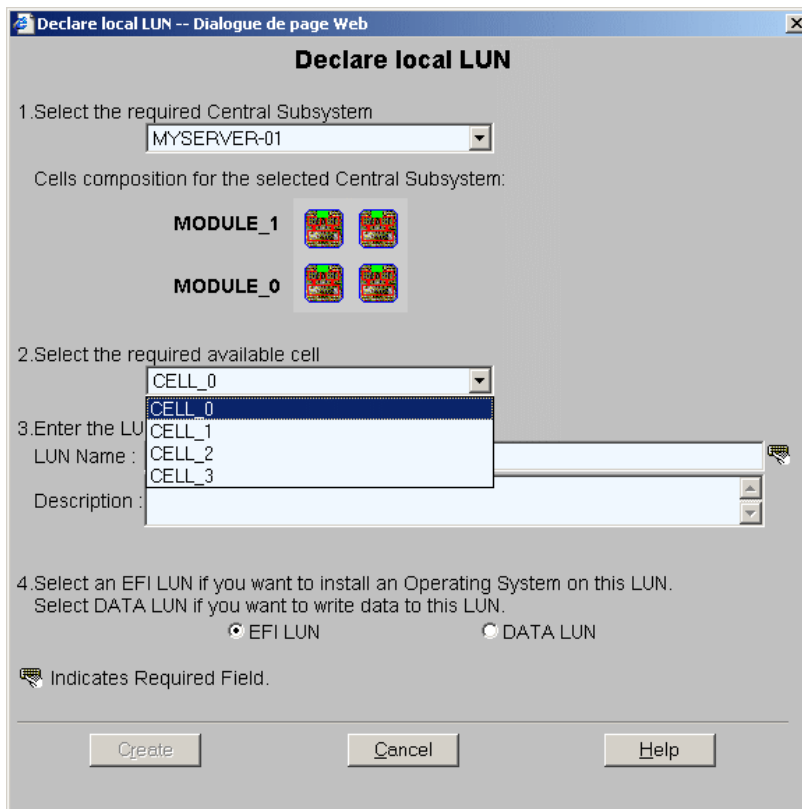

Figure 122. Declare Local LUN dialog

4. Use the **Central Subsystem** drop-down menu to select the Central Subsystem to which the LUN is connected.
5. Use the **Available Cell** drop-down menu to select the cell to which the LUN is connected.
6. Enter the name given to the LUN in the **LUN Name** field with a brief description.
7. Select the **EFI LUN** or **DATA LUN** radio button, as required and click **Create**. The list of available local LUNs is updated.

Deleting Local LUNs

Notes:

- A LUN **CANNOT** be deleted if it is allocated to a Scheme.

To delete a LUN:

1. Click **Configuration Tasks** → **Domains** → **LUNs** in the PAM tree to open the **Logical Units** page.
2. Select the required LUN from the lists of available local LUNs and click **Delete LUN** to open the **Delete LUN** dialog.

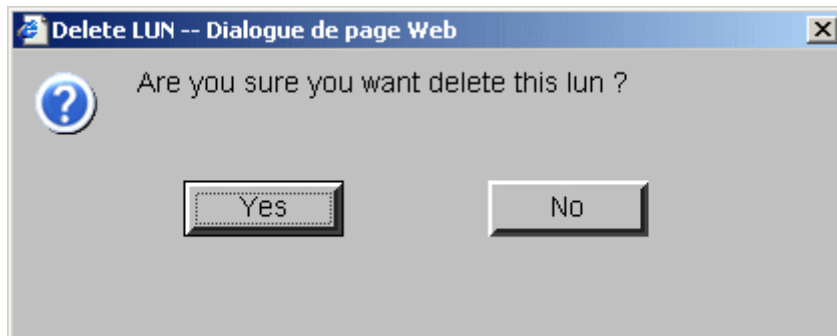

Figure 123. Delete LUN dialog

3. Click **Yes** to confirm. The LUN is removed from the list of available LUNs.

Editing LUNs



Important:

**Reserved for systems connected to a Storage Area Network (SAN).
Please contact your Bull Sales Representative for sales information.**



Notes:

- A LUN **CANNOT** be edited if it is allocated to a Scheme.
- The **NVRAM** button is **NOT ACCESSIBLE** if no NVRAM variables are available for the selected LUN.

If required, you can modify the EFI / Data LUN names, description, NVRAM variables, and/or change a Data LUN into an EFI LUN or vice-versa.

To edit a LUN:

1. Click **Configuration Tasks** → **Domains** → **LUNs** in the PAM tree to open the **Logical Units** page.
2. Select the LUN you want to modify from the lists of available LUNs and click **Edit LUN** to open the **Edit LUN** dialog.

The screenshot shows the 'Edit LUN parameters' dialog box. The fields are as follows:

Name:	LUN8				
Description:					
LUN Number:	0000	Type:	RAID1	Size:	15.0GB
LUN State:	ready				
Subsystem Name:	FDA1300	Subsystem Model:	FDA		
Serial Number:	0000000928303378				
<input type="checkbox"/> EFI LUN	<input type="checkbox"/> Present	<input type="checkbox"/> Loaded	<input type="checkbox"/> Allocated	<input type="button" value="NVRAM..."/>	

Indicates Required Field.

Buttons: OK, Cancel

Figure 124. Edit LUN dialog

3. Modify LUN parameters as required:
 - a. Enter a new name in the **Name** field if you want to change the LUN name.
 - b. Enter a new description in the **Description** field if you want to change the LUN description.
 - c. Select the **EFI LUN** checkbox if you want to change a Data LUN into an EFI LUN.
 - d. Deselect the **EFI LUN** checkbox if you want to change an EFI LUN into a Data LUN.
4. Click **OK** to apply changes.

Renaming LUNs



Important:

Reserved for systems connected to a Storage Area Network (SAN).
Please contact your Bull Sales Representative for sales information.



Note:

A LUN **CANNOT** be renamed if it is allocated to a Scheme.

To rename a LUN:

1. Click **Configuration Tasks** → **Domains** → **LUNs** in the PAM tree to open the **Logical Units** page.
2. Select the LUN you want to rename from the lists of available LUNs and click **Rename LUN** to open the **Rename LUN** dialog.

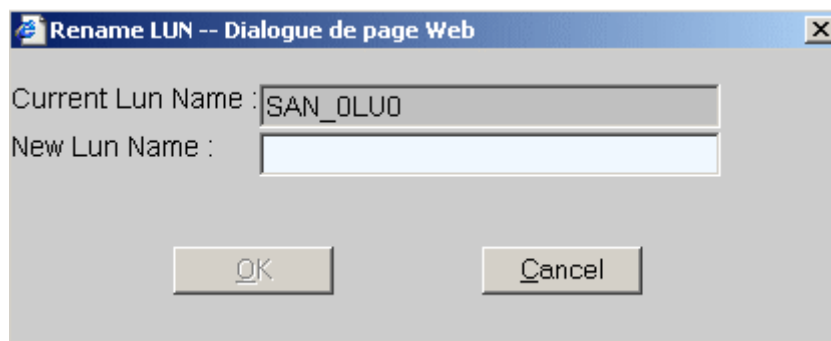

Figure 125. Rename LUN dialog

3. Enter the new name and click **OK** to apply the change.

Clearing, Loading, Saving NVRAM Variables

NVRAM variables are available for each EFI boot LUN. According to requirements, these variables can be cleared, saved and/or loaded.



Note:

NVRAM variables can only be saved when the corresponding domain is active.

To clear, save and/or load NVRAM variables:

1. Click **Configuration Tasks** → **Domains** → **LUNs** in the PAM tree to open the **Logical Units** page.
2. Select the required LUN from the list of available EFI boot LUNs and click **NVRAM**. The **NVRAM Variables** dialog opens:
 - a. Click **Clear** to clear displayed NVRAM variables. When requested, click **OK** to confirm.
 - b. Click **Save** to save NVRAM variables for the selected LUN (currently used by an active domain). When requested, enter the name of the file to which NVRAM variables are to be saved. The NVRAM variables file is stored in the PAM SiteData directory.
 - c. Click **Load** to load previously saved NVRAM variables from the PAM SiteData directory.

Checking and Updating Fibre Channel HBA World Wide Names



Important:

**Reserved for servers and connected to a Storage Area Network (SAN).
Please contact your Bull Sales Representative for sales information.**

To control LUN access, Bull NovaScale Servers use LUN masking at Host Bus Adapter (HBA) driver level. Each Fibre Channel HBA driver contains a masking utility using the World Wide Name (WWN) to limit LUN access. As a result, users are only aware of the LUNs to which they have access.

Whenever you add, change or move a Fibre Channel HBA, you must update the corresponding World Wide Name (WWN) parameters via the PAM interface.

To update an HBA World Wide Name:

1. Click **Configuration Tasks** → **Domains** → **HBAs** in the PAM tree.
2. Expand the required Central Subsystem node down to the IOC housing the HBA concerned.
3. Select the IOC. The **HBA Worldwide Name** page opens.

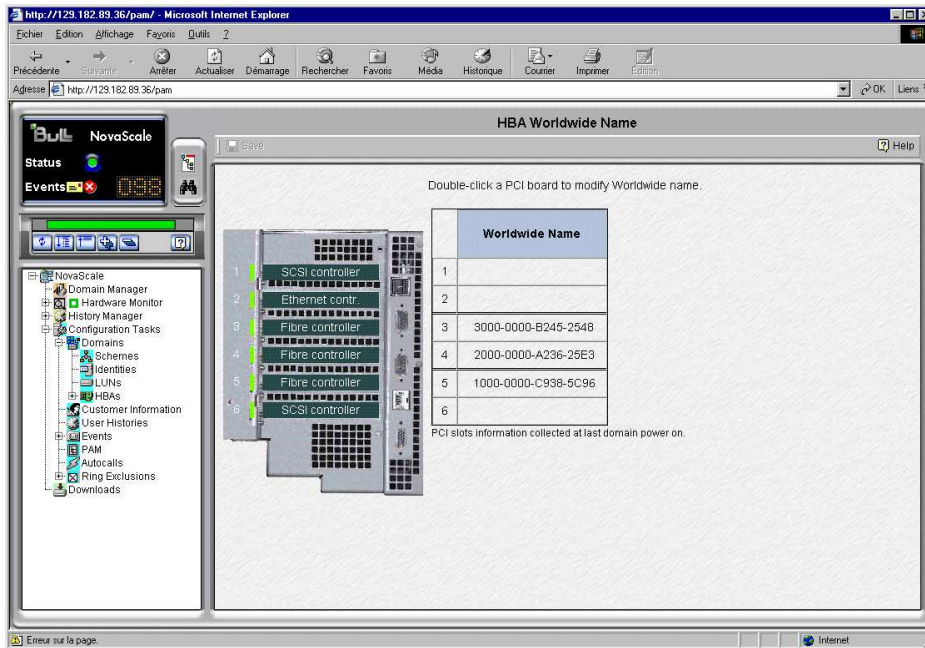

Figure 126. HBA Worldwide Name page

4. Double-click the required PCI board to update the WWN. The **Modify PCI HBA Worldwide Name** dialog opens.

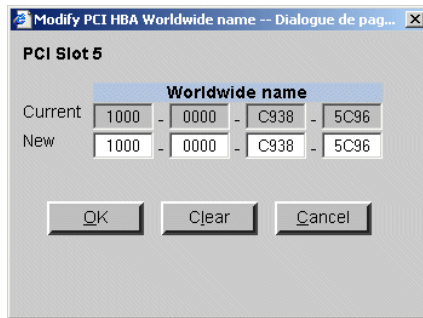



Figure 127. Modify PCI HBA Worldwide Name dialog

5. Enter the WWN supplied with the HBA and click **Save** to apply changes.

Limiting Access to Hardware Resources

You can functionally limit access to certain hardware elements. Locked elements can no longer be accessed by the current domain, but are still physically available for access by other domains. Previously locked elements can be unlocked so that they can be accessed by the domain.

Notes:

- The domain must be **INACTIVE** before configuration changes can be made.
- Hardware locking / unlocking is only taken into account at the next domain power ON.
- Hardware components to be functionally included (unlocked) in the domain at the next domain power ON are marked with a yellow  icon in the **Lock Request** column in the **Domain Hardware Details** page.
- Hardware components to be functionally excluded (locked) from the domain at the next domain power ON are marked with a red / yellow  icon in the **Lock Request** column in the **Domain Hardware Details** page.

See *Viewing Domain Configuration, Resources and Status*, on page 3-35.

The following domain hardware elements can be locked / unlocked:

QBB	Each domain must comprise at least one QBB.
CPU	Each QBB must comprise at least one CPU. If all CPUs are locked from a QBB, the QBB itself is locked.
IOCs	When a domain comprises more than one cell (therefore more than one IOC), the Master IOC is the one hosting the boot disk. The other IOCs in the domain are Slave IOCs. Slave IOCs can be safely locked from a domain, but connected peripherals will no longer be accessible. Note: If the Master IOC is locked, local system disks may no longer be accessible and the domain may not power up.
IOC HubLinks	All IOC HubLinks can be safely locked from a domain, but connected peripherals will no longer be accessible. IOC HubLinks are organized as follows: HubLink_1 controls PCI Slots 1 & 2 HubLink_2 controls PCI slots 3 & 4 HubLink_3 controls PCI slots 5 & 6 Note: If Master IOC HubLink_1 is locked, local system disks may no longer be accessible and the domain may not power up.
PCI Slots	All PCI slots not connected to a boot disk can be safely locked from a domain, but connected peripherals will no longer be accessible. Note: If Master IOC PCI Slots 1, 2 are locked, system disks may no longer be accessible and the domain may not power up.

Table 37. Hardware locking options

Note:

Slave IOCs can be safely locked from a domain, but connected peripherals will no longer be accessible.

If the Master IOL is locked, the domain will not power up.

Locking / Unlocking Hardware Elements

To lock / unlock a domain hardware element:

1. Open the **Lock Domain Hardware Resources** dialog:
 - a. If you are configuring a domain scheme:

From the **Scheme Management** dialog, select the required domain and click **Lock Hardware**.
 - b. If you want to edit a previously defined domain scheme:
 - From the Customer Administrator PAM tree, click **Configuration Tasks** → **Domains** → **Schemes** → **Edit**.
 - Select the required domain and click **Lock Hardware**

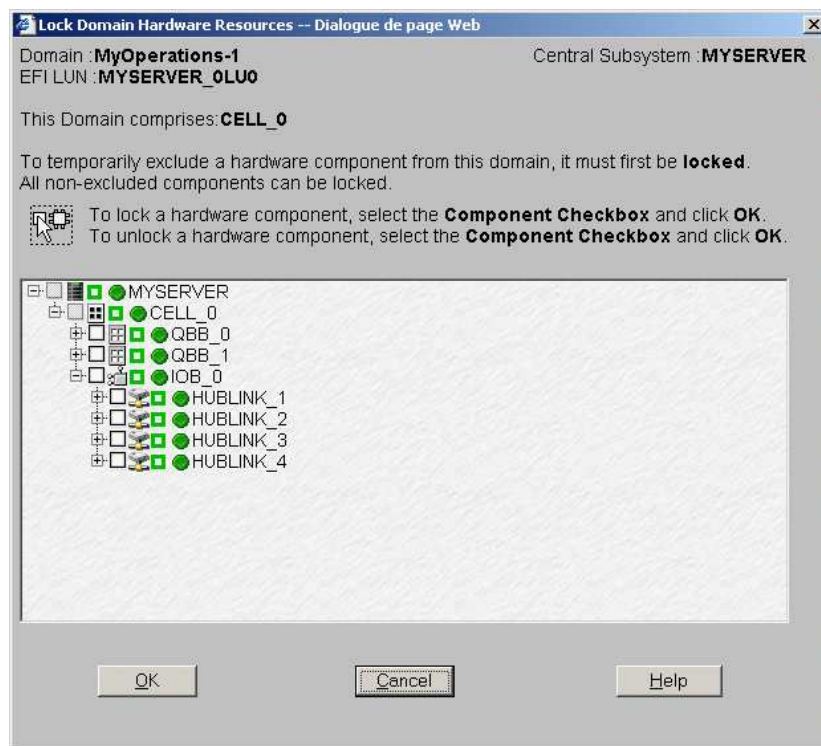

Figure 128. Lock domain hardware resources dialog

2. Expand the component tree to view the hardware element you want to lock / unlock.
3. Select the corresponding checkbox to lock the element or deselect to unlock a previously locked element.

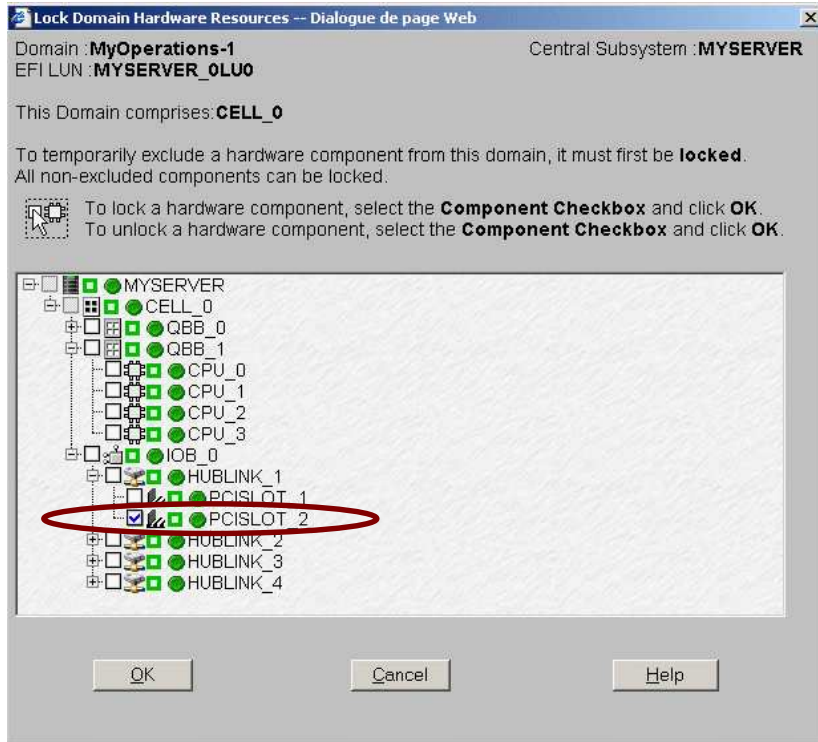

Figure 129. Lock domain hardware resources dialog - PCI slot selected

4. Click **OK** → **Apply** to return to the **Schemes Management** pane.

Creating a Mono-Domain Scheme Using All Server Resources

Notes:

- A domain configuration scheme can include more than one Central Subsystems. If you have more than one Bull NovaScale Server, see *Configuring and Managing Extended Systems*, on page 5-125.
- For more information about scheme configuration options, refer to:
 - *Assessing Configuration Requirements*, on page 5-31
 - *Creating a Domain Configuration Scheme*, on page 5-33
 - *Creating a Domain Identity*, on page 5-50

The configuration criteria set out in the following tables is used to illustrate this example:

NovaScale 5085 Server

Scheme	
Name	MyBusinessScheme
Description	Mono-domain, Cells 0 & 1, Boot 0Lun0, MyBusiness-1
Central Subsystem(s)	MYSERVER-00
Number of domains	1
Domain size	2 cells: Cell0 & Cell1
EFI boot LUNs	SAN: FDA1300 LUN1
Data LUNs (SAN only)	SAN: FDA 1300 LUN10, LUN6
Fibre channel hosts (SAN only)	Primary Link: Cell_0: Module_0/IOC_0/PCISLOT_1 Secondary Link: Cell_1: Module_0/IOC_1/PCISLOT_1
IO resource location	OIOC0 mandatory, OIOC1 optional
Resource access	All resources unlocked
Domain Identity	
Name	MyBusiness-1
Description	Time zone: Central America
Operating System	Windows
Domain network name	MyBusiness-1Net
Domain IP address	123.123.12.1
Domain URL	http://www.MyBusiness-1Web.com
Domain CPU parameters	Monothreading mode
High memory IO space	Disabled
IO memory space optimization	Disabled
Licensing number	XAN-S11-99999/11
Substitute mode	Disabled
Halt on machine check reset	Disabled

Table 38. Scheme configuration criteria - example 1 - mono-module server

NovaScale 5165 Server

Scheme	
Name	MyBusinessScheme
Description	Mono-domain, Cells 0, 1, 2 & 3, Boot 0Lun0, MyBusiness-1
Central Subsystem(s)	MYSERVER-01
Number of domains	1
Domain size	4 cells: Cell0, Cell1, Cell2 & Cell 3
EFI boot LUNs	SAN: FDA1300 LUN1
Data LUNs (SAN only)	SAN: FDA 1300 LUN10, LUN6
Fibre channel hosts (SAN only)	Primary Link: Cell_0: Module_0/IOC_0/PCISLOT_1 Secondary Link: Cell_3: Module_1/IOC_1/PCISLOT_1
IO resource location	0IOC0 mandatory, 0IOC1, 1IOC0, & 1IOC1 optional
Resource access	All resources unlocked
Domain Identity	
Name	MyBusiness-1
Description	Time zone: Central America
Operating System	Windows
Domain network name	MyBusiness-1Net
Domain IP address	123.123.12.1
Domain URL	http://www.MyBusiness-1Web.com
Domain CPU parameters	Monothreading mode
High memory IO space	Disabled
IO memory space optimization	Disabled
Licensing number	XAN-S11-99999/11
Substitute mode	Disabled
Halt on machine check reset	Disabled

Table 39. Scheme configuration criteria - example 1 - 2 modules server

NovaScale 5245 Server

Scheme	
Name	MyBusinessScheme
Description	Mono-domain, Cells 0 to 5, Boot 0Lun0, MyBusiness-1
Central Subsystem(s)	MYSERVER-02
Number of domains	1
Domain size	6 cells: Cell0 to Cell5
EFI boot LUNs	SAN: FDA1300 LUN1
Data LUNs (SAN only)	SAN: FDA 1300 LUN10, LUN6
Fibre channel hosts (SAN only)	Primary Link: Cell_0: Module_0/IOC_0/PCISLOT_1 Secondary Link: Cell_3: Module_1/IOC_1/PCISLOT_1
IO resource location	0IOC0 mandatory, 0IOC1, 1IOC0, 1IOC1, 2IOC0 & 2IOC1 optional
Resource access	All resources unlocked
Domain Identity	
Name	MyBusiness-1
Description	Time zone: Central America
Operating System	Windows
Domain network name	MyBusiness-1Net
Domain IP address	123.123.12.1
Domain URL	http://www.MyBusiness-1Web.com
Domain CPU parameters	Monothreading mode
High memory IO space	Disabled
IO memory space optimization	Disabled
Licensing number	XAN-S11-99999/11
Substitute mode	Disabled
Halt on machine check reset	Disabled

Table 40. Scheme configuration criteria - example 1 - 3 modules server

NovaScale 5325 Server

Scheme	
Name	MyBusinessScheme
Description	Mono-domain, Cells 0 to 7, Boot 0Lun0, MyBusiness-1
Central Subsystem(s)	MYSERVER-03
Number of domains	1
Domain size	8 cells: Cell0 to Cell 7
EFI boot LUNs	SAN: FDA1300 LUN1
Data LUNs (SAN only)	SAN: FDA 1300 LUN10, LUN6
Fibre channel hosts (SAN only)	Primary Link: Cell_0: Module_0/IOC_0/PCISLOT_1 Secondary Link: Cell_3: Module_1/IOC_1/PCISLOT_1
IO resource location	0IOC0 mandatory, 0IOC1, 1IOC0, 1IOC1, 2IOC0, 2IOC1, 3IOC0 & 3IOC1 optional
Resource access	All resources unlocked
Domain Identity	
Name	MyBusiness-1
Description	Time zone: Central America
Operating System	Windows
Domain network name	MyBusiness-1Net
Domain IP address	123.123.12.1
Domain URL	http://www.MyBusiness-1Web.com
Domain CPU parameters	Monothreading mode
High memory IO space	Disabled
IO memory space optimization	Disabled
Licensing number	XAN-S11-99999/11
Substitute mode	Disabled
Halt on machine check reset	Disabled

Table 41. Scheme configuration criteria - example 1 - 4 modules server

To create a mono-domain scheme using all server resources:

1. Check that the required hardware resources are available (at least one IOC and one QBB are required for each server domain) and that the domain Operating System supports the required hardware resources (CPUs, DIMMs, ...).
2. From the Customer Administrator PAM tree, click **Configuration Tasks** → **Domains** → **Schemes** to open the **Schemes Management** pane.
3. Click **New** to open the **Scheme Creation** dialog.
4. Complete the **Scheme** and **Description** fields.

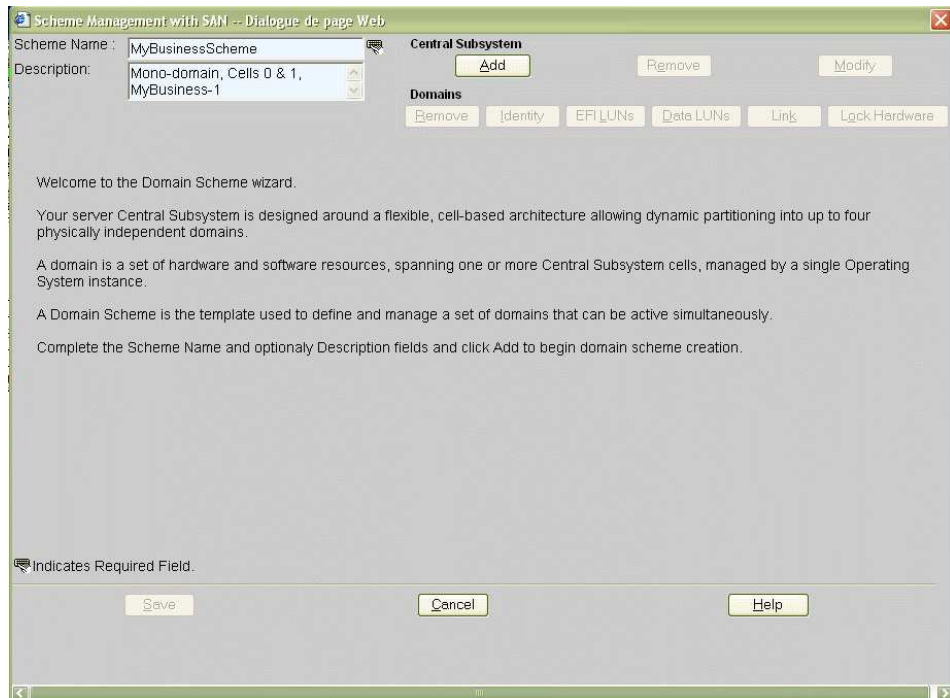
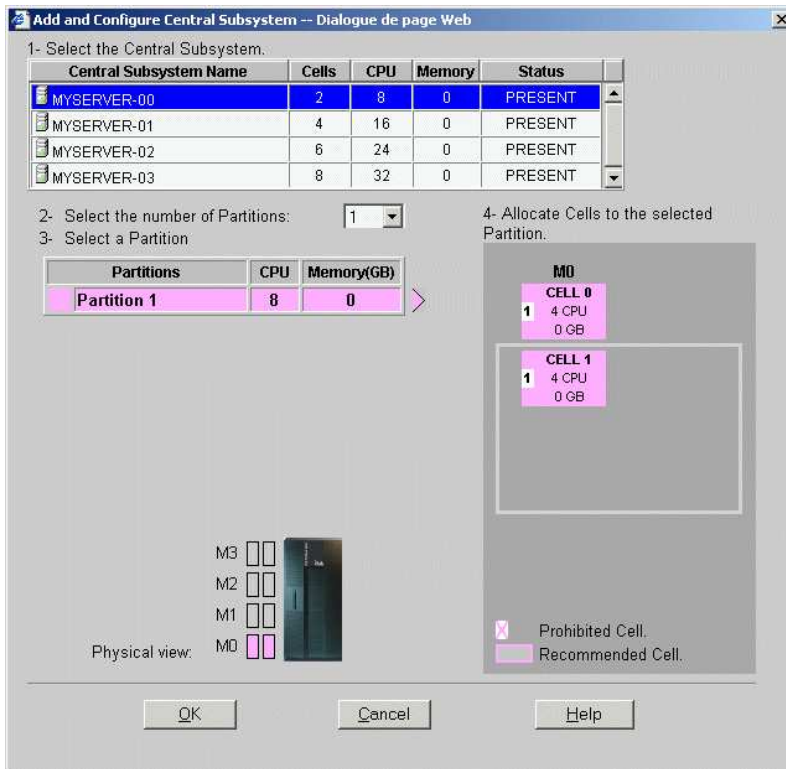

Figure 130. Scheme creation dialog - example 1

- Click **Central Subsystem** → **Add** to select the Central Subsystem to be used by the domain configuration scheme. The **Central Subsystem Configuration** dialog opens.

NovaScale 5085 Partitioned Server



NovaScale 5165 Partitioned Server

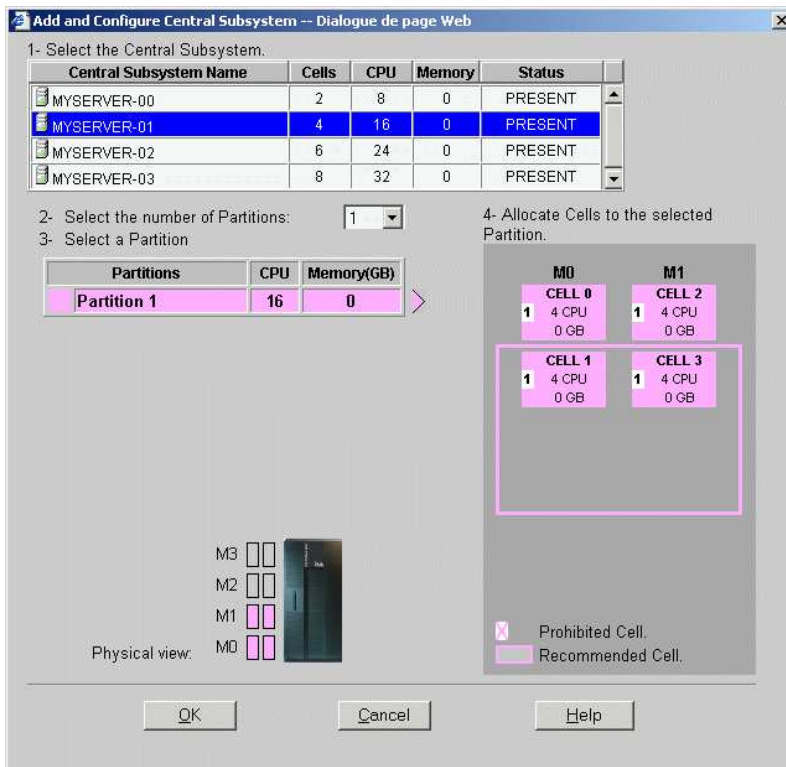

NovaScale 5245 Partitioned Server

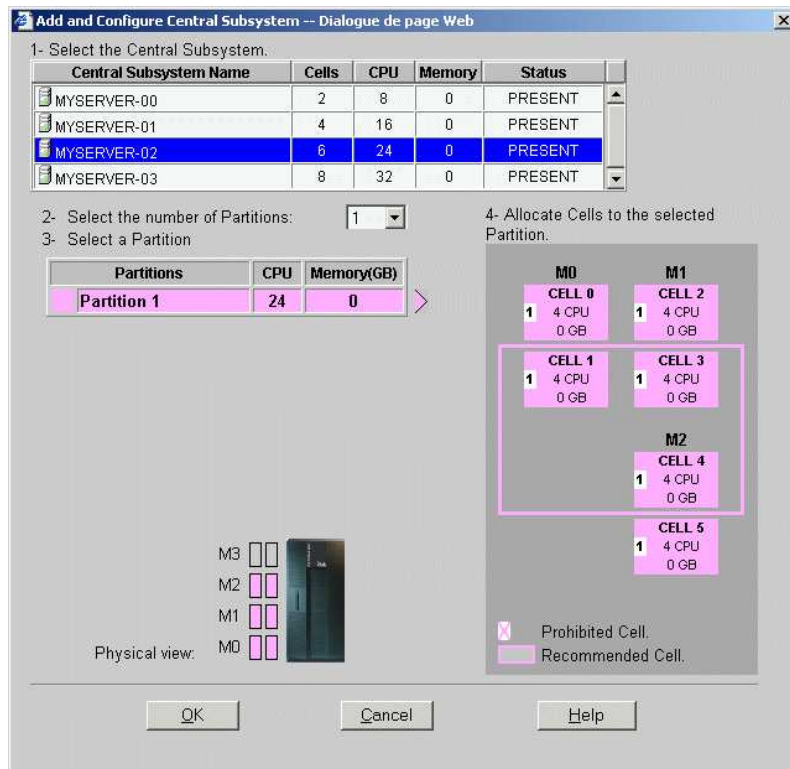

NovaScale 5325 Partitioned Server

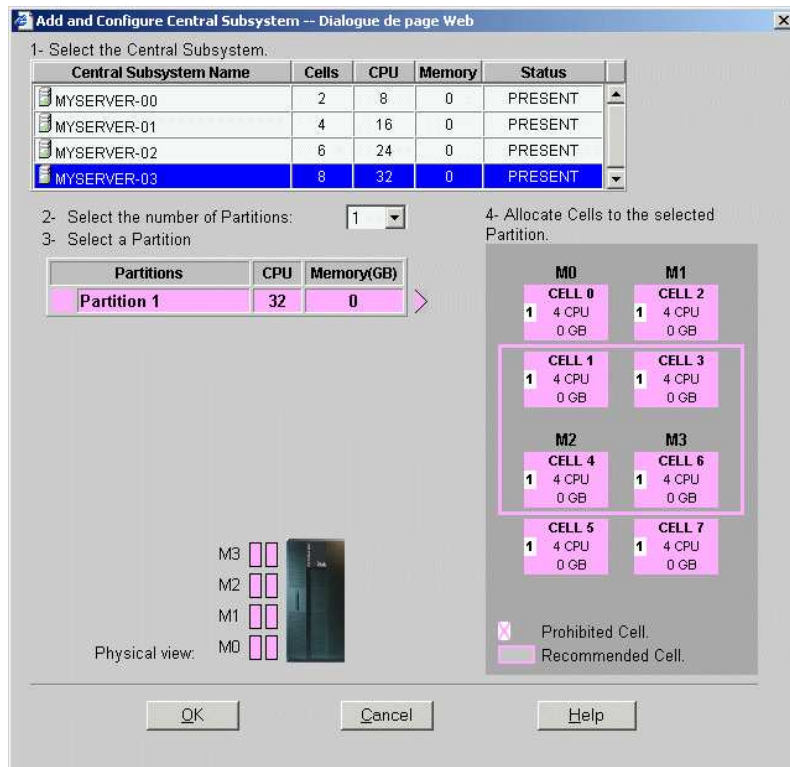

Figure 131. Central Subsystem configuration dialog - example 1

6. In the Central Subsystem list, select the required Central Subsystem.

The graphic representation of the selected Central Subsystem appears in the bottom right part of the window.

7. To create a mono-domain scheme, in the **Number of Partitions** dropdown list select **1** hardware partition.
8. To configure the partition in order to use all server resources, in the Central Subsystem graphic representation select all the cells.
9. Click **OK** to return to the **Scheme Management** dialog.

The **Status** icon is red because a **Domain Identity** and an **EFI LUN** are required to complete domain configuration.

NovaScale 5085 Partitioned Server

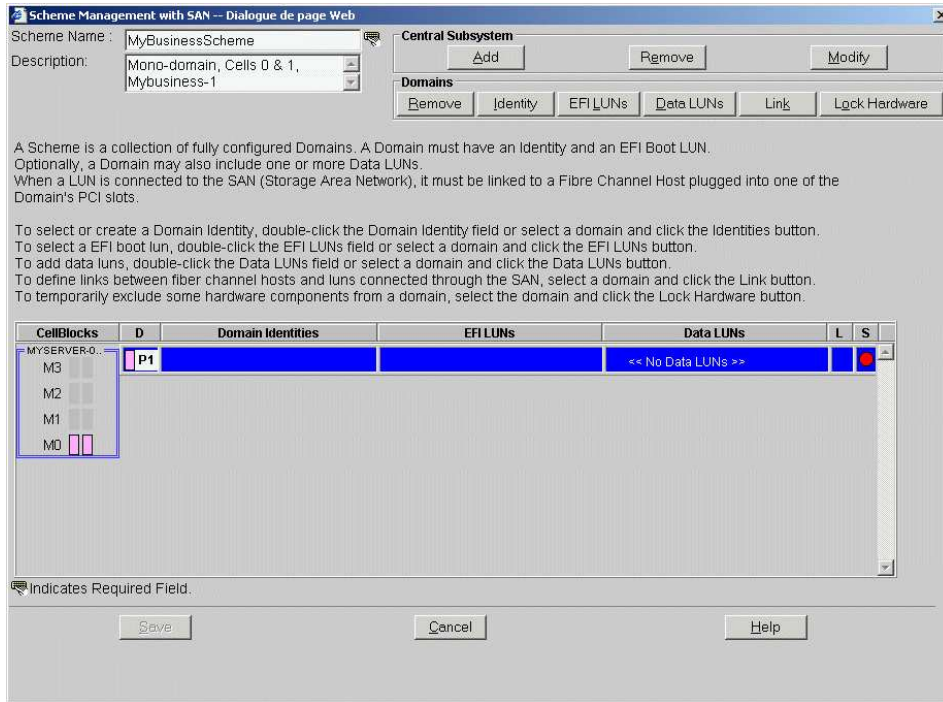

NovaScale 5165 Partitioned Server

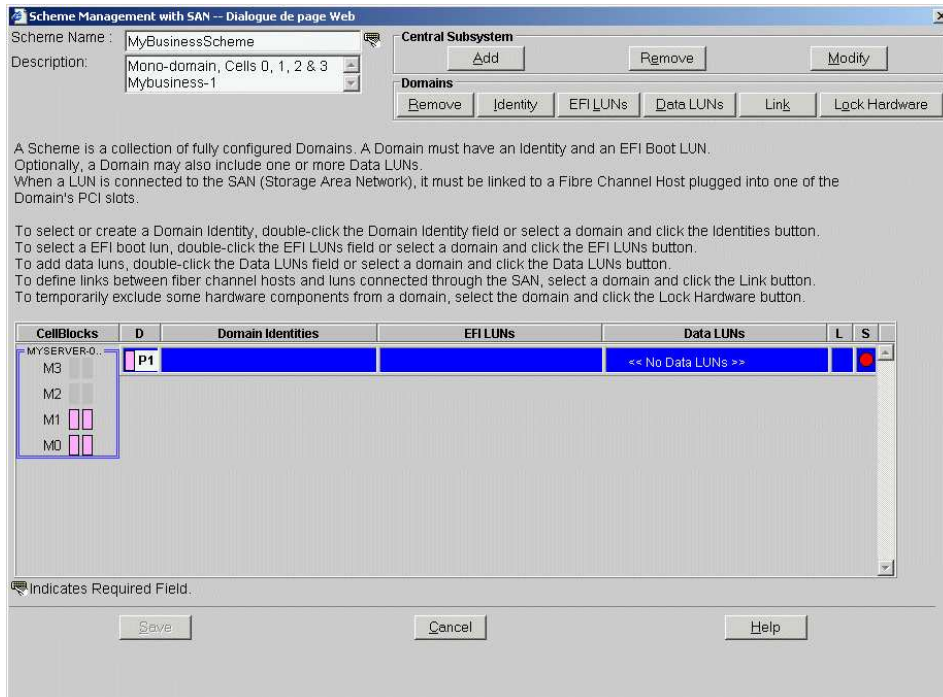

NovaScale 5245 Partitioned Server

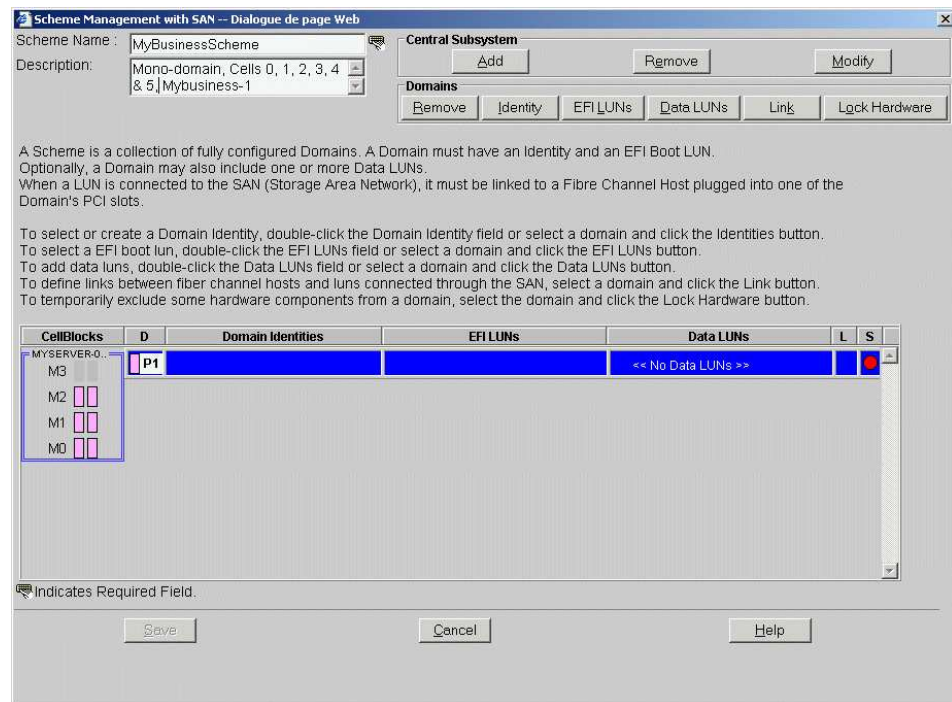

NovaScale 5325 Partitioned Server

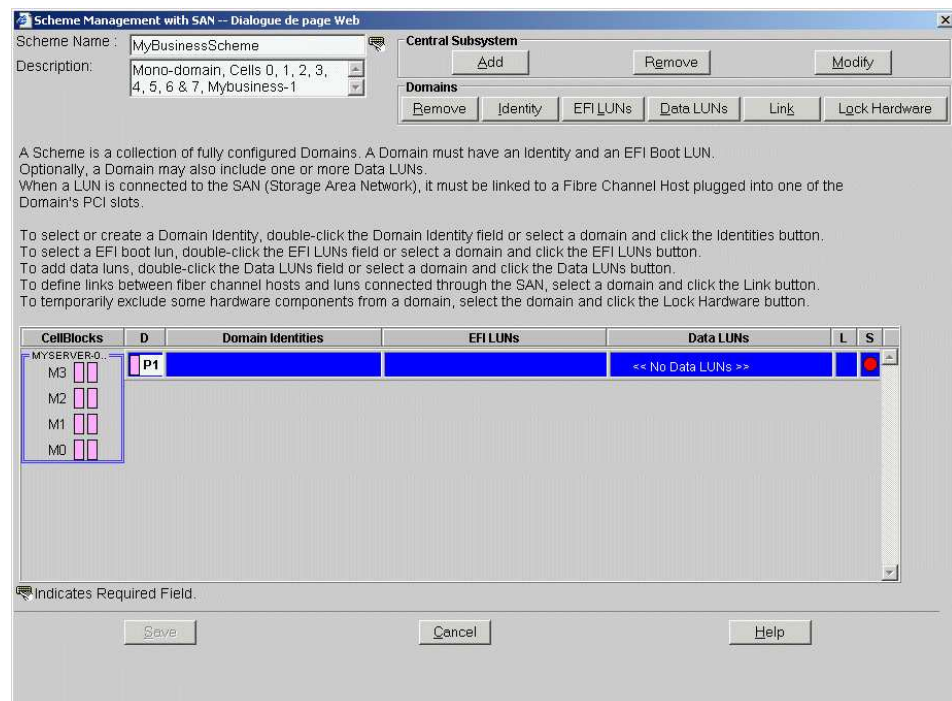

Figure 132. Scheme Management dialog - example 1

10. In the partition list, double-click the empty cell of the **P1** line and the **Domain Identities** column.

The **Identity List** dialog opens.

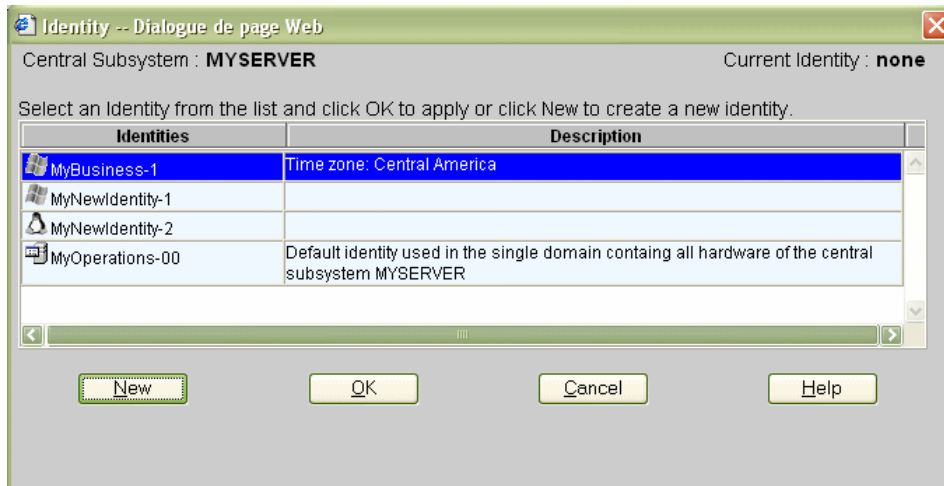

Figure 133. Identity list dialog - example 1

11. If the required identity is in the list, go to Step 16.
If you want to create a new identity for this domain, click **New** to open the **Create New Identity** dialog. See *Creating a Domain Identity*, on page 5-50 for details.

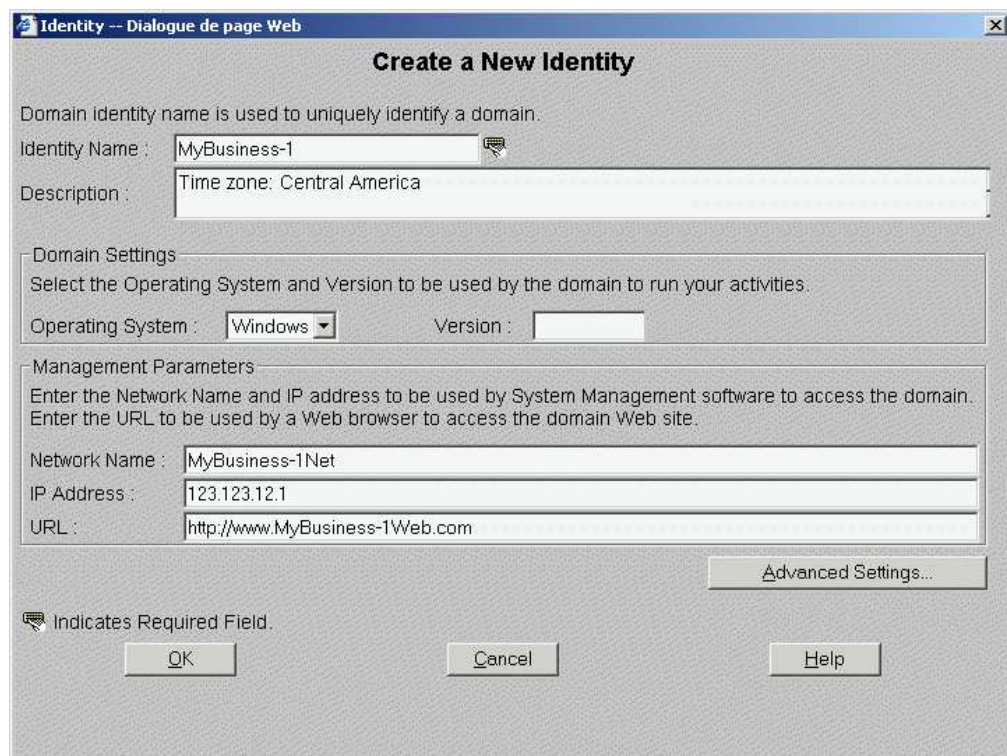

Figure 134. Create new identity dialog - example 1

12. Complete the **Name**, **Description**, **Domain Settings** and **Management Parameters** fields as required.
13. Click **Advanced Settings** to open the **Advanced Identity Settings** dialog.

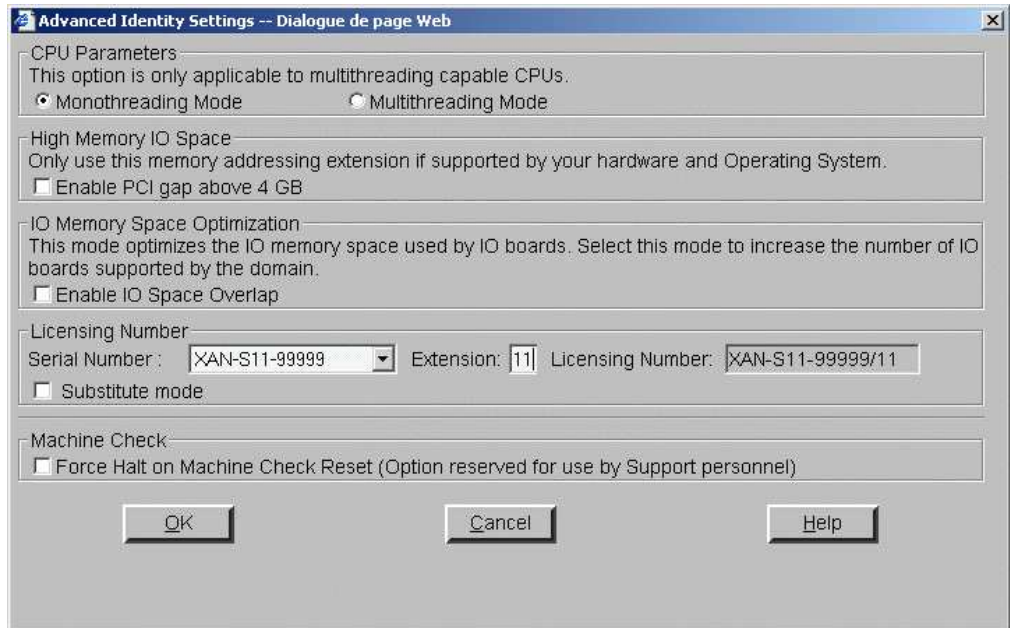

Figure 135. Create new identity advanced setting dialog - example 1

14. Complete the **Advanced Identity Settings** dialog fields as required and click **OK** to return to the **Create new identity** dialog.
15. Click **OK**. The new identity appears in the **Identities List** dialog.
16. Select the required identity from the list of available identities and click **OK** to return to the **Scheme Management** dialog. The selected identity is now displayed in the **Domain Identities** field.
17. Double-click the **EFI LUNs** field. The **Select EFI LUN** dialog opens, allowing you to choose the required EFI Boot LUN from the list of available LUNs.

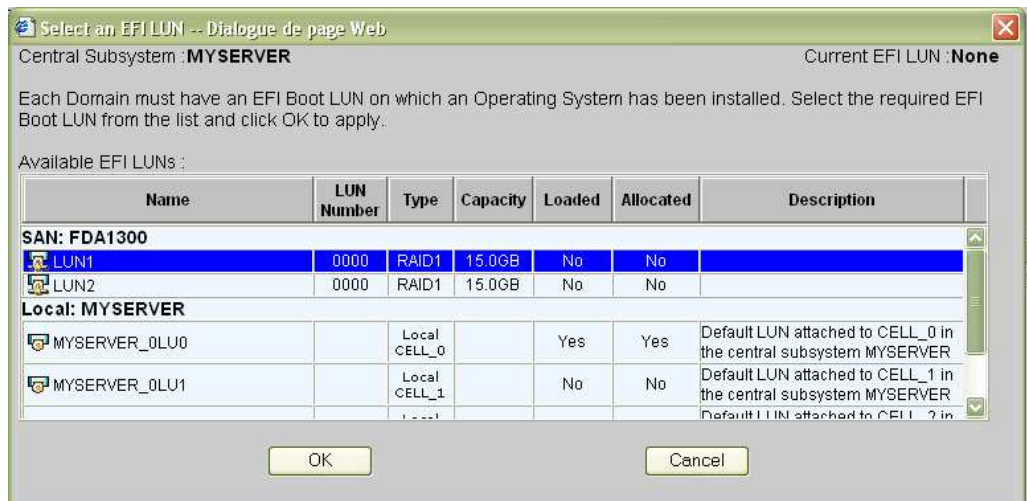

Figure 136. Select EFI LUN dialog - example 1

18. Select the required EFI Boot LUN from the list of available LUNs and click **OK** to return to the **Scheme Management** dialog. The selected LUN is now displayed in the **EFI LUNs** field.

As the selected LUN is a SAN LUN, the **Status** icon remains red and the **No Link** icon  appears.

19. Double-click the **Data LUNs** field. The **Select Data LUN** dialog opens, allowing you to choose the required Data LUNs from the list of available LUNs.

20. Select the required Data LUNs from the list of available LUNs and click **Add** to move the selected Data LUNs to the **Data LUNs selected** list.

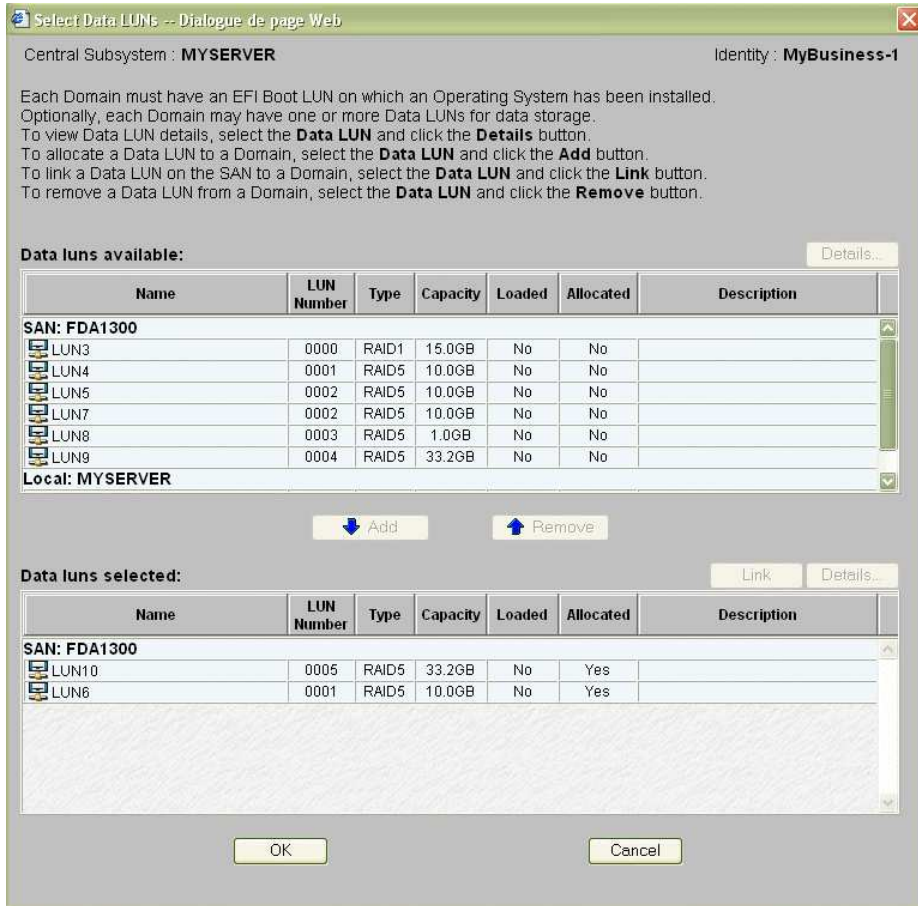

Figure 137. Select Data LUN dialog - example 1

21. Click **OK** to return to the **Scheme Management** dialog. **Data LUN set** is now displayed in the **Data LUNs** field.

The **Status** icon remains red and the **No Link** icon  is displayed. You must now link the selected EFI and Data LUNs to the Fibre Channel Host you want to use to access these LUNs.

22. Click **Domains** → **Link** to open the **Link LUNs to HBA** dialog.

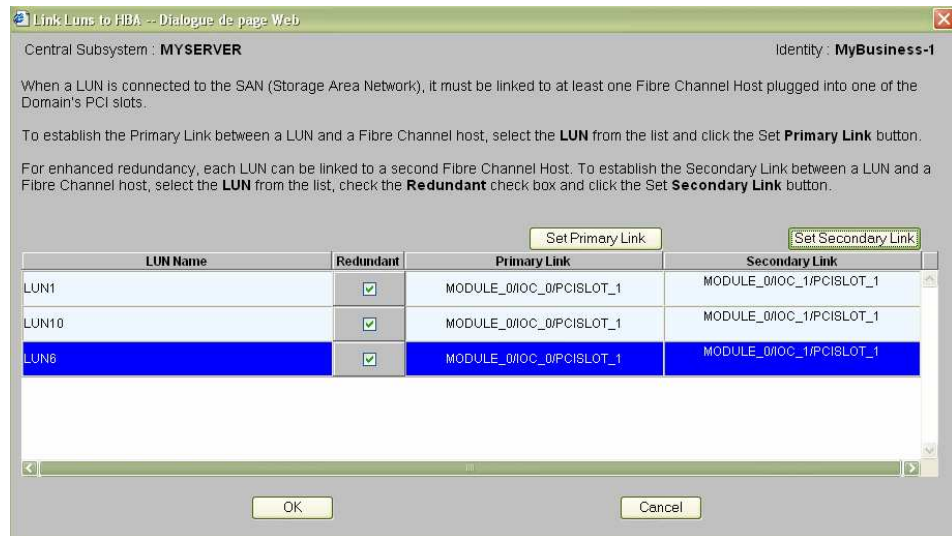

Figure 138. Link LUN to HBA dialog - example 1

23. Select the first LUN in the list and select the **Redundant** mode.

You are informed that dedicated software is required to enable this mode and you are requested to confirm your choice.
Click **OK** to confirm.

24. Click **Set Primary Link** to define the main access path to the SAN. The **Select HBA** dialog opens, allowing you to select the domain PCI slot you want to use to access the LUN.

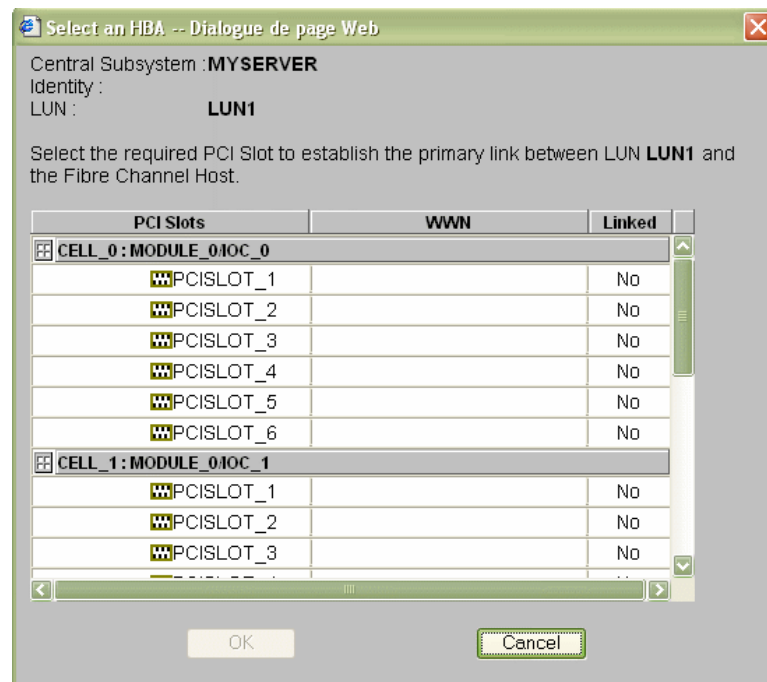



Figure 139. Select HBA dialog - example 1

25. Select the required PCI slot and click **OK**. The primary link is now set.

26. Click **Set Secondary Link** to define the backup access path to the SAN.

27. Select the required PCI slot and click **OK**. The secondary link is now set.

28.Repeat Steps 23 to 27 for each LUN in the list and click **OK** → **Apply** to return to the **Scheme Management** dialog. The **Status** icon turns green and the **Linked** icon  appears.

29.Click **Save**. The domain configuration scheme is now available for domain management.

Creating a Mono-Domain Scheme Using a Selection of Server Resources

Notes:

- A domain configuration scheme can include more than one Central Subsystems. If you have more than one Bull NovaScale Server, see *Configuring and Managing Extended Systems*, on page 5-125.
- For more information about scheme and identity configuration options, refer to:
 - *Assessing Configuration Requirements*, on page 5-31
 - *Creating a Domain Configuration Scheme*, on page 5-33
 - *Creating a Domain Identity*, on page 5-50

The configuration criteria set out in the following tables is used to illustrate this example:

NovaScale 5085 Partitioned Server

Scheme	
Name	MyOffpeakProdScheme
Description	Mono-domain, Cell 1, MyOffpeakProd
Central Subsystem(s)	MYSERVER-00
Number of domains	1
Domain size	1 cell: Cell 1
EFI boot LUNs	SAN: FDA1300 LUN1
Data LUNs (SAN only)	SAN: FDA 1300 LUN10, LUN6
Fibre channel hosts (SAN only)	Primary Link: Cell_1: Module_0/IOC_1/PCISLOT_1
IO resource location	OIOC1
Resource access	All resources unlocked
Domain Identity	
Name	MyOffpeakProd
Description	Time zone: Paris
Operating System	Linux
Domain network name	MyOffpeakProdNet
Domain IP address	124.124.1.0
Domain URL	http://www.MyOffpeakProdWeb.com
Domain CPU parameters	Monothreading mode
High memory IO space	Disabled
IO memory space optimization	Disabled
Licensing number	XAN-S11-99999/12
Substitute mode	Enabled
Halt on machine check reset	Disabled

Table 42. Scheme configuration criteria - example 2 - mono-module server

NovaScale 5165 Partitioned Server

Scheme	
Name	MyOffpeakProdScheme
Description	Mono-domain, Cell 1, Boot 0Lun1, MyOffpeakProd
Central Subsystem(s)	MYSERVER-01
Number of domains	1
Domain size	1 cell: Cell 1
EFI boot LUNs	SAN: FDA1300 LUN1
Data LUNs (SAN only)	SAN: FDA 1300 LUN10, LUN6
Fibre channel hosts (SAN only)	Primary Link: Cell_1: Module_0/IOC_1/PCISLOT_1
IO resource location	OIOC1
Resource access	All resources unlocked
Domain Identity	
Name	MyOffpeakProd
Description	Time zone: Paris
Operating System	Linux
Domain network name	MyOffpeakProdNet
Domain IP address	124.124.1.0
Domain URL	http://www.MyOffpeakProdWeb.com
Domain CPU parameters	Monothreading mode
High memory IO space	Disabled
IO memory space optimization	Disabled
Licensing number	XAN-S11-999999/12
Substitute mode	Enabled
Halt on machine check reset	Disabled

Table 43. Scheme configuration criteria - example 2 - bi-module server

NovaScale 5245 Partitioned Server

Scheme	
Name	MyOffpeakProdScheme
Description	Mono-domain, Cell 1, Boot 0Lun1, MyOffpeakProd
Central Subsystem(s)	MYSERVER-02
Number of domains	1
Domain size	1 cell: Cell 1
EFI boot LUNs	SAN: FDA1300 LUN1
Data LUNs (SAN only)	SAN: FDA 1300 LUN10, LUN6
Fibre channel hosts (SAN only)	Primary Link: Cell_1: Module_0/IOC_1/PCISLOT_1
IO resource location	OIOC1
Resource access	All resources unlocked
Domain Identity	
Name	MyOffpeakProd
Description	Time zone: Paris
Operating System	Linux
Domain network name	MyOffpeakProdNet
Domain IP address	124.124.1.0
Domain URL	http://www.MyOffpeakProdWeb.com
Domain CPU parameters	Monothreading mode
High memory IO space	Disabled
IO memory space optimization	Disabled
Licensing number	XAN-S11-99999/12
Substitute mode	Enabled
Halt on machine check reset	Disabled

Table 44. Scheme configuration criteria - example 2 - 3 modules server

NovaScale 5325 Partitioned Server

Scheme	
Name	MyOffpeakProdScheme
Description	Mono-domain, Cell 1, Boot 0Lun1, MyOffpeakProd
Central Subsystem(s)	MYSERVER-03
Number of domains	1
Domain size	1 cell: Cell 1
EFI boot LUNs	SAN: FDA1300 LUN1
Data LUNs (SAN only)	SAN: FDA 1300 LUN10, LUN6
Fibre channel hosts (SAN only)	Primary Link: Cell_1: Module_0/IOC_1/PCISLOT_1
IO resource location	OIOC1
Resource access	All resources unlocked
Domain Identity	
Name	MyOffpeakProd
Description	Time zone: Paris
Operating System	Linux
Domain network name	MyOffpeakProdNet
Domain IP address	124.124.1.0
Domain URL	http://www.MyOffpeakProdWeb.com
Domain CPU parameters	Monothreading mode
High memory IO space	Disabled
IO memory space optimization	Disabled
Licensing number	XAN-S11-99999/12
Substitute mode	Enabled
Halt on machine check reset	Disabled

Table 45. Scheme configuration criteria - example 2 - 4 modules server

To create a mono-domain scheme using a part of server resources:

1. Check that the required hardware resources are available (at least one IOC and one QBB are required for each server domain) and that the domain Operating System supports the required hardware resources (CPUs, DIMMs, ...).
2. From the Customer Administrator PAM tree, click **Configuration Tasks** → **Domains** → **Schemes** to open the **Schemes Management** pane.
3. Click **New** to open the **Scheme Creation** dialog.
4. Complete the **Scheme** and **Description** fields.

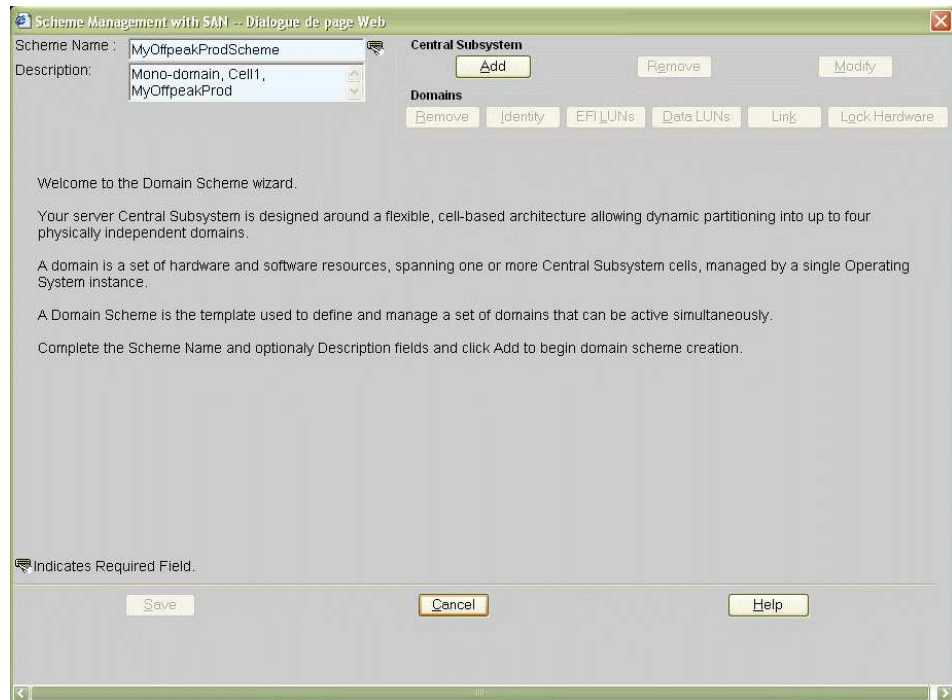
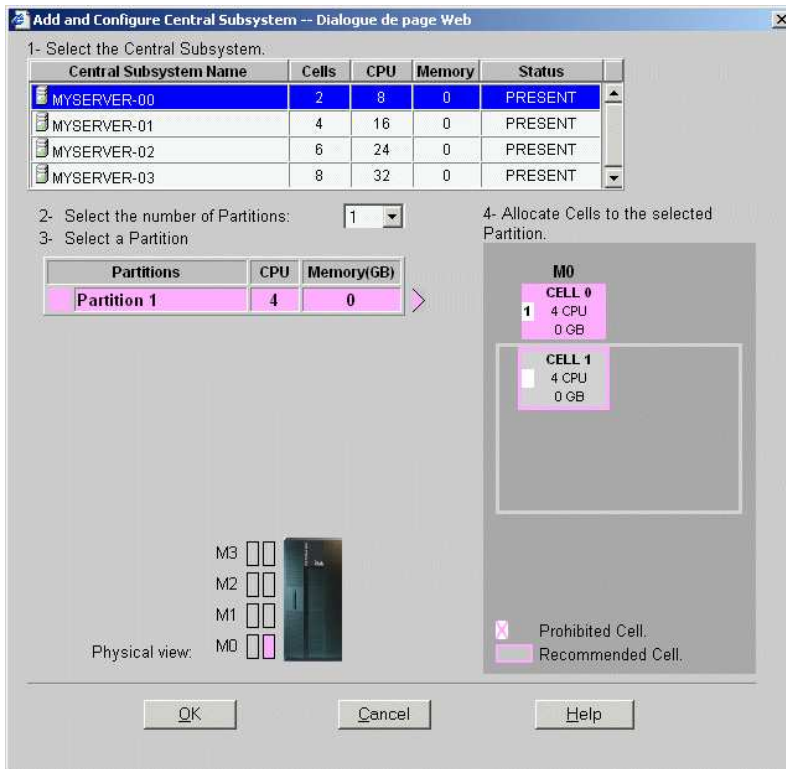

Figure 140. Scheme creation dialog - example 2

- Click **Central Subsystem** → **Add** to select the Central Subsystem to be used by the domain configuration scheme. The **Central Subsystem Configuration** dialog opens.

NovaScale 5085 Partitioned Server



NovaScale 5165 Partitioned Server

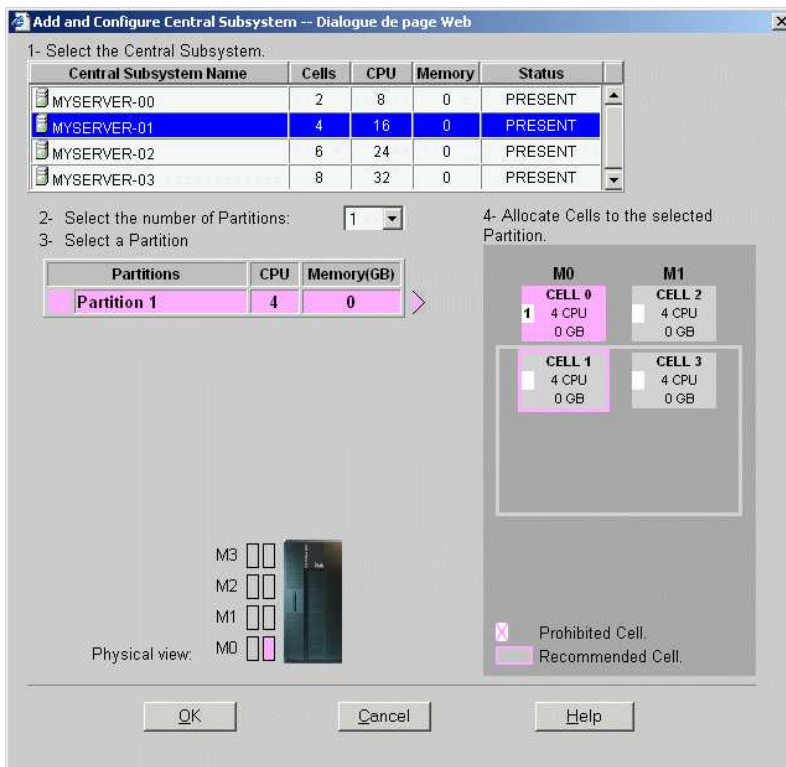

NovaScale 5245 Partitioned Server

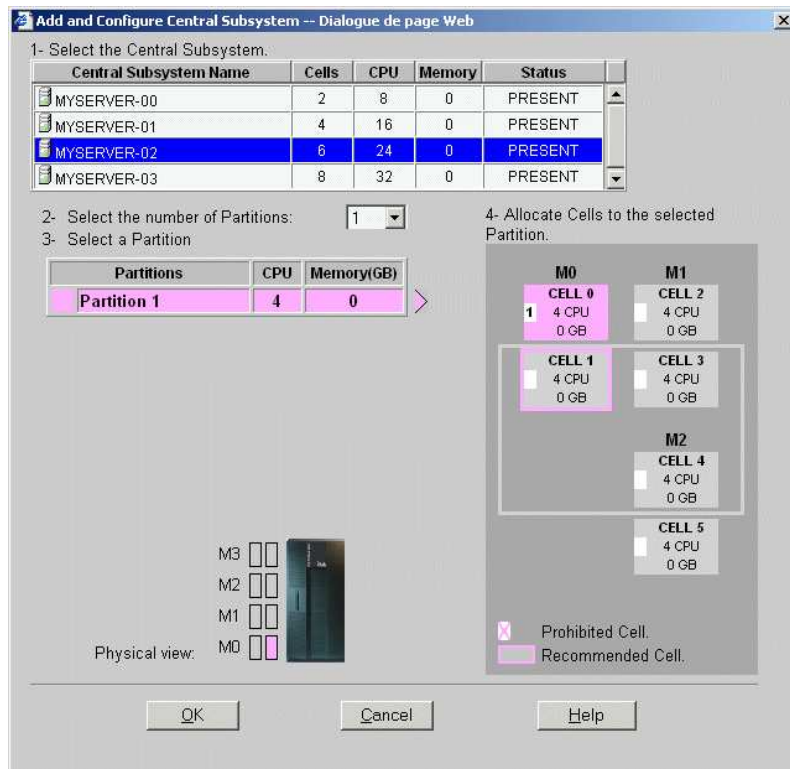

NovaScale 5325 Partitioned Server

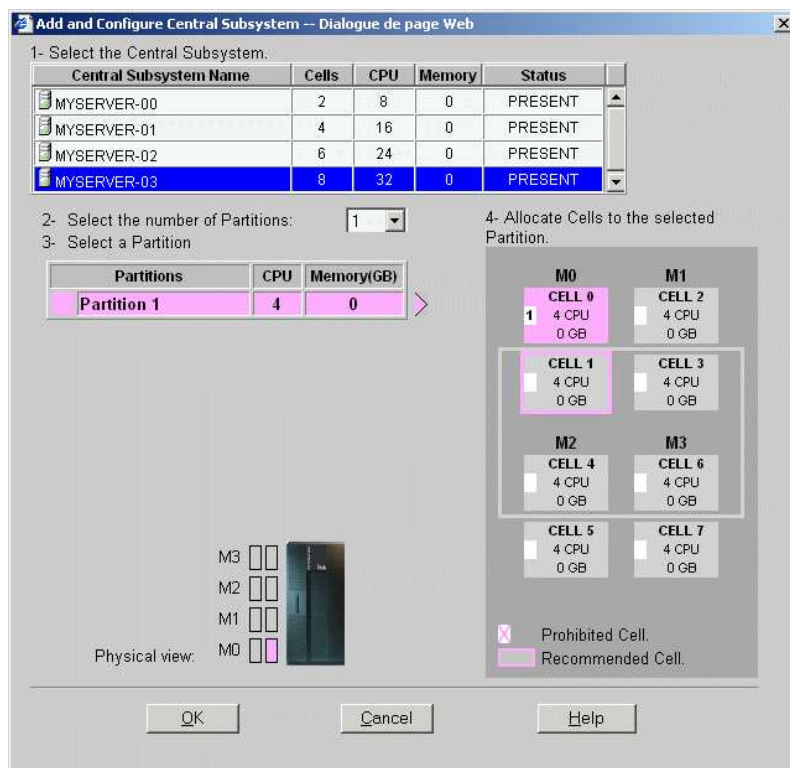

Figure 141. Central Subsystem configuration dialog - example 2

6. In the Central Subsystem list, select the required Central Subsystem.

The graphic representation of the selected Central Subsystem appears in the bottom right part of the window.

7. To create a mono-domain scheme, in the **Number of Partitions** dropdown list select **1** hardware partition.
8. To configure the partition in order to use a particular cell, in the Central Subsystem graphic representation select the required cell.
9. Click **OK** to return to the **Scheme Management** dialog.

The **Status** icon is red because a **Domain Identity** and an **EFI LUN** are required to complete domain configuration.

NovaScale 5085 Partitioned Server

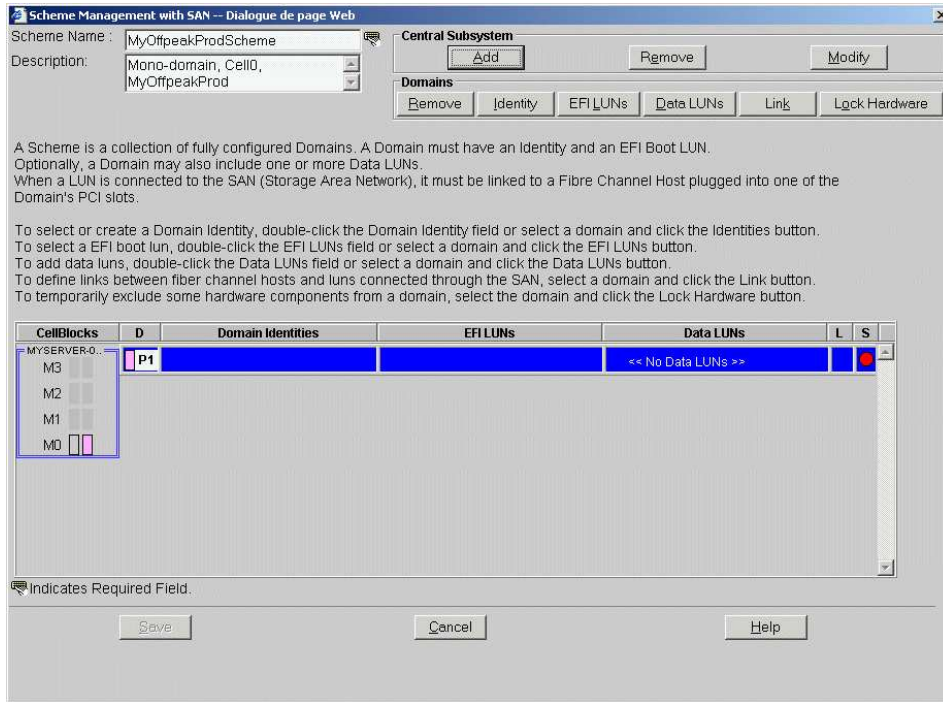

NovaScale 5165 Partitioned Server

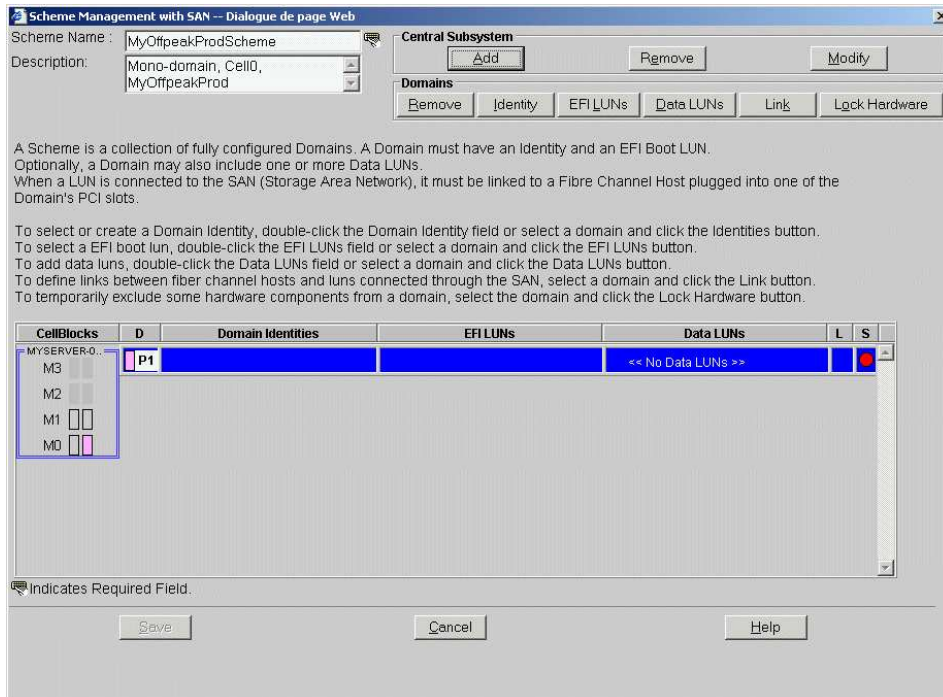

NovaScale 5245 Partitioned Server

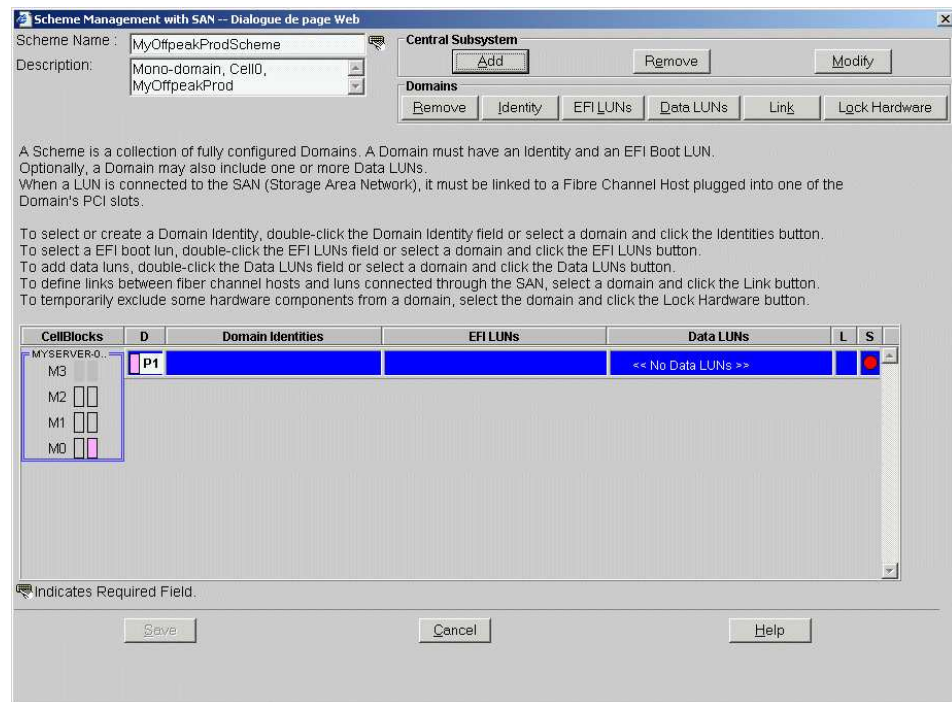

NovaScale 5325 Partitioned Server

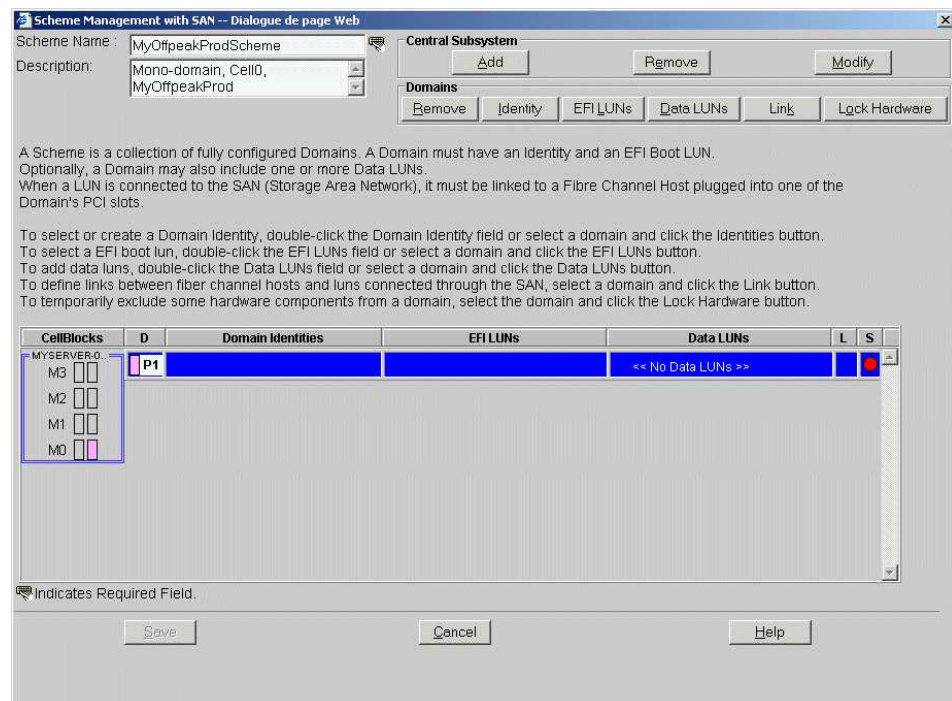

Figure 142. Scheme Management dialog - example 2

10. In the partition list, double-click the empty cell of the **P1** line and the **Domain Identities** column.

The **Identity List** dialog opens.

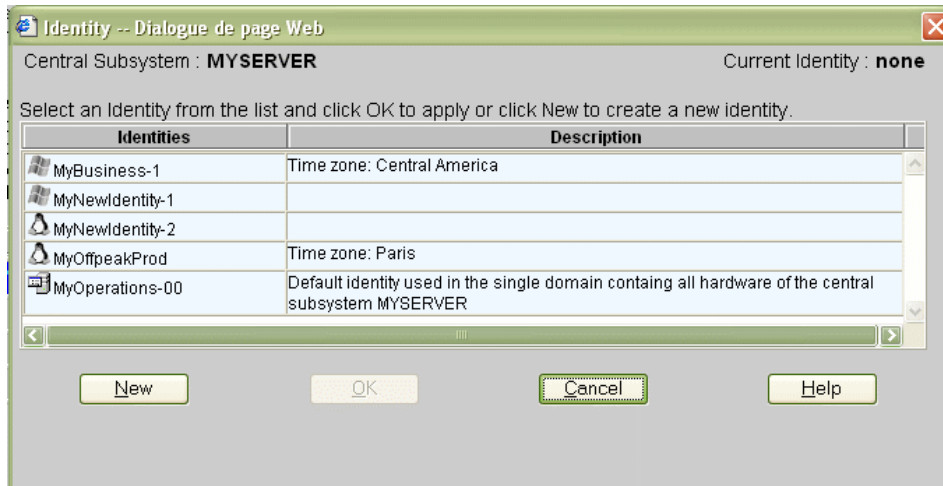

Figure 143. Identity list dialog - example 2

11. If the required identity is in the list, go to Step 16.
If you want to create a new identity for this domain, click **New** to open the **Create New Identity** dialog. See *Creating a Domain Identity*, on page 5-50 for details.

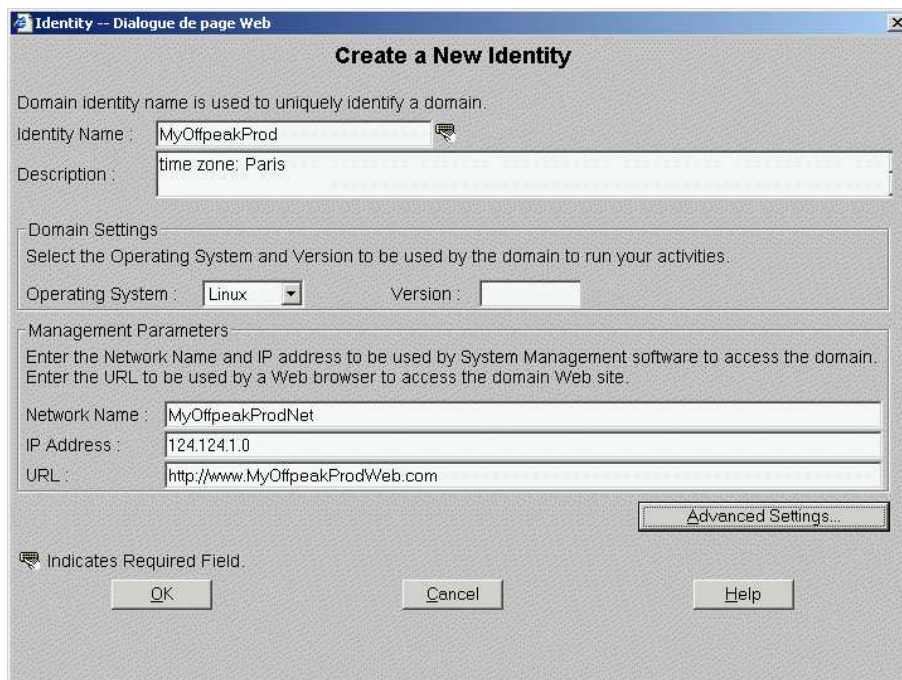

Figure 144. Create new identity advanced setting dialog - example 2

12. Complete the **Name**, **Description**, **Domain Settings** and **Management Parameters** fields as required.
13. Click **Advanced Settings** to open the **Advanced Identity Settings** dialog.

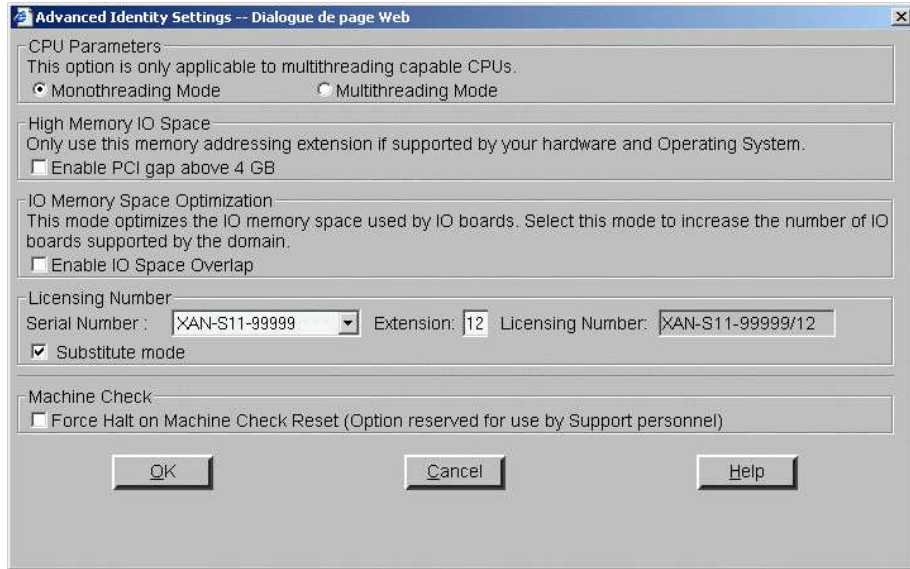

Figure 145. Create new identity advanced setting dialog - example 2

14. Complete the **Advanced Identity Settings** dialog fields as required and click **OK** to return to the **Create new identity** dialog.
15. Click **OK**. The new identity appears in the **Identities List** dialog.
16. Select the required identity from the list of available identities and click **OK** to return to the **Scheme Management** dialog. The selected identity is now displayed in the **Domain Identities** field.
17. Double-click the **EFI LUNs** field. The **Select EFI LUN** dialog opens, allowing you to choose the required EFI Boot LUN from the list of available LUNs.

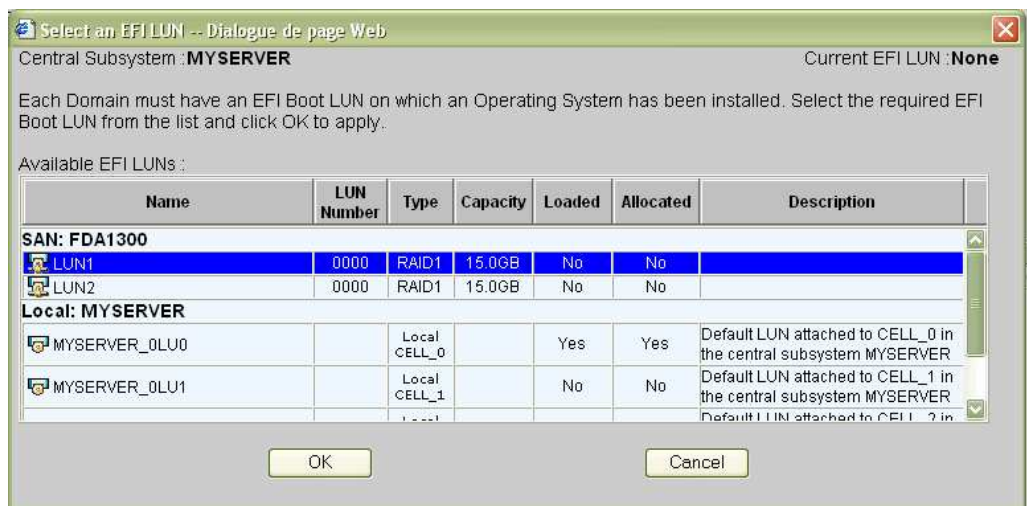

Figure 146. Select EFI LUN dialog - example 2

18. Select the required EFI Boot LUN from the list of available LUNs and click **OK** to return to the **Scheme Management** dialog. The selected LUN is now displayed in the **EFI LUNs** field.

As the selected LUN is a SAN LUN, the **Status** icon remains red and the **No Link** icon  appears.

19. Double-click the **Data LUNs** field. The **Select Data LUN** dialog opens, allowing you to choose the required Data LUNs from the list of available LUNs.

20. Select the required Data LUNs from the list of available LUNs and click **Add** to move the selected Data LUNs to the **Data LUNs selected** list.

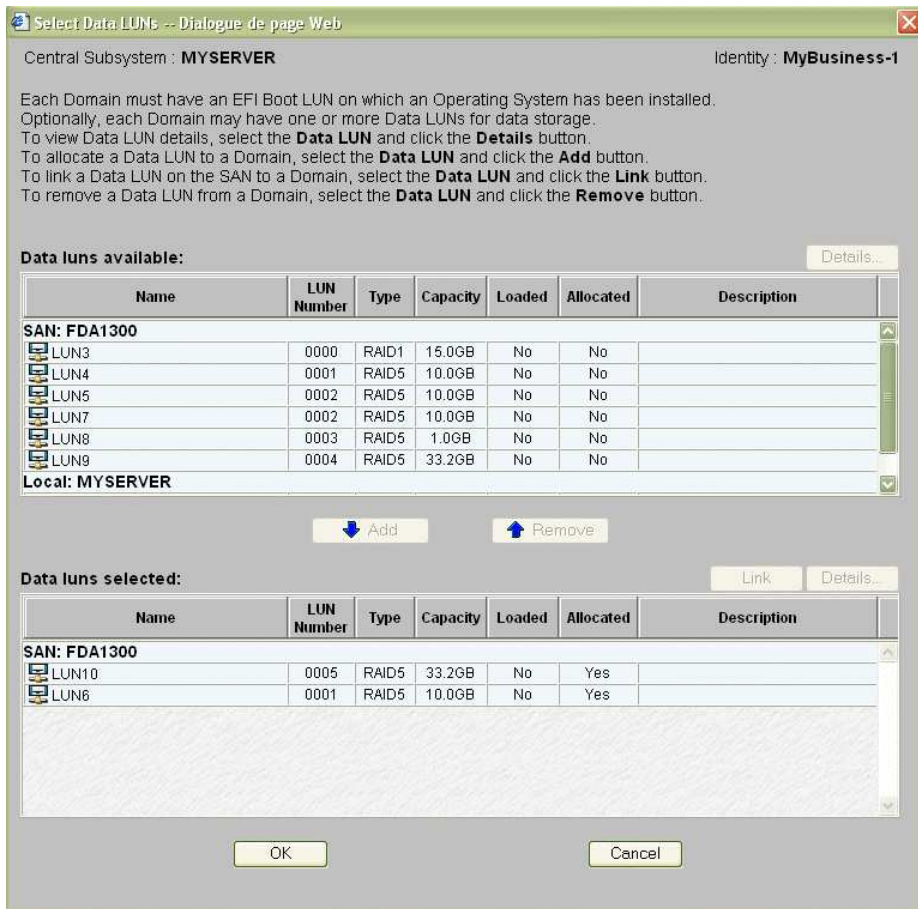

Figure 147. Select Data LUN dialog - example 2

21. Click **OK** to return to the **Scheme Management** dialog. **Data LUN set** is now displayed in the **Data LUNs** field.

The **Status** icon remains red and the **No Link** icon  is displayed. You must now link the selected EFI and Data LUNs to the Fibre Channel Host you want to use to access these LUNs.

22. Click **Domains** → **Link** to open the **Link LUNs to HBA** dialog.

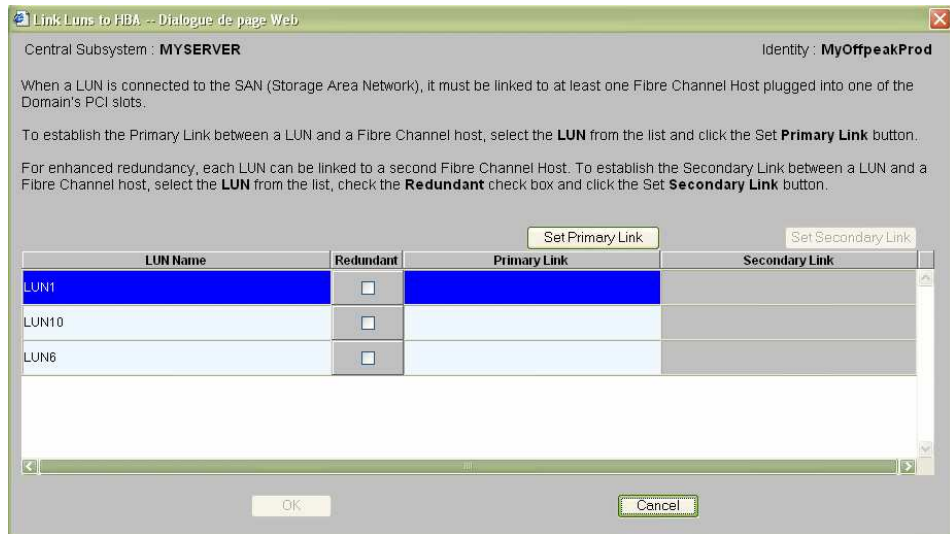

Figure 148. Link LUN to HBA dialog - example 2

23. Select the first LUN in the list and click **Set Primary Link** to define the main access path to the SAN. The **Select HBA** dialog opens, allowing you to select the domain PCI slot you want to use to access the LUN.

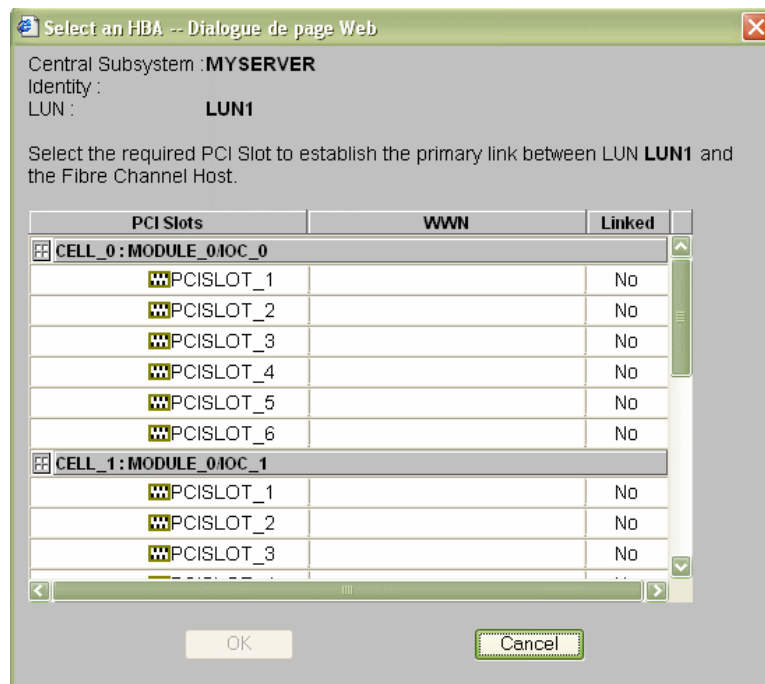



Figure 149. Select HBA dialog - example 2

24. Select the required PCI slot and click **OK**. The primary link is now set.

25. Repeat Steps 23 to 24 for each LUN in the list and click **OK** → **Apply** to return to the **Scheme Management** dialog. The **Status** icon turns green and the **Linked** icon  appears.

26. Click **Save**. The domain configuration scheme is now available for domain management.

Creating a Multi-Domain Scheme Using All Server Resources

 **Notes:**

- A domain configuration scheme can include more than one Central Subsystems. If you have more than one Bull NovaScale Server, see *Configuring and Managing Extended Systems*, on page 5-125.
- For more information about scheme and identity configuration options, refer to:
 - *Assessing Configuration Requirements*, on page 5-31
 - *Creating a Domain Configuration Scheme*, on page 5-33
 - *Creating a Domain Identity*, on page 5-50

The configuration criteria set out in the following tables is used to illustrate this example:

NovaScale 5085 Partitioned Server

Scheme	
Name	MyProd_PayrollScheme
Description	Multi-domain, Cells 0 & 1, MyProduction & MyPayroll
Central Subsystem(s)	MYSERVER-00
Number of domains	2
Domain size	1 cell per domain: Cell 0 for MyProduction (Domain 1) Cell 1 for MyPayroll (Domain 2)
EFI boot LUNs	SAN: FDA 1300 LUN1 for MyProduction Local: 0Lun1 for MyPayroll
Data LUNs (SAN only)	SAN: FDA 1300 LUN10, LUN6 for MyProduction SAN: FDA 1300 LUN4 for MyPayroll
Fibre channel hosts (SAN only)	MyProduction: Primary Link: Cell_0: Module_0/IOC_0/PCISLOT_1 MyPayroll: Primary Link: Cell_1: Module_0/IOC_1/PCISLOT_1
IO resource location	OIOC0 for MyProduction OIOC1 for MyPayroll
Resource access	All resources unlocked
Domain Identity 1	
Name	MyProduction
Description	Time zone: Vladivostok
Operating System	Windows
Domain network name	MyProductionNet
Domain IP address	121.121.12.1
Domain URL	http://www.MyProductionWeb.com
Domain CPU parameters	Monothreading mode
High memory IO space	Disabled
IO memory space optimization	Disabled
Licensing number	XAN-S11-99999/13
Substitute mode	Enabled
Halt on machine check reset	Disabled
Domain Identity 2	
Name	MyPayroll
Description	Time zone: Paris
Operating System	Linux
Domain network name	MyPayrollNet
Domain IP address	122.122.1.0
Domain URL	http://www.MyPayrollWeb.com
Domain CPU parameters	Monothreading mode
High memory IO space	Disabled
IO memory space optimization	Disabled
Licensing number	XAN-S11-99999/14
Substitute mode	Enabled
Halt on machine check reset	Disabled

Table 46. Scheme configuration criteria - example 3 - mono-module server

NovaScale 5165 Partitioned Server

Scheme	
Name	MyProd_PayrollScheme
Description	Multi-domain, Cells 0, 1, 2 & 3, MyProduction & MyPayroll
Central Subsystem(s)	MYSERVER-01
Number of domains	2
EFI boot LUNs	SAN: FDA 1300 LUN1 for MyProduction Local: 0Lun3 for MyPayroll
Data LUNs (SAN only)	SAN: FDA 1300 LUN10, LUN6 for MyProduction SAN: FDA 1300 LUN4 for MyPayroll
Fibre channel hosts (SAN only)	MyProduction: Primary Link: Cell_0: Module_0/IOC_0/PCISLOT_1 MyPayroll: Primary Link: Cell_3: Module_1/IOC_1/PCISLOT_1
IO resource location	0IOC0 mandatory, 0IOC1 & 1IOC0 optional, for MyProduction 1IOC1 mandatory for MyPayroll
Resource access	All resources unlocked
Domain Identity 1	
Name	MyProduction
Description	Time zone: Vladivostok
Operating System	Windows
Domain network name	MyProductionNet
Domain IP address	121.121.12.1
Domain URL	http://www.MyProductionWeb.com
Domain CPU parameters	Monothreading mode
High memory IO space	Disabled
IO memory space optimization	Disabled
Licensing number	XAN-S11-99999/13
Substitute mode	Enabled
Halt on machine check reset	Disabled
Domain Identity 2	
Name	MyPayroll
Description	Time zone: Paris
Operating System	Linux
Domain network name	MyPayrollNet
Domain IP address	122.122.1.0
Domain URL	http://www.MyPayrollWeb.com
Domain CPU parameters	Monothreading mode
High memory IO space	Disabled
IO memory space optimization	Disabled
Licensing number	XAN-S11-99999/14
Substitute mode	Enabled
Halt on machine check reset	Disabled

Table 47. Scheme configuration criteria - example 3 - bi-module server

NovaScale 5245 Partitioned Server

Scheme	
Name	MyProd_PayrollScheme
Description	Multi-domain, Cells 0 to 5, MyProduction & MyPayroll
Central Subsystem(s)	MYSERVER-02
Number of domains	2
EFI boot LUNs	SAN: FDA 1300 LUN1 for MyProduction Local: 0Lun3 for MyPayroll
Data LUNs (SAN only)	SAN: FDA 1300 LUN10, LUN6 for MyProduction SAN: FDA 1300 LUN4 for MyPayroll
Fibre channel hosts (SAN only)	MyProduction: Primary Link: Cell_0: Module_0/IOC_0/PCISLOT_1 MyPayroll: Primary Link: Cell_3: Module_1/IOC_1/PCISLOT_1
IO resource location	0IOC0 mandatory, 0IOC1 & 1IOC0 optional, for MyProduction 1IOC1 mandatory for MyPayroll
Resource access	All resources unlocked
Domain Identity 1	
Name	MyProduction
Description	Time zone: Vladivostok
Operating System	Windows
Domain network name	MyProductionNet
Domain IP address	121.121.12.1
Domain URL	http://www.MyProductionWeb.com
Domain CPU parameters	Monothreading mode
High memory IO space	Disabled
IO memory space optimization	Disabled
Licensing number	XAN-S11-99999/13
Substitute mode	Enabled
Halt on machine check reset	Disabled
Domain Identity 2	
Name	MyPayroll
Description	Time zone: Paris
Operating System	Linux
Domain network name	MyPayrollNet
Domain IP address	122.122.1.0
Domain URL	http://www.MyPayrollWeb.com
Domain CPU parameters	Monothreading mode
High memory IO space	Disabled
IO memory space optimization	Disabled
Licensing number	XAN-S11-99999/14
Substitute mode	Enabled
Halt on machine check reset	Disabled

Table 48. Scheme configuration criteria - example 3 - 3 modules server

NovaScale 5325 Partitioned Server

Scheme	
Name	MyProd_PayrollScheme
Description	Multi-domain, Cells 0 to 7, MyProduction & MyPayroll
Central Subsystem(s)	MYSERVER-03
Number of domains	2
EFI boot LUNs	SAN: FDA 1300 LUN1 for MyProduction Local: 0Lun3 for MyPayroll
Data LUNs (SAN only)	SAN: FDA 1300 LUN10, LUN6 for MyProduction SAN: FDA 1300 LUN4 for MyPayroll
Fibre channel hosts (SAN only)	MyProduction: Primary Link: Cell_0: Module_0/IOC_0/PCISLOT_1 MyPayroll: Primary Link: Cell_3: Module_1/IOC_1/PCISLOT_1
IO resource location	0IOC0 mandatory, 0IOC1 & 1IOC0 optional, for MyProduction 1IOC1 mandatory for MyPayroll
Resource access	All resources unlocked
Domain Identity 1	
Name	MyProduction
Description	Time zone: Vladivostok
Operating System	Windows
Domain network name	MyProductionNet
Domain IP address	121.121.12.1
Domain URL	http://www.MyProductionWeb.com
Domain CPU parameters	Monothreading mode
High memory IO space	Disabled
IO memory space optimization	Disabled
Licensing number	XAN-S11-99999/13
Substitute mode	Enabled
Halt on machine check reset	Disabled
Domain Identity 2	
Name	MyPayroll
Description	Time zone: Paris
Operating System	Linux
Domain network name	MyPayrollNet
Domain IP address	122.122.1.0
Domain URL	http://www.MyPayrollWeb.com
Domain CPU parameters	Monothreading mode
High memory IO space	Disabled
IO memory space optimization	Disabled
Licensing number	XAN-S11-99999/14
Substitute mode	Enabled
Halt on machine check reset	Disabled

Table 49. Scheme configuration criteria - example 3 - 4 modules server

To create a multi-domain scheme using all server resources:

1. Check that the required hardware resources are available (at least one IOC and one QBB are required for each server domain) and that the domain Operating System supports the required hardware resources (CPUs, DIMMs, ...).
2. From the Customer Administrator PAM tree, click **Configuration Tasks** → **Domains** → **Schemes** to open the **Schemes Management** pane.
3. Click **New** to open the **Scheme Creation** dialog.
4. Complete the **Scheme** and **Description** fields.

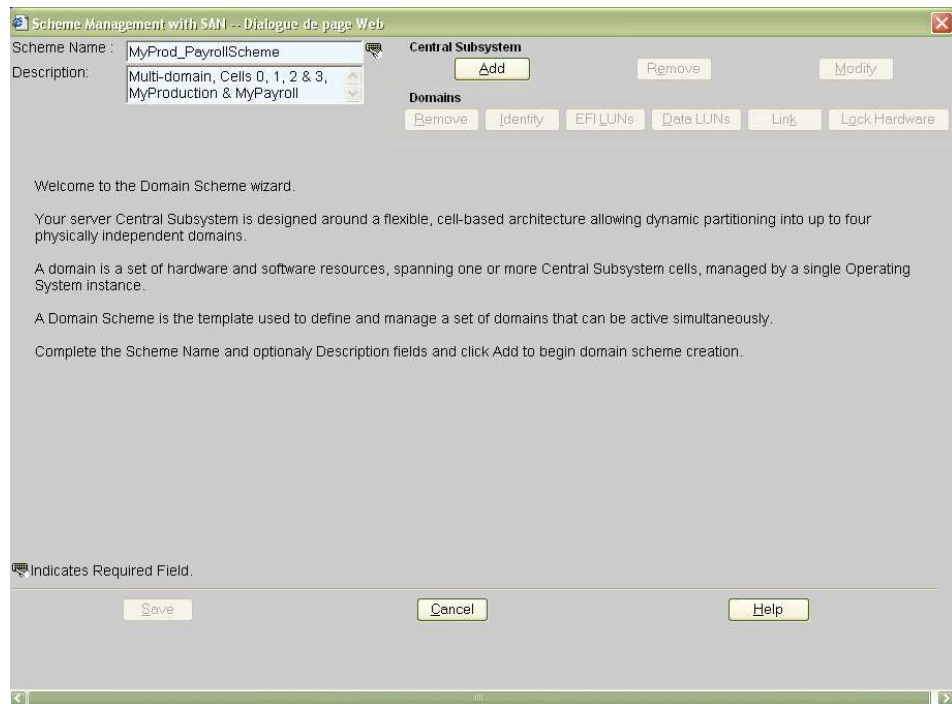
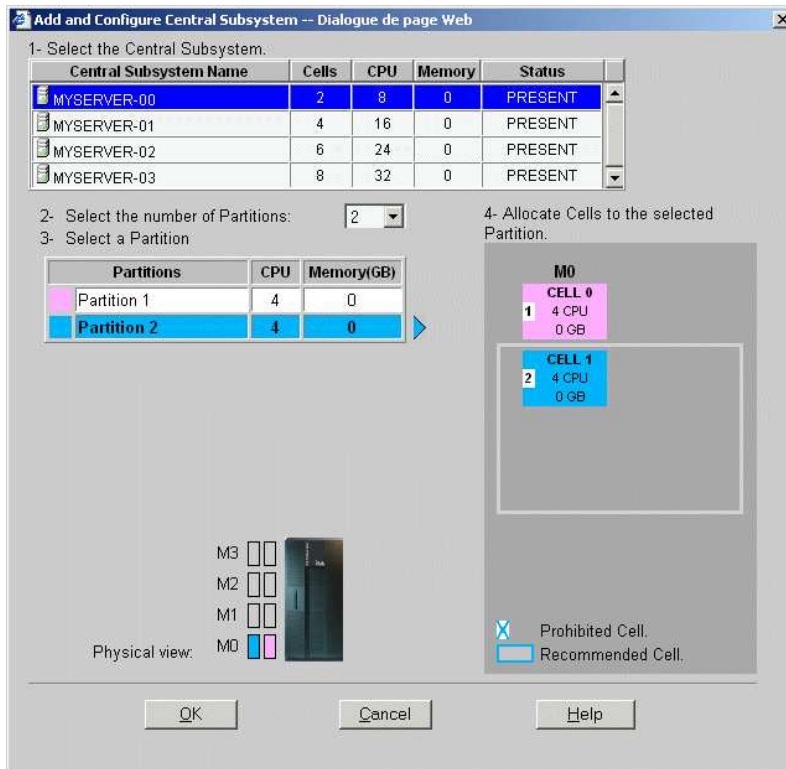

Figure 150. Scheme creation dialog - example 3

- Click **Central Subsystem** → **Add** to select the Central Subsystem to be used by the domain configuration scheme. The **Central Subsystem Configuration** dialog opens.

NovaScale 5085 Partitioned Server



NovaScale 5165 Partitioned Server

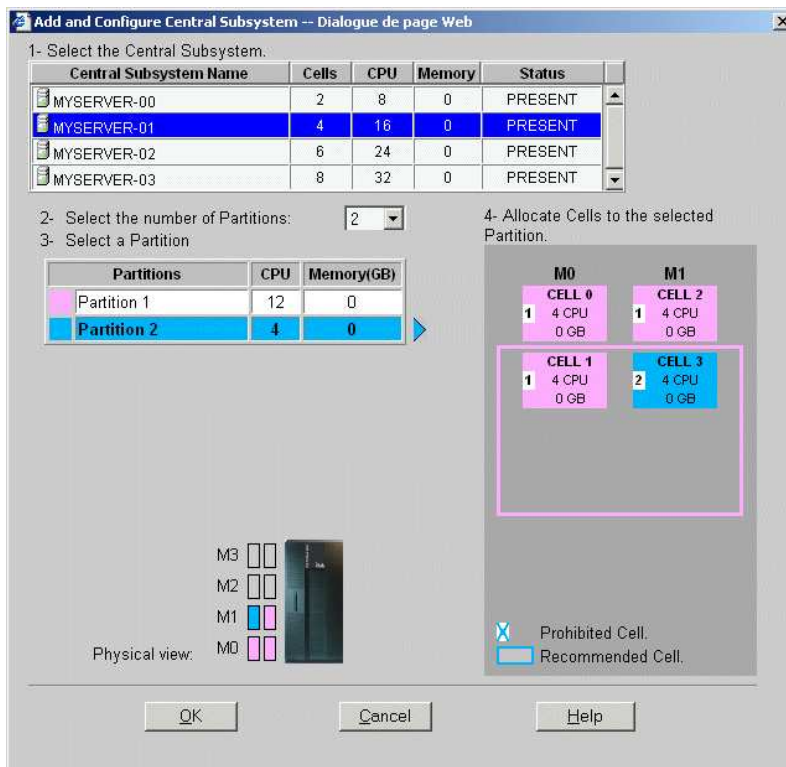

NovaScale 5245 Partitioned Server

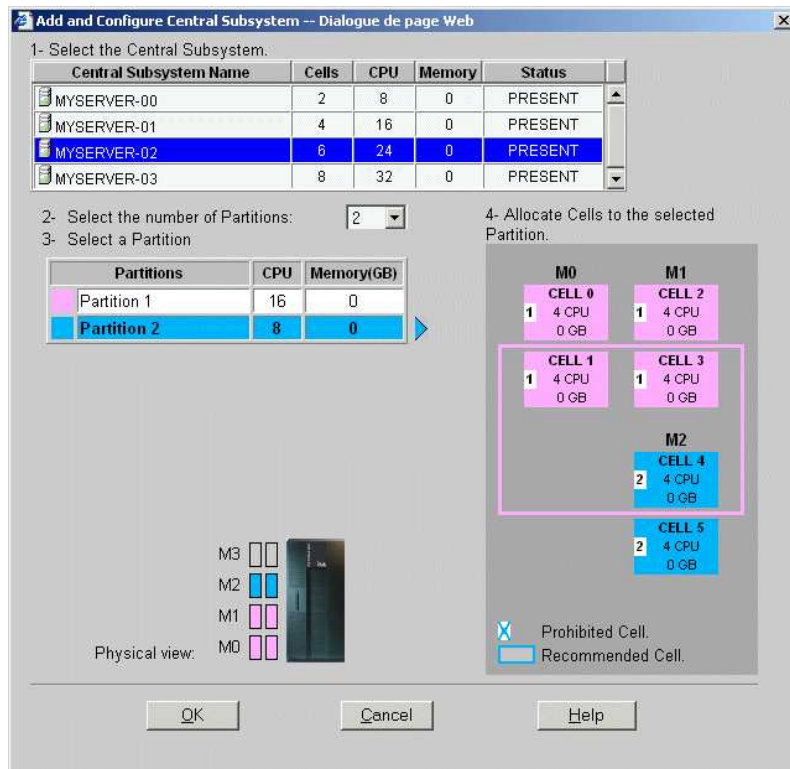

NovaScale 5325 Partitioned Server

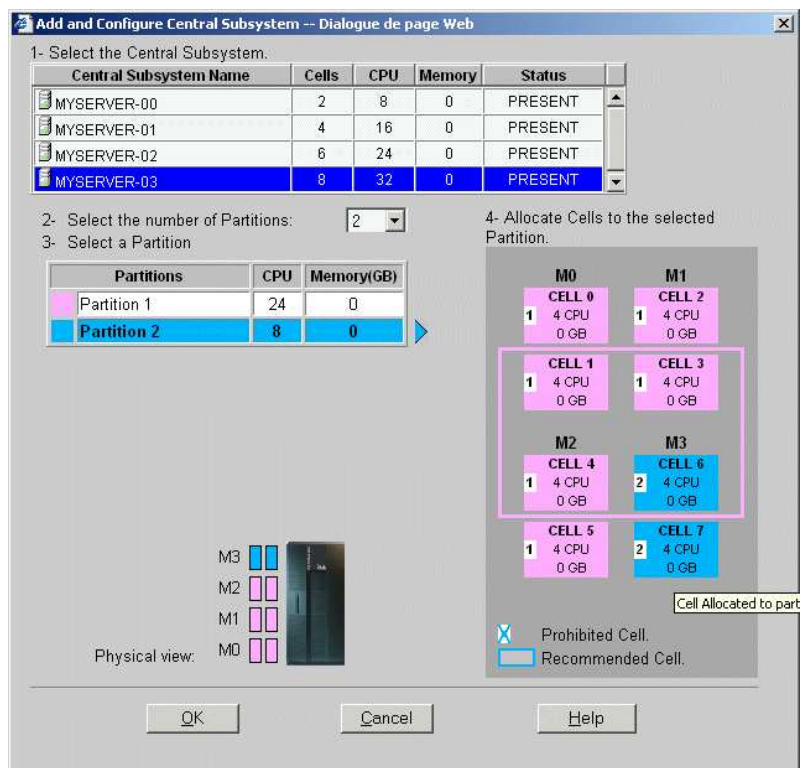

Figure 151. Central Subsystem configuration dialog - example 3

6. In the Central Subsystem list, select the required Central Subsystem.

The graphic representation of the selected Central Subsystem appears in the bottom right part of the window.

7. To create a 2 domains scheme, in the **Number of Partitions** dropdown list select **2** hardware partitions.
8. Configure the 2 partitions by proceeding as follows:
 - a. Select **Partition 1** and select the cells required for domain 1
 - b. Select **Partition 2** and select the cells required for domain 2
9. Click **OK** to return to the **Scheme Management** dialog.

The **Status** icons are red because **Domain Identities** and **EFI LUNs** are required to complete domain configuration.

NovaScale 5085 Partitioned Server

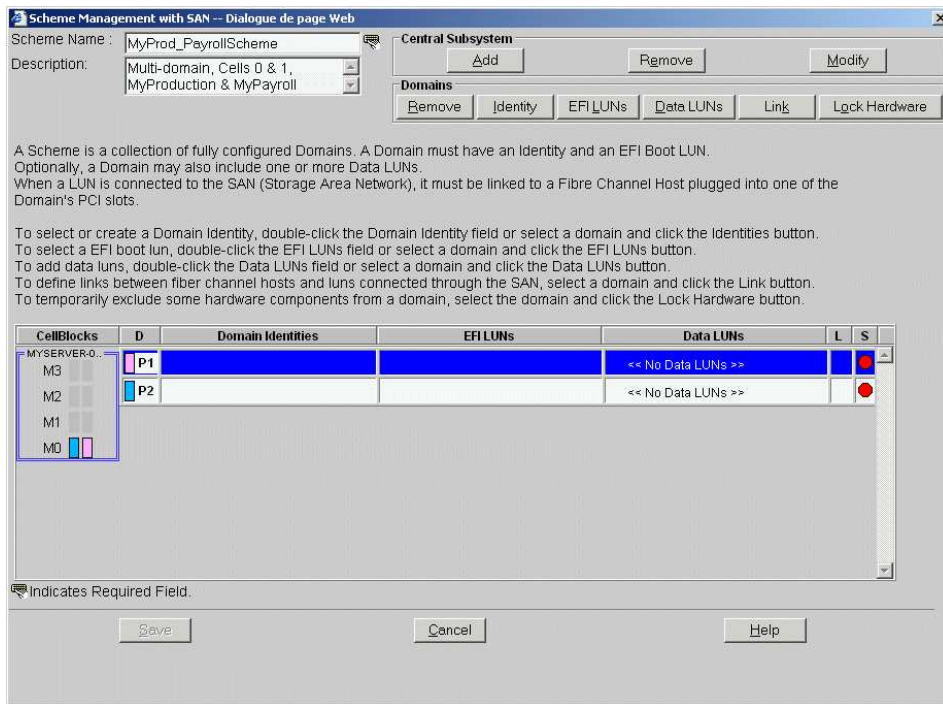

NovaScale 5165 Partitioned Server

Scheme Management with SAN -- Dialogue de page Web

Scheme Name: MyProd_PayrollScheme

Description: Multi-domain, Cells 0, 1, 2 & 3, MyProduction & MyPayroll

Central Subsystem
 Add Remove Modify

Domains
 Remove Identity EFI LUNs Data LUNs Link Lock Hardware

A Scheme is a collection of fully configured Domains. A Domain must have an Identity and an EFI Boot LUN.
 Optionally, a Domain may also include one or more Data LUNs.
 When a LUN is connected to the SAN (Storage Area Network), it must be linked to a Fibre Channel Host plugged into one of the Domain's PCI slots.

To select or create a Domain Identity, double-click the Domain Identity field or select a domain and click the Identities button.
 To select a EFI boot lun, double-click the EFI LUNs field or select a domain and click the EFI LUNs button.
 To add data luns, double-click the Data LUNs field or select a domain and click the Data LUNs button.
 To define links between fiber channel hosts and luns connected through the SAN, select a domain and click the Link button.
 To temporarily exclude some hardware components from a domain, select the domain and click the Lock Hardware button.

CellBlocks	D	Domain Identities	EFI LUNs	Data LUNs	L	S
MYSERVER-0...		P1		<< No Data LUNs >>		●
M3						
M2		P2		<< No Data LUNs >>		●
M1						
MD						

Indicates Required Field.

Save Cancel Help

NovaScale 5245 Partitioned Server

Scheme Management with SAN -- Dialogue de page Web

Scheme Name: MyProd_PayrollScheme

Description: Multi-domain, Cells 0 to 5, MyProduction & MyPayroll

Central Subsystem
 Add Remove Modify

Domains
 Remove Identity EFI LUNs Data LUNs Link Lock Hardware

A Scheme is a collection of fully configured Domains. A Domain must have an Identity and an EFI Boot LUN.
 Optionally, a Domain may also include one or more Data LUNs.
 When a LUN is connected to the SAN (Storage Area Network), it must be linked to a Fibre Channel Host plugged into one of the Domain's PCI slots.

To select or create a Domain Identity, double-click the Domain Identity field or select a domain and click the Identities button.
 To select a EFI boot lun, double-click the EFI LUNs field or select a domain and click the EFI LUNs button.
 To add data luns, double-click the Data LUNs field or select a domain and click the Data LUNs button.
 To define links between fiber channel hosts and luns connected through the SAN, select a domain and click the Link button.
 To temporarily exclude some hardware components from a domain, select the domain and click the Lock Hardware button.

CellBlocks	D	Domain Identities	EFI LUNs	Data LUNs	L	S
MYSERVER-0...		P1		<< No Data LUNs >>		●
M3						
M2						
M1						
MD						

Indicates Required Field.

Save Cancel Help

NovaScale 5325 Partitioned Server

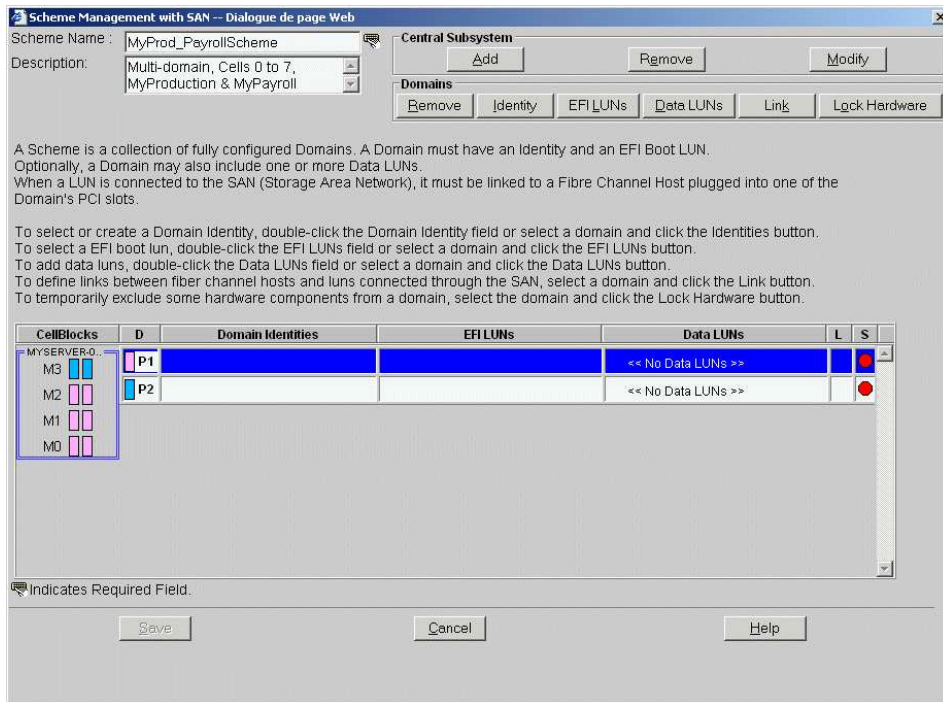

Figure 152. Scheme Management dialog - example 3

- In the partition list, double-click the empty cell of the **P1** line and the **Domain Identities** column.

The **Identity List** dialog opens.

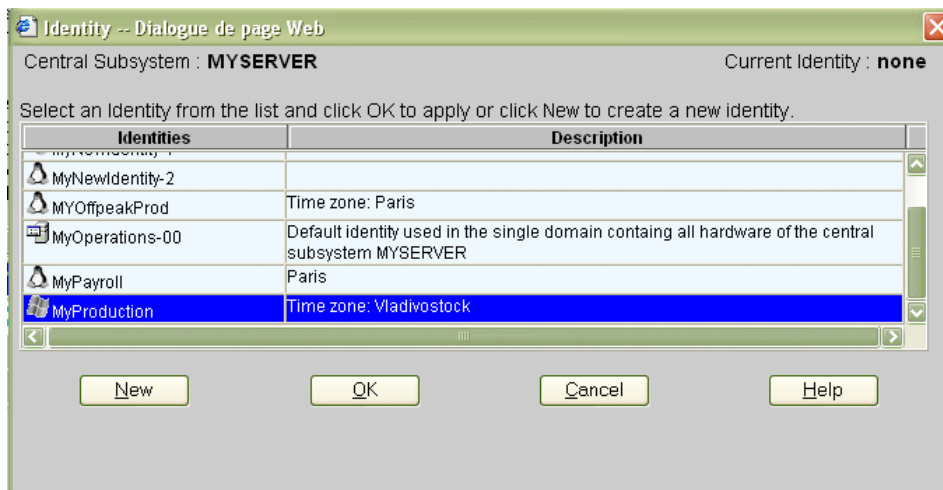

Figure 153. Identities list dialog - example 3

- If the required identity is in the list, go to Step 16.
To create a new identity for this domain, click **New** to open the **Create New Identity** dialog. See *Creating a Domain Identity*, on page 5-50 for details.

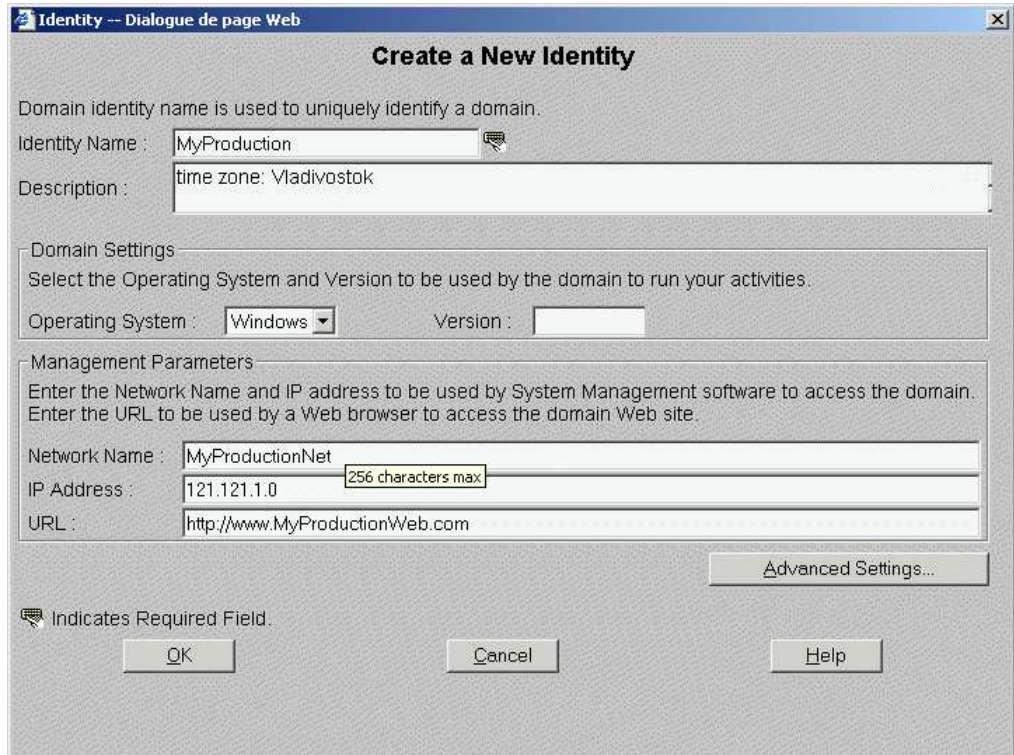

Figure 154. Create new identity dialog - example 3

12. Complete the **Name**, **Description**, **Domain Settings** and **Management Parameters** fields as required.
13. Click **Advanced Settings** to open the **Advanced Identity Settings** dialog.

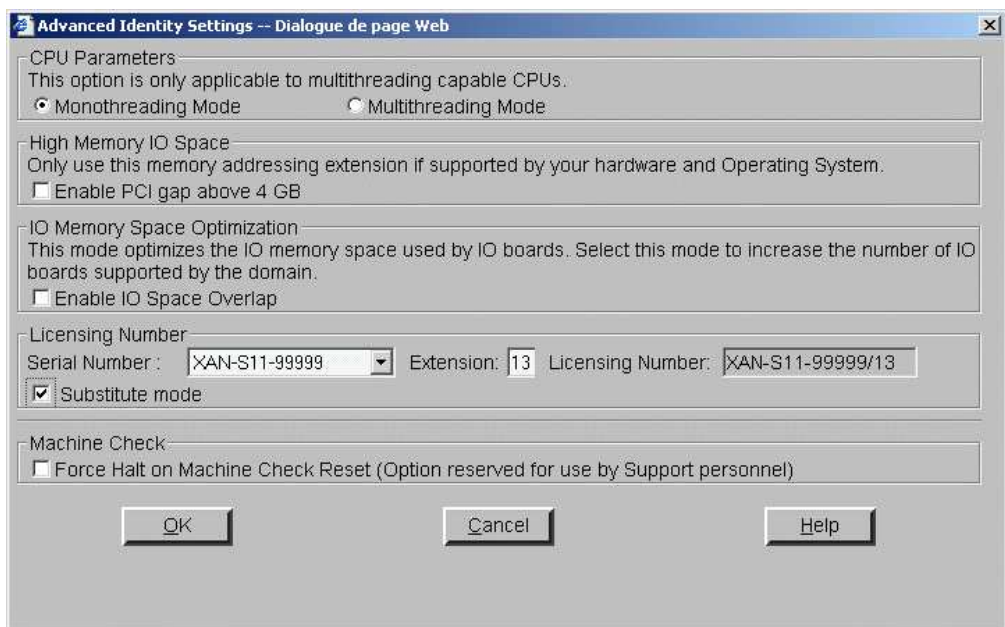

Figure 155. Create new identity advanced setting dialog - example 3

14. Complete the **Advanced Identity Settings** dialog fields as required and click **OK** to return to the **Create new identity** dialog.
15. Click **OK**. The new identity appears in the **Identities List** dialog.

16. Select the required identity from the list of available identities and click **OK** to return to the **Scheme Management** dialog. The selected identity is now displayed in the **Domain Identities** field.
17. Repeat Steps 10 to 16 for the empty cell of the **P2** line and the **Domain Identities** column.
18. Double-click the **D1 EFI LUNs** field. The **Select EFI LUN** dialog opens, allowing you to choose the required EFI Boot LUN from the list of available LUNs.

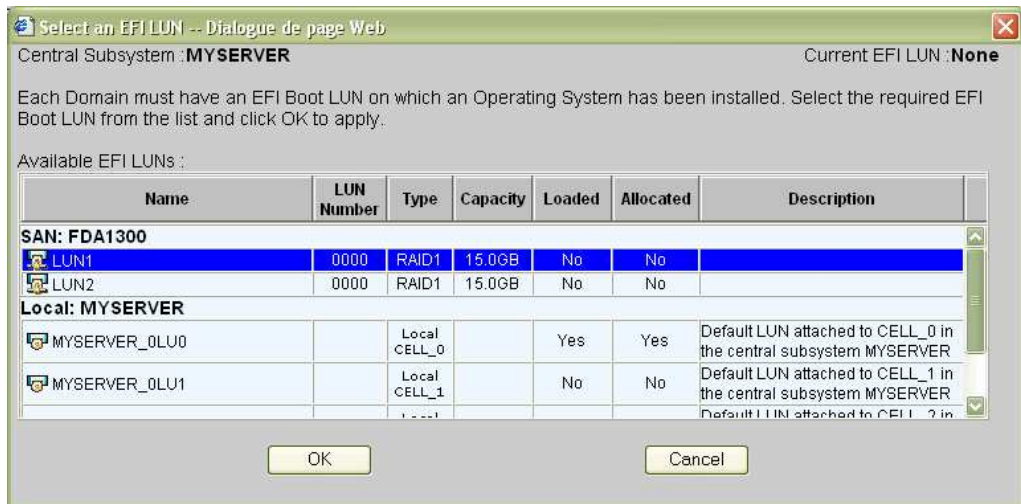

Figure 156. Select SAN EFI LUN dialog - example 3

19. Select the required EFI Boot LUN from the list of available SAN LUNs and click **OK** to return to the **Scheme Management** dialog. The selected LUN is now displayed in the **EFI LUNs** field.

As the selected EFI LUN is a SAN LUN, the **Status** icon remains red and the **No Link** icon  appears.

20. Double-click the **D2 EFI LUNs** field. The **Select EFI LUN** dialog opens, allowing you to choose the required EFI Boot LUN from the list of available Local LUNs.

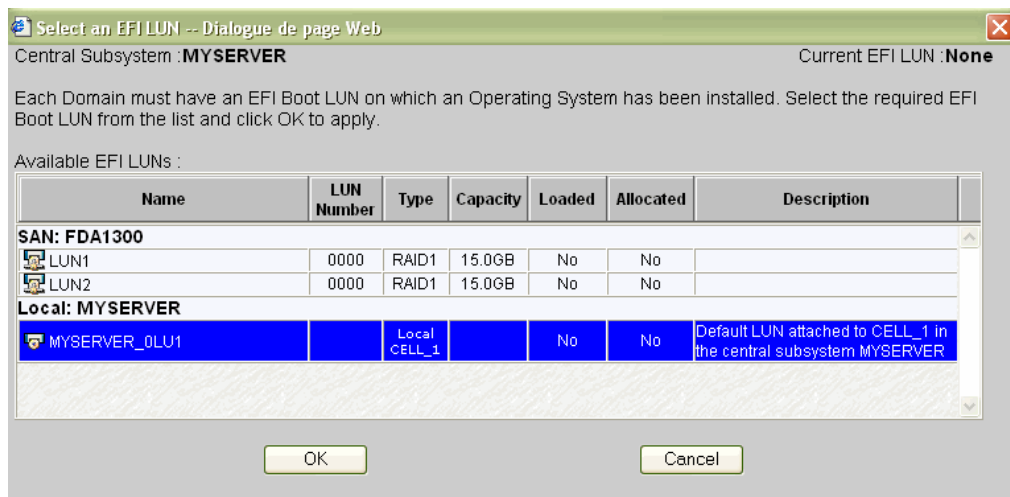

Figure 157. Select Local EFI LUN dialog - example 3

As the selected EFI LUN is a Local LUN, the **Status** icon turns green.

21. Double-click the **D1 Data LUNs** field. The **Select Data LUN** dialog opens, allowing you to choose the required Data LUNs from the list of available LUNs.

22. Select the required Data LUNs from the list of available LUNs and click **Add** to move the selected Data LUNs to the **Data LUNs selected** list.

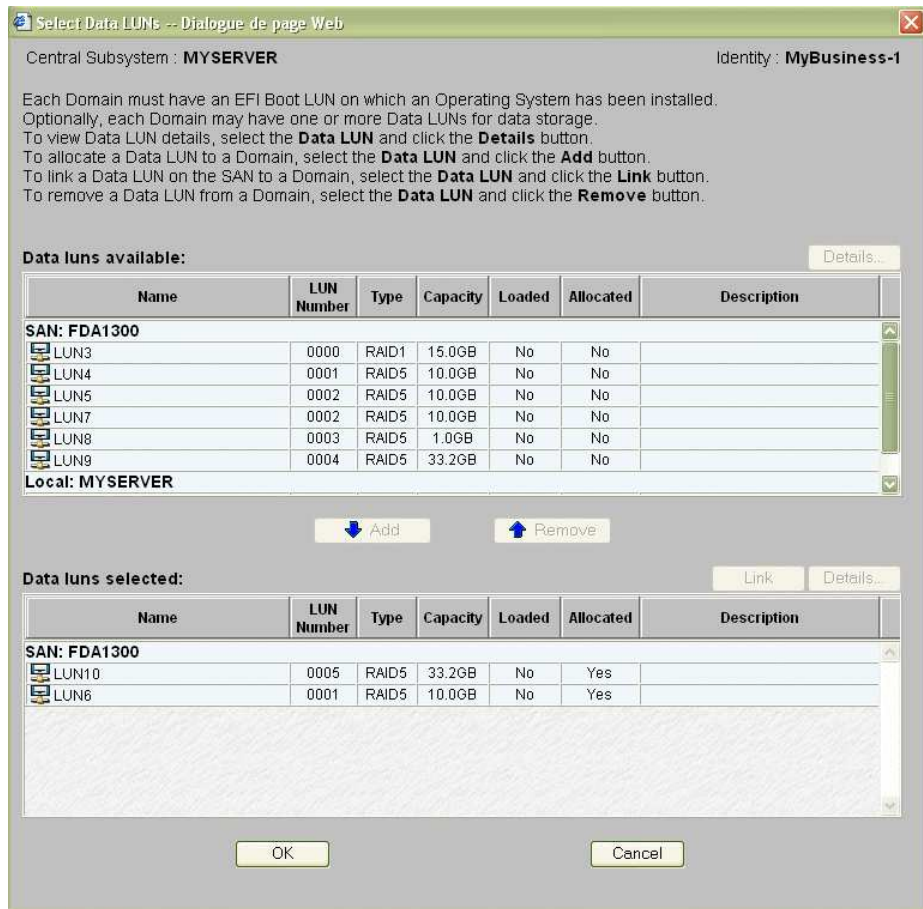



Figure 158. Select Data LUN dialog - example 2

23. Click **OK** to return to the **Scheme Management** dialog. **Data LUN set** is now displayed in the **Data LUNs** field.

The **Status** icon remains red and the **No Link** icon  is displayed. You must now link the selected EFI and Data LUNs to the Fibre Channel Host you want to use to access these LUNs.

24. Repeat Steps 21 to 23 for **D2 Data LUNs**.

As the selected Data LUN is a SAN LUN, the **Status** icon turns red and the **No Link** icon  is displayed. You must now link the selected Data LUN to the Fibre Channel Host you want to use to access this LUN.

25. Double-click the **D1 No Link** icon  to open the **Link LUNs to HBA** dialog.

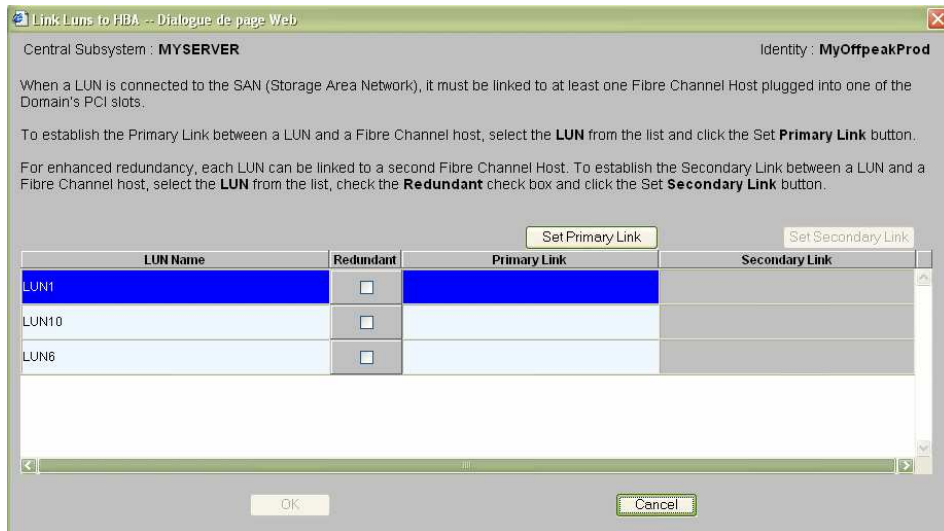

Figure 159. Link LUN to HBA dialog - example 3

26. Select the first LUN in the list and click **Set Primary Link** to define the main access path to the SAN. The **Select HBA** dialog opens, allowing you to select the domain PCI slot you want to use to access the LUN.

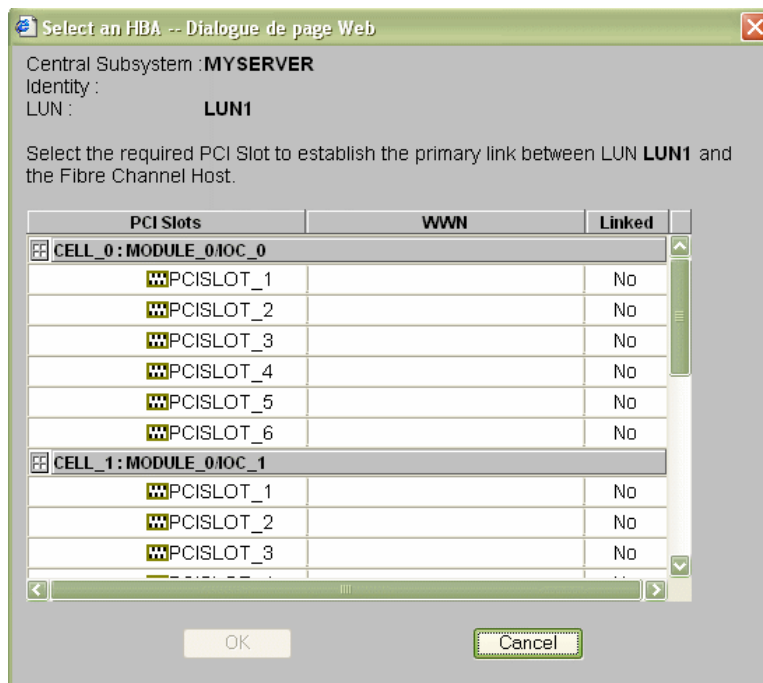



Figure 160. Select HBA dialog - example 3

27. Select the required PCI slot and click **OK**. The primary link is now set.

28. Repeat Steps 23 to 27 for each LUN in the list and click **OK** → **Apply** to return to the **Scheme Management** dialog. The **D1 Status** icon turns green and the **Linked** icon  appears.

29. Repeat Steps 25 to 27 for **D2**. All **Status** icons are green.

30. Click **Save**. The domain configuration scheme is now available for domain management.

Creating a Multi-Domain Scheme Using a Selection of Server Resources

 **Notes:**

- A domain configuration scheme can include more than one Central Subsystems. If you have more than one Bull NovaScale Server, see *Configuring and Managing Extended Systems*, on page 5-125.
- For more information about scheme and identity configuration options, refer to:
 - *Assessing Configuration Requirements*, on page 5-31
 - *Creating a Domain Configuration Scheme*, on page 5-33
 - *Creating a Domain Identity*, on page 5-50

The configuration criteria set out in the following tables is used to illustrate this example:

NovaScale 5165 Partitioned Server

Scheme	
Name	MyTest_DevptScheme
Description	Multi-domain, Cells 1, 2 & 3, MyTest & MyDevpt
Central Subsystem(s)	MYSERVER-01
Number of domains	2
Domain size	Cell 1 for MyTest (Domain 1) Cells 2 & 3 for MyDevpt (Domain 2)
EFI boot LUNs	SAN: FDA 1300 LUN1 for MyTest Local: 0Lun3 for MyDevpt
Data LUNs (SAN only)	SAN: FDA 1300 LUN10, LUN6 for MyTest SAN: FDA 1300 LUN4 for MyDevpt
Fibre channel hosts (SAN only)	MyTest: Primary Link: Cell_1: Module_0/IOC_0/PCISLOT_1 MyDevpt Primary Link: Cell_3: Module_1/IOC_1/PCISLOT_1 Secondary Link: Cell_2: Module_1/IOC_0/PCISLOT_1
IO resource location	1IOC0 for MyTest 3IOC1 for MyDevpt
Resource access	Cell1, Hublink 1 / Cell2, Cell3, Hublinks 2 & 3
Domain Identity 1	
Name	MyTest
Description	Time zone: Paris
Operating System	Linux
Domain network name	MyTestNet
Domain IP address	126.126.1.2
Domain URL	http://www.MyTestNetWeb.com
Domain CPU parameters	Monothreading mode
High memory IO space	Disabled
IO memory space optimization	Disabled
Licensing number	XAN-S11-99999/15
Substitute mode	Enabled
Halt on machine check reset	Disabled
Domain Identity 2	
Name	MyDevpt
Description	Time zone: Paris
Operating System	Windows
Domain network name	MyDevptNet
Domain IP address	126.126.1.0
Domain URL	http://www.MyDevptWeb.com
Domain CPU parameters	Monothreading mode
High memory IO space	Disabled
IO memory space optimization	Disabled
Licensing number	XAN-S11-99999/16
Substitute mode	Enabled
Halt on machine check reset	Disabled

Table 50. Scheme configuration criteria - example 4 - bi-module server

NovaScale 5245 Partitioned Server

Scheme	
Name	MyTest_DevptScheme
Description	Multi-domain, Cells 0, 1, 2 & 4, MyTest & MyDevpt
Central Subsystem(s)	MYSERVER-02
Number of domains	2
Domain size	Cells 0, 1 & 2 for MyTest (Domain 1) Cell 4 for MyDevpt (Domain 2)
EFI boot LUNs	SAN: FDA 1300 LUN1 for MyTest Local: 0Lun3 for MyDevpt
Data LUNs (SAN only)	SAN: FDA 1300 LUN10, LUN6 for MyTest SAN: FDA 1300 LUN4 for MyDevpt
Fibre channel hosts (SAN only)	MyTest: Primary Link: Cell_1: Module_0/IOC_1/PCISLOT_1 Secondary Link: Cell_2: Module_1/IOC_0/PCISLOT_1 MyDevpt: Primary Link: Cell_4: Module_2/IOC_1/PCISLOT_1
IO resource location	0IOCO for MyTest 4IOCO for MyDevpt
Resource access	Cell0, Cell1, Cell2, Hublinks 0, 1 & 2 / Cell4, Hublink 4
Domain Identity 1	
Name	MyTest
Description	Time zone: Paris
Operating System	Linux
Domain network name	MyTestNet
Domain IP address	126.126.1.2
Domain URL	http://www.MyTestWeb.com
Domain CPU parameters	Monothreading mode
High memory IO space	Disabled
IO memory space optimization	Disabled
Licensing number	XAN-S11-99999/15
Substitute mode	Enabled
Halt on machine check reset	Disabled
Domain Identity 2	
Name	MyDevpt
Description	Time zone: Paris
Operating System	Windows
Domain network name	MyDevptNet
Domain IP address	126.126.1.0
Domain URL	http://www.MyDevptWeb.com
Domain CPU parameters	Monothreading mode
High memory IO space	Disabled
IO memory space optimization	Disabled
Licensing number	XAN-S11-99999/16
Substitute mode	Enabled
Halt on machine check reset	Disabled

Table 51. Scheme configuration criteria - example 4 - 3 modules server

NovaScale 5325 Partitioned Server

Scheme	
Name	MyTest_DevptScheme
Description	Multi-domain, Cells 0 to 6, MyTest & MyDevpt
Central Subsystem(s)	MYSERVER-03
Number of domains	2
Domain size	Cells 0, 1, 2 & 3 for MyTest (Domain 1) Cells 4, 5 & 6 for MyDevpt (Domain 2)
EFI boot LUNs	SAN: FDA 1300 LUN1 for MyTest Local: 0Lun3 for MyDevpt
Data LUNs (SAN only)	SAN: FDA 1300 LUN10, LUN6 for MyTest SAN: FDA 1300 LUN4 for MyDevpt
Fibre channel hosts (SAN only)	MyTest: Primary Link: Cell_1: Module_0/IOC_1/PCISLOT_1 Secondary Link: Cell_2: Module_1/IOC_0/PCISLOT_1 MyDevpt: Primary Link: Cell_4: Module_2/IOC_1/PCISLOT_1 Secondary Link: Cell_5: Module_2/IOC_0/PCISLOT_1
IO resource location	0IOC0 for MyTest 4IOC0 for MyDevpt
Resource access	Cell0, Cell1, Cell2, Cell 3, Hublinks 0, 1, 2 & 3 / Cell4, Cell5, Cell6, Hublinks 4, 5 & 6
Domain Identity 1	
Name	MyTest
Description	Time zone: Paris
Operating System	Linux
Domain network name	MyTestNet
Domain IP address	126.126.1.2
Domain URL	http://www.MyTestWeb.com
Domain CPU parameters	Monothreading mode
High memory IO space	Disabled
IO memory space optimization	Disabled
Licensing number	XAN-S11-99999/15
Substitute mode	Enabled
Halt on machine check reset	Disabled
Domain Identity 2	
Name	MyDevpt
Description	Time zone: Paris
Operating System	Windows
Domain network name	MyDevptNet
Domain IP address	126.126.1.0
Domain URL	http://www.MyDevptWeb.com
Domain CPU parameters	Monothreading mode
High memory IO space	Disabled
IO memory space optimization	Disabled
Licensing number	XAN-S11-99999/16
Substitute mode	Enabled
Halt on machine check reset	Disabled

Table 52. Scheme configuration criteria - example 4 - 4 modules server

To create a multi-domain scheme using a part of server resources:

1. Check that the required hardware resources are available (at least one IOC and one QBB are required for each server domain) and that the domain Operating System supports the required hardware resources (CPUs, DIMMs, ...).
2. From the Customer Administrator PAM tree, click **Configuration Tasks** → **Domains** → **Schemes** to open the **Schemes Management** pane.
3. Click **New** to open the **Scheme Creation** dialog.
4. Complete the **Scheme** and **Description** fields.

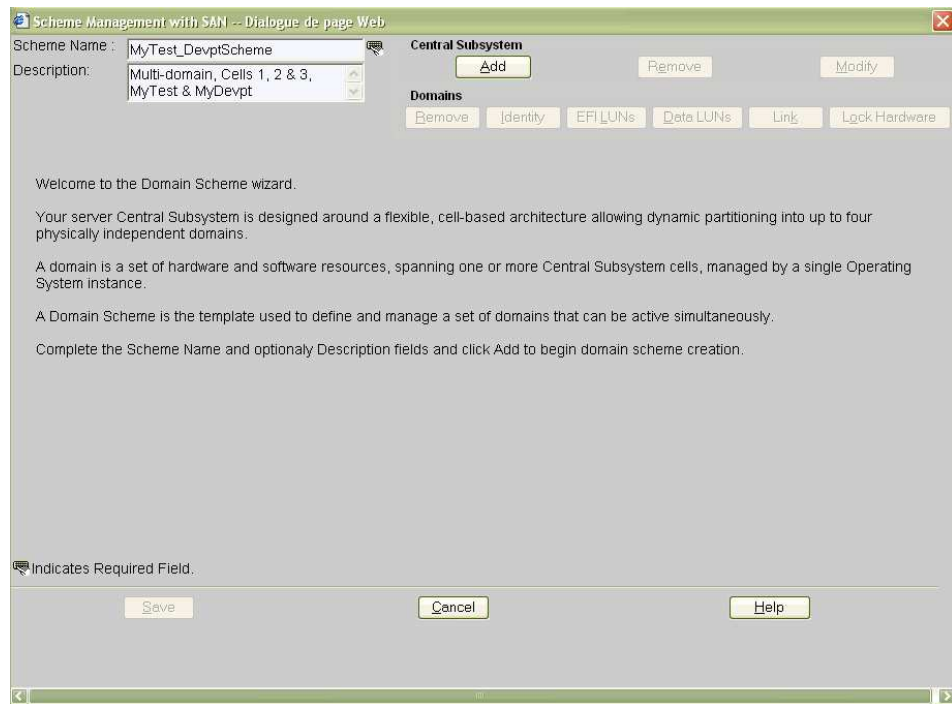
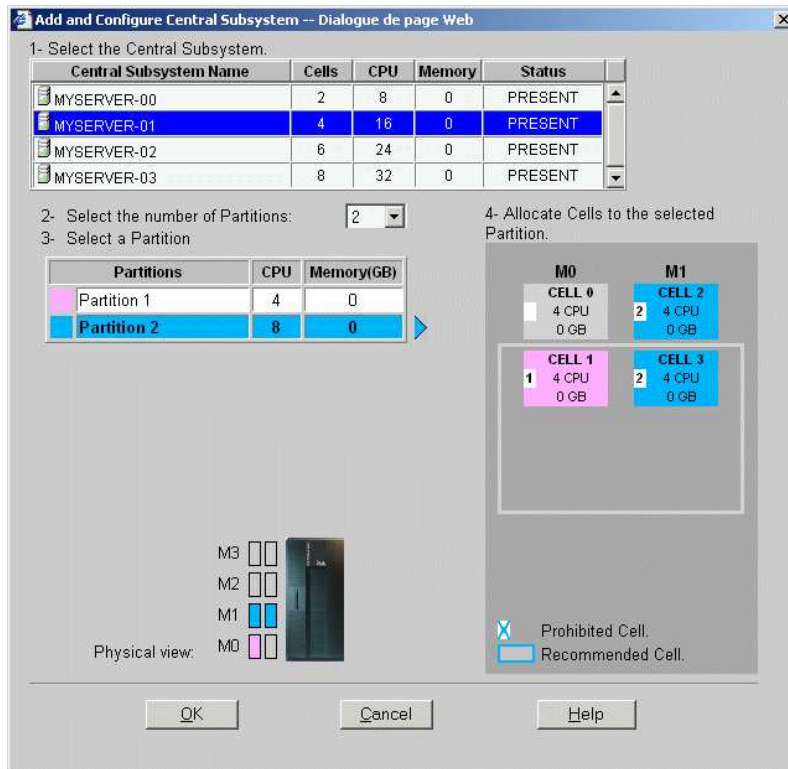

Figure 161. Scheme creation dialog - example 4

- Click **Central Subsystem** → **Add** to select the Central Subsystem to be used by the domain configuration scheme. The **Central Subsystem Configuration** dialog opens.

NovaScale 5165 Partitioned Server



NovaScale 5245 Partitioned Server

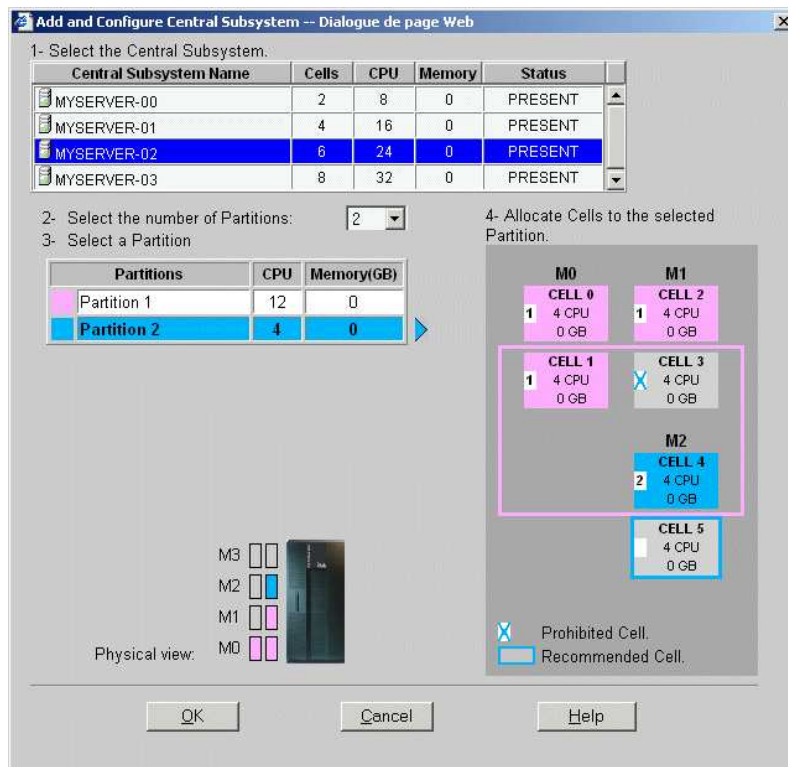

NovaScale 5325 Partitioned Server

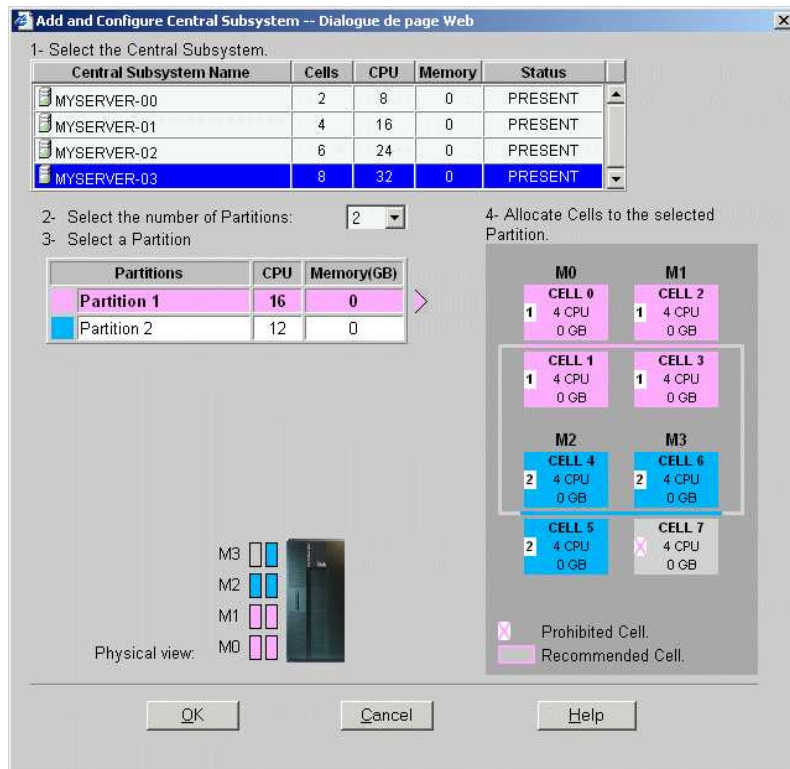

Figure 162. Central Subsystem configuration dialog - example 4

6. In the Central Subsystem list, select the required Central Subsystem.
The graphic representation of the selected Central Subsystem appears in the bottom right part of the window.
7. To create a 2 domains scheme, in the **Number of Partitions** dropdown list select **2** hardware partitions.
8. Configure the 2 partitions by proceeding as follows:
 - a. Select **Partition 1** and select the cells required for domain 1
 - b. Select **Partition 2** and select the cells required for domain 2
9. Click **OK** to return to the **Scheme Management** dialog.
The **Status** icons are red because **Domain Identities** and **EFI LUNs** are required to complete domain configuration.

NovaScale 5165 Partitioned Server

Scheme Management with SAN -- Dialogue de page Web

Scheme Name : MyTest_DevptScheme

Description : Multi-domain, Cells 1, 2 & 3, MyProduction & MyPayroll

Central Subsystem
 Add Remove Modify

Domains
 Remove Identity EFI LUNs Data LUNs Link Lock Hardware

A Scheme is a collection of fully configured Domains. A Domain must have an Identity and an EFI Boot LUN. Optionally, a Domain may also include one or more Data LUNs. When a LUN is connected to the SAN (Storage Area Network), it must be linked to a Fibre Channel Host plugged into one of the Domain's PCI slots.

To select or create a Domain Identity, double-click the Domain Identity field or select a domain and click the Identities button.
 To select a EFI boot lun, double-click the EFI LUNs field or select a domain and click the EFI LUNs button.
 To add data luns, double-click the Data LUNs field or select a domain and click the Data LUNs button.
 To define links between fiber channel hosts and luns connected through the SAN, select a domain and click the Link button.
 To temporarily exclude some hardware components from a domain, select the domain and click the Lock Hardware button.

CellBlocks	D	Domain Identities	EFI LUNs	Data LUNs	L	S
MYSERVER-0:						
M3	<input checked="" type="checkbox"/>	P1		<< No Data LUNs >>	<input checked="" type="checkbox"/>	<input type="checkbox"/>
M2	<input checked="" type="checkbox"/>	P2		<< No Data LUNs >>	<input type="checkbox"/>	<input checked="" type="checkbox"/>
M1	<input type="checkbox"/>					
M0	<input type="checkbox"/>					

Indicates Required Field.

Save Cancel Help

NovaScale 5245 Partitioned Server

Scheme Management with SAN -- Dialogue de page Web

Scheme Name : MyTest_DevptScheme

Description : Multi-domain, Cells 0, 1, 2 & 4, MyProduction & MyPayroll

Central Subsystem
 Add Remove Modify

Domains
 Remove Identity EFI LUNs Data LUNs Link Lock Hardware

A Scheme is a collection of fully configured Domains. A Domain must have an Identity and an EFI Boot LUN. Optionally, a Domain may also include one or more Data LUNs. When a LUN is connected to the SAN (Storage Area Network), it must be linked to a Fibre Channel Host plugged into one of the Domain's PCI slots.

To select or create a Domain Identity, double-click the Domain Identity field or select a domain and click the Identities button.
 To select a EFI boot lun, double-click the EFI LUNs field or select a domain and click the EFI LUNs button.
 To add data luns, double-click the Data LUNs field or select a domain and click the Data LUNs button.
 To define links between fiber channel hosts and luns connected through the SAN, select a domain and click the Link button.
 To temporarily exclude some hardware components from a domain, select the domain and click the Lock Hardware button.

CellBlocks	D	Domain Identities	EFI LUNs	Data LUNs	L	S
MYSERVER-0:						
M3	<input checked="" type="checkbox"/>	P1		<< No Data LUNs >>	<input checked="" type="checkbox"/>	<input type="checkbox"/>
M2	<input checked="" type="checkbox"/>	P2		<< No Data LUNs >>	<input type="checkbox"/>	<input checked="" type="checkbox"/>
M1	<input type="checkbox"/>					
M0	<input type="checkbox"/>					

Indicates Required Field.

Save Cancel Help

NovaScale 5325 Partitioned Server

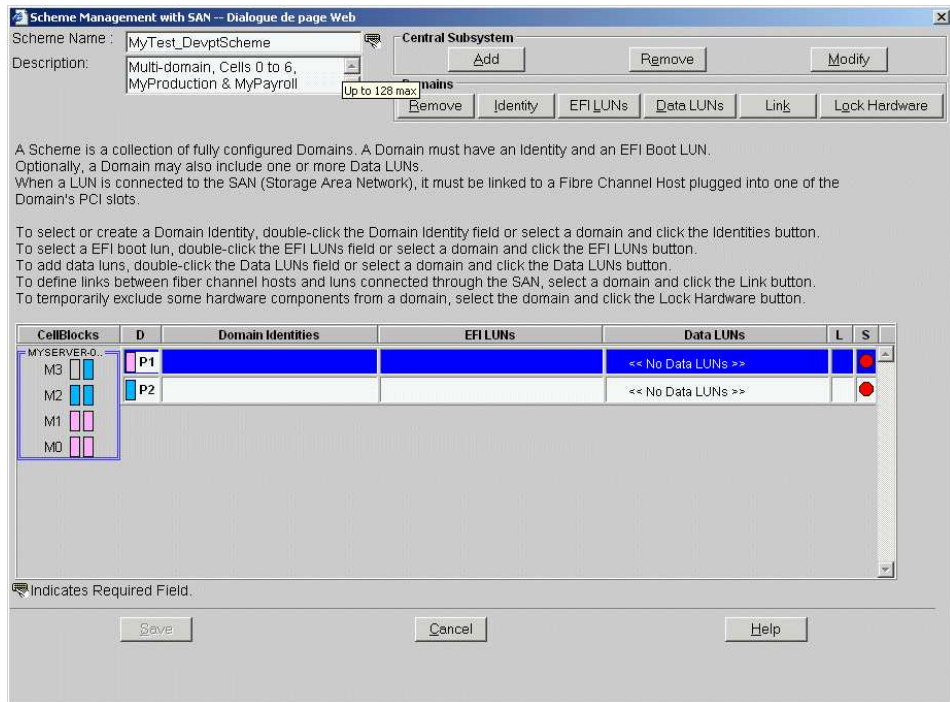

Figure 163. Scheme Management dialog - example 4

- Double-click the empty **D1 Identities** field. The **Identities List** dialog opens.
The **Identity List** dialog opens.

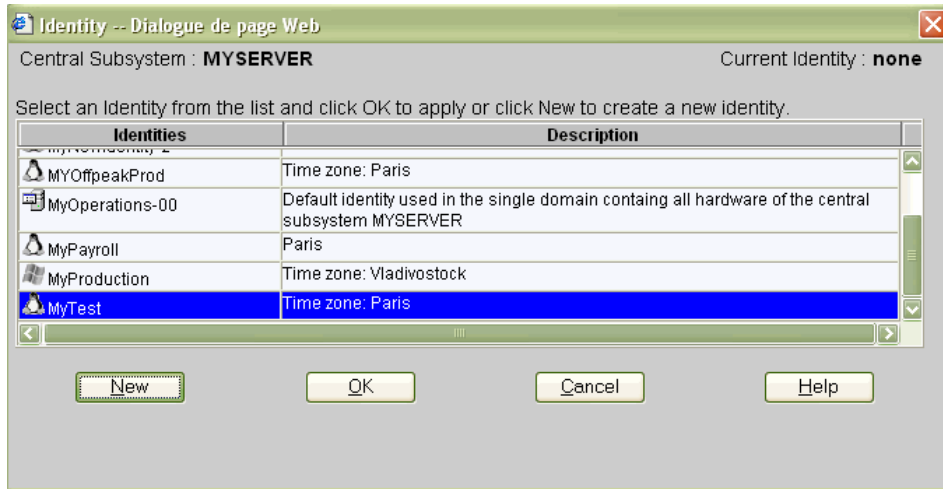

Figure 164. Identities list dialog - example 4

- If the required identity is in the list, go to Step 16.
If you want to create a new identity for this domain, click **New** to open the **Create New Identity** dialog. See *Creating a Domain Identity*, on page 5-50 for details.

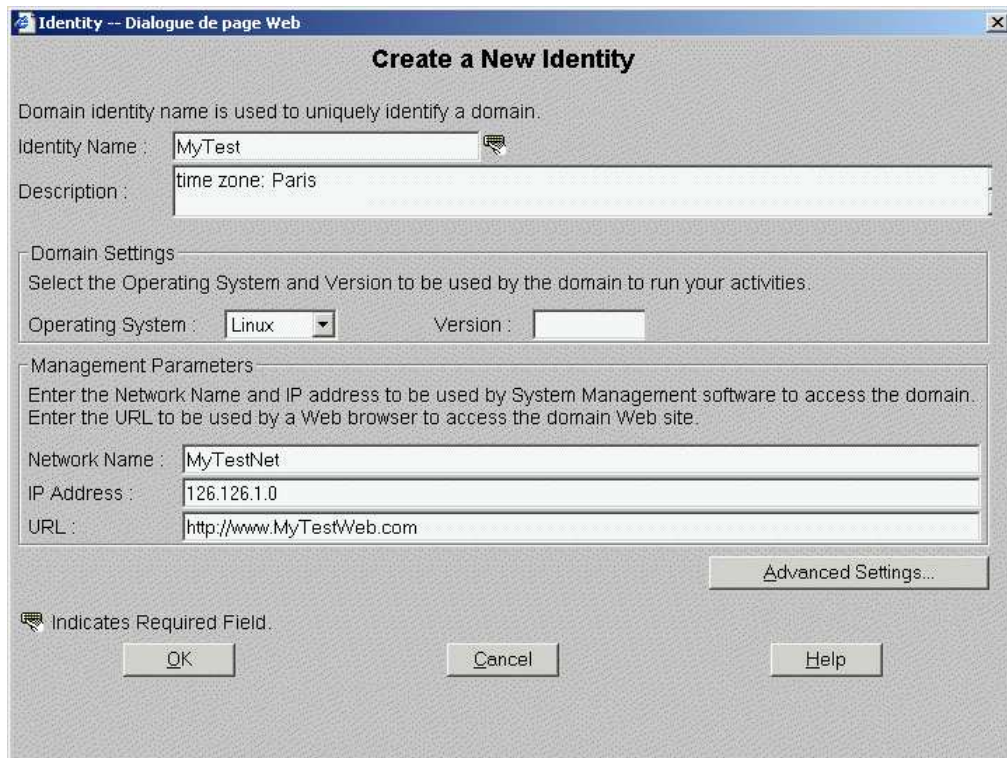

Figure 165. Create new identity dialog - example4

- Complete the **Name**, **Description**, **Domain Settings** and **Management Parameters** fields as required.
- Click **Advanced Settings** to open the **Advanced Identity Settings** dialog.

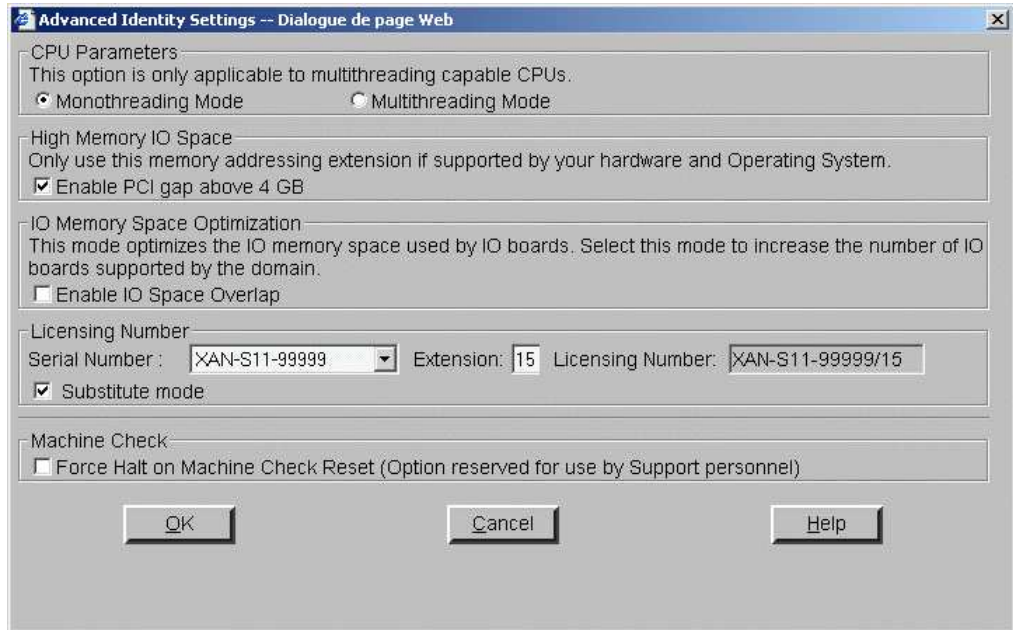

Figure 166. Create new identity advanced setting dialog - example 4

14. Complete the **Advanced Identity Settings** dialog fields as required and click **OK** to return to the **Create new identity** dialog.
15. Click **OK**. The new identity appears in the **Identities List** dialog.
16. Select the required identity from the list of available identities and click **OK** to return to the **Scheme Management** dialog. The selected identity is now displayed in the **Domain Identities** field.
17. Repeat Steps 10 to 16 for the empty cell of the **P2** line and the **Domain Identities** column.
18. Double-click the **D1 EFI LUNs** field. The **Select EFI LUN** dialog opens, allowing you to choose the required EFI Boot LUN from the list of available LUNs.

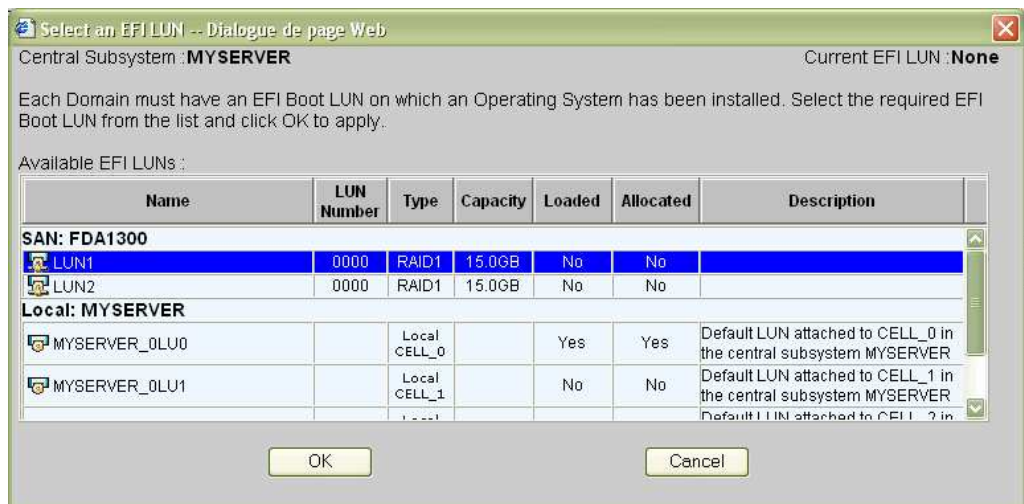



Figure 167. Select EFI LUN dialog - example 4

19. Select the required EFI Boot LUN from the list of available LUNs and click **OK** to return to the **Scheme Management** dialog. The selected LUN is now displayed in the **EFI LUNs** field. As the selected EFI LUN is a SAN LUN, the **Status** icon remains red and the **No Link** icon  appears.

20. Double-click the **D2 EFI LUNs** field. The **Select EFI LUN** dialog opens, allowing you to choose the required EFI Boot LUN from the list of available LUNs.
As the selected EFI LUN is a Local LUN, the **Status** icon turns green.
21. Double-click the **D1 Data LUNs** field. The **Select Data LUN** dialog opens, allowing you to choose the required Data LUNs from the list of available LUNs.
22. Select the required Data LUNs from the list of available LUNs and click **Add** to move the selected Data LUNs to the **Data LUNs selected** list.

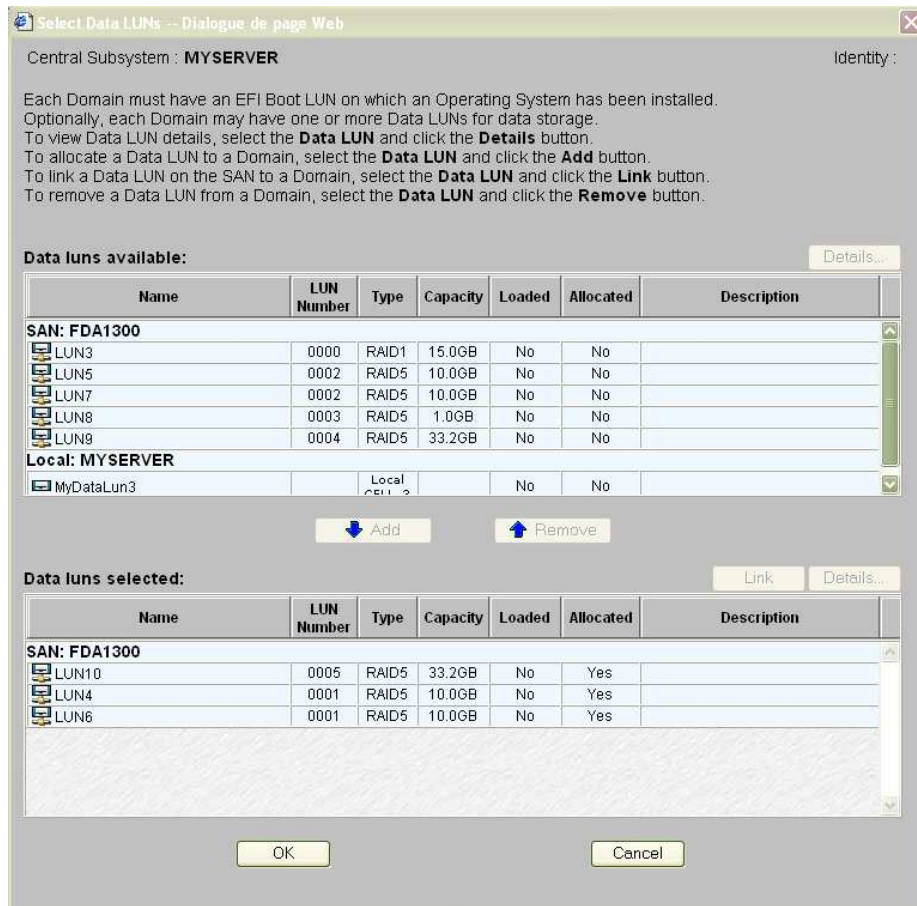



Figure 168. Select Data LUN dialog - example 4

23. Click **OK** to return to the **Scheme Management** dialog. **Data LUN set** is now displayed in the **Data LUNs** field.

The **Status** icon remains red and the **No Link** icon  is displayed. You must now link the selected EFI and Data LUNs to the Fibre Channel Host you want to use to access these LUNs.

24. Repeat Steps 21 to 23 for **D2 Data LUNs**.

As the selected Data LUN is a SAN LUN, the **Status** icon turns red and the **No Link** icon  is displayed. You must now link the selected Data LUN to the Fibre Channel Host you want to use to access these LUN.

25. Double-click the **D1 No Link** icon  to open the **Link LUNs to HBA** dialog.

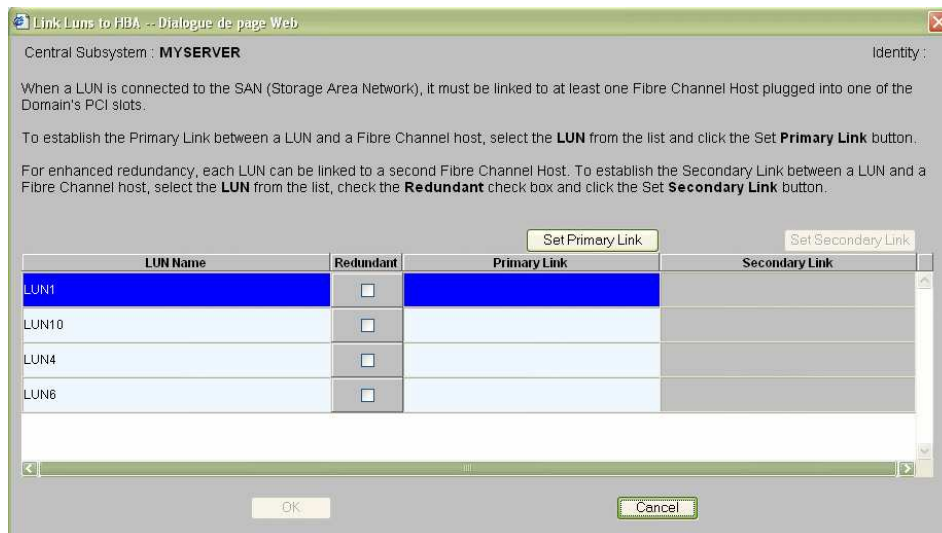

Figure 169. Link LUN to HBA dialog - example 2

26. Select the first LUN in the list and click **Set Primary Link** to define the main access path to the SAN. The **Select HBA** dialog opens, allowing you to select the domain PCI slot you want to use to access the LUN.

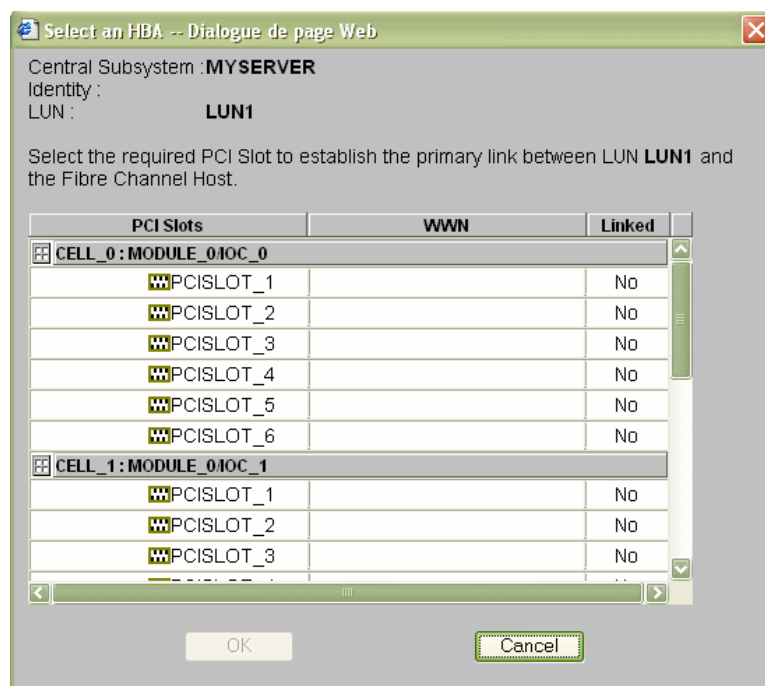

Figure 170. Select HBA dialog - example 4

27. Select the required PCI slot and click **OK**. The primary link is now set.

28. Repeat Steps 26 to 27 for each LUN in the list and click **OK** → **Apply** to return to the

Scheme Management dialog. The **D1 Status** icon turns green and the **Linked** icon  appears.

29. Repeat Steps 25 to 28 for **D2**. All **Status** icons are green.

30. Select **D2** and click **Lock Hardware** to open the **Lock Domain Hardware Resources** dialog.

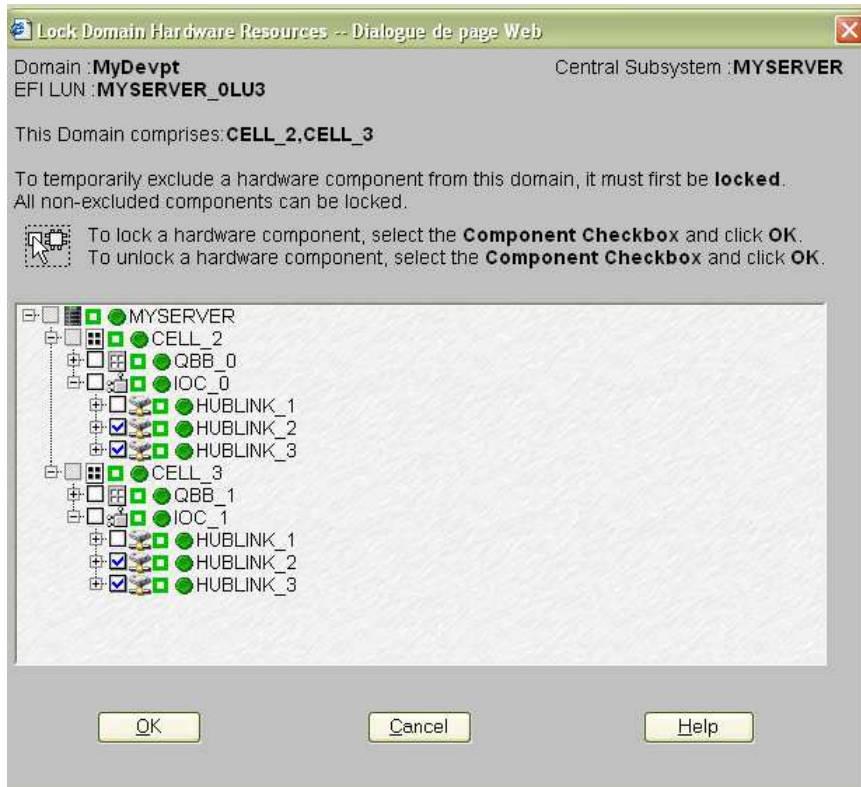

Figure 171. Lock domain hardware resources - example 4

31. Select the resources you want to lock and click **OK** to return to the **Scheme Management** dialog. See *Limiting Access to Hardware Resources*, on page 5-66 for details.

32. Click **Save**. The domain configuration scheme is now available for domain management.



Note:

Cell 0 is free and available for use by another scheme, if required.

Configuring and Managing Extended Systems

A single PAP unit can administer, monitor, and manage several Central Subsystems.

The PAM **Domain Configuration Scheme Wizard** allows easy configuration of extended systems.

Please contact your BULL Customer Sales Representative for details.

Scheme, Domain Identity, and Resources Checklists

Scheme Checklist	
Name	What name do I want to use for my Scheme?
Description	How can I describe my Scheme to reflect its scope?
Central Subsystem(s)	Which Central Subsystem(s) do I want to use?
Number of Domains	How many domains do I need?
Domain Size	How many cells do I want to assign to each domain?
EFI Boot LUNs	Which EFI boot LUN do I want to use for each domain?
Data LUNs *	Which data LUNs do I want to assign to each domain?
Fibre Channel Hosts *	Which fibre channel host(s) do I want to use to access LUNs?
I/O Resource Location	Which cells host the I/O resources I want to use?
Resource Access	Do I want to limit access to certain hardware resources?

* Reserved for systems connected to a Storage Area Network (SAN).

Table 53. Scheme configuration checklist

Domain Identity Checklist	
Name	What name do I want to use for my Domain Identity to reflect the tasks/jobs it will run?
Description	How can I describe my Domain Identity to reflect its use?
Operating System	Which OS do I want to run on this domain? Will this OS support assigned hardware (CPUs, DIMMs)?
Domain Network Name	Which network name will be used to identify this domain?
Domain IP Address	Which IP address will be used to reach this domain?
Domain URL	Which URL can be used to reach my domain Web site (if any)?
Multithreading Mode	Do the CPUs used by this domain support the multithreading mode? Do I want to enable the multithreading mode for this domain?
High Memory IO Space	Do I need more than 4GB PCI gap space for the PCI boards used by this domain?
Licensing Number	Do I intend to install an application protected by a system serial number on this domain? Do I want to substitute the physical system serial number with the logical licensing number for optimum flexibility?
Force Halt on Machine Check Reset	Has my Customer Service Engineer requested me to check this box to troubleshoot my server?

Table 54. Domain Identity configuration checklist

Resources Checklist			
Central Subsystem:			
Cell 0		Cell 1	
QBBs	QBB0	QBBs	QBB1
IO Box	IOC0	IO Box	IOC1
EFI Boot Lun	OLu0	EFI Boot Lun	OLu1
OS instance		OS instance	
I/O Resources		I/O Resources	
IOC0_Slot 1		IOC1_Slot 1	
IOC0_Slot 2		IOC1_Slot 2	
IOC0_Slot 3		IOC1_Slot 3	
IOC0_Slot 4		IOC1_Slot 4	
IOC0_Slot 5		IOC1_Slot 5	
IOC0_Slot 6		IOC1_Slot 6	

Table 55. Resources checklist - part 1

Resources Checklist			
Cell 2		Cell 3	
QBBs	QBB0	QBBs	QBB1
IO Box	IOC0	IO Box	IOC1
EFI Boot Lun	1Lu0	EFI Boot Lun	1Lu1
OS instance		OS instance	
I/O Resources		I/O Resources	
IOC0_Slot 1		IOC1_Slot 1	
IOC0_Slot 2		IOC1_Slot 2	
IOC0_Slot 3		IOC1_Slot 3	
IOC0_Slot 4		IOC1_Slot 4	
IOC0_Slot 5		IOC1_Slot 5	
IOC0_Slot 6		IOC1_Slot 6	

Table 56. Resources checklist - part 2

Resources Checklist			
Cell 4		Cell 5	
QBBs	QBB0	QBBs	QBB1
IO Box	IOC0	IO Box	IOC1
EFI Boot Lun	1Lu0	EFI Boot Lun	1Lu1
OS instance		OS instance	
I/O Resources		I/O Resources	
IOC0_Slot 1		IOC1_Slot 1	
IOC0_Slot 2		IOC1_Slot 2	
IOC0_Slot 3		IOC1_Slot 3	
IOC0_Slot 4		IOC1_Slot 4	
IOC0_Slot 5		IOC1_Slot 5	
IOC0_Slot 6		IOC1_Slot 6	

Table 57. Resources checklist - part 3

Resources Checklist			
Cell 6		Cell 7	
QBBs	QBB0	QBBs	QBB1
IO Box	IOC0	IO Box	IOC1
EFI Boot Lun	1Lu0	EFI Boot Lun	1Lu1
OS instance		OS instance	
I/O Resources		I/O Resources	
IOC0_Slot 1		IOC1_Slot 1	
IOC0_Slot 2		IOC1_Slot 2	
IOC0_Slot 3		IOC1_Slot 3	
IOC0_Slot 4		IOC1_Slot 4	
IOC0_Slot 5		IOC1_Slot 5	
IOC0_Slot 6		IOC1_Slot 6	

Table 58. Resources checklist - part 4

Section V - Creating Event Subscriptions and User Histories

This section explains how to:

- Customize the PAM Event Messaging System, on page 5-133
- Set up Event Subscriptions, on page 5-134
- Create, Edit, Delete an E-mail Server, on page 5-136
- Create, Edit, Delete an E-mail Account, on page 5-138
- Create, Edit, Delete a User History, on page 5-157
- Enable / Disable Event Channels, on page 5-140
- Create, Edit, Delete an Event Subscription, on page 5-141
- Understand Event Message Filtering Criteria, on page 5-143
- Preselect, Create, Edit, Delete an Event Filter, on page 5-153

Customizing the PAM Event Messaging System

During operation, all Central Subsystem activity messages are automatically logged in predefined System Histories that can be viewed and archived by members of the Customer Administrator group. In addition, PAM software reports and logs environmental, command, and hardware errors.

A comprehensive set of Event Message subscriptions allows connected and non-connected users to be notified of system status and activity.

The PAM event messaging system is based on a subscription mechanism allowing the Customer Administrator to send precisely filtered event messages to targeted individuals and/or groups via four channels (WEB Interface, E-mail, User History, SNMP) as shown in Figure 172.

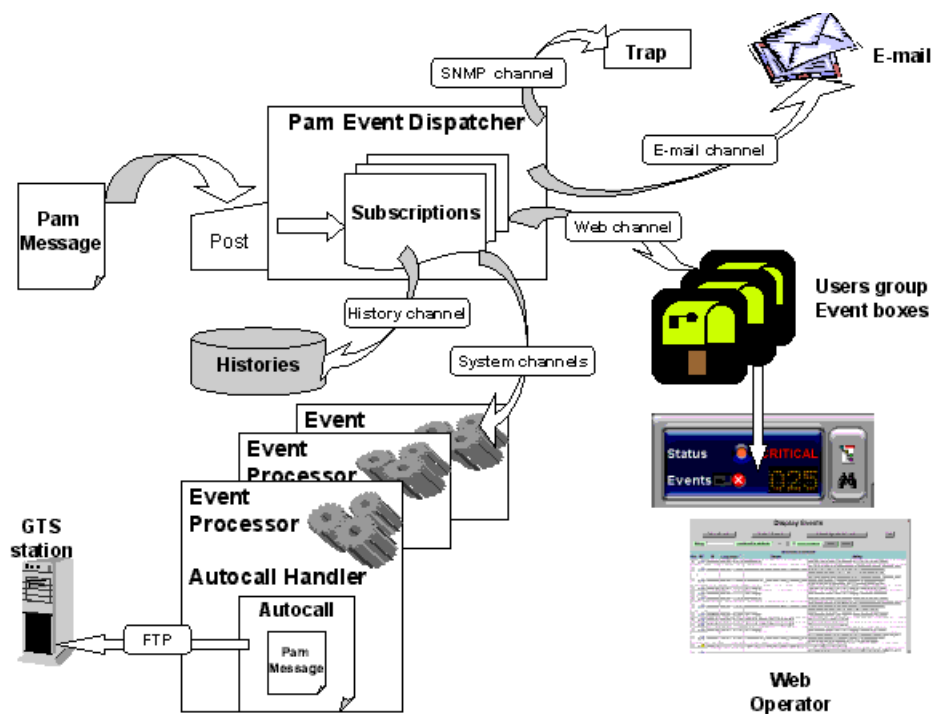

Figure 172. PAM event messaging system features

Note:

PAM software is delivered with a set of predefined subscriptions that have been designed to suit the needs of most Administrators and Operators. If required, you can use PAM **Configuration** tools to set up customized subscriptions.

From the PAM tree, expand the **Configuration Tasks** and **Events** nodes to display event configuration options.

Setting up Event Subscriptions

Before creating an event subscription, you should establish:

- the set of messages you want a user or a group of users to receive (**Filter**),
- how you want the user or group of users to receive messages (**Channel**).

Selecting a Filter

The comprehensive event message filtering system allows you to use a predefined filter or to create a specific filter, according to your needs.

See *Preselecting an Event Filter*, on page 5-153 and *Creating an Event Filter*, on page 5-154.

Selecting a Channel







Four channels can be used to forward event messages, according to targeted recipients:

Channel	Advantage
E-mail	Allows a specific user to receive system notifications/ alerts.
User history	Records specific system operations/alerts into a dedicated log file.
Web	Allows a specific group of users to be warned of system operations/alerts when connected to the PAM Web interface.
SNMP	Forwards specific messages as SNMP traps to the selected SNMP application.

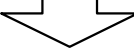
Table 59. Event channels

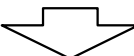
Event Subscription Flowcharts

Once you have established who the targeted recipients are and which channel you want to use, you can use the following flowcharts as a quick guide to event subscription procedures.

E-mail Event Subscription
Allows a specific user to receive system notifications/alerts via e-mail.
<i>Preselect an Event filter, on page 5-153, or Create an Event Filter, on page 5-154.</i>

Select or <i>Create an E-mail Server, on page 5-136.</i>

Select or <i>Create an E-mail Account, on page 5-138.</i>

<i>Create the Event Subscription, on page 5-141.</i>
User History Event Subscription
Records specific system operations/alerts into a dedicated log file.
<i>Preselect an Event filter, on page 5-153, or Create an Event Filter, on page 5-154.</i>

Select or <i>Create a User History, on page 5-158.</i>

<i>Create the Event Subscription, on page 5-141.</i>
Web Event Subscription
Allows a specific group of users to be warned of system operations/alerts when connected to the PAM Web interface.
<i>Preselect an Event filter, on page 5-153, or Create an Event Filter, on page 5-154.</i>

<i>Create the Event Subscription, on page 5-141.</i>
SNMP Event Subscription
Forwards system operations/alerts as SNMP traps to the selected SNMP Manager.
<i>Preselect an Event filter, on page 5-153, or Create an Event Filter, on page 5-154.</i>

<i>Create the Event Subscription, on page 5-141.</i>

Creating, Editing, Deleting an E-mail Server

To send messages via the e-mail channel, you must first create an e-mail server. Several e-mail accounts can then be attached to the same e-mail server, see *Creating an E-mail Account*, on page 5-138.

Creating an E-mail Server



Important:

Before creating an E-mail server, you must first complete the Site engineer email account field on the Customer Information page. This account will be displayed in the Sender email field, as shown in the following screen shot. See *Modifying Customer Information*, on page 5-19.

To create an e-mail server:

1. Click **Configuration Tasks** → **Events** → **E-mail servers** in the PAM tree. The e-mail servers configuration page opens.

Create a New E-mail Server

An e-mail server is defined by its logical name and URL address.
Optionally, a description, a UserName and Password may be added.
An e-mail server is used in association with an e-mail account to send event messages.

Server Name :

URL :

Description :

UserName :

Password :

Security : Anonymous Basic Secure

Sender email : site.engineer@customer.net

Indicates Required Field.

OK Cancel

Figure 173. E-mail servers configuration page

2. Click **New** in the toolbar.
3. Enter the server name in the **Name** field, the address of the existing e-mail server you intend to use in the **URL** field, and a brief description, if required, in the **Description** field.
4. Select the required **Security** level and enter the corresponding username and password (**Basic** and **Secure** levels only).
5. Click **OK** to confirm the creation of the new e-mail server.

Editing E-mail Server Attributes

To modify an e-mail server URL / description:

1. Click **Configuration Tasks** → **Events** → **E-mail servers** in the PAM tree. The e-mail server configuration page opens. See Figure 173 above.
2. Select the required server from the e-mail servers list.
3. Click **Edit** in the toolbar to modify the server URL / description.
4. Enter a new address in the **URL** field and/or a new description in the **Description** field, as applicable.
5. Click **OK** to confirm the modification.

Deleting an E-mail Server



Important:

Before deleting an e-mail server, all the accounts attached to that server must be attached to another server, or deleted.

At least one e-mail server must be defined to send messages via the e-mail channel.

If e-mail accounts are attached to this e-mail server:

- see *Editing E-mail Account Attributes*, on page 5-137 to attach these accounts to another server, or
- see *Deleting an E-mail Account*, on page 5-139 to delete these accounts.

To delete an e-mail server:

1. Click **Configuration Tasks** → **Events** → **E-mail Servers** in the PAM tree. The e-mail server configuration page opens. See Figure 173, on page 5-136.
2. Select the required server from the e-mail servers list.
3. Click **Delete** in the toolbar.
4. Click **OK** to confirm the deletion of the selected e-mail server.

Creating, Editing, Deleting an E-mail Account

To send messages via the e-mail channel, you must first create an e-mail server and then attach an e-mail address to this e-mail server. Several e-mail accounts can be attached to the same e-mail server.

Creating an E-mail Account

To create an e-mail account:

1. Click **Configuration Tasks** → **Events** → **E-mail accounts** in the PAM tree. The e-mail accounts configuration page opens.

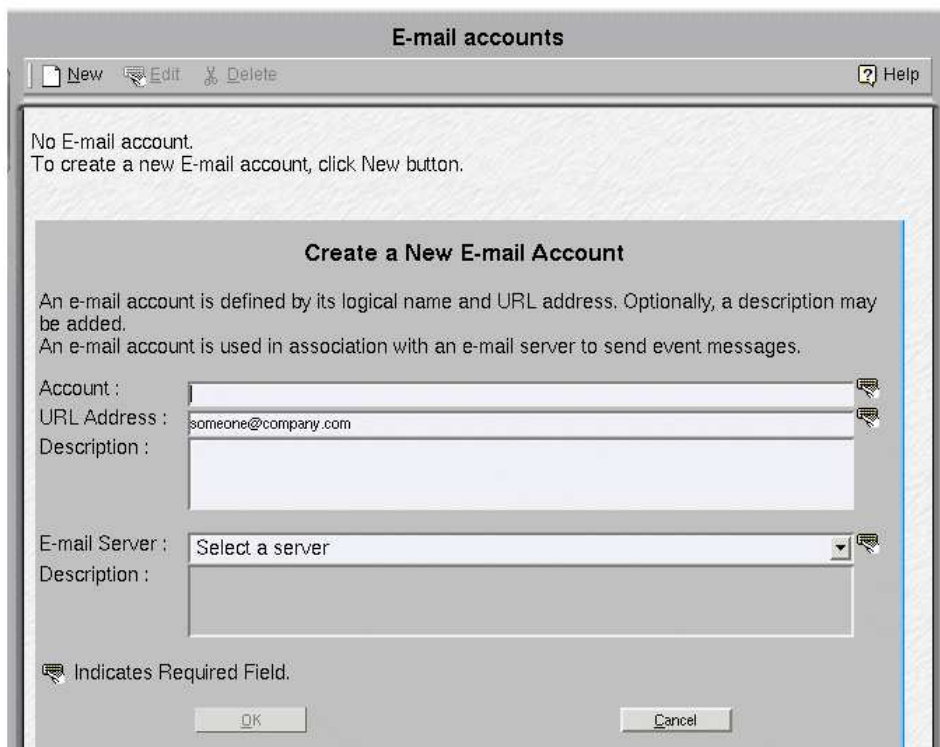

Figure 174. E-mail accounts configuration page

2. Click **New** in the toolbar.
3. Enter the new account name in the **Account** field and corresponding e-mail address in the **URL Address** field.
4. Select the server to be used to deliver messages to this address from the **E-mail Server** list. If the required e-mail server is not in the list, see **Creating an E-mail Server, on page 5-136**.
5. Enter a brief description, if required, in the **Description** field.
6. Click **OK** to confirm the creation of the new e-mail account.

The new e-mail account can now be selected when you set up an event subscription to be sent via the e-mail channel.



Note:

The **OK** button is accessible once all mandatory fields have been completed.

Editing E-mail Account Attributes

To modify an e-mail account name, address, server and/or description:

1. Click **Configuration Tasks** → **Events** → **E-mail accounts** in the PAM tree. The e-mail accounts configuration page opens. **See Figure 174 above.**
2. Select the required account from the e-mail accounts list.
3. Click **Edit** in the toolbar to modify the account name, address, server and/or description.
4. Enter the new attributes in the corresponding fields, as applicable. If the required e-mail server is not in the list, see **Creating an E-mail Server, on page 5-136.**
5. Click **OK** to confirm the modification.

Deleting an E-mail Account



Important:

Before deleting an e-mail account, all the event subscriptions attached to that account must be attached to another account, or deleted.

If event subscriptions are attached to this e-mail account, see:

- **Editing Event Subscription Attributes, on page 5-142** to attach these event subscriptions to another account,
- or **Deleting an Event Subscription, on page 5-142** to delete these event subscriptions.

To delete an e-mail account:

1. Click **Configuration Tasks** → **Events** → **E-mail accounts** in the PAM tree. The e-mail accounts configuration page opens. **See Figure 174 above.**
2. Select the required account from the e-mail accounts list.
3. Click **Delete** in the toolbar.
4. Click **OK** to confirm the deletion of the selected e-mail account.

Enabling / Disabling Event Channels

An event channel must be selected and enabled for all event subscriptions. The following table provides the Customer Administrator with guidelines for selecting an event channel.

Channel	Target	Enabled	Disabled
EMAIL	Specific recipient.	Allows a specific recipient to directly receive specific messages.	Advanced feature: Only to be used if the system generates too many messages and maintenance actions are to be carried out.
LOG (User History)	All user groups.	Allows all users to access specific messages.	
SNMP	SNMP application.	Forwards specific messages as SNMP traps to the selected SNMP application for processing.	
WEB (PAM Interface)	Selected users.	Allows a specific group of users to view specific messages.	

Table 60. Event channel selection guidelines



Note:

When an event channel is disabled, all messages sent via that channel are lost. All event channels are enabled by default.

To enable / disable an event channel:

1. Click **Configuration Tasks** → **Events** → **Channels** in the PAM tree. The channels configuration page opens.

Channel Name	Enable	Description
EMAIL	<input checked="" type="radio"/> Yes <input type="radio"/> No	Email Channel
LOG	<input checked="" type="radio"/> Yes <input type="radio"/> No	History Channel
SNMP	<input checked="" type="radio"/> Yes <input type="radio"/> No	SNMP Channel
WEB	<input checked="" type="radio"/> Yes <input type="radio"/> No	Web Channel

Figure 175. Event Channels configuration page

2. Select the **Yes** or **No** radio button in the **Enable** column to enable or disable the required channel.
3. Click the **Save** icon to confirm the new configuration.

Creating, Editing, Deleting an Event Subscription

Once event subscription prerequisites have been set up, you can create the event subscriptions required to send messages to their destinations. See **Event Subscription Flowcharts**, on page 5-135.

Creating an Event Subscription

To create an event subscription:

1. Click **Configuration Tasks** → **Events** → **Subscriptions** in the PAM tree. The event subscription configuration page opens.
2. Click **New** in the toolbar.

The screenshot shows a window titled "Subscriptions" with a toolbar containing "New", "Edit", "Delete", "Test Subscription", and "Help". Below the toolbar is a table with columns: Name, Enable, Active, Channel, Address, and Filter. The table contains one row with the value "PAMALLEVENTS" in the Name, Address, and Filter columns, and "YES" in the Enable and Active columns. Below the table is a form titled "Create a New Event Subscription". The form includes a text area for "Subscription Name" and "Description", two checked checkboxes for "Enable" and "Active", and a "Channel Type" section with radio buttons for "E-MAIL", "LOG (History)", "SNMP", and "WEB". Below the radio buttons is a note: "When you select the Log channel, all event messages matching the criteria defined in the selected Filter will be sent to the selected User History log." There are also dropdown menus for "User History" and "Filter", each with a "Description" field below it. At the bottom of the form, there is a legend: "Indicates Required Field." and buttons for "OK", "Cancel", and "Help".

Figure 176. New Event Subscription dialog box

3. Select the **Active** and **Enable** checkboxes to activate and enable the new subscription.
4. Enter a short, readily identifiable name in the **Name** field and a brief description, if required, in the **Description** field.
5. Select the required channel radio button:
 - **E-MAIL**: to send event messages to an e-mail address.
 - **LOG**: to send event messages to a user history.
 - **SNMP**: to send event messages to the SNMP Manager.
 - **WEB**: to send event messages to the status pane in the PAM web interface.

6. Select a pre-configured E-mail Account, User History, or User Group from the drop-down menu or enter an SNMP Manager IP address or server name.
7. Select a pre-configured filter from the **Filter** drop-down menu.
8. Click **OK** to confirm the creation of the new event subscription.
9. The event subscription configuration page is automatically updated with the new subscription.
10. Click **Test Subscription** to check that the event subscription has been configured correctly. Subscription parameters will be used to send a test message.



Note:

The **OK** button is accessible once all mandatory fields have been completed.

Editing Event Subscription Attributes

To modify an event subscription description, channel, address and/or filter, or to activate / deactivate and/or enable / disable an event subscription:

1. Click **Configuration Tasks** → **Events** → **Subscriptions** in the PAM tree. The event subscription configuration page opens.
2. Select the required event subscription in the event subscription table.
3. Click **Edit** to modify the attributes of this event subscription. The **Edit Event Subscription** dialog box opens.
4. Select the new channel, E-mail Account, User History, or User Group from the drop-down menu or enter a new SNMP Manager IP address or server name.
5. Modify the description.
6. If required, activate / deactivate and/or enable / disable the event subscription by selecting / deselecting the **Active** and **Enable** checkboxes.



Warning:

If you deactivate / disable an event subscription, no events will be sent to the recipient(s) until the event subscription is reactivated / re-enabled.

7. Click **OK** to confirm the modification.
8. Click **Test Subscription** to check that the event subscription has been re-configured correctly.



Note:

The **OK** button is accessible once all mandatory fields have been completed.

Deleting an Event Subscription

To delete an event subscription:

1. Click **Configuration Tasks** → **Events** → **Subscriptions** in the PAM tree. The event subscription configuration page opens.
2. Select the required event subscription in the event subscription table.
3. Click **Delete** in the toolbar. The **Delete Subscription** dialog box opens.
4. Click **OK** to confirm the deletion of the selected event subscription.

Understanding Event Message Filtering Criteria

The set of predefined filters supplied with PAM software covers everyday event messaging requirements. However, a comprehensive filtering system allows you to finely tune event messaging criteria, if required.

Before creating a new event filter, you should get to know filtering criteria options.

1. Click **Configuration Tasks** → **Events** → **Filters** in the PAM tree. The filter configuration page opens with the list of existing event message filters.
2. Click **New** to display the **Standard Filter** page.

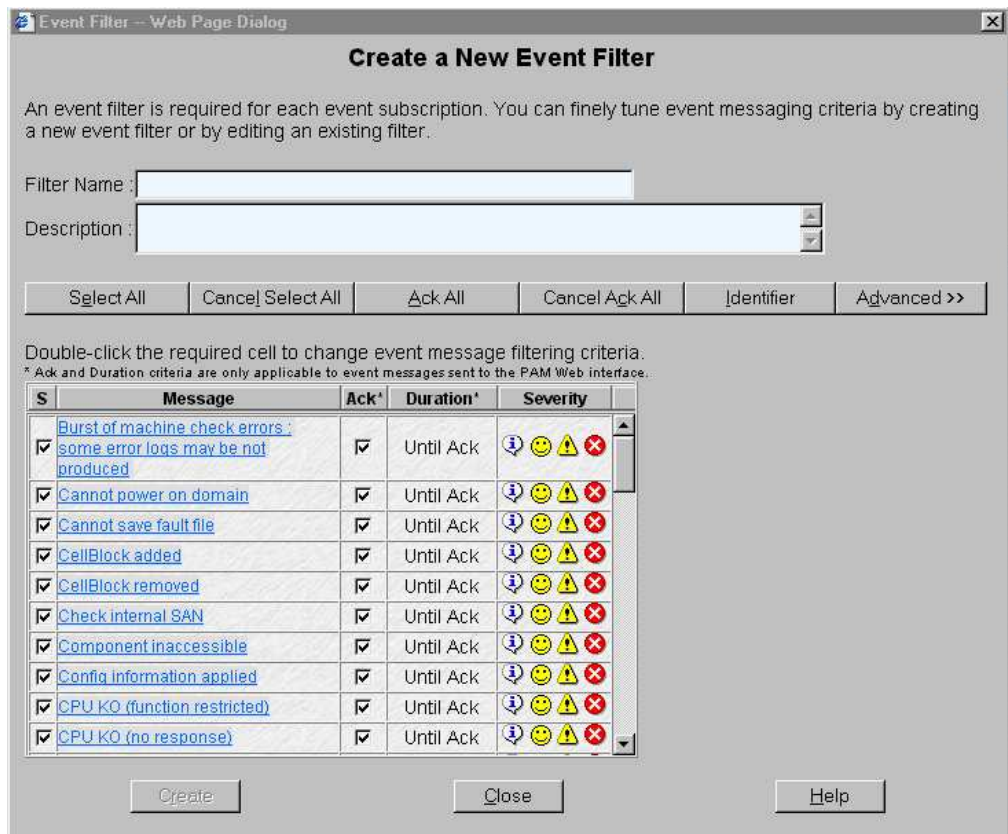

Figure 177. Event message standard filtering criteria chart

3. Click **Advanced** to display the **Advanced Filter** page.

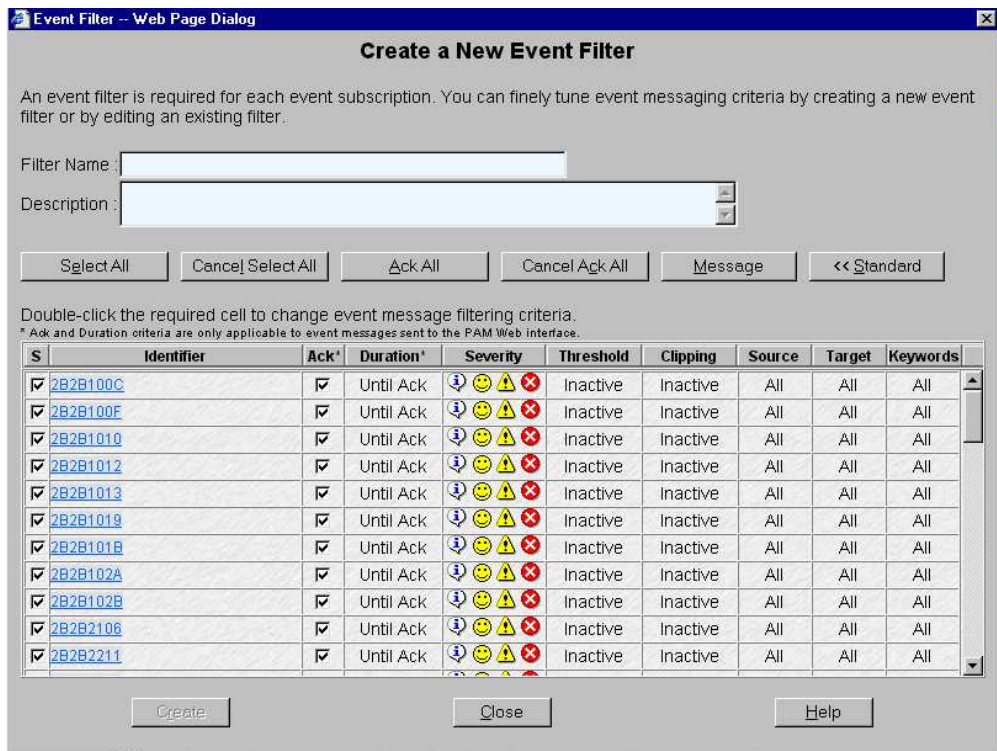

Figure 178. Event message advanced filtering criteria chart

4. Carefully analyze Tables 61 and 62 to understand the various options.

Standard Event Message Filtering Criteria

Criteria	Description
Select	<p>All the checkboxes in this column are selected by default. When an event message S checkbox is deselected, the event message is removed from the filter.</p> <p>Actions</p> <ul style="list-style-type: none"> - Select the S checkbox if you want to include the event message in the new filter. - Deselect the S checkbox if you do not want to include the event message in the new filter.
Message/Identifier	<p>Gives a message description and provides a clickable link to the associated help messages.</p> <p>Actions</p> <ul style="list-style-type: none"> - Toggle the Message/Identifier column by clicking Message or Identifier in the toolbar. - Double click the required message. The corresponding help message opens.
Acknowledge	<p>This column is only applicable to messages sent to the PAM Web interface and is interactive with the Duration column (see below). All the checkboxes in this column are selected by default. When the message Ack checkbox is selected, the event message will be displayed in the event list until it is manually acknowledged by a user.</p> <p>Note: The PAM Web interface stores up to 150 event messages maximum per user group (100 messages by default). Once this limit has been reached, messages may be deleted in order of arrival, even if they have not been acknowledged.</p> <p>Actions</p> <ul style="list-style-type: none"> - Select the Ack checkbox if you want the event message to be displayed until it is manually acknowledged by a user. - Deselect the Ack checkbox if you want the event message to be deleted automatically after a specified period of time. The Duration dialog box opens (see below).

Criteria	Description
<p>Duration</p>	<p>This column is only applicable to messages sent to the PAM Web interface and is interactive with the Ack column (see above). When the specified duration expires, the event message is deleted automatically.</p> <p>Note: The PAM Web interface stores up to 150 event messages maximum per user group (100 by default). Once this limit has been reached, messages may be deleted in order of arrival, even if the set duration has not expired.</p> <div data-bbox="730 584 1211 987" data-label="Image"> </div> <p>Actions</p> <ul style="list-style-type: none"> - Double click the Duration cell to open the Message Display Duration dialog box. - Select the Display message until acknowledged checkbox if you want to manually acknowledge the message before it is removed from the display and click OK to apply. - Enter a value in the Duration field and use the drop-down menu to select the duration unit: seconds, minutes, hours, or days. - The Apply to this message only radio button is selected by default. If required, select another radio button to apply the duration setting to other messages included in the filter. - Click OK to set the duration. The new duration value is displayed in the Duration cell and the Ack checkbox is deselected (see above).

Criteria	Description
Severity Level	<p>This column is used to set message severity level(s): Information, Success, Warning, and Error. At least one severity level must be selected to define the filter.</p> <p>Actions</p> <ul style="list-style-type: none"> - Double click the Severity cell to open the dialog box. <div data-bbox="794 454 1323 875" data-label="Image"> </div> <ul style="list-style-type: none"> - All severity levels are selected by default. Deselect the required checkbox to remove a severity level from the filter. - Select the Apply to all messages checkbox to apply this severity level to all the messages included in the filter. - Click OK to set and apply the severity level. The new severity level is displayed in the corresponding Severity cell.

Table 61. Standard event message filtering criteria

Advanced Event Message Filtering Criteria



Note:

Advanced filtering criteria are reserved for advanced users and are to be used with care.

Criteria	Description
<p>Thresholding</p>	<p>Thresholding is defined on a Count / Period basis aimed at routing significant messages only. Identical messages are counted and when the number of messages indicated in the Threshold Count field is reached within the period of time indicated in the Threshold Period field, this message is selected for routing.</p> <p>Actions</p> <ul style="list-style-type: none"> - Double click the Threshold cell to open the dialog box. <div data-bbox="715 725 1249 1227" data-label="Image"> </div> <ul style="list-style-type: none"> - Select the Threshold Inactive radio button to deactivate thresholding. - Select the Apply to all messages checkbox to deactivate the thresholding setting on all the messages included in the filter. - Select the Threshold Active radio button to activate thresholding. - Enter the required number of messages in the Threshold Count field, the required period of time in the Threshold Period field, and use the drop-down menu to select the time unit: seconds, minutes, hours, or days. - Select the corresponding radio button to apply thresholding settings to one or more messages included in the filter. <p>Note: The Apply to this message only radio button is selected by default.</p> <ul style="list-style-type: none"> - Click OK to set thresholding. The new Threshold Count and Threshold Period settings are displayed in the Threshold cell. <p>Note: Inactive is displayed in the Threshold cell when thresholding is deactivated.</p>

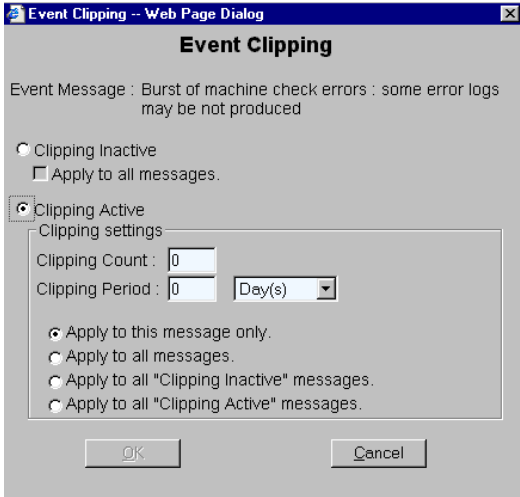
Criteria	Description
<p>Clipping</p>	<p>Clipping is defined on a Count / Period basis aimed at routing a pre-defined number of messages only. Identical messages are counted and when the number of messages indicated in the Clipping Count field is reached within the period of time indicated in the Clipping Period field, no other messages will be selected for routing.</p> <p>Actions</p> <ul style="list-style-type: none"> - Double click the Clipping cell to open the dialog box.  <ul style="list-style-type: none"> - Select the Clipping Inactive radio button to deactivate clipping. - Select the Apply to all messages checkbox to deactivate the thresholding setting on all the messages included in the filter. - Select the Clipping Active radio button to activate clipping. - Enter the required number of messages in the Clipping Count field, the required period of time in the Clipping Period field, and use the drop-down menu to select the time unit: seconds, minutes, hours, or days. - Select the corresponding radio button to apply clipping settings to one or more messages included in the filter. <p>Note: The Apply to this message only radio button is checked by default.</p> <ul style="list-style-type: none"> - Click OK to set clipping. The new Clipping Count and Clipping Period settings are displayed in the Clipping cell. <p>Note: Inactive is displayed in the Clipping cell when clipping is deactivated.</p>

Criteria	Description
<p>Source</p>	<p>Each event message refers to a source (the component that generated the message) and a target (the component referred to in the message) (see below). This feature allows messages to be filtered according to one or more Source string(s) and is particularly useful for debugging and troubleshooting.</p> <p>Actions</p> <ul style="list-style-type: none"> - Double click the Source cell to open the dialog box. - Select a source filter from the Event Sources list. - If the list is empty, enter a source string in the Source filter field and click Add. The new source filter is displayed in the Event Sources list. (Example source strings can be viewed in history files). <div data-bbox="614 689 1316 1189" data-label="Image"> </div> <ul style="list-style-type: none"> - Click Remove or Remove All to remove one or more source strings from the Event Sources list. - Repeat for each source string to be included in the filter. - Click Apply list to all messages to apply the specified source list to all the messages included in the filter. - Click OK to apply the source list. Specified is displayed in the Source cell. <p>Note: All is displayed in the Source cell if the source is not specified.</p>

Criteria	Description
Target	<p>Each event message refers to a target (the component referred to in the message) and a source (the component that generated the message) (see above). This feature allows messages to be filtered according to one or more Target string(s) and is particularly useful for debugging and troubleshooting.</p> <p>Actions</p> <ul style="list-style-type: none"> - Double click the Target cell to open the dialog box. - Select a target filter from the Event Targets list. - If the list is empty, enter a target string in the Target filter field and click Add. The new target filter is displayed in the Event Targets list. (Example target strings can be viewed in history files). <div data-bbox="724 692 1406 1189" data-label="Image"> </div> <ul style="list-style-type: none"> - Click Remove or Remove All to remove one or more target strings from the Event Targets list. - Repeat for each target string to be included in the filter. - Click Apply list to all messages to apply the specified target list to all the messages included in the filter. - Click OK to apply the target list. Specified is displayed in the Target cell. <p>Note: All is displayed in the Target cell if the target is not specified.</p>

Criteria	Description
Keyword	<p>This feature allows messages to be filtered according to a Keyword contained in the messages. Any relevant word(s) contained in source / target strings can be used.</p> <p>Actions</p> <ul style="list-style-type: none"> - Double click the Keywords cell to open the dialog box. - Select a keyword filter from the Event Keywords list. - If the list is empty, enter a keyword in the Keyword filter field and click Add. The new keyword filter is displayed in the Event Keywords list. (Example keywords can be viewed in history files).  <ul style="list-style-type: none"> - Click Remove or Remove All to remove one or more keyword from the Event Keywords list. - Repeat for each keyword to be included in the filter. - Click Apply list to all messages to apply the specified keyword list to all the messages included in the filter. - Click OK to apply the keyword list. Specified is displayed in the Keyword cell. <p>Note: All is displayed in the Keywords cell if the keyword is not specified.</p>

Table 62. Advanced event message filtering criteria

Preselecting, Creating, Editing, Deleting an Event Filter

An event filter must be selected for all event subscriptions. The event messaging system is delivered with a set of predefined filters.

Preselecting an Event Filter

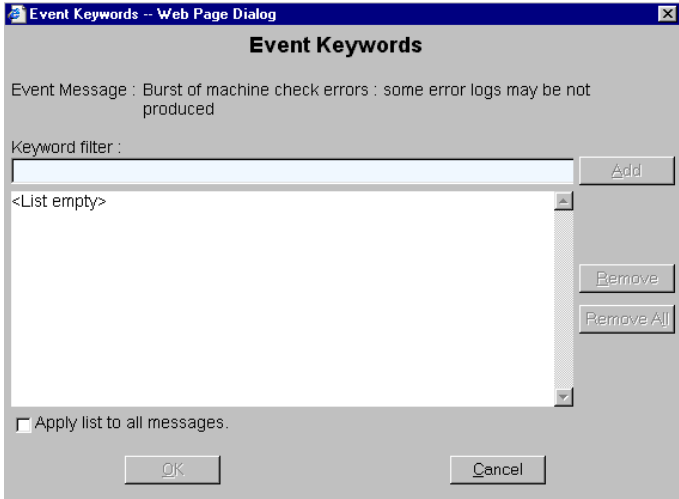
Before proceeding to set up an event subscription, you are advised to check which predefined filter is adapted to your needs:

1. Click **Configuration Tasks** → **Events** → **Filters** in the PAM tree. The filter configuration page opens.

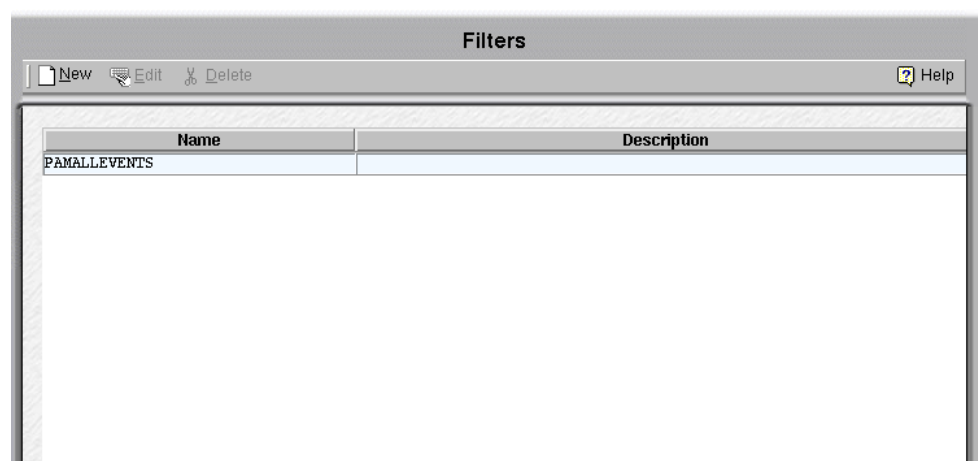

Figure 179. Filters configuration page

2. Check that the required filter is present.

You may also define a specific filter by using the comprehensive event message filtering utility. See *Creating an Event Filter*, on page 5-154.

Creating an Event Filter

Once you have established which filtering criteria you want to apply to your new filter, you can proceed to create a new event filter:

1. Click **Configuration Tasks** → **Events** → **Filters** in the PAM tree. The filter configuration page opens with the list of existing event message filters.
2. Click **New** to display the **Create a New Event Filter** page. The standard event message filtering criteria table is displayed.

Create a New Event Filter

An event filter is required for each event subscription. You can finely tune event messaging criteria by creating a new event filter or by editing an existing filter.

Filter Name :

Description :

Select All | Cancel Select All | Ack All | Cancel Ack All | Identifier | Advanced >>

Double-click the required cell to change event message filtering criteria.
* Ack and Duration criteria are only applicable to event messages sent to the PAM Web interface.

S	Message	Ack*	Duration*	Severity
<input checked="" type="checkbox"/>	Burst of machine check errors : some error logs may be not produced	<input checked="" type="checkbox"/>	Until Ack	Info Warning Error
<input checked="" type="checkbox"/>	Cannot power on domain	<input checked="" type="checkbox"/>	Until Ack	Info Warning Error
<input checked="" type="checkbox"/>	Cannot save fault file	<input checked="" type="checkbox"/>	Until Ack	Info Warning Error
<input checked="" type="checkbox"/>	CellBlock added	<input checked="" type="checkbox"/>	Until Ack	Info Warning Error
<input checked="" type="checkbox"/>	CellBlock removed	<input checked="" type="checkbox"/>	Until Ack	Info Warning Error
<input checked="" type="checkbox"/>	Check internal SAN	<input checked="" type="checkbox"/>	Until Ack	Info Warning Error
<input checked="" type="checkbox"/>	Component inaccessible	<input checked="" type="checkbox"/>	Until Ack	Info Warning Error
<input checked="" type="checkbox"/>	Config information applied	<input checked="" type="checkbox"/>	Until Ack	Info Warning Error
<input checked="" type="checkbox"/>	CPU KO (function restricted)	<input checked="" type="checkbox"/>	Until Ack	Info Warning Error
<input checked="" type="checkbox"/>	CPU KO (no response)	<input checked="" type="checkbox"/>	Until Ack	Info Warning Error

Create | Close | Help

Figure 180. New Filter configuration page - standard event message filtering criteria table

3. Enter a relevant name in the **Filter Name** field and a brief description, if required, in the **Description** field.

Note:

For further details about event filtering criteria and options, see *Standard Event Message Filtering Criteria*, on page 5-145 and *Advanced Event Message Filtering Criteria*, on page 5-148.

4. Deselect the **S** checkbox for the event messages not to be included in the filter.
5. If the filter is to be used to send messages to the PAM Web interface, select the **Ack** checkbox if you want the event message to be manually acknowledged by a user; or deselect the **Ack** checkbox to enter a display value in the **Duration** cell.
6. Double click the **Severity** cell to select the message severity level.

- If required, click **Advanced** to access advanced filtering criteria. The advanced event message filtering criteria chart is displayed.

Create a New Event Filter

An event filter is required for each event subscription. You can finely tune event messaging criteria by creating a new event filter or by editing an existing filter.

Filter Name :

Description :

Select All Cancel Select All Ack All Cancel Ack All Message << Standard

Double-click the required cell to change event message filtering criteria.
* Ack and Duration criteria are only applicable to event messages sent to the PAM Web interface.

S	Identifier	Ack*	Duration*	Severity	Threshold	Clipping	Source	Target	Keywords
<input checked="" type="checkbox"/>	2B2B100C	<input checked="" type="checkbox"/>	Until Ack	☹️ ⚠️ 🚫	Inactive	Inactive	All	All	All
<input checked="" type="checkbox"/>	2B2B100F	<input checked="" type="checkbox"/>	Until Ack	☹️ ⚠️ 🚫	Inactive	Inactive	All	All	All
<input checked="" type="checkbox"/>	2B2B1010	<input checked="" type="checkbox"/>	Until Ack	☹️ ⚠️ 🚫	Inactive	Inactive	All	All	All
<input checked="" type="checkbox"/>	2B2B1012	<input checked="" type="checkbox"/>	Until Ack	☹️ ⚠️ 🚫	Inactive	Inactive	All	All	All
<input checked="" type="checkbox"/>	2B2B1013	<input checked="" type="checkbox"/>	Until Ack	☹️ ⚠️ 🚫	Inactive	Inactive	All	All	All
<input checked="" type="checkbox"/>	2B2B1019	<input checked="" type="checkbox"/>	Until Ack	☹️ ⚠️ 🚫	Inactive	Inactive	All	All	All
<input checked="" type="checkbox"/>	2B2B101B	<input checked="" type="checkbox"/>	Until Ack	☹️ ⚠️ 🚫	Inactive	Inactive	All	All	All
<input checked="" type="checkbox"/>	2B2B102A	<input checked="" type="checkbox"/>	Until Ack	☹️ ⚠️ 🚫	Inactive	Inactive	All	All	All
<input checked="" type="checkbox"/>	2B2B102B	<input checked="" type="checkbox"/>	Until Ack	☹️ ⚠️ 🚫	Inactive	Inactive	All	All	All
<input checked="" type="checkbox"/>	2B2B2106	<input checked="" type="checkbox"/>	Until Ack	☹️ ⚠️ 🚫	Inactive	Inactive	All	All	All
<input checked="" type="checkbox"/>	2B2B2211	<input checked="" type="checkbox"/>	Until Ack	☹️ ⚠️ 🚫	Inactive	Inactive	All	All	All

Create Close Help

Figure 181. New Filter configuration page - advanced event message filtering criteria table

- When you have finished configuring your event filter, click **Create**.
- Repeat steps 3 to 8 for each new event filter you want to create.
- Click **Close** to save changes. The new filter appears in the **Filters** list.

Editing Event Filter Attributes

- Click **Configuration Tasks** → **Events** → **Filters** in the PAM tree. The filter configuration page opens with the list of existing event message filters. See Figure 180 above.
- Select the required filter from the event message filter list.
- Click **Edit** in the toolbar to modify filter attributes.
- Click **OK** to save changes.

Deleting an Event Filter



Important:

Before deleting an event filter, all the event subscriptions using that filter must either be modified to use another filter, or deleted.

- Click **Configuration Tasks** → **Events** → **Filters** in the PAM tree. The filter configuration page opens with the list of existing event message filters. See Figure 179 above.
- Select the required filter from the event message filter list.
- Click **Delete** in the toolbar.
- Click **OK** to confirm the deletion of the selected event filter.

Creating, Editing, Deleting a User History

There are two types of histories: System histories and User histories.

System histories cannot be modified and are only accessible to members of the Customer Administrator group.

User histories can be created, edited and deleted and are accessible to members of both the Customer Administrator and Customer Operator groups.

For guidance, System history contents are explained in the following table:

System History Contents

History Name	Contents
HistoryTrace	History Manager trace file. Logs archiving actions and history/archive processing errors.
InterventionReportHistory	Reserved for Support personnel.
IPMITrace	Reserved.
MaestroHistory	Reserved.
MaestroTrace	Reserved for Support personnel.
PAMHistory	Central PAM software history file. Logs all error or information messages concerning PAM software and all operator visible events.
PAMTrace	Logs domain power sequence trace data.
RPCTrace	Reserved for Support personnel.
SANTrace	Logs SAN-IT trace data.

Table 63. System history contents

Creating a User History



Note:

The Site Data Directory will be used, by default, if you do not specify a different directory when you create a user history. See *Viewing PAM Version Information*, on page 4-13

To create a user history:

1. Click **Configuration Tasks** → **User Histories** in the PAM tree. The **User Histories** control pane opens.
2. Click **New** in the toolbar. The **Create a New User History** dialog opens.

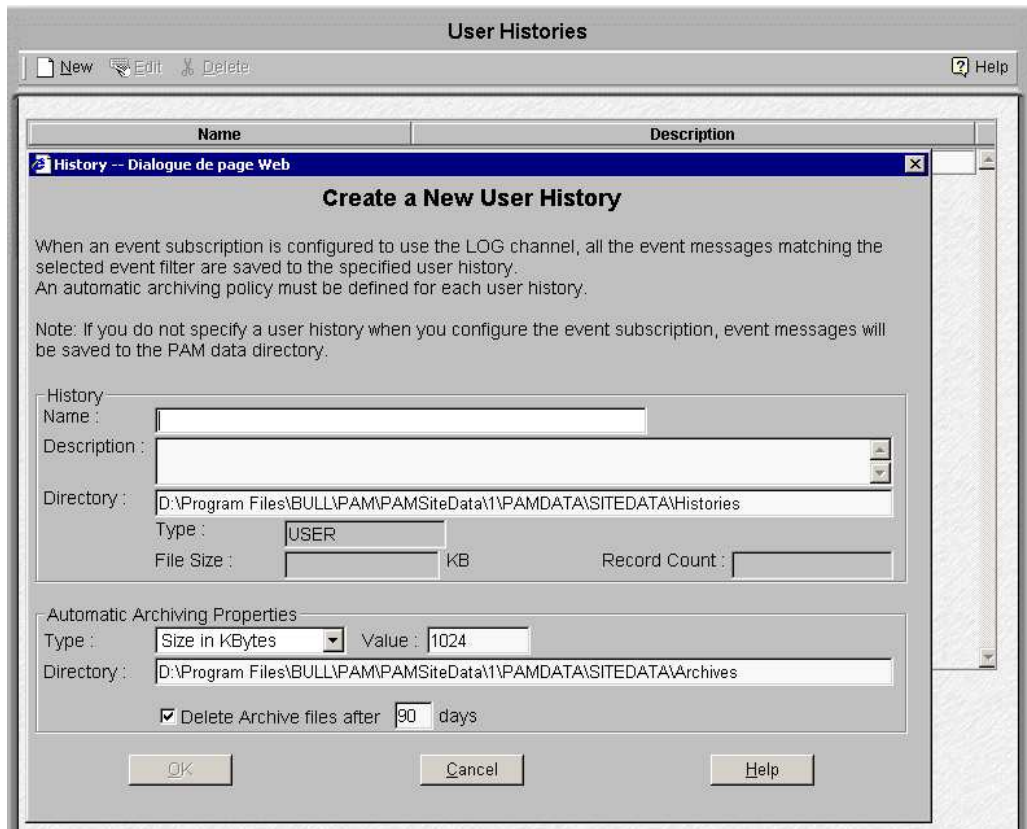

Figure 182. Create a New User History dialog

3. Enter a name in the **Name** field (mandatory) and a brief description, if required, in the **Description** field.
4. Enter a directory pathname in the **Directory** field. If this field is left blank, the default **Histories** directory will be used.

- Use the drop-down menu to select an automatic archiving policy **Type**:

Type	Automatic Archiving Policy
Number of Days	The system will automatically create an archive for this history after the number of days specified in the Value field.
Size in KBytes	The system will automatically create an archive when this history reaches the size in KBytes specified in the Value field. Note: Size in KBytes must be greater than 10.
Number of Records	The system will automatically create an archive when this history reaches the number of records specified in the Value field. Note: Number of Records must be greater than 10.

Table 64. History automatic archiving policies

- Enter the required number of days / KBytes / records in the **Value** field, as applicable.
- Enter a directory pathname in the **Directory** field. If this field is left blank, the default **Archives** directory will be used.
- If you want the archive to be automatically deleted at regular intervals, select the **Delete archive files** checkbox and enter the number of days you want to maintain the archive in the **days** field.
- Click **OK** to confirm the creation of the new history. The new history appears in the list of available histories.



Note:

The **OK** button is accessible once all mandatory fields have been completed.

Editing History Parameters

To modify the archiving parameters of system / user histories:

- Click **Configuration Tasks** → **Histories** in the PAM tree. The **Histories** control pane opens.
- Select the required History from the Histories list.
- Click **Edit** in the toolbar to modify the archiving parameters for this History. The **Edit History Parameters** page opens.
- Enter the new parameters in the corresponding fields.
- Click **OK** to confirm the modification.

Deleting a User History



Important:

Before deleting a user history, all the event subscriptions attached to that history must be attached to another history, or deleted. System histories cannot be deleted.

If event subscriptions are attached to this history:

- see *Editing Event Subscription Attributes*, on page 5-142 to attach these event subscriptions to another history, or
- see *Deleting an Event Subscription*, on page 5-142 to delete these event subscriptions.

To delete a user history:

1. Check that no event subscriptions are attached to this history.
2. Click **Configuration Tasks** → **Histories** in the PAM tree. The **Histories** control pane opens.
3. Select the required History from the Histories list.
4. Click **Delete** in the toolbar.
5. Click **OK** to confirm the deletion of the selected user history.

Appendix A. Specifications

- NovaScale 5085 Server Specifications, on page A-2
- NovaScale 5165 Server Specifications, on page A-4
- NovaScale 5245 Server Specifications, on page A-6
- NovaScale 5325 Server Specifications, on page A-8

NovaScale 5085 Server Specifications

NovaScale 5085 Servers are delivered rack-mounted in 40U or 19U cabinets.

The following web site may be consulted for general site preparation information:

<http://www.cs.bull.net/aise>.

Cabinet Dimensions / Weight	
Unpacked	Packed
1300H	
Height: 195.5 cm (77.0 in)	Height: 200.0 cm (78.7 in)
Width: 60.0 cm (23.6 in)	Width: 80.0 cm (31.5 in)
Depth: 129.5 cm (51.0 in)	Depth: 140.0 cm (55.1 in)
Weight (max): 340 kg (725 lb)	Weight (max): 370 kg (790 lb)
1300L	
Height: 103.5 cm (40.7 in)	Height: 108.0 cm (42.5 in)
Width: 60.0 cm (23.6 in)	Width: 80.0 cm (31.5 in)
Depth: 129.5 cm (51.0 in)	Depth: 140.0 cm (55.1 in)
Weight (max.): 290 kg (618 lb)	Weight (max.): 320 kg (682 lb)
Service Clearance	
Front	150 cm
Rear	100 cm
Side (free side)	100 cm
Operating Limits	
Dry bulb temperature range	+15°C to +30°C (+59°F to +86°F) Gradient 5°C/h (41°F/h)
Relative humidity (non-condensing)	35 to 60% (Gradient 5%/h)
Max. wet bulb temperature	+24°C (+75.2°F)
Moisture content	0.019 kg water/kg dry air
Pressure / Elevation	Sea level ≤ 2500 m
Optimum Operational Reliability	
Temperature	+ 22°C (± 3°C) (+ 72°F (± 5°F)
Hygrometry	50% (± 5%)
Non-Operating Limits	
Dry bulb temperature range	+5°C to +50°C (+41°F to +122°F) Gradient 25°C/h (77°F/h)
Relative humidity (non-condensing)	5 to 95% (Gradient 30%)
Max. wet bulb temperature	+28°C (+82.4°F)
Moisture content	0.024 kg water/kg dry air
Shipping Limits	
Dry bulb temperature range	-35°C to +65°C (-31°F to +149°F) Gradient 25°C/h (77°F/h)
Relative humidity (non-condensing)	5 to 95% Gradient 30%/h
Acoustic Power at Room Temperature +20° C (+68° F)	
System Running	System Idle
Lw(A) 6.3 Bels	Lw(A) 6.1 Bels

Power Cables	
PDU-2-4-M-32A	
AC (32A) Cable type Connector type	1 per PDU 3 x AWG10 (3 x 6 mm ² / #10US) IEC60309-32A
It is mandatory for power lines and terminal boxes to be located within the immediate vicinity of the system and to be easily accessible. Each power line must be connected to a separate, independent electrical panel and bipolar circuit breaker. PDUs require an extra cable length of 1.5 meters for connection inside the cabinet.	
Electrical Specifications (power supplies are auto-sensing and auto-ranging)	
Current draw Power consumption Thermal dissipation	11 A max. at 200 VAC input 2400 VA per full CSS module 2400 W / 8190 BTU per full CSS module
Europe	
Nominal voltage Voltage range Frequency	230 VAC (Phase / Neutral) 207 - 244 VAC 50 Hz 1%
United States of America	
Nominal voltage Voltage range Frequency	208 VAC (Phase / Neutral) 182 - 229 VAC 60 Hz 0.3%
Japan	
Nominal voltage Voltage range Frequency	200 VAC (Phase / Neutral) 188 - 212 VAC 60 Hz 0.2%
Brazil	
Nominal voltage Voltage range Frequency	220 VAC (Phase / Neutral) 212 - 231 VAC 60 Hz 2%
Breaker Protection (Mains Power)	
PDU-2-4-M-32A Maximum inrush current	32A Curve C 210A / per quarter period

Table 65. NovaScale 5085 Server specifications

NovaScale 5165 Server Specifications

NovaScale 5165 Servers are delivered rack-mounted in 40U or 19U cabinets.

The following web site may be consulted for general site preparation information:

<http://www.cs.bull.net/aise>.

Cabinet Dimensions / Weight	
Unpacked	Packed
1300H	1300H
Height: 195.5 cm (77.0 in)	Height: 200.0 cm (78.7 in)
Width: 60.0 cm (23.6 in)	Width: 80.0 cm (31.5 in)
Depth: 129.5 cm (51.0 in)	Depth: 140.0 cm (55.1 in)
Weight (max.): 450 kg (959 lb)	Weight (max.): 480 kg (1022 lb)
1300L	1300L
Height: 103.5 cm (40.7 in)	Height: 108.0 cm (42.5 in)
Width: 60.0 cm (23.6 in)	Width: 80.0 cm (31.5 in)
Depth: 129.5 cm (51.0 in)	Depth: 140.0 cm (55.1 in)
Weight (max.): 400 kg (852 lb)	Weight (max.): 430 kg (915 lb)
Service Clearance	
Front	150 cm
Rear	100 cm
Side (free side)	100 cm
Operating Limits	
Dry bulb temperature range	+15°C to +30°C (+59°F to +86°F) Gradient 5°C/h (41°F/h)
Relative humidity (non-condensing)	35 to 60% (Gradient 5%/h)
Max. wet bulb temperature	+24°C (+75.2°F)
Moisture content	0.019 kg water/kg dry air
Pressure / Elevation	Sea level ≤ 2500 m
Optimum Operational Reliability	
Temperature	+ 22°C (± 3°C) (+ 72°F (± 5°F)
Hygrometry	50% (± 5%)
Non-Operating Limits	
Dry bulb temperature range	+5°C to +50°C (+41°F to +122°F) Gradient 25°C/h (77°F/h)
Relative humidity (non-condensing)	5 to 95% (Gradient 30%)
Max. wet bulb temperature	+28°C (+82.4°F)
Moisture content	0.024 kg water/kg dry air
Shipping Limits	
Dry bulb temperature range	-35°C to +65°C (-31°F to +149°F) Gradient 25°C/h (77°F/h)
Relative humidity (non-condensing)	5 to 95% Gradient 30%/h

Acoustic Power at Room Temperature +20° C (+68° F)	
System Running	System Idle
Lw(A) 6.3 Bels	Lw(A) 6.1 Bels
Power Cables	
PDU-2-4-M-32A	
AC (32A) Cable type Connector type	1 per PDU 3 x AWG10 (3 x 6 mm ² / #10US) IEC60309-32A
It is mandatory for power lines and terminal boxes to be located within the immediate vicinity of the system and to be easily accessible. Each power line must be connected to a separate, independent electrical panel and bipolar circuit breaker. PDUs require an extra cable length of 1.5 meters for connection inside the cabinet.	
Electrical Specifications (power supplies are auto-sensing and auto-ranging)	
Current draw Power consumption Thermal dissipation	11 A max. at 200 VAC input 2400 VA per full CSS module 2400 W / 8190 BTU per full CSS module
Europe	
Nominal voltage Voltage range Frequency	230 VAC (Phase / Neutral) 207 - 244 VAC 50 Hz 1%
United States of America	
Nominal voltage Voltage range Frequency	208 VAC (Phase / Neutral) 182 - 229 VAC 60 Hz 0.3%
Japan	
Nominal voltage Voltage range Frequency	200 VAC (Phase / Neutral) 188 - 212 VAC 60 Hz 0.2%
Brazil	
Nominal voltage Voltage range Frequency	220 VAC (Phase / Neutral) 212 - 231 VAC 60 Hz 2%
Breaker Protection (Mains Power)	
PDU-2-4-M-32A Maximum inrush current	32A Curve C 210A / per quarter period

Table 66. NovaScale 5165 Server specifications

NovaScale 5245 Server Specifications

NovaScale 5245 Servers are delivered rack-mounted in 40U cabinets.

The following web site may be consulted for general site preparation information:

<http://www.cs.bull.net/aise>.

Cabinet Dimensions / Weight	
Unpacked	Packed
1300H	1300H
Height: 195.5 cm (77.0 in)	Height: 200.0 cm (78.7 in)
Width: 60.0 cm (23.6 in)	Width: 80.0 cm (31.5 in)
Depth: 129.5 cm (51.0 in)	Depth: 140.0 cm (55.1 in)
Weight (max): 560 kg (1193 lb)	Weight (max): 590 kg (1257 lb)
Service Clearance	
Front	150 cm
Rear	100 cm
Side (free side)	100 cm
Operating Limits	
Dry bulb temperature range	+15°C to +30°C (+59°F to +86°F) Gradient 5°C/h (41°F/h)
Relative humidity (non-condensing)	35 to 60% (Gradient 5%/h)
Max. wet bulb temperature	+24°C (+75.2°F)
Moisture content	0.019 kg water/kg dry air
Pressure / Elevation	Sea level ≤ 2500 m
Optimum Operational Reliability	
Temperature	+ 22°C (± 3°C) (+ 72°F (± 5°F)
Hygrometry	50% (± 5%)
Non-Operating Limits	
Dry bulb temperature range	+5°C to +50°C (+41°F to +122°F) Gradient 25°C/h (77°F/h)
Relative humidity (non-condensing)	5 to 95% (Gradient 30%)
Max. wet bulb temperature	+28°C (+82.4°F)
Moisture content	0.024 kg water/kg dry air
Shipping Limits	
Dry bulb temperature range	-35°C to +65°C (-31°F to +149°F) Gradient 25°C/h (77°F/h)
Relative humidity (non-condensing)	5 to 95% Gradient 30%/h
Acoustic Power at Room Temperature +20° C (+68° F)	
System Running	System Idle
Lw(A) 6.3 Bels	Lw(A) 6.1 Bels

Power Cables	
PDU-2-4-M-32A	
AC (32A) Cable type Connector type	1 per PDU 3 x AWG10 (3 x 6 mm ² / #10US) IEC60309-32A
It is mandatory for power lines and terminal boxes to be located within the immediate vicinity of the system and to be easily accessible. Each power line must be connected to a separate, independent electrical panel and bipolar circuit breaker. PDUs require an extra cable length of 1.5 meters for connection inside the cabinet.	
Electrical Specifications (power supplies are auto-sensing and auto-ranging)	
Current draw Power consumption Thermal dissipation	11 A max. at 200 VAC input 2400 VA per full CSS module 2400 W / 8190 BTU per full CSS module
Europe	
Nominal voltage Voltage range Frequency	230 VAC (Phase / Neutral) 207 - 244 VAC 50 Hz 1%
United States of America	
Nominal voltage Voltage range Frequency	208 VAC (Phase / Neutral) 182 - 229 VAC 60 Hz 0.3%
Japan	
Nominal voltage Voltage range Frequency	200 VAC (Phase / Neutral) 188 - 212 VAC 60 Hz 0.2%
Brazil	
Nominal voltage Voltage range Frequency	220 VAC (Phase / Neutral) 212 - 231 VAC 60 Hz 2%
Breaker Protection (Mains Power)	
PDU-2-4-M-32A Maximum inrush current	32A Curve C 210A / per quarter period

Table 67. NovaScale 5245 Server specifications

NovaScale 5325 Server Specifications

NovaScale 5325 Servers are delivered rack-mounted in 40U cabinets.

The following web site may be consulted for general site preparation information:

<http://www.cs.bull.net/aise>.

Cabinet Dimensions / Weight	
Unpacked	Packed
1300H	1300H
Height: 195.5 cm (77.0 in)	Height: 200.0 cm (78.7 in)
Width: 60.0 cm (23.6 in)	Width: 80.0 cm (31.5 in)
Depth: 129.5 cm (51.0 in)	Depth: 140.0 cm (55.1 in)
Weight (max): 670 kg (1427 lb)	Weight (max): 700 kg (1491 lb)
Service Clearance	
Front	150 cm
Rear	100 cm
Side (free side)	100 cm
Operating Limits	
Dry bulb temperature range	+15°C to +30°C (+59°F to +86°F) Gradient 5°C/h (41°F/h)
Relative humidity (non-condensing)	35 to 60% (Gradient 5%/h)
Max. wet bulb temperature	+24°C (+75.2°F)
Moisture content	0.019 kg water/kg dry air
Pressure / Elevation	Sea level ≤ 2500 m
Optimum Operational Reliability	
Temperature	+ 22°C (± 3°C) (+ 72°F (± 5°F)
Hygrometry	50% (± 5%)
Non-Operating Limits	
Dry bulb temperature range	+5°C to +50°C (+41°F to +122°F) Gradient 25°C/h (77°F/h)
Relative humidity (non-condensing)	5 to 95% (Gradient 30%)
Max. wet bulb temperature	+28°C (+82.4°F)
Moisture content	0.024 kg water/kg dry air
Shipping Limits	
Dry bulb temperature range	-35°C to +65°C (-31°F to +149°F) Gradient 25°C/h (77°F/h)
Relative humidity (non-condensing)	5 to 95% Gradient 30%/h
Acoustic Power at Room Temperature +20° C (+68° F)	
System Running	System Idle
Lw(A) 6.3 Bels	Lw(A) 6.1 Bels

Power Cables	
PDU-2-4-M-32A	
AC (32A) Cable type Connector type	1 per PDU 3 x AWG10 (3 x 6 mm ² / #10US) IEC60309-32A
It is mandatory for power lines and terminal boxes to be located within the immediate vicinity of the system and to be easily accessible. Each power line must be connected to a separate, independent electrical panel and bipolar circuit breaker. PDUs require an extra cable length of 1.5 meters for connection inside the cabinet.	
Electrical Specifications (power supplies are auto-sensing and auto-ranging)	
Current draw Power consumption Thermal dissipation	11 A max. at 200 VAC input 2400 VA per full CSS module 2400 W / 8190 BTU per full CSS module
Europe	
Nominal voltage Voltage range Frequency	230 VAC (Phase / Neutral) 207 - 244 VAC 50 Hz 1%
United States of America	
Nominal voltage Voltage range Frequency	208 VAC (Phase / Neutral) 182 - 229 VAC 60 Hz 0.3%
Japan	
Nominal voltage Voltage range Frequency	200 VAC (Phase / Neutral) 188 - 212 VAC 60 Hz 0.2%
Brazil	
Nominal voltage Voltage range Frequency	220 VAC (Phase / Neutral) 212 - 231 VAC 60 Hz 2%
Breaker Protection (Mains Power)	
PDU-2-4-M-32A Maximum inrush current	32A Curve C 210A / per quarter period

Table 68. NovaScale 5325 Server specifications

Glossary

A

AC: Alternating Current generated by the power supply. See DC.

ACPI: Advanced Configuration and Power Interface. An industry specification for the efficient handling of power consumption in desktop and mobile computers. ACPI specifies how a computer's BIOS, operating system, and peripheral devices communicate with each other about power usage.

Address: A label, name or number that identifies a location in a computer memory.

AMI: American Megatrends Incorporated.

ANSI: American National Standards Institute.

API: Application Program Interface. The specific method prescribed by a computer operating system or by an application program by which a programmer writing an application program can make requests of the operating system or another application.

Archive: (Archive file). A file that is a copy of a history file. When a history file is archived, all messages are removed from the history file.

ASCII: American National Standard Code for Information Interchange. A standard number assigned to each of the alphanumeric characters and keyboard control code keys to enable the transfer of information between different types of computers and peripherals.

B

Backup: A copy of data for safe-keeping. The data is copied from computer memory or disk to a floppy disk, magnetic tape or other media.

Backup battery: The battery in a computer that maintains real-time clock and configuration data when power is removed.

Baud rate: The speed at which data is transmitted during serial communication.

BERR: Bus Error signal pin used to signal a global machine check abort condition.

BINIT: Bus Initialization signal pin used to signal a global fatal machine check condition.

BIOS: Basic Input / Output System. A program stored in flash EPROM or ROM that controls the system startup process.

BIST: Built-In Self-Test. See POST.

Bit: Derived from **BI**nary **di**gi**T**. A bit is the smallest unit of information a computer handles.

BTU: British Thermal Unit.

Byte: A group of eight binary digits (bit) long that represents a letter, number, or typographic symbol.

C

Cache Memory: A very fast, limited portion of RAM set aside for temporary storage of data for direct access by the microprocessor.

CD-ROM: Compact Disk Read-Only Memory. High-capacity read-only memory in the form of an optically readable compact disk.

Cell: The smallest set of hardware components allocated to a single OS. A cell is functionally defined by:

- the number of available processors
- memory capacity
- I/O channel capacity.

CellBlock: A group of interconnected cells within a single domain. See Central Subsystem.

Central Subsystem: A group of interconnected cells gathered within a single domain. See CellBlock.

Chained DIBs: Two DIBs can be inter-connected to house 4 SCSI RAID disks, 1 DVD-ROM drive, 1 USB port. See DIB and IPD.

Chip: Synonym for integrated circuit. See IC.

Clipping: A PAM Event filter criterion. Clipping is defined on a Count / Time basis aimed at routing a pre-defined number of messages only. Identical messages are counted and when the number of messages indicated in the **Count** field is reached within the period of time indicated in the **Time** field, no other messages will be selected for routing.

CMC: Corrected Memory Check condition is signaled when a hardware corrects a machine check error or when a MCA condition is corrected by firmware.

CMCI: Corrected Memory Check Interrupt.

CMCV: Corrected Memory Check Vector.

CMOS: Complementary Metal Oxide Semiconductor. A type of low-power integrated circuits. System startup parameters are stored in CMOS memory. They can be changed via the system setup utility.

COM: Component Object Model. Microsoft technology for component based application development under Windows.

COM +: Component Object Model +. Microsoft technology for component based application development under Windows. The external part of the PAM software package is a COM+ application.

COM1 or COM2: The name assigned to a serial port to set or change its address. See Serial Port.

Command: An instruction that directs the computer to perform a specific operation.

Configuration: The way in which a computer is set up to operate. Configurable options include CPU speed, serial port designation, memory allocation, ...

Configuration Tasks: A PAM feature used to configure and customize the server.

Control Pane: One of the three areas of the PAM web page. When an item is selected in the **PAM Tree** pane, details and related commands are displayed in the **Control** pane. See PAM Tree pane and Status pane.

Core Unit: A main CSS module unit interconnecting the MIO, MQB, MSX and MFL boards. See MIO, MQB, MSX, MFL.

COS: Cluster Operating System.

CPE: Corrected Platform Error.

CPEI: Corrected Platform Error Interrupt.

CPU: Central Processing Unit. See Microprocessor and Socket.

CSE: Customer Service Engineer.

CSS: Central Sub-System. See CellBlock.

CSS Module: A MidPlane with all its connected components (QBBs, IO boards, PMB) and utility devices. See Module.

D

D2D: DC to DC converter.

DC: Direct Current generated by the power supply. See AC.

Default Setting: The factory setting your server uses unless instructed otherwise.

Density: The capacity of information (bytes) that can be packed into a storage device.

Device Driver: A software program used by a computer to recognize and operate hardware.

DIB: Device Interface Board. The DIB provides the necessary electronics for the Internal Peripheral Drawer. See IPD and Chained DIBs.

DIG64: Developer Interface Guide for IA64.

DIM Code: Device Initialization Manager. Initializes different BUSES during the BIOS POST.

DIMM: Dual In-line Memory Module - the smallest system memory component.

Disk Drive: A device that stores data on a hard or floppy disk. A floppy disk drive requires a floppy disk to be inserted. A hard disk drive has a permanently encased hard disk.

DMA: Direct Memory Access. Allows data to be sent directly from a component (e.g. disk drive) to the memory on the motherboard). The microprocessor does not take part in data transfer enhanced system performance.

DMI: Desktop Management Interface. An industry framework for managing and keeping track of hardware and software components in a system of personal computers from a central location.

DNS: Domain Name Server. A server that retains the addresses and routing information for TCP/IP LAN users.

Domain: is the coherent set of resources allocated to run a customer activity, i.e. the association -at boot time- of a Partition, an OS instance (including applications) and associated LUNs and an execution context including execution modes and persistent information (e.g. time, date of the OS instance). Domain definitions and initializations are performed via PAM. A Domain can be modified to run the same OS instance on a different Partition. When a Domain is running, its resources are neither visible nor accessible to other running Domains.

Domain Identity: a PAM Domain management logical resource. This resource contains context information related to the Customer activity running in a domain. The most visible attribute of this resource is the name that the Customer gives to the activity. For each domain created, the Domain management feature allows the operator to define a new activity or choose an activity from the list of existing activities. See Domain.

Domain Manager: A PAM feature used to power on / off and manage server domains. See Domain.

DPS: Distributed Power Supply.

DRAM: Dynamic Random Access Memory is the most common type of random access memory (RAM).

E

ECC: Error Correcting Code.

EEPROM: Electrically Erasable Programmable Read-Only Memory. A type of memory device that stores password and configuration data. See also EPROM.

EFI: Extensible Firmware Interface.

EFIMTA: EFI Modular Test Architecture.

EFI Shell: The EFI (Extensible Firmware Interface) Shell is a simple, interactive user interface that allows EFI device drivers to be loaded, EFI applications to be launched, and operating systems to be booted. In addition, the EFI Shell provides a set of basic commands used to manage files and the system environment variables. See Shell.

EMI: Electro-Magnetic Interference.

EPROM: Erasable Programmable Read-Only Memory. A type of memory device that is used to store the system BIOS code. This code is not lost when the computer is powered off.

ERC: Error and Reset Controller. This controller allows PAM software to control error detection and reset propagation within each pre-defined CSS partition. The ERC is initialized by PAM software to ensure a partition-contained distribution of the reset, error, interrupt and event signals; and to contribute to error signaling and localization at platform level.

ERP: Error Recovery Procedure.

ESD: ElectroStatic Discharge. An undesirable discharge of static electricity that can damage equipment and degrade electrical circuitry.

Event: The generation of a message (event message) by a software component and that is directed to the Event Manager.

Event address: Defines the destination for a message sent over a specified event channel. An address is one of: the name of a history file (for the HISTORY channel), an e-mail address (for the EMAIL channel), the name of a user group (for the WEB channel), the SNMP Manager IP address (for the SNMP channel).

Event channel: Defines how the Event Manager sends an event message. An event channel is one of: HISTORY (the message is logged in a history file), EMAIL (the message is sent to an e-mail address), WEB (the message is stored for analysis from the PAM web user interface), SNMP (the message is sent as an SNMP trap to the selected SNMP application).

Event filter: A list of selected messages among all possible event messages. If an event message is not included in the filter, the Event Manager discards the message.

Event Manager: A PAM feature used to forward event messages over a configured event channel. See Event.

Event message: A message sent by a software component to the Event Manager for routing to a destination that is configured by an administrator.

Event subscription: An object that defines the event channel, address, and filter for sending an event message. If no such object is defined, the event message is discarded.

Exclusion: Logical removal of a redundant faulty hardware element until it has been repaired or replaced. The hardware element remains physically present in the configuration, but is no longer detected by PAM software and can no longer be used by a domain.

External Disk Subsystem: Disk subsystem housed inside the NovaScale cabinet.

F

Fail-over: Failover is a backup operational mode in which the functions of a system component (such as a processor, server, network, or database, for example) are assumed by secondary system components when the primary component becomes unavailable through either failure or scheduled down time.

FAME: Flexible Architecture for Multiple Environments.

FAST WIDE: A standard 16-bit SCSI interface providing synchronous data transfers of up to 10 MHz, with a transfer speed of 20M bytes per second.

FC: Fibre Channel.

FCAL: Fibre Channel Arbitrated Loop.

FCA: Fibre Channel Adapter.

FCBQ: Fan Control Board for QBB.

FCBS: Fan Control Board for SPS.

FDA: Fibre Disk Array.

FDD: Floppy Disk Drive.

Flash EPROM: Flash Erasable Programmable Read-Only Memory. A type of memory device that is used to store the the system firmware code. This code can be replaced by an updated code from a floppy disk, but is not lost when the computer is powered off.

Firewall: A set of related programs, located at a network gateway server, that protects the resources of a private network from users from other networks.

Firmware: an ordered set of instructions and data stored to be functionally independent of main storage.

Format: The process used to organize a hard or floppy disk into sectors so that it can accept data. Formatting destroys all previous data on the disk.

FPB: FAME Power Board (FAME: Flexible Architecture for Multiple Environments).

FPGA: Field Programmable Gate Array. A gate array that can be reprogrammed at run time.

FRB: Fault Resilient Boot. A server management feature. FRB attempts to boot a system using the alternate processor or DIMM.

FRU: Field Replaceable Unit. A component that is replaced or added by Customer Service Engineers as a single entity.

FSS: FAME Scalability Switch. Each CSS Module is equipped with 2 Scalability Port Switches providing high speed bi-directional links between server components. See SPS.

FTP: File Transfer Protocol. A standard Internet protocol: the simplest way of exchanging files between computers on the Internet. FTP is an application protocol that uses Internet TCP/IP protocols. FTP is commonly used to transfer Web page files from their creator to the computer that acts as their server for everyone on the Internet. It is also commonly used to download programs and other files from other servers.

FWH: FirmWare Hub.

G

GB: GigaByte: 1,073,741,824 bytes. See Byte.

Global MCA: Machine Check Abort is visible to all processors, in a multiprocessor system and will force all of them to enter machine check abort.

GUI: Graphical User Interface.

GTS: Global Telecontrol Server.

H

HA: High Availability. Refers to a system or component that is continuously operational for a desirably long length of time.

HAL: Hardware Abstraction Layer.

HA CMP: High Availability Clustered MultiProcessing.

Hard Disk Drive: HDD. See Disk Drive.

Hardware: The physical parts of a system, including the keyboard, monitor, disk drives, cables and circuit cards.

Hardware Monitor: A PAM feature used to supervise server operation.

HBA: Host Bus Adapter.

HDD: Hard Disk Drive. See Disk Drive.

History File: A file in which the History Manager logs informative messages or error messages relating to system activity. Messages are sent from source components to target components.

History Manager: The component running on the PAP Windows operating system that logs messages to history files.

HMMIO Space: High Memory IO Space.

HPB: Hot Plug Board. This board provides an interlock switch on each IO Box PCI slot for hot-swapping PCI boards. See P-HPB.

HPC: High Performance Computing.

Hot plugging: The operation of adding a component without interrupting system activity.

Hot swapping: The operation of removing and replacing a faulty component without interrupting system activity.

HTTP: HyperText Transfer Protocol. In the World Wide Web, a protocol that facilitates the transfer of hypertext-based files between local and remote systems.

HW Identifier: Number (0 - F) used to identify Cellblock components. This number is identical to PMB code-wheel position.

I

I2C: Intra Integrated Circuit. The I2C (Inter-IC) bus is a bi-directional two-wire serial bus that provides a communication link between integrated circuits (ICs). The I2C bus supports 7-bit and 10-bit address space devices and devices that operate under different voltages.

IA64: is a 64-bit Intel processor Architecture based on Explicitly Parallel Instruction Computing (EPIC). The Itanium processor is the first in the Intel line of IA-64 processors.

IB: Infini Band.

IC: Integrated Circuit. An electronic device that contains miniaturized circuitry. See Chip.

ICH2: I/O Controller Hub 2, component that contains the fundamental I/O interfaces required by the system. Flash memory, Keyboard, USB and IDE device interface.

ICH4: I/O Controller Hub 4.

ICMB: Intelligent Chassis Management Bus.

ID: A number which uniquely identifies a device on a bus.

IDE: Integrated Drive Electronics. A type of hard disk drive with the control circuitry located inside the disk drive rather than on a drive controller card.

Identity: See Domain Identity.

IIS: Internet Information Server. A group of Internet servers (including a Web or HTTP server and a FTP server) with additional capabilities for Microsoft® Windows® NT and Microsoft Windows (and later) operating systems.

I/O: Input / Output. Describes any operation, program, or device that transfers data to or from a computer.

Interface: A connection between a computer and a peripheral device enabling the exchange of data. See Parallel Port and Serial Port.

Internal Disk Subsystem: Disk subsystem housed inside the NovaScale Internal Peripheral Drawer (IPD).

IOB: Input / Output Board. The IOB connects up to 11 PCI-X boards.

IOC: Input / Output Board Compact. The IOC connects up to 6 PCI-X boards.

IOL: I/O Board Legacy. The IOL provides:

- I/O controller Hub
- USB ports
- 10/100/1000 Ethernet controller
- Video controller
- Serial / debug port

IOR: I/O Board Riser. The IOR provides:

- I/O controller Hub
- USB ports
- 10/100/1000 Ethernet controller
- Video controller
- Serial / debug port

IP: Internet Protocol. The protocol by which data is sent from one computer to another via the Internet. Each computer (known as a host) on the Internet has at least one IP address that uniquely identifies it from all other computers on the Internet.

IPD: Internal Peripheral Drawer. The IPD houses legacy peripherals (DVD-Rom drive, USB port) and SCSI system disks. See DIB and Chained DIBs.

IPF: Itanium Processor Family.

IPL: Initial Program Load. It defines the firmware functional phases during the system initialization.

IPMB: Intelligent Platform Management Bus.

IPMI: Intelligent Platform Management Interface.

ISA: Industry Standard Architecture. An industry standard for computers and circuit cards that transfer 16 bits of data at a time.

J

Jumper: A small electrical connector used for configuration on computer hardware.

K

KVM: Keyboard Video Monitor.

KVM switch: the Keyboard Video Monitor switch allows the use of a single keyboard, monitor and mouse for more than one module.

L

LAN: Local Area Network. A group of computers linked together within a limited area to exchange data.

LD: Logical Disk. A Storeway FDA 1x00/2x00 logical disk (or LUN) is visible to the OS as a Disk. See LUN and PD (Physical Disk).

LED: Light Emitting Diode. A small electronic device that glows when current flows through it.

Legacy Application: An application in which a company or organization has already invested considerable time and money. Typically, legacy applications are database management systems (DBMSs) running on mainframes or minicomputers.

Licensing Number: When you install an application protected by a system serial number, you are requested to supply this serial number. For optimum flexibility, PAM software allows you to replace the physical serial number by a logical licensing number so that you can run the application on any physical partition and, in the case of extended systems, on any of the Central Subsystems within the extended configuration.

LID: Local Interrupt Identifier (CPU).

Local Disk Subsystem: Disk subsystem housed inside the NovaScale cabinet and not connected to a SAN.

Local MCA: Machine Check Abort is detected and handled by a single processor and is invisible to the other processor.

Locking: Means of functionally limiting access to certain hardware elements. Locked hardware elements can no longer be accessed by the current domain, but are still physically available for use by other domains. Previously locked elements can be unlocked so that they can be accessed by the domain.

LPT1 or LPT2: The name assigned to a parallel port to specify its address. See Parallel Port.

LS240: Laser Servo super diskette holding up to 240 Mb.

LUN: Logical Unit Number. Term used to designate Logical Storage Units (logical disks) defined through the configuration of physical disks stored in a mass storage cabinet.

LVDS: Low Voltage Differential SCSI.

M

MAESTRO: Machine Administration Embedded Software Real Time Oriented. Part of the PAM software package embedded on the PMB board.

MCA: Machine Check Abort.

See also Local MCA and Global MCA.

Memory: Computer circuitry that stores data and programs. See RAM and ROM.

Memory bank: The minimum quantity of memory used by the system. It physically consists of four memory DIMMs.

MFL: Midplane Fan & Logistics board. The MFL houses the Fan Boxes and is connected to the MIO and MQB. See MIO, MQB.

Microprocessor: An integrated circuit that processes data and controls basic computer functions.

Midplane: Mid-Plane. All system hardware components are connected to the Midplane.

MIMD: Multiple Instruction Multiple Data

MIO: Midplane Input / Output board. The MIO connects one or two IOC boards and the PMB. See Core Unit.

Mirrored volumes: A mirrored volume is a fault-tolerant volume that duplicates your data on two physical disks. If one of the physical disks fails, the data on the failed disk becomes unavailable, but the system continues to operate using the unaffected disk.

Module: a Midplane Board with all its connected components and utility devices. See CSS Module and MP.

MQB: Midplane QBB board. The MQB connects one or two QBBs and one or two IPDs. See QBB and IPD.

MSX: Midplane SPS & XPS board. The MSX houses a B-SPS switch and is connected to the MIO and the MQB. There are two MSX boards in a CSS module. All SP connections between a QBB and an IOC use an MSX. See B-SPS, MIO, MQB.

MTBF: Mean Time Between Failure. An indicator of expected system reliability calculated on a statistical basis from the known failure rates of various components of the system. Note: MTBF is usually expressed in hours.

Multicore: Presence of two or more processors on a single chip.

Multimedia: Information presented through more than one type of media. On computer systems, this media includes sound, graphics, animation and text.

Multitasking: The ability to perform several tasks simultaneously. Multitasking allows you to run multiple applications at the same time and exchange information among them. See Task.

Multithreading: The ability of a processor core to execute more than one independent instruction thread simultaneously. As the core comprises two complete context registers, it is able to switch rapidly from one instruction thread to another.

N

NFS: Network File System. A proprietary distributed file system that is widely used by TCP/IP vendors. Note: NFS allows different computer systems to share files, and uses user datagram protocol (UDP) for data transfer.

NMI: Non-Maskable Interrupt.

NUMA: Non Uniform Memory Access. A method of configuring a cluster of microprocessors in a multiprocessing system so that they can share memory locally, improving performance and the ability of the system to be expanded.

nsh: nsh stands for **new shell**. See Shell and EFI Shell.

NVRAM: Non Volatile Random Access Memory. A type of RAM that retains its contents even when the computer is powered off. See RAM and SRAM.

O

OF: Open Firmware. Firmware controlling a computer prior to the Operating System.

Operating System: See OS.

OS: Operating System. The software which manages computer resources and provides the operating environment for application programs.

P

PAL: Processor Abstraction Layer: processor firmware that abstracts processor implementation differences. See also SAL.

PAM: Platform Administration & Maintenance.

PAM software: Platform Administration & Maintenance software. One part (PAP application and the PamSite WEB site) runs on the PAP unit. The other part (MAESTRO) is embedded on the PMB board.

PAM Tree pane: One of the three areas of the PAM web page. Server hardware presence and functional status are displayed in the PAM Tree pane. See Status pane and Control pane.

PAP unit: Platform Administration Processor unit. The PC hosting all server administration software.

PAP application: Platform Administration Processor application. Part of PAM software, PAP application is a Windows COM+ application running on PAP unit.

Parallel Port: Connector allowing the transfer of data between the computer and a parallel device.

PARM request: the PARM application is designed to handle Requests issued by the CSE (Customer Service Engineer)

Partition: Division of storage space on a hard disk into separate areas so that the operating system treats them as separate disk drives.

Password: A security feature that prevents an unauthorized user from operating the system.

PCI: Peripheral Component Interconnect. Bus architecture supporting high-performance peripherals.

PD: Physical Disk. A Storeway FDA 1300/2300 physical disk is not visible to the OS. See LD.

PDU: Power Distribution Unit. Power bus used for the connection of peripheral system components.

Permanence: Property of a history file that determines whether or not the history file can be modified or deleted from the PAM user interface. Permanence is either *Static* (cannot be modified) or *Dynamic* (can be modified).

P-HPB: PCI Hot Plug Board. This board provides an interlock switch on each IO Box PCI slot for hot-swapping PCI boards. See HPB.

PIC: Platform Instrumentation Control.

ping: A basic Internet program that lets you verify that a particular IP address exists and can accept requests. The verb "to ping" means the act of using the ping utility or command.

PIROM: Processor Information ROM. Processor Information ROM (PIROM) contains information about the specific processor in which it resides. This information includes robust addressing headers to allow for flexible programming and forward compatibility, core and L2 cache electrical specifications, processor part and S-spec numbers, and a 64-bit processor number.

PMB: Platform Management Board. Links the server to the PAP unit.

PNP: Plug aNd Play. The ability to plug a device into a computer and have the computer recognize that the device is there.

POST: Power On Self Test. When power is turned on, POST (Power-On Self-Test) is the diagnostic testing sequence (or "starting program") that a computer runs to determine if hardware is working correctly.

PROM: Programmable Read-Only Memory.

PUID: PAM Universal/Unique IDentifier. PAM software allocates a PUID (PAM Universal / Unique Identifier) to each hardware / software object to guarantee unambiguous identification.

The PUID for each hardware element can be obtained by hovering the mouse over the corresponding element in the PAM tree, e.g.:

PAM:/CELLSBLOCK_<NAME>/MODULE_x/QBB_y/C PU_y.

Q

QBB: Quad Brick Board. The QBB is the heart of the Bull NovaScale Server, housing 4 Itanium 2 processors and 16 DIMMs. Each QBB communicates with other CSS Module components via 2 high-speed bidirectional Scalability Port Switches. See SPS or FSS.

R

RAID: Redundant Array of Independent Disks. A method of combining hard disk drives into one logical storage unit for disk-fault tolerance.

RAM: Random Access Memory. A temporary storage area for data and programs. This type of memory must be periodically refreshed to maintain valid data and is lost when the computer is powered off. See NVRAM and SRAM.

RAS: Reliability, Availability, Serviceability.

Real-time clock: The Integrated Circuit in a computer that maintains the time and date.

RFI: Radio Frequency Interference.

Ring: The CSS module interconnection ring comprises the cables used to interconnect two, three or four CSS modules.

RJ45: 8-contact regular jack.

RMC: Remote Maintenance Console.

ROM: Read-Only Memory. A type of memory device that is used to store the system BIOS code. This code cannot be altered and is not lost when the computer is powered off. See BIOS, EPROM and Flash EPROM.

RS-232 Port: An industry standard serial port. See Serial Port.

RSF: Remote Service Facilities.

RTC: Real Time Clock.

S

S@N.IT: SAN Administration Tool.

SAL: System Abstraction Layer. Firmware that abstract system implementation differences in IA-64 platform. See also PAL.

SAN: Storage Area Network. A high-speed special-purpose network that interconnects different kinds of data storage devices with associated data servers on behalf of a larger network of users.

SAPIC: Streamlined Advanced Programmable Interrupt Controller message.

SBE: Single Bit Error.

Scheme: Configuration file ensuring optimum use and compatibility of the physical and logical resources used to simultaneously run multiple domains.

SCI: Scalable Coherent Interface.

SCSI: Small Computer System Interface. An input and output bus that provides a standard interface used to connect peripherals such as disks or tape drives in a daisy chain.

SDR: Sensor Data Record.

SDRAM: Synchronous Dynamic Random Access Memory. A type of DRAM that runs at faster clock speeds than conventional memory. See DRAM.

SEL: System Event Log. A record of system management events. The information stored includes the name of the event, the date and time the event occurred and event data. Event data may include POST error codes that reflect hardware errors or software conflicts within the system.

Serial Communication: Data sent sequentially, one bit at a time.

Serial Port: Connector that allows the transfer of data between the computer and a serial device. See COM1 or COM 2. Shell is a Unix term for the interactive user interface with an operating system.

SIO: Server I/O / Super I/O.

Shell: The Shell is the layer of programming that understands and executes the commands a user enters. As the outer layer of an operating system, the Shell can be contrasted with the kernel, the inmost layer or core of services of an operating system. See EFI Shell.

SIOH: Server I/O Hub. This component provides a connection point between various I/O bridge components and the Intel 870 chipset.

Sideband: This part of the CSS module inter-connection ring comprises logistic cables (errors, commands, resets). See Ring.

SMBIOS: System Management BIOS.

SM-BUS: System Management Bus.

SMIC: Server Management Interface Chip.

SMP: Symmetrical Multi Processor. The processing of programs by multiple processors that share a common operating system and memory.

SNC: Scalable Node Controller. The processor system bus interface and memory controller for the Intel 870 chipset. The SNC supports both the Itanium 2 processors, DDR SDRAM main memory, a Firmware Hub Interface to support multiple Firmware hubs, and two scalability ports for access to I/O and coherent memory on other nodes, through the FSS.

SNM: System Network Module.

SNMP: Simple Network Management Protocol. The protocol governing network management and the monitoring of network devices and their functions.

Socket: Central Processing Unit multicore interface. Each socket can house 1 or 2 processor cores. See Microprocessor and CPU.

Source: Each message refers to a source (the resource that generated the message) and a target (the component referred to in the message). This feature can be allows messages to be filtered according to one or more **Source** string(s) and is particularly useful for debugging and troubleshooting. See Target.

SPD: Serial Presence Detect. DIMM PROM.

SPS: Scalability Port Switch. Each CSS Module is equipped with 2 Scalability Port Switches providing high speed bi-directional links between system components. See FSS.

SRAM: Static RAM. A temporary storage area for data and programs. This type of memory does not need to be refreshed, but is lost when the system is powered off. See NVRAM and RAM.

SSI: Server System Infrastructure.

Status Pane: One of the three areas of the PAM web page. Provides quick access to CSS Module availability status, server functional status, and pending event message information. See also Control pane and PAM Tree pane.

SVGA: Super Video Graphics Array.

T

Target: Each message refers to a target (the component referred to in the message), identified by its PUID, and a source (the component that generated the message). This feature allows messages to be filtered according to one or more **Target** string(s) and is particularly useful for debugging and troubleshooting. See Source and PUID.

Task: Each message refers to a target (the component referred to in the message), identified by its PUID, and a source (the component that generated the message). This feature allows messages to be filtered according to one or more **Target** string(s) and is particularly useful for debugging and troubleshooting. See Source and PUID.

TCP: Transmission Control Protocol. A set of rules (protocol) used along with the Internet Protocol (IP) to send data in the form of message units between computers over the Internet.

TCP/IP: Transmission Control Protocol / Internet Protocol. The basic communication language or protocol of the Internet.

T&D: Tests and Diagnostics.

Thresholding: A PAM Event filter criterion. Thresholding is defined on a Count / Time basis aimed at routing significant messages only. Identical messages are counted and when the number of messages indicated in the **Count** field is reached within the period of time indicated in the **Time** field, this message is selected for routing.

U

UART: a **U**niversal **A**synchronous **R**eceiver **T**ransmitter. The microchip with programming that controls a computer interface to its attached serial devices.

ULTRA SCSI: An enhanced standard 16-bit SCSI interface providing synchronous data transfers of up to 20 MHz, with a transfer speed of 40M bytes per second. It is also called Fast-20 SCSI.

UML: **U**nified **M**odeling **L**anguage. A standard notation for the modeling of real-world objects as a first step in developing an object-oriented design methodology.

UPS: **U**ninterruptible **P**ower **S**upply. A device that allows uninterrupted operation if the primary power source is lost. It also provides protection from power surges.

URL: **U**niform / **U**niversal **R**esource **L**ocator. The address of a file (resource) accessible on the Internet.

USB: **U**niversal **S**erial **B**us. A plug-and-play interface between a computer and add-on devices. The USB interface allows a new device to be added to your computer without having to add an adapter card or even having to turn the computer off.

V

VCC: **V**oltage **C**ontinuous **C**urrent.

VGA: **V**ideo **G**raphics **A**rray.

VI: **V**irtual **I**nterface.

Visibility: A property of a history file. Visibility is either *System* (the history file is predefined by the PAM software and is visible only to an administrator) or *User* (the history file is created by an administrator and is visible to both an administrator and an operator).

VLAN: **V**irtual **L**ocal **A**rea **N**etwork. A local area network with a definition that maps workstations on some other basis than geographic location (for example, by department, type of user, or primary application).

VxWORKS: Platform Management Board Operating System.

W

WAN: **W**ide **A**rea **N**etwork. Geographically dispersed telecommunications network. The term distinguishes a broader telecommunication structure from a local area network (LAN).

WBEM: **W**eb **B**ased **E**nterprise **M**anagement.

WMI: **W**indows **M**anagement **I**nterface.

WOL: A feature that provides the ability to remotely power on a system through a network connection.

X

XML: **e**Xtended **M**arkUp **L**anguage. A flexible way to create common information formats and share both the format and the data on the World Wide Web, intranets, and elsewhere.

XSP: **e**Xtended **S**calable **P**ort.

Y

No entries.

Z

No entries.

Index

A

- Access, front door, 1-20
- Action Request Package
 - default, creating, 4-51
 - filtering, 4-52
 - troubleshooting tools, creating, 4-51

Archive

- history, 4-38
- viewing, online, 4-38

Autocall settings, checking, 4-48

Autocalls

- configuring, 5-20
- FTP parameters, 5-20

Automatic restart, 5-52

B

Back Up, PAM software, 5-26

BIOS, POST codes, 3-43

BIOS info, domain, 3-33

Boot, options, 5-7

Boot manager, EFI, 5-7

C

CD-ROM drive, 1-14

Channels, enabling / disabling, 5-140

Checking

- environmental conditions, 4-46
- events, 4-47
- fault status, 4-47
- hardware availability, 4-46
- hardware connections, 4-47
- histories, 4-47
- PMB, 4-49
- power status, 4-47
- SNMP settings, 4-48
- temperature status, 4-47

Checking

- Autocall settings, 4-48
- MAESTRO version, 4-48
- PAM version, 4-48
- writing rules, 4-48

Checks, server status, 2-6

Clipping, 5-148

Components, 5085, 1-7

Configuration

- requirements, assessing, 5-31
- saving the current snapshot, 3-11

Configuring, event messaging, 5-133

Connecting to, server domain

- Enterprise LAN, 2-19
- Web, 2-20

Connection, hardware, 3-43

Console, 1-15

- opening / closing, 1-21
- tooggling, 2-9

Creating, Action Request Package, 4-51

CSS , functional status / domain state, 4-43

CSS hardware, functional status, 4-4

CSS Module, PMB, 4-50

CSS module, 1-13

- availability status, 2-7, 4-4

power, 4-19

thermal zone, 4-17

Custom Package, creating, 4-53

Customer information, modifying, 5-19

Customizing, PAM settings, 5-22

D

Data disks (SCSI), configuring, 5-5

Default schemes, updating, 5-49

Delivery, system, 1-2

Details pane, PAM, 2-6

DIB, chained, 1-13

DIMMs, 1-13

Disks, 1-14

- configuring SCSI data disks, 5-5

Documentation

- highlighting, xv
- preface, iii
- related publications, xv

Domain

- BIOS info, 3-33
- deleting, 3-26
- dump, 3-24, 3-43
- force power OFF, 3-43
- force power off, 3-21
- functional status, 3-29
- hardware resources, 3-35
- incidents, 3-42
- power down, 2-10, 2-11
- power logs, 3-31
- power OFF, 3-43
- power off, 3-18
- power on, 3-14
- power ON , 3-43
- power up, 2-10, 2-11
- powering sequences, 3-32
- request logs, 3-34
- reset, 3-25, 3-43

Domain configuration

- adding domains, 3-10
- replacing, 3-10

Domain identity. See identity

Domain manager, 3-2

Domain scheme. See scheme

Domains

- configuring, 5-28
- incidents, 3-43
- managing, 3-1
- powering ON / OFF, 4-48

Dump, domain, 3-24

DVD/CD-ROM drive, 1-13

E

E-mail

- creating an e-mail account, 5-138
- creating an e-mail server, 5-136
- deleting an e-mail account, 5-139
- deleting an e-mail server, 5-137
- editing e-mail account attributes, 5-139
- editing e-mail server attributes, 5-137

EFI

- boot manager, 5-7

- boot manager options, 5-7
- file transfer protocol, 5-15
- manual network configuration, 5-14
- network setup and configuration, 5-14
- shell, 5-9
- EFI boot, options, 5-7
- EFI shell
 - command syntax, 5-9
 - commands, 5-11
 - script, 5-11
 - starting, 5-9
- EFI utilities, using, 5-6
- Electrical safety, xviii
- Enterprise LAN, server domain
 - Linux, connecting, 2-19
 - Windows, connecting, 2-19
- Environmental conditions, checking, 4-46
- Ethernet hub, 1-19
- Ethernet ports, 1-13, 1-14
- Event filter
 - advanced filtering criteria, 5-148
 - creating a new filter, 5-154
 - deleting, 5-155
 - editing filter attributes, 5-155
 - preselecting, 5-153
 - standard filtering criteria, 5-145
- Event message, status, 4-4
- Event messages
 - acknowledging, 4-34
 - consulting, 4-33
 - customizing, 5-133
 - e-mail, viewing, 4-35
 - enabling / disabling channels, 5-140
 - managing, 4-31
 - severity, 5-148
 - severity levels, 4-32
 - sorting / locating, 4-35
 - source, 5-148
 - subscription, 5-133
 - target, 5-148
 - viewing, 4-31
- Event subscription
 - See Subscriptions, 5-141
 - flowchart, 5-135
- Event subscriptions, creating, 5-132
- Events, checking, 4-47
- Example scheme
 - mono-domain
 - all resources, 5-69
 - part of resources, 5-83
 - multi-domain
 - all resources, 5-96
 - part of resources, 5-111
- Exclude / include, monitoring, 4-15
- Excluding
 - clocks, 4-27
 - hardware, 4-23
 - hardware element, 4-47
 - sidebands, 4-27
 - XPS cables, 4-27
- Excluding
 - hardware, 4-23
 - SPS, 4-27
- Exclusion, hardware, 3-43
- Extended system, configuring, managing, 5-125

F

- Fail-over, policy, 1-22
- Fault list
 - consulting, 4-33
 - monitoring, 4-15
 - viewing, 4-35
- Fault status, checking, 4-47
- FDA 1300 disk rack, 1-17
- FDA 2300 FC disk rack, 1-17
- FDD, 1-14
- Firmware information, 4-17
- Force power off, domain, 3-21
- Front door, opening, 1-20
- FRU information, 4-16
- Functional status, CSS hardware, 4-4
- functional status, domain, 3-29

G

- Getting to know, server, 1-7

H

- Hardware
 - connections, 3-43
 - excluding, 4-23, 4-47
 - exclusion, 3-43
 - including, 4-23, 4-24
- Hardware availability, checking, 4-46
- Hardware components, locking / unlocking, 5-66
- Hardware connections, checking, 4-47
- Hardware monitor, CSS module power, 4-19
- Hardware resources
 - checklist, 5-126
 - domain, 3-35
- HBA, WWN, 5-64
- Highlighting, documentation, xv
- Histories
 - checking, 4-47
 - creating a user history, 5-158
 - deleting, 5-160
 - editing parameters, 5-159
- History
 - archiving, 4-38
 - viewing, online, 4-36
- History / archive, viewing, offline, 4-40
- History file, deleting, manually, 4-40
- History files
 - archiving, 4-36
 - deleting, 4-36
 - managing, 4-31
 - viewing, 4-31
- HMMIO, 5-52

I

- Identity
 - checklist, 5-126
 - copying, 5-54
 - creating, 5-50
 - deleting, 5-54
 - editing, 5-54
 - managing, 5-50
- Illegal characters, xx
- Incident
 - investigating, 4-42

- what to do, 4-42, 4-46
- Incidents
 - dealing with, 3-43
 - domain, 3-42
- Include / exclude, monitoring, 4-15
- Including
 - clocks, 4-27
 - hardware, 4-23, 4-24
 - sidebands, 4-27
 - SPS, 4-27
 - XSP cables, 4-27
- Indicators
 - fault status, 4-15, 4-16
 - failure status, 4-15, 4-16
 - functional status, 4-8, 4-15
 - power status, 4-18
 - presence status, 4-6, 4-15
 - temperature status, 4-20
- IO memory space, 5-52
- IOB, 1-13
- IOC
 - jumper status, 4-21
 - PCI slot status, 4-22
- IOL, 1-13
- iSM, 5-5
- K**
- Keyboard, 1-15
- Keys, registry, xxi
- KVM switch, 1-16
- L**
- Laser safety, xix
- LEDs, PMB, 4-50
- Licensing number, 5-52
- Linux, system users, 5-4
- Linux domain, remote access, Web, 2-18
- Linux Redhat, remote access, enterprise LAN, 2-16
- Linux SuSE domain, remote access, enterprise LAN, 2-17
- Locking, hardware components, 5-66
- Locking / Unlocking, hardware elements, 5-67
- Locking hardware, scheme, 5-33
- LUN, creating, 5-5
- LUN list, updating, 5-56
- LUN properties, modifying, 4-49
- LUNs, 5-55, 5-57
 - creating, 5-60
 - deleting, 5-61
 - editing, 5-62
 - local, 5-60
 - renaming, 5-63
 - scheme, 5-33
 - updating lists, 5-59
- M**
- Machine check halt, 5-52
- MAESTRO version, checking, 4-48
- Managing
 - domain configuration schemes, 5-33
 - domain schemes, 5-50
 - domains, 3-2
- Memory boards, 1-13
- MFL, firmware information, 4-17
- Microsoft Windows, system users, 5-4
- Mirroring, PAP unit, 1-22
- Modem, 1-19
- Modifying, customer information, 5-19
- Modifying, LUN properties, 4-49
- Monitor, 1-15
- Monitoring
 - failure status, 4-15, 4-16
 - fan status, 4-21
 - fault list, 4-15
 - fault status, 4-15, 4-16
 - firmware information, 4-17
 - FRU information, 4-16
 - functional status, 4-15
 - Hardware Search engine, 4-10
 - hardware status, 4-15
 - include / exclude, 4-15
 - jumper status, 4-21
 - PAM Tree, 4-5
 - PCI slot status, 4-22
 - power status, 4-18
 - presence status, 4-15
 - server, 4-1, 4-2
 - Status pane, 4-3
 - temperature status, 4-20
 - thermal zones, 4-17
- Monothreading mode, 5-52
- Mother boards, 1-13
- Mouse, 1-15
- Multiithreading mode, 5-52
- N**
- Notices
 - electrical safety, xviii
 - laser safety, xix
 - safety, xviii
- NPort Server, 1-19
- NVRAM, 5-55, 5-57
- NVRAM variables
 - clearing, 5-56
 - loading, 5-56
 - managing, 5-56
 - saving, 5-56
- P**
- PAM
 - connection, 2-2
 - customizing, 5-133
 - details pane, 2-6
 - event messaging, 5-133
 - simultaneous connection, 2-4
 - software package, 1-22
 - status pane, 2-6, 4-3
 - toolbar, 2-8
 - tree pane, 4-5
 - user information, 4-12
 - user interface, 2-5
 - writing rules, xx
- PAM settings, customizing, 5-22
- PAM software
 - activating a version, 5-24
 - back up / restore, 5-26
 - deploying a release, 5-23
 - monitoring, 4-2
- PAM tree pane, 2-7
- PAM version, checking, 4-48
- PAM version information, viewing, 4-13
- PAP application, rebooting, 3-43, 4-48
- PAP unit, 1-14
 - CD-ROM drive, 1-14

- disks, 1-14
 - Ethernet ports, 1-14
 - FDD, 1-14
 - mirroring, 1-22
 - serial ports, 1-14
 - PAP users, setting up, 5-17
 - Partitioning, 5-29
 - Peripheral drawer, 1-13
 - PHPB, 1-13
 - PMB, 1-13
 - checking, 4-49
 - code wheels, 4-50
 - firmware information, 4-17
 - rebooting, 3-43
 - resetting, 4-49
 - testing, 4-49
 - Power, CSS module, 4-19
 - Power cables, 1-14, 1-15, 1-16, 1-17, 1-18
 - Power down, server domain, 2-10, 2-11
 - Power logs, domain, 3-31
 - Power off, domain, 3-18
 - Power on, domain, 3-14
 - Power sequences, domain, 3-32
 - Power status, checking, 4-47
 - Power-up
 - server domain, 2-10, 2-11
 - system domains, 2-12, 2-15
 - Powering ON / OFF, domains, 4-48
 - Preface, documentation, iii
 - Processors, 1-13
- Q**
- QBBs, 1-13
- R**
- Rebooting, PAP application, 4-48
 - Related publications, documentation, xv
 - Remote access
 - Enterprise LAN, 2-16
 - Linux Redhat Domain, 2-16
 - Linux SuSE domain, 2-17
 - Windows domain, 2-16
 - Web, 2-18
 - Linux domain, 2-18
 - Windows domain, 2-18
 - Request logs, domain, 3-34
 - Reset, domain, 3-25
 - Resetting, PMB, 4-49
 - Resources, server, 1-22
 - Restoring, PAM software, 5-26
- S**
- Safety, notices, xviii
 - SAN, 5-57
 - scheme, 5-33
 - SAN LUN lists, updating, 5-59
 - Scheme
 - assess requirements, 5-33
 - checklist, 5-126
 - copying, 5-49
 - creating, 5-33
 - deleting, 5-49
 - editing, 5-48
 - identity, 5-33
 - loading, 3-8
 - locking hardware, 5-33
 - LUNs, 5-33
 - managing, 3-5, 5-33
 - Pre-requisites, 5-33
 - renaming, 5-49
 - SAN, 5-33
 - steps, 5-33
 - viewing, 3-6
 - WWN, 5-33
 - Search, hardware, 4-10
 - Serial ports, 1-13, 1-14
 - Server
 - See also system
 - domain, 2-10, 2-11
 - getting to know, 1-7
 - monitoring, 4-1, 4-2
 - partitioning, 5-29
 - resources, 1-22
 - Server components
 - accessing, 1-20
 - CD-ROM drive, 1-14
 - console, 1-15
 - core unit, 1-13
 - CSS module, 1-13
 - DIMMs, 1-13
 - Ethernet hub, 1-19
 - Ethernet ports, 1-13, 1-14
 - FDA 1300 FC, 1-17
 - FDA 2300 FC, 1-17
 - FDD, 1-14
 - internal peripheral drawer, 1-13
 - IOB, 1-13
 - IOL, 1-13
 - keyboard, 1-15
 - KVM switch, 1-16
 - memory boards, 1-13
 - modem, 1-19
 - monitor, 1-15
 - mother boards, 1-13
 - mouse, 1-15
 - NPort Server, 1-19
 - PAP unit, 1-14
 - PAP unit disks, 1-14
 - PHPB, 1-13
 - PMB, 1-13
 - power cables, 1-14, 1-15, 1-16, 1-17, 1-18
 - processors, 1-13
 - QBBs, 1-13
 - serial ports, 1-13, 1-14
 - USB ports, 1-13
 - VGA port, 1-13
 - Server status, checking, 2-6
 - Setting up
 - PAP users, 5-17
 - system users, 5-4
 - Severity, event message, 4-32
 - Snapshot, saving the current configuration, 3-11
 - SNMP settings, checking, 4-48
 - Specifications
 - NovaScale 5085 Servers, A-2
 - NovaScale 5165 Server, A-4
 - NovaScale 5245 Server, A-6
 - NovaScale 5325 Server, A-8
 - system, A-1
 - Status
 - CSS module, 2-7, 4-4
 - event message, 4-4
 - exclude / include, 4-15
 - failure indicators, 4-15, 4-16

- fans, 4-21
- fault indicators, 4-15, 4-16
- functional, 4-7, 4-8
- functional indicators, 4-15
- hardware information, 4-15
- IOC jumper, 4-21
- PCI slots, 4-22
- power, 4-18
- presence, 4-5, 4-6
- presence indicators, 4-15
- temperature indicators, 4-20
- Status pane, PAM, 2-6
- String lengths, *xxi*
- Subscriptions
 - advanced filtering criteria, 5-148
 - channels, 5-140
 - creating, 5-141
 - deleting, 5-142
 - e-mail account, 5-138
 - e-mail server, 5-136
 - editing attributes, 5-142
 - filter, 5-154
 - filtering, 5-153
 - history, 5-158
 - prerequisites, 5-134
 - setting up, 5-134
 - standard filtering criteria, 5-145
 - understanding filters, 5-143
- System
 - See also* server
 - dimensions, A-1
 - domains, 2-12, 2-15
 - weight, A-1
- System components, DVD/CD-ROM drive, 1-13
- System users
 - Linux, 5-4
 - Microsoft Windows, 5-4
 - setting up, 5-4

T

- Temperature status, checking, 4-47
- Testing, PMB, 4-49
- Thermal zone, 4-17
- Thresholding, 5-148
- Toolbar, PAM, 2-8
- Troubleshooting tools, Action Request Package, creating, 4-51

U

- Unlocking, hardware components, 5-66
- USB ports, 1-13
- User group, PAP, 5-17
- User histories, creating, 5-132
- User interface, PAM, 2-5

V

- VGA port, 1-13

W

- Web, server domain
 - Linux, connecting, 2-20
 - Windows, connecting, 2-20
- Windows domain, remote access
 - enterprise LAN, 2-16
 - Web, 2-18
- Writing rules
 - checking, 4-48
 - illegal characters, *xx*
 - string lengths, *xxi*
- WWN
 - checking, 5-64
 - HBA, 5-64
 - SAN, 5-33
 - updating, 5-64

Technical publication remarks form

Title : NOVASCALE NovaScale 5xx5 User's Guide
--

Reference: 86 A1 41EM 05

Date: February 2007

ERRORS IN PUBLICATION

--

SUGGESTIONS FOR IMPROVEMENT TO PUBLICATION

--

Your comments will be promptly investigated by qualified technical personnel and action will be taken as required.
If you require a written reply, please include your complete mailing address below.

NAME : _____ Date : _____

COMPANY : _____

ADDRESS : _____

Please give this technical publication remarks form to your BULL representative or mail to:

Bull - Documentation Dept.
1 Rue de Provence
BP 208
38432 ECHIROLLES CEDEX
FRANCE
info@frec.bull.fr

BULL CEDOC
357 AVENUE PATTON
B.P.20845
49008 ANGERS CEDEX 01
FRANCE

REFERENCE
86 A1 41EM 05

Utiliser les marques de découpe pour obtenir les étiquettes.
Use the cut marks to get the labels.

