

NovaScale Master 5.1 Server Add-ons

Installation and Administrator's
Guide



NOVASCALÉ

NovaScale Master 5.1

Server Add-ons

Installation and Administrator's Guide

Software

November 2007

BULL CEDOC
357 AVENUE PATTON
B.P.20845
49008 ANGERS CEDEX 01
FRANCE

REFERENCE
86 A2 95ER 02

The following copyright notice protects this book under Copyright laws which prohibit such actions as, but not limited to, copying, distributing, modifying, and making derivative works.

Copyright © Bull SAS 2006, 2007

Printed in France

Suggestions and criticisms concerning the form, content, and presentation of this book are invited. A form is provided at the end of this book for this purpose.

To order additional copies of this book or other Bull Technical Publications, you are invited to use the Ordering Form also provided at the end of this book.

Trademarks and Acknowledgements

We acknowledge the right of proprietors of trademarks mentioned in this book.

Intel® and Itanium® are registered trademarks of Intel Corporation.

Windows® and Microsoft® software are registered trademarks of Microsoft Corporation.

UNIX® is a registered trademark in the United States of America and other countries licensed exclusively through the Open Group.

Linux® is a registered trademark of Linus Torvalds.

The information in this document is subject to change without notice. Bull will not be liable for errors contained herein, or for incidental or consequential damages in connection with the use of this material.

Table of Contents

List of Figures	vii
List of Tables.....	viii
Preface.....	ix
Scope and Audience of this Manual.....	ix
Using this Manual	ix
Related Information	ix
Highlighting.....	x
Chapter 1. NovaScale Master Server Add-ons Concepts.....	1
1.1 NovaScale Master	1
1.1.1 Overview.....	1
1.1.2 Monitoring.....	2
1.1.3 Event Reception	2
1.1.4 Hardware Manager	3
1.1.5 Storage Manager	3
Chapter 2. NovaScale Master Server Add-ons Installation and Configuration.....	5
2.1 General Installation Requirements.....	5
2.1.1 Supported Operating Systems	5
2.1.2 Required Disk Space	5
2.1.3 Required Memory	5
2.1.4 Installation Requirements.....	5
2.1.5 Operational Requirements.....	6
2.1.6 Restrictions	6
2.2 Installing NovaScale Master Server Add-Ons for Windows.....	7
2.2.1 Prerequisites.....	7
2.2.2 Installing Free Management Server Add-Ons from the CD-ROM	7
2.2.3 Installing Payable Management Server Add-Ons Packages	9
2.2.4 Uninstalling NovaScale Master Server Add-Ons Components	9
2.2.5 Upgrading to a New NovaScale Master Server Add-Ons Version	9
2.3 Installing NovaScale Master Server Add-Ons for Linux.....	10
2.3.1 Prerequisites.....	10
2.3.2 Installing Free Management Server Add-Ons from the CD-ROM	10
2.3.3 Installing Payable Management Server Add-Ons Packages	12
2.3.4 Uninstalling NovaScale Master Server Add-On Components.....	12
2.3.5 Upgrading to a new NovaScale Master Server Add-Ons Version	12
2.4 Monitoring Configuration.....	13
2.4.1 Configuration GUI	13
2.4.2 Categories and Services	13

Chapter 3. NovaScale Master Server Add-ons Description	15
3.1 Internal Storage (Free).....	15
3.1.1 NSMasterGAMTT for LSI MegaRAID 320-2x Management	15
3.1.2 NSMasterLSICIM for LSI 22320 Chip Management	18
3.2 External Storage Server Add-ons	21
3.2.1 NSMasterStoreWayFDA (StoreWay FDA Management)	21
3.3 Virtualization Server Add-ons	23
3.3.1 Overview	23
3.3.2 NSMasterVMwareESX for "VMware ESX" Management	24
3.3.3 NSMasterHyperNova for "HyperNova" Management.....	35
3.4 Bull Products Server Addons	46
3.4.1 NSMasterDD4A for Bull "Dynamic Domains for Applications" Management	46
3.4.2 NSMasterBVS for Bull Video Services Management	47
3.4.3 NSMasterJOnAS for JOnAS Management.....	49
 Appendix A. Check Commands for Customizable Services of Add_ons	 55
Internal Storage Management	55
NSMasterGAMTT	55
NSMasterLSICIM.....	58
External Storage Management	60
NSMasterStoreWayFDA	60
Virtualization Management.....	62
NSMasterVMwareESX.....	62
NSMasterHyperNova	66
Bull Products Management.....	68
NSMasterDD4A.....	68
NSMasterBVS.....	70
NSMasterJOnAS.....	73
 Index	 75

List of Figures

Figure 1-1.	NovaScale Master Architecture.....	2
Figure 2-1.	Windows Installation - NovaScale Master Welcome Page.....	8
Figure 2-2.	Windows Installation - NovaScale Master Install Page.....	8
Figure 2-3.	Linux Installation - NovaScale Master Welcome Page.....	11
Figure 2-4.	Linux Installation - Selecting NovaScale Master Components.....	11
Figure 3-1.	GAM Monitoring Components.....	16
Figure 3-2.	LSI CIM Monitoring Components.....	19
Figure 3-3.	StoreWay FDA Monitoring Components.....	21
Figure 3-4.	Virtual Managers view.....	24
Figure 3-5.	Virtual Manager information pane.....	24
Figure 3-6.	VMwareESX Add-On components.....	25
Figure 3-7.	ESX Virtual Platforms page.....	26
Figure 3-8.	ESX Platform Properties.....	26
Figure 3-9.	ESX Virtual Machines pane.....	28
Figure 3-10.	Host Topology modification confirmation.....	29
Figure 3-11.	VMware category properties pane.....	32
Figure 3-12.	VMwareESX monitoring information.....	34
Figure 3-13.	VMwareESX reporting information.....	35
Figure 3-14.	HyperNova Add-On components.....	36
Figure 3-15.	HyperNova Virtualization Platforms page.....	37
Figure 3-16.	HyperNova Platform Properties.....	37
Figure 3-17.	Virtual Machines display after Discover step.....	38
Figure 3-18.	Virtual Machines display after Re-iscover step.....	39
Figure 3-19.	Host Topology modification confirmation.....	40
Figure 3-20.	Virtual Machine Properties pane.....	43
Figure 3-21.	Virtual Platform monitoring.....	45
Figure 3-22.	DDA4 Monitoring Components.....	46
Figure 3-23.	BVS Web Server Monitoring Components.....	48
Figure 3-24.	JOnAS Architecture.....	49
Figure 3-25.	JOnAS configuration.....	50
Figure 3-26.	JOnAS domains.....	51
Figure 3-27.	JOnAS properties.....	51
Figure 3-28.	JOnAS category and services.....	52
Figure 3-29.	JOnAS indicators.....	53
Figure 3-30.	JOnAS category view.....	53
Figure 3-31.	jonasAdmin launching.....	54

List of Tables

Table 2-1.	NovaScale Master - Required Memory.....	5
Table 2-2.	Management Server Add-Ons Installation Requirements.....	5
Table 2-3.	Management Server Add-Ons Operational Requirements.....	6
Table 3-1.	GAMTT monitoring services	16
Table 3-2.	LSI CIM monitoring services	19
Table 3-3.	StoreWay FDA monitoring services	21
Table 3-4.	DD4A categories and services	47
Table 3-5.	Bull Video Services categories and services.....	48

Preface

Scope and Audience of this Manual

NovaScale Master Server Add-Ons are Bull products, which provide extension to NovaScale Master for managing Bull Intel platforms specific devices or tools. Administration environments can include different platforms from the NovaScale Universal or Intensive Series or Express 5800 Series servers.

In order to monitor a specific item, NovaScale Master Server Add-Ons configuration must be customized. This manual explains also how, as an Administrator you can perform configuration tasks for these Add-Ons.



Note:

Configuration tasks may only be performed by Administrators.

Using this Manual

For a conceptual approach to NovaScale Master Server Add-Ons, read **Chapter 1**.

Chapter 2 describes how to install and configure NovaScale Master Server Add-Ons.

Chapter 3 describes for each Server Add-On how to configure its elements on the Management server. It provides detailed information about all resource properties as well as concrete examples to help customization of the configuration (Modifying Service Parameters, ...).

This chapter also contains reference information about categories and services of the monitoring server provided by these NovaScale Master Server Add-Ons.

Appendix A contains reference information about the check Nagios commands used by NovaScale Master Server Add-Ons monitoring services.

Related Information

- *NovaScale Master Installation Guide* (Ref. 86 A2 48EG).
- *NovaScale Master User's Guide* (Ref. 86 A2 49EG). The NovaScale Master GUI (Graphical User Interface) and the way to use are described in this guide.
- *NovaScale Master Administrator's Guide* (Ref. 86 A2 50EG).
- Restrictions and well-known problems are described in the associated *Release Notes* document.
- *Dynamic Domains for Applications User's Guide* (Ref 86 A2 63ER).

Highlighting

The following highlighting conventions are used in this book:

Bold	Identifies commands, keywords, files, structures, directories and other items whose names are predefined by the system. Also identifies graphical objects such as buttons, labels and icons that the user selects.
<i>Italics</i>	Identifies chapters, sections, paragraphs and book names to which the reader must refer for details.
Monospace	Identifies examples of specific data values, examples of text similar to displayed messages from the system, or information you should actually type.



Note:

Important information.

Chapter 1. NovaScale Master Server Add-ons Concepts

1.1 NovaScale Master

1.1.1 Overview

NovaScale Master monitoring ensures the following tasks:

- Monitoring NovaScale machines: NovaScale Master checks if these hosts are accessible, using the **ping** command from the System Manager. The machines to be monitored are either explicitly specified by the administrator or selected by a discovery mechanism.
- Monitoring specific elements of the hardware, operating system, services and Internet such as Power Status, **CPU load, memory usage, disk usage, number of users, processes** and **service execution, http and ftp services**.
The administrator can define status thresholds (OK, WARNING, CRITICAL, UNKNOWN) for each monitoring element. When an anomaly occurs or when normal status is recovered, **alerts** (in a log file) and **notifications** (by e-mail, by Bull autocall and/or by SNMP trap) are generated.

 **Note:**

Hardware and OS monitoring for Bull Intel-Based platforms are provided by the NovaScale Master Server package, not by the Add-Ons packages.

NovaScale Master Server Add-Ons extend the NovaScale Master monitoring with more specific links to third-party management tools for specific devices or/and specific system functionalities.

 **Note:**

These Server Add-Ons packages extend generally the management server independently of the platform or/and OS type (storage, network, virtualization, framework, ...).

NovaScale Master, a tool for monitoring and managing Bull NovaScale and Express 5800 systems, consists of three main components that can be deployed on Windows and Linux systems:

- Management Server and Server Add-ons
- Management Console
- Management Agent.

Management Server and Server Add-ons

Provides the infrastructure and services in charge of collecting and operating management data. Management Server must be installed on the server dedicated to management.

Management Console

Provides third-party management tools for the end-user station running the NovaScale Master console WEB GUI.

Management Agent

Provides instrumentation and administration tools for monitored servers. Management Agent must be installed on each server to monitor.

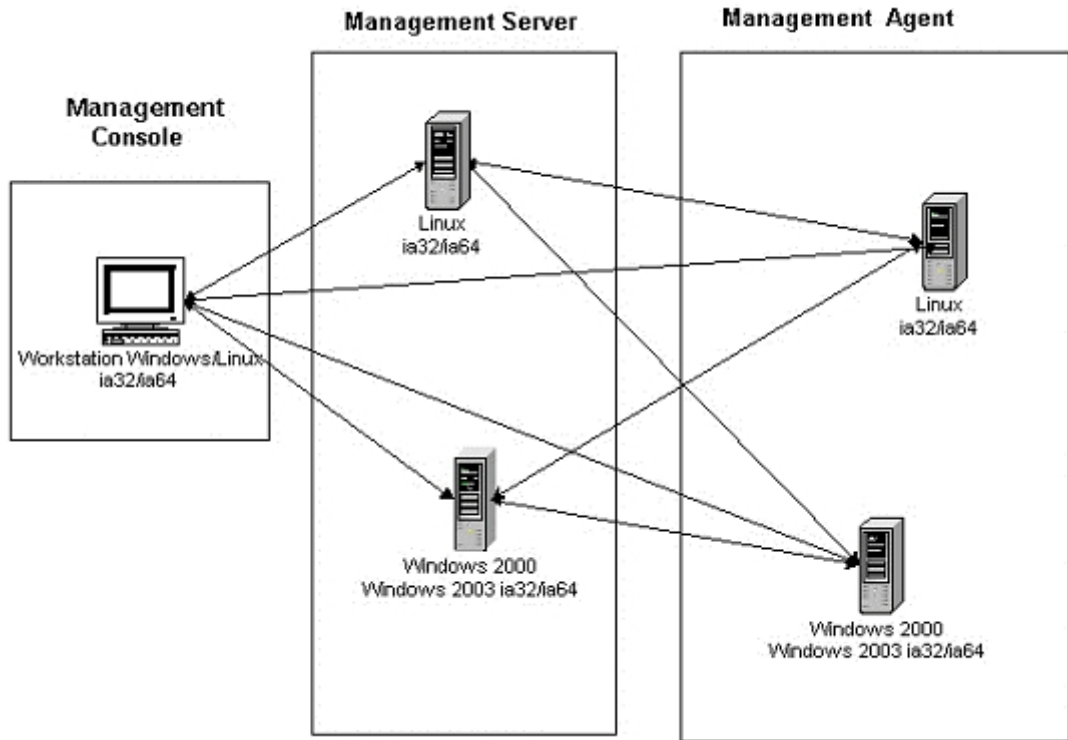

Figure 1-1. NovaScale Master Architecture



Note:

NovaScale Master for Windows and Linux are distributed on the same CD-ROM.

1.1.2 Monitoring

A **Service** (or monitoring service) defines how specific host elements are monitored. A service can be defined for all hosts or for a list of hosts, depending on the OS (Windows, Linux or both) and/or on the model. Notification properties are defined for each service.

Services are organized into monitoring **categories**. For instance, the **SystemLoad** category includes the **CPU** and **Memory** services for a Windows host.

1.1.3 Event Reception

NovaScale Master can receive **SNMP traps** from any SNMP agent. SNMP traps enable an agent to notify the NovaScale Master Server of significant events via an unsolicited SNMP message. SNMP Traps must be defined in a **MIB** (Management Information Base).

1.1.4 Hardware Manager

A **Hardware Manager** manages hardware for one or a set of servers.

1.1.5 Storage Manager

A **Storage Manager** manages storage for one or a set of servers or/and bays.

NovaScale Master Server Add-Ons

NovaScale Master Server Add-Ons deliver optional management packages to extend NovaScale Master Server.

A NovaScale Master Server Add-On provides functional links (monitoring, GUI call, reporting ...) between a NovaScale Master Server and a third-party management tool.

Some free Server Add-Ons are distributed on the NovaScale Master Add-Ons CD-ROM.

 **Note:**

There is a difference between the Server Add-On and the third-party management tool. Even if the third-party management tool may be dedicated to an OS or/and a platform type, its NovaScale Master Server Add-On will be able to be installed on a NovaScale Master Server machine. (Thus, on Linux and on Windows, on IA32 and on IA64 ...).

This release provides several NovaScale Master Server Add-Ons. Some of them are free and delivered on the NovaScale Master CD-ROM. The others must be purchased.

System Domains	Server Addons
Internal Storage (free)	LSI GAMTT Mgt Package
	LSI CIM Mgt Package
	LSI MegaRaid SAS Mgt Package
External Storage (not free)	StoreWay FDA Mgt Package
Bull Tools Management (not free)	Dynamic Domains Mgt Package
	Bull Video Service Mgt Package
	JOnAS framework Mgt Package
Virtualization Management (not free)	Vmware ESX Mgt Package
	Xen HN Master Mgt Package

Each Server Add-on is described in the following chapters.

Chapter 2. NovaScale Master Server Add-ons Installation and Configuration

2.1 General Installation Requirements

Before installing NovaScale Master, check that the environment meets the software and hardware requirements described below.

2.1.1 Supported Operating Systems

NovaScale Master Server Add-Ons operate on Linux and Windows operating systems.

The principal Requirements are the NovaScale Master Server pre-installation and its own requirements. See *NovaScale Master Installation Guide* for details.

2.1.2 Required Disk Space

In general, each Server Add-On needs between 1 and 2 MB.

2.1.3 Required Memory

The following table indicates the required memory for the Management Server.

NovaScale Master	Memory
Management Server	512MB

Table 2-1. NovaScale Master - Required Memory

2.1.4 Installation Requirements

Server Add-ons	Component
*	NSMasterServer5.0-x

Table 2-2. Management Server Add-Ons Installation Requirements

2.1.5 Operational Requirements

Server Add-ons	Target Tools
NSMasterGAMTT	Linux GAM version 6.02.31 or higher. Windows GAM version 6.02-32 or higher. Important: Contact <www.lsilogic.com> web site to download the above versions. If not on-line, contact the Bull support team. Note: For IA32 machines the following previous versions are supported: Linux GAM version 6.02-21 or higher Windows GAM version 6.02-22 or higher.
NSMasterLSICIM	LSI CIM provider version 3.06 or higher. Important: Contact <www.lsilogic.com> web site to download the above versions. If not on-line, contact the Bull support team. Note: Not supported on Linux IA64 system.
NSMasterMegaRaidSAS	LSI MegaRaid SAS (IR) SNMP agent version 3.09 or higher. Contact <www.lsilogic.com> web site to download the above versions. If not on-line, contact the Bull support team.
NSMasterStoreWayFDA	StoreWay FDA SNMP Agent release included in the "iSM NEC Storage Manager" v 4.2e and higher.
NSMasterDD4A	DD4A version 2.6.3 and higher
NSMasterBVS	BVS version 4.0 and higher
NSMasterJOnAS	JOnAS version 4.8 and higher
NSMasterVMwareESX	VMware ESX 3.0 and higher

Table 2-3. Management Server Add-Ons Operational Requirements

2.1.6 Restrictions

Windows

N/A

Linux

N/A

2.2 Installing NovaScale Master Server Add-Ons for Windows

2.2.1 Prerequisites

To install NovaScale Master Server Add-Ons on Windows:

- The user must be a member of an Administrators group. The default administrator login is Administrator.
- The installation program requires the Internet Explorer WEB browser. Other browsers, such as Netscape or Mozilla, cannot be used to install NovaScale Master on Windows.
- Management Server Add-Ons are to be installed on the server dedicated to management.
- Acrobat Reader is required to view PDF versions of the NovaScale Master documentation.
- The free Server Add-ons are present on the NovaScale Master CD-ROM, the others must be supplied by your Bull contact.

2.2.2 Installing Free Management Server Add-Ons from the CD-ROM

Management Server Add-Ons, to be installed on the server dedicated to management, require the components indicated in 2.1.4 *Installation Requirements*, and must be installed from the CD-ROM.

To install **Management Server**:

1. From the dedicated server, launch the installation program.
2. Log on as **Administrator**.
3. Insert the NovaScale Master or NovaScale Master Add-ons CD-ROM in the drive. The installation program is launched automatically and opens the **Welcome** page.

 **Note:**

If the installation does not start automatically, double-click <CD-ROM drive> / **setup.exe**.



Figure 2-1. Windows Installation - NovaScale Master Welcome Page

4. Click **Install Now** to open the **Install** page, which allows the selection of the required NovaScale Master component:
 - Management Server Add-Ons
 and provides the following information:
 - What to install?
 - What to do now?

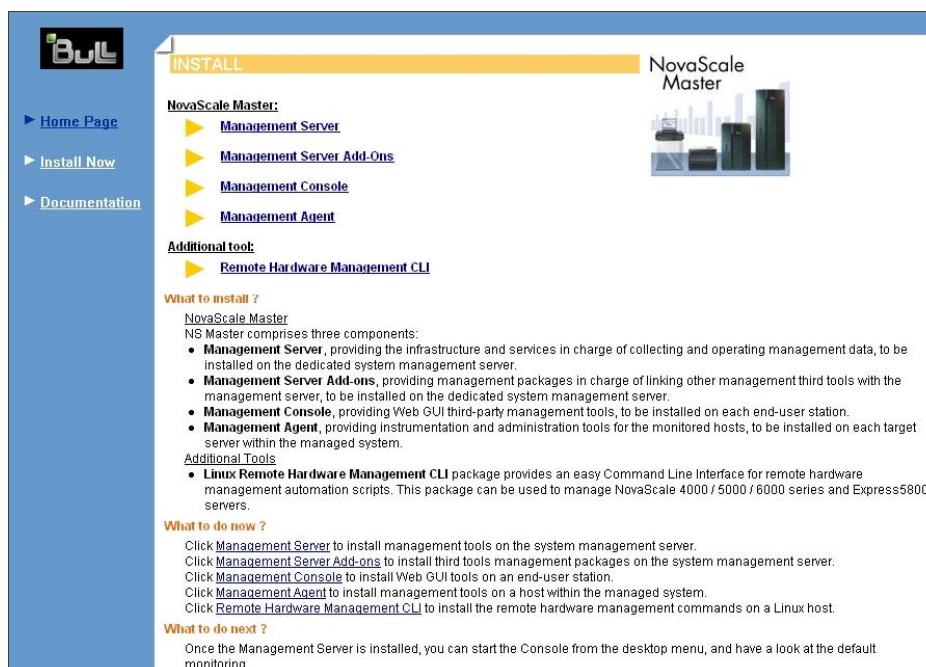

Figure 2-2. Windows Installation - NovaScale Master Install Page

5. Select **Management Server Add-Ons**, then **Windows 32 bits** or **Windows 64 bits** operating system according to server type.

6. Click the selected Add-Ons **Install Now** link to install the **Server Add-Ons** package. The wizard prompts for a destination folder.

The default value can be changed if required. At the end of the installation process, Management Server Add-Ons components are automatically operational.

2.2.3 Installing Payable Management Server Add-Ons Packages

These are auto-extractible packages. To install a package, just launch it from any logical device:

```
NSMaster<tierceTool>-5.1-x.exe
```

2.2.4 Uninstalling NovaScale Master Server Add-Ons Components

Uninstallation operations must be launched locally. Launching the uninstallation program removes all files and folders.

To uninstall NovaScale Master Add-Ons components:

1. From the Control Panel, launch **Add/Remove Programs**.
2. Select the required NovaScale Master Server Add-Ons components and click **Remove**.



Note:

After uninstallation operations, customized categories in previous version can remain in configuration. These elements must be removed using the NSMaster Configuration GUI.

2.2.5 Upgrading to a New NovaScale Master Server Add-Ons Version

When upgrading to a new NovaScale Master Server Add-Ons version, the existing NovaScale Master Server Add-Ons environment that may have been customized is maintained.

NovaScale MasterServer Add-Ons are upgraded via the standard installation program.



Note:

When you upgrade the NovaScale Master Management Server, you **MUST** upgrade previous release installed server add-ons to benefit from new improvements.

See the Release Notes for more details about specific add-on migration, where applicable.

2.3 Installing NovaScale Master Server Add-Ons for Linux

2.3.1 Prerequisites

To install NovaScale Master Server Add-Ons on Linux:

- The user must be logged as root.
- The installation program requires the Mozilla WEB browser (Version >1.4.3 or Firefox):
If Mozilla is not installed, launch another WEB browser and open file:
<CD-ROM Mount point>/product /index.html
It is advised to uninstall the previous version of Mozilla before installing a new version. This operation will not delete bookmarks, histories, cookies and other information stored in the profile directory.
The Mozilla directory must be set in the root PATH environment variable. If a previous version of Mozilla has not been uninstalled, the Mozilla directory must be set at the beginning of the PATH variable.
- Management Server Add-Ons are to be installed on the server dedicated to management.
- Acrobat Reader is required to view PDF versions of the NovaScale Master documentation.
- The free Server Add-ons are present on the NovaScale Master CD-ROM, the others must be supplied by your Bull contact.

2.3.2 Installing Free Management Server Add-Ons from the CD-ROM

Management Server Add-Ons, to be installed on the server dedicated to management, require the components indicated in 2.1.4 *Installation Requirements*, and must be installed from the CD-ROM.

To install **Management Server Add-Ons** from the CD-ROM:

1. From the dedicated server, launch the installation program.
2. Log on as **root**.
3. Insert the NovaScale Master CD-ROM in the drive.
The CD-ROM filesystem is automatically mounted to one of the following directories:
/mnt/cdrom or **/mnt/dvd** (Red Hat and Advanced Server distributions)
/media/cdrom or **/media/dvd** (SuSE distribution).
4. Launch the following commands:

```
cd <CD-ROM mount point>
./install.sh
```

The **install.sh** script automatically launches the Mozilla or Mozilla Firefox browser and opens the **Welcome** page.

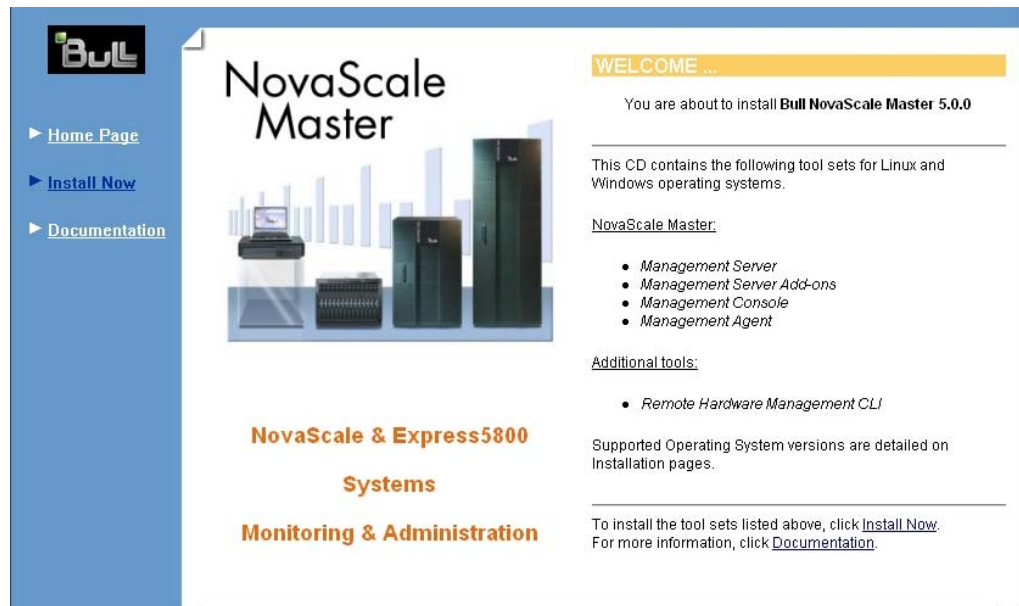

Figure 2-3. Linux Installation - NovaScale Master Welcome Page

5. Click **Install Now** to open the **Install** page, which allows the selection of the required NovaScale Master component:
 - Management Server Add-Ons
 and provides the following information:
 - What to install?
 - What to do now?

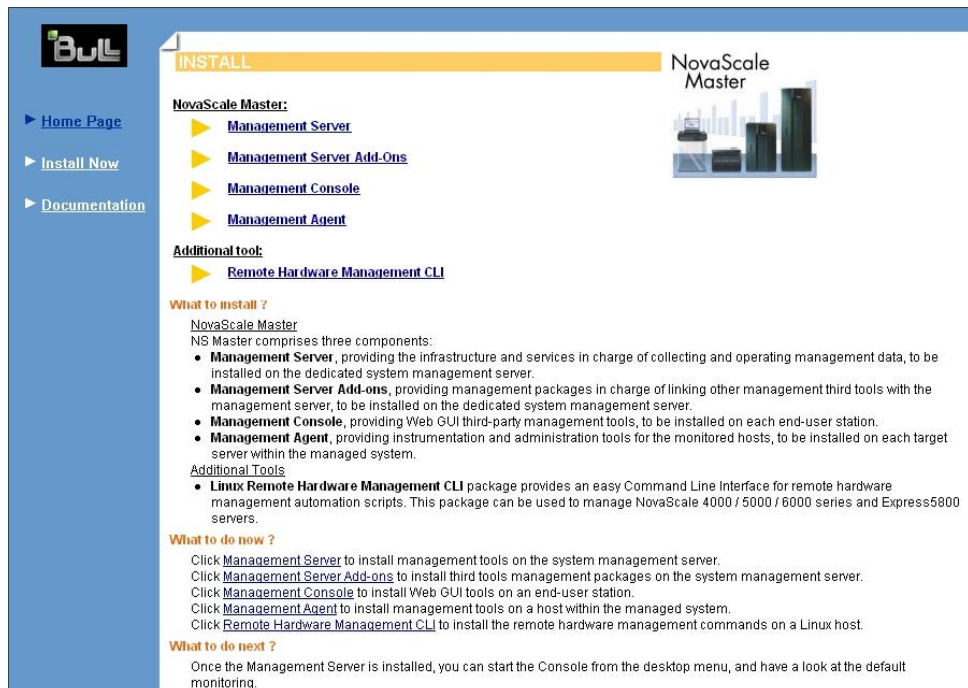

Figure 2-4. Linux Installation - Selecting NovaScale Master Components

6. Select Install Management Server Add-Ons.
7. Select the **Linux 32 bits** or **Linux 64 bits** operating system according to server type.
8. Install the selected **NovaScale Master Server Add-Ons** packages as described below.

```
cd <CD-ROM mount point>/product/mgtpack/NSMaster<toolname>/linux  
rpm -Uhv NSMaster<toolname>-5.1-x.noarch.rpm
```

2.3.3 Installing Payable Management Server Add-Ons Packages

These are RPM packages. To install a package just launch it from any logical device:

```
rpm -Uhv NSMaster<tiercetool>-5.1-x.noarch.rpm
```

2.3.4 Uninstalling NovaScale Master Server Add-On Components

1. Log on as **root**.
2. Launch the command:

```
rpm -e NSMaster<tiercetool>-5.1-x.noarch.rpm
```

2.3.5 Upgrading to a new NovaScale Master Server Add-Ons Version

When upgrading to a new NovaScale Master Server Add-Ons version, the existing NovaScale Master Add-Ons environment that may have been customized is maintained.

NovaScale Master Add-Ons are upgraded via the standard rpm installation command:

```
rpm -Uhv NSMaster<toolname>-5.1-x.noarch.rpm
```



Note:

When you upgrade the NovaScale Master Management Server, you **MUST** upgrade previous release installed server add-ons to benefit from new improvements.

See the *Release Notes* for more details about specific add-on migration, where applicable.

2.4 Monitoring Configuration

Configuring NovaScale Master Monitoring consists mainly in specifying the parameters required for monitoring tasks. Most configuration tasks are performed via the NovaScale Master Configuration GUI (Graphical User Interface).

NovaScale Master Server Add-Ons extend the Monitoring configuration default rules the Administrator can customize. New monitoring categories and services are provided.

2.4.1 Configuration GUI

NovaScale Master provides a GUI to perform the main configuration tasks.

Starting the Configuration GUI

To start the Configuration GUI, either:

- From the NovaScale Master Console, click the  icon representing the Configuration GUI in the Administration zone (top right)
- Or click the **Configuration** link on the NovaScale Master Home Page, URL:
`http://<NovaScale Master server name>/NSMaster`
- Or, from a WEB browser, go to the following URL:
`http://<NovaScale Master server name>/NSMaster/config/`

2.4.2 Categories and Services

NovaScale Master Server Add-Ons delivers more default monitoring categories and services. These categories and services depend on the Operating System running on the host:

- services for Windows hosts will be applied to all hosts with a Windows operating system,
- services for Linux hosts will be applied to all hosts with a Linux operating system,
- services for hosts, independently of the Operating System, will be applied to all hosts.

The administrator can change the default-monitoring configuration by:

- **customizing services**, to define specific thresholds and monitoring properties or to modify the list of monitored hosts. A service can be customized to create one or more occurrences of this service with the same name. Each occurrence can have a different host list and different monitoring properties. For instance, if you do not want to monitor file systems in the same way on all Linux hosts, customize the **All** service in the **FileSystems** category.

Note:

The Administrator CANNOT modify the OS and/or model type of these monitoring services and categories, as internal tool semantic checks may reject such modifications.

- **cloning services**, to define new monitored elements. One or more services are created, with different names from the original names. All properties can be edited except the check command. For instance, to monitor a specific logical drive on a Windows system, clone the C service and modify the check command parameters,
- **customizing categories**, to restrict monitoring a whole category to a list of hosts,
- **creating a category**, to assign a set of cloned services to this category.

See the *NovaScale Master Administrator's Guide* for more details about configuration.

Chapter 3. NovaScale Master Server Add-ons Description

NovaScale Master Server Add-Ons provides different functional items for each Management Package.

3.1 Internal Storage (Free)

3.1.1 NSMasterGAMTT for LSI MegaRAID 320-2x Management

GAMTT (or **GAM**) is the LSI tool used to survey, configure and control RAID provided by LSI MegaRAID Ultra320 SCSI cards.

See <http://www.lsilogic.com/products/megaraid/index.html> for more information or to download the GAMTT install package.



Note:

This tool runs on NovaScale machines under Linux or Windows.

The corresponding NovaScale Master Add-On creates monitoring links between NovaScale Master and the **GAM** SNMP agent.

The following figure shows the different monitoring components:

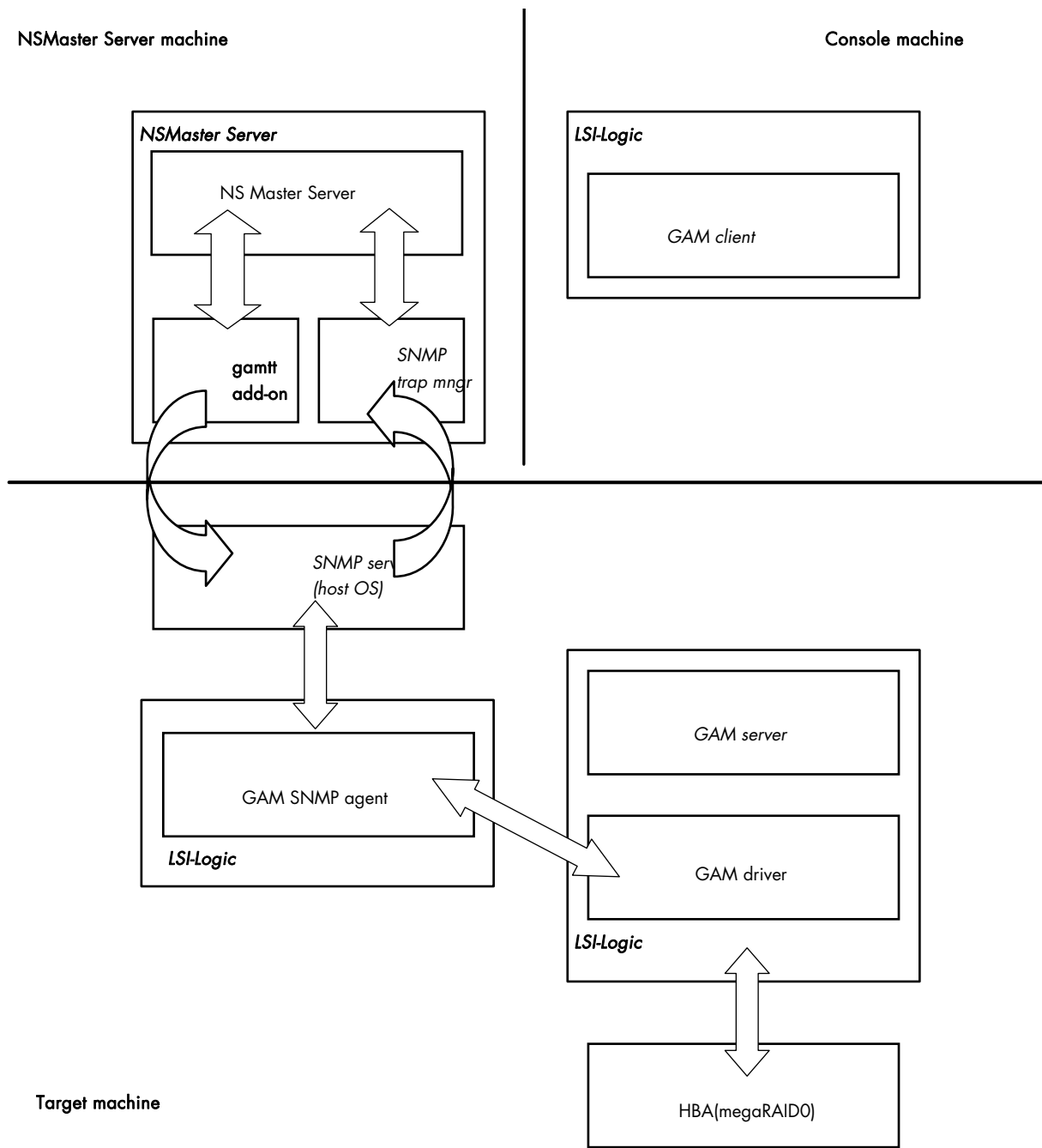

Figure 3-1. GAM Monitoring Components

3.1.1.1 Default Categories & Services (independent of OS type)

Targeted OS	Model	Category	Service	Check command
Any	any	GAMTTraid	Status	Check_gamttRAID
			Alerts	No check (SNMP trap receiver)

Table 3-1. GAMTT monitoring services



Notes:

- This category is based on the GAMTT management product from LSI. This tool and especially its SNMP interface is a requirement for the following GAMTTraid monitoring services. Check that this tool works on the targeted OS, if you want to monitor with it in NOVASCALE Master.
- This category is based on GAMTT management product from LSI. The previous (NOVASCALE Master release 4.0) "MegaRAID" category is based on PowerConsolePlus management product from LSI. These two management products are functionally redundant but not compatible. So you need to replace the "MegaRAID" category and its services by "GAMTTraid" category and services, if you replace PowerConsolePlus by GAMTT.

3.1.1.2 GAMTTraid Category

Status	For NovaScale and Express5800 hosts with an LSI (or Mylex) SCSI RAID card managed by GAMTT (or GAM) management tool. This service checks the Host RAID status reported by the associated GAMTT SNMP agent.
Alerts	For NovaScale and Express5800 hosts. When an alert is sent from the GAMTT SNMP agent, it is processed by the NovaScale Master server. Note: The <code>mlxraid.mib</code> mib is integrated in the NovaScale Master application.



Note:

Do not forget to configure the agent to send SNMP traps to the NovaScale Master server by adding the NovaScale Master server host address to the SNMP managers list of this agent.

3.1.1.3 check_gamttRAID (any OS) Nagios command

The configurable NovaScale Master service check command syntax is:

```
check_gamttRAID!<community>!<port>!<timeout>!{ [-A {ALL|<Ct>}] | [-P {ALL|<Ct>.<Ch>.<Tg>}] | [-L {ALL|<Ct>.<Ldn>}] }
```

Input

<community>	SNMP community string (defaults to "public")
<port>	SNMP port (defaults to 161)
<timeout>	Seconds before timing out (defaults to Nagios timeout value)
-A, -adapter ALL <Ct>	Controller board
-P, -physical ALL <Ct>.<Ch>.<Tg>	Physical device addr
-L, -logical ALL <Ct>.<Ldn>	Logical drive addr

Output

See the output of the `check_gamttRAID` command in Appendix A.

Default syntax for "GAMTTraid.Status"

```
check_gamttRAID!public!161!60!-A ALL
```

3.1.2 NSMasterLSICIM for LSI 22320 Chip Management

LSI CIM is the LSI tool used to survey, configure and control RAID provided by LSI MegaRAID 22320 SCSI cards.

See <http://www.lsilogic.com/products/megaraid/index.html> for more information or to download the LSI CIM install package.



Note:

This tool runs on NovaScale machines under Linux or Windows.

The corresponding NovaScale Master Add-On creates monitoring links between NovaScale Master and the **LSI CIM** provider.

The following figure shows the different monitoring components:

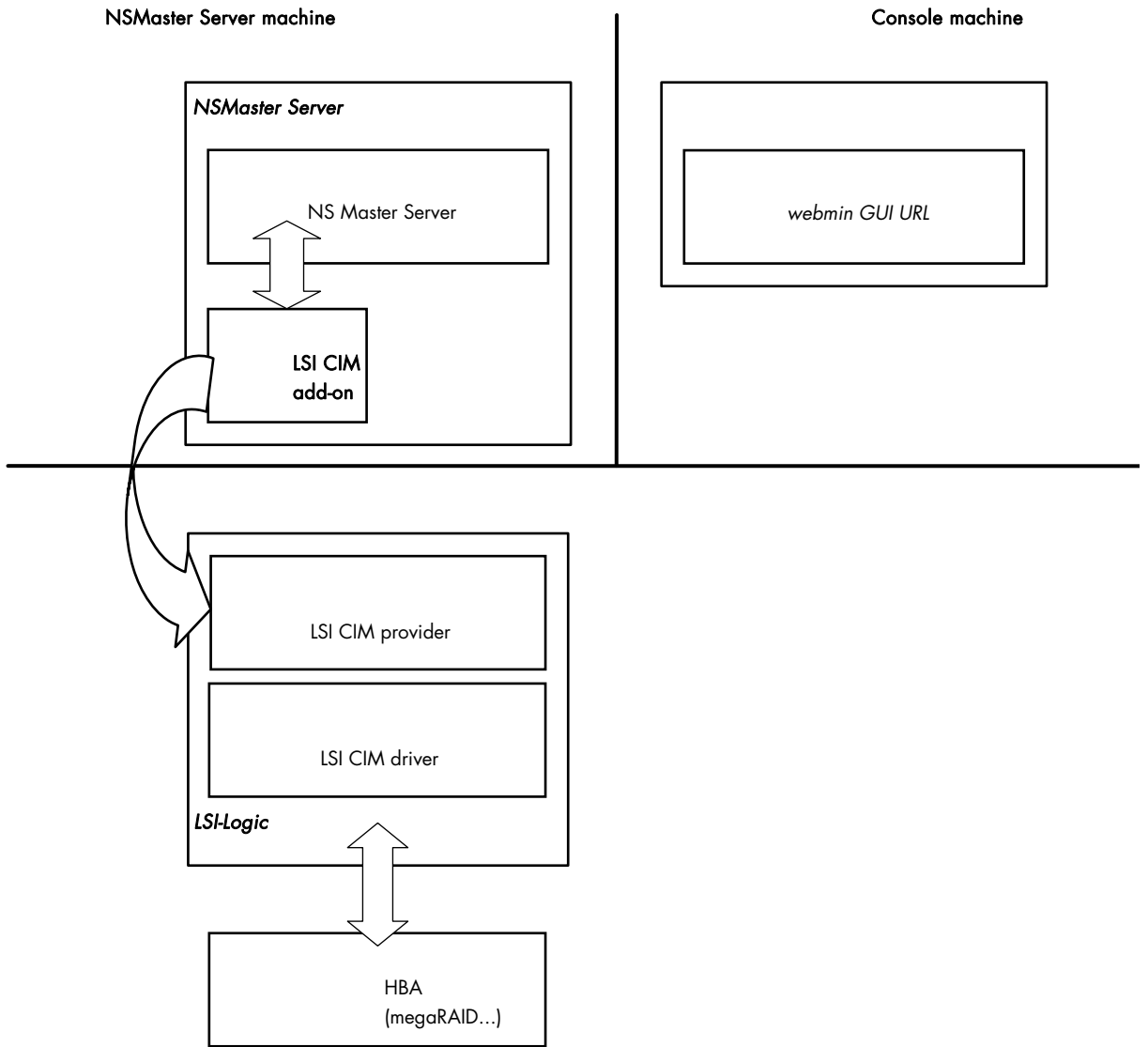

Figure 3-2. LSI CIM Monitoring Components

3.1.2.1 Default Categories & Services (independent of OS type)

Targeted OS	Model	Category	Service	Check command
Any	Any	LsiCIM	RAIDStatus	check_LSICIM
			CTRLstatus	check_LSICIM_ctrl

Table 3-2. LSI CIM monitoring services

Note:

This category is based on the LSI CIM management product. This tool is a requirement for the following LsiCIM monitoring services. Check that this tool works on the targeted OS, if you want to monitor with it in NovaScale Master.

LsiCIM Category

RAIDstatus For NovaScale and Express5800 hosts with an LSI SCSI RAID card managed by the LSI CIM management tool. This service checks the Host RAID status reported by the associated LSI CIM provider.

CTRLstatus For NovaScale and Express5800 hosts with an LSI SCSI RAID card managed by the LSI CIM management tool. This service checks the status of a specific RAID SCSI controller reported by the associated LSI CIM provider.

3.1.2.2 `check_LSICIM` (any OS) Nagios command

The configurable NovaScale Master service check command syntax is:

```
check_LSICIM
```

Input

N/A

Output

See the output of the `check_LSICIM` shell command in Appendix A.

Default syntax for "LsiCIM.CTRLstatus"

```
check_LSICIM
```

3.1.2.3 `check_LSICIM_ctrl` (any OS) Nagios command

The configurable NovaScale Master service check command syntax is:

```
check_LSICIM_ctrl! [<ctrlname>]
```

Input

<ctrlname> Name of the controller to check



Note:

The name of the controller must be protected with a quote if the name contains blank characters.

Output

See the output of the `check_LSICIM` shell command in Appendix A.

Default syntax for "LsiCIM.CTRLstatus" is inactive:

```
check_LSICIM! 'ctrlname'
```

3.2 External Storage Server Add-ons

3.2.1 NSMasterStoreWayFDA (StoreWay FDA Management)

The corresponding NovaScale Master Add-On creates monitoring links between NovaScale Master and the StoreWay FDA SNMP agent and WEB GUI.

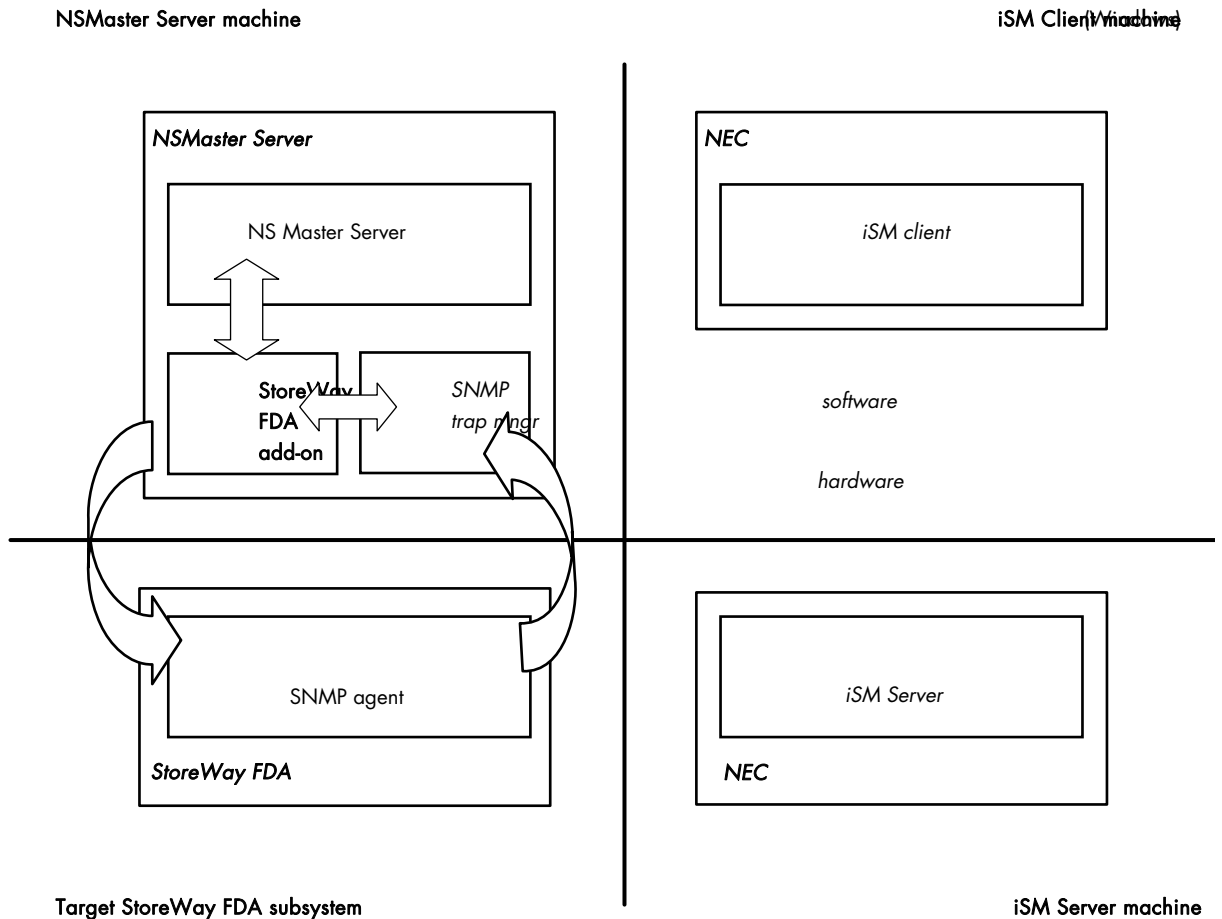

Figure 3-3. StoreWay FDA Monitoring Components

3.2.1.1 Default Categories & Services (independent of OS type)

Targeted OS	Model	Category	Service	Check command
Any	BayStoreWay FDA	StoreWayFDA	Status	check_NECFDA
			Alerts	No check (SNMP trap receiver)

Table 3-3. StoreWay FDA monitoring services

**Note:**

This category is based on the StoreWay FDA SNMP agent. This SNMP interface is a requirement for the following StoreWayFDA monitoring services.

3.2.1.2 StoreWayFDA Category

Status For StoreWay FDA hosts managed via its SNMP agent. This service checks the StoreWay FDA status reported by the SNMP agent.

Alerts For StoreWay FDA hosts. When an alert is sent from the StoreWay FDA SNMP agent, it is processed by the NovaScale Master Server.

**Note:**

The **Armg2_4.mib** mib is integrated in the NovaScale Master application.

**Note:**

Do not forget to configure the StoreWay FDA agent to send SNMP traps to the NovaScale Master Server by adding the NovaScale Master Server host address to the agent's SNMP managers list.

3.2.1.3 check_NECFDA (any OS) Nagios command

The configurable NovaScale Master service check command syntax is:

```
check_storewayfda!<community>!<port>!<timeout>
```

See the **check_NECFDA** command in Appendix A for parameters details.

Default syntax for "StoreWayFDA.Status" is:

```
check_necfda!public!161!60
```

3.2.1.4 NovaScale Master Configuration

StoreWayFDA configuration for NovaScale Master is available from the configuration GUI by selecting **Topology** → **StoreWay** → **StoreWayFDAs**.

To edit a StoreWay FDA, select **Edit**.

To define a new StoreWay FDA in the NovaScale Master configuration database, click the **New StoreWay FDA** button and initialize the following attributes:

StoreWay FDA name name of the StoreWay FDA

description description

network name bay netname

snmp port number SNMP port number

snmp community SNMP community

3.3 Virtualization Server Add-ons

3.3.1 Overview

The NovaScale Master Server Virtualization Add-ons deliver an optional management package to manage virtual machines. A virtualization Add-on can provide:

- Supervision features to detect abnormalities and notify them to defined entities,
- Administration features to perform actions on elements.

3.3.1.1 Definitions

Virtualization Add-Ons use specific topology elements:

- **Native Operating System (Native OS):**
the virtualization layer installed on a physical machine that hosts virtual machines. It is represented by a NovaScale Master host with a specific OS (specified by the Add-On).
- **Virtual Machine (VM):**
a machine that is hosted by a native OS. It is represented by a NovaScale Master host with a specific model (specified by the Add-On).
- **Virtual Platform:**
the set of virtual machines and native OS deployed on a physical machine.
- **Virtual Manager:**
the interface used to manage the virtual elements.

3.3.1.2 Topology Representation

The elements of a virtual platform are displayed in the NovaScale Master Console views.

To load a specific view, select **File** → **Load** → **SystemMgt** → **view name**

Or, if already loaded, switch from one view to another by selecting **Views** → **view name**

- From the **Hosts** view, only the native OS and VM hosts are displayed. VM hosts are represented with the specific icon .
- From the **Virtual Managers** view, the virtual platform is displayed as shown in the following figure:

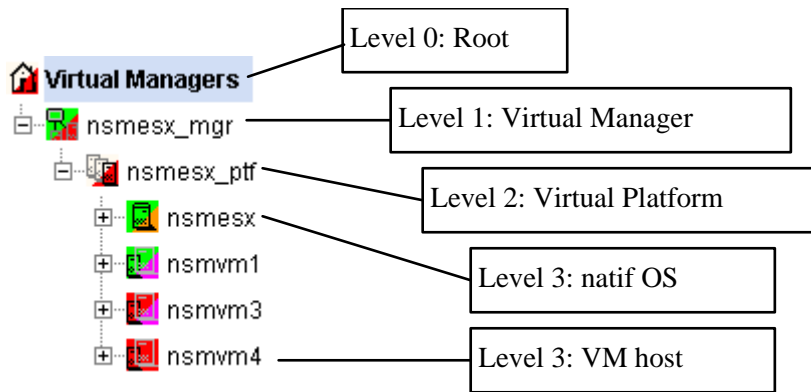

Figure 3-4. Virtual Managers view

Under the root node, the first node is the Virtual Manager that administrates the Virtual Platform. The Virtual Platform contains the native host and the VM hosts. When you select a node, information about the elements are displayed in the Application pane.

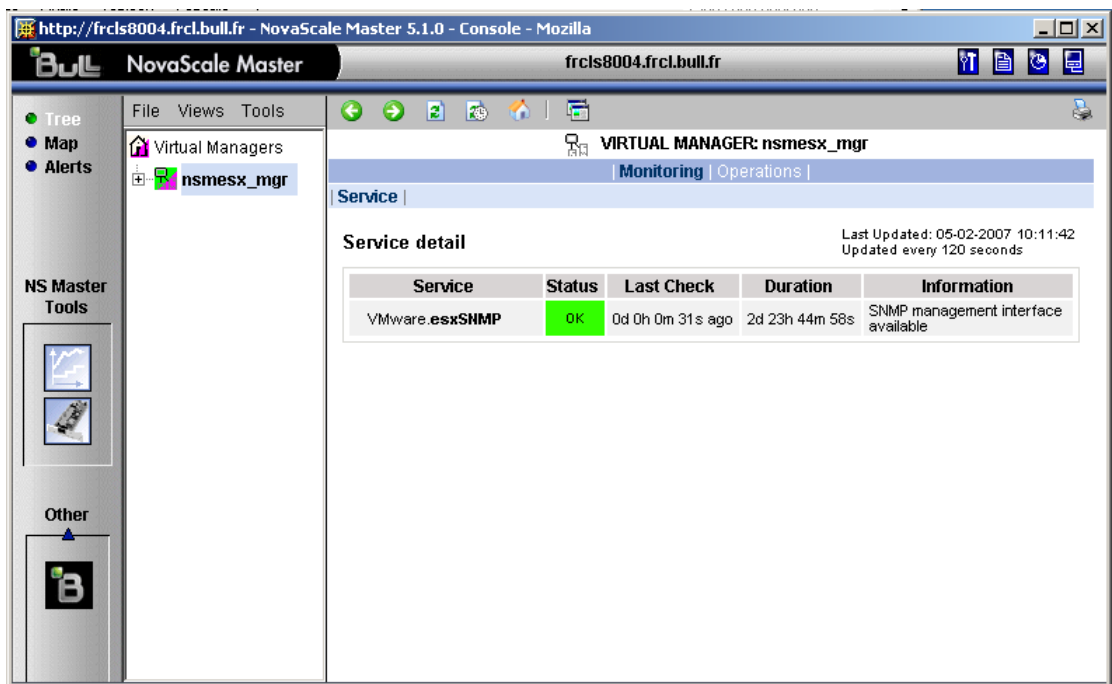



Figure 3-5. Virtual Manager information pane

3.3.2 NSMasterVMwareESX for "VMware ESX" Management

3.3.2.1 Overview

The **VMware ESX** server is a virtualization layer that abstracts processor, memory, storage and networking resources into multiple virtual machines.

The VMwareESX Add-On provides functional links to manage the virtual machines hosted by the ESX server.

 **Note:** The link is functional only with the version 3 of the ESX server.

The VMwareESX Add-On retrieves VM and native OS monitoring information via the VMware Service Console SNMP interface and allows the Web Virtual Interface to be launched from the NovaScale Master Console.

The following figure shows the link between each component:

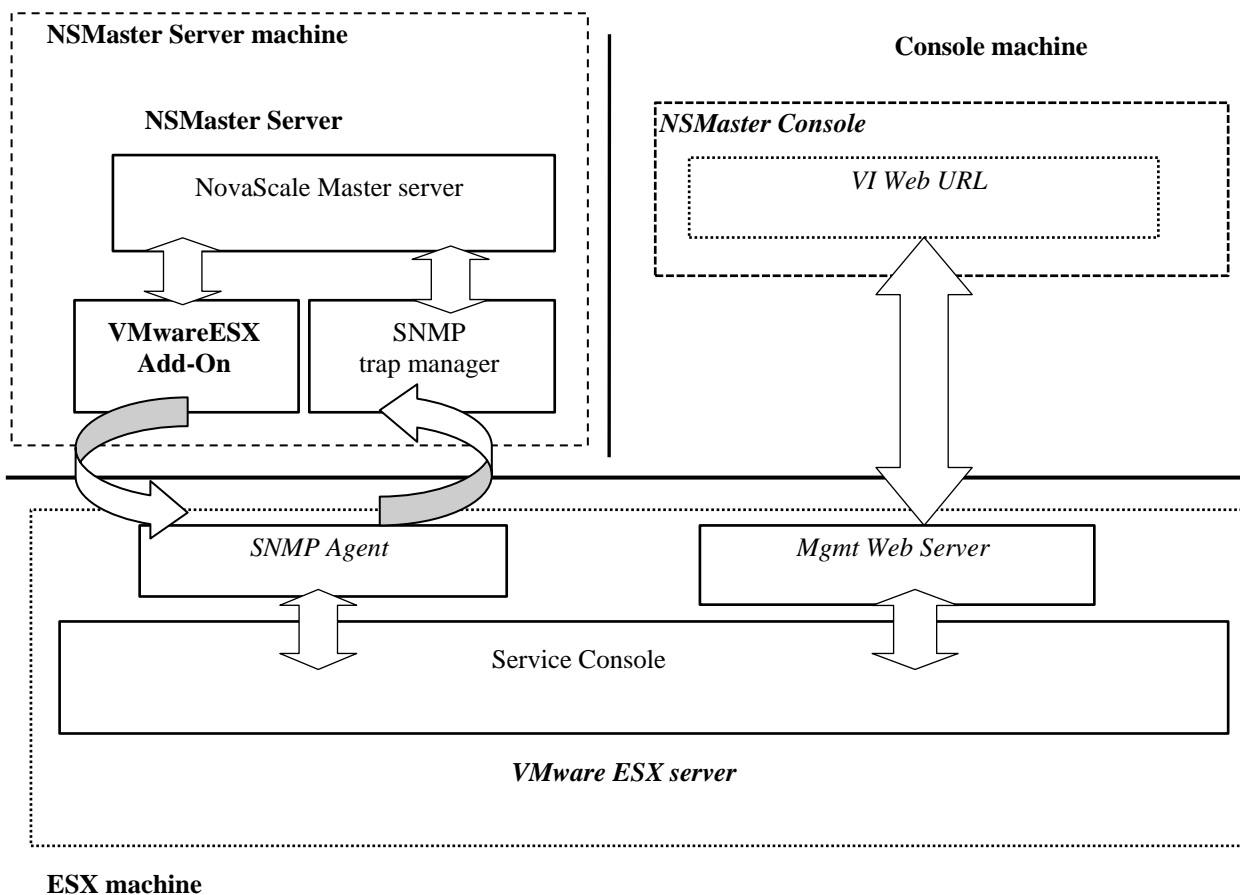

Figure 3-6. VMwareESX Add-On components

Note:

The SNMP agent of the ESX server must be configured to receive SNMP requests from and to send traps to the NovaScale Master Server. Web access requires specific configuration of the Web client. For detailed information about these procedures, see the VMware Infrastructure documentations available at http://www.vmware.com/support/pubs/vi_pubs.html.

3.3.2.2 NovaScale Master Configuration

To configure the monitoring elements for the VMwareESX Add-On, you have to define an ESX Virtual Platform from the NovaScale Master Configuration GUI. Native OS, VMs, related monitoring services and reporting indicators are defined in one easy step. The native OS is represented by a NSMaster host with the OS: **ESX**. VMs are represented by a NSMaster host with the model: **VMware**.

3.3.2.2.1 ESX Virtual Platform

To configure an ESX Virtual Platform, click the **VMware ESX** link in the Virtualization part of the Topology domain. The list of all configured platforms appears, as in the following example:

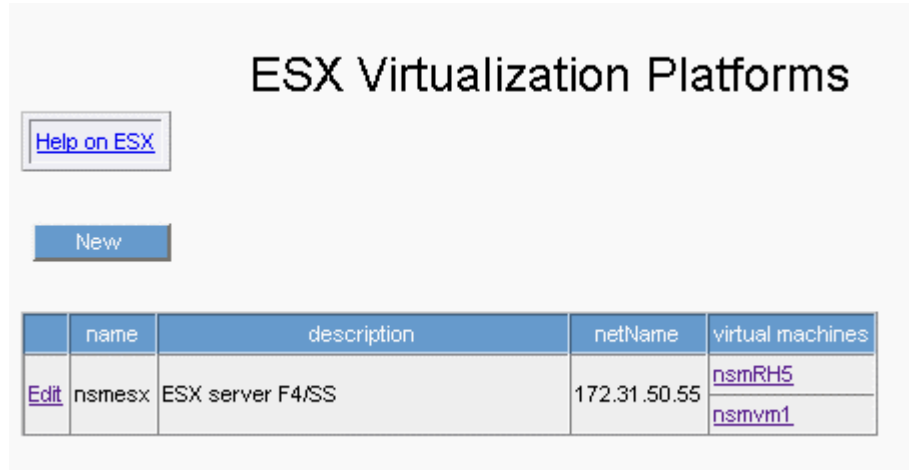

Figure 3-7. ESX Virtual Platforms page

It is possible:

- To create a new ESX Virtual Platform using the **New** button
- To edit or delete a resource using the **Edit** link
- To edit a virtual machine using the **<hostname>** link.

When you click the **New** button, the following display appears with all resource properties:

Properties	
name	<input type="text"/>
description	<input type="text"/>
ESX Server Host	
name	<input type="text"/> <input type="button" value="Select"/>
model	other <input type="button" value="v"/>
network name	<input type="text"/>
SNMP Configuration	
SNMP port	161
SNMP community	public
Virtualization Platform	
Virtual Machines	
<input type="button" value="Discover"/>	To get the list of virtual machine hosted, click the Discover button

Figure 3-8. ESX Platform Properties

Besides the characteristics (name and description) of the main object, the properties of an ESX virtual platform are divided into three-parts:

- **ESX Server Host:** used to define the physical machine and the native OS.

- **SNMP Configuration:** used to configure SNMP interface data.
- **Virtualization Platform:** used to describe the Vmware ESX platform virtual machine.

ESX Server Host Properties

name	ESX host short name. This name is displayed in the NovaScale Master Console views. Click Select to choose a defined host from the NSMaster host list.
model	Host model (see the <i>NovaScale Master Administrator's Guide</i> for values).
network name	ESX host network name (hostname or IP address).

SNMP Configuration Properties

SNMP port	SNMP agent port.
SNMP configuration	SNMP agent community.

Virtualization Platform Properties

Virtual Machines	List of the VMs established by selecting the VMs obtained by requests to the ESX server SNMP agent. The request is performed by clicking the Discover button (or Re-discover if in edition mode). See below the complete description of the procedure.
-------------------------	---

Virtual Machines Discovery

The result of the discovery is displayed as a table composed of three parts:

- the left column allows you to select the VMs to be associated to the platform
- the center part displays Virtual Machine Configuration as defined on the VMware ESX server
- the right part allows you to edit the main properties (name, network name and OS) of the corresponding NSMaster host. The host can be edited only if the corresponding VM is selected. You can select an already defined host by clicking the **Select** button or you can create a host by completing the corresponding fields.

Note:

When you select an already defined host, you cannot change its network name and OS. But the Select contains a Default Option corresponding to the VM name, that can be edited. If the VM name contains space(s), they are replaced by underscore(s) in the host label.

Virtual Machines

Select virtual hosts to associate them to the ESX platform by clicking the corresponding checkbox.
Then, map each virtual hosts to a defined NS Master host or choose to create a new.

<input checked="" type="checkbox"/>	ESX Virtual Machines	NS Master Configuration			
	Name	Name		netName	OS
<input checked="" type="checkbox"/>	nsmvm5	nsmvm5	Select	nsmvm5	other ▼
<input checked="" type="checkbox"/>	nsmvm2	nsmvm2	Select	nsmvm2	other ▼
<input checked="" type="checkbox"/>	White windows	White_windows	Select	White_windows	other ▼
<input checked="" type="checkbox"/>	nsmRH5	nsmRH5	Select	nsmRH5	other ▼
<input checked="" type="checkbox"/>	nsmvm1	nsmvm1	Select	172.31.50.60	other ▼
<input checked="" type="checkbox"/>	nsmvm4	nsmvm4	Select	nsmvm4	other ▼

To update the list of virtual machines, click the Re-discover button

Figure 3-9. ESX Virtual Machines pane

Virtual Machines Re-Discovery

Re-Discovery is required to check that the current NSMaster configuration still matches the VMware ESX configuration in order to:

- Add virtual machine not yet registered in the VMware ESX Virtualization Platform
- Remove virtual machine no more defined in the VMware ESX configuration.

During the Re-discovery step, if the current configuration is not compatible with VMware ESX configuration, the invalid VMs are displayed in red and the VMs not referenced in the current NSMaster configuration are displayed in green.

VMs no longer defined in VMware ESX are automatically unchecked and will be removed from the platform on form validation. New VMs must be explicitly checked for being added in the platform to be linked to the platform on form validation.

Note:

How to Add, Delete or Modify Virtual Machine is detailed in 3.3.2.2.2 *Virtual Machine Edition*, on page 29.

After edition:

- Click the **OK** button to validate your edition
- Or click **Cancel** to return to Virtual Platforms pages without changes
- Or click **Delete** to remove the Virtual Platform and maintain the hosts corresponding to the VMs and the VMware ESX server
- Or click **DeleteAll** to remove the Virtual Platform and the hosts corresponding to the VMs and the VMwareESX server.

Note:

Edition with a **Topology modification** requires confirmation: a page listing all modifications to be applied to the Topology configuration is displayed, as shown in the following figure.

ESX Virtualization Platform

Host Topology Modification

Configuration of the ESX Platform will lead to the following modification in Host Topology:

- VMware windows host will be created with model VMware.
- nsm host will be created with OS ESX.

Do you agree ?

Figure 3-10. Host Topology modification confirmation

If you do not agree, click the **NO** button to return to the platform edition page, otherwise click the **YES** button to create the virtual platform.

Related ESX Virtualization platform Objects

When an ESX Virtualization platform is defined, related objects are automatically generated to configure the specific Supervision linked to this type of NovaScale server. The following table describes the objects generated during the creation of the platform.

Type	Description
host VMware	As defined in the Virtual Machine configuration part of the edition page.
host ESX	Host corresponding to the virtualization layer, as defined in the ESX server Host configuration part.
hostgroup	hostgroup representing the physical platform, named <platformName>.
manager	Virtualization manager representing the management interface, named < platformName>_mgr.
categories and services	The VMwareESX category and related services are instantiated for the ESX host. The VirtualMachine category and related services are instantiated for each VMware host.

3.3.2.2.2 Virtual Machine Edition

A virtual machine is represented by a host linked to the VMware ESX Virtualization platform. It has properties linked to the platform and properties of a host object.

Add, remove or modification of properties linked to the platform must be done from the VMware Virtualization platform edition page.

Modification of host properties must be done from the Host edition page.

Add a virtual machine to a platform

Add of a virtual machine is performed by checking the corresponding line in Virtual Machines part of the platform edition form and setting the host characteristics in NSMaster Configuration table zone (by filling in the corresponding fields or by selecting an already defined host).

Note:

When you edit a Virtualization platform, only the Virtual Machines defined as part of the NovaScale Master platform are displayed. To add a virtual machine, you must perform a Re-discovery to get the list of all machines defined on the Virtualization Server.

Remove a virtual machine from a platform

Remove a virtual machine is performed by unchecking the corresponding line in the Virtual Machines part of the platform.

Note:

The corresponding host remains in the NovaScale Master definition with model set to 'other'. To delete it, click the **Other Hosts** link to get the list of all Other Hosts configured, edit the corresponding host and click the **Delete** button.

Modify a virtual machine defined in a platform

To modify the name of the NSMaster host corresponding to a virtual machine, enter the new name in the corresponding field or choose it in the list of already defined hosts in NovaScale Master by clicking the **Select** button.

To modify other characteristics as netName or OS, the Host edition form must be used.

Note:

To get the Host edition form corresponding to the virtual machine, click the **Hostname** link displayed in the global platforms page.

Delete all virtual machines and corresponding hosts.

To delete all virtual machines and corresponding hosts, use the **DeleteAll** button of the Virtualization Platform Edition form. Beware: the virtualization server and the platform will be also deleted from the NovaScale Master configuration.

3.3.2.2.3 Virtualization Supervision

As specified above, services are instantiated for each host defined in the Virtualization Platform. You can disable virtualization supervision by editing the hostgroup or manager properties or by editing each service (refer to the *NovaScale Administration Guide* for details).

Monitoring Services

Monitoring services defined for the native OS are associated with the **VMwareESX** category.

Services Applied to the Native OS

Service	Description	Check_command
Status	Checks ESX server status	check_esx_server
SNMP	Checks the ESX SNMP interface	check_esx_snmp
Memory	Checks ESX memory availability	check_esx_mem
Alerts	Processes alerts received from the ESX SNMP agent	none (SNMP Trap receiver)

Monitoring services defined for VM hosts are associated with the **VirtualMachine** category.

Services Applied to the VM Host

Service	Description	Check_command
Status	Checks VM status	check_esx_vm
CPU	Checks VM CPU usage	check_esx_vm_cpu
Memory	Checks VM memory availability	check_esx_vm_mem

Monitoring services related to Virtual Platform elements are automatically created during the edition of the ESX Virtual Platform. These services can be displayed and edited from the Services page in the Supervision domain, but only attributes related to monitoring or notification can be edited.

Properties	
category	VMware
name	esxStatus
description	checks the ESX server status (automatically generated)
model	any
OS family	ESX
host list expression	nsmesx
Monitoring attributes	
status	<input checked="" type="radio"/> active <input type="radio"/> inactive
Monitoring command attributes (for this service)	
check command	check_esx_server
check command parameters	public!50%!0%
monitoring period	24x7
polling interval	5 mn (5 mn by default if empty)
Notification attributes (for this service)	
e-mail contact groups	<div style="display: flex; justify-content: space-between;"> <div> <p>Selected Objects</p> <ul style="list-style-type: none"> mgt-admins </div> <div style="text-align: center;"> <p><= Add</p> <p>Remove =></p> </div> <div> <p>All Objects</p> <ul style="list-style-type: none"> mgt-admins </div> </div>
enable Bull autocall	<input type="radio"/> Yes <input checked="" type="radio"/> No
enable SNMP trap	<input checked="" type="radio"/> Yes <input type="radio"/> No
notification period	24x7
re-notification interval	240 mn (240 mn by default if empty)
notify if warning	<input checked="" type="radio"/> Yes <input type="radio"/> No
notify if critical	<input checked="" type="radio"/> Yes <input type="radio"/> No
notify if recovery	<input checked="" type="radio"/> Yes <input type="radio"/> No

Figure 3-11. VMware category properties pane



Note:

During ESX Platform definition, all services are defined and activated for the ESX server and for each VM. To deactivate the monitoring of one service, set **status** (Monitoring attributes part) to inactive.

3.3.2.3 Nagios Check Commands

check_esx_server

The configurable NovaScale Master service check command syntax is:

```
check_esx_server!<snmp_community>!<wThres>%!<cThres>%
```

See the **check_esx3** command in Appendix A for parameters details.

check_esx_snmp

The configurable NovaScale Master service check command syntax is:

```
check_esx_snmp!<snmp_community>
```

See the **check_esx3** command in Appendix A for parameters details.

check_esx_mem

The configurable NovaScale Master service check command syntax is:

```
check_esx_mem!<snmp_community>!<wThres>!<cThres>
```

See the **check_esx3** command in Appendix A for parameters details.

check_esx_vm

The configurable NovaScale Master service check command syntax is:

```
check_esx_vm!<esx_server>!<snmp_community>!<vmname>
```

See the **check_esx3** command in Appendix A for parameters details.

check_esx_vm_memory

The configurable NovaScale Master service check command syntax is:

```
check_esx_vm!<esx_server>!<snmp_community>!<vmname><wThres>!<cThres>
```

See the **check_esx3** command in Appendix A for parameters details.

check_esx_vm_cpu

The configurable NovaScale Master service check command syntax is:

```
check_esx_cpu!<esx_server>!<snmp_community>!<vmname><wThres>!<cThres>
```

See the **check_esx3** command in Appendix A for parameters details.

3.3.2.4 Reporting Indicators

Reporting indicators are defined for VM hosts and for native OS. They get values from the corresponding monitoring services.

Indicators Applied to the Native OS

Indicator	Corresponding Service
<esx_server>_esxMemory	esxMemory

Indicators Applied to the VM Host

Indicator	Corresponding Service
<vm_host>_vmCPU	vmCPU
<vm_host>_vmMemory	vmMemory



Note:

During ESX Platform definition, all indicators are defined and activated for the ESX server and for each VM. To deactivate the reporting of one indicator, set to inactive. Beware, if you deactivate the corresponding service, the indicator will no longer be collected.

3.3.2.5 NovaScale Master Console

VMwareESX Operation

From the Virtual Manager or from any element of the Virtual Platform, you can launch the **Virtual Infrastructure Web Interface** by selecting the following cascading menu:

Operation → Application → VMware VI Web

VMwareESX Monitoring

From the platform or host elements, you can access monitoring information.

From the hosts element, you can display information related to associated services by selecting **Monitoring** menus.

From the platform element, you can display monitoring information related to all elements by selecting **Monitoring** menus. For instance, you can view all services of the hosts in the platform, as show in the following figure:

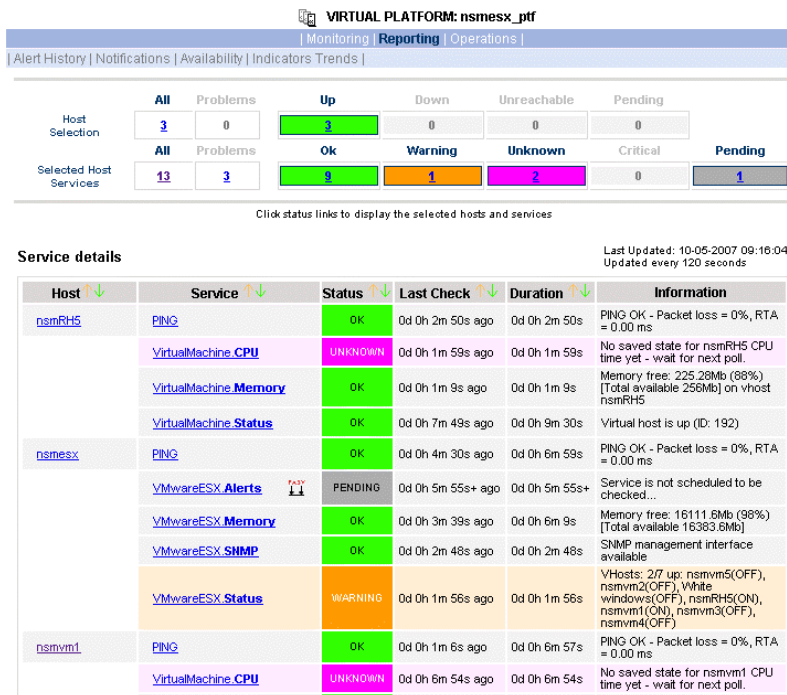
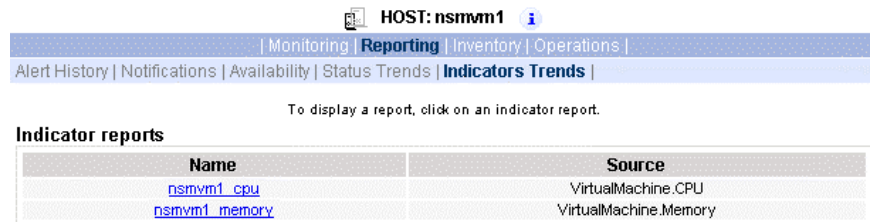

Figure 3-12. VMwareESX monitoring information

VMwareESX Reporting

From the platform or host elements, you can access reporting information by selecting **Indicators Trends** from the **Reporting** menu.

From the host element, you can display indicators related to this host as shown in the following figure:



HOST: nsmvm1

| Monitoring | **Reporting** | Inventory | Operations |

Alert History | Notifications | Availability | Status Trends | **Indicators Trends** |

To display a report, click on an indicator report.

Name	Source
nsmvm1_cpu	VirtualMachine.CPU
nsmvm1_memory	VirtualMachine.Memory

Figure 3-13. VMwareESX reporting information

From the platform element, you can display indicators related to all platform elements.

3.3.3 NSMasterHyperNova for "HyperNova" Management

3.3.3.1 Overview

The HyperNova server is a virtualization layer that abstracts processor, memory, storage and networking resources into multiple virtual machines.

The HyperNova Add-On provides functional links to manage the virtual machines hosted by the HyperNova server, by requesting the administration tool, HyperNova Master (HN Master).

The following figure shows the link between each component:

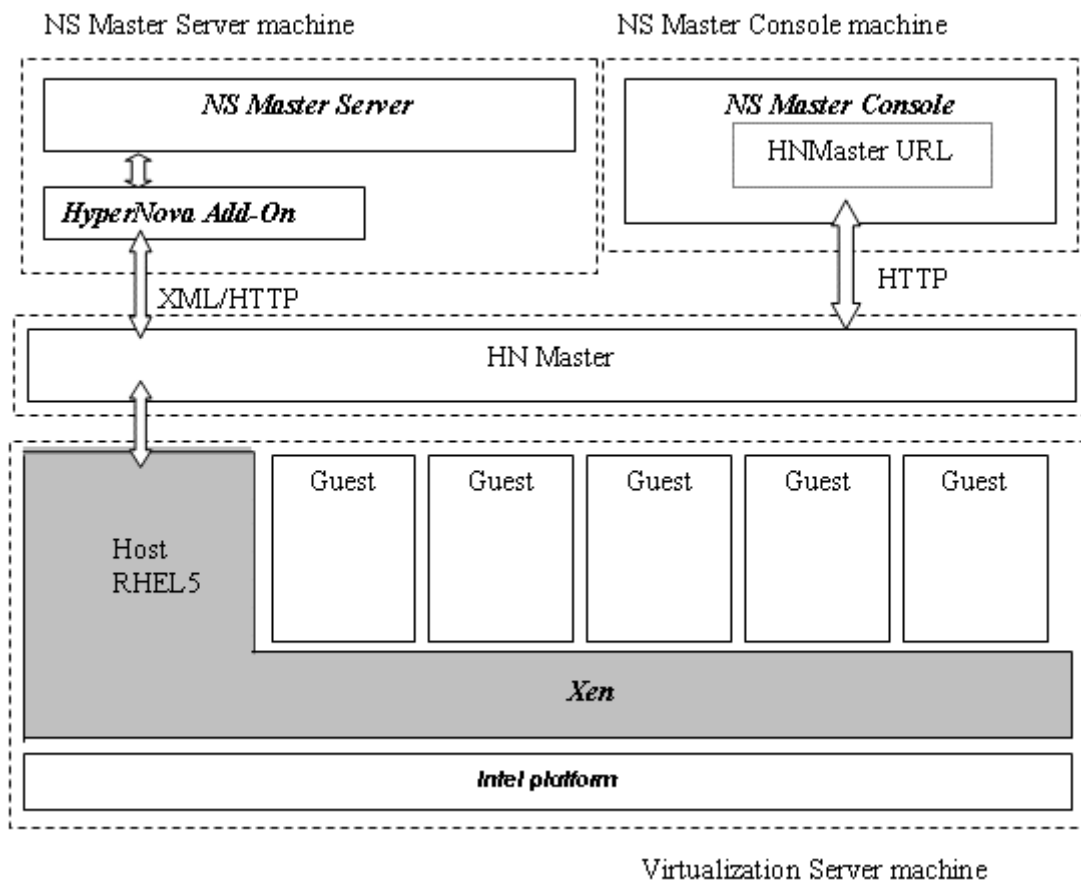

Figure 3-14. HyperNova Add-On components

3.3.3.2 NovaScale Master Configuration

To configure the monitoring elements for the HyperNova Add-On, you have to define an HyperNova Virtualization Platform from the NovaScale Master Configuration GUI. Native OS, VMs and related monitoring services are defined in one easy step.

The native OS is represented by a NSMaster host with the OS: **Xen**.

VMs are represented by a NSMaster host with the model: **HyperNova**.

3.3.3.2.1 HyperNova Virtualization Platform

To configure a HyperNova Virtualization Platform, click the **HyperNova** link in the Virtualization part of the Topology domain. The list of all configured platforms appears, as in the following example:

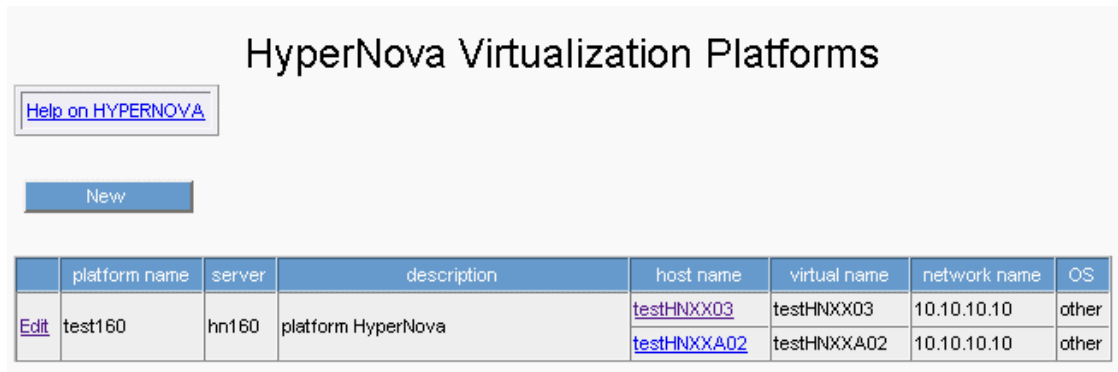

Figure 3-15. HyperNova Virtualization Platforms page

It is possible:

- To create a new HyperNova Virtualization Platform using the **New** button
- To edit or delete a resource using the **Edit** link
- To edit a virtual host using the **<hostname>** link.

When you click the **New** button, the following display appears with all resource properties:

Figure 3-16. HyperNova Platform Properties

Besides the characteristics (name and description) of the main object, the properties of an HyperNova virtual platform are divided into two-parts:

- **Virtualization Server:** used to define the physical machine and the native OS.
- **Virtual Machines:** used to describe the HyperNova platform virtual machine.

Virtualization Server Properties

- name** Server host short name.
This name is displayed in the NovaScale Master Console views.
Click **Select** to choose a defined host from the NSMaster host list.
- model** Host model (see the *NovaScale Master Administrator's Guide* for values).
- network name** Server network name (hostname or IP address).

Virtual Machines Properties

- Virtual Machines** List of the VMs established by selecting the VMs obtained by XML/HTTP requests to HN Master.
The request is performed by clicking the **Discover** button (or **Re-discover** if in edition mode).
See below the complete description of the procedure.

Virtual Machines Discovery

The result of the discovery is displayed as a table composed of three parts:

- the left column allows you to select the VMs to be associated to the platform
- the center part displays Virtual Machine Configuration as defined on the virtualization server
- the right part allows you to edit the main properties (name, network name and OS) of the corresponding NSMaster host. The host can be edited only if the corresponding VM is selected. You can select an already defined host by clicking the select button or you can create a host by completing the corresponding fields.

<input checked="" type="checkbox"/>	HyperNova Virtual Machines		NS Master Configuration			
	Name	Type	Name		netName	OS
<input checked="" type="checkbox"/>	Rhel5Para	Para	<input type="text" value="Rhel5Para"/>	<input type="button" value="Select"/>	<input type="text" value="Rhel5Para"/>	<input type="text" value="other"/>
<input checked="" type="checkbox"/>	Rhel5VT	Full	<input type="text" value="Rhel5VT"/>	<input type="button" value="Select"/>	<input type="text" value="Rhel5VT"/>	<input type="text" value="other"/>
<input checked="" type="checkbox"/>	win2003	Full	<input type="text" value="win2003"/>	<input type="button" value="Select"/>	<input type="text" value="win2003"/>	<input type="text" value="other"/>
<input checked="" type="checkbox"/>	Win2003s	Full	<input type="text" value="Win2003s"/>	<input type="button" value="Select"/>	<input type="text" value="Win2003s"/>	<input type="text" value="other"/>

To update the list of virtual machines, click the Re-discover button

Figure 3-17. Virtual Machines display after Discover step

Notes:

- When you select an already defined host, you cannot change its network name and OS. But, The Select contains a Default Option that correspond to the VM name, that can be edited.
- If the VM name contains space(s), they are replaced by underscore(s) in the host label.

Virtual Machines Re-Discovery

Re-Discovery is required to check that the current NSMaster configuration still matches the HyperNova configuration in order to:

- Add virtual machine not yet registered in the HyperNova Virtualization Platform
- Remove virtual machine no more defined in the HyperNova configuration.

During the Re-discovery step, if the current configuration is not compatible with HyperNova configuration the invalid VMs are displayed in red and the VMs not referenced in the current NSMaster configuration are displayed in green, as shown in the following figure:

<input type="checkbox"/>	HyperNova Virtual Machines		NS Master Configuration		
	Name	Type	Name	netName	OS
<input checked="" type="checkbox"/>	testHNXXA02	Para	testHNXXA02 <input type="text"/> <input type="button" value="Select"/>	10.10.10.10	other <input type="button" value="v"/>
<input checked="" type="checkbox"/>	testHNXXA04	Full	testHNXXA04 <input type="text"/> <input type="button" value="Select"/>	10.10.10.10	other <input type="button" value="v"/>
<input checked="" type="checkbox"/>	testHNXXA05	Full	testHNXXA05 <input type="text"/> <input type="button" value="Select"/>	10.10.10.10	other <input type="button" value="v"/>
<input type="checkbox"/>	testVMrm	Full	testVMrm <input type="text"/> <input type="button" value="Select"/>	10.10.10.10	other <input type="button" value="v"/>
<input checked="" type="checkbox"/>	VM1	Para	VM1 <input type="text"/> <input type="button" value="Select"/>	172.31.35.170	other <input type="button" value="v"/>
<input checked="" type="checkbox"/>	VM2	Para	VM2 <input type="text"/> <input type="button" value="Select"/>	172.31.35.171	other <input type="button" value="v"/>
<input checked="" type="checkbox"/>	VM3	Para	VM3 <input type="text"/> <input type="button" value="Select"/>	172.31.35.172	other <input type="button" value="v"/>
<input checked="" type="checkbox"/>	VM4	Para	VM4 <input type="text"/> <input type="button" value="Select"/>	172.31.35.173	other <input type="button" value="v"/>
<input checked="" type="checkbox"/>	VMA	Para	VMA <input type="text"/> <input type="button" value="Select"/>	172.31.35.174	other <input type="button" value="v"/>
<input type="checkbox"/>	shared_para_RHEL5	Para	shared_para_RHEL5 <input type="text"/> <input type="button" value="Select"/>	10.10.10.10	other <input type="button" value="v"/>
<input type="checkbox"/>	testHNXX03	Full	testHNXX03 <input type="text"/> <input type="button" value="Select"/>	10.10.10.10	other <input type="button" value="v"/>
<input type="checkbox"/>	testVMfullvide	Full	testVMfullvide <input type="text"/> <input type="button" value="Select"/>	10.10.10.10	other <input type="button" value="v"/>
<input type="checkbox"/>	testVMparasansOS	Para	testVMparasansOS <input type="text"/> <input type="button" value="Select"/>	10.10.10.10	other <input type="button" value="v"/>
<input type="checkbox"/>	VMA_BIS	Para	VMA_BIS <input type="text"/> <input type="button" value="Select"/>	VMA_BIS	other <input type="button" value="v"/>
<input type="checkbox"/>	VMA_CR17	Para	VMA_CR17 <input type="text"/> <input type="button" value="Select"/>	VMA_CR17	other <input type="button" value="v"/>

Figure 3-18. Virtual Machines display after Re-iscover step

VMs no longer defined in HNmaster are automatically unchecked and will be removed from the platform on form validation. New VMs must be explicitly checked for being added in the platform to be linked to the platform on form validation.

 **Note:**

How to Add, Delete or Modify Virtual Machine is detailed in 3.3.3.2.2 *Virtual Machine Edition*, on page 41.

After edition:

- Click the **OK** button to validate your edition
- Or click **Cancel** to return to Virtual Platforms pages without changes
- Or click **Delete** to remove the Virtual Platform and maintain the hosts corresponding to the VMs and the Virtualization server
- Or click **DeleteAll** to remove the Virtual Platform and the hosts corresponding to the VMs and the Virtualization server.

 **Note:**

Edition with a **Topology modification** requires confirmation: a page listing all modifications to be applied to the Topology configuration is displayed, as shown in the following figure.

HyperNova Virtualization Platform

Host Topology Modification

Configuration of the HyperNova Platform will lead to the following modification in Host Topology:

- 172.31.35.130 host will be created as Virtualization server (OS Xen).
- creation of RHEL5Para host (model HyperNova): add to platform with vmlid RHEL5Para.
- creation of RHEL5VT host (model HyperNova): add to platform with vmlid RHEL5VT.
- creation of win2003 host (model HyperNova): add to platform with vmlid win2003.
- creation of Win2003s host (model HyperNova): add to platform with vmlid Win2003s.

Do you agree ?

Figure 3-19. Host Topology modification confirmation

If you do not agree, click the **NO** button to return to the platform edition page, otherwise click the **YES** button to create the virtual platform.

Related HyperNova Virtualization platform Objects

When an HyperNova Virtualization platform is defined, related objects are automatically generated to configure the specific Supervision linked to this type of NovaScale server. The following table describes the objects generated during the creation the platform.

Type	Description
host HyperNova	As defined in the Virtual Machine configuration part of the edition page.
host HNMmaster	Host corresponding to the virtualization layer and hosting the HNMmaster application, as defined in the Virtualization Server configuration part.
hostgroup	hostgroup representing the physical platform, named <platformName>.
manager	Virtualization manager representing the management interface, named < platformName>_HNMmaster
categories and services	The HyperNova category and related services are instantiated for the HNMmaster host. The VirtualMachine category and related services are instantiated for each HyperNova host.

 **Note:**

A hostgroup representing the virtual platform, a virtualization manager and instances of services for the virtualization server (**HyperNova** category) and for the hosts representing the virtual machine (**VirtualMachine** category) are also created

3.3.3.2.2 Virtual Machine Edition

A virtual machine is represented by a host linked to the HyperNova Virtualization platform. It has properties linked to the platform and properties of a host object.

Add, remove or modification of properties linked to the platform must be done from the HyperNova Virtualization platform edition page.

Modification of host properties must be done from the Host edition page.

Add a virtual machine to a platform

Add of a virtual machine is performed by checking the corresponding line in Virtual Machines part of the platform edition form and setting the host characteristics in NSMaster Configuration table zone (by filling in the corresponding fields or by selecting an already defined host).

 **Note:**

When you edit a Virtualization platform, only the Virtual Machines defined as part of the NovaScale Master platform are displayed. To add virtual machine, you must performs a Re-discovery to get the list of all machines defined on the Virtualization Server.

Remove a virtual machine from a platform

Remove a virtual machine is performed by unchecking the corresponding line in the Virtual Machines part of the platform.

 **Note:**

The corresponding host remains in the NovaScale Master definition with model set to other. To delete it, click the 'Other Hosts' link to get the list of all Other Hosts configured, edit the corresponding host and click on Delete button.

Modify a virtual machine defined in a platform

To modify the name of the NSMaster host corresponding to a virtual machine, enter the new name in the corresponding field or choose it in the list of already defined hosts in NovaScale Master by clicking the Select button.

To modify other characteristics as netName or OS, Host edition form must be used.

 **Note:**

To get the Host edition form corresponding to the virtual machine, click the Hostname link displayed in the global platforms page.

Delete all virtual machines and corresponding hosts.

To delete all virtual machines and corresponding hosts, use the **DeleteAll** button of the Virtualization Platform Edition form. Beware: the virtualization server and the platform will be also deleted from the NovaScale Master configuration.

3.3.3.2.3 Virtualization Supervision

As specified above, services are instantiated for each host defined in the Virtualization Platform. You can disable virtualization supervision by editing the hostgroup or manager properties or by editing each service (refer to the *NovaScale Administration Guide* for details).

Monitoring Services

Monitoring services defined for the native OS are associated with the **HyperNova** category.

Services Applied to the Native OS

Service	Description	Check_command
Status	Checks global status	check_hn_server_status

Monitoring services defined for VM hosts are associated with the **VirtualMachine** category.

Services Applied to the VM Host

Service	Description	Check_command
Status	Checks VM status	check_hn_vm_status

Monitoring services related to Virtual Platform elements are automatically created during the edition of the HyperNova Virtualization Platform. These services can be displayed and edited from the Services page in the Supervision domain, but only the attributes related to monitoring or notification can be edited.

Properties	
category	VirtualMachine
name	Status
description	checks the virtual machine status (automatically generated)
model	HyperNova
OS family	any
host list expression	testHNXXA02
Monitoring attributes	
status	<input checked="" type="radio"/> active <input type="radio"/> inactive
Monitoring command attributes (for this service)	
check command	check_hn_vm_status
check command parameters	172.31.35.160@testHNXXA02
monitoring period	24x7
polling interval	5 mn (5 mn by default if empty)
Notification attributes (for this service)	
e-mail contact groups	<div style="display: flex; justify-content: space-between;"> <div> <p>Selected Objects</p> <ul style="list-style-type: none"> mgt-admins </div> <div style="text-align: center;"> <p><= Add</p> <p>Remove =></p> </div> <div> <p>All Objects</p> <ul style="list-style-type: none"> mgt-admins </div> </div>
enable Bull autocall	<input type="radio"/> Yes <input checked="" type="radio"/> No
enable SNMP trap	<input checked="" type="radio"/> Yes <input type="radio"/> No
notification period	24x7
re-notification interval	0 mn (0 mn by default if empty)
notify if warning	<input checked="" type="radio"/> Yes <input type="radio"/> No
notify if critical	<input checked="" type="radio"/> Yes <input type="radio"/> No
notify if recovery	<input checked="" type="radio"/> Yes <input type="radio"/> No

Figure 3-20. Virtual Machine Properties pane



Note:

During HyperNova Platform definition, all services are defined and activated for the server and for each VM. To deactivate the monitoring of one service, set **status** (Monitoring attributes part) to inactive.

3.3.3.3 Nagios Check Commands

check_hn_server_status

The configurable NovaScale Master service check command syntax is:

```
check_hn_server_status
```

See the **check_NSM_hypernova_xen** command in Appendix A for parameters details.

`check_hn_vm_status`

The configurable NovaScale Master service check command syntax is:

```
check_hn_vm_status!<hypernova_server>!<vmname>
```

See the `check_NSM_hypernova_xen` command in Appendix A for parameters details.

3.3.3.4 NovaScale Master Console

Operation

From the Virtual Manager or from any element of the Virtual Platform, you can launch the **HN Master Web Interface** by selecting the following cascading menu:

Operation → **Application** → **HN Master**

3.3.3.5 HyperNova Monitoring

From the platform or host elements, you can access monitoring information.

From the hosts element, you can display information related to associated services by selecting **Monitoring** menus.

From the platform element, you can display monitoring information related to all elements by selecting **Monitoring** menus. For instance, you can view all services of the hosts in the platform, as shown in the following figure:

	All	Problems	Up	Down	Unreachable	Pending	
Host Selection	3	0	3	0	0	0	
	All	Problems	Ok	Warning	Unknown	Critical	Pending
Selected Host Services	6	0	6	0	0	0	0

Click status links to display the selected hosts and services

Service details

Last Updated: 23-07-2007 14:56:41
 Updated every 120 seconds

Host ↑↓	Service ↑↓	Status ↑↓	Last Check ↑↓	Duration ↑↓	Information
hn160	HyperNova.GlobalStatus	OK	0d 0h 0m 51s ago	3d 3h 22m 42s	Nothing to report
	PING	OK	0d 0h 3m 49s ago	3d 3h 21m 26s	PING OK - Packet loss = 0%, RTA = 0.00 ms
testHNXX03	PING	OK	0d 0h 2m 15s ago	0d 2h 36m 58s	PING OK - Packet loss = 0%, RTA = 0.00 ms
	VirtualMachine.Status	OK	0d 0h 0m 54s ago	3d 3h 23m 7s	VM inactive
testHNXXA02	PING	OK	0d 0h 4m 49s ago	1d 19h 45m 2s	PING OK - Packet loss = 20%, RTA = 0.00 ms
	VirtualMachine.Status	OK	0d 0h 2m 11s ago	3d 3h 20m 37s	VM inactive

6 Matching Service Entries Displayed (filter: Service Status **PENDING OK WARNING UNKNOWN CRITICAL**)

Figure 3-21. Virtual Platform monitoring

3.4 Bull Products Server Addons

3.4.1 NSMasterDD4A for Bull “Dynamic Domains for Applications” Management

The **Dynamic Domains for Applications (DD4A)** software is a tool that can be used on the Linux operating system for simulating the partitioning of a multi-CPU machine at application level. Dynamic Domains for Applications can be used with standard Linux distributions and can be managed using the Webmin standard administration tool.

See the *Dynamic Domains for Applications User’s Guide* (ref 86 A2 63ER) for more information.

You can install DD4A from the *Bull Extension Pack for RedHat CD* (ref 76741846-xxx).

 **Note:**

DD4A runs only on Linux machines and uses a Webmin module for its management. You can download the prerequisite Webmin package from the web site: <http://www.webmin.com>

This Add-On creates monitoring links between NovaScale Master and the **DD4A** management webmin module.

The following figure shows the different components used for monitoring:

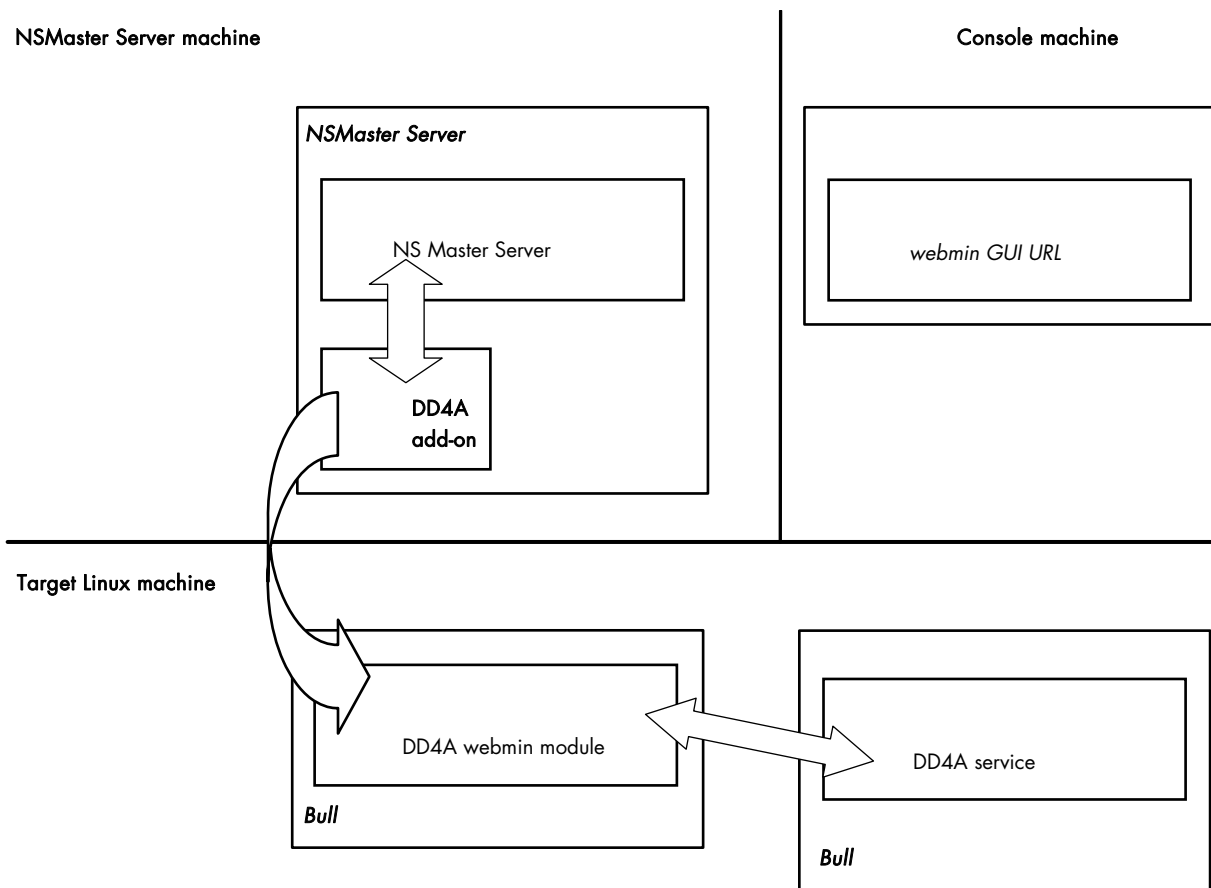

Figure 3-22. DDA4 Monitoring Components

NovaScale Master Server Add-Ons provides the default Bull product categories by Management Package described below.

3.4.1.1 Default Categories & Services Proposed for Linux Hosts

Targeted OS	Model	Category	Service	Check command
Linux	Any	DynamicDomains	All	check_dd4a
			Default	

Table 3-4. DD4A categories and services

3.4.1.2 DynamicDomains Category

All Service

For NovaScale and Express5800 Linux hosts with the Dynamic Domains management tool. This service dynamically checks global status reported by the associated webmin module for all defined Dynamic Domains.



Note:

There is no need to reconfigure the tool to survey new defined Dynamic Domains.

default Service

For NovaScale and Express5800 Linux hosts with the Dynamic Domains management tool. This service checks the status of the default Dynamic Domain.



Note:

When creating a new Dynamic Domain, statically clone the default monitoring service to survey the new dynamic domain.

3.4.1.3 check_DynamicDomains (Linux OS) Nagios Command

The configurable NovaScale Master service check command syntax is:

```
check_DynamicDomains!<{ALL|<DomainName>}
```

Default syntax for **DynamicDomains.All**:

```
check_DynamicDomains!ALL
```

Default syntax for **DynamicDomains.default**:

```
check_DynamicDomains!default
```

3.4.2 NSMasterBVS for Bull Video Services Management

Bull Video Services (BVS) software is a tool that can be used with standard Linux distributions and Windows and can be managed using Web server.

See the *Bull Video Services User's Guide* for more information.

You can install BVS from the Bull Video Services CD (ref 36673900-xxx).



Note:

BVS 4.1 runs on Linux and Windows machines and uses an integrated Web server for management.

This Add-On creates monitoring links between NovaScale Master and the **BVS** management Web server module.

The following figure shows the different monitoring components:

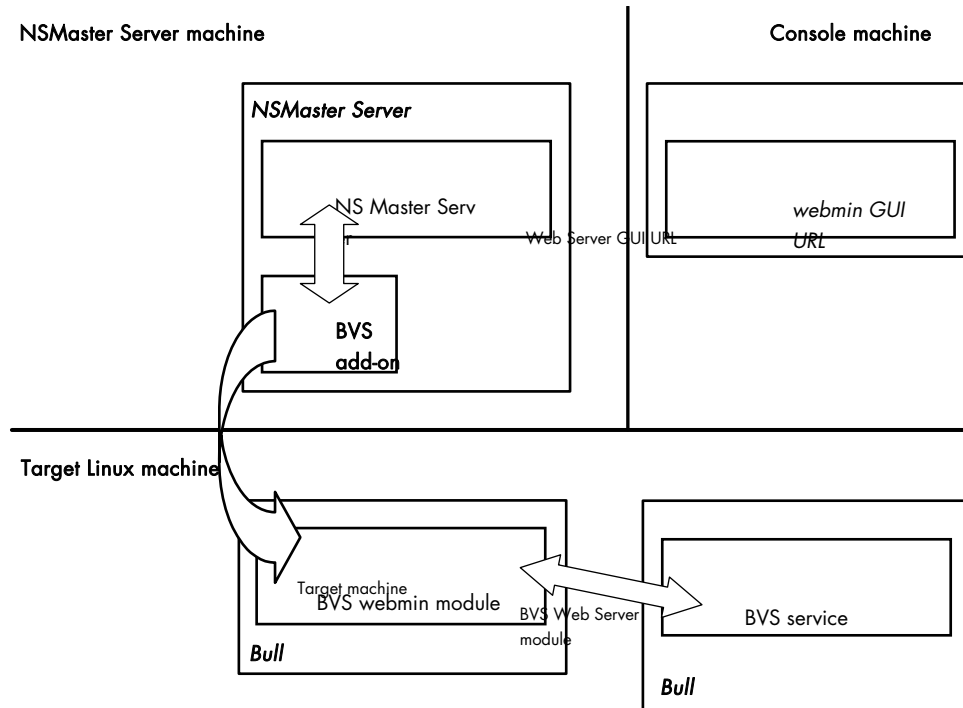

Figure 3-23. BVS Web Server Monitoring Components

Targeted OS	Model	Category	Services	Check command
Linux	any	BullVideoServices	Streaming	check_BullVideoServices
Windows			Recording Datagrams	

Table 3-5. Bull Video Services categories and services

3.4.2.1 BullVideoServices Category

Streaming For NovaScale hosts acting as Bull video server. This service checks the status of the video streaming service.

Recording For NovaScale hosts acting as Bull video server. This service checks the status of the video recording service.

Datagrams For NovaScale hosts acting as Bull video server. This service checks the status of the video datagram errors.

3.4.2.2 check_BVS Nagios Command

The configurable NovaScale Master service check command syntax is:

```
check_BVS!<serviceName>
```

See the **check_BVS** command, in Appendix A for parameters details.

For instance, Default syntax for **BullVideoService.Streaming** is:

```
check_BVS!Streaming
```

3.4.3 NSMasterJOnAS for JOnAS Management

3.4.3.1 JOnAS Overview

JOnAS is a pure Java, open source, application server. Its high modularity allows to it to be used as:

- A J2EE server, for deploying and running EAR applications (i.e. applications composed of both web and ejb components)
- An EJB container, for deploying and running EJB components (e.g. for applications without web interfaces or when using JSP/Servlet engines that are not integrated as a JOnAS container)
- A WEB container, for deploying and running JSPs and Servlets (e.g. for applications without EJB components).

The JOnAS architecture is illustrated in the following figure, showing WEB and EJB containers relying on JOnAS services.

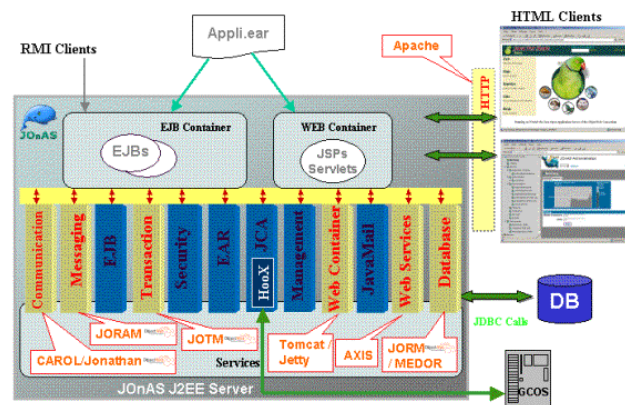

Figure 3-24. JOnAS Architecture

See <http://jonas.objectweb.org/doc/index.html> for more information.

3.4.3.2 JOnAS Domain Topology

A JOnAS management domain is composed of a set of JOnAS servers that are running under the same management authority. All the servers in the domain must have a distinct **server name** and a common **domain name**.

The servers in a domain can be administered by a management application running on a server playing the role of **administrator** or **master**. The managed servers play the role of **slaves**.

A default domain configuration is provided in `$JONAS_ROOT/conf/domain.xml`. This configuration corresponds to a domain named **jonas** managed by a server also named **jonas**.

JOnAS administrators are responsible for the configuration and administration of JOnAS servers running within a management domain.

3.4.3.3 JOnAS Monitoring Information

NovaScale Master retrieves domain and server monitoring information from JOnAS (administrator or master) server via the WEB services.



Note:

WEB services are operational only if the “**conf/server.xml**” file on JOnAS (administrator or master) server is correctly configured as:
The **localhost** value must be replaced by the **DNS host name**.

3.4.3.4 NovaScale Master Configuration

JOnAS configuration for NovaScale Master is available from the configuration GUI by selecting **Third-Party Application** → **JOnAS**.

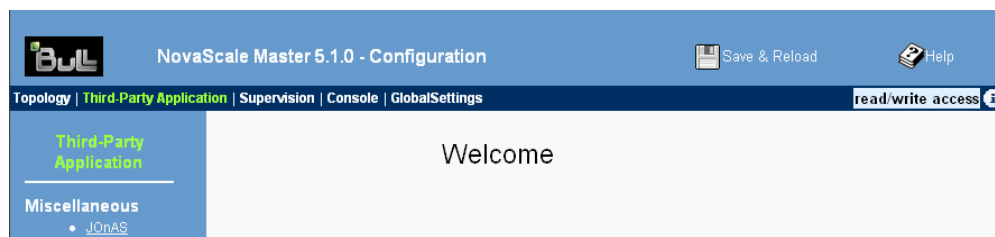

Figure 3-25. JOnAS configuration

JOnAS Domain Definition

To display the JOnAS domains already defined, click **Third-Party Application** → **JOnAS**.

[New Domain](#)

	Domain name	Description	Host name	Admin server	Other servers
Edit	jonas	N/A	charly4L	jonas	none
Edit	jonas	N/A	frcls6260	instance1	instance2,instance3
Edit	jonas	N/A	nsmaster	jonas	none

Figure 3-26. JOnAS domains

To edit a domain, click **Edit**.

To define a new JOnAS domain in the NovaScale Master configuration database, click the **New Domain** button and initialize the following attributes:

JOnAS Domain Attributes

[Help on JOnAS Domain attributes](#)

[OK](#) [Cancel](#)

Properties

domain name

description

Domain information access

host name

port number

Authentication

user name

password confirm

Domain monitored Servers

admin server name

master server Yes No

Figure 3-27. JOnAS properties

domain name name of JOnAS domain

description description of the domain

Domain information access

host name name of the host

port number port number

user name name of the user

password password

Domain monitored Servers

admin server name name of JOnAS administrator or master server

master server master server flag

If the master server flag is set to **Yes**, the **Get Servers** button is displayed:

The screenshot shows a form with two main sections. The top section is labeled 'master server' and contains two radio buttons: 'Yes' (which is selected) and 'No'. The bottom section is labeled 'other servers' and contains a 'Get servers' button and a text instruction: 'Click on "Get servers" to get the servers managed in the domain'.

Click the **Get Servers** button to list all the servers belonging to the specified domain:

The screenshot shows the 'Domain monitored Servers' form after the 'Get servers' button has been clicked. The 'admin server name' field is set to 'instance1' and the 'master server' field is set to 'Yes'. Below these fields, there are two columns: 'Selected Servers' and 'All Servers'. The 'Selected Servers' column contains a list box with 'instance2' and 'instance3' selected. The 'All Servers' column contains a list box with 'instance2' and 'instance3'. Between the two columns are two buttons: '<= Add' and 'Remove =>'. The '@' symbol is visible at the bottom right of the screenshot.

other servers the selected servers will be monitored by NovaScale Master.

3.4.3.5 JOnAS Category and Service

The definition of a domain creates or updates a **JOnAS** category and creates one service by JOnAS server identified by the JOnAS server name.

[-] JOnAS : JOnAS monitoring (automatically generated)	OS any	charly4L, nsmaster, frcls6260	[]
clone modify withdraw All []			
instance2	OS any	frcls6260	[]
instance3	OS any	frcls6260	[]
instance1	OS any	frcls6260	[]
jonas	OS any	nsmaster	[]
jonas	OS any	charly4L	[]

Figure 3-28. JOnAS category and services

The `check_NSM_JOnAS` command defined for the service, returns the state of the server (**RUNNING**, **STOPPED**, **FAILED**, **UNREACHABLE**). If the server is running, the following attributes are returned:

- Threads count

- Memory allocated and used
- HTTP requests count
- Committed transactions count

3.4.3.6 JOnAS Reporting Indicators

Threads and **MemoryUsed** indicators are created for each JOnAS service.

The **Threads** indicator returns the current threads count.

The **MemoryUsed** indicator returns the current memory used.

	host	name	collect mode	source	status
Edit	charly4L	JOnASjonas.MemoryUsed	NSM_monitoring	JOnAS.jonas	active
Edit	charly4L	JOnASjonas.Threads	NSM_monitoring	JOnAS.jonas	active

Figure 3-29. JOnAS indicators

3.4.3.7 NovaScale Master Console

JOnAS Monitoring Representation

The JOnAS category groups services monitoring for all the servers in the domain.

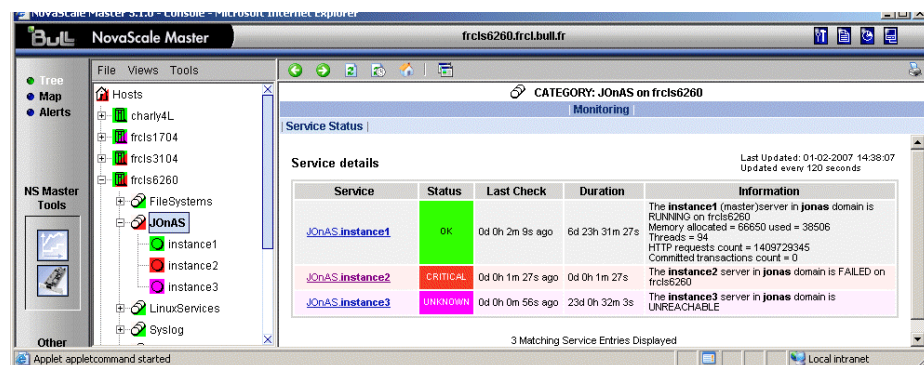

Figure 3-30. JOnAS category view

Launching the jonasAdmin Application

The JOnAS administration tool, **jonasAdmin**, can be contextually launched from a host node on the NovaScale Master console by clicking:

Operations → **Application** → **jonasAdmin**

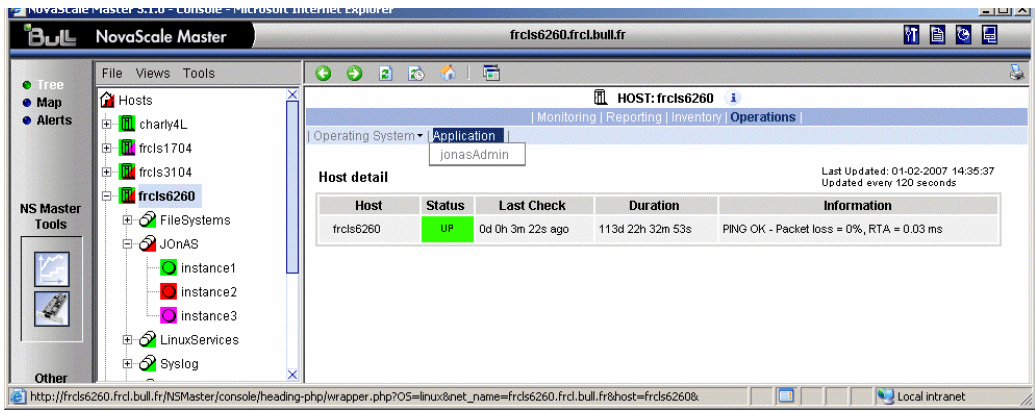

Figure 3-31. jonasAdmin launching

Appendix A. Check Commands for Customizable Services of Add_ons

This chapter describes the usage of the check commands by customizable services. These commands are Linux commands. They run only under CYGWIN on Windows.

Internal Storage Management

NSMasterGAMTT

check_gamttRAID

check_gamttRAID uses the following shell (PERL) command:

Usage

```
check_gamttraid -H <host> [-C <community>] [-p <port>] [-t <timeout>]
{ [-A {ALL|<Ct>}] | [-P {ALL|<Ct>.<Ch>.<Tg>}] | [-L {ALL|<Ct>.<Ldn>}] }
[-v <vl>] [-f <f>]
```

-H, -hostname <host>	Hostname or IP address of target to check
-C, -community <community>	SNMP community string (defaults to "public")
-p, -port <port>	SNMP port (defaults to 161)
-t, -timeout <timeout>	Seconds before timing out (defaults to Nagios timeout value)
-A, -adapter ALL <Ct>	Controller board
-P, -physical ALL <Ct>.<Ch>.<Tg>	Physical device addr
-L, -logical ALL <Ct>.<Ldn>	Logical drive addr
-v, -verbosity <vl>	Verbosity level: "0" None "1" Adds the <CtrlModel> and the status of all controller boards filtered
-f, -format <f>	"0" Carriage Return in ASCII mode (\n) "1" Carriage Return in HTML mode ()

Return code

"OK" (0), "WARNING" (1), "CRITICAL" (2), "UNKNOWN" (3)

- "OK":
All "logical drives" and all "physical devices" run normally.

- "WARNING":
At least one "logical drive" or one "physical device" is in a "WARNING" state.
- "CRITICAL":
At least one "logical drive" or one "physical device" is in a "CRITICAL" state.
- "UNKNOWN"
All other types of processing errors (bad parameter, no response, and so on...).



Note:

In the case of multiple errors, the global state will be the worst one; "CRITICAL" > "WARNING" > "OK".

Output

A string composed with a global state descriptor followed, if they exist, by error states of concerned component (controller, Logical Device, Physical Device).

global state descriptor:

The first line shows the global state. The syntax is:

```
GAMTT RAID [CT | PD | LD ]<GlobalStatus>
"CT " if "-A".
"PD " if "-P".
"LD " if "-L".
```

state descriptor by controller

They may be present after the global state descriptor if an error exists.

The syntax is:

```
[ CT(Ct<Ct>) <CtrlModel> <CtrlStatus>
  [{LD(Ct<Ct> Nu<Ldn>) <LDType> <LDStatus>[, ] ...}]
  [{PD(Ct<Ct> Ch<Ch> Tg<Tg>) <PDType> <PDStatus>[, ] ...}]
  ...]
```

<GlobalStatus>	worst detected status
<CtrlModel>	controller model
<CtrlStatus>	worst state detected for an element of this controller (LD and PD)
<Ct>	controller number
<Ldn>	"logical drive" number
<LDType>	"logical drive" type: "RAIDx" or "JBOD"
<LDStatus>	"logical drive" status
<Ct>	controller number
<Ch>	"channel" number
<Tg>	target number
<PDType>	"physical device" type: "Disk", "Processor", "Ctrl Channel", •
<PDStatus>	"physical device" status

Examples:

- If global state is "OK":
> check_gamttraid -H <host>
GAMTT RAID OK
>

```

> check_gamttraid -H <host> -P 0.0.1
GAMTT RAID PD OK
>
> check_gamttraid -H <host> -L 0.0
GAMTT RAID LD OK
>
> check_gamttraid -H <host> -v 1
GAMTT RAID OK
CT(Ct0) MegaRAID Ultra320-2x OK
CT(Ct1) DAC960FFX2 OK
CT(Ct2) MegaRAID Ultra320-2x OK
>
> check_gamttraid -H <host> -A 1 -v 1
GAMTT RAID CT OK
CT(Ct1) DAC960FFX2 OK
>

```

- If global state is "CRITICAL" or "WARNING", only concerned elements are displayed:

```

> check_gamttraid -H <host>
GAMTT RAID CRITICAL
CT(Ct0) MegaRAID Ultra320-2x CRITICAL
PD(Ct0 Ch0 Tg1) Disk Dead
>
> check_gamttraid -H <host> -L 0.1
GAMTT RAID LD CRITICAL
CT(Ct0) MegaRAID Ultra320-2x CRITICAL
LD(Ct0 Nu1) RAID5 Critical
>

```

- If return code is "UNKNOWN":

```

> check_gamttraid -H <host>
GAMTT RAID UNKNOWN - snmp query timed out
>

```

NSMasterLSICIM

check_LSICIM

check_LSICIM uses the following shell (PERL) command:

Usage

```
check_LSICIM -H <host> [-C <ctrlname>]
```

-H, -hostname <host> Hostname or IP address of target to check

-C, -ctrlname <ctrlname> Name of the controller to check



Note:

The name of the controller must be protected with a quote if the name contains blank characters.

Return code

"OK" (0), "WARNING" (1), "CRITICAL" (2), "UNKNOWN" (3)

- "OK":
All "Controllers" run normally.
- "WARNING":
At least one "Controllers" is in a "WARNING" state.
- "CRITICAL":
At least one "Controllers" is in a "CRITICAL" state.
- "UNKNOWN"
All other types of processing errors (bad parameter, no response, etc...).



Note:

In the case of multiple errors, the global state will be the worst one; "CRITICAL" > "WARNING" > "OK".

Output

A string indicates the state of mirroring followed, where applicable, by concerned component error states (controller, Logical Device, Physical Device).

If the GlobalStatus determined by the worst status of components is not OK, the state of the component is reported with the following format:

```
[CT(Ct<Ct>) <CtrlName> <CtrlStatus>
[ {> LD(Ct<Ct> Nu<Ldn>) <LDType> <LDStatus>[, ] ...}]
[ { - PD(Ct<Ct> Ch<Ch> Tg<Tg>) <PDManufacturer> <PDModel> <PDStatus>[, ] ...}]
[ {> PD(Ct<Ct> Ch<Ch> Tg<Tg>) <PDManufacturer> <PDModel> <PDStatus>[, ] ...}]
```

<Ct> controller number
<CtrlModel> controller model
<CtrlStatus> worst state detected for an element of this controller (LD and PD)

<Ldn> "logical drive" number
 <LDType> "logical drive" type: IM
 <LDStatus> "logical drive" status as reported by the LSI CIM provider
 <Ch> "channel" number
 <Tg> target number
 <PDManufacturer> "physical device" manufacturer
 <PDModel> "physical device" model
 <PDStatus> "physical device" status as reported by the LSI CIM provider

Examples:

```

$ ./check_LSICIM -H 172.31.50.71
: LSI SCSI storage - Integrated Mirroring not available -

LSI SCSI storage - Integrated Mirrored available -
CT(0) LSI 53C1030 CRITICAL
> LD(Ct0 Ch2 Tg0) IMVolume: Degraded Redundancy
  - PD(Ct0 Ch3 Tg0) SEAGATE ST373454LC: Error

$ ./check_LSICIM -H 172.31.50.71 -C 'LSI SCSI1030 - 0'

> CT(0) LSI 53C1030 OK

$ ./check_LSICIM -H 172.31.50.71 -C 'LSI SCSI1030 - 0'
> CT(0) LSI 53C1030 CRITICAL
  - PD(Ct0 Ch0 Tg0) MAXTOR ATLAS10K4_36SCA CRITICAL
  
```

External Storage Management

NSMasterStoreWayFDA

check_NECFDA

check_NECFDA uses the following shell (PERL) command:

Usage

```
check_necfda -H <host> [-C <community>] [-p <port>] [-t <timeout>]
[-f <f>]
```

-H, -hostname <host>	Hostname or IP address of the target to check
-C, -community <community>	SNMP community string (defaults to "public")
-p, -port <port>	SNMP port (defaults to 161)
-t, -timeout <timeout>	Seconds before timing out (defaults to Nagios timeout value)
-f, -format <f>	"0" Carriage Return in ASCII mode (\n) "1" Carriage Return in HTML mode ()

```
check_necfda -help
```

-h, -help	Display help
-----------	--------------

```
check_necfda -version
```

-V, -version	Display version
--------------	-----------------

Return code

"OK" (0), "WARNING" (1), "CRITICAL" (2), "UNKNOWN" (3)

Output

The first line shows the global state with the following format:

```
necfda <GlobalStatus>
```

<GlobalStatus> Most severe state detected on a controller.

Examples:

- If the global state is « OK »

```
> check_necfda -H <host>
necfda OK
>
```

- If the global state is "CRITICAL" or "WARNING", only errors are displayed :
- When the return code is "UNKNOWN":

```
> check_necfda -H <host>
necfda CRITICAL
>
> check_necfda -H <host>
necfda WARNING
>
> check_necfda -H <host>
necfda UNKNOWN - snmp query timed out
>
> check_necfda -H <host>
necfda UNKNOWN - no data received
>
```

Virtualization Management

NSMasterVMwareESX

check_esx3

The Nagios check commands used by NSMasterVMwareESX Add-On uses the shell (PERL) command **check_esx3**.

Usage

```
check_esx3 -H esxname [-N|-M|-B] [-C community] [-v virtualhost]
           [-l thing [-w warn -c crit]] [-t timeout]
```

-H <esxname>	Hostname or IP address of the ESX server to check
-N,-M,-B	set context for check execution -N for Nagios mode, -M for MRTG mode, -B for NSMaster mode.
-C <community>	SNMP community string (defaults to "public")
-v <virtualhost>	name of the virtual host to check
-l <thing>	what to check Available thing are: CPU, MEM, SNMP, STATE, LIST, LISTNET.
-w <warnThreshold>	warning threshold
-c <criticalThreshold>	critical threshold.
-h, -help	Display help

Return code

OK(0), WARNING(1), CRITICAL(2), UNKNOWN(3).

Output:

The output depend on the calling Nagios command. See detailed cases below.

check_esx_server case

The check_esx3 shell is called with the following syntax:

```
check_esx3 -B -H <esxname> -C <community> -l LIST
           -w <warn>% -c <crit>%
```

Output:

VHosts: <nb-up>/<nb-all> up: <VMname> (<status>), .

Example:

```
check_esx3 -H esx -C public -w 50% -c 0%
```

```
VHosts: 2/4 up: nsmvm5 (OFF), nsmvm1 (ON), nsmvm3 (ON), nsmvm4 (OFF)
```

Status is set to **WARNING** if more than 50% of VMs are down.

Status is set to **CRITICAL** if all VMs are down.

Note:

The list of VMs used to establish ESX server status corresponds to all the VMs declared on the ESX server and not only to those declared on the NovaScale Master ESX platform. The VMname is that declared on the VMware ESX server (this name can be different from the NSMaster hostname).

check_esx_snmp case

The check_esx3 shell is called with the following syntax:

```
check_esx3 -B -H <esxname> -C <community> -l SNMP
```

Output:

```
OK          SNMP management interface available
CRITICAL    SNMP management interface not available
```

check_esx_mem case

The check_esx3 shell is called with the following syntax:

```
check_esx3 -B -H <esxname> -C <community> -l MEM -w <warn>% -c <crit>%
```

Output:

```
Memory free: <free>Mb (<percent_free>) [Total available <total>Mb]
```

Example:

```
check_esx3 -H esx -C public -l MEM -w 20% -c 10%
```

```
Memory free: 16111.6Mb (98%) [Total available 16383.6Mb]
```

Status is set to **WARNING** if less than 20% of memory is available.

Status is set to **CRITICAL** if less than 10% of memory is available.

check_esx_vm

The check_esx3 shell is called with the following syntax:

```
check_esx3 -B -H <esxname> -C <community> -v <virtualHost>
-l STATE
```

Output:

```
OK          VHost <VMname>is up (ID: <id>)
CRITICAL   VHost <VMname>is down (ID: <id>)
```

Example:

```
check_esx_vm -H esx -C public -v nsmvm1 -l STATE
```

```
VHost nsmvm1 is up (ID: 48)
```

Status is set to OK if the VM is up.

Status is set to CRITICAL if the VMs are down.



Note:

The VMname is that declared on the ESX server (this name can be different from the NSMaster hostname).

check_esx_vm_memory

The check_esx3 shell is called with the following syntax:

```
check_esx3 -B -H <esxname> -C <community> -v <virtualHost>
-l MEM -w <warn>% -c <crit>%
```

Output:

```
Memory free: <free>Mb (<percent_free>) [Total available <total>Mb] on
vhost <VMname>
```

Example:

```
check_esx_vm_mem -B -H esx -C public -v nsmvm1 -w 20% -c 10%
```

```
Memory free: 460.8Mb (90%) [Total available 512Mb] on vhost smvm1
```

Status is set to **WARNING** if less than 20% of memory is available.

Status is set to **CRITICAL** if less than 10% of memory is available.



Note:

The VMname is that declared on the ESX server (this name can be different from the NSMaster hostname).

check_esx_vm_cpu

The check_esx3 shell is called with the following syntax:

```
check_esx3 -B -H <esxname> -C <community> -v <virtualHost>
-l CPU -w <warn>% -c <crit>%
```

Output:

```
CPU usage is <percent_used> on <VMname> nsmvm1 (<time>average)
```

Example:

```
check_esx_vm_cpu -B -H esx -C public -v nsmvm1 -w 80% -c 90%
```

CPU usage is 3% on nsmvm1 (301s average)

Status is set to WARNING if more than 80% of CPU is used.

Status is set to CRITICAL if if more than 90% of CPU is used.

Note:

The VMname is those declared on the ESX server (this name can be different from the NSMaster hostname).

NSMasterHyperNova

check_NSM_hypernova_xen

The Nagios check commands used by NMasterHyperNova addOns uses the shell (PERL) command `check_NSM_hypernova_xen`.

Usage

```
check_NSM_hypernova_xen -H <hnname> [-m <virtualhost>]
                        [-t timeout]
```

-H <hnname>	Hostname or IP address of the HyperNova server to check
-v <virtualhost>	name of the virtual host to check
-h, -help	Display help

Return code

OK(0), WARNING(1), CRITICAL(2), UNKNOWN(3).

Output:

The output is the StatusText as setting by HNMaster. For the list of values, refer to the HyperNova documentation

Examples

Check_hn_server_status

The `check_NSN_hypernova_xen` shell is called with the following syntax:

```
check_NSN_hypernova_xen -H <hnserver>
```

Output :

StatusText as returned by HNMaster

Example:

```
check_NSN_hypernova_xen -H hnserver
```

Nothing to report

Status is set to OK.

Check_hn_vm_status

The `check_NSN_hypernova_xen` shell is called with the following syntax:

```
check_NSN_hypernova_xen -H <hnserver> -m <virtualhost>
```

Output :

<virtualHost>: StatusText as returned by HNMaster

Example:

```
check_NSN_hypervnova_xen -H hnserver -m VM1
```

```
VM1: VM inactive
```

Status is set to WARNING.

Note:

The VMname is those declared on the HyperNova Server (this name can be different from the NSMaster hostname).

Bull Products Management

NSMasterDD4A

check_DynamicDomains

check_DynamicDomains uses the check_DD4A shell (PERL) command:

Usage

```
check_DD4A -H <host> [-w ] [-D <domainName>]
```

-H, --hostname <host>	Hostname or IP address of target to check
-D, --domain ALL <domainName>	ALL domains or a specific one: <domainName>
-w, --web	WEB HTML output format

Return code

"OK" (0), "WARNING" (1), "CRITICAL" (2), "UNKNOWN" (3)

- "OK":
All "Dynamic Domains" run normally.
- "WARNING":
At least one "Dynamic Domain" is in a "WARNING" state.
- "CRITICAL":
At least one " Dynamic Domain " is in a "CRITICAL" state.
- "UNKNOWN"
All other types of processing errors (bad parameter, no response, etc...).



Note:

In the case of multiple errors, the global state will be the worst one; "CRITICAL" > "WARNING" > "OK".

Output

A string with a global state descriptor followed, if they exist, by error states of the concerned component (controller, Logical Device, Physical Device).

If -D ALL or without -D parameter is used, the first line displays the defined Dynamic Domains number. Then, only Dynamic Domains with issues are displayed with their status, their number of used CPUs, their CPU load (and the associated threshold) and their number of tasks.



Note:

The global state is not displayed textually, only the command return code contains this status information.

If `-D <domainName>` is used, the command output displays the defined Dynamic Domain name with its number of used CPUs, its CPU load (and the associated threshold) and its number of tasks.

Examples:

- `check_DD4A -H <host>`
- `check_DD4A -H <host> -D ALL`
4 Dyn.Domains.
- domain2 : WARNING
CPUs: 4 / 4, tasks: 70
load: 80% (> 75%)
- domain3 : CRITICAL
CPUs: 4 / 4, tasks: 110
load: 100% (> 75%)
- `check_DD4A -H <host> -D default`
default : OK
CPUs: 7 / 8, tasks: 37
load: 0.56% (< 75%)

NSMasterBVS

check_BVS

check_BullVideoServices uses the check_BVS shell (PERL) command:

Usage

```
check_BVS -H <host> -S {Streaming|Recording|Datagrams}
[{-p <period>} | { -l <begin> -t <end> }] [-w]
```

-H, -hostname <host> Hostname or IP address of target to check

-S, -service Streaming|Recording|Datagrams

-p, -period <period> | -l <begin> -t <end>
indicates to the Bull Video Server the period in seconds to calculate the average values

-w, -web WEB HTML output format

Return code

"OK" (0), "WARNING" (1), "CRITICAL" (2), "UNKNOWN" (3)

- "OK":
"Bull Video Server" runs normally.
- "WARNING":
"Bull Video Server" is in "WARNING" state.
- "CRITICAL":
"Bull Video Server" is in "CRITICAL" state.
- "UNKNOWN"
All other type of processing errors (bad parameter, and so on...).

The BVS state "UNREACHABLE" (*Bull Video Server is in " UNREACHABLE " state (daemon not started, communication timeout, ...)*).will be transformed to Nagios "UNKNOWN" status.

The status values (OK, WARNING, CRITICAL) are fixed by the video server itself according to criteria's indicated by a Bull Video Server administrator.

Output

The following information is displayed. Average values are calculated using the value specified by the 'polling interval' textbox from the service configuration screen. The default value is 1 min. A modification of this value will be automatically taken into account by the check_BVS plugin.

'Streaming' service

Status global status of 'Streaming' service

Channels number of channels used for streaming (average)
Rate average rate in MB/s
Load percentage of disk rate in relation to a value declared on BVS server

Example:

```
check_BVS -H <host> -S Streaming
  Status: OK
  channels: 17.00,
  rate (MB/s): 38.84,
  load: 12.69 %
```

'Recording' service

Status global status of 'Recording' service
Channels number of channels used for recording (average)
Rate average rate in MB/s
Load percentage of disk rate in relation to a value declared on BVS server.

Example:

```
check_BVS -H <host> -S Recording
  Status: OK
  channels: 7.00,
  rate (MB/s): 3.84,
  load: 7.69 %
```

'Datagrams' service

Status global status of 'Datagram' service
Nb of late dg number of UDP datagram's sent late per second (average)
Avg late value average delay value in ms. A delay value between 0 and 10 ms is considered as a normal value.
Nb of deleted dg number of deleted UDP datagrams per second (average).

Example:

```
check_BVS -H <host> -S Datagrams
  Status: OK
  nb of late dg: 128.67,
  avg late value: 1.03 ms,
  nb of deleted dg: 3.08
```

Service Inaccessible

In case of inaccessible service only the RC will be displayed.

Example:

```
check_BVS -H <host> -S <service>  
  Status: UNREACHABLE
```

NSMasterJOnAS

Check_JOnAS

Check_JOnAS uses the following shell (PERL) command:

Usage

```
check_JOnAS -H <host> -N <network name> -a <jonas master>  
-d <domain> -s <server> -p <port number> [-u <user> -p <password> ]  
[ -m] -w
```

-H host	host name
-N network name	network name
-a <jonas master>	JOnAS server name Administrator or master
-d <domain>	domain name
-s <server>	target server name
-p <port number>	port number
-u <user name>	user name(mandatory if called outside NSMaster)
-p <password>	password (mandatory if called outside NSMaster)
-m	set if JOnAS server is master
-w	command output in HTML

Return Code

"OK" (0), "WARNING" (1), "CRITICAL" (2), "UNKNOWN" (3)

- "OK":
JOnAS server runs normally.
 - "WARNING":
JonAS server is in "STOPPED" state.
 - "CRITICAL":
JOnAS server is in "FAILED" state.
- "UNKNOWN":
JOnAS server is in "UNREACHABLE" state.

Example:

```
check_JOnAS -H nasmaster -N nsmaster.frcl.bull.fr -a jonas -d  
jonas -s jonas -p 9000  
The jonas server in jonas domain is RUNNING on  
nsmaster.frcl.bull.fr  
Memory allocated = 57700 used = 39949  
Threads = 95  
HTTP requests count = 0  
Committed transactions count = 0
```

```
check_JOnAS -H frcls6260 -N frcls6260.frcl.bull.fr -a
instance1 -d jonas -s instance1 -p 9000 -m
The instance1 (master)server in jonas domain is RUNNING on
frcls6260
Memory allocated = 64315 used = 36359
Threads = 98
HTTP requests count = 478157905
Committed transactions count = 0
```

Index

A

alerts, 1
Alerts Service, 17, 22
All Service, 47
Arm2_4.mib, 22

B

Bull Video Services Management, 47
BullVideoServices Category, 48
BVS, 47

C

check command
 syntax, 55
check_JOnAS, 73
check_BVS, 49, 70
check_DynamicDomains, 47, 68
check_esx_mem, 33, 63
check_esx_server, 32, 62
check_esx_snmp, 33, 63
check_esx_vm, 33, 63
check_esx_vm_cpu, 33, 64
check_esx_vm_memory, 33, 64
check_esx3, 62
check_gamttRAID, 17, 55
check_hn_server_status, 43
check_hn_vm_status, 44
check_LSICIM, 20, 58
check_LSICIM_ctrl, 20
check_NECFDA, 22, 60
check_NSM_hypermova_xen, 66
check_NSM_JOnAS, 52

CIM, 18

commands

- check_JOnAS, 73
- check_BVS, 49, 70
- check_DynamicDomains, 68
- check_esx_mem, 33
- check_esx_server, 32
- check_esx_snmp, 33
- check_esx_vm, 33
- check_esx_vm_cpu, 33
- check_esx_vm_memory, 33
- check_gamttRAID, 17, 55
- check_LSICIM, 20, 58
- check_LSICIM_ctrl, 20
- check_NECFDA, 60
- check_NSM_hypermova_xen, 66
- check_NSM_JOnAS, 52
- ping, 1

CTRLstatus Service, 20

D

Datagrams Service, 49
DD4A, 46
Disk Space
 Requirements, 5
Dynamic Domains for Applications, 46
DynamicDomains Category, 47

E

ESX Virtual Platform, 25

G

GAM, 15
GAMTT, 15
GAMTTraid Category, 17
GUI, 13

- configuration tasks, 13
- starting, 13

H

Hardware Manager, 3
host ESX, 29
host HNMasteR, 40
host HyperNova, 40
host VMware, 29
HyperNova, 35

I

Installation
 Requirements, 5
 Windows, 7
Installation (Linux), 10

J

JOnAS, 49
jonasAdmin, 53

L

LSI 22320 chip, 18
LSI CIM, 18
LSI MegaRAID, 15
LsiCIM Category, 20

M

MegaRAID, 15
megaraid.mib, 17
Memory
 Requirements, 5
MIB, 2
Monitoring Configuration, 13

N

notifications, 1
NSMasterGAMTT, 15
NSMasterHyperNova, 35
NSMasterLSICIM, 18

O

Operating Systems, 5

P

ping command, 1

R

RAIDstatus Service, 20
Recording Service, 48
Restrictions, 6

S

Server Add-On, 3
service, 2
Service
 Cloning, 14
 Creating, 14
 Customization, 13
 Customizing, 14
ServiceStatus, 17, 22
SNMP traps, 2
Storage Manager, 3
Storage Server, 21
StoreWay FDA Management, 21
StoreWayFDA Category, 22
Streaming Service, 48

T

thresholds, 1

U

Uninstallation (Linux), 12

Uninstallation (Windows), 9

Upgrading (Linux), 12

Upgrading (Windows), 9

URL

 NovaScale Master main page, 13

V

virtualization platform, 36

Virtualization Server, 23

Vmware ESX, 24

Technical publication remarks form

Title:	NovaScale Master 5.1 Server Add-ons Installation and Administrator's Guide
---------------	---

Reference:	86 A2 95ER 02
-------------------	---------------

Date:	November 2007
--------------	---------------

ERRORS IN PUBLICATION

--

SUGGESTIONS FOR IMPROVEMENT TO PUBLICATION

--

Your comments will be promptly investigated by qualified technical personnel and action will be taken as required.
If you require a written reply, please include your complete mailing address below.

NAME: _____ DATE: _____

COMPANY: _____

ADDRESS: _____

Please give this technical publication remarks form to your BULL representative or mail to:

Bull - Documentation D^{épt.}
1 Rue de Provence
BP 208
38432 ECHIROLLES CEDEX
FRANCE
info@frec.bull.fr

BULL CEDOC
357 AVENUE PATTON
B.P.20845
49008 ANGERS CEDEX 01
FRANCE

REFERENCE
86 A2 95ER 02