

This page is deliberately left empty.

Proprietary Notice and Liability Disclaimer

The information disclosed in this document, including all designs and related materials, is the valuable property of NEC Computers and/or its licensors. NEC Computers and/or its licensors, as appropriate, reserve all patent, copyright and other proprietary rights to this document, including all design, manufacturing, reproduction, use, and sales rights thereto, except to the extent said rights are expressly granted to others.

To allow for design and specification improvements, the information in this document is subject to change at any time, without notice. Reproduction of this document or portions thereof without prior written approval of NEC Computers is prohibited.

The NEC Computers product(s) discussed in this document are warranted in accordance with the terms of the Warranty Statement accompanying each product. However, actual performance of each product is dependent upon factors such as system configuration, customer data, and operator control. Since implementation by customers of each product may vary, the suitability of specific product configurations and applications must be determined by the customer and is not warranted by NEC Computers.

Trademarks

NEC ESMPRO, NEC DianaScope, NEC MWA, and ExpressBuilder are trademarks or registered trademarks of NEC Corporation.

Adobe, and Adobe Acrobat are registered trademarks of Adobe Systems, Incorporated.

Microsoft, Microsoft Windows, Windows NT, Windows 95, Windows 98, Windows 2000 and Windows Server 2003 are all registered trademarks of Microsoft Corporation.

MS-DOS is a registered trademark of Microsoft Corporation.

Intel and Xeon are registered trademarks of Intel Corporation.

All other product, brand, or trade names used in this publication are the trademarks or registered trademarks of their respective trademark owners.

rev 1.0 September 2006

Copyright 2006
All Rights Reserved

NEC Computers S.A.S.
10 rue Godefroy
Immeuble OPTIMA
92821 PUTEAUX

This page is intentionally left blank.

Preface

Congratulations for your purchase of the Additional DAC Battery (called BBU hereafter). This User's Guide describes how to install and use the BBU correctly and safely. Read the guide thoroughly before handling it. In addition, refer to this manual when you want to know how to use it or some malfunction occurs. Always keep the manual at hand so that you can find it as soon as possible if necessary.

For the LSI Logic MegaRAID SAS 8300XLP 0-Channel (ZCR) RAID Controller to which the BBU is connected, refer to the User's Guide coming with the disk array controller.

Read "Notes on Use" carefully before handling the BBU.

Keep this User Guide handy for quick reference.
Be sure to read this section carefully.



NOTES ON USE - Always read the Notes -

The following includes information necessary for proper and safe operation of the product.

SAFETY INDICATIONS

In the User Guide, "WARNING" or "CAUTION" is used to indicate a degree of danger. These terms are defined as follows:



WARNING

Indicates a hazard that may result in death or serious personal injury.



CAUTION





Indicates a hazard that may cause minor personal injury, including burns, or property damage.

Precautions against hazards are presented with the following symbols. The individual symbols are defined as follows:



	Attention	This symbol indicates a hazard. An image in the symbol illustrates the hazard type.	(Example) Precaution against electric shock
	Prohibited Action	This symbol indicates prohibited actions. An image in the symbol illustrates a particular prohibited action.	(Example) Prohibition of disassembly
	Mandatory Action	This symbol indicates mandatory actions. An image in the symbol illustrates a mandatory action to avoid a particular hazard.	(Example) Unplug the power cord!

Symbols Used in This Manual and Warning Labels



Cautions

	Indicates a general notice or warning that cannot be specifically identified.
	Indicates that improper use may cause an electric shock.
	Indicates that improper use may cause a personal injury.
	Indicates that improper use may cause fumes or fire.

Prohibited Actions

	Indicates a general prohibited action that cannot be specifically identified.
	Do not disassemble, repair, or modify the server. Doing so may cause an electric shock or fire.





Mandatory Action



	Unplug the power cord of the server. Not doing so may cause an electric shock or fire.
	Indicates a mandatory action that cannot be specifically identified. Make sure to follow the instruction.

Safety Notes

Read the notes described below carefully to understand them, these will enable you to safely use your product. See "Safety Indications" described earlier for the descriptions of symbols.

General

 WARNING	
	<p>Do not use the product for services involving human lives or requiring high reliability.</p> <p>The product is not intended to be used with or control facilities or devices concerning human lives, including medical devices, nuclear facilities and devices, aeronautics and space devices, transportation facilities and devices; and facilities and devices requiring high reliability. The manufacturer assumes no liability for any accident resulting in personal injury, death, or property damage if the Disk Expansion Unit has been used in the above conditions.</p>
 	<p>Do not use the product if you are aware of any suspect smoke, odour, or noise.</p> <p>If smoke, odour, or noise is present, immediately switch off the unit and disconnect the power plug from the outlet. Contact your sales agent. Using the product in such conditions may cause a fire.</p>
	<p>Keep needles or metal objects away from the server.</p> <p>Do not insert needles or metal objects into the ventilation holes or cartridge slot of the server. Doing so may cause an electric shock.</p>

 CAUTION	
 	<p>Keep water or foreign matter away from the server.</p> <p>Do not let any form of liquid (water etc.) or foreign matter (e.g., pins or paper clips) enter the server. Failure to follow this warning may cause an electric shock, a fire, or a failure of the server. When such things accidentally enter the server, immediately turn off the power and disconnect the power plug from the AC outlet. Do not disassemble the server. Contact your service representative.</p>

Power Supply and Power Cord Use

CAUTION



Disconnect the power cord(s) before installing or removing the product in/from the server.

Make sure to power off the server and disconnect the power cord(s) from the power outlet before installing/removing the product in/from the server, or connecting with the peripheral devices. All voltage is removed only when the power cords are unplugged.



Always observe the following to prevent an electric shock or fire that could be caused by a damaged cord.

- Do not stretch the cord harness.
- Do not pinch the power cord.
- Do not bend the power cord.
- Keep chemicals away from the power cord.
- Do not twist the power cord.
- Do not place any object on the power cord.
- Do not bundle power cords.
- Do not alter, modify, or repair the power cord.
- Do not secure the power cord with staples or equivalents.
- Do not use a damaged power cord. (Replace a damaged power cord with a new one of the same specifications. Ask your sales agent for replacement.)



Do not hold the power plug if your hands are wet.

Do not disconnect/connect the plug while your hands are wet. Failure to follow this warning may cause an electric shock.



Do not pull the cable when disconnecting the power cord.

When disconnecting the power cord from the server, hold the plug and pull it straight out. Pulling the cord out by the cable portion could damage the cable to result in an electrical shock hazard or a fire.



Installation, Relocation, Storage, and Connection

CAUTION



Do not connect any interface cable when the power cord of the Disk Expansion Unit is plugged to a power source.



Make sure to power off the server and unplug the power cord from a power outlet before connecting/disconnecting the interface cable. If the server is off-powered but its power cord is plugged to a power source, touching the cable may cause an electric shock or a fire may result from a short circuit. Also, connect/disconnect the interface cable after turning off the power of the destination.



Do not use any unauthorized interface cable.

Use only interface cables authorized by the manufacturer and locate a proper device and connector before connecting a cable. Using an unauthorized cable or connecting a cable to an improper destination may cause a short circuit, resulting in a fire.

Also, observe the following notes on using and connecting an interface cable.

- Do not step on the cable.
- Do not place any object on the cable.
- Do not use the server with loose cable connections.
- Do not use any damaged cable connector.
- Make sure the cable is securely locked with the relevant screws.



Do not use or store the product in the place where corrosive gases exist.



Make sure not to locate or use the server in the place where corrosive gases (sulphur dioxide, hydrogen sulphide, nitrogen dioxide, chlorine, ammonia, ozone, etc) exist.





Also, do not set it in the environment where the air (or dust) includes components accelerating corrosion (ex. sulphur, sodium chloride) or conductive metals. There is a risk of a fire due to corrosion and/or short-circuits of an internal printed board.



Avoid installation in extreme temperature conditions.







Immediately after the server is powered off, its internal components, such as hard disk drives are very hot. Let the installed components fully cool down before installing/removing anything.

Cleaning and Working with the Product

 WARNING	
  	<p>Do not disassemble, repair, or alter the server.</p> <p>Do not attempt to disassemble, repair, or alter the product in any occasion other than those described in this User Guide. Failure to follow this instruction may cause an electric shock or fire as well as malfunctions of the product.</p>
	<p>Disconnect the power plug before accessing inside the server.</p> <p>Make sure to power off the server and disconnect the power plug from the AC outlet before accessing inside the server. Touching any internal device of the server when its power cord connected to a power source may cause an electric shock even if the server is off-powered.</p>

 CAUTION	
	<p>Make sure to complete installation.</p> <p>Always connect the DC cable and/or interface cable firmly. An incompletely connected cable may cause a contact failure, resulting in smoke or fire.</p>

During Operation

 CAUTION	
 	<p>Avoid contact with the server during thunderstorms.</p> <p>Disconnect the power plug from the outlet when a thunderstorm is approaching. If the thunderstorm begins before you can disconnect the power plug, do not touch any part of the server containing the product. Failure to follow this warning may cause an electric shock.</p>
 	<p>Keep animals away from the server.</p> <p>Keep animals away from the server containing the product. Pet's discharges or fur may enter the server and cause a fire or electric shock.</p>
	<p>Do not use a cellular phone or a pager around the server.</p> <p>Turn off cellular phones or pagers near the server containing the product. Radio interference may cause malfunctions of the server.</p>

Warning Labels

The warning label is attached to the product with possible danger or their vicinity in your product to inform the user that a hazardous situation may arise when operating the product. (Do not intentionally remove or damage any of the labels.)

If you find any labels totally/partially removed or illegible due to damage, contact your sales representative.

 NI-MH	Set up Date	FR	
	Y . M		
 警告 WARNING			
分解したり、100℃近くの高温に近づけたりしないで下さい。 また、水に浸したりしないで下さい。爆発・破裂の恐れがあります。 Do not open or expose to heat above 100℃, and do not place the battery in the water may cause an explosion.			
 注意 CAUTION			
バッテリーの廃棄は取扱説明書を参照して下さい。 Please refer to User's Guide when disposing the battery.			

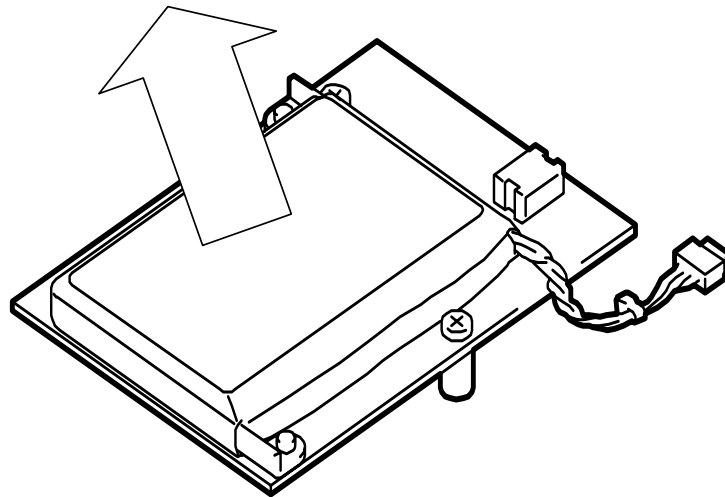

Notes on Use - for correct operation of BBU -

Note the following when you use the BBU. If you ignore the notes, your assets (including important data and/or other devices) may be damaged.



- The BBU is an additional battery exclusively used for the LSI Logic MegaRAID SAS 8300XLP 0-Channel (ZCR) RAID Controller.
The BBU cannot be connected to any other disk array controllers.
- The BBU is an extremely sensitive electronic device. First make your body contact with metallic frame of the server to discharge static electricity from your body before handling the BBU.
- Do not drop the BBU. Do not make the BBU hit against other objects.
- For the recycle and disposal of the BBU, see "Recycle and Disposal" in this chapter.

This Manual

The guide is intended for persons who are familiar with operating systems including Windows and fundamental operations of general-purpose I/O devices including the keyboard and mouse.

Text Conventions

The following conventions are used throughout this User's Guide. For safety symbols, see "SAFETY INDICATIONS" provided earlier.

 Notice	Items to be observed or points to be noted when operating the product.
 Check	Items to be checked when operating the product
 Tips	Information useful or convenient for you

In the Package

The carton contains various accessories, as well as the product itself. See the packing list (Chapter 1-4. Checking contents in package) to make sure that you have everything and that individual components are not damaged. If you find any component missing or damaged, contact your sales agent.

Transportation

To transport the BBU, remove it from the server following "Chapter 1 Overview" and put the BBU and all the accessories in the package used for the delivery.

Transfer to Third Party

Make sure to provide this manual along with the product to a third party.

**Notice****About data on the hard disk**

Be sure to take appropriate measures not to leak important data (e.g., customers' information or companies' management information) on the removed hard disk to any third parties.

Data seems to be erased when you empty "Recycle Bin" of Windows or execute the "format" command of the operating system. However, the actual data remains written on the hard disk. Data not erased completely may be restored by special software and used for unexpected purposes.

It is strongly recommended that the software or service (both available at stores) for data erasure should be used in order to avoid the trouble explained above. For details on data erasure, ask your sales representative.

NEC assumes no liability for data leakage if the product is transferred to third party without erasing the data.

Life of BBU

The BBU is equipped with a backup battery. The life of the battery is about 2 years while it varies depending on the use environment and operating conditions.

Replace the battery with a new one after about two years from the installation of the BBU (the installation time can be known by the battery label put on the server and the BBU). Contact your service representative for the replacement

Maintenance Parts

The holding period of maintenance parts of the BBU is five years from the truncation of manufacturing.

Recycle and Disposal

The battery pack of the BBU is equipped with lithium ion battery which is recyclable. To enable such valuable resources to be reused, contact your service representative or bring it to the nearest recycle agent. For the removal of the BBU, see "4. Battery Pack Replacement Procedure" in "Chapter 3 Operation and Maintenance."

Dispose of other devices following the regulation of the local government. For details, contact the local government or your service representative.

Take sufficient note on the handling of the battery pack following "Chapter 3 Operation and Maintenance."

**Notice**

Dispose of hard disk drives, backup data cartridges, floppy disks and other writable media (including CD-R/CD-RW) after erasing the data saved in the media securely on your own responsibility so that the data may not be restored, replayed, and/or reused by third parties. Take special care for protecting individual privacy and corporate secret.

Contents

Preface	1
NOTES ON USE - Always read the Notes -	1
Symbols Used in This Manual and Warning Labels	2
Cautions.....	2
Prohibited Actions.....	2
Mandatory Action.....	2
Safety Notes	3
General.....	3
Power Supply and Power Cord Use.....	4
Installation, Relocation, Storage, and Connection.....	5
During Operation	6
Warning Labels.....	7
Notes on Use - for correct operation of BBU -.....	7
This Manual	8
Text Conventions	8
In the Package.....	8
Transportation.....	8
Transfer to Third Party.....	9
Life of BBU.....	9
Maintenance Parts.....	9
Recycle and Disposal	9
Contents	10
Chapter 1 Overview.....	11
1. Characteristics of BBU	11
2. Specification	11
3. Installation Flow.....	12
4. Checking Contents in Package	12
5. Names and Functions of Sections.....	13
6. Notes	14
6-1. Notes on Installation.....	14
6-2. Notes on Operation	14
Chapter 2 Installing BBU	15
1. Installation Procedure.....	15
1-1. Checking Cable	15
1-2. Putting Setup Date Label	16
1-3. Installing BBU in Disk Array Controller.....	17
2. Checking with Management Utility	19
3. Reconditioning the battery.....	23
Chapter 3 Operation and Maintenance	24
1. Maintenance Service	24
2. Preventive Maintenance.....	24
2-1. Preventive Maintenance of BBU	24
2-2. Life of BBU	24

Chapter 1 Overview

First read this chapter if you use the Additional DAC Battery (called BBU below) for the first time.

This chapter describes the characteristics and configuration of the BBU and outlines the additional battery installation job.

1. Characteristics of BBU

The BBU is an additional battery exclusively used for the LSI Logic MegaRAID SAS 8300XLP 0-Channel (ZCR) RAID Controller.

Connecting the BBU to the disk array controller can prevent data from being lost due to an unforeseen accident including instantaneous power interruption (in the WriteBack mode).

- Backup of data in cache memory on disk array controller for up to 64 hours
- Improvement of reliability in WriteBack mode
- Use of rechargeable NiMH battery

2. Specification

Item	Specification	Remarks
Maximum data backup time	64 hours	Full charging
Outer dimension (mm)	49 (width) x 68 (depth) x 15 (height)	
Weight	About 0.07 kg	
Battery capacity	4.22 Wh	Normal operation
Operating environment	Temperature	10°C - 35°C
	Humidity	20% - 80%
Storage environment	Temperature	0°C - 35°C
	Humidity	20% - 80%
Life (battery back)	About 2 years	Varies depending on operating environment and boundary conditions

3. Installation Flow

The following shows the job flow for installing the BBU. For details, see the respective chapters.

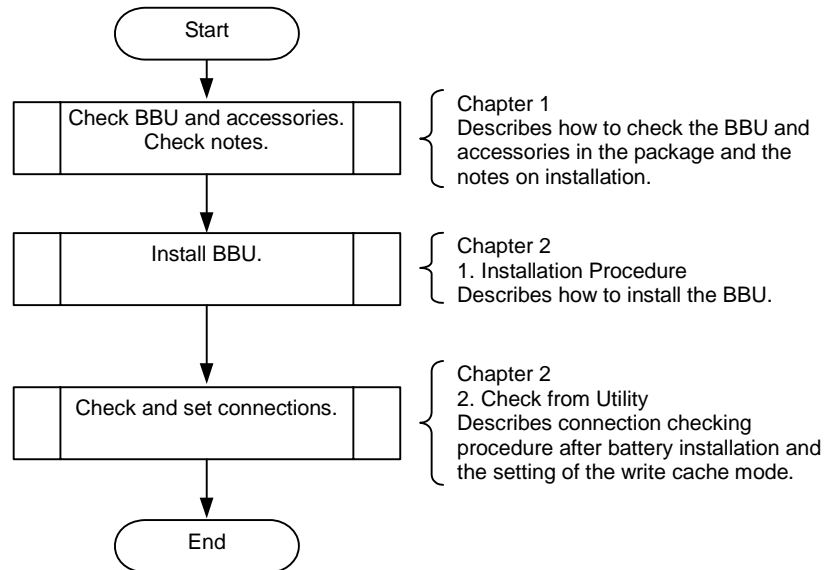

4. Checking Contents in Package

The package contains the following items. Check the contents to confirm that all the items are provided before starting the installation job.

No.	Item	Qty	Remarks
1	Additional DAC battery	1	This unit
2	Setup date label	1	

The package contains the following items.

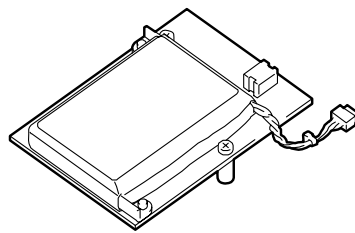

Battery Backup Unit (BBU)

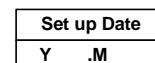

Setup Date label

5. Names and Functions of Sections

This section describes the sections of the BBU.

Front view

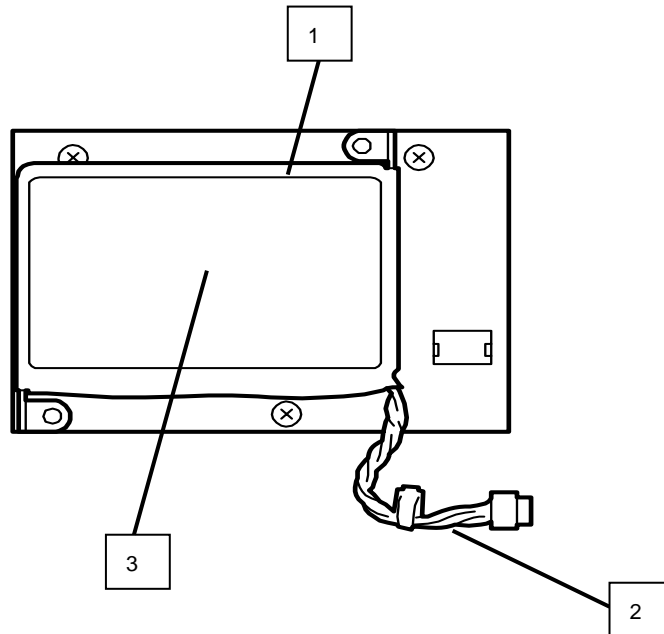

1	Battery cell NiMH battery cell		
2	Battery cable Used to connect the battery cell to battery board.		
3	<table border="1"> <tbody> <tr> <td data-bbox="274 1249 890 1525"> Recycle and caution label The label is put on the battery pack. It indicates the recycle symbol, battery type, and warning message, and is filled with the management revision of the battery pack. </td> <td data-bbox="896 1258 1241 1482"> </td> </tr> </tbody> </table>	Recycle and caution label The label is put on the battery pack. It indicates the recycle symbol, battery type, and warning message, and is filled with the management revision of the battery pack.	
Recycle and caution label The label is put on the battery pack. It indicates the recycle symbol, battery type, and warning message, and is filled with the management revision of the battery pack.			

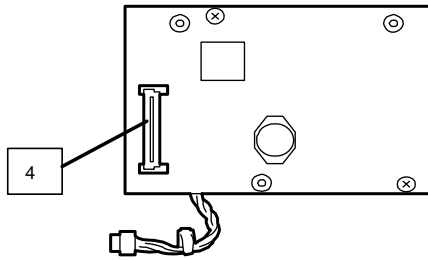
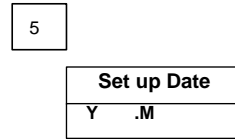
Rear view**Accessories**

- | | |
|---|--|
| 4 | Battery Connector
Connect to the disk array controller. |
| 5 | Setup Date label (accessory)
The label comes with the BBU. Fill the year and month when the BBU is installed in the disk array controller. Then put the label on the BBU surface. |

6. Notes

Read the following notes thoroughly before using the BBU.

6-1. Notes on Installation

- Do not put the BBU on a metallic plate including the chassis of the server. Do not hold the BBU with wet hands. If you do not follow these directions, the battery may be short-circuited.

6-2. Notes on Operation

- The life of the battery pack used for the BBU is about 2 years, which may vary a little depending on the use environment and environmental conditions. Replace the battery pack with a new one after about two years from the installation. For the replacement, contact your service representative.

Chapter 2 Installing BBU

This chapter describes the installation of the BBU in the disk array controller (0ch).

1. Installation Procedure

To install the BBU in the disk array controller, do as follows:



Check

Before the installation, refer to the User's Guide of the disk array controller and that of the server.

1-1. Checking Cable

Make sure that the cable is removed from both the battery cell and the battery board.

If the cable is connected, remove it.

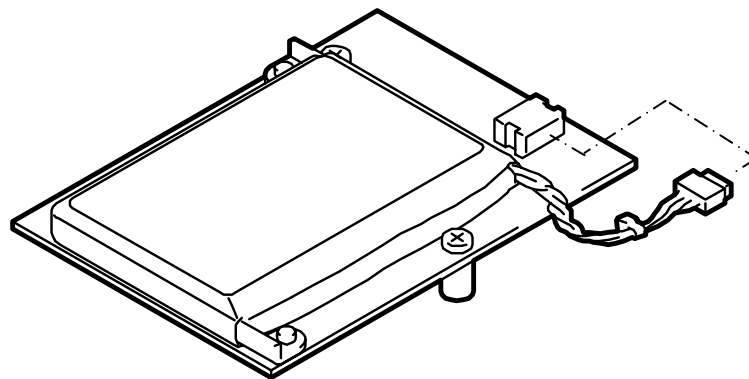

1-2. Putting Setup Date Label

Fill the year and month when the BBU is installed in the disk array controller on the battery label coming with the BBU.

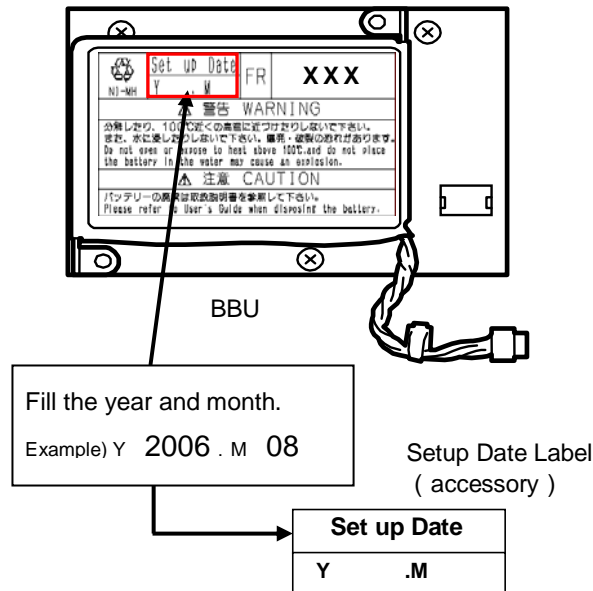

Notice

The life of the battery is about 2 years while it varies depending on the use environment and operating conditions. If the battery pack is used after its life, the maximum data backup time (64 hours) cannot be secured. Replace such a battery pack with a new one as soon as possible following "Chapter 3 Operation and Maintenance."

1-3. Installing BBU in Disk Array Controller

See the following instructions and figures.

1. Position the battery pack daughter card so the screw holes on the standoffs are in line with the screw holes on the front side of the zero-channel RAID card.
2. Carefully insert screws from the back of the card through the holes on the standoffs.

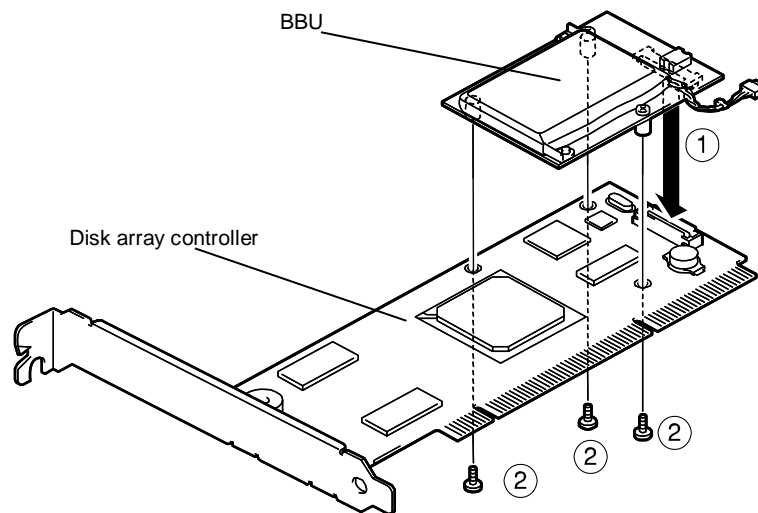

3. Connect battery harness connector to the mating connector on the battery pack. Note: Connector is keyed so that it will only mate in the correct orientation.

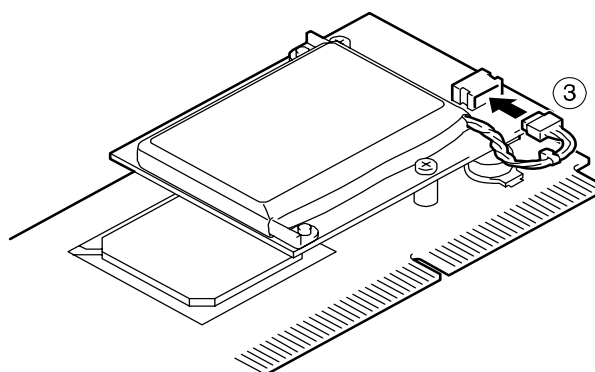

To remove the additional battery from this card, do as follows:

1. Pull out the additional battery cable from the battery harness connector.

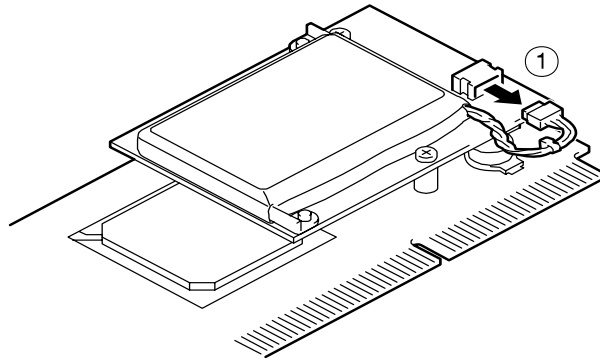

2. Remove the screws from the back of the card.
3. Remove the additional battery from the card.

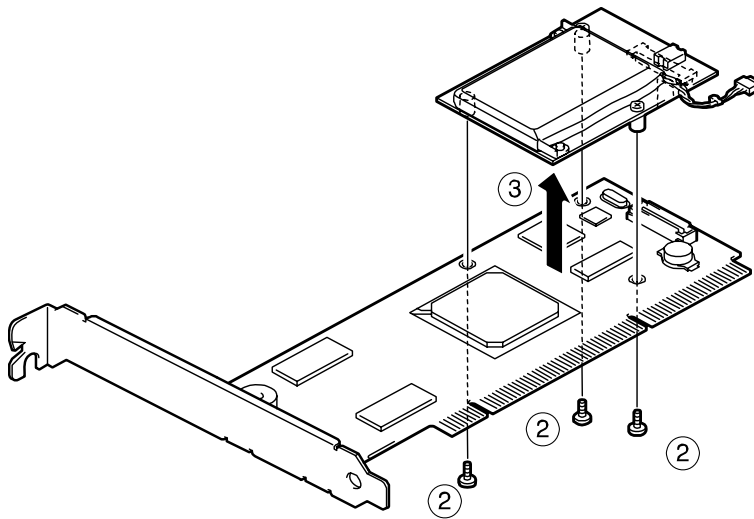

2. Checking with Management Utility

After the installation, check the connections and settings of the BBU using the disk array controller management utility "MegaRAID Storage Manager™" (called MSM hereafter).

1. Boot OS and start MSM.
2. Make sure that the "Battery Backup Unit" icon appears in the Physical tab of MSM.

The screenshot shows the MegaRAID Storage Manager (MSM) interface. The 'Physical' tab is selected, and the 'Battery Backup Unit' icon is highlighted in the tree view. The 'Properties' tab displays the following battery status information:

Battery Type	: No Battery	Auto Learn Period	: 30Days
Next Learn Time	: 2410Days	Relative State of Charge	: 0 %
Absolute State of Charge	: 0 %	Remaining Capacity	: 0 mAh
Full Capacity	: 0 mAh	Run time to Empty	: 0 min
Average Time to Empty	: 0 min	Average Time to Full	: 0 min
Cycle Count	: 1	Maximum Error Margin	: 0 %
Temperature	: 0.0 Degree C	Voltage	: 0 mV
Current	: 0 mA	Auto Learn Mode	: Auto

The log window at the bottom shows the following entries:

Error Level	Date / Time	Description
Information	2006-07-11, 14:13:08	Successful log on to the server User: administrator, Client: 127.0.0.1, Access Mode: Full, Client Time: 2006-07-11,14:13...
Information	2006-07-11, 14:11:41	Controller ID: 0 Battery charge complete
Information	2006-07-11, 14:10:56	Controller ID: 0 Time established since power on Time Tue Jul 11 14:10:56 2006 51Seconds
Information	50seconds from reboot	Controller ID: 0 Device inserted Device Type: Disk Device Id: 0:1
Information	50seconds from reboot	Controller ID: 0 PD inserted 0:1

Displaying log from server

3. Select the Logical tab in the left frame of the window, and then select each "Virtual Disk" under the Logical tab.
4. Select the Properties tab in the right frame of the window, and confirm the setting for Default Write Policy.

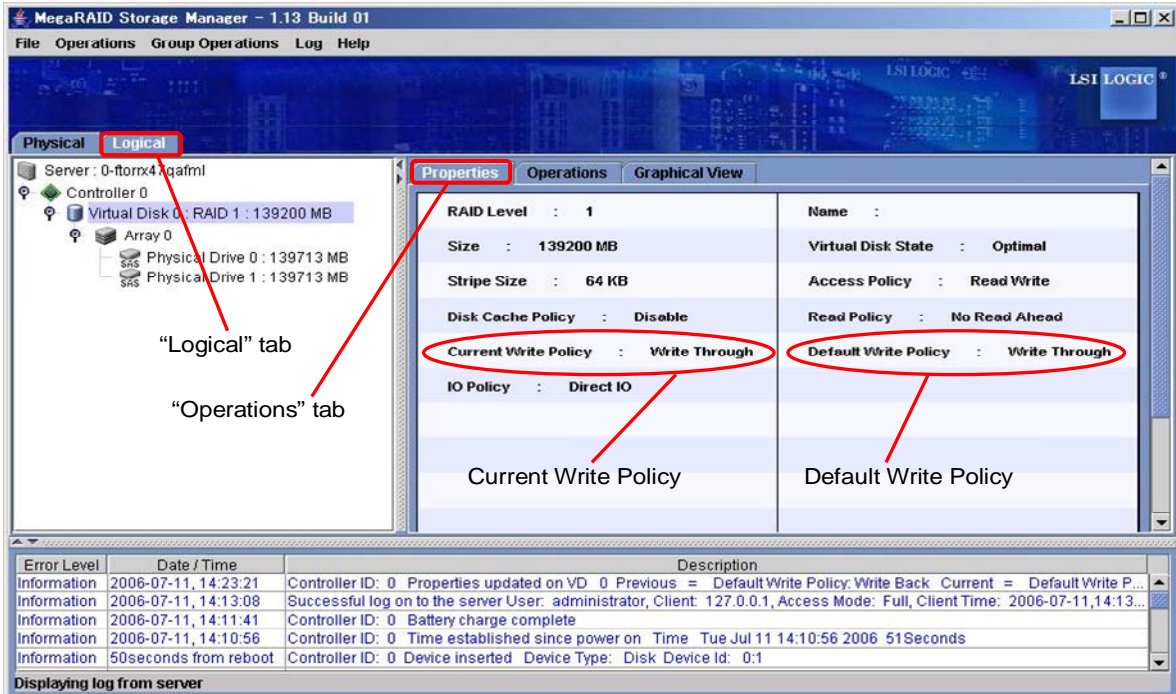

5. Change the Default Write Policy to "Write Back" if not specified.
6. To change the Default Write Policy:
 - 6-1. Select the Logical tab in the left frame of the window, and then select each "Virtual Disk" under the Logical tab.
 - 6-2. Select the Set Virtual Disk Properties under the Operations tab in the right frame of the window, and change the Default Write Policy to Write Back.
 - 6-3. Repeat Steps 6-1 and 6-2 for all Virtual Disk under the Logical tab to change their Default Write Policy to "Write Back".

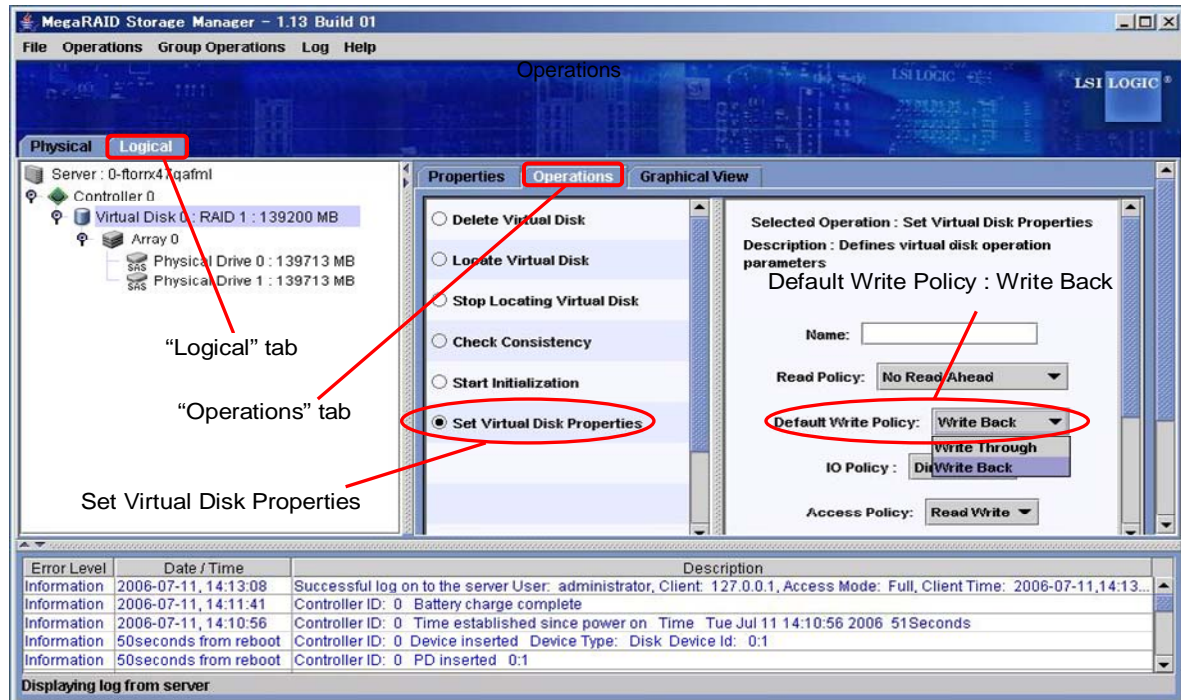

7. After charging the BBU, make sure that the Current Write Policy (indicating write cache operation status) is indicated as "Write Back."

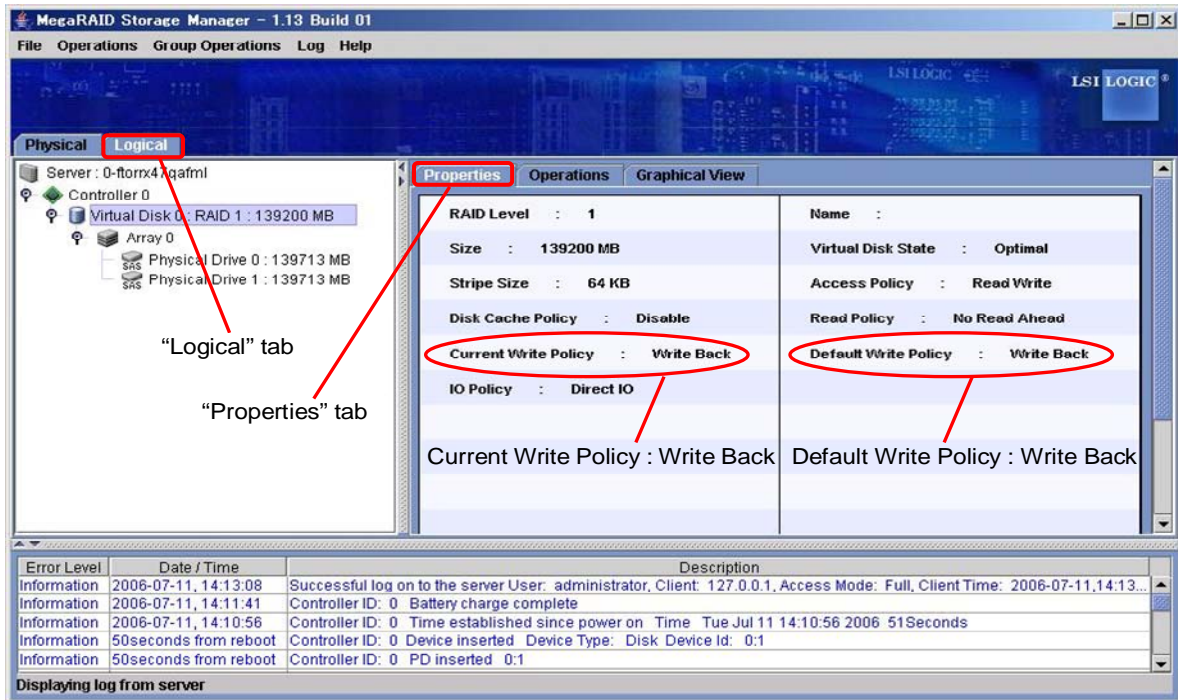

Notice

- The battery cell you have purchased is not charged at all. For such battery cell, the [Current Write Policy] in [Properties] of [Logical] tab is indicated as "Write Through" on MSM.
- You can check the charged status of battery cell by selecting [Relative State of Charge] or [Absolute State of Charge] in [Physical] tab → [Properties] on MSM.



Tips

For details of the Write Policy, refer to the User's Guide of the disk array controller or MSM User's Guide (online document in the CD-ROM coming with the server).

3. Reconditioning the battery

Because the battery cell has not been charged when you purchased the battery, the status of “Current Write Policy” is “Write Through”. To see the status on MSM, select the Logical tab in the left frame of the window, and then select each "Virtual Disk" under the Logical tab. Then select the Properties tab in the right frame of the window. The battery will execute the following operations to recondition the battery when it is installed or replaced.

1. The battery starts charging. The following log is registered in MSM and application log.

Controller ID:x Battery started charging

2. About a few hours later, the battery finishes charging. The following log is registered to MSM and application log.

Controller ID:x Battery charge complete

3. The battery starts discharging to recondition the battery status. The following logs are registered in MSM and application log.

Controller ID:x Battery relearn pending: Battery is under charge

Controller ID:x Battery is discharging

4. After several hours, the battery finishes discharging. The following log is registered in MSM and application log.

Controller ID:x Battery relearn completed

5. The battery starts charging again. The following log is registered in MSM and application log. If the battery does not start charging after a while, please reboot the server and confirm if the following log is registered in MSM or application log.

Controller ID:x Battery started charging

6. About a few hours later, the battery finishes charging. The following log is registered in MSM and application log. After these operations, the battery will execute discharging and charging every 30 days.

Controller ID:x Battery charge complete

Chapter 3 Operation and Maintenance

1. Maintenance Service

We recommend you contact Service Representative approved by the manufacturer to order genuine spare parts or to perform any operations on your system.

2. Preventive Maintenance

2-1. Preventive Maintenance of BBU

Check the states of the BBU (including voltage and temperature) regularly as preventive maintenance. For the purpose, you can use MegaRAID Storage Manager™ (MSM).

2-2. Life of BBU

The battery cell used in the BBU can be used for about two years. Replace the battery cell having been used for two years or longer with a new one as soon as possible.



The BBU is a supply/charged warranty device.

This page is deliberately left empty.

