

**LSI MegaRAID SAS 8708 EM2
Disk Array Controller**

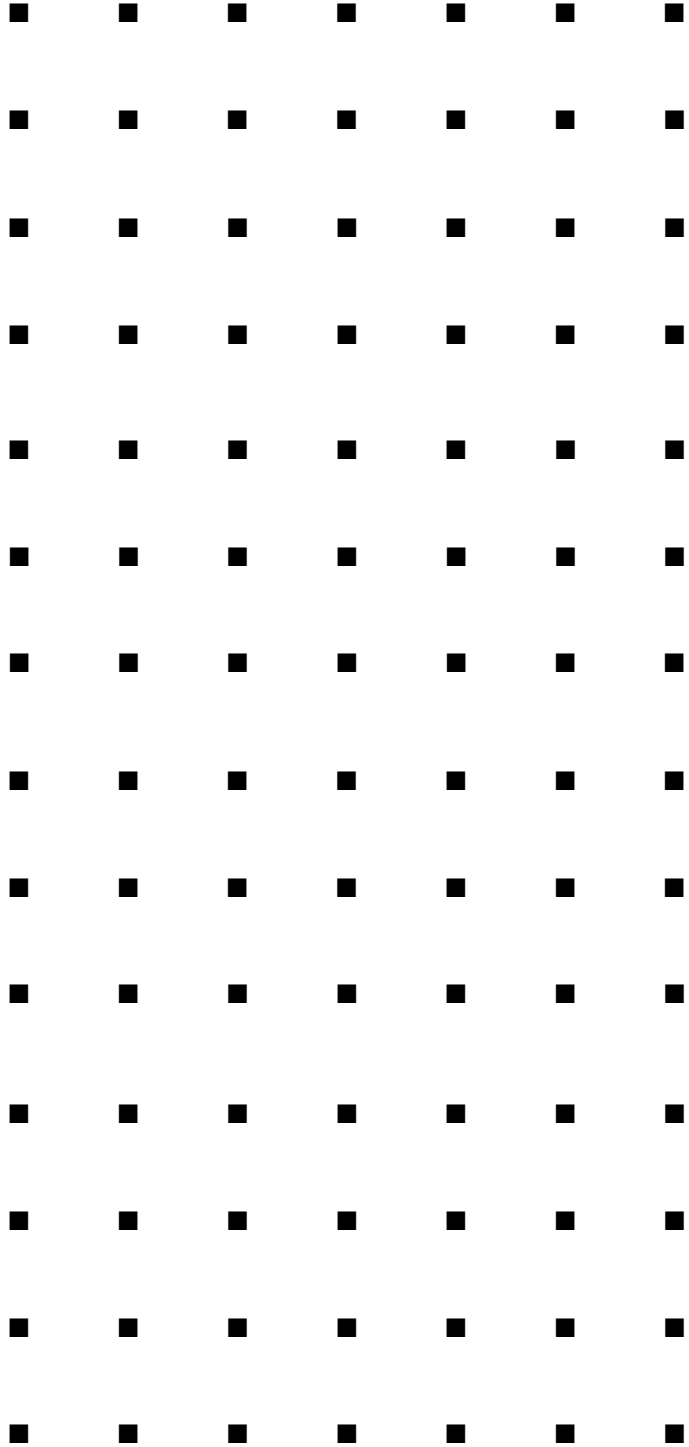

User Guide

PROPRIETARY NOTICE AND LIABILITY DISCLAIMER

The information disclosed in this document, including all designs and related materials, is the valuable property of NEC Computers and/or its licensors. NEC Computers and/ or its licensors, as appropriate, reserve all patent, copyright and other proprietary rights to this document, including all design, manufacturing, reproduction, use, and sales rights thereto, except to the extent said rights are expressly granted to others.

To allow for design and specification improvements, the information in this document is subject to change at any time, without notice. Reproduction of this document or portions thereof without prior written approval of NEC Computers is prohibited.

The NEC Computers product(s) discussed in this document are warranted in accordance with the terms of the Warranty Statement accompanying each product. However, actual performance of each product is dependent upon factors such as system configuration, customer data, and operator control. Since implementation by customers of each product may vary, the suitability of specific product configurations and applications must be determined by the customer and is not warranted by NEC Computers.

rev 1.0 January 2008

Copyright 2008
All Rights Reserved

NEC Computers S.A.S.
10 rue Godefroy
Immeuble OPTIMA
92821 PUTEAUX

Preface

Congratulations for your purchase of the RAID Controller.

The User's Guide describes how to install and use the Disk Array Controller (with or without the optional RAID 5/6 key) correctly and safely. Read the guide thoroughly before handling it. In addition, refer to this manual when you want to know how to use it or some malfunction occurs. Always keep the manual at hand so that you can see it as soon as possible if necessary.

For the server in which the disk array controller is installed, refer to the User's Guide of the server. Read "Notes on Use" carefully before handling the disk array controller.

Table of Contents

Preface.....	3
Table of Contents	4
 NOTES ON USE - Always read the Notes -	6
Symbols Used in This Manual and Warning Labels	7
Safety Notes.....	8
This Manual.....	12
In the Package	12
Third Party Transfer	13
Disposal	13
Data Backup.....	13
Transportation	13
Abbreviations	13
Chapter 1 Overview.....	14
1. Specification	14
2. RAID Controller Features	15
3. Names and Functions of Sections.....	16
4. Hardware Setup.....	17
4-1. Prepare for setup	17
4-2. Selecting and Installing a Bracket	18
4-3. Installing the Disk Array Controller	19
4-4. Connecting the SAS Cable	20
4-5. Connecting the LED Cable.....	21
Chapter 2 RAID	22
1. Overview of RAID	22
1-1. What is RAID (Redundant Array of Inexpensive Disks)?.....	22
1-2. RAID Levels	22
1-3. Disk Group	23
1-4. Virtual Disk.....	23
1-5. Parity.....	23
1-6. Hot-Swap	24
1-7. Hot-Spare Disk.....	24
1-8. Write Cache Setting (Write Policy).....	24
2. RAID Levels.....	25
2-1. RAID Levels Characteristics	25
2-2. RAID0	26
2-3. RAID1	26
2-4. RAID5	27
2-5. RAID6	27
2-6. RAID10	28
2-7. RAID50	28
Chapter 3 RAID Controller Features	29
1. Rebuild.....	29
1-1. Manual Rebuild	29
1-2. Auto Rebuild.....	29
2. Patrol Read.....	30
3. Consistency Check.....	30

4. Background Initialize	31
5. Reconstruction.....	32
5-1. Removed physical drive	32
5-2. Migration only.....	32
5-3. Migration with addition	32
Chapter 4 Creating a Virtual Disk.....	34
1. Before Using WebBIOS.....	34
1-1. Supported Functions	34
1-2. Notes on Creating a Virtual Drive.....	35
2. Using WebBIOS	36
2-1. Starting WebBIOS	36
2-2. Main Menu	37
2-3. Adapter Properties	39
2-4. Scan Devices	43
2-5. Virtual Disks	44
2-6. Physical Drives	45
2-7. Physical Drive Properties	46
2-8. Configuration Wizard.....	48
2-9. Adapter Selection.....	48
2-10. Physical View / Logical View	48
2-11. Events	48
2-12. Exit.....	49
3. Configuring Virtual Disk	50
3-1. Configuration Wizard.....	50
3-2. Configure SPAN	59
3-3. Parameters for VD Definition	64
4. Operation of Various Features.....	66
4-1. Check Consistency	66
4-2. Manual Rebuild	68
4-3. Setting Hot Spare	71
4-4. Reconstruction	74
4-5. Locate	77
4-6. Slow Initialize	78
Chapter 5 Operation and Maintenance	80
1. Maintenance Service	80
2. Preventive Maintenance	80
2-1. Data Backup	80
3. Maintenance	80
3-1. Configuration on Disk (COD) Feature	80
3-2. Rebuild Feature	80
4. Replacing the Disk Array Controller	81
5. Troubleshooting	82

Keep this User Guide handy for quick reference.
Be sure to read this section carefully.

NOTES ON USE - Always read the Notes -

The following includes information necessary for proper and safe operation of the product.

SAFETY INDICATIONS

In the User Guide, "WARNING" or "CAUTION" is used to indicate a degree of danger. These terms are defined as follows:



WARNING







Indicates a hazard that may result in death or serious personal injury.



CAUTION





Indicates a hazard that may cause minor personal injury, including burns, or property damage.

Precautions against hazards are presented with the following symbols. The individual symbols are defined as follows:



	Attention	This symbol indicates a hazard. An image in the symbol illustrates the hazard type.	(Example)  Precaution against electric shock
	Prohibited Action	This symbol indicates prohibited actions. An image in the symbol illustrates a particular prohibited action.	(Example)  Prohibition of disassembly
	Mandatory Action	This symbol indicates mandatory actions. An image in the symbol illustrates a mandatory action to avoid a particular hazard.	(Example)  Unplug the power cord!

Symbols Used in This Manual and Warning Labels



Cautions

	Indicates a general notice or warning that cannot be specifically identified.
	Indicates that improper use may cause an electric shock.
	Indicates that improper use may cause a personal injury.
	Indicates that improper use may cause fumes or fire.

Prohibited Actions

	Indicates a general prohibited action that cannot be specifically identified.
	Do not disassemble, repair, or modify the server. Doing so may cause an electric shock or fire.





Mandatory Action



	Unplug the power cord of the server. Not doing so may cause an electric shock or fire.
	Indicates a mandatory action that cannot be specifically identified. Make sure to follow the instruction.

Safety Notes





Read the notes described below carefully to understand them, these will enable you to safely use your product. See "Safety Indications" described earlier for the descriptions of symbols.

General

 WARNING	
	<p>Do not use the product for services involving human lives or requiring high reliability.</p> <p>The product is not intended to be used with or control facilities or devices concerning human lives, including medical devices, nuclear facilities and devices, aeronautics and space devices, transportation facilities and devices; and facilities and devices requiring high reliability. The manufacturer assumes no liability for any accident resulting in personal injury, death, or property damage if the Disk Expansion Unit has been used in the above conditions.</p>
 	<p>Do not use the product if you are aware of any suspect smoke, odour, or noise.</p> <p>If smoke, odour, or noise is present, immediately switch off the unit and disconnect the power plug from the outlet. Contact your sales agent. Using the product in such conditions may cause a fire.</p>
	<p>Keep needles or metal objects away from the server.</p> <p>Do not insert needles or metal objects into the ventilation holes or cartridge slot of the server. Doing so may cause an electric shock.</p>

 CAUTION	
 	<p>Keep water or foreign matter away from the server.</p> <p>Do not let any form of liquid (water etc.) or foreign matter (e.g., pins or paper clips) enter the server. Failure to follow this warning may cause an electric shock, a fire, or a failure of the server. When such things accidentally enter the server, immediately turn off the power and disconnect the power plug from the AC outlet. Do not disassemble the server. Contact your service representative.</p>

Power Supply and Power Cord Use

⚠ CAUTION	
	<p>Disconnect the power cord(s) before installing or removing the product in/from the server.</p> <p>Make sure to power off the server and disconnect the power cord(s) from the power outlet before installing/removing the product in/from the server, or connecting with the peripheral devices. All voltage is removed only when the power cords are unplugged.</p>
	<p>Do not hold the power plug if your hands are wet.</p> <p>Do not disconnect/connect the plug while your hands are wet. Failure to follow this warning may cause an electric shock.</p>
	<p>Do not pull the cable when disconnecting the power cord.</p> <p>When disconnecting the power cord from the server, hold the plug and pull it straight out. Pulling the cord out by the cable portion could damage the cable to result in an electrical shock hazard or a fire.</p>
	
	

Installation, Relocation, Storage, and Connection

CAUTION



Do not connect any interface cable when the power cord of the Disk Expansion Unit is plugged to a power source.



Make sure to power off the server and unplug the power cord from a power outlet before connecting/disconnecting the interface cable. If the server is off-powered but its power cord is plugged to a power source, touching the cable may cause an electric shock or a fire may result from a short circuit. Also, connect/disconnect the interface cable after turning off the power of the destination.



Do not use any unauthorized interface cable.

Use only interface cables authorized by the manufacturer and locate a proper device and connector before connecting a cable. Using an unauthorized cable or connecting a cable to an improper destination may cause a short circuit, resulting in a fire.

Also, observe the following notes on using and connecting an interface cable.

- Do not step on the cable.
- Do not place any object on the cable.
- Do not use the server with loose cable connections.
- Do not use any damaged cable connector.
- Make sure the cable is securely locked with the relevant screws.



Do not use or store the product in the place where corrosive gases exist.



Make sure not to locate or use the server in the place where corrosive gases (sulphur dioxide, hydrogen sulphide, nitrogen dioxide, chlorine, ammonia, ozone, etc) exist.





Also, do not set it in the environment where the air (or dust) includes components accelerating corrosion (ex. sulphur, sodium chloride) or conductive metals. There is a risk of a fire due to corrosion and/or short-circuits of an internal printed board.



Avoid installation in extreme temperature conditions.







Immediately after the server is powered off, its internal components, such as hard disk drives are very hot. Let the installed components fully cool down before installing/removing anything.

Cleaning and Working with the Product

 WARNING	
  	<p>Do not disassemble, repair, or alter the server.</p> <p>Do not attempt to disassemble, repair, or alter the product in any occasion other than those described in this User Guide. Failure to follow this instruction may cause an electric shock or fire as well as malfunctions of the product.</p>
	<p>Disconnect the power plug before accessing inside the server.</p> <p>Make sure to power off the server and disconnect the power plug from the AC outlet before accessing inside the server. Touching any internal device of the server when its power cord connected to a power source may cause an electric shock even if the server is off-powered.</p>

 CAUTION	
	<p>Make sure to complete installation.</p> <p>Always connect the DC cable and/or interface cable firmly. An incompletely connected cable may cause a contact failure, resulting in smoke or fire.</p>

During Operation

 CAUTION	
 	<p>Avoid contact with the server during thunderstorms.</p> <p>Disconnect the power plug from the outlet when a thunderstorm is approaching. If the thunderstorm begins before you can disconnect the power plug, do not touch any part of the server containing the product. Failure to follow this warning may cause an electric shock.</p>
 	<p>Keep animals away from the server.</p>
	<p>Do not use a cellular phone or a pager around the server.</p> <p>Turn off cellular phones or pagers near the server containing the product. Radio interference may cause malfunctions of the server.</p>

Notes on Use - for correct operation of the RAID controller-

Note the following when using the RAID controller. If you ignore these notes, your assets (including important data and/or other devices) may be damaged.

- The RAID controller must be exclusively used with the server for which it was sold. The RAID controller cannot be connected to any other servers.
- The RAID controller is an extremely sensitive electronic device. Touch the metallic frame of the server to discharge static electricity from your body before handling the RAID controller.
- Do not connect any HDD other than the ones specified with this product.
- Inquire with your service representative about the options that can be connected to this product.
- Confirm with your service representative whether this RAID controller co-exist with other PCI boards.
- Turn off your cellular phone or pager near the server containing the product. Radio interferences may cause malfunctions of the server.

This Manual

The guide is intended for persons who are familiar with operating systems, including Windows, and fundamental operations of general-purpose I/O devices, including the keyboard and mouse.

Text Conventions

The following conventions are used throughout this User Guide. For safety symbols, see "SAFETY INDICATIONS" provided earlier.



Notice

Items to be observed or points to be noted when operating the product.



Check

Items to be checked when operating the product.



Tips

Information useful or convenient for you.

In the Package

Check the package contents.

The package contains various accessories, as well as the product itself. Check with the packing list and make sure you have everything and that individual components are not damaged. If you find any missing or damaged components, contact your sales agent.

Third Party Transfer

Make sure to provide this manual along with the product to a third party.



About data on the hard disk

Be sure to take appropriate measures not to leak important data (e.g., customers' information or companies' management information) on the removed hard disk to any third parties.

Data seems to be erased when you empty "Recycle Bin" of Windows or execute the "format" command of the operating system. However, the actual data remains written on the hard disk. Data not erased completely may be restored by special software and used for unexpected purposes.

It is strongly recommended that the software or service (both available at stores) for data erasure should be used in order to avoid the trouble explained above. For details on data erasure, ask your sales representative.

The manufacturer assumes no liability for data leakage if the product is transferred to third party without erasing the data.

To transfer or sell any software application that comes with the product to a third party, the following requirements must be satisfied:

- All provided software applications must be transferred and no backup copies must be retained.
- The software applications must be uninstalled before transferring the product.

Disposal

Dispose of the product according to all national laws and regulations.



It is the user's responsibility to completely erase or modify all the data stored in storage device such as hard disk, backup data cartridge, floppy disk, or any other media (CD-R/CD-RW) so that the data cannot be restored.

Data Backup

A device failure due to shock or thermal changes, as well as operator's misconduct, may cause a data loss. To avoid losing data, we recommend you make a back-up copy of your valuable data on a regular basis.

Transportation

To transport the product, remove the product from the server and put it in the package used for the delivery along with the accessories, according to Chapter 1.

Abbreviations

Formal title	Abbreviation
RAID Controller User's Guide	this manual
RAID Controller	RAID Controller card
Operating System	OS
Hard disk drive	HDD

Chapter 1 Overview

Read this chapter first if you are using the RAID controller for the first time.

This chapter describes the notes you should always follow while using the RAID controller, the RAID controller features, and the hardware setup.

1. Specification

Item	Specification		Remarks
	RAID0/1 (standard)	RAID5/6 (with optional RAID 5/6 upgrade key)	
Number of SAS connectors	2 internal channels		4 ports per a channel
Cache size	128 MB		
PCI bus	Conforming to PCI Express 1.0A		
PCI connector	PCI Express (x8)		
Maximum PCI bus transfer rate	2.5 Gigabits/lane		
Device interface	SAS available		
Maximum data transfer rate	300 MB/sec		
RAID level	0, 1, 10	0, 1, 5, 6, 10, or 50	
Maximum number of RAID controllers installed in server	2		
Maximum number of connectable HDDs	8		4 HDDs connected per channel
Maximum number of logical drives	64		Maximum number of LDs for each disk group is 16.
Outer dimension	121 (width) x 181 (depth) x 22 (height) mm		
Weight	About 0.1 kg		
Operating voltage	3.3V/12V		
Power consumption (max.)	17.6W		
Operating environment	Temperature: 10°C to 35°C Humidity: 20% to 80%		Without condensation

2. RAID Controller Features

The RAID controller is equipped with two channels (4 ports per channel) of interface connectors conforming to SAS/SATA. The data transfer rate per port is up to 300 MB/sec.

RAID controller features

- Data transfer rate of up to 300 MB/sec
- Installation of 128MB DDR-II
- Up to 8 SAS/SATA HDDs connectable per board (4 HDDs connectable per channel)
- Support of RAID levels 0, 1, 5, 6, 10, 50 (depending on the RAID controller card)
- Automatic detection of a faulty drive
- Replacement of a failed HDD without shutting down the system



Notice

- The RAID controller does not support the PCI hot plug feature.

3. Names and Functions of Sections

(Front view)

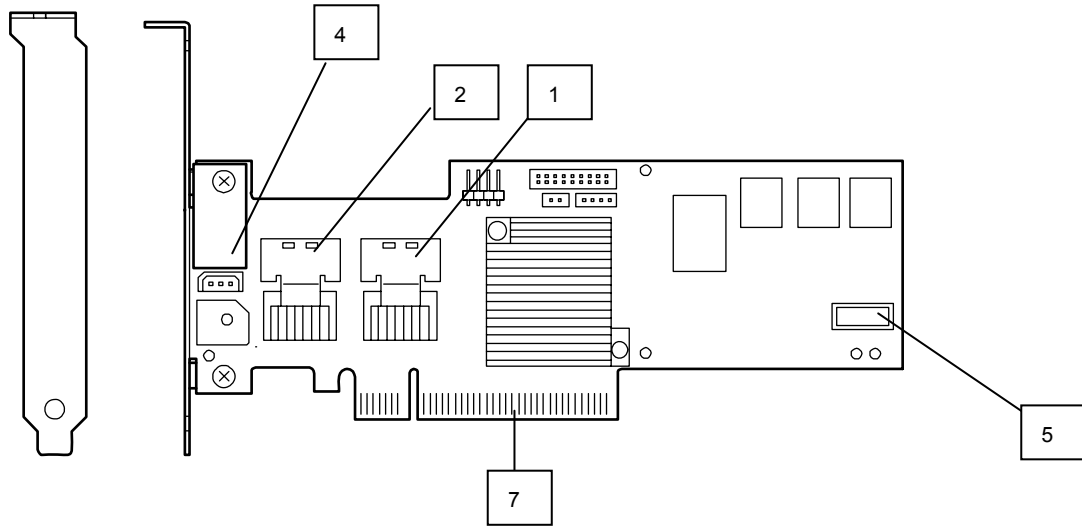

(Rear view)

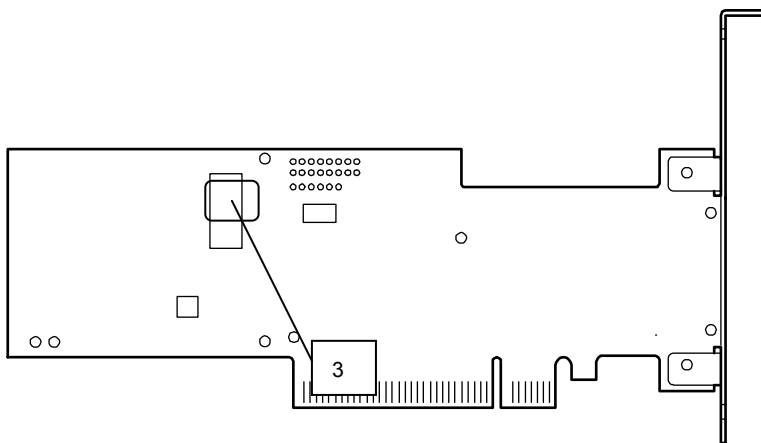

- 1** Channel 1 (Ports 0 - 3)
These channels allow the RAID controller to be connected to SAS devices.
- 2** Channel 2 (Ports 4 - 7)
These channels allow the RAID controller to be connected to SAS devices.
- 3** HW label
Indicates the management revision of the RAID controller.

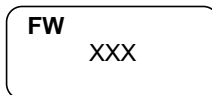

- 4** Upgrade key
The Upgrade key provides the RAID5/6 compatibility feature.
- 5** Battery connector
Used to connect the RAID Battery Backup Unit.
- 7** PCI connector (PCI Express)
The connector allows the RAID controller to be connected to a PCI slot (PCI Express) in the server.

4. Hardware Setup

Install the RAID controller in a server in the following procedure.



Check

Before the installation, always refer to the User's Guide of the server. The job flow varies depending on the server type or system configuration. Check the server type and system configuration before the installation to conduct setup correctly.

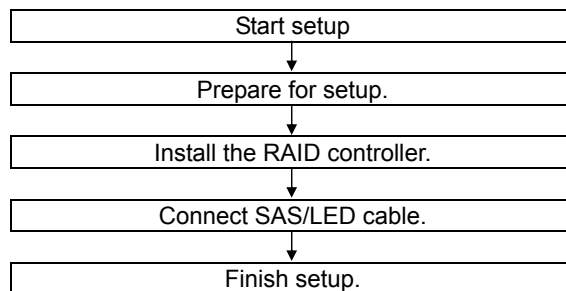

4-1. Prepare for setup



Notice

Note the following before the setup.

- Some limitation may be imposed to the installation on the PCI slot (PCI Express) depending on the type of the server. Before the installation, check the limitation following the Server User Guide.
- HDDs to be connected to the disk array controller should have the same specification. Contact your service representative for HDDs which can be connected to the disk array controller.
- Coexistence with other PCI boards (including disk array controller, mirroring board, and SCSI controller) may be limited. Before using the disk array controller together with other PCI boards, ask your service representative whether the disk array controller can coexist with the other PCI boards.

1. Exit from all applications and shutdown the OS.
2. Press the POWER switch on the server to power off the server.
3. Pull out all the power cords connected to the power unit of the server.
4. Remove the side cover on the server as described in the Server User Guide.



Check

For the installation or removal of the side cover and other components on the server, refer to the Server User Guide.

4-2. Selecting and Installing a Bracket

The card is shipped with a factory-installed full-height PCI bracket.

To install the card in a low-profile PCI slot, the full-height PCI bracket should be replaced with the low-profile PCI bracket.

1. Remove the screws (2) fixing the full-height PCI bracket to the card.
2. Remove the full-height PCI bracket.
3. Install the low-profile PCI bracket on the card.
4. Secure the low-profile PCI bracket with the screws (2) removed in step 1.

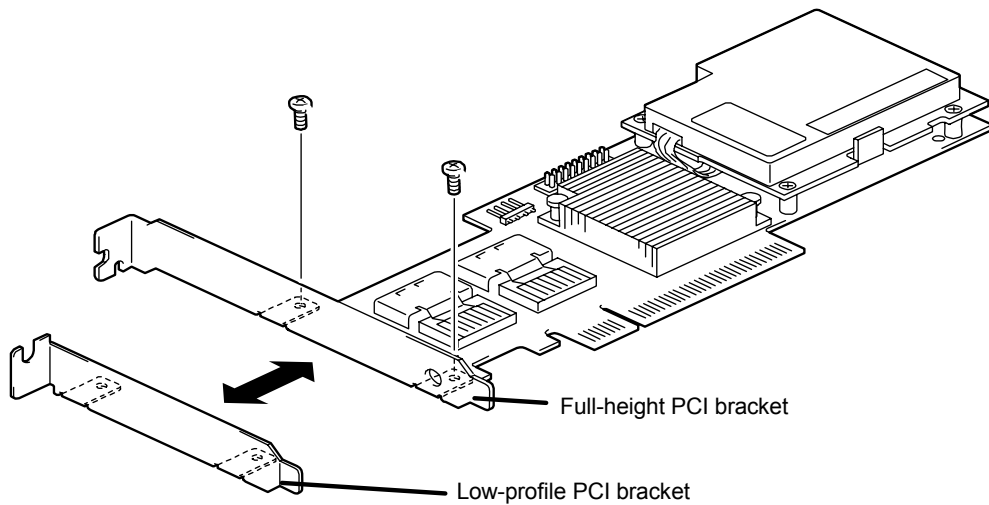

Tips

Use the same procedure to replace the low-profile PCI bracket with the full-height PCI bracket.

4-3. Installing the Disk Array Controller

Confirm the position of the PCI slot (PCI Express) in which you wish to install the disk array controller and remove the corresponding additional slot cover.



Notice

- Store the removed additional slot cover carefully. Keep the removed screw, it will be used to install the disk array controller.
- The disk array controller does not support the PCI hot-plug feature. Before installing or removing the disk array controller from the server, always power off the server and pull out the power cord from the receptacle.



Check

Some limitations may be imposed to the installation on the PCI slot depending on the type of the server. Before the installation, check the limitations in the Server User Guide.

Insert the disk array controller into the PCI slot (PCI Express) securely and fix it. To fix the disk array controller with screws, use the screw removed when the additional slot cover is removed.

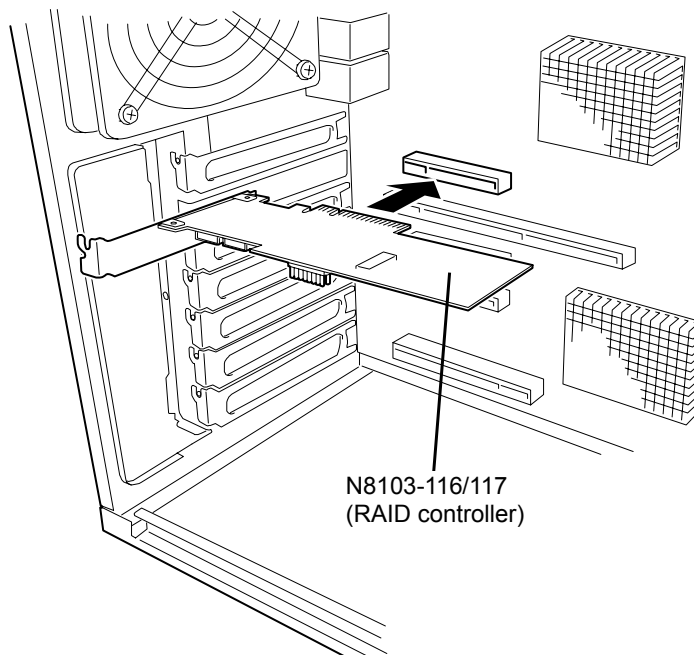

Example: Tower Model Server



Notice

- When the RAID controller cannot be easily inserted into the PCI slot (PCI Express), pull out it once and insert it again. Note that the disk array controller may be damaged if excess force is applied to it.
- Do not push or pull on the RAID Battery Backup Unit during the installation or removal of the RAID controller.

4-4. Connecting the SAS Cable

Connect the SAS cable to the SAS connector on the disk array controller. For the connection, see the figure below and the connection table. For the connection to the server, refer to the Server User Guide.

If it is hard to connect the cable, pull out the RAID controller from the PCI slot (PCI Express) once and connect the cable to the RAID controller.

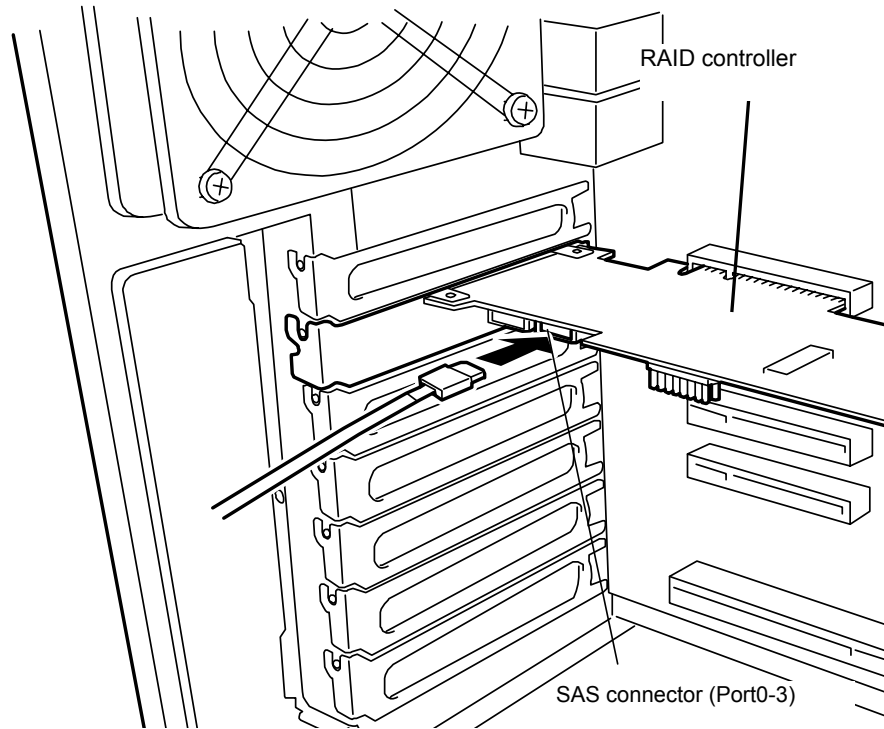

Example: Tower Model Server



Port numbers are predefined according to the physical location of HDD. When connecting the disk array controller to the server with the SAS cable, check if the cable connector is appropriate to the port number. Connecting an incorrect cable may cause a malfunction of the device. Refer to the Server User Guide for the server port numbers.

4-5. Connecting the LED Cable

Connect the LED cable coming with the server to the HDD LED connector. Refer to the figure and table below.

For the connection to the motherboard, refer to the User's Guide of the server. If it is hard to connect the LED cable, pull out the card from the PCI (or PCI Express) slot once and connect the cable to the card.

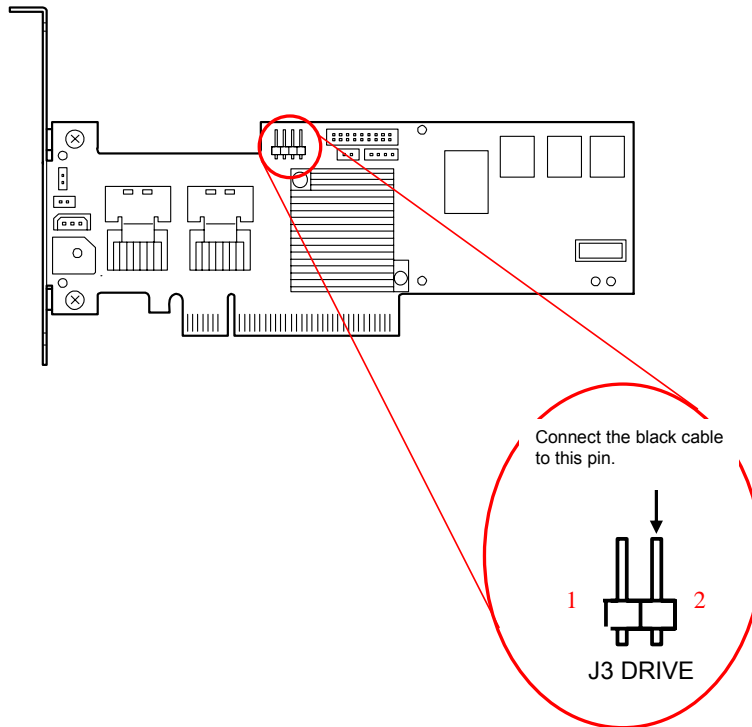

LED cable connection table

		LED cable (coming with server)
HDD LED connector	Pin 1	Not used
	Pin 2	Connected with black cable

Chapter 2 RAID

This chapter describes the RAID features which the disk array controller supports.

1. Overview of RAID

1-1. What is RAID (Redundant Array of Inexpensive Disks)?

RAID is an abbreviation for "Redundant Array of Inexpensive Disks". The RAID technology allows several hard disk drives (HDDs) to be handled collectively.

RAID can configure several HDDs (at least 2) as a single array (disk group) to operate the HDDs effectively. This ensures higher performance than a single HDD of a large capacity.

This disk array controller has a feature to divide a single disk group into several logical drives (up to 40 virtual disks). The host computer recognizes these virtual disks as if it were a single HDD, and can access in parallel several HDDs configuring a disk group.

Some RAID levels can recover data from remaining data and parity by using a rebuild feature if an error occurs in a single HDD. This ensures a high system reliability.

1-2. RAID Levels

There are several RAID levels on the market, and the disk array controller supports the following ones: RAID 0, RAID 1, RAID 5, RAID 6, RAID 10, and RAID 50.

The number of HDDs required to create a disk group varies depending on the RAID level as shown in the table below.

RAID level	Number of required HDDs	
	Min.	Max.
RAID 0	1	8
RAID 1	2	2
RAID 5	3	8
RAID 6	3	8
RAID 10	4	8
RAID 50	6	8



Tips

- When making a logical disk of RAID6 with HDD3, we recommend you use WebBIOS.
- For more information on the RAID levels, see "2. RAID Levels" described later in this chapter.



Notice

The RAID levels 5, 6, and 50 are supported only when the optional upgrade key is installed.

1-3. Disk Group

A disk group consists of at least 2 HDDs.

Up to eight disk groups are permitted by the disk array controller when eight HDDs are installed in the server.

The figure below shows a sample configuration. The three HDDs are connected to the disk array controller, creating one disk group (DG).

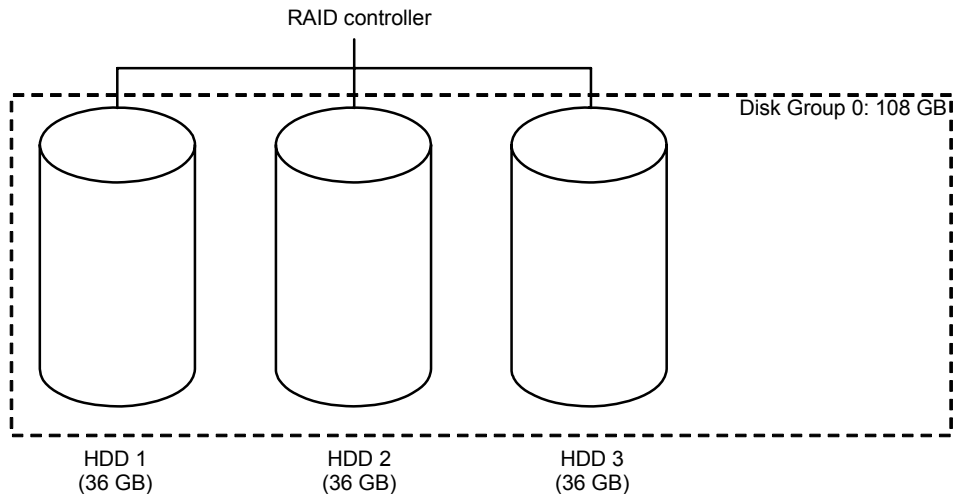

1-4. Virtual Disk

A virtual disk is a logical drive defined in a disk group. It is recognized as a physical drive by the OS. Up to 64 virtual disks are permitted by the RAID controller. The maximum number for each disk group is 16.

The figure below shows a sample configuration in which the RAID controller is connected with three HDDs, creating one disk group (DG). Two RAID5 virtual disks (VD) are defined in the DG.

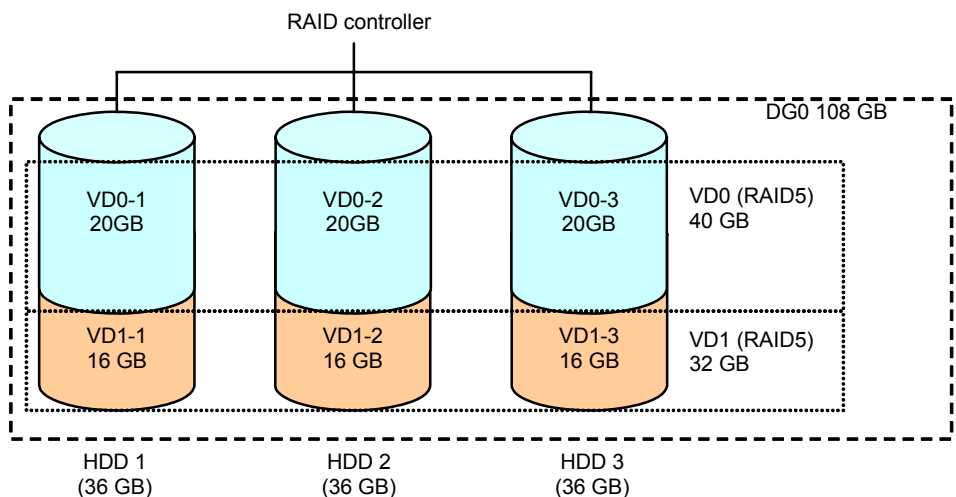

1-5. Parity

Parity implies redundant data. A single set of redundant data is created from the data saved in more than one HDD.

The redundant data is used for data recovery when a HDD is defective.

1-6. Hot-Swap

The hot-swap feature enables a HDD to be removed (or replaced) under system operation.

1-7. Hot-Spare Disk

The hot-spare disk is prepared as an auxiliary HDD substituting for a defected HDD included in a logical drive which is configured at a redundant RAID level. When a HDD fault is detected, the system disconnects the HDD (turns it offline) and starts rebuild the data on the hot-spare disk.



Tips

To rebuild using hot-spare disks (standby rebuild), see "Chapter 3 Disk Array Controller Features".

1-8. Write Cache Setting (Write Policy)

- You can select the following 3 settings for the write policy of the virtual disks.

(1) Write Back with battery

This setting is available if the controller is connected to the RAID Battery Backup Unit. The write access performance can be much better than in the write thru mode. If the battery is either charging, bad, or missing, the virtual disks will run in write thru mode.

(2) Write Thru

We recommend this setting if the controller is not connected to the battery. If you feel that it takes much longer to write data to your VD's than to read data from them, we recommend you to connect the battery.

(3) Constant Write Back

This setting is available whether the battery is present or not. However data in cache memory on the controller will be discarded if the battery is either charging, bad, missing or if a learn cycle is being executed. Please provide a UPS unit to protect your system from a power failure.



Tips

- For write cache setting, see "Chapter 3 Features of RAID Controller".
- The battery is not fully charged when you purchase it. If you selected 'Write Back with battery', please keep the system running for about 9 hours until the current write policy becomes write back.
- When you select "Write Back with battery" equipped with the battery, please note the data of the cache memory may disappear if a power failure occurs while the battery is breaking down or charging.



Tips

When OS is Linux, no information on the source, Type, and event ID is displayed in the system log (syslog). Only the content of the explanation column is recorded.

2. RAID Levels

This section details the RAID levels supported by the disk array controller.

2-1. RAID Levels Characteristics

The table below lists the characteristics of the RAID levels.

Level	Function	Redundancy	Characteristics
RAID0	Striping	No	Data read/write at the highest rate Largest capacity Capacity: (capacity of single HDD) × (number of HDDs)
RAID1	Mirroring	Yes	Two HDDs required Capacity: capacity of single HDD
RAID5	Striping of both data and redundant data	Yes	Three or more HDDs required Capacity: (capacity of single HDD) × ((number of HDDs) - 1)
RAID6	Striping of both data and redundant data	Yes	Three or more HDDs required Capacity: (capacity of single HDD) × ((number of HDDs) - 2)
RAID10	Spanning of RAID1	Yes	Four or more HDDs required Capacity: (capacity of single HDD) × ((number of HDDs) ÷ 2)
RAID50	Spanning of RAID5	Yes	Six or more HDDs required Capacity: (capacity of single HDD) × ((number of HDDs) - 2)



Tips

When making a logical disk of RAID6 with HDD3, we recommend you use WebBIOS.

2-2. RAID0

In RAID 0, the data to be recorded is distributed to HDDs. This mode is called "striping".

In the figure below, data is recorded in stripe 1 (disk 1), stripe 2 (disk 2), and stripe 3 (disk 3)... in that order. Because RAID0 allows all the HDDs to be accessed collectively, it provides the best disk access performance.



RAID 0 cannot have data redundancy. If a HDD is defective, the data saved in the HDD cannot be recovered.

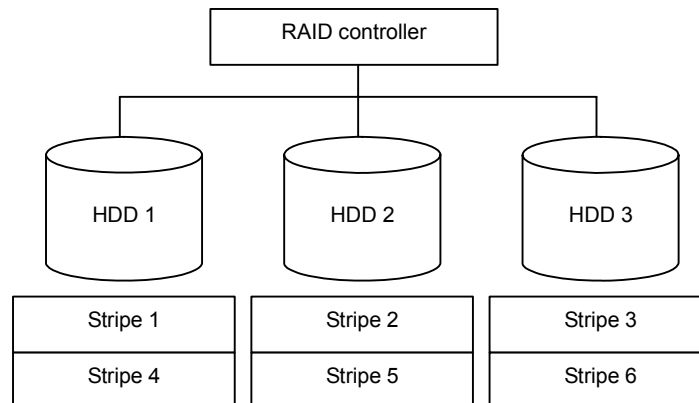

2-3. RAID1

In the RAID1 level, data saved in a HDD is written to another HDD without change. The mode is called "mirroring".

When data is written onto a single HDD, the same data is written onto another HDD. If either of the HDDs is defective, the other HDD containing the same data can substitute for the defective HDD, allowing the system can continue to operate without interruption.

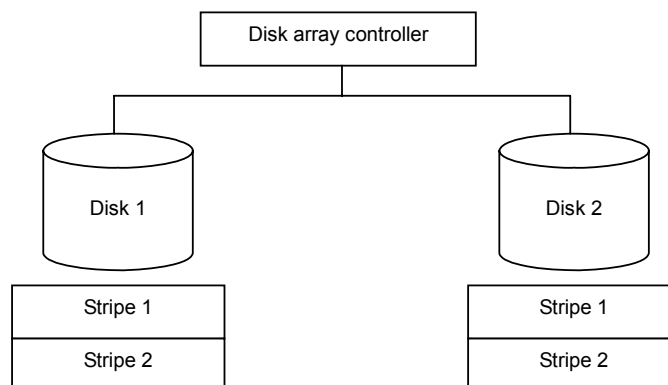

2-4. RAID5

In RAID5, data is distributed to HDDs by striping and, at the same time, the parity (redundant data) is distributed to the HDDs. This mode is called "striping with distributed parity".

Each of stripe x, stripe x+1, and parity (x, x+1) created from stripe x and stripe x+1 is written onto a specific HDD. Accordingly, the total capacity assigned to the parity is just the same as the capacity of a single HDD. If any one of the HDDs configuring a logical drive is defected, data is still available with no problems.

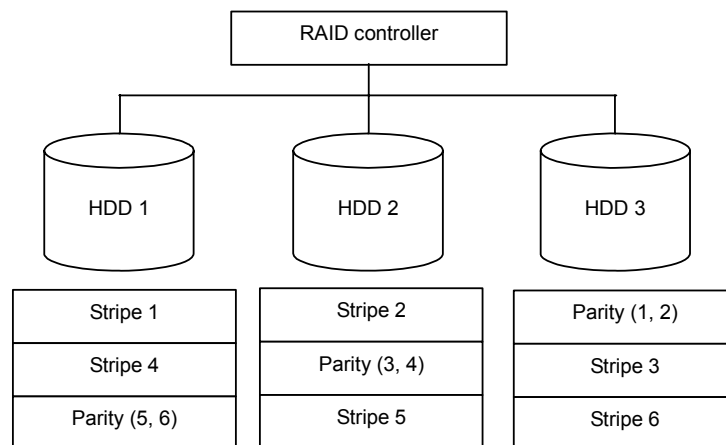

2-5. RAID6

A RAID 6 extends RAID 5 by adding an additional parity block (Q) created by different calculation methods, such as weighting by some factor, thus it uses block-level striping with two parity blocks distributed across all member disks.

This mode is called "striping with duplex and distributed parity". Accordingly, the total capacity assigned to the parity is just the same as the capacity of two HDDs. If any two of the HDDs configuring a logical drive are defected, data is still available with no problems.

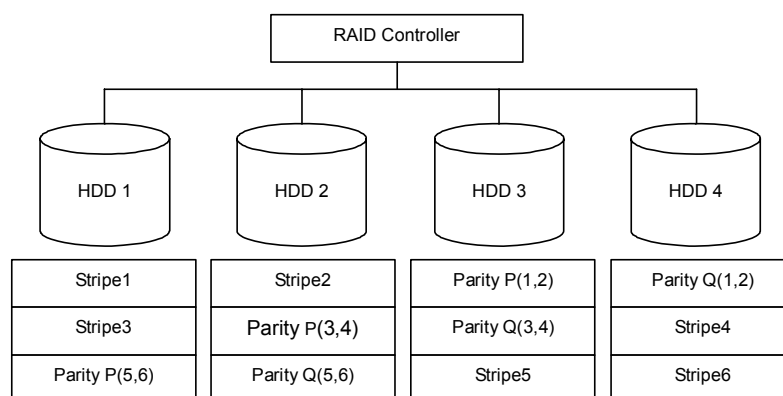

RAID levels 5, 6, and 50 are supported only when the optional RAID 5/6 upgrade key is installed.

2-6. RAID10

Data to be recorded is distributed to two HDDs in mirroring mode. Then, each mirrored data is written onto HDD by striping. Owing to this feature, the high disk access performance of RAID0 and, in addition, the high reliability of RAID1 can be achieved.

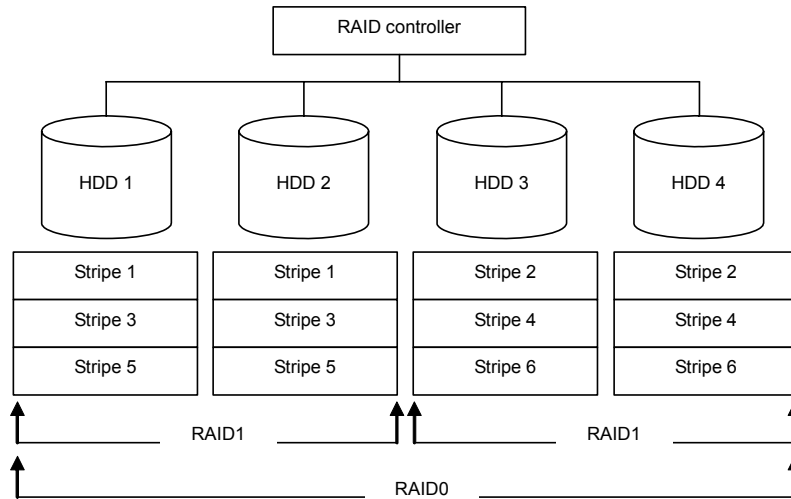

2-7. RAID50

The data is distributed to the HDDs by striping with distributed parity, and then written onto the HDDs by striping. Owing to this feature, the high disk access performance of RAID0 and, in addition, the high reliability of RAID5 can be achieved.

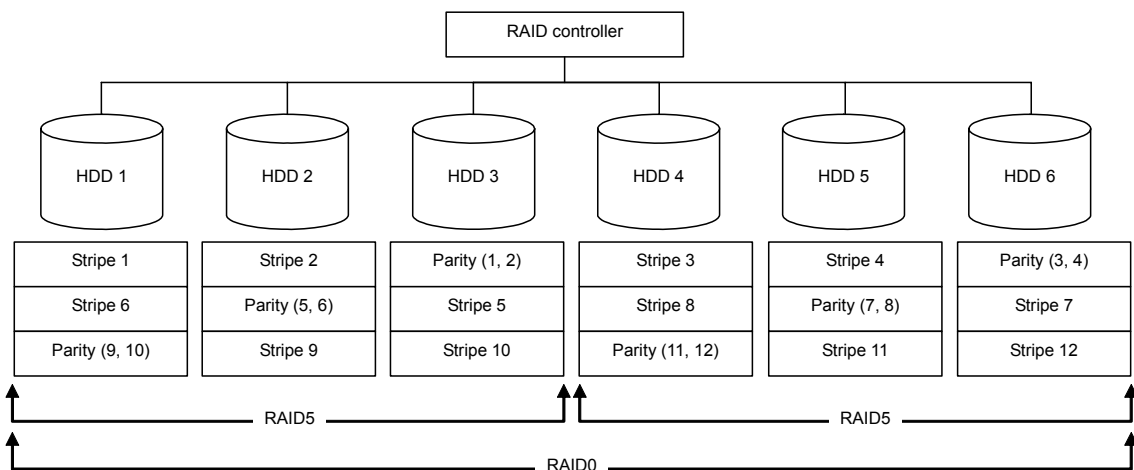

Chapter 3 RAID Controller Features

This chapter describes the RAID controller features.

1. Rebuild

The rebuild feature can recover the data in a defective HDD. The rebuild can be applied to redundant virtual disks in the RAID1, RAID5, RAID6, RAID10 or RAID50 level.

1-1. Manual Rebuild

The manual rebuild can be performed using the MegaRAID Storage Manager™, the management utility of the RAID controller. Select a HDD and start the rebuild manually.

For more information, refer to the "MegaRAID Storage Manager™ User's Guide" in the ExpressBuilder disc that comes with the server.

1-2. Auto Rebuild

The disk array controller automatically starts the rebuild without referring to any utility.

There are two different types of auto rebuild:

- Standby rebuild

Automatic rebuild by using hot-spare disks. In this configuration, the rebuild is performed automatically if a HDD assigned to a virtual disk is defective.

- Hot-swap rebuild

Automatic rebuild once the defective HDD has been hot-swapped with a functional one.



Notice

Note the following for the rebuild:

- The HDD used for rebuild should have the same capacity, rotation speed, and standard as the defective HDD.
- During rebuild, the processing rate is decreased.
- During rebuild, do not shutdown or reboot the server. If the server is shutdown by an unforeseen accident such as a power interruption, turn on the power again as soon as possible. The rebuild is automatically restarted.
- The interval between the removal of the defective HDD and the installation of a substitute HDD should be 60 sec or longer.
- If the hot-swap rebuild does not function, perform the manual rebuild.
 - Hard disk drive with partitions
 - Hard disk drive used for another arrayPrepare another new hard disk drive or a formatted hard disk drive.

2. Patrol Read

The patrol read is a read & verify test in the entire HDD area. It can be performed for all HDDs assigned to virtual disks and hot-spare disks.

The Patrol Read allows subsequent defects of HDDs to be detected and repaired.

For HDDs configuring redundant virtual disks or those assigned to hot-spare disks, error sectors detected during the Patrol Read can be repaired.



Notice

Note the following for the patrol read:

- The Patrol Read feature is factory-set to "Disabled".
- For the detailed operation, refer to the "MegaRAID Storage Manager™ User's Guide" in ExpressBuilder disc that comes with the server.

3. Consistency Check

The Consistency Check is used to check consistency among virtual drives. It is available for redundant virtual drives in the RAID1 or RAID5 level.

The Consistency Check can be performed through WebBIOS or the MegaRAID Storage Manager.

The Consistency Check performs a consistency check and can also repair some sector errors. It can also be used as a preventive maintenance.



Notice

Note the following for the Consistency Check:

- During the Consistency Check, the processing rate is decreased.
- If the system is restarted, the Consistency Check is aborted. However, the Consistency Check resumes after restart.
- To schedule the execution of a Consistency Check, use WebBIOS, or the MegaRAID Storage Manager.

4. Background Initialize

The Background Initialize is automatically executed when the RAID5 virtual disk is created in a disk group composed of five or more HDDs.

The Background Initialize performs the parity generation processing to the area not initialized in the background. It is equivalent to the Consistency Check.

The Background Initialize is not required in the following cases.

- Full Initialize has already been executed and completed normally.
(* Full Initialize is a function to clear the entire area of a virtual disk with "0".
- Consistency Check has already been executed and completed normally.
- Rebuild has already been executed and completed normally.
- "Yes" is specified for "Disable BGI" in VD Definition.

The Background Initialize is executed again if any of the following cases occurred in the virtual disk on which the Background Initialize has completed.

- When the virtual disk is degraded or offline, you execute Make Online to a HDD in offline status, and the virtual disk becomes Optimal state.
- When you replace the disk array controller with the maintenance parts and others.
- When you execute Reconstruction to an existing virtual disk to make RAID5 VD with five or more HDDs.
- When you execute Reconstruction to existing virtual disk to make RAID6 VD with seven or more HDDs.



Note the following for Background Initialize:

- During Background Initialize, the processing rate is decreased.
- Background Initialize will resume a few minutes later if it is interrupted.

5. Reconstruction

The reconstruction feature is used to change the configuration and/or RAID level of existing virtual disk. Reconstruction usually includes three features, however, the RAID controller only supports "Migration with addition".



Use WebBIOS for Reconstruction.

5-1. Removed physical drive

Unsupported.

5-2. Migration only

Unsupported.

5-3. Migration with addition

Use this feature to add HDDs to an existing virtual disk. The execution patterns are as shown below (α : Number of HDDs to be added).

Before execution		After execution		Description
RAID level	Numver of HDDs	RAID level	Number of HDDs	
RAID0	X	RAID0	$x+\alpha$	Capacity increased : equivalent to α HDDs.
RAID0	1	RAID1	2	Capacity remains unchanged.
RAID0	X	RAID5	$x+\alpha$	Capacity increased : equivalent to $\alpha-1$ HDDs.
RAID0	X	RAID6	$x+\alpha$ ($\alpha=2$ or more)	Capacity increased : equivalent to $\alpha-2$ HDDs.
RAID1	2	RAID0	$2+\alpha$	Capacity increased : equivalent to $\alpha+1$ HDDs.
RAID1	2	RAID5	$2+\alpha$	Capacity increased : equivalent to α HDDs.
RAID1	2	RAID6	$2+\alpha$	Capacity increased : equivalent to $\alpha-1$ HDDs.
RAID5	X	RAID0	$x+\alpha$	Capacity increased : equivalent to $\alpha+1$ HDDs.
RAID5	X	RAID5	$x+\alpha$	Capacity increased : equivalent to α HDDs.
RAID5	X	RAID6	$x+\alpha$	Capacity increased : equivalent to $\alpha-1$ HDDs.
RAID6	X	RAID0	$x+\alpha$	Capacity increased : equivalent to $\alpha-2$ HDDs.
RAID6	X	RAID5	$x+\alpha$	Capacity increased : equivalent to $\alpha+1$ HDDs.
RAID6	X	RAID6	$x+\alpha$	Capacity increased : equivalent to α HDDs.



Note the following for the Reconstruction:

- Be sure to make a backup copy of the data and to perform a Consistency Check before starting Reconstruction.
- The Reconstruction is disabled in a configuration in which several virtual disks are defined in one disk group
- During Reconstruction, the processing rate is decreased.
- The Reconstruction is disabled for the degraded virtual disk. First execute Rebuild to recover the virtual disk, then execute Reconstruction.
- During Reconstruction, do not shutdown or reboot the server. If the server is shutdown by an unforeseen accident such as power interruption, turn on the power again as soon as possible. The Reconstruction is automatically restarted.
- In some configuration, Background Initialize may start automatically upon the completion of the reconstruction.

Ex: Migration with addition for RAID5 virtual disk

The figure below shows an example, in this case adding a single 36GB HDD to a RAID5 virtual disk configured with three 36GB HDDs.

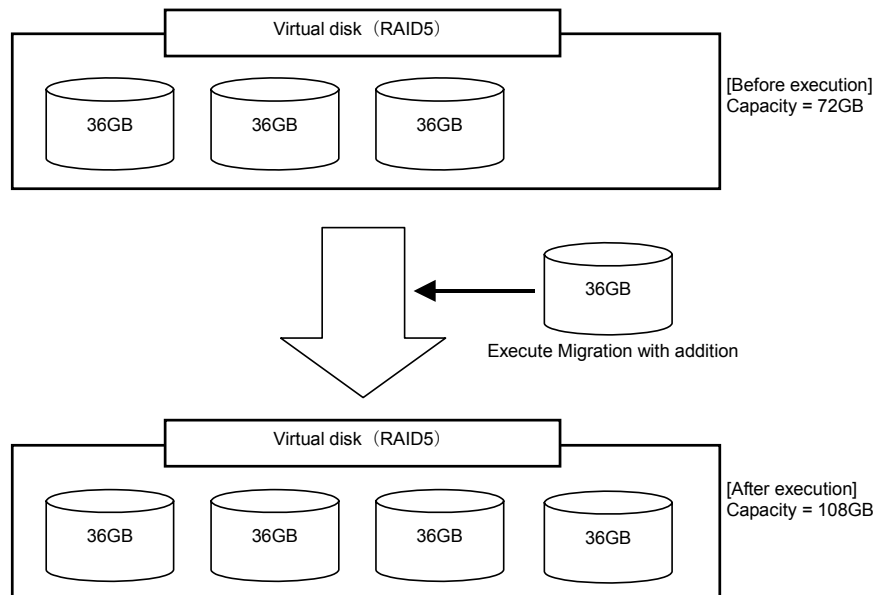

Chapter 4 Creating a Virtual Disk

This section describes the configuration utility "WebBIOS".

1. Before Using WebBIOS

Read the following sections describing the supported functions and the recommended precautions before using "WebBIOS".

1-1. Supported Functions

- Indication of model name and capacity of hard disk drive (called HDD hereafter)
- Indication of HDD allocation status
- Creation of virtual disk
- Setting of RAID level
- Setting of Stripe Block size
- Setting of Read Policy/Write Policy/IO Policy
- Indication of configuration information and status of virtual disk
- Removal of virtual disk
- Clearing of configuration
- Execution of initialization
- Execution of Consistency Check
- Execution of manual rebuild
- Execution of reconstruction

1-2. Notes on Creating a Virtual Drive

The HDDs configuring the disk group should have the same capacity and rotation speed.

- Be sure to execute a Consistency Check after creating a VD.
- When installing an OS in a VD under the disk array controller, create a VD dedicated to the OS installation.
- The physical drive numbers shown in WebBIOS are identified as follows.

Slot number shown in Physical Drives box*

* "X:X:X" shown in Physical Drives box represents the Connector number:Enclosure number:Slot number. With this server, the connector number is always "()", and the enclosure number is always "1". The slot number are identical (between 0 and 7), and represent a disk bay slot number.

Physical Drives View of WebBIOS

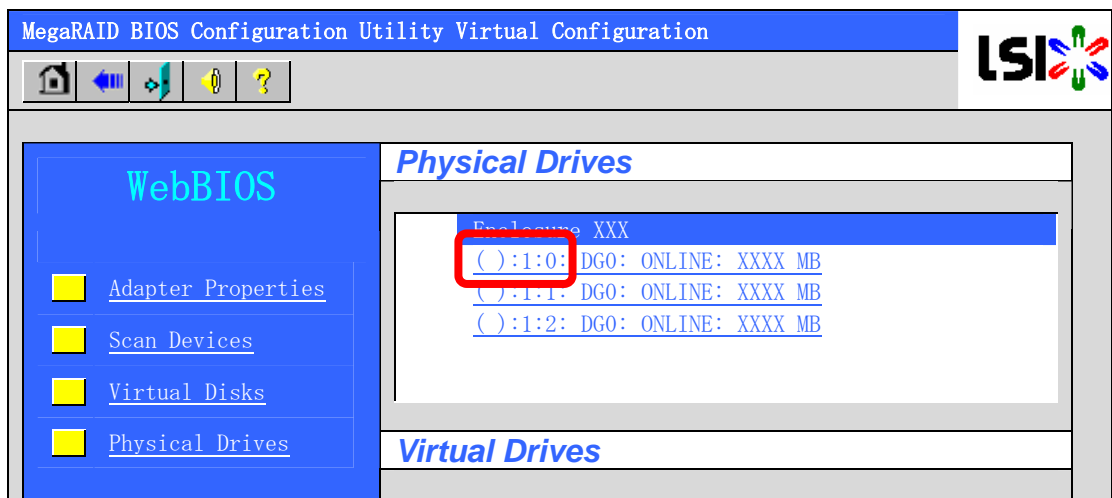

2. Using WebBIOS

2-1. Starting WebBIOS

1. Power on the system. Press **Esc** when prompted to do so in order to view diagnostic messages.
2. Press **Ctrl + H** on POST screen to start WebBIOS.

POST screen image (with no virtual disk assigned)

```
LSI MegaRAID SAS - MFI BIOS Version XXXX (Build MMM DD, YYYY)
Copyright (c) 2007 LSI Corporation
HA - X (Bus X  Dev X)  MegaRAID SAS 8708EM2
FW package: X.X.X - XXXX

0 Logical Drive(s) found on the host adapter.
0 Logical Drive(s) handled by BIOS.
Press <Ctrl> <H> for WebBIOS.
```



Do not press unnecessary keys, such as **Pause** during POST.

2-2. Main Menu

Shown below is the [Adapter Selection] screen that appears first on WebBIOS. Select a controller to operate WebBIOS, and click [Start].

Adapter Selection					
Adapter No.	Bus No	Device No	Type	Firmware Version	
0.	<input type="checkbox"/>	XX	XX	MegaRAID SAS 8708EM2	X.XX.XX - XXXX
1.	<input type="checkbox"/>	XX	XX	MegaRAID SAS 8708EM2	X.XX.XX - XXXX
<input type="button" value="Start"/>					

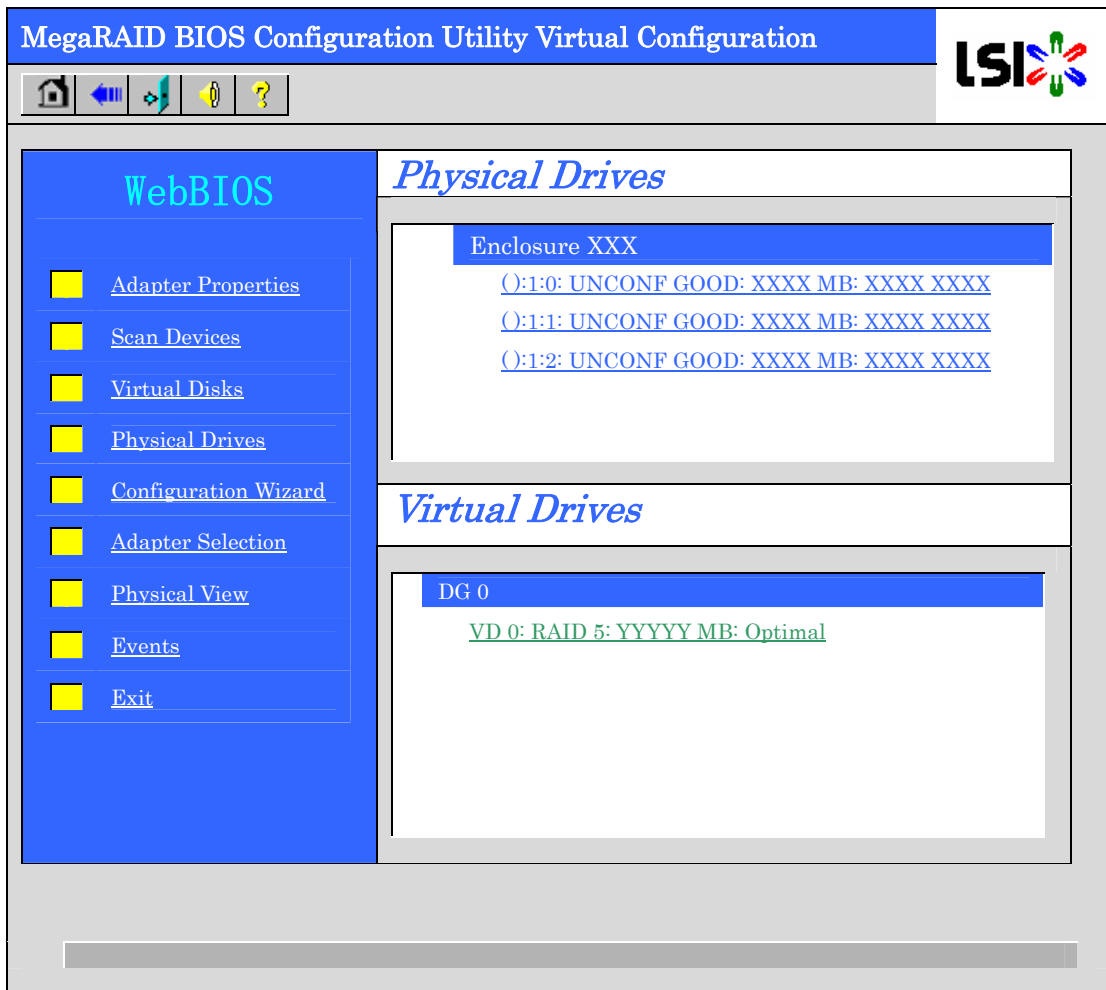

When the adapter is selected on [Adapter Selection], the WebBIOS Top Menu appears.



“X:X:X” shown in Physical Drives box represents the Connector number:Enclosure number:Slot number. With this server, the connector number is always “()”, and the enclosure number is always “1”.The slot number are identical (between 0 and 7), and represent a slot number of the disk bay.

2-3. Adapter Properties

When you click [Adapter Properties] on The WebBIOS Top Menu, the configuration information for the disk array controller is displayed.

MegaRAID BIOS Configuration Utility Adapter Information		LSI 	
			
MegaRAID SAS 8078EM2			
Firmware Version X.XX.XX-XXXX		WebBIOS Version X.XX-XXX	
Sub Vendor ID	0x1000	Sub Device ID	0x1003
Host Interface	PCIE	Port Count	8
NVRAM Size	32 KB	Memory Size	128 MB
Firmware Time	XXX XX XXXX:XX:XX:XX	Serial Number	XXXXXXXXXX
Min Stripe Size	8 KB	Max Stripe Size	1024KB
Virtual Disk Count	XX	Physical Disk Count	XX
Firmware Package Version		X.X.X-XXXX	
<input type="button" value="Next"/>			
<input type="button" value="Home"/>		<input type="button" value="Back"/>	

Click [Next] to see the detailed settings of this controller.

MegaRAID BIOS Configuration Utility Adapter Properties		LSI	
Properties			
Battery Back Up	Present	Coercion Mode	None ▼
Set Factory Defaults	No ▼	PDF Interval	300
Cluster Mode	Disabled ▼	Alarm Control	Disabled ▼
Rebuild Rate	30	Patrol Read Rate	30
BGI Rate	30	Cache Flush Interval	4
CC Rate	30	Spinup Drive Count	2
Reconstruction Rate	30	Spinup Delay	12
Adapter BIOS	Enabled ▼	Stop On Error	Disabled ▼
<input type="button" value="Submit"/> <input type="button" value="Reset"/> <input type="button" value="Next"/>			
<input type="button" value="Home"/>		<input type="button" value="Back"/>	

The detailed settings are continued on the next page. Click [Next] to view more information.

MegaRAID BIOS Configuration Utility Adapter Properties		LSI	
Properties			
Stop CC On Error	No ▼	Schedule CC	Supported
Maintain PD Fail History	Disabled ▼		
<input type="button" value="Submit"/> <input type="button" value="Reset"/>			
<input type="button" value="Home"/>		<input type="button" value="Back"/>	

Default settings and their explanation

Item	Default	Description	Change
Battery Backup	Present None	Displays Properties of the additional battery. When the battery is installed: Present When the battery is not installed: None	-
Set Factory Defaults	No Yes	Restores factory defaults.	Prohibited *1
Cluster Mode	Disabled	-	Prohibited
Rebuild Rate	30	Recommended value: 30	Permitted
Patrol Read Rate	30	Recommended value: 30	Permitted
BGI Rate	30	Recommended value: 30	Permitted
CC Rate	30	Recommended value: 30	Permitted
Reconstruction Rate	30	Recommended value: 30	Permitted
Adapter BIOS	Enabled Disabled	-	Prohibited
Coercion Mode	None 128MB-way 1GB-way	-	Prohibited
PDF Interval	300	-	Prohibited
Alarm Control	Disabled Enabled Silence	Silence: The alarm is stopped.	Permitted
Cache Flush Interval	4	-	Prohibited
Spinup Drive Count	2	-	Prohibited
Spinup Delay	12	-	Prohibited
StopOnError	Disabled Enabled	-	Prohibited
Stop CC On Error	No Yes	Specify the operation at error detection in Consistency Check. No: Recover and resume. Yes: Abort	Permitted
Maintain PD Fail History	Disabled Enabled	-	Prohibited
Schedule CC	Supported	Set the scheduled consistency check	Permitted

*1 Do not perform "Set Factory Defaults". If performed, the factory-set values will no longer be restored.

How to change a setting value

On the [Adapter Properties] screen, change a parameter to the desired value, and then click [Submit] at the center of the screen to determine the new value.

The status of "Battery Backup" is indicated as "Present". Clicking [Present] opens the Battery Status screen shown below.

MegaRAID BIOS Configuration Utility Battery Module		LSI	
<div style="display: flex; justify-content: space-between; align-items: center;"> </div>			
Battery Type: iBBU Voltage: XXXXX mV Current: X Temperature: XX deg centigrade Status: Gas Gauge Status : xxxxxxxxx Fully Charge Capacity remaining : XX% Design Charge Capacity remaining : XX% Expected margin of error :X%	Design Info Mfg Name: LSIC10000A Mfg Date: MM/DD/YYYY Serial No: XXXX Design Capacity: 880mAh Design Voltage: 4800mV Device Name: 5810-2 Device Chemistry: NiMH		
Capacity Info FullCharge Capacity: XXXmAh Remaining Capacity: XXXmAh	Properties Auto Learn Period (days) 30 Next Learn Time XX/XX/XXXX;XX/XX/XX Learn Delay Interval (hrs) <input type="text" value="0"/> Auto Learn Mode <input type="text" value="Disabled"/> <div style="text-align: center; margin-top: 10px;"> <input type="button" value="Go"/> </div>		
<input type="button" value="Home"/>		<input type="button" value="Back"/>	



You cannot change the values for "Auto Learn Period", "Next Learn Time", and "Learn Delay Interval".



- The Status field shows "Charging" when the battery is in charged status. It shows "Discharging" when the battery is in discharged status.
- When powering on the server after a battery replacement, the Status may not immediately change to "Charging". In that case, power on the server for several hours, and check "Status" again.

2-4. Scan Devices

When you click [Scan Devices] on the WebBIOS top menu, the HDDs connected to the disk array controller are detected again. Use this feature when you have installed a new HDD while WebBIOS is running.



If the newly connected HDD contains other configuration information, [Foreign Configuration] screen shown below appears. To use the HDD as a new one, click [ClearForeignCfg] to clear the configuration information on the HDD.

MegaRAID BIOS Configuration Utility Foreign Configuration		LSI
1 Foreign Config(s) Found. Want to Import?		
Select Configuration	All Configurations ▼	
<input type="button" value="Preview"/> <input type="button" value="Clear"/> <input type="button" value="Cancel"/>		

2-5. Virtual Disks

When you click [Virtual Disks] on WebBIOS top menu, the screen for operating the VD that has already been configured appears.

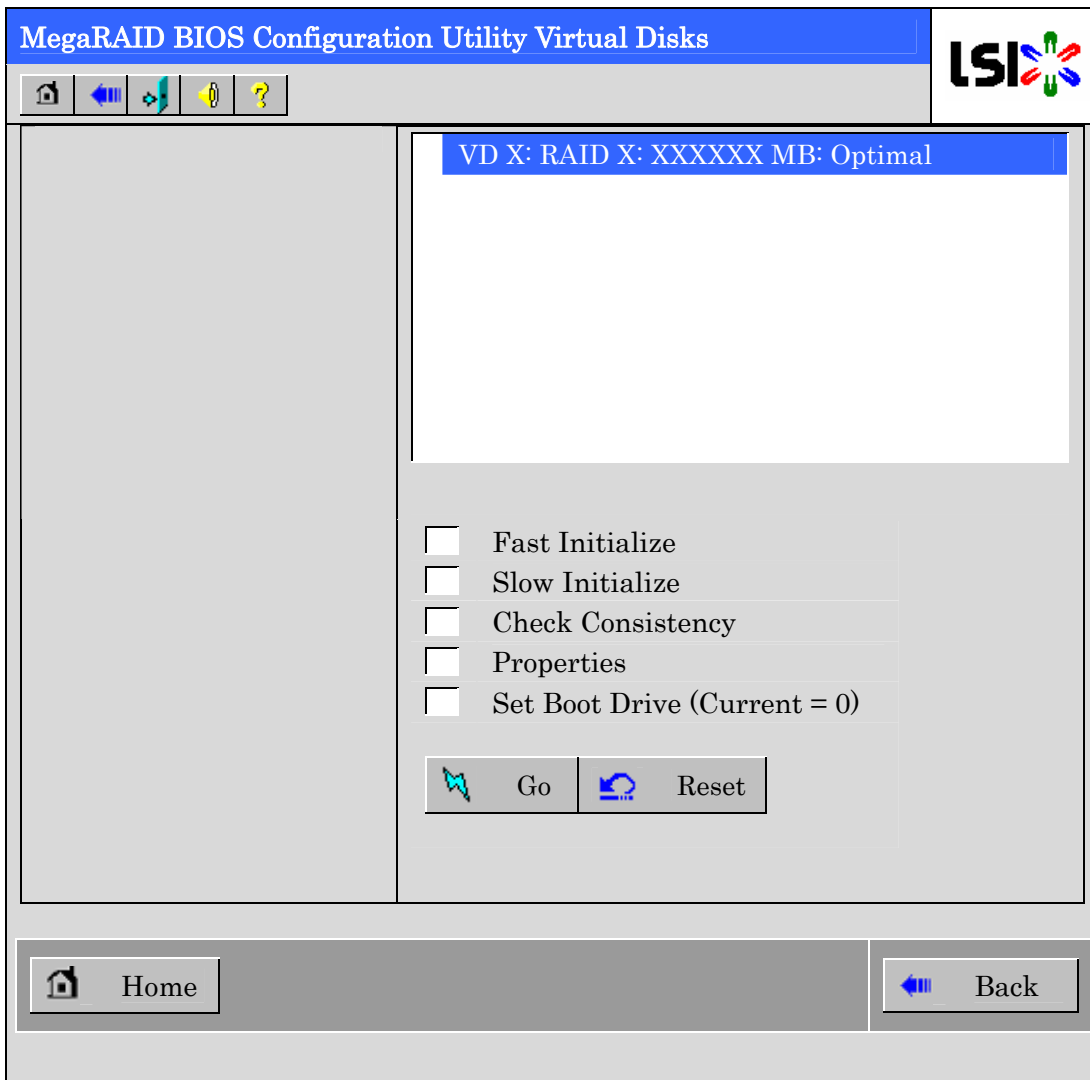

If no virtual disk exists, the upper right column of the screen will be blank. Use this menu only when a virtual disk exists.

2-6. Physical Drives

When you click [Physical Disks] on the WebBIOS top menu, the screen for operating the physical drive (HDD) connected to the disk array controller appears.

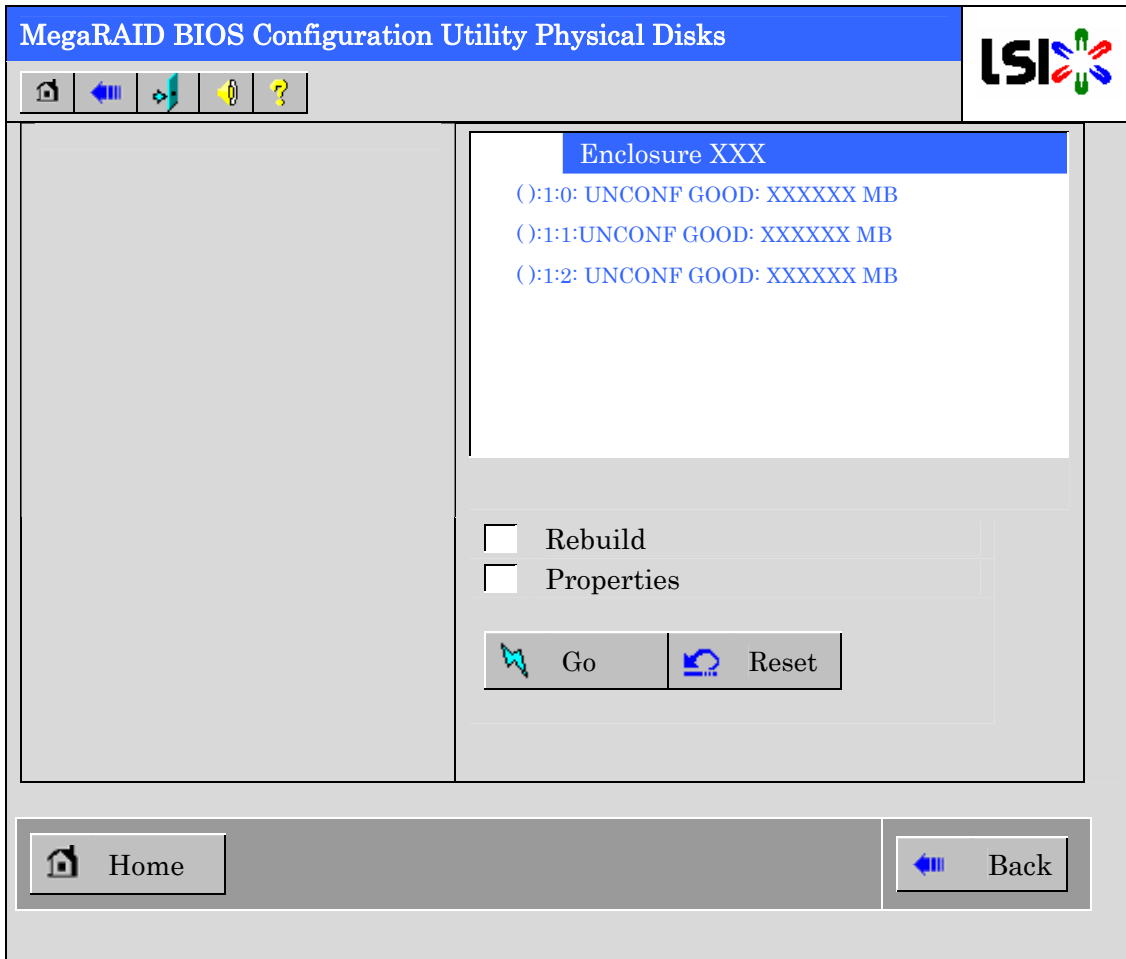

If no physical disk exists, the upper right column of the screen will be blank. Use this menu only when a physical disk exists.

2-7 Physical Drive Properties

Follow the procedure below to check the Physical Drive Properties. Shown below is an example to check the physical drive properties ():1:0.

- ① Click the Physical Drive you want to check.
- ② Click the checkbox for [Properties].
- ③ Click [Go].

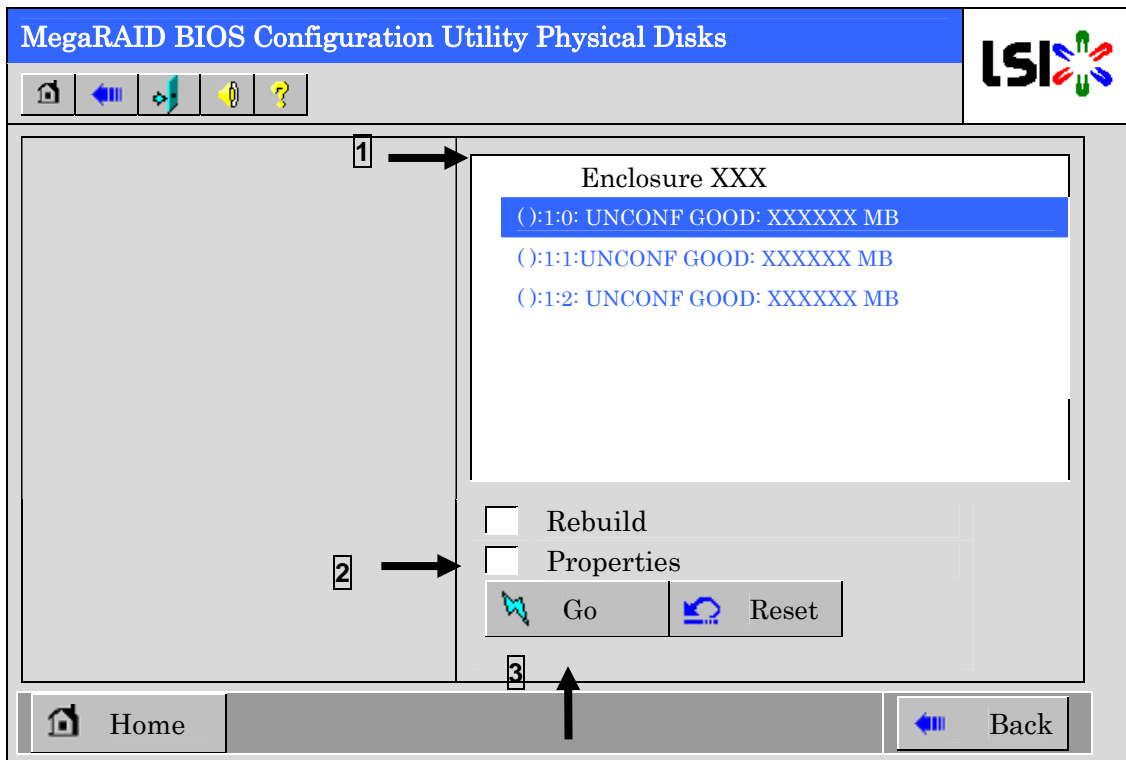

The Properties screen shown below appears.

MegaRAID BIOS Configuration Utility Physical Drive 0 





Revision	XXX
Enclosure ID	XXX
Slot Number	2
Device Type	Disk
Connected Port	0
Media Errors	XX
Pred Fail Count	XX
SAS Address	XXXXXX
Physical Drive State	UNCONF GOOD
Coerced Size	XXXXXX MB

 DG 0
DG 1

Make Drive Offline Locate

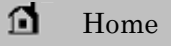
 Go

 Home  Back

2-8. Configuration Wizard

Use this wizard to configure a RAID using the HDDs connected to the RAID controller. The detailed explanation of this feature is given in "Configuring Virtual Disk".

2-9. Adapter Selection

If several RAID controllers are installed in the server, you need to select an adapter controlled by WebBIOS to configure each adapter. Clicking [Adapter Selection] on the WebBIOS top menu opens the [Adapter Selection] screen again.

2-10. Physical View / Logical View

If the virtual disk has been configured using the RAID controller, DG (disk group) is displayed on the WebBIOS top menu. Clicking [Physical View] displays information for the HDDs in the DG. Clicking [Logical View] displays the virtual disk in the DG.

2-11. Events

The Events screen is used to confirm the system events.



The disk array controller does not support the Events feature.

2-12. Exit

When you click [Exit] on the WebBIOS top menu, a confirmation screen to exit from WebBIOS is displayed. Click [Yes] to exit from WebBIOS.

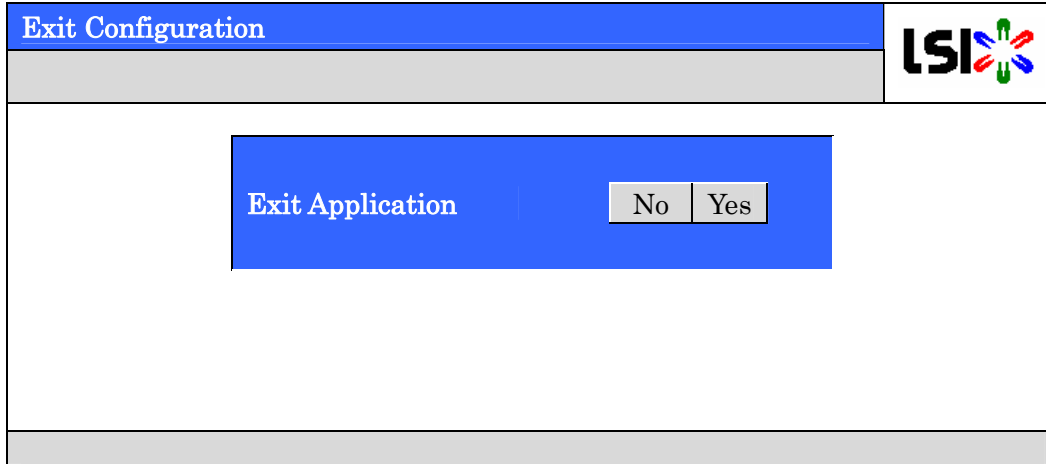

The screen shown below appears when WebBIOS is terminated. Restart the server.

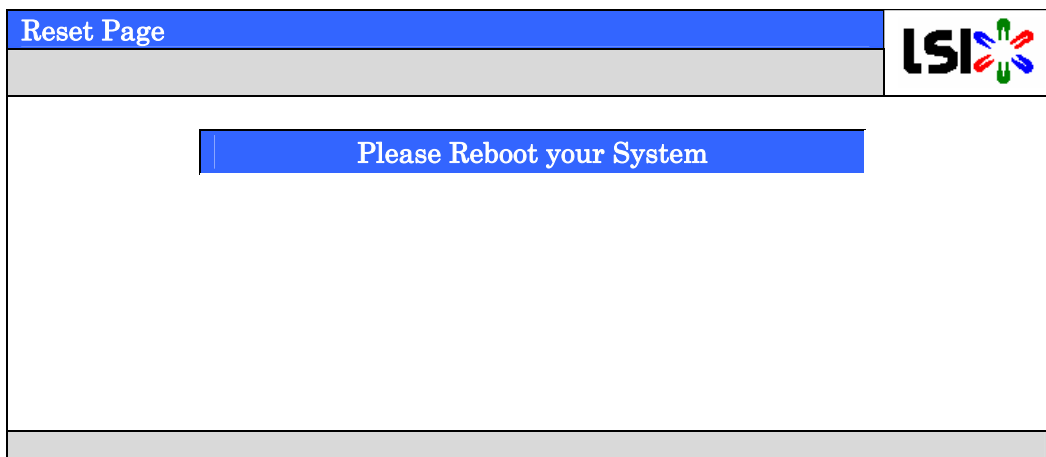

3. Configuring Virtual Disk

This section describes the procedures for the configuration of a VD (virtual disk) using WebBIOS.

3-1. Configuration Wizard

1. When you click [Configuration Wizard] on the WebBIOS top menu, the screen shown below appears. Select the relevant operation, and click [Next] at lower right of the screen.

MegaRAID BIOS Configuration Utility Configuration Wizard		LSI
Configuration Wizard guides you through the steps for configuration the MegaRAID System easily and efficiently. The steps are as follows:		
1. Array definitions	Group physical drives into arrays.	
2. Virtual Disk definitions	Define virtual disks using those arrays.	
3. Configuration Preview	Preview configuration before it is saved.	
Please choose appropriate configuration type:		
<input type="checkbox"/> Clear Configuration	Allows you to clear existing configuration only.	
<input type="checkbox"/> New Configuration	Clears the existing configuration. If you have any existing data in the earlier defined drives, the data will be lost.	
<input type="checkbox"/> Add Configuration	Retains the old configuration and then adds new drives to the configuration. This is the safest operation as it does not result in any data loss.	
		<input type="button" value="Cancel"/> <input type="button" value="Next"/>

Clear Configuration	Allows you to clear the existing configuration.
New Configuration	Clears the existing configuration and creates a new VD. If you have any existing data in the virtual disk defined earlier, the data will be lost.
Add Configuration	Retains the old configuration and then adds the new virtual disk.

2. When you select [New Configuration] or [Add Configuration], the screen shown below appears.

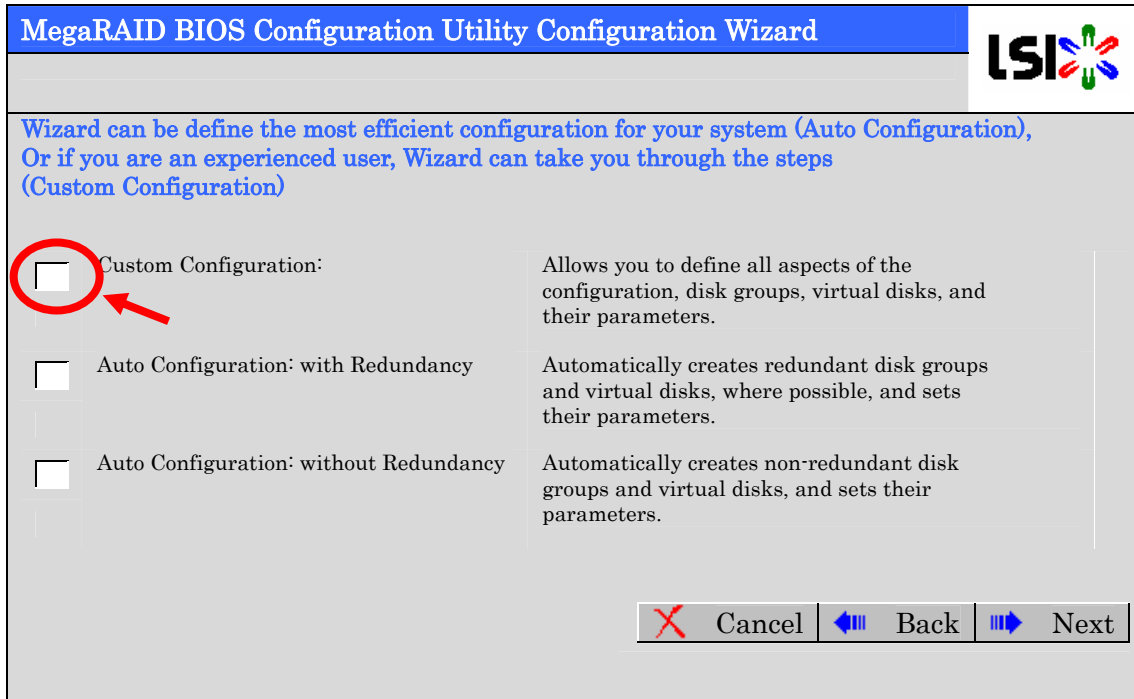

- Custom Configuration: Allows you to define all aspects of the configuration, RAID level, size, and others.
- Auto Configuration with Redundancy: Automatically creates redundant virtual disk.
- Auto Configuration without Redundancy: Automatically creates non-redundant virtual disk.



The RAID controller only supports "Custom Configuration".

- Use this menu to define several physical drives (PD) as a disk group (DG).

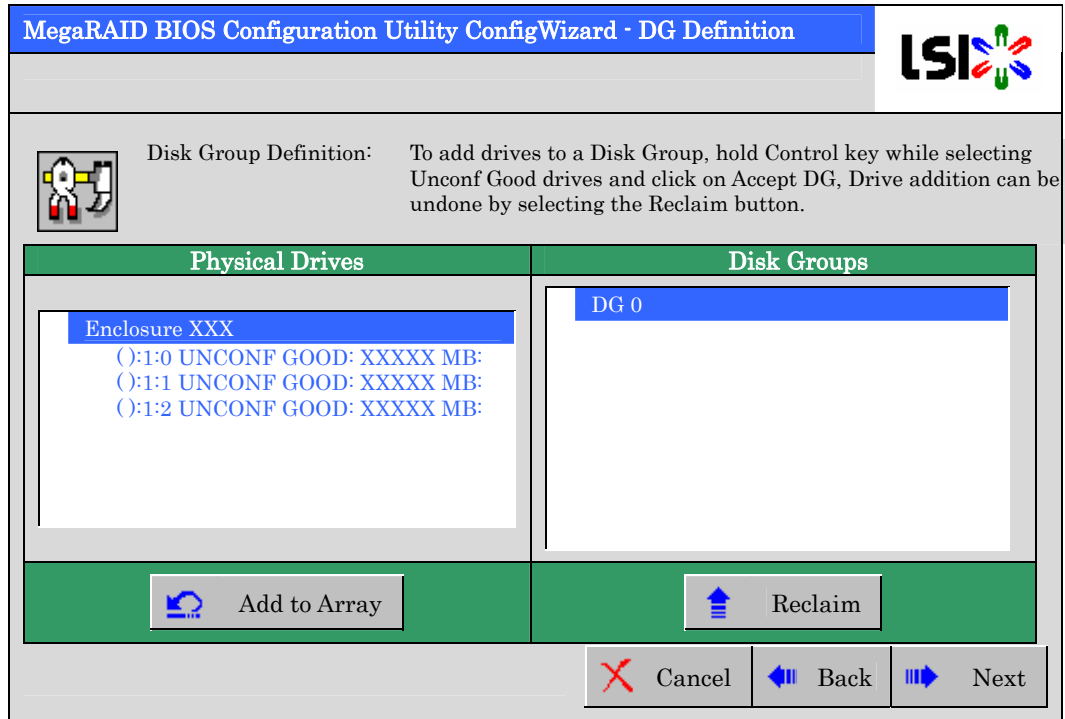

- To add physical drives (HDD) to a Disk Group, hold the **Ctrl** key while selecting physical HDDs (Physical Drives) in the DG.

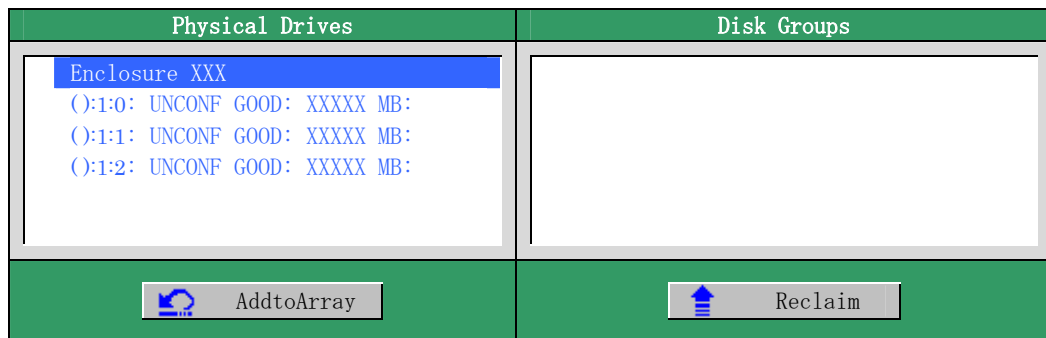

- When your selection is complete, click [Add to Array] at the lower left of the screen.

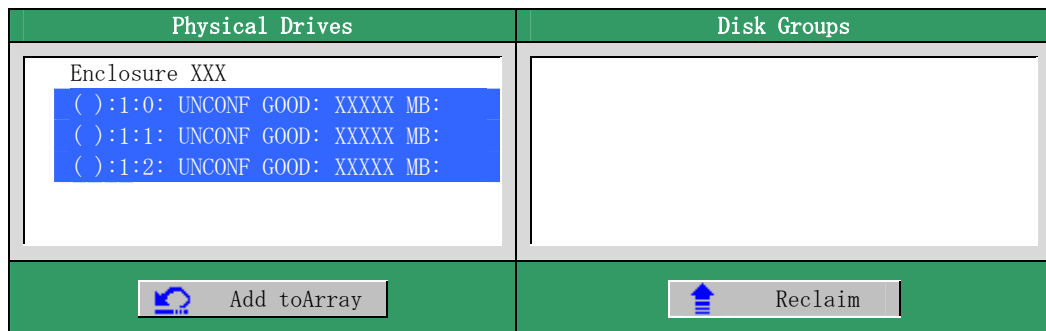

- ③ A new DG is defined in the Disk Groups frame. To define the new DG, click [Accept DG] at the lower right of the screen.

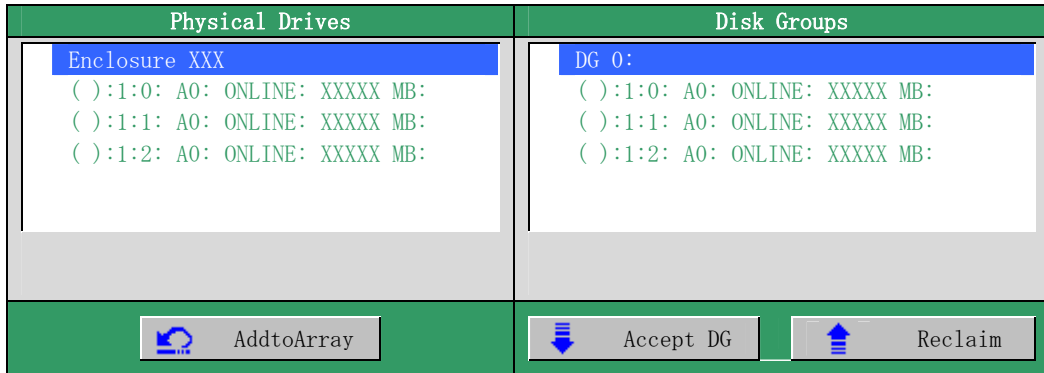

- ④ Once the DG has been defined, click [Next] at the lower right of the screen.

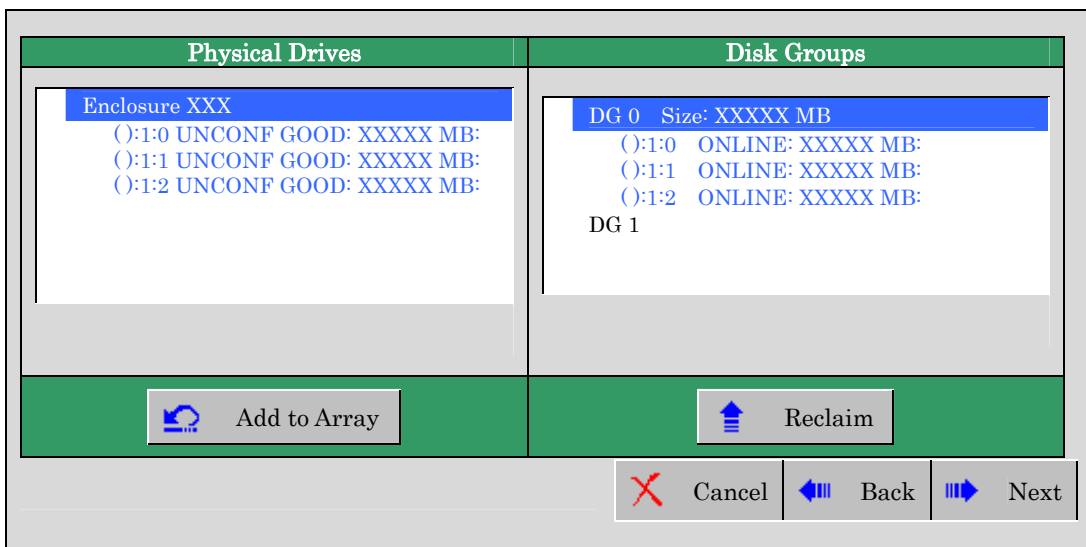

- ⑤ The Span Definition screen appears.

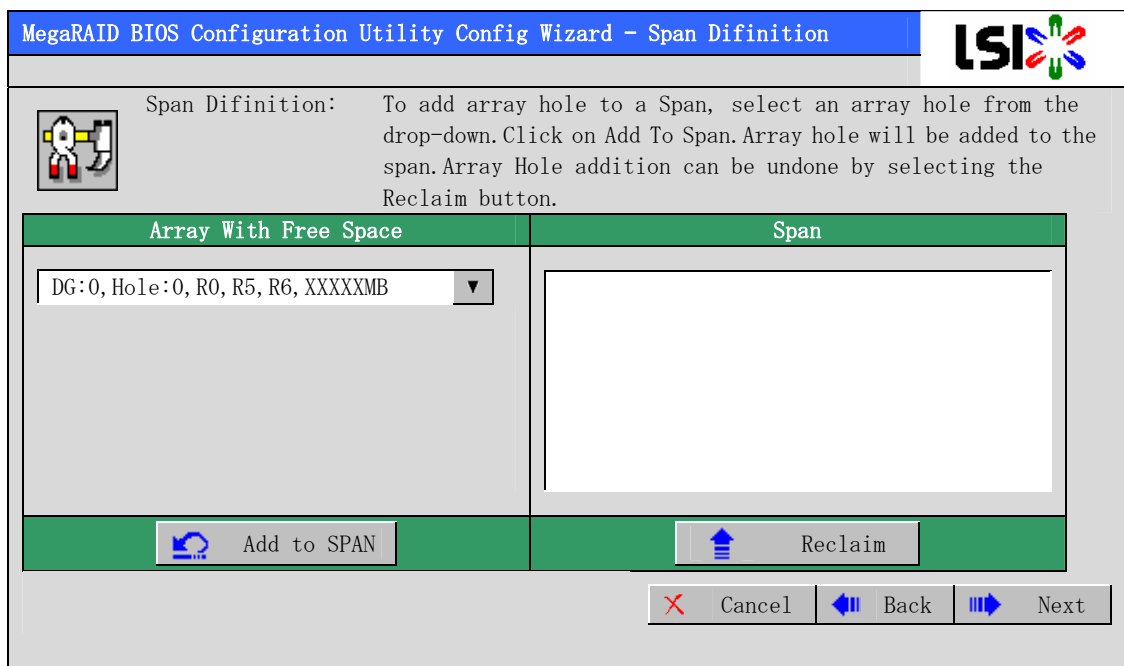

- ⑥ Select a DG to define the VD from the “Array With Free Space” frame, then click [Add to SPAN]. The DG is defined in the “Span” field to the right.

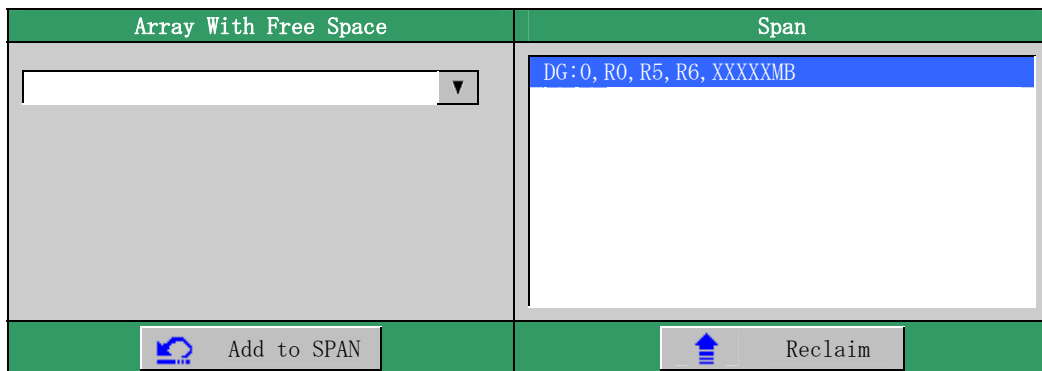

- ⑦ Once the Span has been defined, click [Next] at the lower right of the screen.



- To configure RAID0, 1, 5, or 6, perform Span Definition to a single DG only. If you need to perform Span Definition to several DGs, define a VD for the first DG, then select the next DG to define a VD.
- To configure RAID10 or 50, select several DGs containing the same number of HDDs for Span Definition.
- Span Definition cannot be performed to DGs containing different numbers of HDDs.

Define the virtual disk (VD) in a DG that has been created in previous step. When a DG was defined, [VD Definition] screen is displayed. The defined DG is displayed in the Configuration column. The available RAID levels and the maximum size for the VD are also displayed.

MegaRAID BIOS Configuration Utility ConfigWizard - VD Definition		LSI
RAID Level	RAID 6 ▼	<div style="border: 1px solid black; width: 100%; height: 100%;"></div> <p style="color: green; text-align: center;">Next LD, Possible RAID Levels R0:XXXXX R5:YYYYY R6:ZZZZZ</p>
Strip Size	64 KB ▼	
Access Policy	RW ▼	
Read Policy	Normal ▼	
Write Policy	WBack ▼	
<input type="checkbox"/> Wrthru for BAD BBU		
IO Policy	Direct ▼	
Disk Cache Policy	Disabled ▼	
Disable BGI	No ▼	
Select Size	ZZZZZ MB	
<input type="button" value="Accept"/> <input type="button" value="Reclaim"/>		
<input type="button" value="Cancel"/> <input type="button" value="Back"/> <input type="button" value="Next"/>		

As an example, define a RAID5 VD of yyyyy MB.

- ① Specify the necessary parameters in the columns on the left.
- ② Enter "yyyyy" in the "Select Size" field.
- ③ Click [Accept] at the lower center of the screen.
- ④ If you want to define another VD, click [Back] and repeat the steps starting from the Span Definition screen.
- ⑤ Once the VD definition is completed, click [Next].



The value shown in "Select Size" indicates the maximum size allowed for RAID1 or RAID6. You need to specify the maximum size for RAID0 or RAID5 according to "Next LD, Possible RAID Levels".

MegaRAID BIOS Configuration Utility ConfigWizard - VD Definition



RAID Level	RAID 0
Strip Size	64 KB
Access Policy	RW
Read Policy	Normal
Write Policy	WBack
<input type="checkbox"/> Wrthru for BAD BBU	
IO Policy	Direct
Disk Cache Policy	Disabled
Disable BGI	No
Select Size	0 MB

DG 0

VD 0

Press Back Button To Add Another VD

- ⑥ VD 0 is created in DG 0 as shown in the screen below.

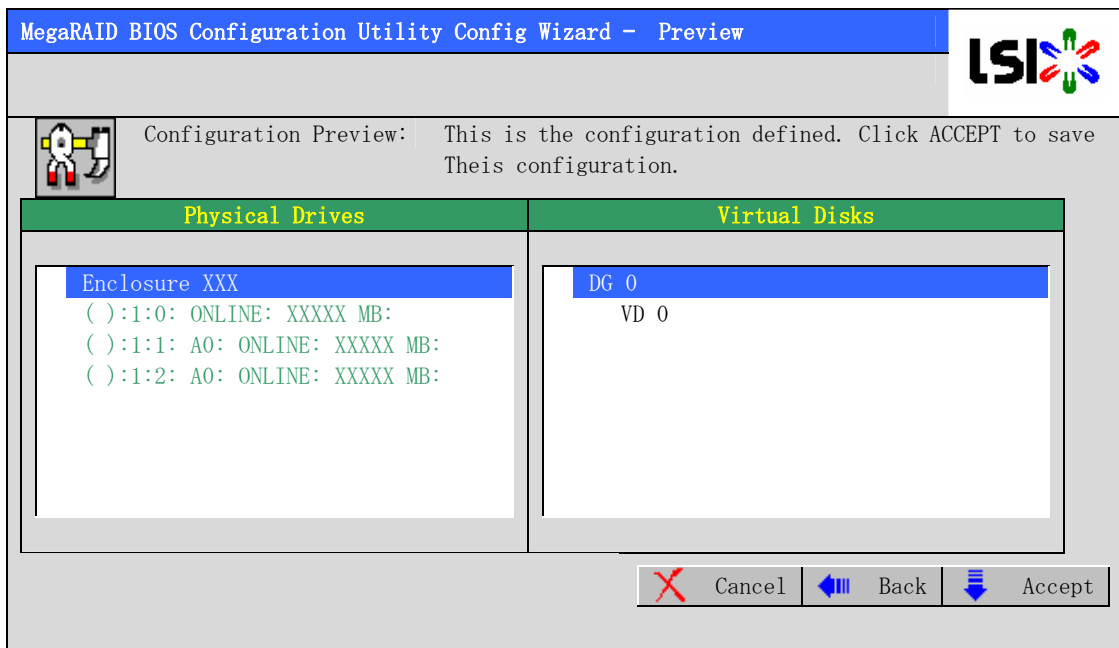

- ⑦ Make sure that the VD is created correctly, and click [Accept] at the lower right of the screen.
- ⑧ The confirmation message "Save this Configuration?" appears. Click "Yes" to save the configuration.
- ⑨ The confirmation message "All data on the new Virtual Disks will be lost. Want to Initialize?" appears. Select "Yes".
- ⑩ The "Virtual Disks" operation screen is displayed. If no other operation is required, click [Home] at the lower left of the screen.

- ① The WebBIOS Top Menu is displayed. Virtual Disk you have created is displayed in the lower right frame of the screen.

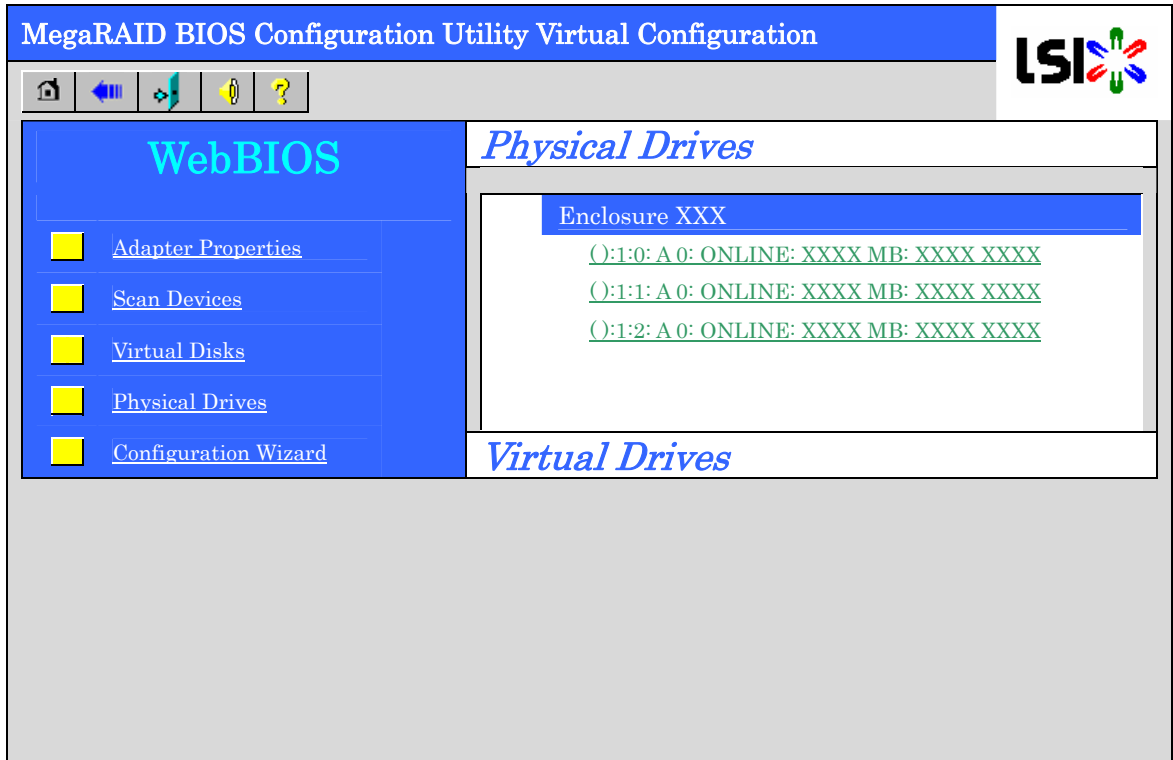

3-2. Configure SPAN

The following describes the procedure to configure the RAID 10 (spanning of RAID1) with four HDDs.



Do not attempt to configure RAID00 or RAID60. They are not supported.

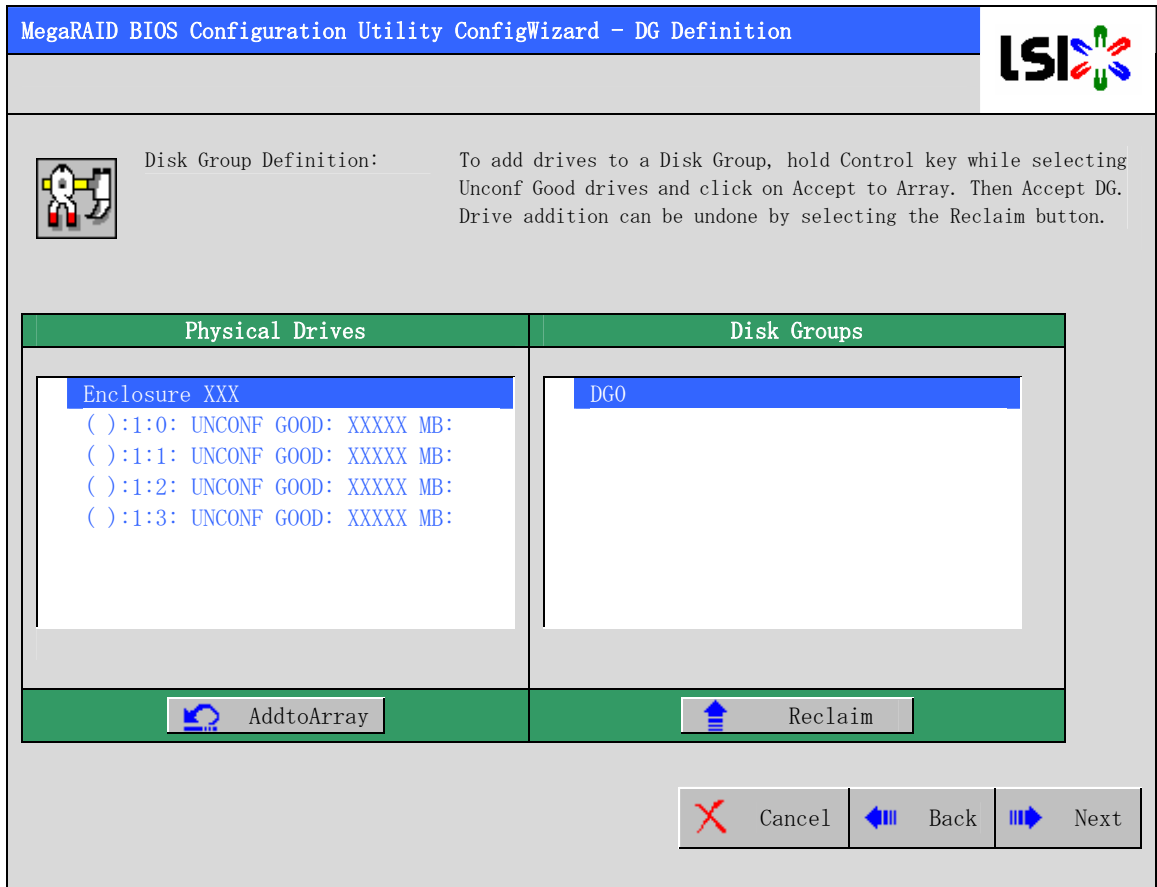

- ① Click the [Configuration Wizard] on the WebBIOS Top Menu to start the Wizard.



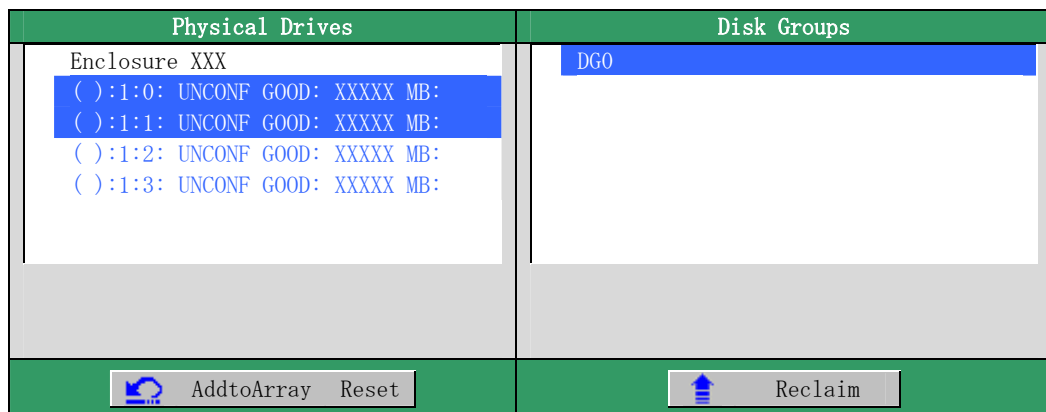

- ② To add physical drives (HDD) to a Disk Group, hold the **Ctrl key** while selecting the HDDs in the DG. (In the example, two DGs will be configured and spanned.)



- ③ Once your selection is completed, click [Add to Array] at the lower right of the screen. Make sure that the new DG is defined in the Disk Groups frame to the right, and click [Accept DG].

Physical Drives	Disk Groups
Enclosure XXX ():1:0: ONLINE: XXXXX MB: ():1:1: ONLINE: XXXXX MB: ():1:2: UNCONF GOOD: XXXXX MB: ():1:3: UNCONF GOOD: XXXXX MB:	DG0 ():1:0: ONLINE: XXXXX MB: ():1:1: ONLINE: XXXXX MB:
 AddtoArray Reset	 Accept DG  Reclaim

- ④ A new DG is defined in the Disk Groups frame. Define another DG using the same procedure. Once the DGs have been defined, click [Next] at the lower right of the screen.

Physical Drives	Disk Groups
Enclosure XXX ():1:0: ONLINE: XXXXX MB: ():1:1: ONLINE: XXXXX MB: ():1:2: ONLINE: XXXXX MB: ():1:3: ONLINE: XXXXX MB:	DG0 Size:XXXXXMB ():1:0: ONLINE: XXXXX MB: ():1:1: ONLINE: XXXXX MB: DG1 Size:XXXXXMB ():1:2: ONLINE: XXXXX MB: ():1:3: ONLINE: XXXXX MB: DG2
 Reset	 Reclaim

- ⑤ Configure RAID10 (spanning of RAID1) using the two DGs that have been created in the previous step. When the DGs have been defined, the [VD Definition] screen is displayed.

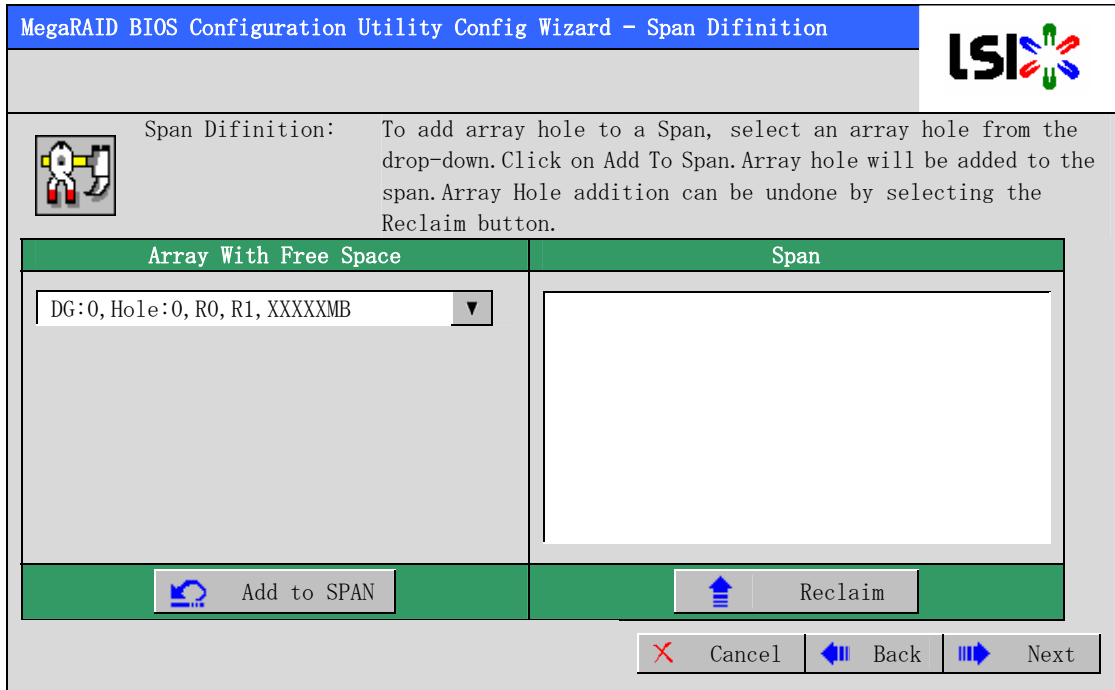

- ⑥ Select DG0 from the "Array With Free Space" frame, then click [Add to SPAN]. The DG is defined in the "Span" field to the right.

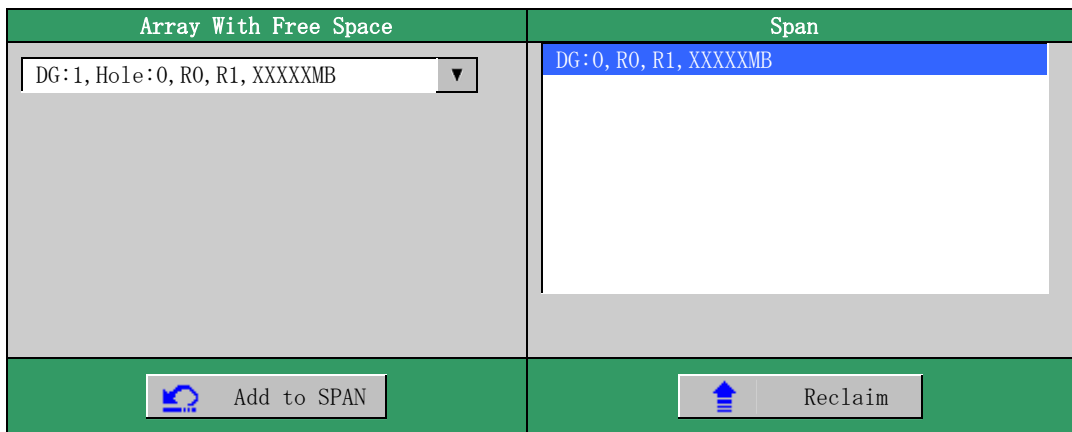

- ⑦ Select DG1 and click [Add to SPAN]. When the two DGs are defined in the "Span" field to the right, click [Next].

Array With Free Space	Span
<input type="text" value="DG:1, Hole:0, R0, R1, XXXXXMB"/>	<div style="background-color: #0000ff; color: white; padding: 2px;">DG:0, R0, R1, XXXXXMB</div> <div style="background-color: #0000ff; color: white; padding: 2px;">DG:1, R0, R1, XXXXXMB</div>
<input type="button" value="Add to SPAN"/>	<input type="button" value="Reclaim"/>

- ⑧ The VD Definition screen is displayed. Enter the necessary parameters, and click [Accept].

MegaRAID BIOS Configuration Utility ConfigWizard - VD Definition		
RAID Level	<input type="text" value="RAID 10"/>	<div style="color: green; font-weight: bold;">Next LD, Possible RAID Levels</div> <div style="color: green; font-weight: bold;">R00:XXXXX R10</div>
Strip Size	<input type="text" value="64 KB"/>	
Access Policy	<input type="text" value="RW"/>	
Read Policy	<input type="text" value="Normal"/>	
Write Policy	<input type="text" value="WBack"/>	
<input type="checkbox"/> Wrthru for BAD BBU		
IO Policy	<input type="text" value="Direct"/>	
Disk Cache Policy	<input type="text" value="Disabled"/>	
Disable BGI	<input type="text" value="No"/>	
Select Size	<input type="text" value="ZZZZZ"/> MB	
<input type="button" value="Accept"/> <input type="button" value="Reclaim"/>		
<input type="button" value="Cancel"/> <input type="button" value="Back"/> <input type="button" value="Next"/>		

- ⑨ Make sure that both DG0 and DG1 are defined as VD 0, then click [Next] at the lower right of the screen.

MegaRAID BIOS Configuration Utility ConfigWizard - VD Definition



RAID Level	RAID 0	DG 0 VD 0 DG 1 VD 0 Press Back Button To Add Another VD.
Strip Size	64 KB	
Access Policy	RW	
Read Policy	Normal	
Write Policy	WBack	
<input type="checkbox"/> Wrthru for BAD BBU		
IO Policy	Direct	
Disk Cache Policy	Disabled	
Disable BGI	No	
Select Size	0 MB	
<input type="button" value="Reclaim"/>		

- ⑩ On the "Preview" screen, make sure that the VD is defined correctly, then click [Accept] at the lower right of the screen.

MegaRAID BIOS Configuration Utility Config Wizard - Preview



 Configuration Preview: This is the configuration defined. Click ACCEPT to save This configuration.

Physical Drives	Virtual Disks
Enclosure XXX ():1:0: ONLINE: XXXXX MB: ():1:1: A0: ONLINE: XXXXX MB: ():1:2: A0: ONLINE: XXXXX MB: ():1:3: A0: ONLINE: XXXXX MB:	DG 0 VD 0 DG 1 VD 0

- ⑪ The confirmation message "Save this Configuration?" appears. Click "Yes" to save the configuration.

- ⑫ The confirmation message "All data on the new Virtual Disks will be lost. Want to Initialize?" appears. Select "Yes".
- ⑬ The "Virtual Disks" operation screen is displayed. If no other operation is required, click [Home] at the lower left of the screen.
- ⑭ The WebBIOS Top Menu is displayed. The Virtual Disk you have created is displayed in the lower right frame of the screen.

3-3. Parameters for VD Definition

Listed below are the parameters for the Configuration Wizard.

Item	Parameter	Remarks
RAID Level	RAID 0 / RAID 1 / RAID 5 / RAID 6 / RAID 00 / RAID 10 / RAID 50 / RAID60	RAID 00 and RAID 60 are not supported.
Strip Size	8 KB / 16 KB / 32 KB / 64 KB / 128 KB / 256 KB / 512 KB / 1024 KB	Recommended value: 64KB
Access Policy	RW / Read Only / Blocked	Recommended value: RW
Read Policy	Normal / Ahead / Adaptive	Recommended value: Normal
Write Policy	WBack / Wthru	WBack :Write Back WThru :Write Thru
WrtThru for BAD BBU	Checked / Unchecked	Select a mode when WriteBack is specified for Write Policy. Checked: Normal WriteBack Unchecked: Constant WriteBack Recommended value: Checked
IO Policy	Direct / Cached	Recommended value: Direct
Disk Cache Policy	Unchanged / Enabled / Disabled	Recommended value: Disabled
Disable BGI	No / Yes	Specify whether to perform Background Initialize after creation of VD. Recommended value: No



BGI (Back Ground Initialize) is available only for a RAID5 VD configured with five or more HDDs or RAID6 VD configured with seven or more HDDs.

The Write Policy has the following modes depending on the combination with WrtThru for BAD BBU. Select a mode suitable for your environment.

		WrtThru forBAD BBU	
		Checked	Unchecked
Write Policy	WBack	Normal write back mode (recommended) This mode is available only when the RAID Battery Backup Unit is Installed. The controller uses cache memory for writing. However, if the battery is being charged or	Constant write back mode This mode is available even if the RAID Battery Backup Unit is not installed. The controller always uses cache memory for writing. In this mode, the data in the cache memory may not be protected from damages if a power failure occurs due to

		has failed, the controller automatically operates in WThru (write through) mode. Thus, this mode can provide higher data security.	the charge/discharge state or if the battery is defective. Be sure to use a UPS when specifying this mode for write policy.
	WThru	Write through mode This mode is recommended when the RAID Battery Backup Unit is not installed. The controller does not use cache memory to write the data.	* This mode is unavailable. If you do not check "WThru for BAD BBU" during the creation of the VD, this item is automatically checked once the VD has been created.

You can change the parameters for the VD definition except for the RAID level and the Stripe Size. On the WebBIOS Top Menu, click [Virtual Disks], specify parameters in the "Policies" frame, and then click [Change].

MegaRAID BIOS Configuration Utility Virtual Disk X

Properties
RAID Level: X State: Optimal
Size: XXXXXX MB Strip Size: XX KB

Policies
Access: RW Read: Normal
Write: WBack Disk Cache: Disabled
 Use wrthru for failure or missing battery
Disable BGI: No I/O: Direct
 (circled in red)

Operations
 Del Locate Fast Init Slow Init
 CC

Right Panel:
 Remove physical drive
DG 0
0:0:0: XXXXX MB
1:0:1: XXXXX MB
 Migration only
RAID 6
 Migration with addition
3:0:3: XXXXX MB
4:0:4: XXXXX MB
5:0:5: XXXXX MB

Bottom Bar:

4. Operation of Various Features

4-1. Check Consistency

- ① Start WebBIOS.
- ② Click [Virtual Disks] on the WebBIOS Top Menu.
- ③ Select a VD to perform the Check Consistency from the upper right frame of the Virtual Disks screen.
- ④ Click the checkmark column for the Check Consistency from the lower right frame of the Virtual Disks screen.
- ⑤ Make sure that the Check Consistency is checked, and click [Go].

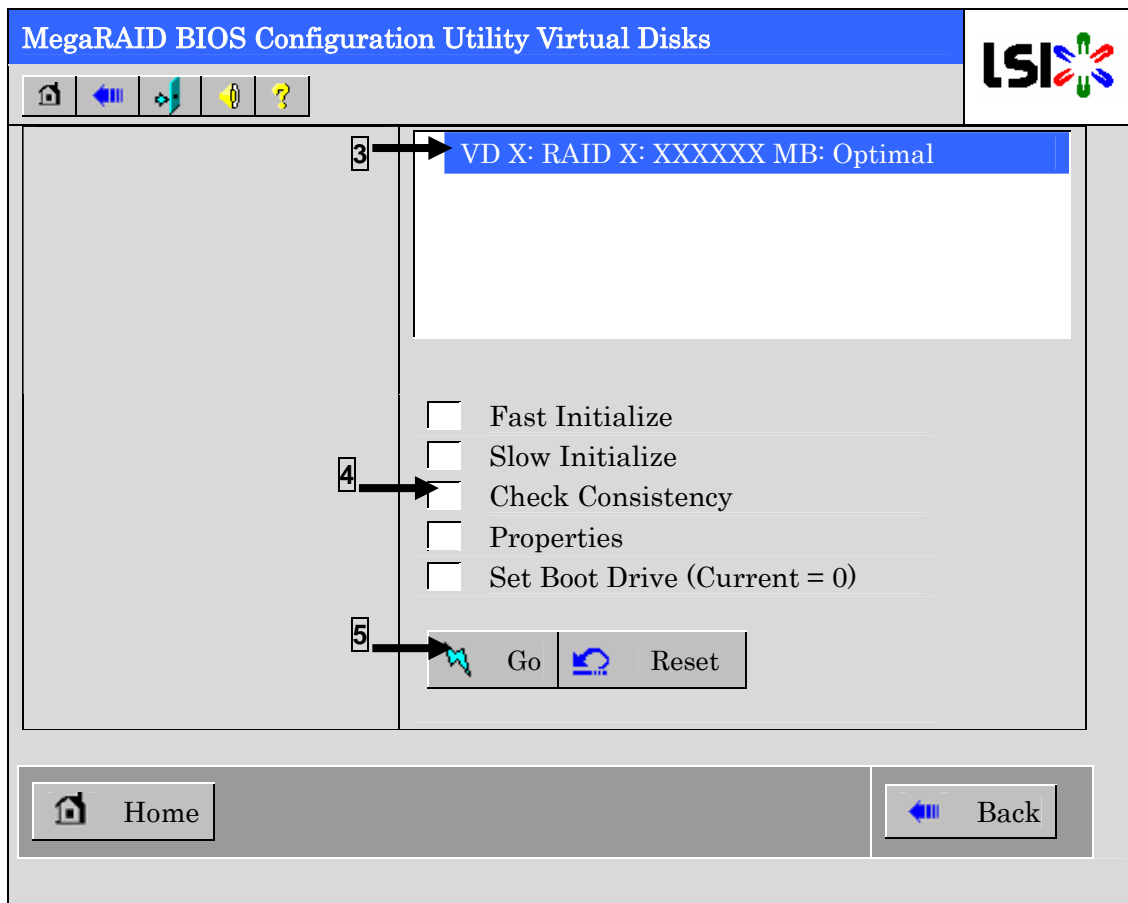

- ⑥ The Check Consistency progress is displayed on the left frame of the Virtual Disks screen.
- ⑦ Click [Home] at the lower left of the Virtual Disks screen to return to the Top Menu.

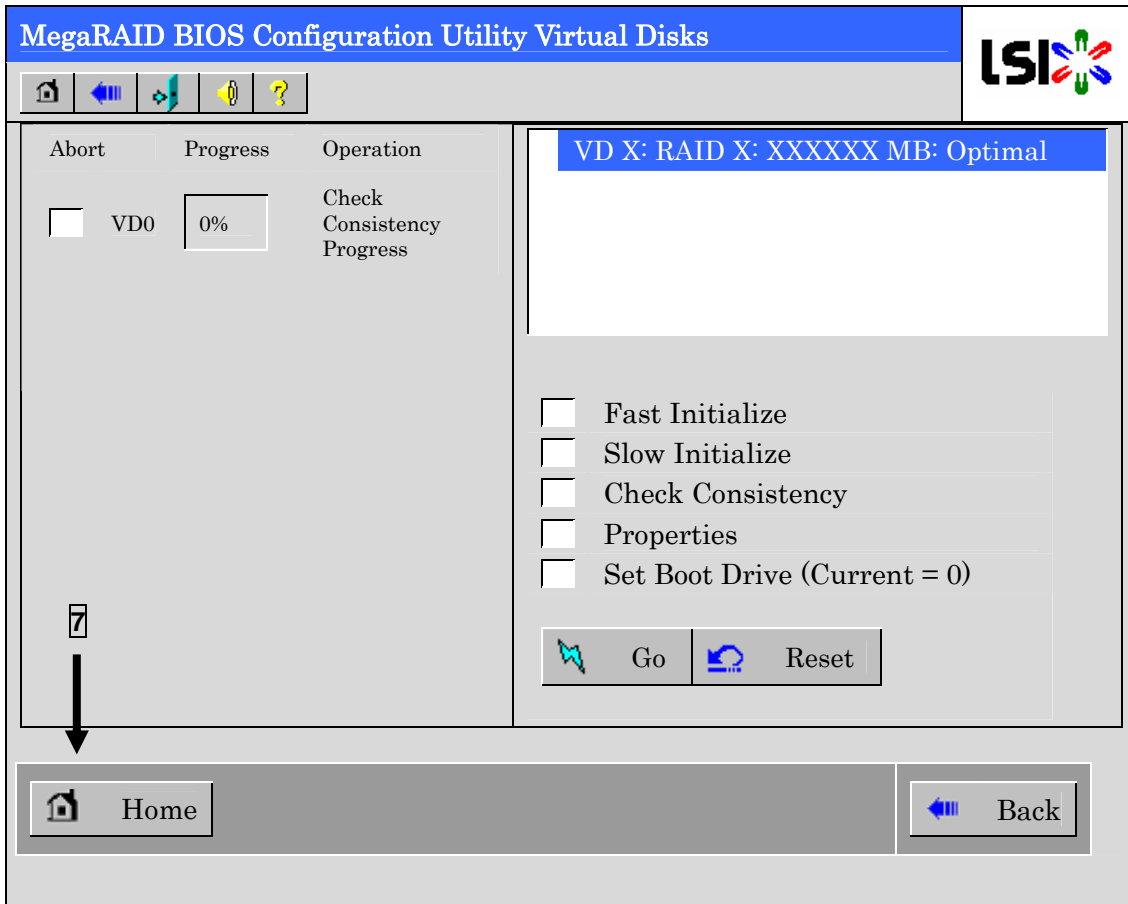

Click [Home] while background tasks such as Consistency Check, Rebuild, or reconstruction are being executed. When the progress indication is displayed, the background task may process at a slower rate on some servers.

4-2. Manual Rebuild

Power off the server and replace the failed HDD with a new one. As the Auto Rebuild feature is disabled for non-hot-swap replacement, use the Manual Rebuild feature to recover the virtual disk as described below.

The procedures described below are based on the following assumption: One of the HDDs failed in a RAID5 virtual disk configured with three HDDs.

- ① Start WebBIOS. Make sure that the status for the replaced HDD is indicated as "UNCONF GOOD" in the right frame of the Top Menu.

In the example below, the hard disk drive in slot number 2 has been replaced.

The indication "PD Missing from DGx: Slot 2: xxxxx MB" indicates that the PD (physical drive) previously installed in slot number 2 was removed.

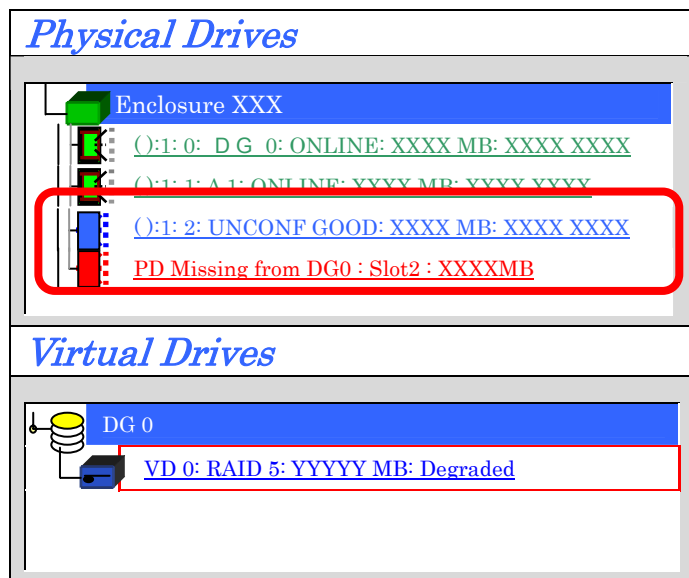

- ② Select "():1:2" (newly connected HDD) in [Physical Drives].
- ③ The Physical Drive properties are displayed.

- ④ Select "Make Global HSP" or "Make Dedicated HSP" on the lower part of the screen, and then click [Go] on the lower center of the screen.

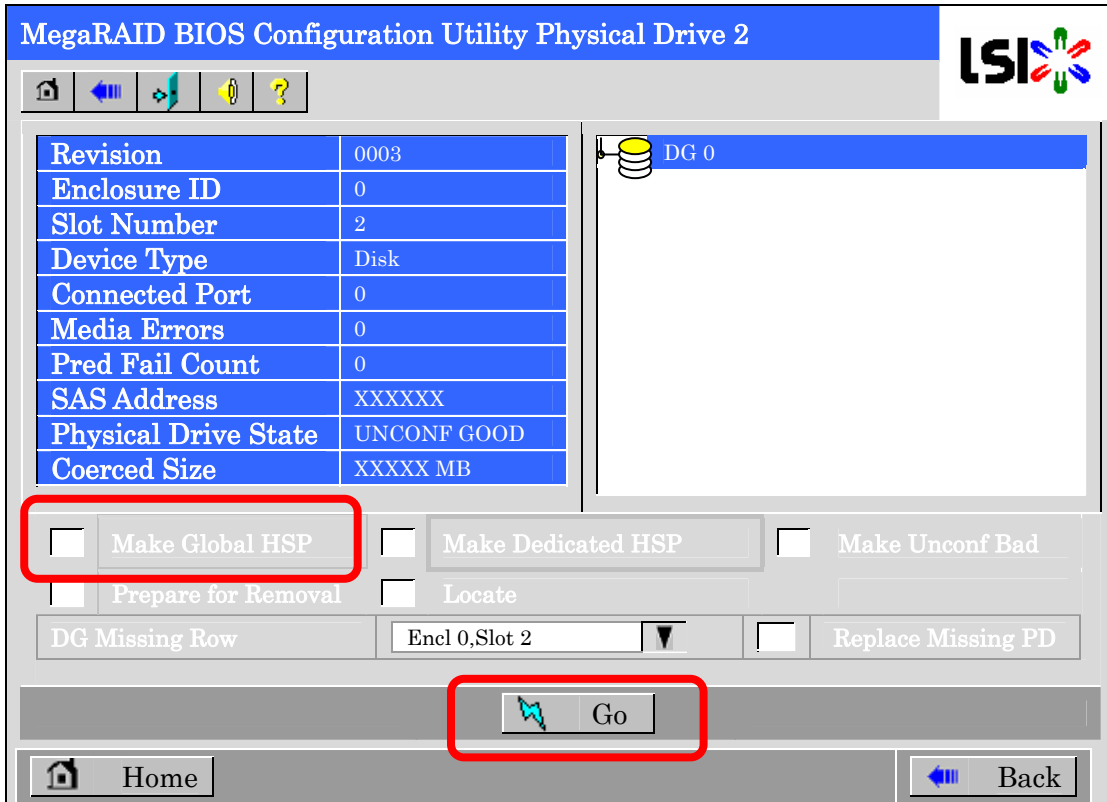

- ⑤ When [Rebuild Progress] is displayed, click [Home] at the lower left of the screen to go back to WebBIOS Top Menu.

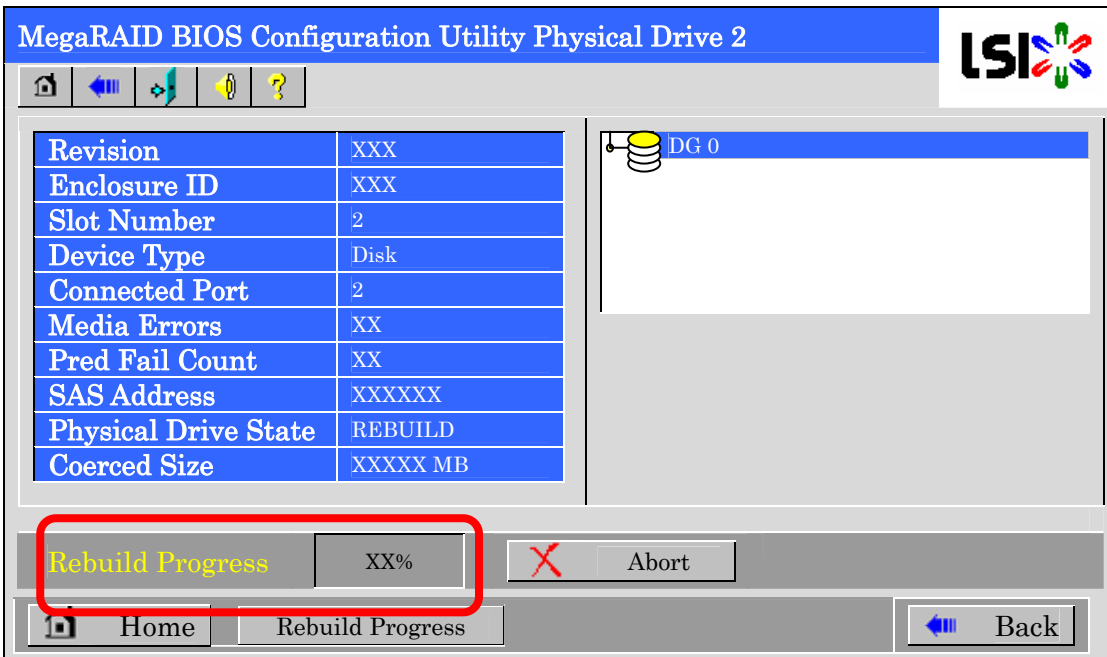

Click [Home] while background tasks such as Consistency Check, Rebuild, or reconstruction are being executed. When the progress indication is displayed, the background task may process at a slower rate on some servers.

- ⑥ While rebuilding, the WebBIOS top screen is displayed. Click [Home] at the lower left of the screen to go back to the WebBIOS top menu.

The screenshot shows two panels. The top panel, titled "Physical Drives", displays "Enclosure XXX" with three physical drives: PD 0 (ONLINE: XXXX MB), PD 1 (ONLINE: XXXX MB), and PD 2 (REBUILD: XXXX MB). The bottom panel, titled "Virtual Drives", displays "DG 0" with a virtual drive VD 0 (RAID 5: YYYYY MB: Degraded).

- ⑦ Once the rebuild is finished, the status for the physical drive is "online" and that of the virtual drive is "optimal".

The screenshot shows two panels. The top panel, titled "Physical Drives", displays "Enclosure XXX" with three physical drives: PD 0 (ONLINE: XXXX MB), PD 1 (ONLINE: XXXX MB), and PD 2 (ONLINE: XXXX MB). The bottom panel, titled "Virtual Drives", displays "DG 0" with a virtual drive VD 0 (RAID 5: YYYYY MB: Optimal).

4-3. Setting Hot Spare

The procedures described below are based on the following assumption:

Add a HDD to a RAID5 virtual disk configured with three HDDs and assign this HDD as Hot Spare Disk.

- ① Start WebBIOS.

Make sure that the status for the added HDD is indicated as "UNCONF GOOD" in the right frame of the Top Menu.

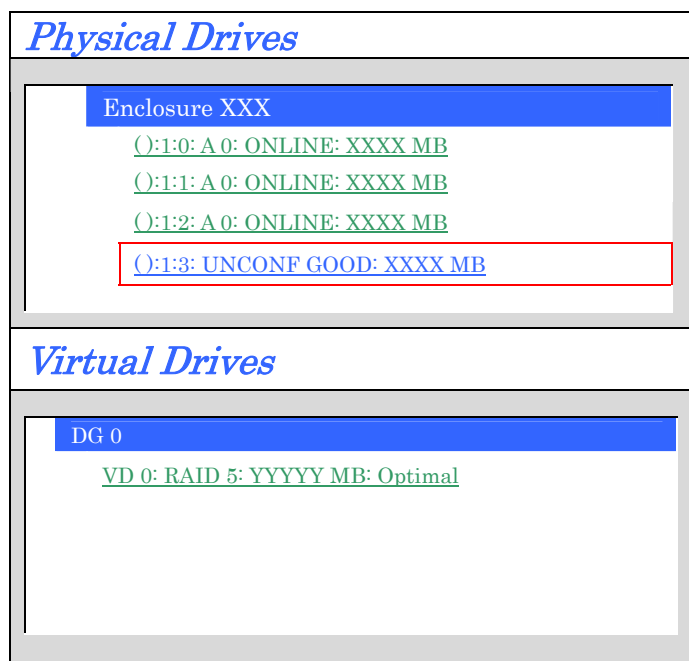

- ② Select "():0:3" (newly connected HDD) in [Physical Drives].
- ③ The properties for the Physical Drive are displayed.

- ④ Select [Make Global HSP] or [Make Dedicated HSP] on the lower right of the screen, and then click [Go] on the lower center of the screen.

Global HSP: Indicates the Hot Spare available for all the DGs.

Dedicated HSP: Indicates the Hot Spare available only for the specific DG. You need to specify the target DG.

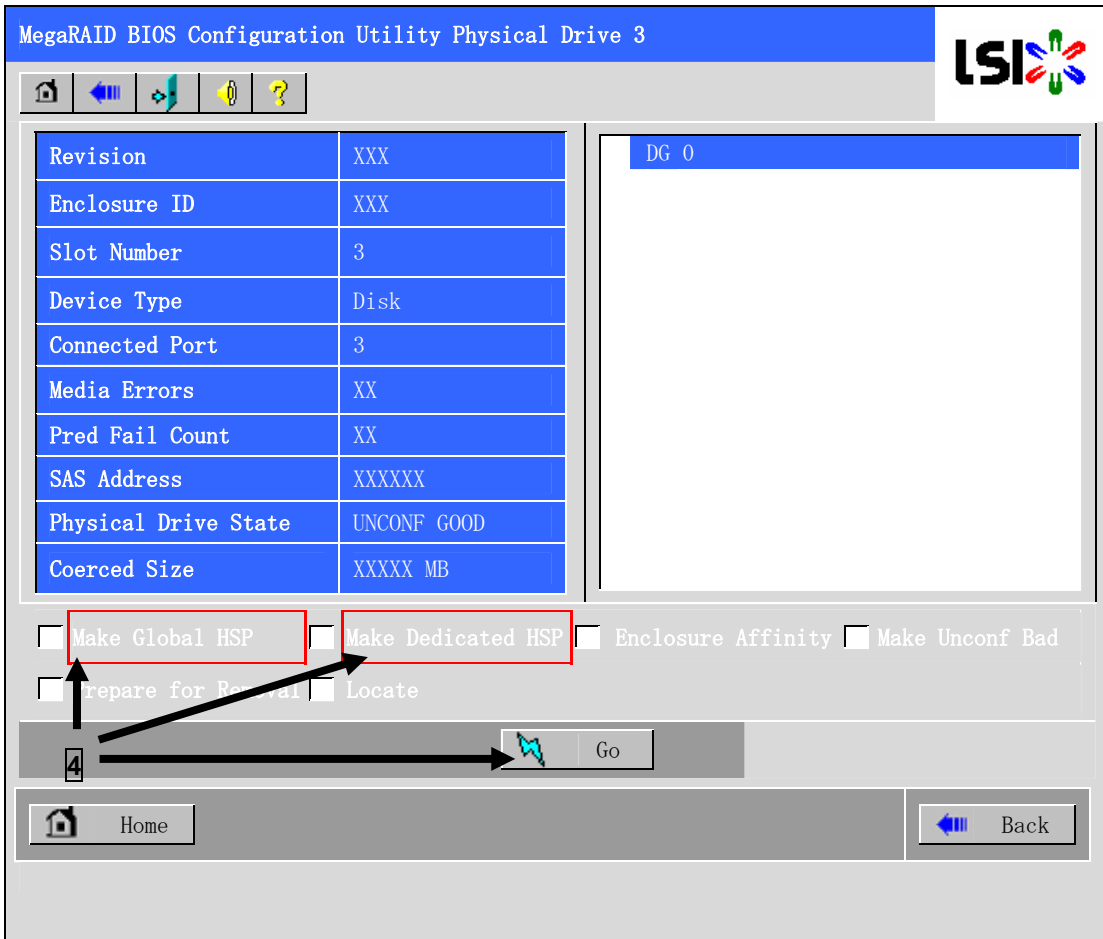

Tips

Do not check "Enclosure Affinity" which defines the hot-spare to a specific enclosure. This setting is not supported in the system.

- ⑤ The status for the newly connected HDD changes to "HOTSPARE".
- ⑥ Click [Home] at the lower left of the screen to go back to the WebBIOS Top Menu.

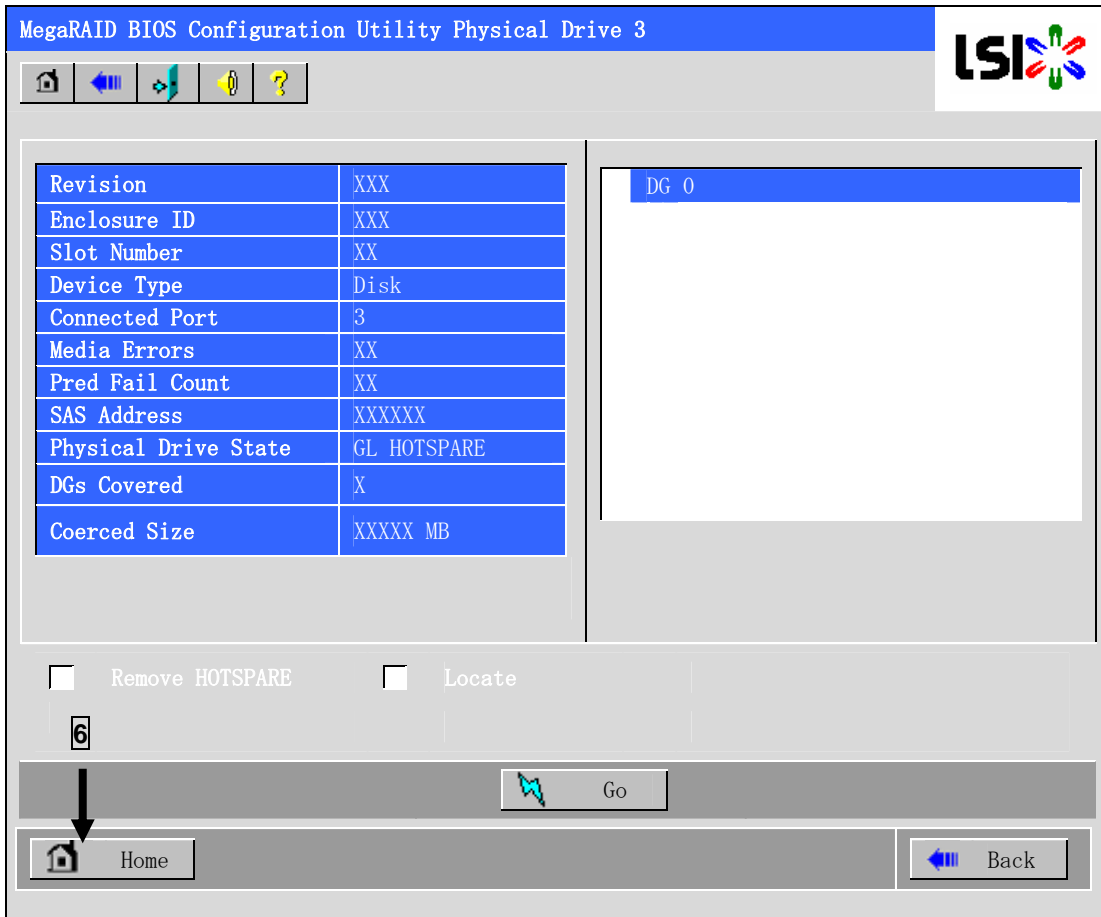

4-4. Reconstruction

The procedures described below are based on the following assumption:

Add a HDD to a RAID5 virtual disk configured with three HDDs to make a RAID5 virtual disk configured with four HDDs.

- ① Start WebBIOS.

Make sure that the status for the added HDD is indicated as "UNCONF GOOD" in the right frame of the Top Menu.

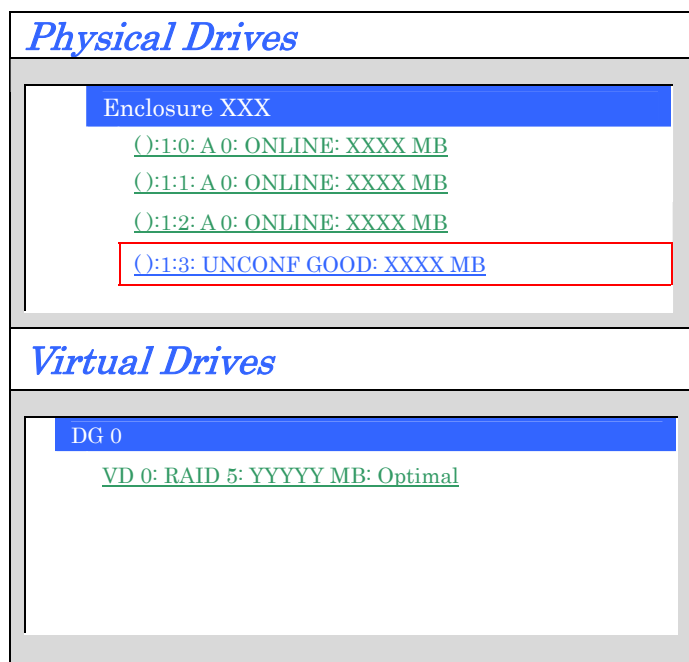

- ② Select "VD 0" (already been constructed) in [Virtual Drives].

- ③ The Setting menu for the VD 0 is displayed.

MegaRAID BIOS Configuration Utility Virtual Disk X

LSI

Properties
 RAID Level: X State: Optimal
 Size: XXXXXX MB Strip Size: XX KB

Policies
 Access: RW Read: Normal
 Write: WBack Disk Cache: Disabled
 Use wrthru for failure or missing battery
 Disable BGI: No I/O: Direct
 Change

Operations
 Del Locate Fast Init Slow Init
 CC
 Go

Remove physical drive

DG 0
 ():1:0: XXXXX MB
 ():1:1: XXXXX MB

Migration only
 RAID 6

Migration with addition
 ():1:3: XXXXX MB

Reset Go

Home Back

- ④ On the right of the screen, the items required for reconstruction are displayed.

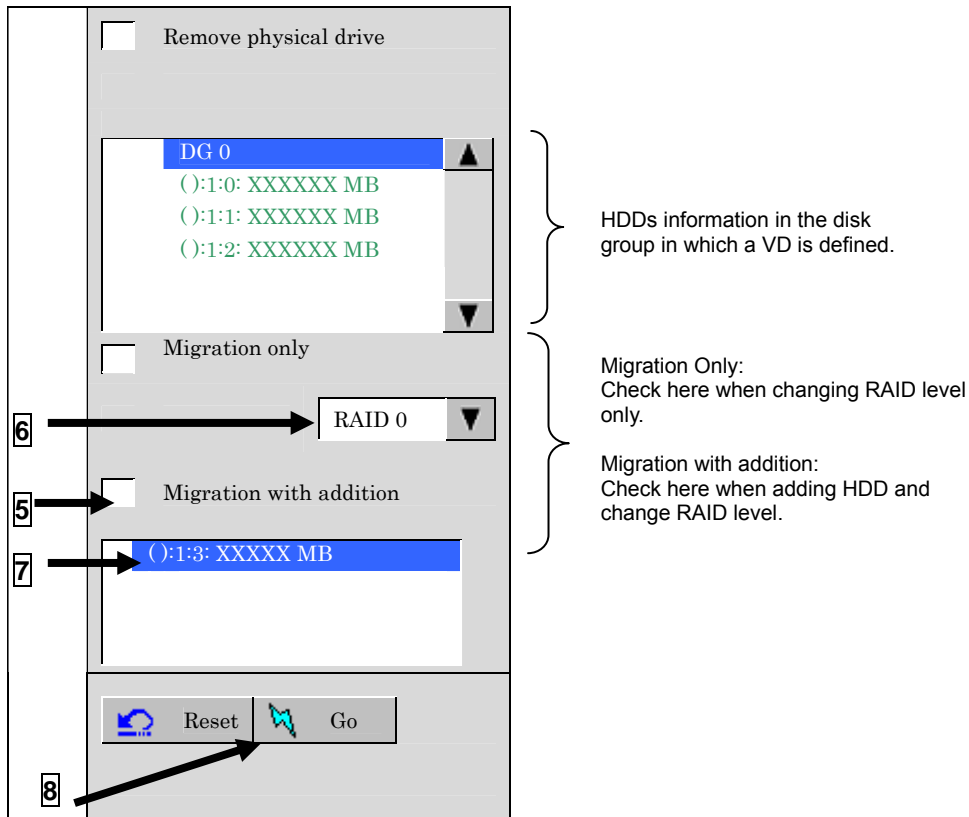

- ⑤ Select "Migration with addition".
- ⑥ Specify the RAID level used after the reconstruction.
- ⑦ Select the HDD you wish to add.
- ⑧ When you have finished steps 5 to 7, click [Go] at the lower right of the screen.
- ⑨ The progress of reconstruction is displayed on the lower left of the screen. Click [Home] at the lower left of the screen to return to the WebBIOS Top Menu.



- The capacity of the Virtual Disk may be incorrectly displayed after reconstruction. In this case, perform a Scan Devices from the top menu.
- Click [Home] while background tasks such as Consistency Check, Rebuild, or reconstruction are being executed. When the progress indication is displayed, the background task may process at a slower rate on some servers.

4-5. Locate

The Locate command makes a HDD LED blink to confirm the location of the HDD. We recommend you execute it before adding virtual disks or hot spares, reconstructing virtual disks, or replacing HDDs.

- How to execute Locate command on WebBIOS

① Click a physical drive (PD X) to check the location on the WebBIOS top menu.

② The Physical drive properties are displayed. Click Locate.

③ Click Go. The LED of the HDD blinks.

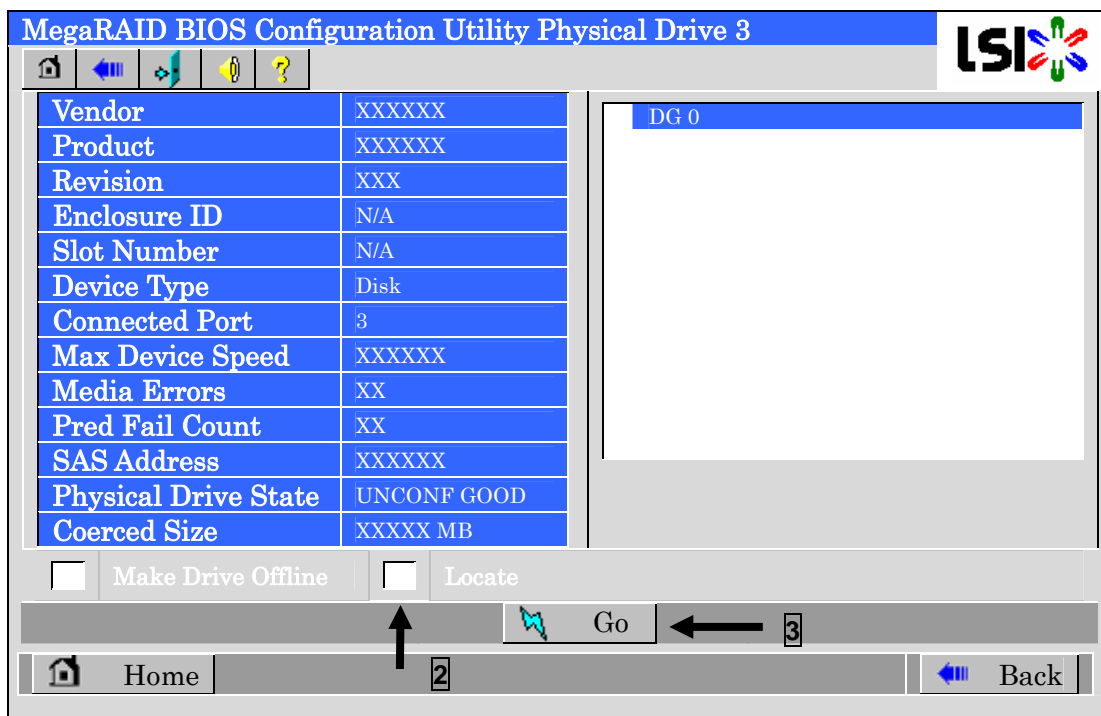

4-6. Slow Initialize

Slow Initialize writes zero to all the sectors of the data area in the virtual disk.

- ① Start WebBIOS.
- ② Click [Virtual Disks] on the WebBIOS top menu.
- ③ Select a VD to perform Slow Initialize from the upper right frame of the Virtual Disks screen.
- ④ Click the checkmark column for Slow Initialize from the lower right frame of the Virtual Disks screen.
- ⑤ Make sure that Slow Initialize is checked, and click [Go].

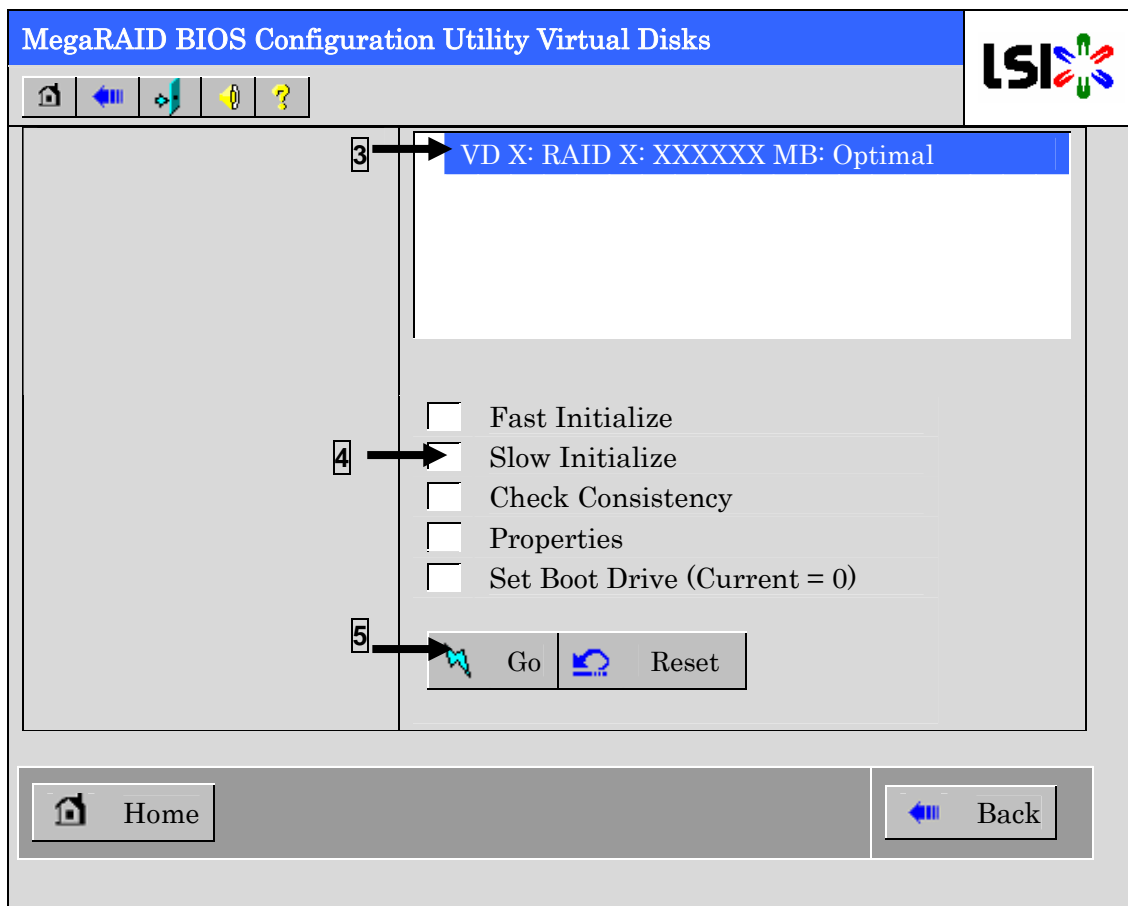

Notice

- On the configuration wizard, Fast Initialize writes zero to the first sector of each hard drive to clear the partitions in the virtual disk.
- Slow Initialize takes a long time.

Creating a RAID 6 Logical Drive

If you want to create the Logical Drive from three Physical Devices, you need to use WebBIOS.



Even if WebBIOS is used, it is not possible to set it to "StripSize:8KB".

Chapter 5 Operation and Maintenance

1. Maintenance Service

We recommend you contact Service Representative approved by the manufacturer to order genuine spare parts or to perform any operations on your system.

2. Preventive Maintenance

2-1. Data Backup

We recommend you backup routinely the data located on the HDDs to prevent severe loss should an incident occur.

For more information on data backup, refer to the Server User Guide.

3. Maintenance

The RAID controller supports the following maintenance features

- Configuration on Disk (COD) feature
- Rebuild feature

3-1. Configuration on Disk (COD) Feature

The COD feature writes the configuration information into HDDs. This feature prevents the configuration information from being lost if the disk array controller is defective and requires replacement.

Once the disk array controller has been replaced, the COD feature can read the configuration information from the HDDs to operate the controller normally.



Check

The configuration information is not saved on the disk array controller but on the HDDs.

3-2. Rebuild Feature

The rebuild feature can recover the data that was stored in a defective HDD. This feature is available for redundant logical drives in the RAID1, RAID5, RAID6, RAID10, or RAID50 level.

See "Chapter 3 Features of RAID controller" for details.

4. Replacing the Disk Array Controller

Replace the disk array controller as described in the following procedure:



Check

For more information on the handling of the server, refer to the Server User Guide.

⚠ CAUTION



Avoid installation in extreme temperature conditions.

Immediately after the server is powered off, its internal components such as hard disk drives are very hot. Let the installed components fully cool down before installing/removing any component.

Shutdown OS while the server is powered on, power off the server, and pull out the power cords from the receptacles.

1. If applicable, remove the side cover and other components from the server.
2. Remove the SAS cable from the disk array controller.



Notice

Before removing the SAS cables, check the port numbers of the SAS connectors on the disk array controller and those of the SAS cables to write down the connecting configuration.

3. Remove the screw fixing the disk array controller and remove the disk array controller from the server.



Notice

- If applicable, disconnect the additional battery from the disk array controller you remove following the instructions from the "Additional DAC Battery User Guide".
- Always write down in which PCI slot the controller was installed.

4. Insert the replaced disk array controller into the same PCI slot (PCI Express) and fix it with the screw.
5. Connect all the relevant cables according to the information you noted down.
6. Install the components removed during step 2.
7. Connect the power cords and power on the server. Make sure that the server boots normally.

5. Troubleshooting

If the server equipped with the disk array controller does not operate normally or if some utilities are disabled, check the following situations.

If your problem is documented, take the corresponding appropriate action.

(1) The OS cannot be installed.

- ⑧ How were the virtual disks created?
→ Create virtual disks using WebBIOS.

(2) The OS does not boot.

- ⑧ Is the disk array controller securely inserted into the mating PCI slot?
→ If not, install the disk array controller correctly.
- ⑧ Is the disk array controller inserted into a PCI slot to which some installation limitation is imposed?
→ Check the PCI slot and controller limitations, and insert the controller into a correct slot.

If the OS is not recognized despite the above actions, the disk array controller may be defective. Contact your service representative.

- ⑧ Are all HDDs inserted to the end of the slot?
→ Install the HDDs in the slot correctly.
- ⑧ Are the SAS cables correctly connected to the disk array controller, HDDs and/or additional HDD cage?
→ Connect the cables correctly.

If the OS is not recognized despite the above actions, one or more HDDs may be defective. Contact your service representative.

(3) HDD failed

- Contact your service representative.

(4) Rebuild cannot be executed.

- ⑧ Is the capacity of the replacement HDD identical to that of the failed one?
→ Use a disk having the same capacity as the defective HDD.
- ⑧ Is the system configured in RAID0?
→ Rebuild is not possible because the redundancy feature is not supported by RAID0. Replace the defected HDD and create a new virtual disk.

(5) Consistency Check is disabled.

- ⑧ Is the virtual disk degraded?
→ Replace the defective HDD and execute Rebuild.
- ⑧ Is the system configured in RAID0?
→ Consistency Check is not possible because the redundancy feature is not supported by RAID0. Replace the defected HDD and create a new virtual disk.

(6) The additional battery is not recognized, or the POST displays the message below.

The battery hardware is missing or malfunctioning, or the battery is unplugged. If you continue to boot the system, the battery-backed cache will not function. Please contact technical support for assistance. Press 'D' to disable this warning (if your controller does not have a battery).

- ⑧ Is the cable correctly connected between the battery pack and DIMM?
→ Connect the cable correctly.

If the additional battery is still not recognized, it may be defective. Contact your service representative.

(7) The additional battery is not recognized, or the POST displays the message below.

Your battery is bad or missing, and you have VDs configured for write-back mode. Because the battery is not usable, these VDs will actually run in write-through mode until the battery is replaced. The following VDs are affected : xx
Press any key to continue.

- ⑧ Is the cable correctly connected between the battery pack and DIMM?
→ Connect the cable correctly.
- ⑧ The charge level of the battery may be not sufficient.
→ Keep the system powered on for several hours to charge the battery and check to see if the message is still displayed.

If the additional battery is still not recognized, it may be defective or require replacement. Battery-life expectancy is about 2 years. Contact your service representative.

