

# NovaScale R630

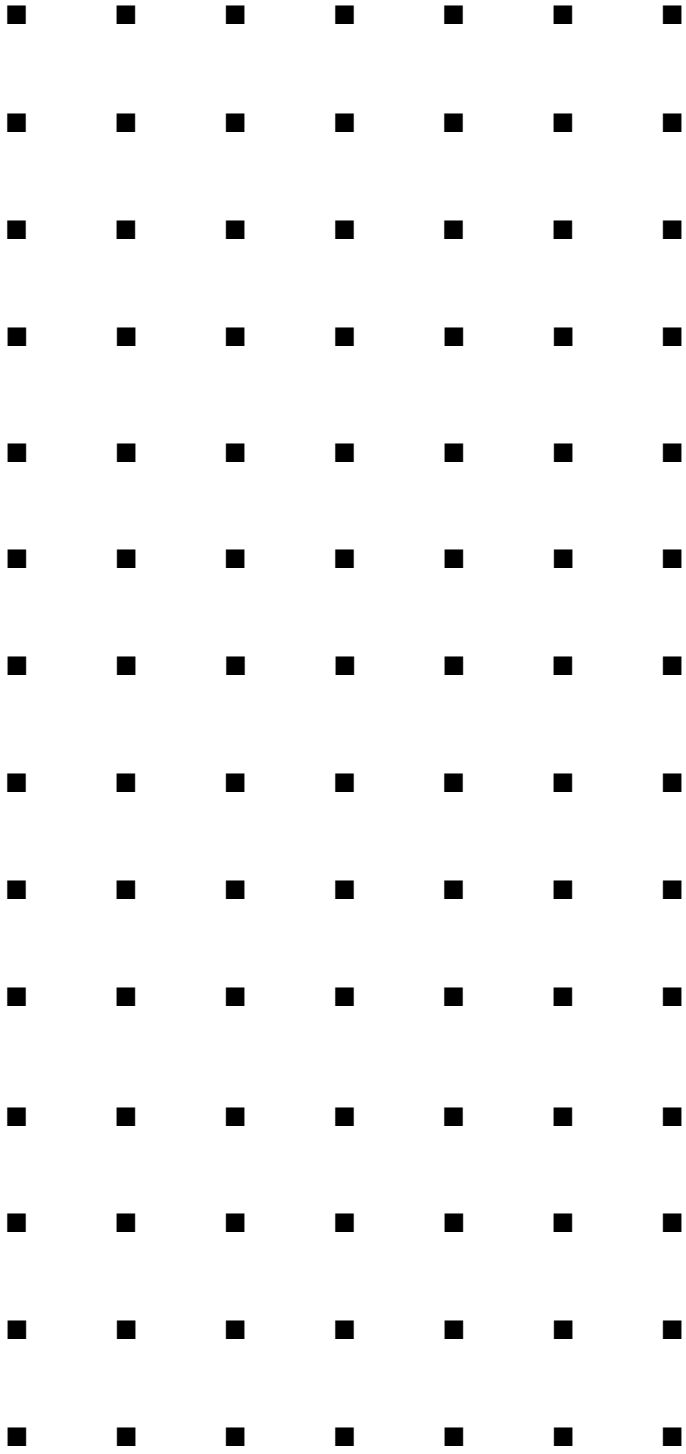

Setup Guide

### *Proprietary Notice and Liability Disclaimer*

The information disclosed in this document, including all designs and related materials, is the valuable property of NEC Computers and/or its licensors. NEC Computers and/ or its licensors, as appropriate, reserve all patent, copyright and other proprietary rights to this document, including all design, manufacturing, reproduction, use, and sales rights thereto, except to the extent said rights are expressly granted to others.

To allow for design and specification improvements, the information in this document is subject to change at any time, without notice. Reproduction of this document or portions thereof without prior written approval of NEC Computers is prohibited.

The Bull product(s) discussed in this document are warranted in accordance with the terms of the Warranty Statement accompanying each product. However, actual performance of each product is dependent upon factors such as system configuration, customer data, and operator control. Since implementation by customers of each product may vary, the suitability of specific product configurations and applications must be determined by the customer and is not warranted by Bull.

rev 1.0 October 2007

Copyright 2007

NEC Computers S.A.S.  
All Rights Reserved



Keep this User's Guide handy for quick reference when necessary.

## Safety Indications



To use the Fault Tolerant Server series safely, follow the instructions in this User's Guide.

This guide explains components that pose a danger, types of dangers caused by failing to follow the instructions, and actions taken to prevent them; such components are labeled warning.

This guide and warning labels use "WARNING" and "CAUTION" to indicate a danger depending on the degree. These terms are defined as follows:

 <b>WARNING</b>	Indicates a danger that could lead to a death or serious injury.
 <b>CAUTION</b>	Indicates a danger that could lead to a burn, other injuries or damage to physical assets.

This guide uses the following three types of symbols to give indications and precautions against a danger. They are defined as follows:

	Indicates that there is a risk of a danger. Each image symbolizes a particular type of danger. (Attention)
	Indicates what you must not do. Each image symbolizes a particular type of prohibition. (Prohibited actions)
	Indicates what you must do. Each image symbolizes a particular type of action necessary to avoid a danger. (Mandatory actions)

(Example)





High temperature.  
Immediately after the power-off, system components such as hard disk are very hot. Wait the server to cool down completely before adding/removing some component.

Symbol to draw attention









Term indicating a degree of danger

Symbol indicating a prohibited action (may not always be indicated)







Description of a danger

Symbols and its descriptions used in this User’s Guide and warning labels are as follows:



**Attention**

	Indicates a risk of an electric shock.
	Indicates a risk of a personal injury due to heat.
	Indicates a risk of catching your fingers.
	Indicates a risk of a fire or smoke.
	Indicates a general precaution or warning that is not defined herein.
	Indicates a risk of losing eyesight due to laser beam.
	Indicates a risk of an explosion.
	Indicates a risk of a personal injury.

**Prohibited actions**

	Indicates a general prohibition that is not defined herein.
	Do no touch the indicated area. There is a risk of an electric shock or fire.
	Do not touch with wet hands. There is a risk of an electric shock.
	Keep from flame. There is a risk of a fire.
	Avoid using water or liquid nearby. If it spills on the equipment, there is a risk of an electric shock or fire.
	Do not disassemble, repair, or modify the equipment. There is a risk of an electric shock or fire.

## Mandatory actions

	Unplug the server. There is a risk of an electric shock or fire.
	Indicates a general action to take that is not defined herein. Make sure to follow the instructions.

For detailed notes to set up the machine safely, refer to “NOTES FOR SAFE HANDLING” on page 1-2.

**NOTE:** This equipment has been tested and found to comply with the limits for a Class A digital device, pursuant to Part 15 of the FCC Rules. These limits are designed to provide reasonable protection against harmful interference when the equipment is operated in a commercial environment. This equipment generates, uses, and can radiate radio frequency energy and, if not installed and used in accordance with the instruction manual, may cause harmful interference to radio communications. Operation of this equipment in a residential area is likely to cause harmful interference in which case the user will be required to correct the interference at his own expense.

This class A digital apparatus meets all requirements of the Canadian Interference-Causing Equipment Regulations.

Cet appareil numérique de la classe A respecte toutes les exigences du Règlement sur le matériel brouilleur du Canada.

**CLASS 1  
LASER PRODUCT**

This system is classified as a CLASS 1 LASER PRODUCT. This label is located on the internal DVD-ROM installed in your system.

**NOTE:** This product provides resistance against hardware faults with its redundant hardware modules. However, this does not mean complete fault-tolerance is assured. For example, there is a risk of system down when:

- A fatal fault occurs in software.
- Both modules within a redundant hardware pair break down.
- A fatal fault occurs in a non-redundant component, such as the clock generator circuitry or the interconnect backplane.
- The entire system is cut off from AC power.

## **Trademarks and Patents**

EXPRESSBUILDER and NEC ESMPRO are trademarks of NEC Corporation.

Microsoft, Windows, Windows Server, Windows NT, and MS-DOS are registered trademarks of Microsoft Corporation in the United States and other countries.

Intel and Pentium are registered trademarks of Intel Corporation.

AT is a registered trademark of International Business Machines Corporation in the United States and other countries.

Adobe, the Adobe logo, Acrobat, and the Acrobat logo are trademarks of Adobe Systems Incorporated.

Datalight is a registered trademark of Datalight, Inc. ROM-DOS is a trademark of Datalight, Inc.

Xeon is a trademark of Intel Corporation in the United States. DLT and DLTtape are trademarks of Quantum Corporation in the United States.

All other product, brand, or trade names used in this publication are the trademarks or registered trademarks of their respective trademark owners.

Microsoft Windows Server 2003 R2 Standard x64 edition operating system and Microsoft Windows Server 2003 R2 Enterprise x64 Edition operating system or Microsoft Windows Server 2003 Enterprise x64 Edition operating system are called Windows Server 2003 x64 Edition for short. Microsoft Windows Server 2003 R2 32-bit Standard Edition operating system, Microsoft Windows Server 2003 R2 32-bit Enterprise Edition operating system, Microsoft Windows Server 2003 Standard Edition operating system and Microsoft Windows Server 2003 Enterprise Edition operating system are called Windows Server 2003 for short. Microsoft Windows 2000 Server operating system, Microsoft Windows 2000 Advanced Server operating system and Microsoft Windows 2000 Professional operating system are called Windows 2000 for short. Microsoft Windows Vista Business operating system is called Windows Vista for short. Microsoft Windows XP Professional x64 Edition operating system is called Windows XP x64 Edition for short. Microsoft Windows XP Home Edition operating system and Microsoft Windows XP Professional operating system are called Windows XP for short. Microsoft Windows NT Server network operating system version 3.51/4.0 and Microsoft Windows NT Workstation operating system version 3.51/4.0 are called Windows NT for short. Microsoft Windows Millennium Edition Operating System is called Windows Me for short. Microsoft Windows 98 operating system is called Windows 98 for short. Microsoft Windows 95 operating system is called Windows 95 for short. Names used with sample applications are all fictitious. They are unrelated to any existing product names, names of organizations, or individual names.

## **Preface**

Welcome to the Fault Tolerant Server series.

Fault Tolerant Server series is a “fault-tolerant (ft)” server focusing on “high reliability” in terms of fault-tolerance, in addition to the “high performance,” “scalability,” and “general versatility”. In the event of trouble, its dual configuration will allow the system to instantaneously isolate the failed parts to assure non-stop running; operation will be moved smoothly from one module to the other, minimizing damage to it. You can use series in a mission-critical system where high availability is required. By the use of Windows Server 2003 operating system, it also provides outstanding openness for general-purpose applications, etc.

To make the best use of these features, read this User's Guide thoroughly to understand how to operate Fault Tolerant Server series.



## **About This User's Guide**

This User's Guide helps a user to properly setup and use the product. Consult this guide when you set up the product.

Keep this manual and the separate volume of User's Guide handy.

This User's Guide is intended for users who have a good knowledge on the basic use of Windows operating systems and general I/O devices such as a keyboard and mouse.

## **How to Use This User's Guide**

This guide explains the procedures you should perform before you begin system operation after you purchased the product. Read the guide in order from Chapter 1. If you perform procedures according to this guide, you will set up the product properly.

Chapter 4 describes how to install the operating system. Chapter 5 describes post-installation procedures. Chapter 6 explains how to troubleshoot if you cannot set up the product properly. Refer to "SYSTEM REPAIR" on page 6-2 for details about system configurations and repairs of this product. Refer to "TROUBLESHOOTING" on page 6-13 if you feel you failed to set up the product.

See this User's Guide for details of this product's operation, and functions and operations of the hardware and the system.

## Additional symbols

The following symbols are used throughout this User's Guide in addition to the caution symbols described at the beginning.

<b>IMPORTANT:</b>	Important points or instructions to keep in mind when using the server or software
<b>CHECK:</b>	Something you need to make sure when using the server or software
<b>TIPS:</b>	Helpful information, something useful to know

## About our Web Service

Information on Fault Tolerant Server series including modification modules is also available on the manufacturer web site.

## Contents

<b>Preface</b> .....	<b>viii</b>
<b>About This User's Guide</b> .....	<b>ix</b>
How to Use This User's Guide .....	ix
Additional symbols .....	x
About our Web Service .....	x
<b>CHAPTER 1</b> .....	<b>1-1</b>
<b>BEFORE USING</b> .....	<b>1-1</b>
<b>PRECAUTIONS FOR SAFETY</b> .....	<b>1-2</b>
General .....	1-2
Use of Power Supply and Power Cord .....	1-3
Installation, Relocation, Storage and Connection.....	1-4
Cleaning and Handling of Internal Devices .....	1-5
During Operation.....	1-6
Rack-mount Model.....	1-7
<b>UNPACKING</b> .....	<b>1-9</b>
Accessories.....	1-9
<b>CHAPTER 2</b> .....	<b>2-1</b>
<b>ABOUT OPERATING SYSTEM</b> .....	<b>2-1</b>
<b>INSTALLING Windows Server 2003</b> .....	<b>2-2</b>
About OS Installation .....	2-2
<b>CHAPTER 3</b> .....	<b>3-1</b>
<b>INSTALLING SERVER</b> .....	<b>3-1</b>
<b>INSTALLATION</b> .....	<b>3-2</b>
Installing the device to the rack.....	3-2
Unmounting the device from the rack .....	3-7
Connect peripheral devices to Fault Tolerant Server series .....	3-8
<b>CHAPTER 4</b> .....	<b>4-1</b>
<b>WINDOWS SETUP</b> .....	<b>4-1</b>
<b>BEFORE STARTING SETUP</b> .....	<b>4-2</b>
<b>SETUP FLOW</b> .....	<b>4-3</b>
<b>Step 1: Things Required for Setup</b> .....	<b>4-4</b>
Size of the Partition to be Created .....	4-5
<b>Step 2: Prepare for Express Setup</b> .....	<b>4-6</b>

2-1: Prepare Fault Tolerant Server series .....	4-6
<b>Step 3: Disable OS Boot Monitoring Function .....</b>	<b>4-8</b>
<b>Step 4: Start the Express Setup .....</b>	<b>4-12</b>
Flow of Setup Procedures.....	4-13
Setup Procedures .....	4-14
<b>Step 5: Windows Setup Wizard.....</b>	<b>4-17</b>
<b>Step 6: Windows Server 2003 Service Pack Installation .....</b>	<b>4-18</b>
<b>Step 7: Set Dual LAN Configuration .....</b>	<b>4-19</b>
Overview .....	4-19
Fault Tolerant Server Series Duplication Rule.....	4-20
Dual Configuration Setup.....	4-20
<b>Step 8: Set Dual Disk Configuration .....</b>	<b>4-25</b>
Setting Dual Disk Configuration by RDR (Rapid Disk Resync) function .....	4-25
<b>Step 9: Update Software.....</b>	<b>4-31</b>
<b>Step 10: Connect and Configure Options .....</b>	<b>4-32</b>
<b>Step 11: Create Volume.....</b>	<b>4-33</b>
<b>Step 12: Set Network for NEC ESMPRO Agent.....</b>	<b>4-34</b>
<b>Step 13: Enable OS Boot Monitoring Function.....</b>	<b>4-36</b>
<b>Step 14: Make Settings for Failure Management .....</b>	<b>4-37</b>
Set Memory Dump (Debug Information).....	4-37
Set Dr. Watson .....	4-41
Install a Network Monitor .....	4-42
Set Recovery Console .....	4-43
<b>Step 15: Back up System Information .....</b>	<b>4-44</b>
<b>CHAPTER 5 .....</b>	<b>5-1</b>
<b>PROCEDURES AFTER COMPLETION OF INSTALLATION .....</b>	<b>5-1</b>
<b>INSTALLING MANAGEMENT UTILITIES.....</b>	<b>5-2</b>
System Update.....	5-2
NEC ESMPRO Agent .....	5-3
NEC ESMPRO Manager.....	5-9
<b>CONFIRMATION OF THE ft Server Control Software VERSION .....</b>	<b>5-9</b>
<b>APPLYING Windows Service Pack.....</b>	<b>5-10</b>
Notes to apply the Windows Service Pack.....	5-10
Applying Windows Service Pack.....	5-10
<b>COMPRESSING A SYSTEM DRIVE.....</b>	<b>5-10</b>
<b>ABOUT Windows Update (APPLYING SECURITY PATCHES).....</b>	<b>5-11</b>
<b>CHAPTER 6 .....</b>	<b>6-1</b>

<b>TROUBLESHOOTING .....</b>	<b>6-1</b>
<b>SYSTEM REPAIR.....</b>	<b>6-2</b>
Preparation .....	6-3
Starting up Recovery Console.....	6-4
Updating the System .....	6-7
Installing ft Server Control Software .....	6-10
<b>TROUBLESHOOTING.....</b>	<b>6-11</b>
Problems with EXPRESSBUILDER .....	6-11
Problems with Windows Setup .....	6-12
About the Express Setup .....	6-13
Problems with NEC ESMPRO Setup.....	6-14
Problems with System Repair .....	6-14

# Chapter 1

---

## Before Using





This chapter includes information necessary for proper and safe operation of the server, the main unit and its accessories. Go through this chapter before you start setup of the product.



## PRECAUTIONS FOR SAFETY

This section provides precautions for using the server safely. Read this section carefully to ensure proper and safe use of the server. For symbol meanings, see “Safety Indications” described in the previous section.

---

### General

 <b>WARNING</b>	
	<p>Do not use the server in an operation where human lives are involved or high reliability is required.</p> <p>This equipment is not intended for use in controlling or use with facilities or systems where human lives are involved or high reliability is required, including medical devices or nuclear, aerospace, transportation, and traffic control facilities. The manufacturer assumes no liability for any accidents or damage to physical assets resulting from the use of this equipment in such systems or facilities.</p>
	<p>Do not continue to use the server if you detect smoke, odor, or noise.</p> <p>If the server emits smoke, odor, or noise, immediately flip off the POWER switch, unplug the cords, and contact your sales agent. There is a risk of a fire.</p>
	<p>Do not insert a wire or metal object.</p> <p>Do not insert a wire or metal objects into a vent or disk drive slot. There is a risk of an electric shock.</p>

 <b>CAUTION</b>	
	<p>Prevent water or foreign objects from getting into the server.</p>
	<p>Do not let water or foreign objects (e.g., pins or paper clips) enter the server. There is a risk of a fire, electric shock, and breakdown. When such things accidentally enter the server, immediately turn off the power and unplug the cords. Contact your sales agent instead of trying to disassemble it yourself.</p>

---

## Use of Power Supply and Power Cord

### WARNING



Do not handle power plugs with a wet hand.

Do not plug/unplug power cords with a wet hand. There is a risk of an electric shock.



Do not connect the ground wire to a gas pipe.



Never connect the ground wire to a gas pipe. There is a risk of a gas explosion.

### CAUTION



Do not plug the cords in nonconforming outlets.



Use wall outlets with specified voltage and power type. There is a risk of a fire or current leakage.

Avoid installing the server where you may need extension cords. If the cords do not meet the power specifications, there is a risk of overheating that could lead to a fire.



Do not plug too many cords in a single outlet.

If the rated current is exceeded, there is a risk of overheating that could lead to a fire.



Do not plug the cords insecurely.



Insert the plug firmly into an outlet. There is a risk of heat or fire due to poor contact. If dust settles on the slots and it absorbs moisture, there is also a risk of heat or fire.



Do not use nonconforming power cords.



AC cord is to spend the thing of the next specifications:

You also have to observe the following prohibitions to prevent an electric shock or fire caused by damage to the cords.

- Do not pull on the cords.
- Do not pinch the cords.
- Do not bend the cords.
- Keep chemicals away from the cords.
- Do not twist the cords.
- Do not place any object on the cords.
- Do not use cords as bundled.
- Do not alter, modify, or repair the cords.
- Do not staple the cords.
- Do not use any damaged cord. (Replace it with a new one of the same specifications. For replacement procedures, contact your sales agent.)



---

## Installation, Relocation, Storage and Connection

### CAUTION



Do not install the server in an unsuitable place.

Install the server in such a place as specified in this User's Guide. Avoid the following locations. There is a risk of a fire.

- a dusty place
- a humid place located near a boiler, etc
- a place exposed to direct sunlight
- an unstable place



Do not use or store this product in a corrosive environment.

Avoid the usage or storage of this product in an environment which may be exposed to corrosive gases, such as those including but not limited to : sulfur dioxide, hydrogen sulfide, nitrogen dioxide, chlorine, ammonia and/or ozone.

Avoid installing Fault Tolerant Server series in a dusty environment or one that may be exposed to corrosive materials such as sodium chloride and/or sulfur.

Avoid installing this product in an environment that may have excessive metal flakes or conductive particles in the air.

Such environments may cause corrosion or short circuits within this product, resulting in not only damage to this product, but may even lead to be a fire hazard.

If there are any concerns regarding the environment at the planned site of installation or storage, please contact your sales agent.



Do not use any non-designated interface cable.

Use only interface cables designated by the manufacturer; identify which component or connector to attach beforehand. If you use a wrong cable or make a wrong connection, there is a risk of short-circuit that could lead to a fire.

You also have to observe the following prohibitions about handling and connecting interface cables:

- Do not use any damaged cable connector.
- Do not step on the cable.
- Do not place any object on the cable.
- Do not use the server with loose cable connections.
- Do not use damaged cables.

## Cleaning and Handling of Internal Devices

### WARNING



Do not disassemble, repair, or alter the server.



Unless described herein, never attempt to disassemble, repair, or alter the server. There is a risk of an electric shock or fire as well as malfunction.



Do not look into the DVD-ROM drive.



The DVD-ROM drive uses a laser beam. Do not look or insert a mirror inside while the system is on. A laser beam is invisible; if your eyes get exposed to it, there is a risk of losing eyesight.



Do not detach a lithium battery yourself.

This equipment has a lithium battery. Do not detach it yourself. If the battery is exposed to fire or water, it could explode.

When the lithium battery is running down and the server does not work correctly, contact your sales agent instead of disassembling, replacing or recharging it yourself.



Disconnect the power plugs before cleaning the server.



Even though built-in options for the server can be replaced while the power cords are connected to power source, be sure to follow the instructions described in this User's Guide. Do not touch any internal device of the server unless instructed by this User's Guide. There is a risk of an electric shock.



Make sure to power off the server and disconnect the power plug from a power outlet before cleaning or installing/removing internal optional devices. Touching any internal device of the server with its power cords connected to power source may cause an electric shock even if the server is off-powered.

Disconnect the power plug from the outlet occasionally and clean the plug with a dry cloth. Heat will be generated if condensation is formed on a dusty plug, which may cause a fire.

### CAUTION



High temperature

Immediately after powering off the system, system components such as hard disk may be very hot. Wait for the server to cool down completely before adding/removing components.



Make sure to completely insert cables and boards.

Completely insert all power cords, interface cables and/or boards. An incompletely inserted component may cause a contact failure, resulting in fire and/or smoke.



Protect the unused connectors with the protective cap.



The unused power cord connectors are covered with the protective cap to prevent short circuits and electrical hazards. When removing the power cord connector from the internal devices, attach the protective cap to the connector. Failure to follow this warning may cause a fire or an electric shock.

---

## During Operation

### CAUTION



Keep animals away.



Keep animals away from the server. Animal's waste or hair may get inside the server to cause a fire or electric shock.



Do not place any object on top of the server.

The object may fall off to cause injuries, damage to hardware and/or a fire.



Do not leave the DVD tray ejected.

Dust may get in the server to cause malfunction. The ejected tray may also become a cause of injuries.



Do not touch the server when it thunders.

Unplug the server when it threatens to thunder. If it starts to thunder before you unplug the server, do not touch the server or cables. There is a risk of a fire or electric shock.



Do not use a cellular phone or pager around the server.

Turn off your cellular phone or pager when you use the server. Their radio waves may cause the server to malfunction.

---

## Rack-mount Model

### WARNING



Do not install the server on a nonconforming rack.

Install the server on a 19-inch rack conforming to the EIA standard. Do not use the server without a rack or install it on a nonconforming rack. The server may not function properly, and there is a risk of damage to physical assets or injuries. For suitable racks, contact your sales agent.



Do not use the server in an unsuitable place.

Do not install a server rack in an unsuitable environment. Other systems also may be affected, and the rack may fall over to cause a fire or injuries. For details about installation environment and quake-resistant engineering, see the attached manual or contact your sales agent.

### CAUTION



Be careful not to hurt your fingers.

Exercise great care not to hurt your fingers on the rail when you mount/dismount the server into/from the rack.



Carry or install the server by more than 3 people.

To avoid a risk of injuries, users should not attempt to carry or install the server into a rack. Installation should be performed by trained maintenance personnel.



Do not install the server in such a manner that its weight is imposed on a single place.

To distribute the weight, use stabilizers or attach two or more racks. Unstable rack may fall down to cause injuries.



Do not assemble parts alone.

It takes at least two people to mount doors and trays to a rack. If you handle them alone, you may drop some parts to cause a breakage or injuries.



Do not pull a device out of the rack if the rack is unstable.

Before pulling out a device, make sure that the rack is fixed (by stabilizers or quake-resistant engineering).



Do not leave more than one device pulled out from the rack.

If you pull out more than one device, the rack may fall down. You can only pull out one device at a time.



Do not install excessive wiring.



To prevent burns, fires, and damage to the server, make sure that the rated load of the power branch circuit is not exceeded. For more information on installation and wiring of power-related facilities, contact your electrician or local power company.



 **CAUTION**



Do not pull out a device during operation.

Do not pull out or remove a device while it is running. There is a risk of malfunction and a device may be detached from a rack to cause injuries.

## UNPACKING

This product and various accessories are in the special shipping box. Take them out from the box and check the individual items. Store the box and unused accessories in a safe place.

---

### Accessories

This product is shipped with various accessories. See the packing list to make sure everything is included and check the individual items. If any component is missing or damaged, contact your sales agent.

- Keep the accessories in a safe place. You will need them when you perform setup, addition of options, or replacement of failed components.
- To check EXPRESSBUILDER components, see the attached list.
- Be sure to fill out and mail the software registration card that is shipped with the operating system.
- Make backup copies of included floppy disks, if any. Keep the original disks as the master disks; use these copies in operation.
- Improper use of an included floppy disk or CD-ROM may alter your system environment. If you find something unclear, stop using them and contact your sales agent.

# Chapter 2

---

## About Operating System

This chapter gives essential information on the Windows system supported by the server and how to install it.

## INSTALLING Windows Server 2003

For installing an operating system on Fault Tolerant Server series, use EXPRESSBUILDER.

---

### **IMPORTANT:**

The Fault Tolerant Server series is a precision instrument. You should ask maintenance personnel to install it.

---

The Express Setup program is exclusively used for the Fault Tolerant Server series. To execute the setup program, simply select the item [Express Setup] from the menu displayed when starting the system through the provided CD-ROM "EXPRESSBUILDER." The setup program automatically performs the complete setups from hardware internal parameter/status settings to installation of the operating system (Windows Server 2003) and various utilities.

Use the Fault Tolerant Server series setup program for the first installation and reinstallation of the operating system. This program accomplishes complicate setups.

Before performing the Fault Tolerant Server series setup, contact your sales agent about the latest release of ft Server Control Software.

---

### **About OS Installation**

Read the notes here carefully before installing the operating system.

### **Operating System Supported by the Fault Tolerant Server series**

The operating system that Fault Tolerant Server series supports is Microsoft® Windows Server™ 2003 R2 32-bit Enterprise Edition (English), hereinafter called "Windows Server 2003."

Fault Tolerant Server series does not support any operating systems other than the above (e.g., Windows Server 2003 Standard Edition, Windows 2000 or Windows NT 4.0).

### **About Windows Server 2003**

Use the Express Setup program to install Windows Server 2003. Note the following at installation:

---

### **IMPORTANT:**

- Complete all the setups such as the memory expansion and the BIOS setting before installing Windows Server 2003.
  - A software package, which is to be purchased separately, is also provided with the documentation for installation. However, see this User's Guide for installation into this server.
  - After completing the Express Setup program, make settings for failure management (e.g., memory dump (debug information) setting according to Chapter 4.
- 

### **About Auto Installation of Utilities**

The Express Setup installs the following utilities automatically.

- Drivers and services for achieving duplicated operation
- NEC ESMPRO Agent



# Chapter 3

---

## Installing Server

This chapter describes requirements for using the product properly and safely, the setup procedures to make Fault Tolerant Server series ready for use, and how to connect peripherals.



# INSTALLATION





This section describes installation of Fault Tolerant Server series.

---

## Installing the device to the rack

Install this device to the rack. as described in this section.

 <b>WARNING</b>	
	<p>Observe the following precautions to use the server safely. There is a risk of a death or serious injury. For details, see “Notes for Safe Handling” in Chapter 1.</p> <ul style="list-style-type: none"><li>■ Do not use the product with the unspecified rack.</li><li>■ Do not use the product at non-designated places.</li></ul>

 <b>CAUTION</b>	
   	<p>Observe the following precautions to use the server safely. There is a risk of a burn, personal injury, or damage to physical assets. For details, see “Notes for Safe Handling” in Chapter 1.</p> <ul style="list-style-type: none"><li>■ Do not install or remove a rack alone.</li><li>■ Do not install the server with the cover removed.</li><li>■ Do not squeeze your fingers in the product.</li></ul>

---

### IMPORTANT:

Temperature increase inside the rack and airflow

If you install several components or the ventilation isn't good inside the rack, the internal temperature may increase due to heat emitted from the components. When the operating temperatures of Fault Tolerant Server series (10 to 35°C) are exceeded, there is a risk of malfunction. You must take adequate precautions and measures for airflow inside the rack as well as in the room so that the internal temperature can be kept within this range during operation.

---

- Required tool

To install the device to the rack, a Phillips-head screw drive is required.

- Checking the place to install

Decide the place (height) to install. To keep balance, install it as low as you can on the rack. To install the rack, the height for 4U is required.

---

**IMPORTANT:**

To install this device to the rack, the space for 1U is required for installing the USB compatible floppy disk drive, in addition to the space for 4U.

---

Next to the square hole of the rack, an imprinted mark is placed for 1U (This is the unit to show the height of the rack). This device is as high as 4U (about 176 mm), so install it between the imprinted marks that indicate the height of 4U.

● Installing this device

Follow the steps below to set the 4U chassis to the rack.

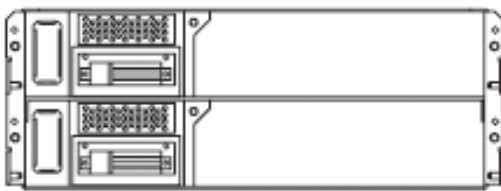

Front side of 4U chassis

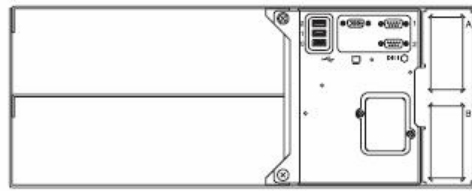

Rear side of 4U chassis

---

**IMPORTANT:**

4U chassis weighs about 10 Kg. To mount, remove or replace it, be sure to hold it with two or more people.

The following are the required accessories. Make sure you have them all.

- |                            |     |
|----------------------------|-----|
| - Bracket                  | -2  |
| - Panhead screw            | -4  |
| - Washer for panhead screw | -4  |
| - Plate screw (short)      | -8  |
| - Plate screw (long)       | -4  |
| - Washer for plate screw   | -12 |

**TIPS:**

Core nuts (8 pieces) are not included. Use the core nuts that are attached to the rack.

---

1. If the rack has front and rear doors, read the instruction that comes with the rack, and open them.
2. Install the brackets from the rear side of the rack. Install the brackets with its flat side facing inside. Place them with washers for panhead screw that come with this device, and panhead screws symmetrically (total: 4). Fasten the screws tentatively not tightly.

4U (top of device)

3U

2U

1U

Bottom of device

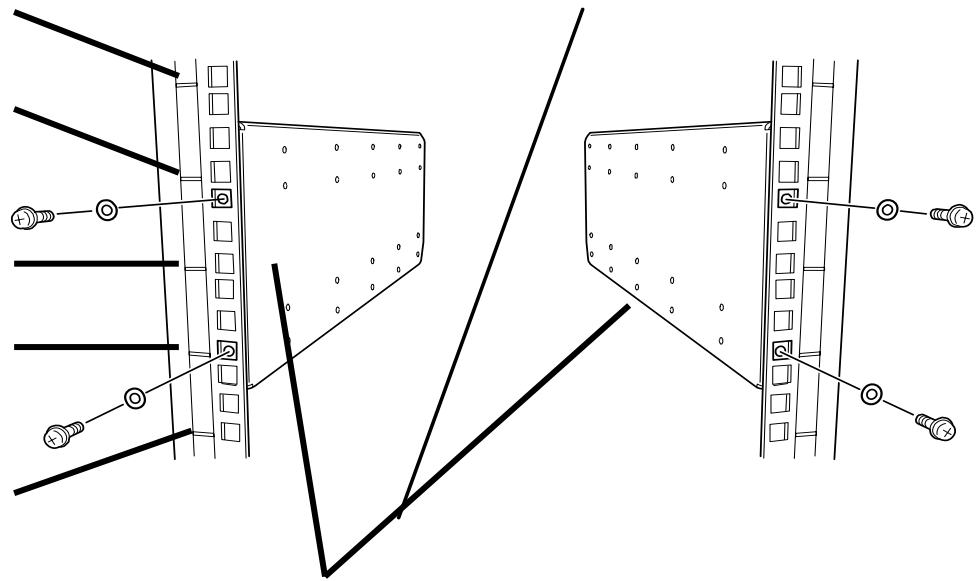

Bracket (flat sides are facing inside)

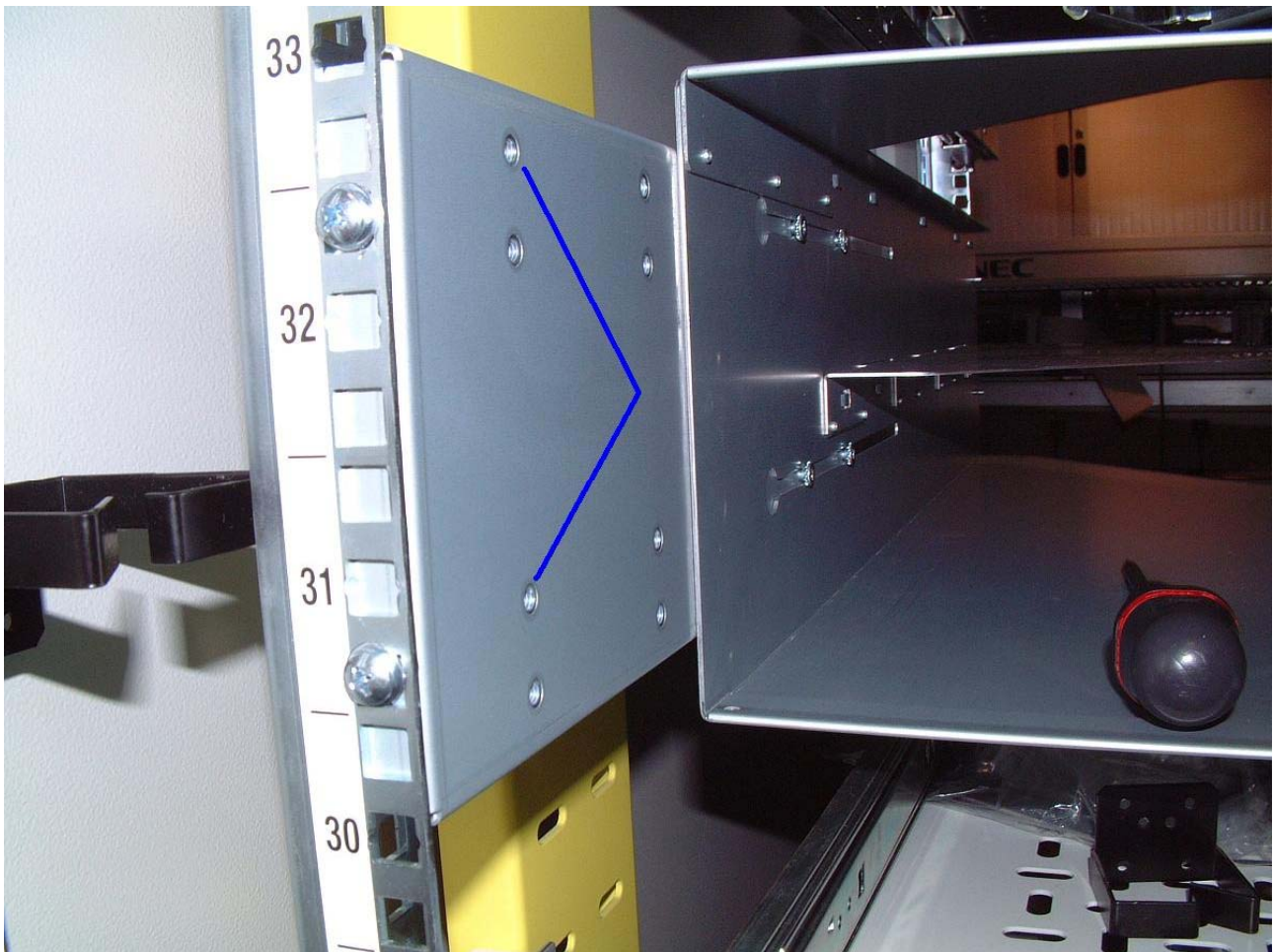

- Fix the core nuts to the front side of the rack.  
Attach them symmetrically (total: 8 core nuts).

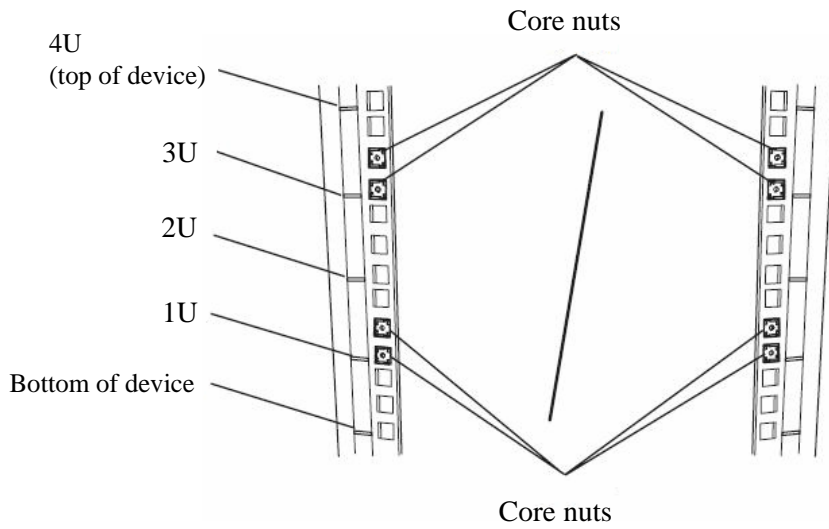

Fix a core nut from inside of the rack.  
Hook either of the clips of the core nut to a square hole of the rack,  
and hook the other clip to a hole by a flat-blade screwdriver.

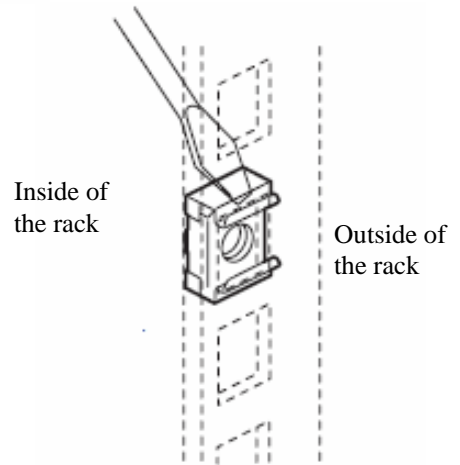

- Insert the 4U chassis from the front side of the rack.

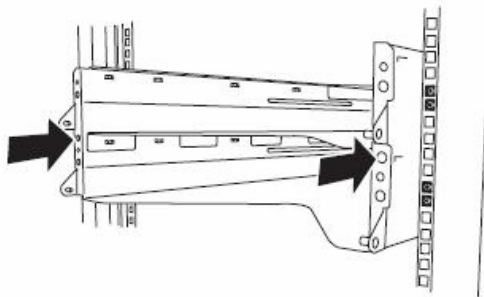

- Tentatively fasten the washers for plate screw and plate screws (short) on 4 places to the on the front and back sides (total: 8 places) from the rear.

6. Fasten tightly the washers for plate screw and plate screws (long) on the 2 places on the right and left sides (total: 4) from the front.

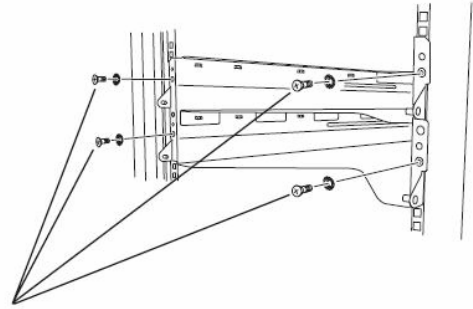

Washers and plate screws (long)

7. Fasten tightly the 4 round screws on the back side and the 8 plate screws on the side panels (which you fastened tentatively).

8. Mount the CPU/IO module 0.  
Mount the module while lowering the lock so the module stacks on the way.

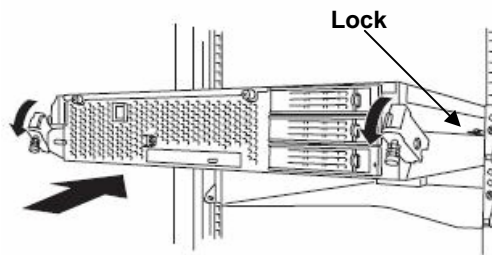

9. Fasten the levers on the left and right sides with screws.

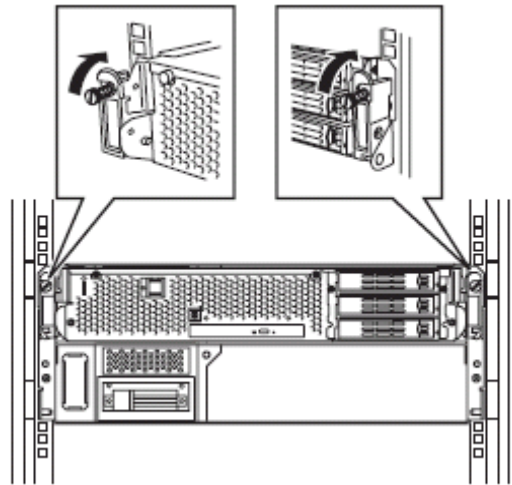

10. Mount the CPU/IO module 1 in the same way.

---

## Unmounting the device from the rack

Follow the steps below and unmount the device from the rack.

<b>⚠ CAUTION</b>	
	<p>Observe the following precautions to use the server safely. There is a risk of a burn, personal injury, or damage to physical assets. For details, see “Notes for Safe Handling” in Chapter 1.</p> <ul style="list-style-type: none"><li>■ Do not carry or install a rack alone.</li><li>■ Do not squeeze your fingers in the product</li><li>■ Do not impose a weight on the device when it is pulled out from the rack.</li><li>■ Do not pull a device out of the rack if the rack is unstable.</li><li>■ Do not leave more than one device pulled out from the rack.</li><li>■ Do not pull the device from the rack while it is operating.</li></ul>

1. Check that the device is powered off, and remove all the power cords and interface cables that are connected to the device.
2. Remove the front bezel.
3. Loosen the screws on the left and right sides of the front panel of the CPU/IO module and release the lock by pulling the ejector toward you.
4. Pull out the CPU/IO module gently from the rack.

---

### **IMPORTANT:**

- When the device is pulled out, do not load anything on its top. It is dangerous, since the device may fall.
- Do not hold the handle on the front side or the convex part on the back side. To move the device, hold the bottom.
- Since the device is locked and can not be pulled out, pull it out after releasing the lock by lowering the lock on the side of the CPU/IO module.



- 
5. When you unmount 4U chassis from the rack, hold it tightly.



To remove the mechanical parts of the rack, see the installation procedure.

---

## Connect peripheral devices to Fault Tolerant Server series

The server is provided with connectors for wide variety of peripheral devices on its front and rear. The figure on the next page illustrates available peripheral devices for the server in the standard configuration, and locations of the connectors for the devices. After connecting the peripheral devices, connect the provided power cords with the server, and then plug the power cords into the power outlet.

 <b>WARNING</b>	
	<p>Observe the following precautions to use the server safely. There is a risk of a death or serious injury. For details, see “Notes for Safe Handling” in Chapter 1.</p> <ul style="list-style-type: none"><li>■ Do not hold the power plug with a wet hand.</li><li>■ Do not connect the ground wire to a gas pipe.</li></ul>

 <b>CAUTION</b>	
	<p>Observe the following precautions instructions to use the equipment safely. There is a risk of a burn, personal injury, or damage to physical assets. For details, see “Notes for Safe Handling” in Chapter 1.</p> <ul style="list-style-type: none"><li>■ Do not plug the power cord in a nonconforming outlet.</li><li>■ Do not plug too many cords in a single outlet.</li><li>■ Do not plug the cord insecurely.</li><li>■ Do not use nonconforming power cords.</li></ul>

---

### IMPORTANT:

- Power off the server before connecting peripheral devices, with the exception of peripherals with USB interface. Connecting a powered peripheral device to the powered server will cause malfunctions and failures.
  - To connect a third-party peripheral device or interface cable to the server, check with your sales agent to see if they are compatible with Fault Tolerant Server series. Some third-party devices may not be used with the server.
  - The total cable length of SCSI device connections is up to 6 m, including the internal SCSI cables.
  - The serial port connectors are reserved for maintenance.
  - Place the USB floppy disk drive on the server. Space of 1U is needed to put it on the server.
-



---

**IMPORTANT:**

## Connection of optional devices

- In the case of standard configuration, you need to complete setup of the operating system before mounting optional PCI cards or hard disks that you purchased separately.
  - If the Fibre Channel controller (Optical) is mounted, be sure to connect the cables to the FC array unit before going on to the next step.
- 

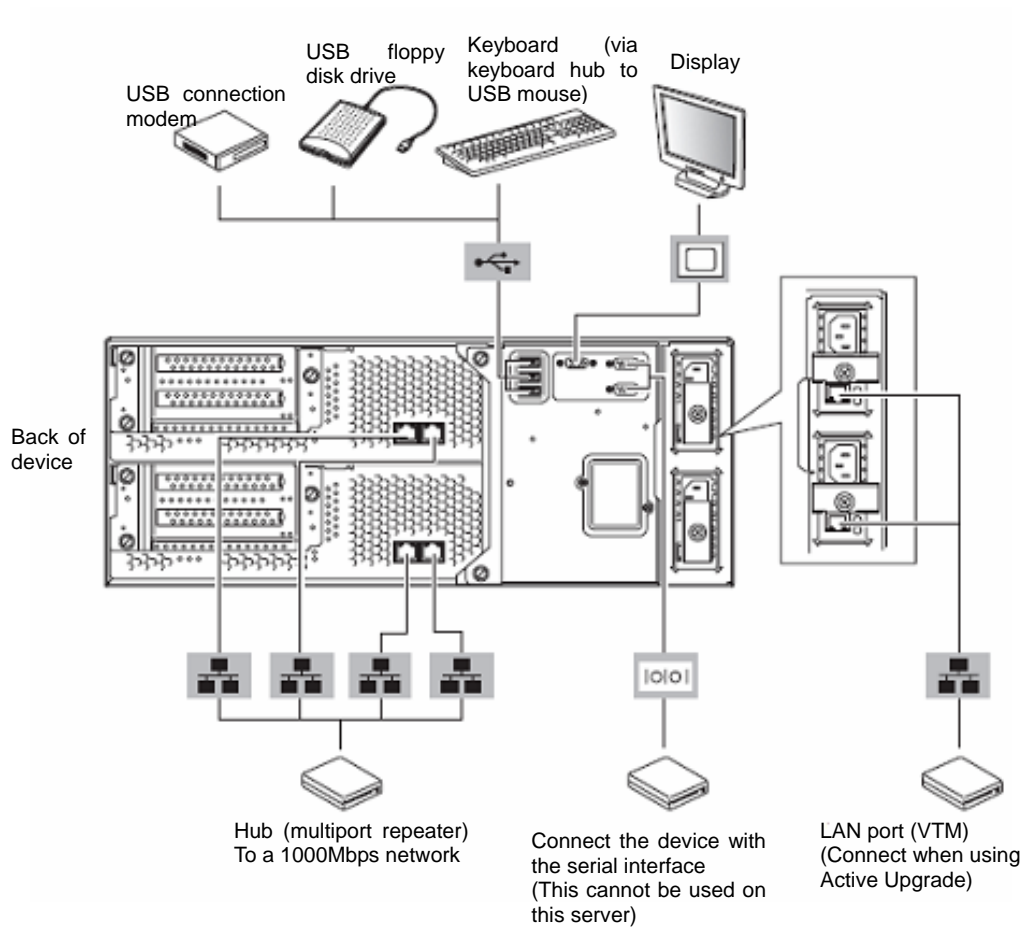

Rotate the stopper in clockwise direction, and insert the power cords to the AC inlets of the power unit.

Connect the plug at the other end of the power cord to a wall outlet with parallel double-pole grounds provided or to an uninterruptible power supply (UPS).

To use the functions of the server, you should connect the server to the UPS.

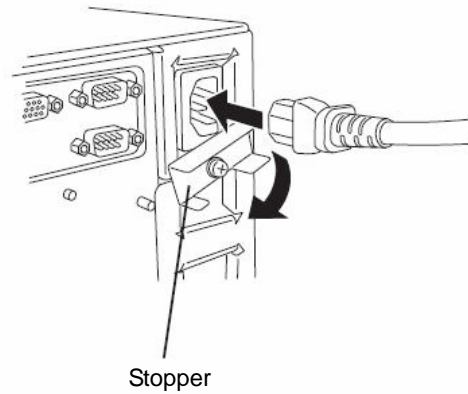

---

**IMPORTANT:**

- Be sure to use both of the power cords to make the server fault-tolerant.
  - When AC is powered on, the fans in power supply unit starts to rotate.
  - After connecting the power cords, wait at least 30 seconds before pressing the power switch.
- 

To connect the power cords from the server to an uninterruptible power supply (UPS), use service outlets on the rear of the UPS.

The UPS service outlets are categorized into two groups: SWITCH OUT and UN-SWITCH OUT. (They may be called "OUTPUT1" and "OUTPUT2".)

To restrict the power supply from ESM/PRO/AutomaticRunningController, connect the power cable to SWITCH OUT.

For constant power supply, connect the power cords to a UN-SWITCH OUT outlet. (Connect the modem that is in service for 24 hours to this outlet.)

When the power cords from the server are connected to a UPS, change the BIOS setup of the server to link with power supply from the UPS.

Select [AC-LINK] from [Server] on the BIOS setup utility and change parameters. See the separate volume of User's Guide for details.

<Example>

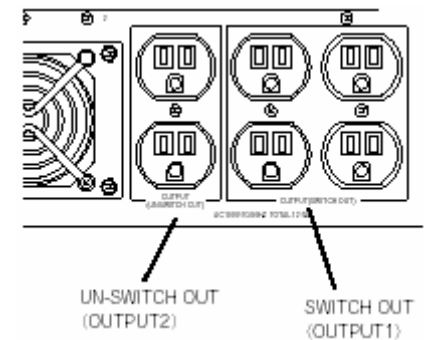

# Chapter 4

---

## Windows Setup

This chapter describes procedures for configuring OS Boot Monitoring function, setting dual LAN configuration, setting dual disk configuration and so on.

# Before starting Setup

Read this section before starting setup.

Use EXPRESSBUILDER to install Windows Server 2003 in the Fault Tolerant Server series.

The setup program that is specific to Fault Tolerant Server series is called “Express Setup.” This setup program is run by using the startup CD-ROM that comes with your server and EXPRESSBUILDER.

Express Setup allows you to install Windows Server 2003 and various utilities automatically.

# SETUP FLOW

The right flow-chart illustrates the flow of the setup procedures for the Fault Tolerant server. Corresponding page numbers are shown in parentheses.

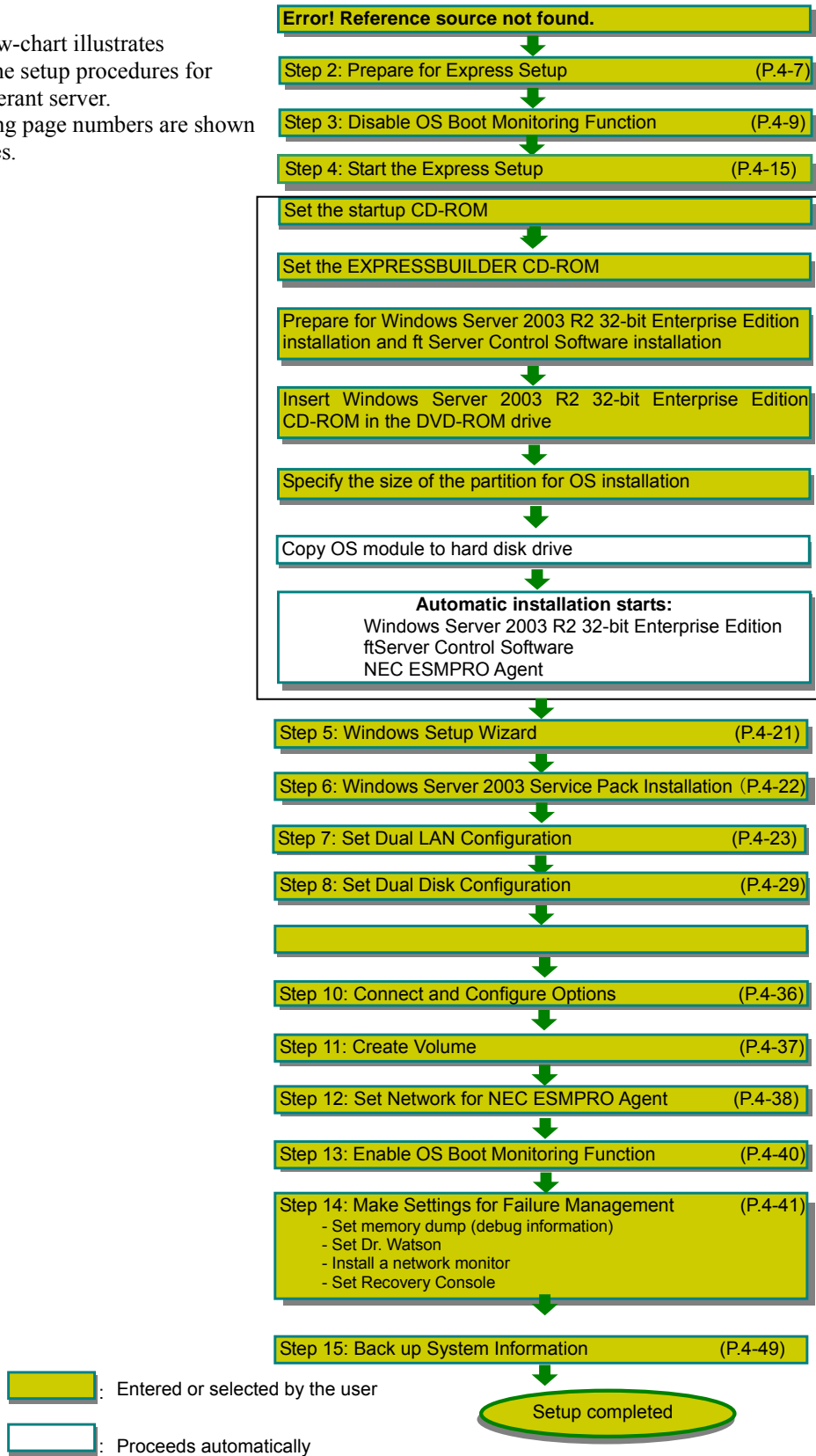

## Step 1: Things Required for Setup

The following explains the setup procedure using the Express Setup program:

---

### IMPORTANT:

- Because “Express Setup” formats the entire area of the disk used for installation, all data on that disk will be deleted. If there is any data partition other than system partition that contains OS on the disk for reinstallation, you must back up important data in the data partition first and then start “Express Setup.”
  - Do not apply service packs to Fault Tolerant Server series based on your judgment. If you desire to apply service packs, contact your sales agent about application status and apply service packs to Fault Tolerant Server series.
- 

---

### TIPS:

For the latest information on support for Windows Service Pack, contact your sales agent.

---

You need the following to install Windows Server 2003 R2 32-bit Enterprise Edition:

- Startup CD-ROM
- EXPRESSBUILDER (CD-ROM)
- ft Server Control Software UPDATE CD-ROM  
This CD-ROM is used to update ft Server Control Software; it may not be shipped with the equipment. (Not included if “EXPRESSBUILDER” CD-ROM contains the latest version of software programs at the time of shipment.)
- Microsoft® Windows Server™ 2003 R2 32-bit Enterprise Edition Disk1  
(hereinafter referred to as “Windows Server 2003 CD-ROM”)  
Microsoft® Windows Server™ 2003 R2 32-bit Enterprise Edition Disk2
- Windows Server 2003 Service Pack CD-ROM  
Use Windows Server 2003 Service Pack 2 for this server.
- User’s Guide (Setup) (this manual)
  
- User’s Guide

---

### IMPORTANT:

- About the latest release of ft Server Control Software and purchase of the latest version of its Update CD-ROM, ask your sales agent.
- 

Before starting the setup, decide the size of the partition where the operating system will be installed.

---

## Size of the Partition to be Created

The required minimum size of a partition to install the system can be obtained from the following formula:

Size required for installation + paging file size + dump file size	
Size required for installation	= 3,500MB (Windows Server 2003 R2)
Paging file size (recommended)	= size of memory mounted* × 1.5
Dump file size	= size of memory mounted* + 12MB

---

### IMPORTANT:

- The above paging file size is necessary for collecting debug information (memory dump). If a value smaller than the “Recommended” value is set for the initial size of the paging file, correct debug information (memory dump) may not be collected.
- The maximum paging file size is 4095MB in a partition. If 1.5 times the size of mounted memory is larger than 4095MB, set the size at 4095MB.
- If the size of mounted memory is larger than 2GB, the maximum size of dump file is “2048MB+12MB.”

---

**TIPS:** The mounted memory size means the total of memory installed on a single CPU/IO module.

---

For example, if memory of 1GB is mounted, the required minimum partition size obtained from the above formula is as follows:

$$3500\text{MB} + (1024\text{MB} \times 1.5) + (1024\text{MB} + 12\text{MB}) = 6072\text{MB}$$

---

### TIPS:

- The minimum partition size you can specify in the Express Setup is 6072MB. The partition size must be 6072MB or larger for automatic installation. Therefore the size smaller than 6072MB cannot be specified.
  - When you select [Create All Area] as system partition size in ExpressSetup, whole area of the disk installed becomes the C drive. The time for resynchronization in replacing a disk becomes longer depending on the capacity of the C drive. Specify the appropriate partition size according to your environment.
-

## Step 2: Prepare for Express Setup

Before starting Express Setup, be sure to do the following. If these preparations are not done, setup cannot be performed properly.

---

### 2-1: Prepare Fault Tolerant Server series

With the power of Fault Tolerant Server series off, follow the steps below:

1. Prepare Fault Tolerant Server series.
  - Mount the modules for both systems.
  - Insert only one hard disk to the Slot 1 of the CPU/IO module 0.
  - Remove all LAN cables.
  - Remove optional SCSI devices such as a tape device from the SCSI connector.

---

#### IMPORTANT:

Do not mount any hard disk into any slots of any modules unless specified. If multiple hard disks are inserted, the hard disk to install OS cannot be determined.

---

2. Prepare the installation from the CPU/IO module 0.

The location of the parts required for operations and check are shown below:

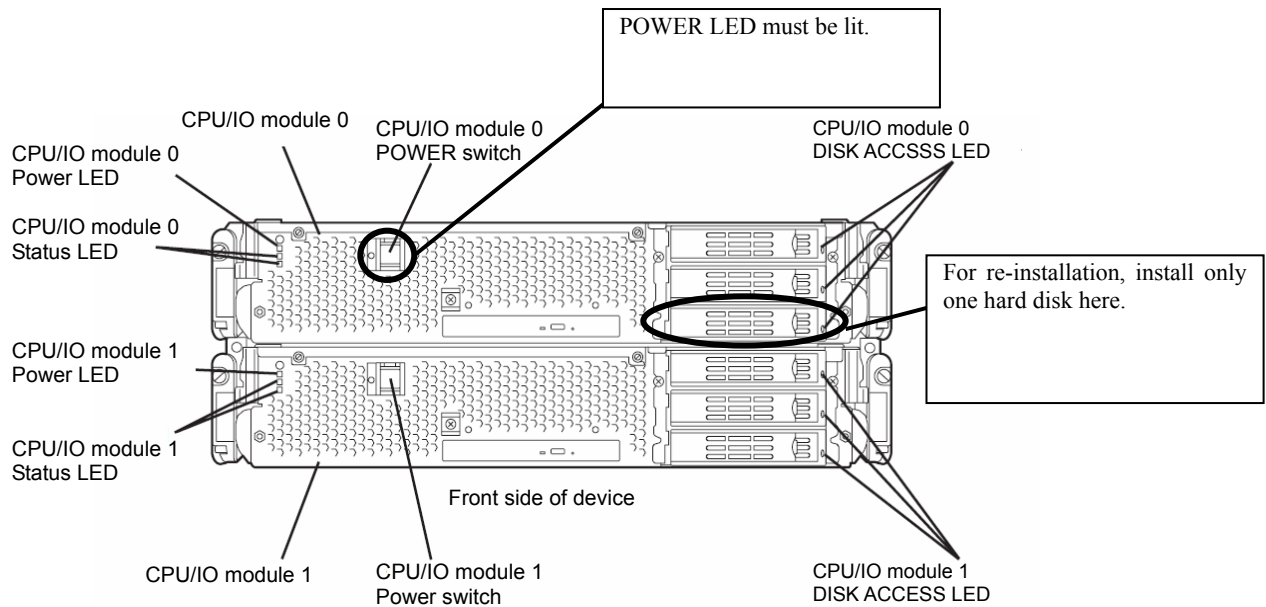



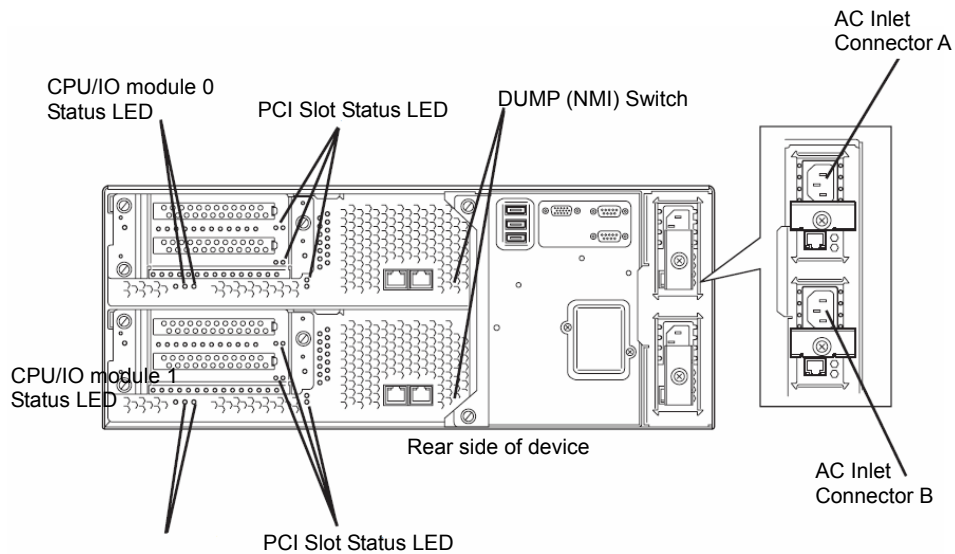

**<When the AC power is on (The power cords are plugged to the wall outlet)>**

- (1) Confirm the POWER LED of the CPU/IO module.
  - If the POWER LED is lit, shut down the OS and unplug the AC power cord after the POWER LED turns off.
  - If the POWER LED is turned off, unplug the AC power cord.
- (2) Execute the operation to be taken when AC power supply is turned off.

**<When the AC power is off (The power cord is not plugged into the outlet)>**

Connect the power cords to Fault Tolerant Server series in the following order:

- (1) Connect the power cord to the AC inlet A connector.
- (2) Connect the power cord to the AC inlet B connector.
- (3) Make sure that the CPU/IO module status LED is turned off.

Preparation is now completed.

## Step 3: Disable OS Boot Monitoring Function

Check whether the power is ON and make settings for properly performing setup for later on.

This equipment has a function to monitor the main unit at startup. (Enabled in the configuration at shipment)

When reinstalling the operating system, this monitoring function needs to be disabled. Otherwise the installation may not be done properly. Follow the steps in this section and make proper settings.

---

### IMPORTANT:

If you skip the settings described here, the system will be restarted forcefully while Windows setup screen is shown and the setup will be unsuccessful. BIOS may repeat Windows setup in an invalid manner. In this case, you will need to restart the setup procedures from the beginning.

---

---

### TIPS:

For details of operations for BIOS Setup Utility and parameters, see the separate volume of User's Guide.

---

### <Procedure for Changing BIOS settings>

1. Turn on the display and the peripheral equipment connected to the Fault Tolerant Server series.

---

### CHECK:

If the power cords are connected to a power controller like a UPS, make sure that it is powered on.

---

2. Detach the front bezel.
3. Press the POWER switch which is located on the front side of the server. (This is the side on which the in-built LED is lit.)

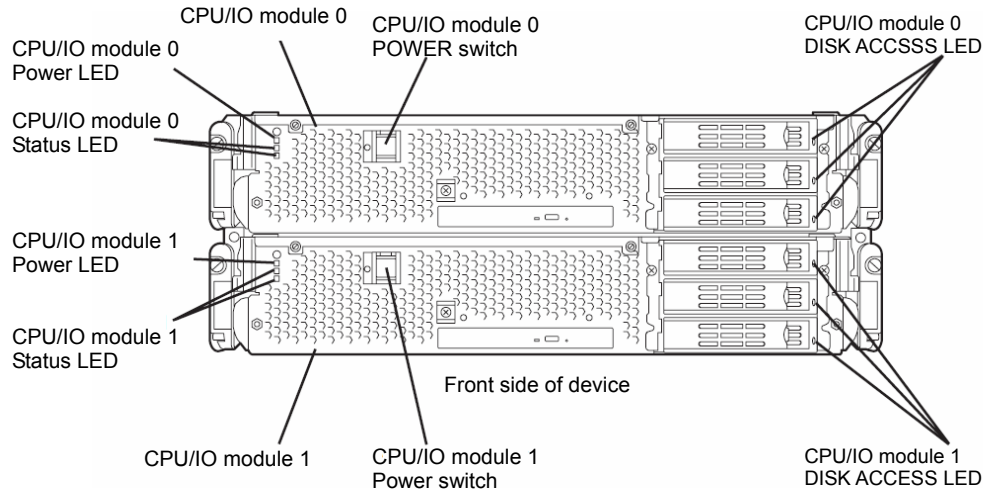

---

### IMPORTANT:

Do not turn off the power before the full screen logo appears.

---

After a while, the full screen logo will appear on the screen.

While the full screen logo is displayed on the screen, Fault Tolerant Server series is performing a power-on self test (POST) to check itself. For details, see the separate volume of User's Guide.

---

### CHECK:

If the server finds errors during POST, it will interrupt POST and display the error message. See the separate volume of User's Guide.

---

- When the message “Press <F2> to enter SETUP” or “Press <F2> to enter SETUP or Press <F12> to boot from Network” is displayed on the display screen, press **F2**.

The BIOS Setup Utility “SETUP” starts and the Main menu is displayed on the screen.

<Example>

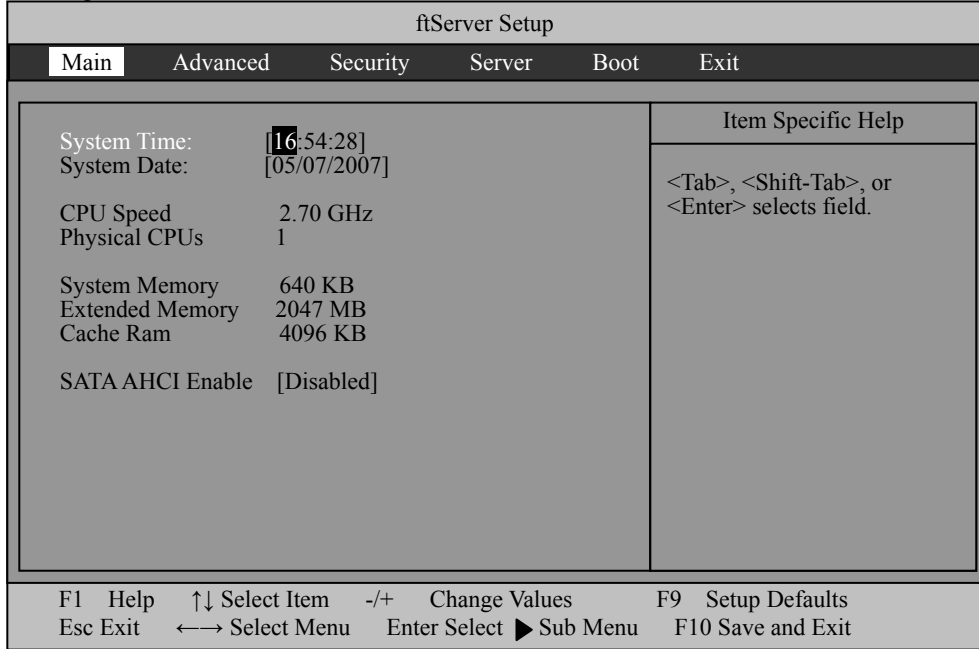

- Move the cursor onto "Server" and select “Server.”

The Server menu will be displayed.

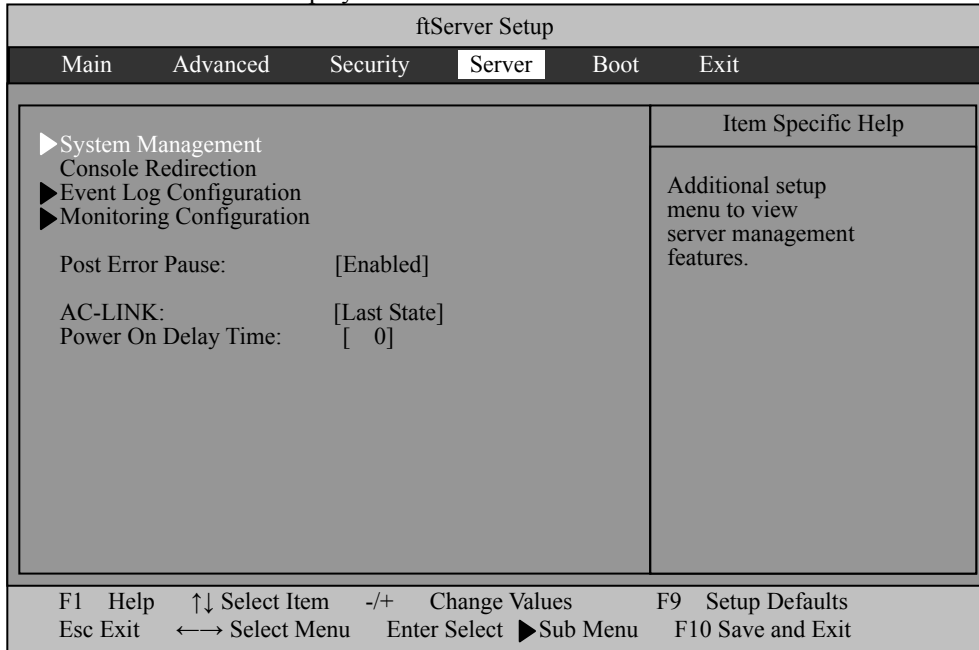

6. Move the cursor onto “Monitoring Configuration” and press **Enter**.

The Monitoring Configuration submenu appears.

ftServer Setup					
Main	Advanced	Security	Server	Boot	Exit
Monitoring Configuration		Item Specific Help			
FRB-2 Timer	[Enabled]	Disables/enables the FRB-2 Timer.			
PCI Enumeration Monitoring:	[Enabled]				
PCI Enumeration Monitoring Timeout:	[ 180]				
Option ROM Scan Monitoring:	[Enabled]				
Option ROM Scan Monitoring Timeout:	[ 300]				
OS Boot Monitoring:	[Enabled]				
OS Boot Monitoring Timeout:	[ 600]				
POST Pause Monitoring:	[Enabled]				
POST Pause Monitoring Time-out	[ 180]				
F1 Help    ↑↓ Select Item    -/+ Change Values    F9 Setup Defaults Esc Exit   ←→ Select Menu    Enter Select    ► Sub Menu    F10 Save and Exit					

7. Move the cursor onto “OS Boot Monitoring” and press **Enter**.

Parameters will be displayed.

8. Among the parameters, choose “Disabled” and press **Enter**.

The current display of the configuration for OS Boot Monitoring will be changed to “Disabled.”

ftServer Setup					
Main	Advanced	Security	Server	Boot	Exit
Monitoring Configuration		Item Specific Help			
FRB-2 Timer	[Enabled]	Disables/enables the FRB-2 Timer.			
PCI Enumeration Monitoring:	[Enabled]				
PCI Enumeration Monitoring Timeout:	[ 180]				
Option ROM Scan Monitoring:	[Enabled]				
Option ROM Scan Monitoring Timeout:	[ 300]				
OS Boot Monitoring:	[Disabled]				
OS Boot Monitoring Timeout:	[ 600]				
POST Pause Monitoring:	[Enabled]				
POST Pause Monitoring Time-out	[ 180]				
F1 Help    ↑↓ Select Item    -/+ Change Values    F9 Setup Defaults Esc Exit   ←→ Select Menu    Enter Select    ► Sub Menu    F10 Save and Exit					

9. Press the **Esc** key to go back to the Server menu, and then move the cursor and select "Exit" to display the Exit menu.

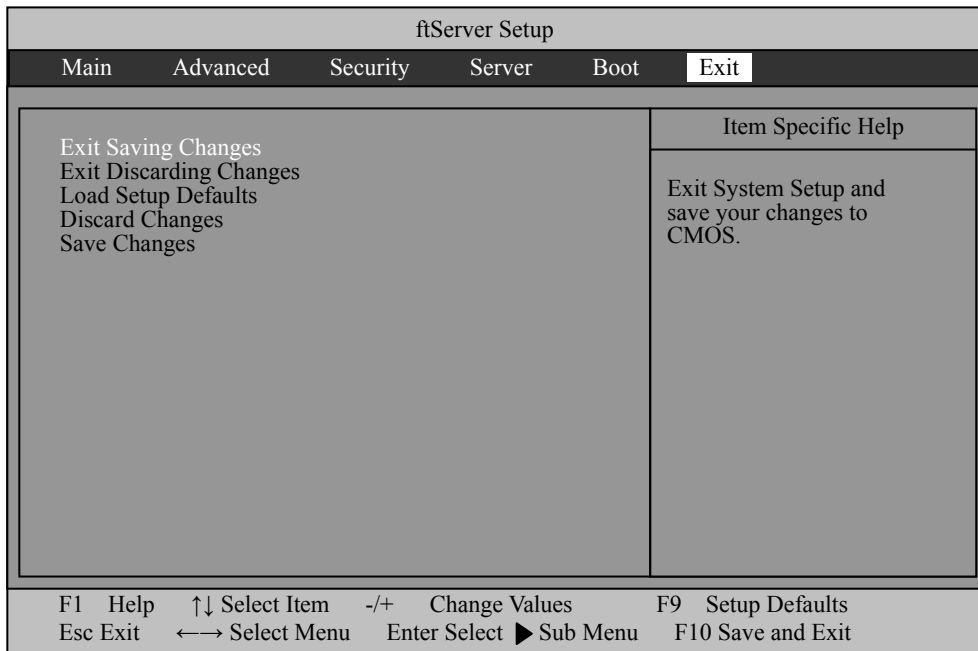

10. Move the cursor onto "Exit Saving Changes" and press **Enter**.

The confirmation window will appear.

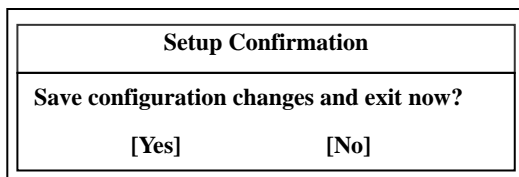

11. Select "Yes" and press **Enter**.

After the configuration data is saved and SETUP is terminated, the system is rebooted. This is the end of steps for switching OS Boot Monitoring function.

---

**TIPS:**

After the procedure above is completed, power off this server to prepare for installation. Then, referring to "Step 4: Start the Express Setup" on the next page to continue the setup.

---

## Step 4: Start the Express Setup

Set up with the Express Setup functions of EXPRESS BUILDER.

“Express Setup” is a setup method that allows configuration of hardware internal parameters and status and installation of OS (Windows Server 2003) and various utilities in seamless manners by using the startup CD-ROM and “EXPRESSBUILDER” CD-ROM which comes with the server. Use the “Express Setup” to install the OS. It performs complicated setups automatically.

Express Setup edits the information required for the setup, saves it to a floppy disk before the setup, reads the information one by one at the setup and automatically performs a series of setup processes. The floppy disk used here is called [Configuration diskette].

---

### TIPS:

- [Configuration diskette] is a setup disk that stores the information set/selected during Express Setup.  
Express Setup executes all the setup process automatically, based on this information. It is not necessary to sit by the system and check the status, during the setup. Also, if you use the Configuration diskette that has been used last time, you can create the same setup condition as the previous one.
- You can create a parameter file in advance, by using “Configuration Diskette Creator®” in EXPRESSBUILDER.  
If you create [Configuration diskette] in advance, you can skip the options that need to be entered or selected during Express Setup. (You can create or modify the setup information in the Configuration diskette, during Express Setup). If any computer that is running on Windows XP/2000/Windows Server 2003 is available, it is recommended to edit the setup information with Configuration Diskette Creator in advance.
- This device does not include the FD drive by standard. To use Configuration diskette, customers need to prepare an optional FD drive.

---

For the procedure to create a parameter file with Configuration Diskette Creator, refer to User’s Guide.

- **Reinstalling the OS to the hard disk drive that has been upgraded to dynamic disk**

You cannot reinstall Windows Server 2003 if the existing partition of the hard disk drive that has been upgraded to dynamic disk is still there.

---

## Flow of Setup Procedures

The following flow-chart illustrates the setup procedures for Express Setup.

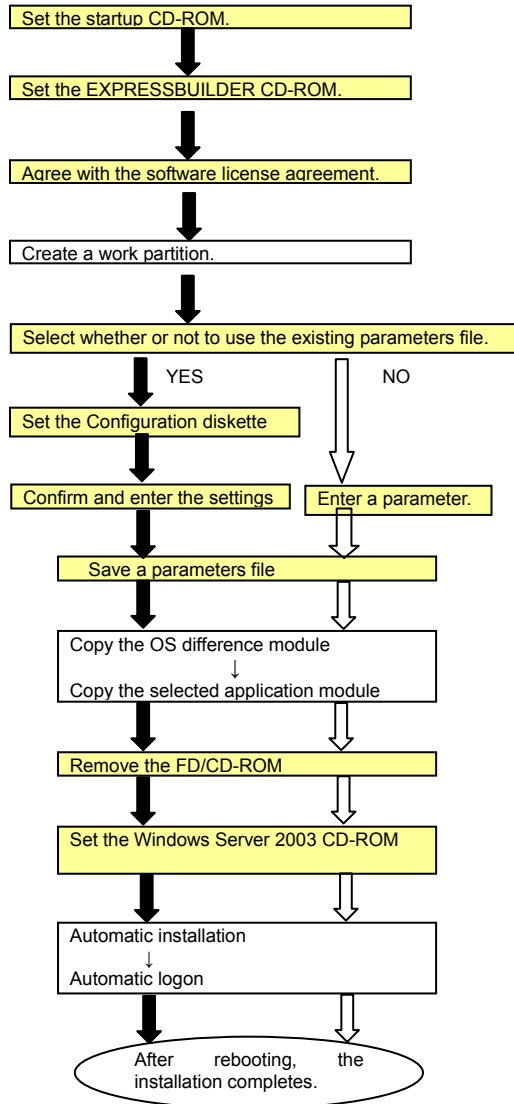

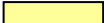
 : Requires data to be entered or selected

 : Proceeds automatically

---

## Setup Procedures

Follow the procedure below to execute Express Setup.

---

### CHECK:

To execute Express Setup with a parameter file, one empty 1.44MB formatted floppy disk is required. Prepare an empty floppy disk in advance.

When you reinstall OS, you can skip entering the parameter in the Wizard form, by reading the parameter file that has been saved.

---

---

### IMPORTANT:

In case of changing the system configuration, update the system (page 6-8).

---

1. Turn on Fault Tolerant Server series. Insert the startup CD-ROM into the DVD-ROM drive, and restart it.
2. When the OS that can be started has been already installed on the hard disk, press the Enter key while the message, "Press any key to boot from CD...", is displayed.

You do not need to perform this operation if the OS that can be started does not exist.

3. If the next message is displayed, insert the EXPRESSBUILDER CD-ROM into the DVD-ROM drive, and select [OK].

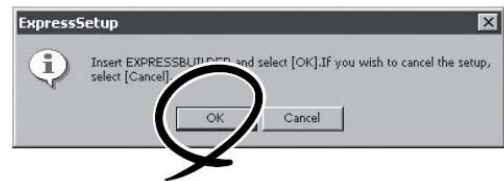

4. If the license agreement screen is displayed, read the license agreement packed with this product carefully. Select [Yes] to agree. Select [No] not to agree.



---

### IMPORTANT:

If you do not agree with the license agreement, the Express setup will finish, and Windows server 2003 will not be installed.

---

---

### CHECK:

If a partition already exists on the hard disk, the next message is displayed. If you click [OK], the partition will be deleted and the setup will be continued. If you click [Cancel], the setup will be cancelled.

---

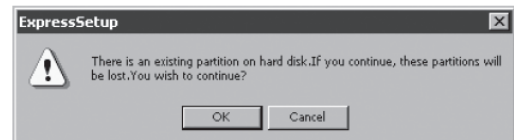

5. When the next message is displayed, to read the parameters file that has been created, insert the Configuration Diskette into the floppy disk drive and select [Yes]. To create a new parameters file, select [No].

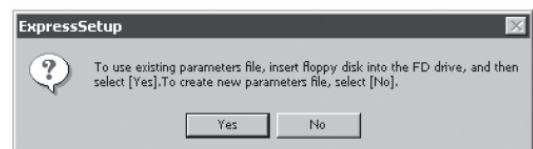

When the OS wizard has been started and [Yes] has been selected, insert the floppy disk, and read and confirm the parameters file.

If you select [No], follow the wizard and enter the parameter.



---

**IMPORTANT:**

- Allocate the partition to install the OS in the size that is bigger than the required minimum size. (See page 4-6.)
  - If you select [Use Existing Partition] in [System Partition], information about the first partition will be formatted and erased all. Information on other partitions will be retained.
  - If an existing hard disk drive partition that has been upgraded to the dynamic disk remains, you cannot reinstall OS (refer to page 4-12). Do not select [Use Existing Partition] in [System Partition].
  - When you select [Use Existing Partition] in [System Partition], if the partition to be reused only exists, reserve the maximum disk space and install Windows Server 2003.
  - When you select [Create All Area] in [System Partition], whole area of the disk installed becomes the C drive. The time for resynchronization in replacing a disk becomes longer depending on the capacity of the C drive. Specify the appropriate partition capacity size according to your environment.
  - You cannot move to the next window, if the settings that you have made are incorrect.
  - Single-byte space cannot be used in creating users and groups. Do not use single-byte space in [User and Group creation].
- 

If you finish entering the parameter, the next window is displayed.

To save the parameters file on the floppy disk, select [Yes] and enter the file name. To save it only on the hard disk, select [No].



---

**CHECK:**

When you are setting [Use Existing Partition] and there is no second partition other than the OS partition on the hard disk drive, the message on the right is displayed.

If you select [Yes], the whole disk space is reserved and the process will be continued. If you select [No], the setup will be cancelled. If you select [Cancel], you can go back to the OS wizard and correct the parameter

---

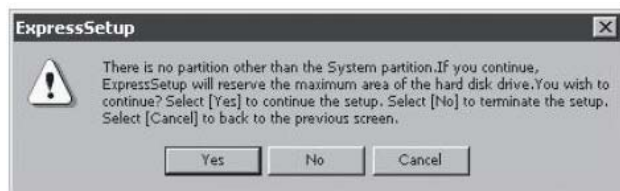

6. If the next message is displayed, insert the Windows Server 2003 R2 CD-ROM (DISC 1) into the DVD-ROM drive, and select [OK].

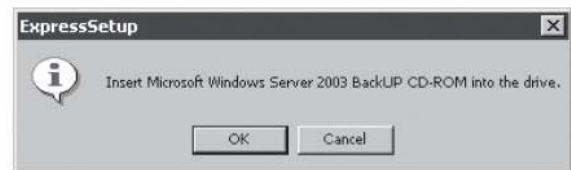

---

**CHECK:**

Depending on the OS media to be used, you may be asked to enter the product key. Enter the product key, and select [Next].

---

The automatic startup has been started. Applications specified as Windows Server 2003 will be automatically installed, and log on to the system.



7. If the [Windows Setup] window is displayed after the installation, insert the Microsoft Windows Server 2003 R2 CD-ROM (DISC 2) into the DVD-ROM drive, and click [OK].

After this, follow the message and continue the installation.

After the installation completes, remove the Microsoft Windows Server 2003 R2 CD-ROM (DISC 2) into the DVD-ROM drive, and restart Fault Tolerant Server series.



## **Step 5: Windows Setup Wizard**

When the immediately preceding operation was “Step 4 Start the Express Setup,” proceed to “Step 6: Windows Server 2003 Service Pack Installation.”

## **Step 6: Windows Server 2003 Service Pack Installation**

### **Installing Windows Server 2003 Service Pack**

Right after the Windows setup, the Windows Server 2003 Service Pack is not applied to the system.

Refer to “Applying Windows Service Pack” on page 5-14, and apply the Windows Server 2003 Service Pack.

---

**IMPORTANT:**

Make sure to apply Windows Server 2003 Service Pack 2. There is no hot fix which can be applied as of the time when this “Rectification Sheet” was released. When the new information on Service Pack or hot fix is released, it will be posted on the web page of PP support service.

---

## Step 7: Set Dual LAN Configuration

The Fault Tolerant Server series builds a dual LAN configuration by using "Intel(R) PRO/1000 MT Dual Port Network Connection" and extended PCI slot "Intel(R) PRO/1000 MT Server Adapter" and "Stratus emb-EB 2-Port Gigabit Adapter" mounted as standard on the CPU/IO module.

---

### Overview

The dual LAN configuration is of two types as described below:

- **Adapter Fault Tolerance (AFT)**

Adapter Fault Tolerance (AFT) is a feature that places more than one LAN controller on the same LAN (same segment), and automatically switches the process of the primary controller to the backup controller when any trouble occurred on the primary.

- **Adaptive Load Balancing (ALB)**

Adaptive Load Balancing (ALB) is a feature that connects more than one LAN controller to the same hub and enhances the throughput by operating packet transmission from the server.

Receive Load Balancing (RLB) is enabled by default. When RLB is enabled, the receiving throughput is enhanced.

The other modes, "Static Link Aggregation" and "IEEE 802.3ad Link Aggregation," do not contribute to enhancement against a fault. When a fault occurs, the communication performed on the controller with the fault is not taken over by the backup controller but lost.

---

## Fault Tolerant Server Series Duplication Rule

Be sure to set the dual configuration in the server.

Also, when you set the duplex configuration, be sure to use one CPU/IO module 0 adapter and one CPU/IO module 1 adapter.

e.g.1) Set the dual configuration with the improved endurance using all the adapters.

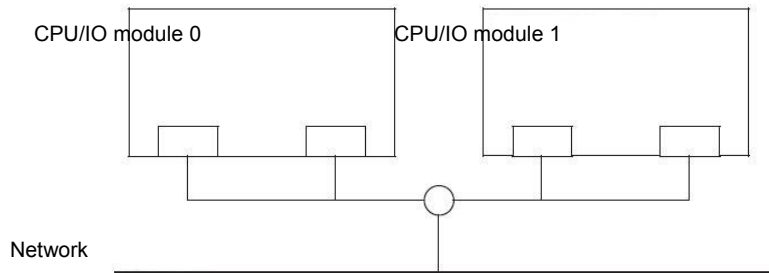

e.g.2) Set the dual configuration for more than one LAN connection

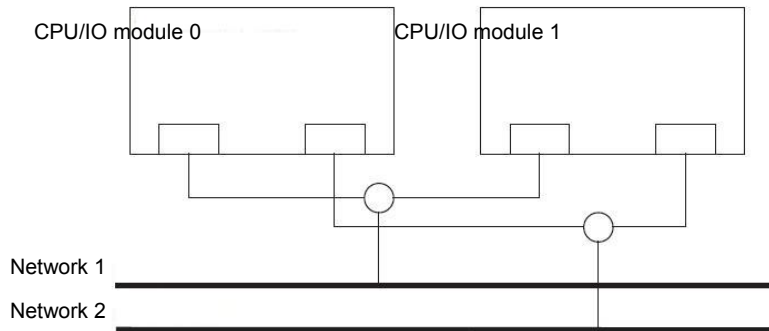

---

## Dual Configuration Setup

The following describes the procedure to set dual LAN configuration.

The procedure to set dual LAN configuration of the example 1 in “Fault Tolerant Server Series Duplication Rule” above is explained.

To set dual LAN configuration, log on as "Administrator" or a member of the group "Administrators.”

1. Start Device Manager.

2. Select one target network adapter, right-click on it and select [Properties] from the displayed menu to display the Properties window.

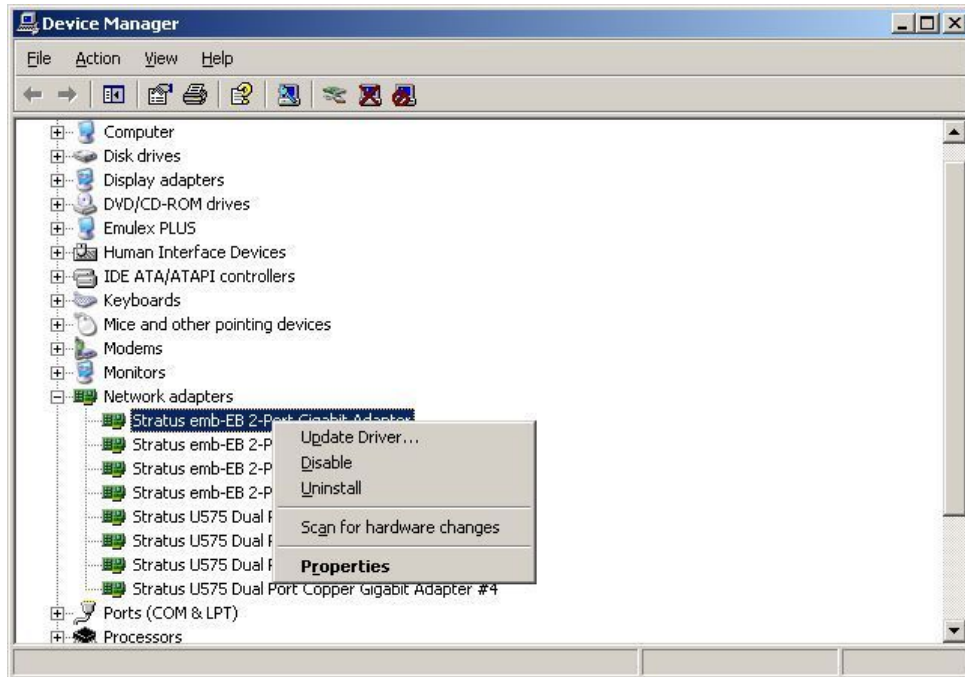

3. Select the [Teaming] tab in the Properties window. Check the radio button of [Team with other adapters] and click [New Team...].

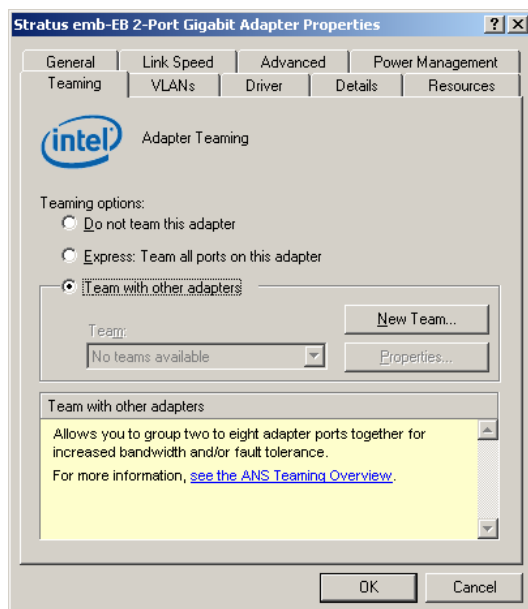

4. Enter the team name, and click [Next >].

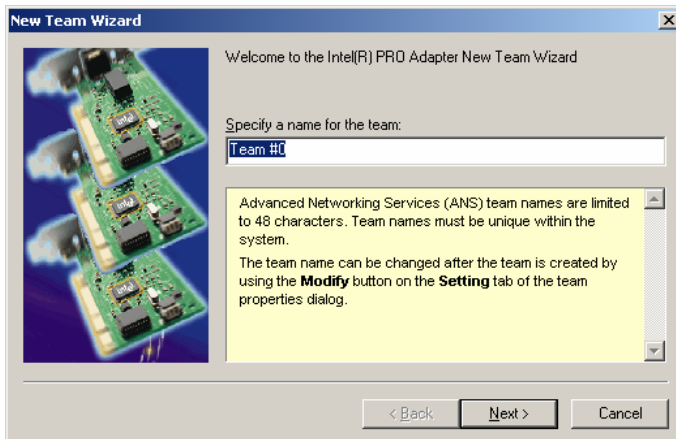

5. Select the check boxes of the adapters you want to include to the team, and click [Next>].

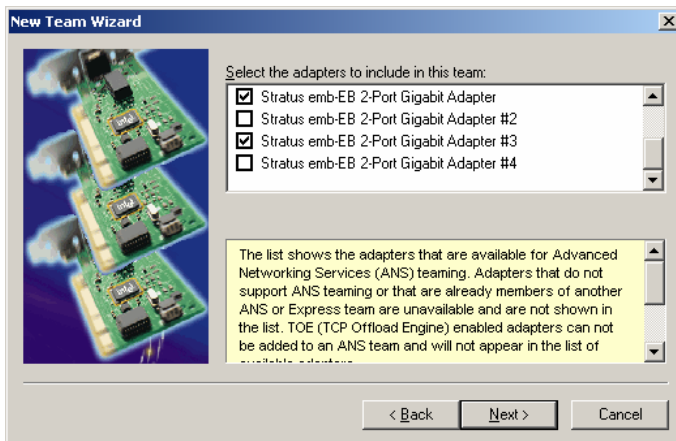

6. Select “Adapter Fault Tolerance” or “Adaptive Load Balancing” as a team mode. (Usually select “Adapter Fault Tolerance.”)

Click [Next >].

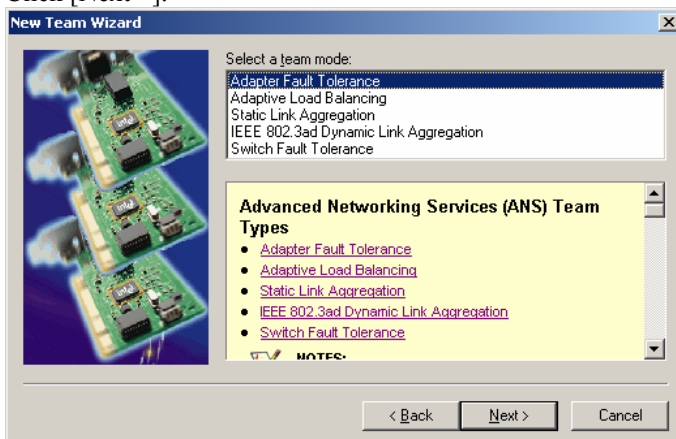

7. Click [Finish].



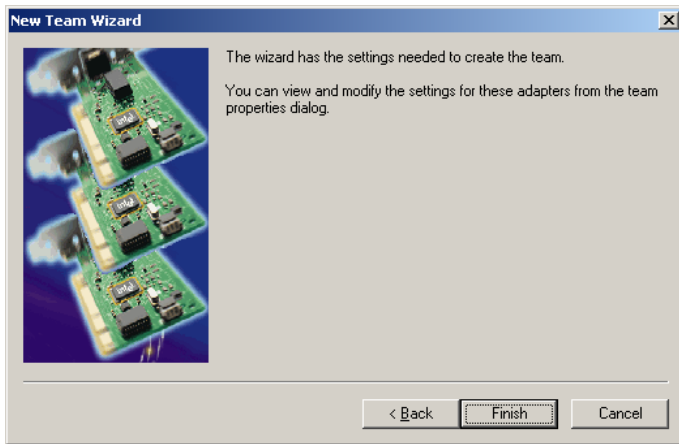

8. Start a command prompt, and confirm the physical MAC address of the team adapter with ipconfig /all.

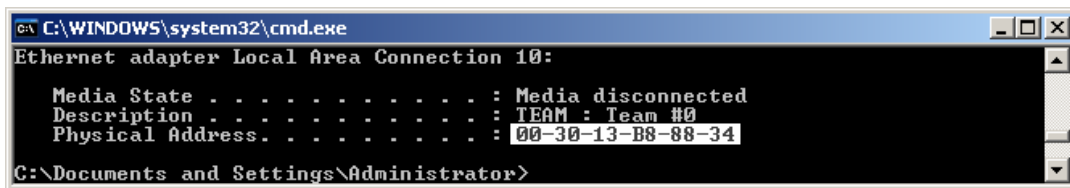

9. Select the team adapter that has been set, right-click on it and select [Properties] from the menu displayed to display the Properties window.

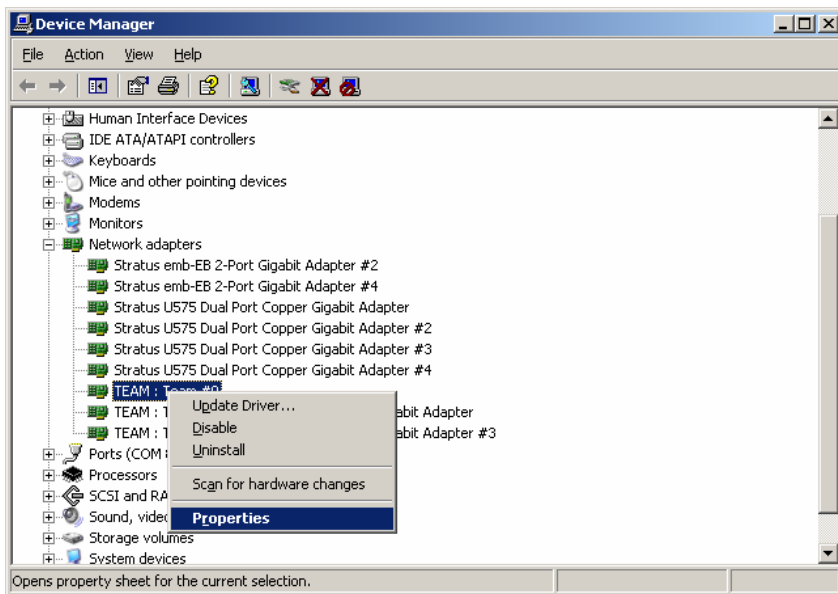

10. Select the [Advanced] tab in the Properties window. Select [Locally Administered Address] from the [Settings] list box, and enter the MAC address of team adapter that you have checked in the [Value:] text box, and click [OK].

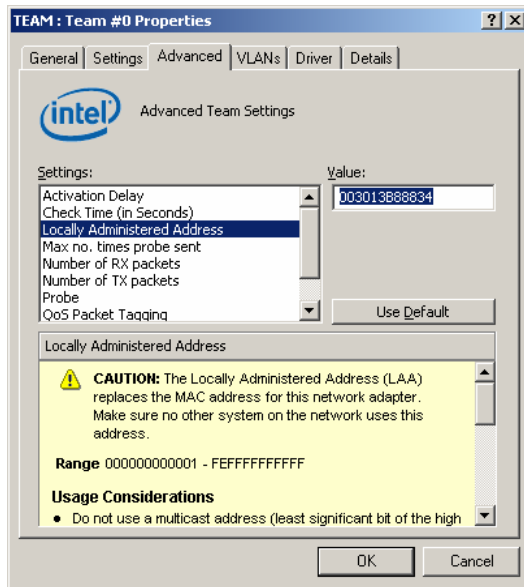

## Step 8: Set Dual Disk Configuration

Fault Tolerant Server series secures data by setting dual disk configuration using “RDR (Rapid Disk Resync) function.” Be sure to make dual disk settings by referring to the procedure.

---

### IMPORTANT:

- Set dual disk configuration by the RDR (Rapid Disk Resync) function. If you want to use other disk management tool (e.g. VERITAS Storage Foundation), install it after “Step 14: Make Settings for Failure Management.” If you perform this operation with a tool other than the RDR (Rapid Disk Resync), a mirror synchronization gap may occur when the system is rebooted.
  - CPU/IO module has a processor function part and IO function part, and monitors and manages each part. The IO function part is referred to as PCI module in this section.
- 

---

## Setting Dual Disk Configuration by RDR (Rapid Disk Resync) function

This device sets dual configuration for each disk by the RDR function of the ft control software.

By setting RDR, as the following figure and table show, dual configuration is set between the disks of the corresponding slots, and these disks are recognized as one virtual disk by Windows (such as Disk Management and Device Manager).

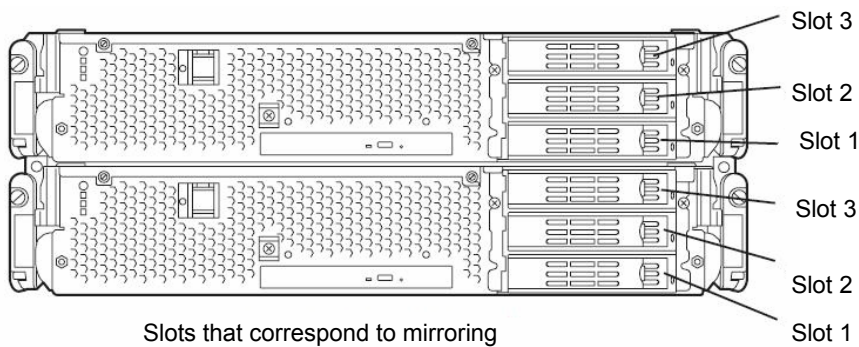

Corresponding slot
PCI module 0 Slot 1 ⇔ PCI module 1 Slot 1
PCI module 0 Slot 2 ⇔ PCI module 1 Slot 2
PCI module 0 Slot 3 ⇔ PCI module 1 Slot 3

- \* In the table above, PCI module names correspond as follows:  
 PCI module (for CPU/IO module 0) - PCI module 0  
 PCI module (for CPU/IO module 1) - PCI module 1

---

**IMPORTANT:**

- To perform this procedure, you need to log on as an administrator or a member of administrator group.
  - RDR can only be set on the basic disk inserted into the built-in slot of Fault Tolerant Server series. It cannot be set on the dynamic disk.
  - For the disk on which RDR is set, use the products with the same serial number.
  - Be sure to configure the RDR settings in the same way not only when the OS is installed but also when the disk is added to the PCI module.
- 

Follow the steps below to configure the dual disk configuration.

1. Click [Start] – [All Programs] – [RDR] – [RDR Utility], to start the RDR Utility.

---

**IMPORTANT:**

If the disk status of the disk (Slot 1 of the PCI module 0) on which the system is installed is “Boot, configured Active or Imported,” performing the steps 2 to 4 are not required. Go to step 5. If the disk status is other than “Boot, configured, Active or Imported,” go on to step 2. To check the “disk status,” click the disk on which the system is installed from the left pane of RDR Utility and check the “disk status” display on the right pane.

---

---

**TIPS:**

- For the details on RDR Utility, see “Disk Operations Using the RDR (Rapid Disk Resync) Function” in “Disk Operations” in Chapter 3, “Windows Setup and Operation.” in the User’s Guide.
  - The RDR Utility display is not updated automatically. Each time you perform disk-related operations such as inserting or removing a disk or RDR setting, click [Action] from the menu and click [Refresh] (or press the **F5** key) to update the display.
  - In RDR Utility, PCI module names correspond as follows:
    - PCI module (for CPU/IO module 0) - PCI module 0
    - PCI module (for CPU/IO module 1) - PCI module 1
-

- Right-click the disk (Slot 1 of PCI module 0) on which the system is installed on the left pane of the [RDR Utility] window, and click [Create RDR Virtual Disk].

**TIPS:**

Depending on the disk status, it takes time to set RDR, and RDR Utility may be stopped for a few minutes. This is not an error. Please wait for a while.

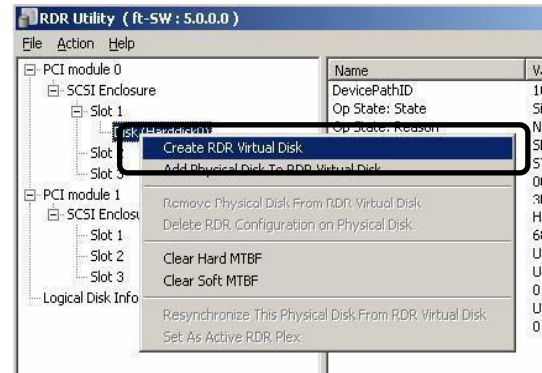

- Click [Yes].



- Click [OK].



**IMPORTANT:**

If you set RDR on the disk that includes a system partition or a partition that cannot be unmounted, the message on the right is displayed. Click [Yes]. The system is restarted after 2 minutes. After it is restarted, perform the steps 5 and later.



- Insert the disk to set dual configuration into the corresponding slot. (In this case Slot 1 of PCI module 1).

**IMPORTANT:**

When a disk is inserted a popup window for asking to reboot the computer may be displayed, but you do not need to reboot it. Click [No] and close the popup window.

As for the disk to be inserted, use a new disk or a physically formatted disk with the same capacity as the synchronization source disk. If you use other disks, dual configuration is not set normally.

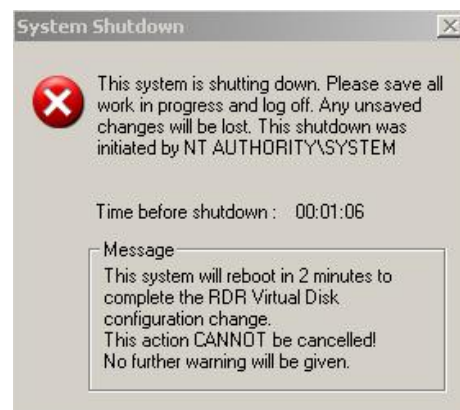

\* As for physical format, refer to “SAS BIOS ~ Adaptec SAS/SATA~ Configuration Utility” in Chapter 4, “System Configuration” in the separate volume of the User’s Guide, and perform Format Disk with Disk Utilities To perform “Low-Level Format,” on the BIOS setup utility, click [Server], [Monitoring Configuration]

and set [Option ROM Scan Monitoring] to [Disabled]. For how to configure the settings, see “System BIOS ~ SETUP ~” in Chapter 4, “System Configuration” in the separate volume of the User’s Guide.

6. Right-click the Slot 1 of the PCI module 1 from the left pane of RDR Utility, and then click [Add Physical Disk To RDR Virtual Disk].

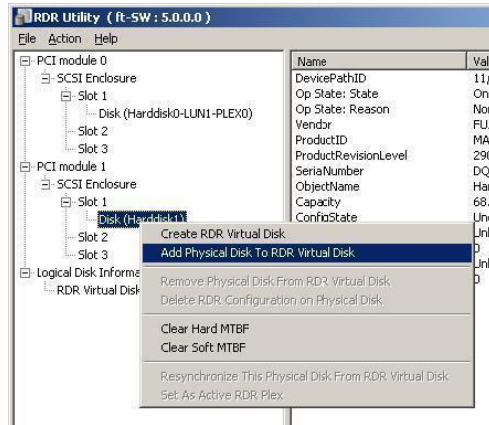

7. Click [OK].



8. Check that disk synchronization has been started and the status of the DISK ACCESS LED and RDR Utility display changes as the following table.

■ During synchronization

	DISK ACCESS LED	RDR Utility	
		Condition	Status
Synchronization source disk	Amber and blinking	Simplex	
Synchronization destination disk	Amber and blinking	Syncing	
RDR Virtual Disk		Simplex	Resync x % (x=0, 10, 20, ..., 90)

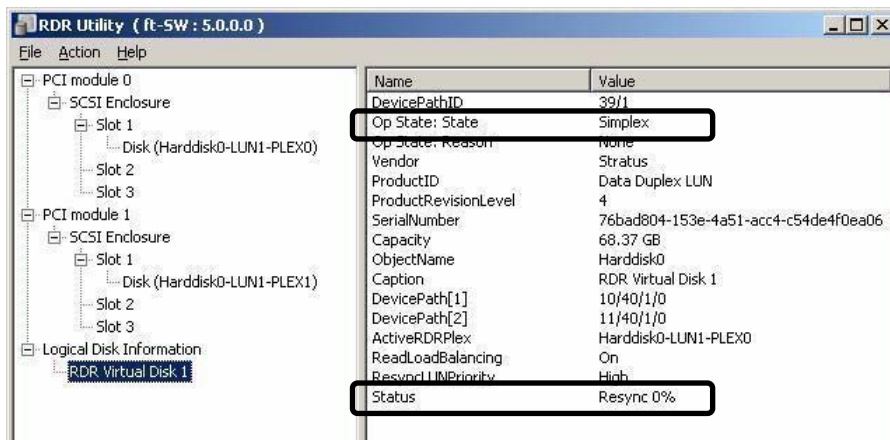



---

**IMPORTANT:**

- The time required for synchronization deffers depending on the size of the partition that exists on the disk. As for the partition with the 18GB capacity, it takes about 16 minutes. If there is no partition, synchronization completes soon after setting RDR is completed and the disk changes to the synchronization completion status.
  - Setting dual disk configuration may not complete if the system is rebooted during synchronization. Do not reboot the system before synchronization process completes.
-

■ Synchronization completed

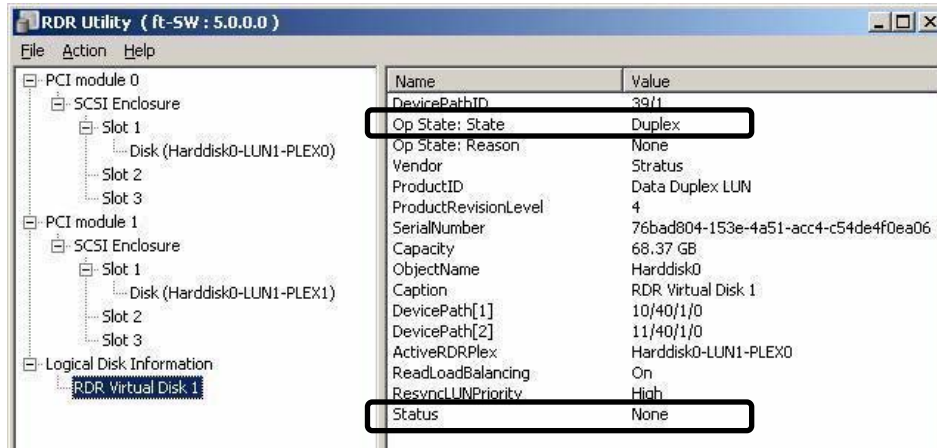
	DISK ACCESS LED	RDR Utility	
		Condition	Status
Synchronization source disk	Green and blinking	Duplex	
Synchronization destination disk	Green and blinking	Duplex	
RDR Virtual Disk		Duplex	None



**IMPORTANT:**

- If you have created a new partition on the disk where RDR has been set and which is duplexed, the created partition area is automatically synchronized.
- If you have changed a disk where RDR has been set and which is duplexed to a dynamic disk, the whole area (where no partition exists) that is not synchronized at this time will be synchronized.
- If the system is not stopped without terminating Windows normally (such as by pressing the power button), the whole disk area synchronized will be resynchronized after the system is rebooted.



## **Step 9: Update Software**

If you use ftServer Control Software UPDATE CD-ROM, see “Installing ftServer Control Software” (page 6-12) to update the software. When there are other update modules, apply them in this step.

## Step 10: Connect and Configure Options

When there are optional PCI boards or peripheral devices to connect to the main unit, power off the main unit. Then, for connecting them, follow the instructions in “PCI board” in the separate volume of the User’s Guide and the manual of the devices.

When the mounted memory is 4GB or more, specify /PAE switch to BOOT.INI file.

In order to use the entire mounted memory from the Windows system, /PAE switch needs to be specified. If it is not specified, the Windows system only uses a part of the mounted memory.

Refer to Microsoft Product Support Services for details of specification method.

BOOT.INI file exist on C:\. It is displayed by clicking [Folder Options] – [View] in Explorer and choosing [Show hidden files and folders] option.

Below shows the example of the modification.

### (Before modification)

```
[boot loader]
timeout=30
default=multi(0)disk(0)rdisk(0)partition(1)\WINNT
[operating systems]
multi(0)disk(0)rdisk(0)partition(1)\WINNT="Windows Server 2003, Enterprise" /fastdetect
```

### (After modification)

```
[boot loader]
timeout=30
default=multi(0)disk(0)rdisk(0)partition(1)\WINNT
[operating systems]
multi(0)disk(0)rdisk(0)partition(1)\WINNT="Windows Server 2003, Enterprise" /fastdetect /PAE
```

Make dual configuration when you added LAN and disks. For details, see “Step 7 Set Dual LAN Configuration” on page 4-19 and “Step 8 Set Dual Disk Configuration” on page 4-25.

## Step 11: Create Volume

For Fault Tolerant Server series, you need to perform mirroring for each disk by the RDR function. If you created a new partition or volume on the disk that has been set RDR and dual configuration, the area is mirrored automatically. You do not need to perform mirroring for each partition or volume. For more details about performing mirroring by the RDR function, see “Setting Dual Disk Configuration by RDR (Rapid Disk Resync) function” in “Step 8: Set Dual Disk Configuration.”

---

**TIPS:**

- To create a partition or volume, refer to the Windows online help.
  - You can create a partition or volume even after the operation has been started.
-

## Step 12: Set Network for NEC ESMPRO Agent

NEC ESMPRO Agent is required for continuous operation of the Fault Tolerant Server series. It is automatically installed when you install the OS.

To operate NEC ESMPRO Agent, you need to set the SNMP.

### To change the settings of the SNMP Service:

1. Double-click [Administrative Tools] in [Control Panel].
2. Open [Services] in [Administrative Tools].
3. Select [SNMP Service] from the service list and then [Properties] in the [Action] menu.

The “SNMP Properties” dialog box appears.

4. Enter “public” in the [Community name] box in the [Traps] property sheet and click the [Add to list] button.

---

#### IMPORTANT:

- If you changed the community name of traps to be received from the default “\*” in the NEC ESMPRO Manager site, enter the same name as the community name newly set in the NEC ESMPRO Manager site.
  - To receive trap from NEC ESMPRO Agent at the NEC ESMPRO Manager machine, both community names should be the same.
- 

5. Click the [Add...] button in [Trap destinations]. After entering the IP address of the NEC ESMPRO Manager machine of the send destination in the [Host name, IP or IPX address] box, click the [Add] button.

---

**IMPORTANT:** If the IP address (or host name) of the remote NEC ESMPRO Manager is specified as the trap send destination in the setup of the manager report (TCP/IP), the message warning the duplication appears. The specification of the same NEC ESMPRO Manager causes to be reported doubly.

---

6. Open the [Security] property sheet and make settings as follows:
  - Add the community name entered in 4 to [Accepted community names].
  - Set its authority to [READ CREATE] or [READ WRITE].
  - Select [Accept SNMP packets from any host].

---

#### IMPORTANT:

- If you entered any community name other than “public” in 4, add that name to “Accepted community names.”
  - Unless you set the acceptable community’s authority to “READ CREATE” or “READ WRITE,” you cannot perform monitoring from NEC ESMPRO Manager.
- 

#### < Setup of receiving SNMP packets from specific hosts only >

Select [Accept SNMP packets from these hosts], specify IP addresses of the hosts, IP addresses of the servers to install Agent, and the loop-back address (127.0.0.1).

#### < Setup of receiving SNMP packets from specific communities only >

Change the name of the community receiving SNMP packets from the default “public” to any name.

---

#### IMPORTANT:

- If the community name is changed, you need to register the change made to the community of NEC ESMPRO Agent from [Control Panel]. To change the community to another and register it, use the [SNMP Community] list box in the [General] tab.
  - To allow NEC ESMPRO Agent to receive SNMP packets sent from NEC ESMPRO Manager, set the send community name in NEC ESMPRO Manager to be the same as that accepted by the SNMP Service in NEC ESMPRO Agent.
-

7. Terminate the network setup.

---

**IMPORTANT:**

- If the SNMP service was added to the system after the service pack had been applied at OS installation, apply it again. If not, the SNMP service may not operate properly. This can cause the improper operation of NEC ESMPRO Agent.
  - The SNMP Service is required for operating NEC ESMPRO Agent. If the SNMP Service is deleted after the installation of NEC ESMPRO Agent, install the SNMP Service and then reinstall NEC ESMPRO Agent.
  - Some software products provided by other vendors use the SNMP Service. If the SNMP Service and NEC ESMPRO Agent are installed in the system in which such software as above is installed, it may be impossible to start NEC ESMPRO Agent services. If so, delete the SNMP Service once and install the service again. Then, reinstall NEC ESMPRO Agent and the other vendor's software.
-

## Step 13: Enable OS Boot Monitoring Function

When necessary for system operation, enable the “OS Boot Monitoring” setting which has been disabled in “Step 3: Disable OS Boot Monitoring Function” (page 4-8). Or, see “Step 3: Disable OS Boot Monitoring Function” (page 4-8) and set appropriate time (default is 10 min.).

ftServer Setup					
Main	Advanced	Security	Server	Boot	Exit
Monitoring Configuration		Item Specific Help			
FRB-2 Timer	[Enabled]	Disables/enables the FRB-2 Timer.			
PCI Enumeration Monitoring:	[Enabled]				
PCI Enumeration Monitoring Timeout:	[ 180]				
Option ROM Scan Monitoring:	[Enabled]				
Option ROM Scan Monitoring Timeout:	[ 300]				
OS Boot Monitoring:	<b>[Enabled]</b>				
OS Boot Monitoring Timeout:	[ 600]				
POST Pause Monitoring:	[Enabled]				
POST Pause Monitoring Time-out	[ 180]				
F1 Help    ↑↓ Select Item    -/+ Change Values    F9 Setup Defaults Esc Exit   ←→ Select Menu   Enter Select   ► Sub Menu   F10 Save and Exit					

## Step 14: Make Settings for Failure Management

Make the following settings beforehand to ensure quick recovery from failure.

---

### Set Memory Dump (Debug Information)

This section explains the setting for collecting memory dump (debug information) in the server.

---

**IMPORTANT:** Notes on memory dump

- The maintenance personnel designated by your sales agent are responsible for collecting memory dump. Customers should make settings of memory dump only.
  - Sometimes a message indicating a shortage of virtual memory appears at the system startup, when a failure has occurred after making settings described here and you have restarted the system to save the memory dump. Continue the startup. If you restart the system, you may not be able to collect the memory dump accurately.
  - If an error such as a stop error of the OS occurs, the normal dump function may run instead of the quick dump function depending on the system status. However, the memory dump file can be used for failure analysis equivalent to that of the quick dump function.
- 

Take the following steps to set memory dump:

1. From the [Start] menu, select [Control Panel] and then click [System].  
The [System Properties] dialog box appears.
2. Click the [Advanced] tab.
3. Click [Settings] in the [Startup and Recovery] box.

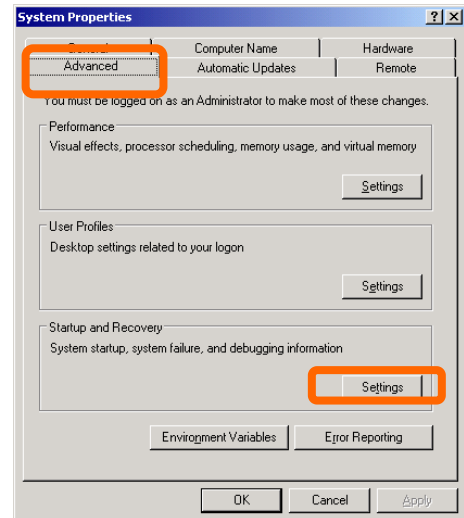

4. Enter the location, where debug information is to be written, in the text box.

When writing debug information under the file name "MEMORY.DMP" in the D drive:

D:\MEMORY.DMP

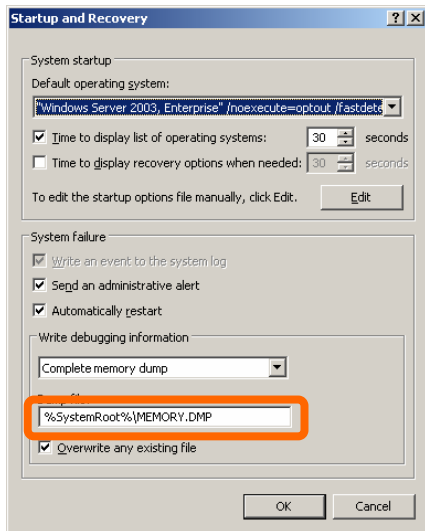

---

#### IMPORTANT:

- [Complete memory dump] should be specified for writing debug information. However, if the mounted memory size is over 2GB, specify [Kernel Memory Dump]; you cannot specify [Complete memory dump] ([Complete memory dump] is not displayed on the menu).
  - Specify a drive which has a free space of the size of memory in the Fault Tolerant Server series + 12MB or more (If the memory size is over 2GB, 2048MB + 12MB).
  - If the memory will be expanded to larger than 2 GB, change Write Debugging Information to [Kernel Memory Dump] before expanding the memory. Size of the debugging information (memory dump) to be collected will change due to memory increase. Check how much free space the hard disk to which debugging information is written has.
  - If an error such as a stop error of the OS occurs, the normal dump function may run instead of the quick dump function depending on the system status. However, the memory dump file can be used for failure analysis equivalent to that of the quick dump function
  - In the system failure settings, it is recommended to specify “Automatically restart.” When this option is not selected, the system cannot be restarted after the operation is switched to the disks that are mirrored when the system cannot be started due to a disk error.
-



5. Click [Settings] in the [Performance] box.

The [Performance Options] window appears.

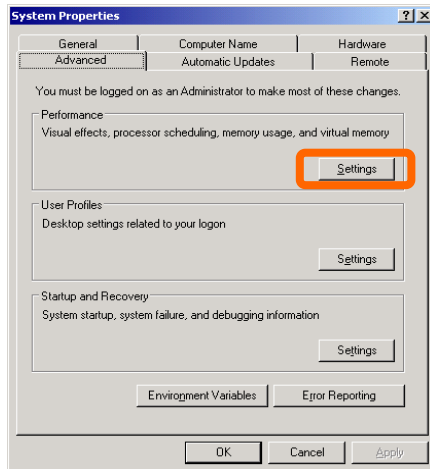

6. Click the [Advanced] tab on the [Performance Options] window.

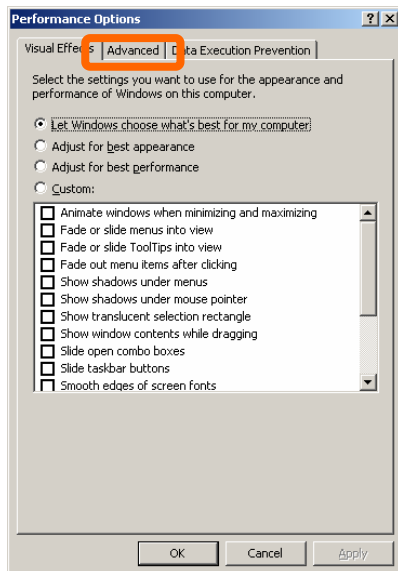

7. Click [Change] in the [Virtual memory] box.

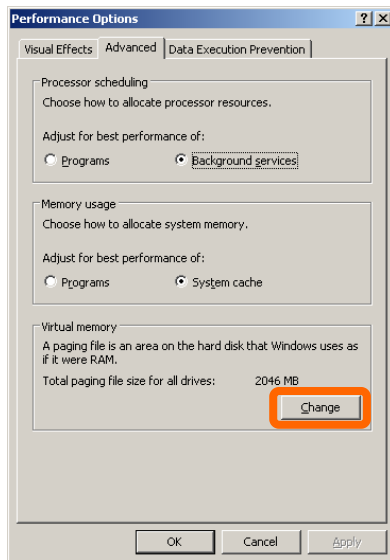

8. Change the value set for [Initial Size] in the [Paging file size for selected drive] box to the [Recommended] value or more, and then click [Set].

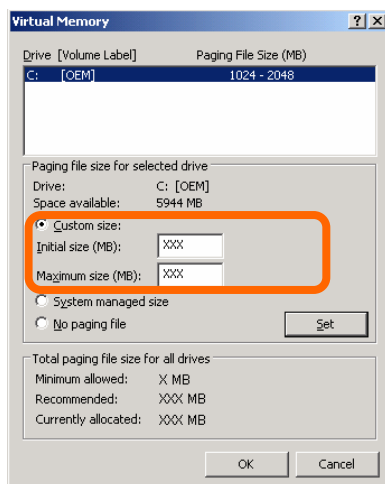

---

### IMPORTANT:

- Be sure to create the file in the size more than [Recommended] value in the OS partition. If a value smaller than the [Recommended] value is set for [Initial Size] of the paging file, accurate debug information (memory dump) may not be collected.
  - For the [Recommended] value, see "Size of the Partition to be Created" (page 4-5).
  - To be prepared for failure, it is recommended to press the dump button to see if the memory dump can be collected normally beforehand.
  - If the memory has been expanded, re-set the paging file according to the memory size.
- 

9. Click [OK].

A message is displayed asking you to restart the system depending on the changed settings. Restart the system according to the messages.

## Set Dr. Watson

Dr. Watson of Windows Server 2003 is a debugger for application errors. When detecting an application error, Dr. Watson diagnoses the Fault Tolerant Server series, and records the diagnostic information (log). Take the following steps to collect diagnostic information:

1. Click [Run...] from [Start].
2. Enter "drwtsn32.exe" in the [Open] box, and click [OK].

The [Dr. Watson for Windows] dialog box appears.

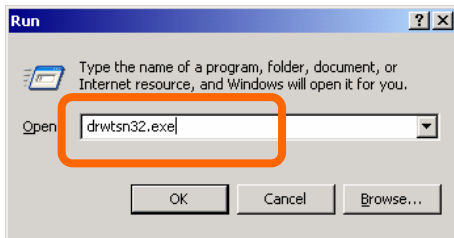

3. Specify where you want to save diagnostic information in the [Log File Path] box.

Diagnostic information is saved under the file name "DRWTSN32.LOG."

---

**CHECK:** Do not specify a network path. Be sure to specify a path on the local computer.

---

4. Specify the crash dump file save destination in the [Crash Dump] box.

---

**TIPS:** A "crash dump file" is a binary file that can be read by Windows Debugger.

---

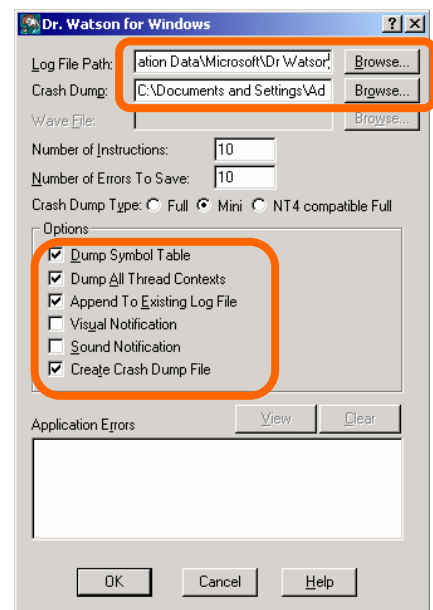

5. Select the following check boxes in the [Options] box.

- [Dump Symbol Table]
- [Dump All Thread Contexts]
- [Append To Existing Log File]
- [Create Crash Dump File]

For the above functions, see the online help.

6. Click [OK].

---

## Install a Network Monitor

A network monitor is useful for examining the causes of network failures and taking the countermeasures. To use the network monitor, you need to restart the system after the installation. It is recommended to install the network monitor before a failure occurs.

1. From the [Start] menu, select [Control Panel] and click [Add/Remove Windows Programs].

The [Add/Remove Windows Programs] dialog box appears.

2. Click [Add/Remove Windows Components].

The [Windows Components Wizard] dialog box appears.

3. Select the [Management and Monitoring Tools] on [Components] and click [Details...] at the bottom right of the window. [Management and Monitoring Tools] appears.

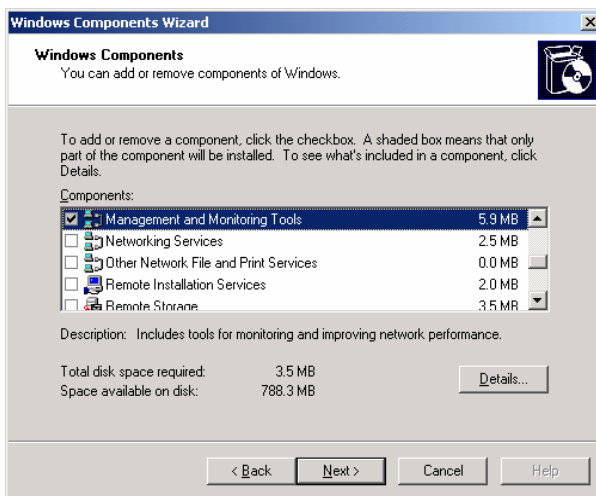

4. Check the [Network Monitor Tools] check box on the [Subcomponents of Management Monitoring Tools] dialog box and click [OK] at the bottom of the window.

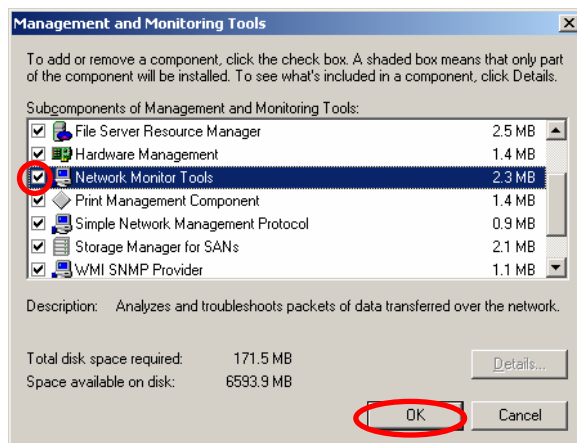

5. Click [Next].
6. If a message is displayed asking you to insert "Windows Server 2003 R2A Enterprise Edition CD-ROM," follow the instructions on the screen.

Close the menu that appears by inserting the CD-ROM. To close the menu, click the [X] mark on the menu.

7. Click [Finish] in the [Windows Components Wizard] dialog box.
8. Click the [X] mark on the [Add or Remove Programs] dialog box.

You can also activate the network monitor by clicking [Start], pointing to [All Programs], pointing to [Administrative Tools] and then clicking [Network Monitor]. For details on the operation, see the online help.

---

## Set Recovery Console

---

**TIPS:**

Recovery console is used for repairing the system when the system cannot be started for some reason.

---

There are cautions to be taken for using the Recovery console. Refer to “Cautions for using the Windows Server 2003 Recovery Console” of “SYSTEM REPAIR” in Chapter 6 “Troubleshooting” in the User’s Guide (Setup).

## Step 15: Back up System Information

After setting up the system, back up the system information using the Off-line Maintenance Utility.

Without backup for system information, the information and settings that are specific to your server cannot be restored after the server is repaired. Take the following steps to make a backup copy of the system information:

1. Prepare a 3.5-inch floppy disk.
2. Insert the "EXPRESSBUILDER" CD-ROM into the DVD-ROM drive of the server, and restart the system.  
EXPRESSBUILDER is activated and [EXPRESSBUILDER Top Menu] is displayed.
3. Select [Off-line Maintenance Utility] from [Tools].
4. Select [Save] from [System Information Management].

Follow the instructions you see on the screen.

The setup is now completed.

# Chapter 5

---

## Procedures after Completion of Installation

This chapter describes how you install management utilities, how you back up system information, and setup of PCs on the network. You may need to confirm these procedures while the system is running.

## INSTALLING MANAGEMENT UTILITIES

The provided "EXPRESSBUILDER" CD-ROM contains "NEC ESMPRO Agent" for monitoring Fault Tolerant Server series and "NEC ESMPRO Manager" for managing the Fault Tolerant Server series. Install and setup these utilities in the Fault Tolerant Server series or the computer (management PC) that manages the Fault Tolerant Server series.

---

### System Update

Perform system update in the following cases:

- When the system configuration is changed
- When the system is restored
- When the system is restored from the backup media

---

**TIPS:**

Use the Windows Server 2003 CD-ROM that includes ServicePack1 to install this server (320Fc-MR).

---

Log on to the system with the account that has administrator rights (such as Administrator) and insert the "EXPRESSBUILDER" CD-ROM into the DVD-ROM drive.

The [Master Control Menu] is displayed. Click [Setup] and click [UPDATING THE SYSTEM] from the menu to start the system update. Follow the messages displayed on the screen to continue the process.

After you have updated the system, you need to reinstall ft Server Control Software. Refer to "Installing ft Server Control Software" on page 6-12 to reinstall it.



---

## NEC ESMPRO Agent

NEC ESMPRO Agent is automatically installed by executing the “Fault Tolerant Server series setup program.”

Click [Start] then [All Programs], and make sure that the installed utility folder exists. If it has not been installed while setting up the Fault Tolerant Server series, install it separately.

---

### IMPORTANT:

Make sure that NEC ESMPRO Agent is installed because it is indispensable for continuous operation of Fault Tolerant Server series.

---

To set details about NEC ESMPRO Agent, double-click the [NEC ESMPRO Agent] icon in the [Control Panel] dialog box. The properties dialog box appears for changing the settings.

For details on the set items, see the online help displayed by clicking on [Help].

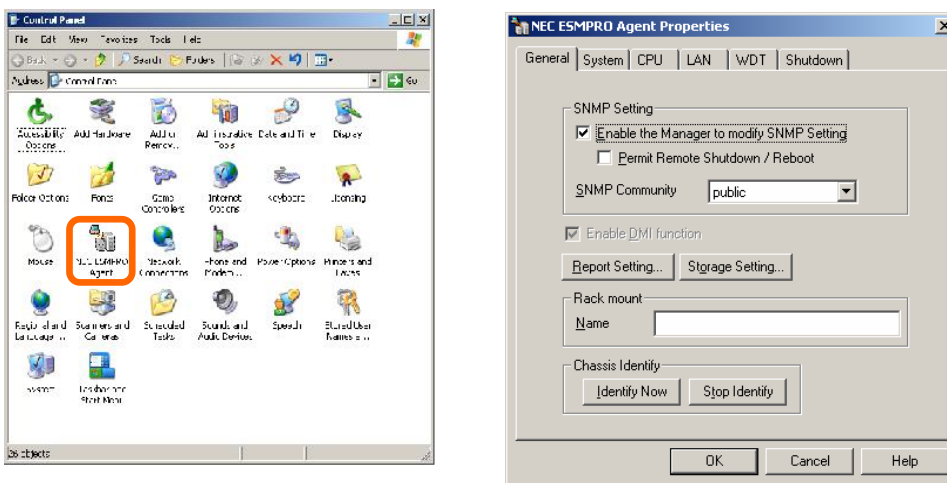

## Operation Environment

NEC ESMPRO Agent can be operated in the hardware and software environments shown below.

- **Hardware**
  - Installation system                      Fault Tolerant Server series
  - Memory                                      Memory capacity required to operate OS + 25.0 MB or larger
  - Empty capacity of hard disk      50.0 MB or larger
- **Software**      Windows Server 2003 SP1

## Preparation before Setup

Be sure to read the following description before system installation or setup.

To operate NEC ESMPRO Agent, you need to make settings of TCP/IP and the SNMP of components associated with TCP/IP.

## TCP/IP Setting

See the Help started from the Start menu for how to set TCP/IP.

## SNMP Service Setting

### To install the SNMP Service:

1. Open [Add/Remove Programs] in [Control Panel].
2. Click [Add/Remove Windows Components].
3. Select [Management and Monitoring Tools] in the Windows component wizard and click the [Details...] button.
4. Check the check box of [Simple Network Management Protocol].
5. Click the [Next] button.  
The file copy operation is started.
6. After the file copy is finished, click the [Finish] button.

### To change the settings of the SNMP Service:

1. Double-click [Administrative Tool] in [Control Panel].
2. Start [Services] in [Administrative Tool].
3. Select [SNMP Service] from the service list and then [Properties] in the [Action] menu.  
The "SNMP Properties" dialog box appears.
4. Enter "public" in the [Community name] box in the [Traps] property sheet and click the [Add to list] button.

---

**IMPORTANT:**

- To change the community name of traps to be received from the default "\*" in the NEC ESMPRO Manager site, enter the same name as the community name newly set in the NEC ESMPRO Manager site.
  - To receive trap from NEC ESMPRO Agent at the NEC ESMPRO Manager machine, both community names should be the same.
- 

5. Click the [Add...] button in [Trap destinations]. After entering the IP address of the NEC ESMPRO Manager machine of the send destination in the [Host name, IP or IPX address] box, click the [Add] button.

---

**IMPORTANT:**

If the IP address (or host name) of the remote NEC ESMPRO Manager specified as the trap send destination in the setup of the manager report (TCP/IP), the message warning the duplication appears. The specification of the same NEC ESMPRO Manager causes to be reported doubly.

---

6. Open the [Security] property sheet and make settings as follows;
  - Add the community name entered in Step 4 to [Accepted community names].
  - Set its authority to [READ CREATE] or [READ WRITE].
  - Select [Accept SNMP packets from any host.]

---

**IMPORTANT:**

- If you entered any community name other than "public" in Step 4, add that name to "Accepted community names."

- Unless you set the acceptable community's authority to "READ CREATE" or "READ WRITE," you cannot perform monitoring from NEC ESMPRO Manager.
- 

< **Setup of receiving SNMP packets from specific hosts only** >

Select [Accept SNMP packets from these hosts], specify IP addresses of the hosts, IP addresses of the servers to install Agent, and the loop-back address (127.0.0.1).

< **Setup of receiving SNMP packets from specific communities only** >

Change the name of the community receiving SNMP packets from the default "public" to any name.

---

**IMPORTANT:**

- If the community name is changed, the community of NEC ESMPRO Agent is changed and registered by starting from [Control Panel]. To change the community to another and register it, use the [SNMP Community] list box in the [General] tab.
  - To allow NEC ESMPRO Agent to receive SNMP packets sent from NEC ESMPRO Manager, set the send community name in NEC ESMPRO Manager to be the same as that accepted by the SNMP Service in NEC ESMPRO Agent.
- 

7. Terminate the network setup.

---

**IMPORTANT:**

- During OS installation, if the SNMP service is added to the system after applying the service package during OS installation, apply it again. If not, the SNMP service may not operate properly, and this can cause the improper operation of NEC ESMPRO Agent.
  - The SNMP Service is required for operating NEC ESMPRO Agent. If the SNMP Service is deleted after the installation of NEC ESMPRO Agent, install the SNMP Service and then reinstall NEC ESMPRO Agent.
  - Some software products provided by other vendors use the SNMP Service. If the SNMP Service and NEC ESMPRO Agent are installed in the system in which such software as above is installed, it may be impossible to start NEC ESMPRO Agent services. If so, delete the SNMP Service once and install the service again. After which, reinstall NEC ESMPRO Agent and the other vendor's software.
- 

## Installation

NEC ESMPRO Agent is automatically installed together with the installation or re-installation of the Fault Tolerant Server series. NEC ESMPRO Agent may be installed manually on the master control menu of EXPRESSBUILDER as follows:

1. Login to the system with user name "Administrator."
2. Insert CD-ROM "EXPRESSBUILDER" into the DVD-ROM drive.

---

**TIPS:**

The DVD-ROM drive may be either the drive connected to the system or any drive located on the network and connected by the LAN Manager. (These are collectively called DVD-ROM drive hereafter).

---

**IMPORTANT:**

To use a DVD-ROM drive on the network, assign the network driver to the drive and then execute MC\1ST.EXE of the drive. Do not start the DVD-ROM drive from the network computer in Windows Explorer.

---

The autorun function automatically displays the master control menu of EXPRESSBUILDER.

3. Click [NEC ESMPRO] in [Setup].

The NEC ESMPRO setup is started to display the main menu.

- Click [Agent] in the main menu of the NEC ESMPRO setup.



---

**TIPS:**

The available menus vary depending on OS types. (The menus that cannot be installed are displayed gray.)

---

**IMPORTANT:**

- Double-clicking to select a menu may display two same dialog boxes. Click the [End] button to close one of the dialog boxes.
  - If you click the [Cancel] button during setup, the message asking whether to stop or not to stop the installation will appear. You can stop the installation by clicking on the [Stop] button (the main menu remains displayed). However, the file having been setup halfway will not be deleted.
  - When NEC ESMPRO Agent is already installed, delete its older version from [Add or Remove Programs] in Control Panel, and install the new version.
- 

- The setup program determines the machine type automatically.

---

**IMPORTANT:**

If the setup program is unable to determine the machine model, the setup of NEC ESMPRO Agent will be stopped.

---

- Click the [Next] button.

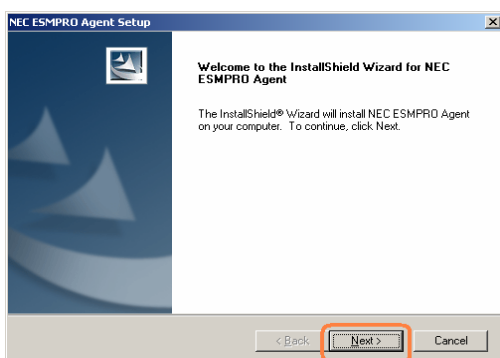

- Enter the path in which NEC ESMPRO Agent is installed and click the [Next] button.

The NEC ESMPRO Agent module is installed below the ESM directory of the root partition in default. If no problem is found, click the [Next] button without any modification.

To change the installation directory, click the [Reference] button, specify the desired installation directory with the full path including the drive name, and click the [Next] button.

- When the installation end window appears, click the [OK] button.

The installed is complete. The functions of installed NEC ESMPRO Agent will be enabled after the system is restarted.

---

**IMPORTANT:**

- After the installation of NEC ESMPRO Agent, SNMP Service is stopped. The SNMP Services will be started when the OS is restarted.
  - Even if the installation of NEC ESMPRO is completed, the main menu for the NEC ESMPRO setup remains displayed. Note that the main menu may be hidden by another dialog box. To terminate the NEC ESMPRO setup, click [End] in the main menu.
- 

**Setup of NEC ESMPRO Agent**

The settings of installed NEC ESMPRO Agent remain unchanged from those at shipment. Click the [Start] button, [Setting], and [Control Panel] sequentially to open [Control Panel].

If you double-click the [NEC ESMPRO Agent] icon in [Control Panel], the property dialog box will appear. Modify the setting of each sheet in the dialog box to be fit to the used environment. The notes on setup and the necessary information are explained in “Supplement” in Chapter 5 of User’s Guide in the separate volume. See the supplement for setup or suspicion of malfunction.

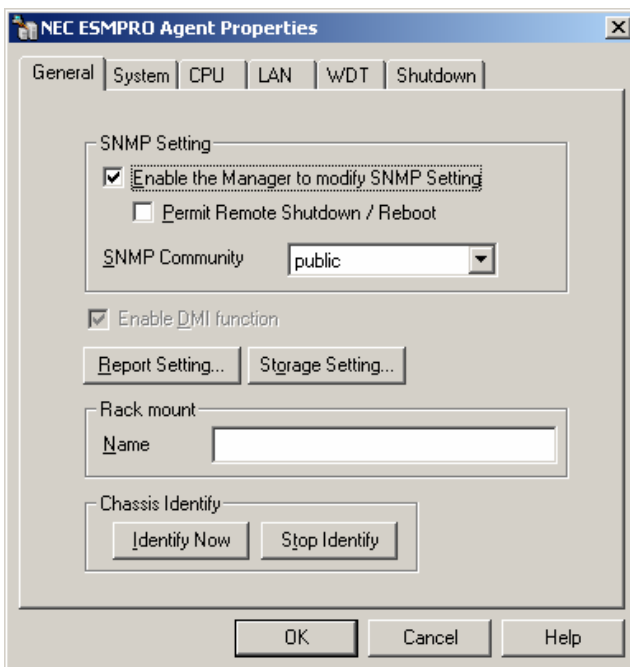

## Uninstall

The uninstallation of NEC ESMPRO Agent is described below.

### Uninstallation of NEC ESMPRO Agent

The procedure of uninstalling NEC ESMPRO Agent is described below.

---

**IMPORTANT:**

Uninstallation of NEC ESMPRO Agent

- Start the uninstallation of NEC ESMPRO Agent after the system is started completely.
  - If NEC ESMPRO Agent is uninstalled just after the system startup, the setup program may freeze displaying the [Service Being Deleted...] dialog box. Shutdown the system by using "Task Manager" or other operation. Then uninstall NEC ESMPRO Agent after the system is started completely.
  - In the system that operates Windows Server 2003, do not change the setting of "Local security policy" from the default.  
The error occurs by InstallShield if the uninstallation is executed with the setting changed, and the uninstallation fails.
- 

- With using EXPRESSBUILDER:
  1. Make the main menu of the NEC ESMPRO setup appear by referring to the section "Install" in this document.
  2. Click [NEC ESMPRO Agent].  
The "Welcome" dialog box appears.
  3. Select [Delete] and then click the [Next] button.  
Now NEC ESMPRO Agent is uninstalled.
- Without using EXPRESSBUILDER:
  1. Start [Add/Remove Programs] in [Control Panel].
  2. Select [NEC ESMPRO Agent] and click [Change/Remove].  
The "Welcome" dialog box appears.
  3. Select [Remove] and click [Next].  
Now NEC ESMPRO Agent is uninstalled.

---

## NEC ESMPRO Manager

Linked with NEC ESMPRO Agent installed in the server, NEC ESMPRO Manager monitors the server status and receives alerts from the server.

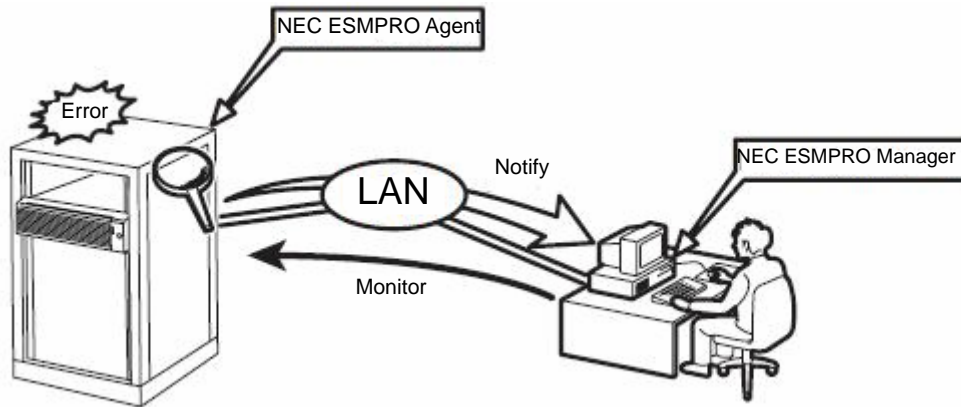

When a failing module in the server is to be replaced, NEC ESMPRO Manager enables logical module disconnection from the server and logical installation after module replacement.

For the installation of NEC ESMPRO Manager and notes on the operation, see the separate volume of the User's Guide.

## CONFIRMATION OF THE ft Server Control Software VERSION

The following describes how to check the version of ft Server Control Software, which consists of various types of software for fault tolerance. Perform the procedure when you need to check the ft Server Control Software version of the current system before adding units or attachment to Fault Tolerant Server series.

Confirm the version following the steps below:

1. Log in the system as an authorized Administrator.
2. Open Control Panel from the Start menu.
3. Open "Add or Remove Programs."

You can confirm the version that corresponds to the name of [ft Server Control Software].

## APPLYING Windows Service Pack

---

### Notes to apply the Windows Service Pack

You should not apply service packs other than those listed in “Step 1; Things Required for Setup” of Chapter 4 “WINDOWS SETUP” (page 4-4) in User’s Guide (Setup) on Fault Tolerant Server series by yourself.

When applying Service Pack, also apply appropriate Microsoft’s HotFix.

---

#### IMPORTANT:

- If you want to apply Service Packs other than ones listed in “Step 1; Things Required for Setup” of Chapter 4 “WINDOWS SETUP” (page 4-4) in User’s Guide (Setup), ask your sales agent about the application status of the Service Packs, and apply them to Fault Tolerant Server series.
  - The Service Pack applied to Fault Tolerant Server series is the same as the standard Windows Server 2003 Service Pack.
- 

---

### Applying Windows Service Pack

Follow the procedure below to apply Service Packs to Fault Tolerant Server series.

Service Packs will not be installed automatically to Fault Tolerant Server series during “ft series Setup” or “Updating the system” to repair the system.

If Server Packs need to be applied, follow the procedure below.

If you want to apply Service Packs other than the ones listed in “Step 1: Things Required for Setup” of Chapter 4 “WINDOWS SETUP” (page 4-4) in User’s Guide (Setup), as your sales agent about the application status of the Service Packs and apply them by following the procedure below:

### How to apply the Windows Service Pack

---

#### IMPORTANT:

When Windows Service Pack is applied, considerations on settings of Power and Screen Saver are required.

If the following settings are enabled when applying Windows Service Pack, the process may stop or Windows Service Pack may not be applied properly. Disable the settings by clearing the checkboxes before applying Windows Service Pack. Reconfigure the following settings as necessary afterwards.

- Settings of Screen Saver
  - Power Schemes (Turn off monitor, Turn off hard disks)
  - Hibernation (enable Hibernation)
- 

Logon to the system as a user with administrator authority and apply Service Packs.

1. Download Service Packs from the Web site of Microsoft and apply them.
2. Restart the system.

## COMPRESSING A SYSTEM DRIVE

Do not compress the root directory and the Windows directory when compressing the System Drive. (The Windows



Server 2003 directory is labeled as “Windows.”) If you compress the root directory and the Windows directory, operational stability cannot be ensured because the Windows File Protection (WFP) may replace an unassigned driver with a signed driver.

## **ABOUT Windows Update (APPLYING SECURITY PATCHES)**

Before updating Windows modules by using the Windows Update function on Fault Tolerant Server series, make sure to read the description of each module. Contact your sales agent for information about the test status of security patch and QFE on Fault Tolerant Server series. It is strongly recommended to contact your sales agent when updating the operating system on Fault Tolerant Server series.

- Under a support policy for security patches and QFE on Fault Tolerant Server series, security patches released by Microsoft are categorized into the following levels according to their importance:
- **IMPORTANT Patches (Considered as IMPORTANT by the manufacturer and requiring immediate application):** Tests will be performed upon publication of new patches and the results will be informed to the sales agents. The high-risk viruses (such as Nimba worm as a past example) will be immediately tested.
  - **Security Rollup Package (SRP):** Tests will be performed along with the publications of SRP and the results will be informed to the sales agents.
  - **Other patches:** Tests for the security patches regarding the standard functions of Windows Operating System will be periodically performed, and the results will be informed to the sales agents.

Contact your sales company if you have any questions or concerns regarding Windows Update.

# Chapter 6

---

## Troubleshooting

This chapter describes what to do when files needed to operate the OS are damaged and any trouble occurs on the product.

## SYSTEM REPAIR

If the system cannot be operated by some reason, use Recovery Console to restore the system. However, this method is only recommended to users or administrators who have good knowledge of the system.

When you have restored a damaged file by using Recovery Console, always update the system as described later in this chapter.

---

### IMPORTANT:

If hard disks cannot be recognized, the system cannot be repaired.

---

### Cautions for using the Windows Server 2003 Recovery Console

For using the Recovery Console in a system where the system disk is a dynamic disk, the following settings need to be configured beforehand.

If these settings are not done, files on the hard disk cannot be updated on the Recovery Console, and the message “Access is denied” appears.

#### 1. “Local Security Policy” setting

---

### IMPORTANT:

This setting should be made on the Windows Server 2003 in advance.

---

- (a) Start Windows Server 2003, and log on as a user with the administrator authority.
- (b) From the Start menu, select [Administrative Tools] and select [Local Security Policy].
- (c) Select [Local Policies] and then select [Security Options] in the left pane of the [Local Security Settings] window.
- (d) Double-click [Recovery console: Allow floppy copy and access to all drives and all folders] in the right pane, and enable the Security Setting.

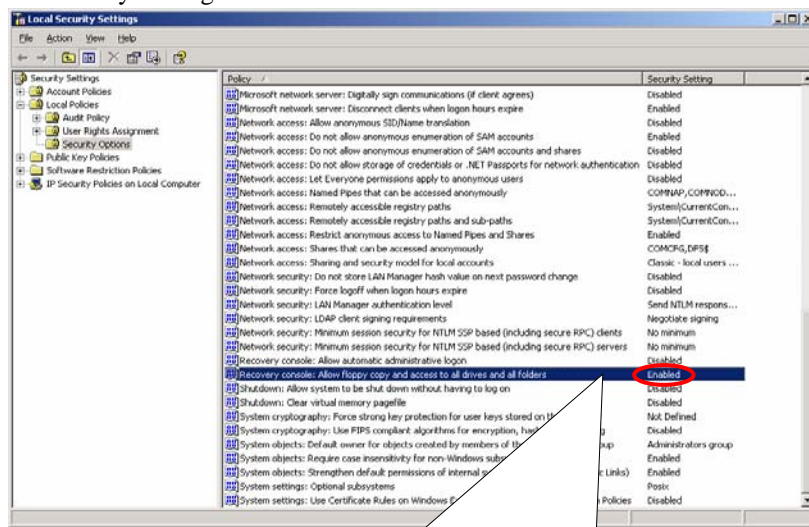

#### 2. Environ

---

### IMPORTANT:

This setting is made on the Windows Server 2003 Recovery Console when the Windows Server 2003 Recovery Console is in use. This should be set every time when the Recovery Console is started.

---

- (a) Start the Windows Server 2003 Recovery Console.  
For how to start the Recovery Console, see “Preparation” (page 6-3) and “Starting up Recovery Console” (page 6-4).
- (b) Log on to the Recovery Console, and execute the following command.

(The default is FALSE)  
 set AllowRemovableMedia = TRUE

---

**IMPORTANT:**

- The dynamic disk can be written from the Windows Server 2003 Recovery Console after the setting shown above is made.
- As the default, the Windows Server 2003 Recovery Console is not allowed to write data from the basic/dynamic disk to a floppy disk. However, after the setting shown above is made, a floppy disk can be written (copy, access).

Default setting:

Write (copy, access)		Basic disk	Dynamic disk
Copy From	Copy To access destination		
HDD	HDD	Copy available	Copy not available
FD	HDD	Copy available	Copy not available
CD	HDD	Copy available	Copy not available
CD	FD	Copy not available	Copy not available
HDD	FD	Copy not available	Copy not available



After the setting:

Write (copy, access)		Basic disk	Dynamic disk
Copy From	Copy To access destination		
HDD	HDD	Copy available	Copy available
FD	HDD	Copy available	Copy available
CD	HDD	Copy available	Copy available
CD	FD	Copy available	Copy available
HDD	FD	Copy available	Copy available

Note: HDD : Hard disk (SystemDrive, SystemRoot only)  
 FD : Floppy disk  
 CD : CD-ROM

---

## Preparation

You need a support disk, “Windows Server 2003 OEM-DISK for EXPRESSBUILDER” to start up the Recovery Console. Have “Windows Server 2003 OEM-DISK for EXPRESSBUILDER” ready before starting the Recovery Console.

**If you do not have a computer that runs Windows Server 2003 or Windows 2000/XP/NT.**

Follow the steps below to create a “Windows Server 2003 OEM-DISK for EXPRESSBUILDER”:

1. Prepare a 3.5-inch floppy disk.
2. Power on the peripherals and then Fault Tolerant Server series.
3. Disable the configuration for OS Boot Monitoring function.

In the BIOS setup, select [Server] - [Monitoring Configuration] - [OS Boot Monitoring] and choose “Disabled.” See “Step 3: Disable OS Boot Monitoring Function” (page 4-9) for details.

4. Insert the EXPRESSBUILDER CD-ROM into the drive of the server.
5. Then, reset (pressing **Ctrl + Alt + Delete**) or power off/on Fault Tolerant Server series to reboot it.  
The system will start up from the CD-ROM to start EXPRESSBUILDER.
6. From the [Tools] menu, select [Create Support Disk].
7. From the [Create Support Disk] menu, select [Windows Server 2003 OEM-DISK for EXPRESSBUILDER].
8. Follow the instructions on the screen to insert the floppy disk.

“Windows Server 2003 OEM-DISK for EXPRESSBUILDER” will be created on the floppy disk. Write-protect and place a label on the disk and keep it in a safe place.

---

**IMPORTANT:**

Enable the configuration for OS Boot Monitoring function to deploy the system without performing the system repair which uses the Recovery Console. In the BIOS setup, select [Server] - [Monitoring Configuration] - [OS Boot Monitoring] and set appropriate time. See “Step 13: Enable OS Boot Monitoring Function” (page 4-40) for details.

---

**If you have a computer that runs Windows Server 2003 or Windows 2000/XP/NT.**

You can also create a “Windows Server 2003 OEM-DISK for EXPRESSBUILDER” by the steps below:

1. Prepare a 3.5-inch floppy disk.
2. Insert the EXPRESSBUILDER CD-ROM into the drive of a computer that runs Windows Server 2003 or Windows 2000/XP/NT.
3. From [Setup], select [Make OEM-Disk].
4. Follow the instructions on the screen to insert the floppy disk.

“Windows Server 2003 OEM-DISK for EXPRESSBUILDER” will be created on the floppy disk. Write-protect and place a label on the disk and keep it in a safe place.

---

**Starting up Recovery Console**

You can start up Recovery Console in two ways:

- Start up Recovery Console installed on the system.
- Start up Recovery Console from the Windows Server 2003 CD-ROM.

**■ Installing Recovery Console on the system**

1. Start up the Fault Tolerant Server series and log on to Windows Server 2003.
2. Insert the Windows Server 2003 CD-ROM into the drive.
3. From [Start] of the taskbar, select [Run...] to run.  
DVD-ROM drive:\i386\winnt32.exe /cmdcons /syspart:c: /tempdrive:c:
4. Follow the messages that appear on the screen to continue.

## ■ Starting up the Recovery Console

1. Disable the configuration for OS Boot Monitoring function.

Select [Server] - [Monitoring Configuration] - [OS Boot Monitoring] and choose “Disabled.”  
See “Step 3: Disable OS Boot Monitoring Function” (page 4-9) for details.

2. Power on the system.

### <When starting up Recovery Console installed on the system>

- (a) Select Microsoft Windows Recovery Console in “Please select the operating system to start:”

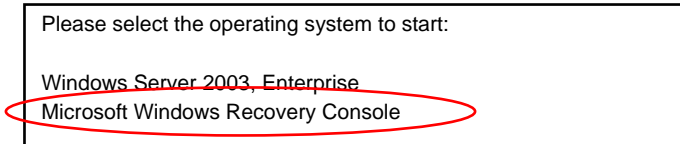

- (b) When the following message appears on the screen press **F6** quickly.

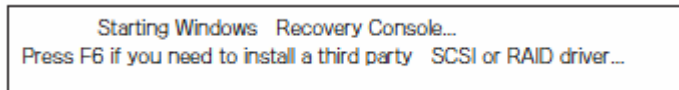

### <When starting Recovery Console from Windows Server 2003 CD-ROM>

- (a) Insert the Windows Server 2003 CD-ROM into the drive.
- (b) When the CD is set, reset the system (press **Ctrl + Alt + Delete**) or press the power switch to power off and on to reboot the Fault Tolerant Server series.
- (c) When the following message appears, press any key to start up from the CD-ROM.

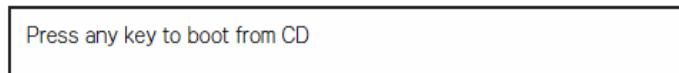

---

#### **IMPORTANT:**

Press any key while the message is displayed. Otherwise the system will be started up from a hard disk and Recovery Console will not be started.

---

- (d) When the following message appears on the screen, press **F6** quickly.

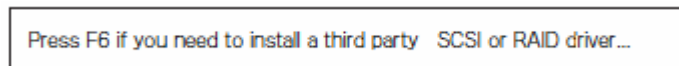

3. When the screen to select SCSI drivers appears, follow the steps below.

- (a) When the following screen is displayed, press the **S** key.

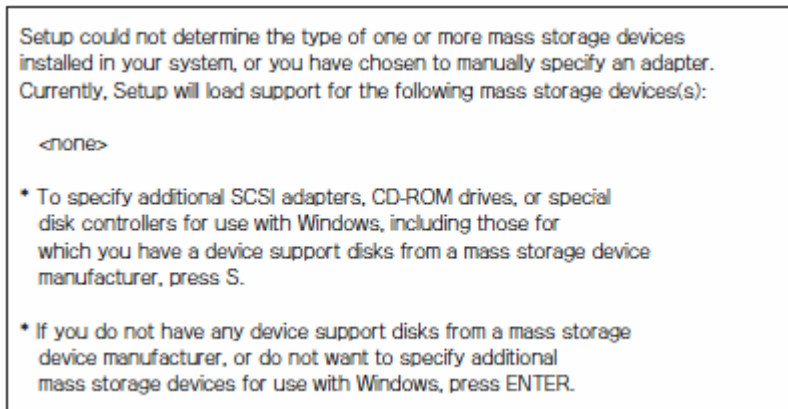

- (b) Insert the “Windows Server 2003 OEM-DISK for EXPRESSBUILDER” into the floppy disk drive, and then press **Enter**. The SCSI adapter list is displayed.

Please insert the disk labeled  
Manufacture-supplied hardware support disk  
into Drive A:  
  
\* Press ENTER when ready.

- (c) Select [Stratus Virtual Disk Driver] and then press **Enter**.  
The screen of (a) is displayed again.
- (d) Select [Stratus Embedded SAS Adapter] and then press **Enter**.
- (e) When the following screen appears, remove the floppy disk from the floppy disk drive and press **Enter**.

Setup will load support for the following mass storage device(s):  
  
Stratus Virtual Disk Driver  
Stratus Embedded SAS Adapter

Continue the operations by following the messages.

4. When you start up Recovery Console from Windows Server 2003 CD-ROM, the following message appears. Press the **R** key to boot Recovery Console.

Welcome to Setup.  
  
This portion of the Setup program prepares Microsoft(R)  
Windows(R) to run on your computer.  
  
- To set up Windows now, press ENTER.  
- To repair a Windows installation using  
- Recovery Console, press R.  
- To quit Setup without installing Windows, press F3.

---

**IMPORTANT:**

- The message shown above does not appear when you have started up the Recovery Console installed on the system.
- 

5. Follow the messages on the screen to start up the Recovery Console.

---

**IMPORTANT:**

- When you restored a damaged file using the Recovery Console, update the system described in the next section.
  - If you run the system without restoring files, enable the configuration for OS Boot Monitoring function. When necessary for system operation, select [Server] - [Monitoring Configuration] - [OS Boot Monitoring] and set appropriate time. See “Step 13: Enable OS Boot Monitoring Function” (page 4-40) for details.
  - To write data to a dynamic disk, settings described in “Cautions for using the Windows Recovery Console” in “System Repair” need to be configured in advance. For details, see “Cautions for using the Windows Recovery Console” in “System Repair.”
-

---

## Updating the System

---

### IMPORTANT:

Fault Tolerant Server series is a precision instrument. You should ask maintenance personnel to update the system.

---

You will need to update the system after you repair the system using Recovery Console.

---

### IMPORTANT:

- Make sure to follow the steps below when you have restored the system by using Recovery Console.
  - Check the configuration for OS Boot Monitoring function.  
If [OS Boot Monitoring] selected in [Monitoring Configuration] of [Server] is not set to “Disabled”, disable it. See “Step 3: Disable OS Boot Monitoring Function” (page 4-9) for details.
  - When updating the system, considerations on settings of Power and Screen Saver are required.  
If the following settings are enabled when updating the system, the process may stop or the system update may not be applied properly. Disable the settings by clearing the checkboxes before updating the system. Reconfigure the following settings as necessary afterwards.
    - Settings of Screen Saver
    - Power Schemes (Turn off monitor, Turn off hard disks)
    - Hibernation (enable Hibernation)
- 

1. Log on to the system with OS installed as user with Administrative account.
- 

### IMPORTANT:

Check that the dual system is configured properly (Confirm that the STATUS LED 2 on the CPU/IO module illuminates green. See page 4-7 for location of the STATUS LED).

---

2. Remove duplications of all the LANs for both onboard and option boards.

When dual LAN is disabled, a setup of LAN will be deleted. Note down the setup information.

- (a) Start Device Manager.
- (b) Select the team adapter that you want to cancel duplication, and select [Properties] from the menu displayed by right-click, to display the Properties window.

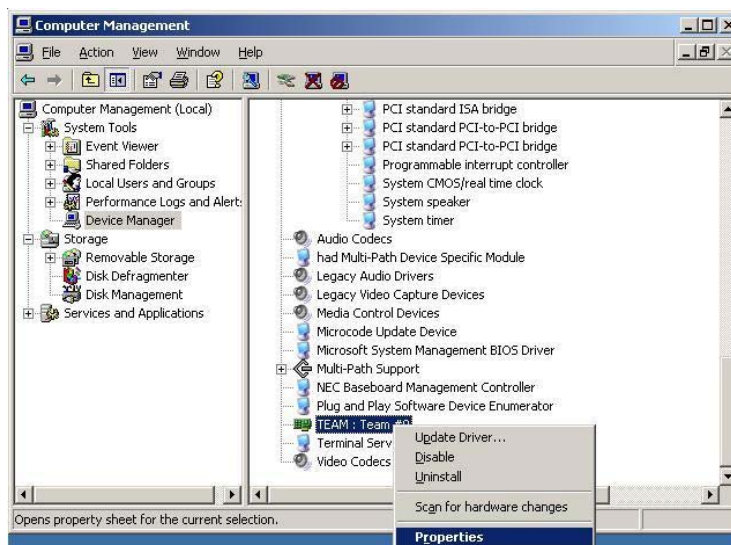



- (c) Select the [Settings] tab in the Properties window, and click [Remove Team].

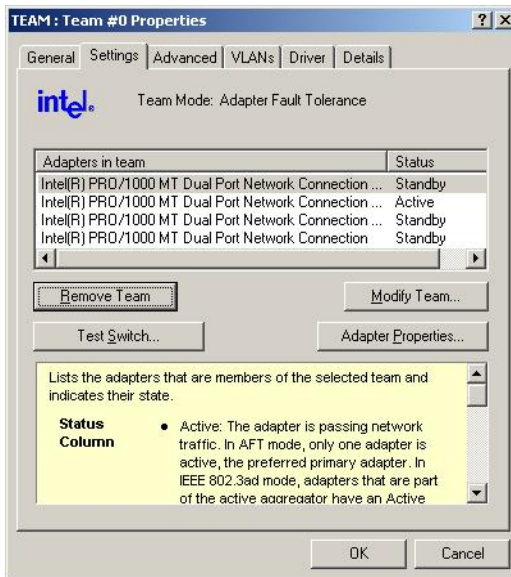

- (d) The confirmation dialog will be displayed. Click [Yes].

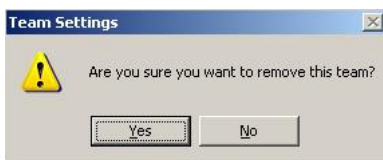

3. Follow the steps below to update the system.

Do not input or output data during the update process.

- After logging on to the system as a user with the Administrative account, insert EXPRESSBUILDER CD-ROM into the drive of the server.
- When the “Master Control Menu” screen appears, click [Setup] and click [Update system] on the menu.

4. When the dialog box for confirmation of executing system update appears, click [OK].

The system update will start.

Follow the instructions.

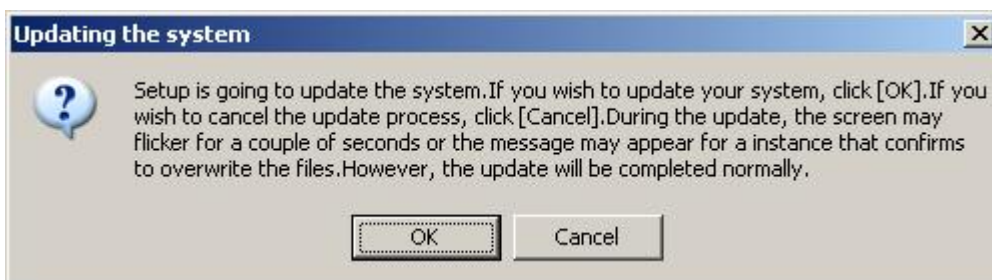

5. After the system update is completed, the dialog box below will be displayed. Click [OK].

The system will be rebooted. Eject a CD from DVD-ROM drive after the reboot process starts.

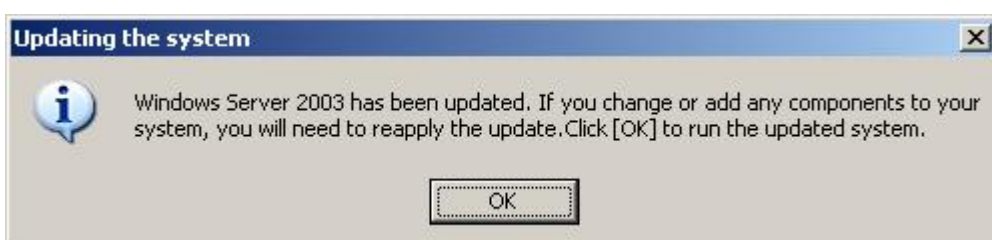

---

**IMPORTANT:**

If the message, “Windows - FT Orphaning A disk that is part of a fault-tolerant volume can no longer be accessed” is displayed during the update process, an OS stop error may occur when restarting the OS. If an OS stop error occurs, Hold down the POWER switch, and turn off the system. In this case, the system will be successfully updated, however, disk mirroring is disabled. Make sure to check disk mirroring in 8.

When “Found New Hardware” wizard appears at the reboot, click [Cancel]. If the same message appears again, click [Cancel] again.

---

6. Reinstall ft Server Control Software.

Reinstall ft Server Control Software referring to “Installing ft Server Control Software” (page 6-10).

7. Check disk mirroring.

If the disk mirroring is disabled, enable the mirroring again. For the method to check disk mirroring, see “Step 8: Set Dual Disk Configuration” in Chapter 4.

---

**IMPORTANT:**

- During disk re-synchronization, do not shut down the system until the resynchronization is completed.
- If the following dialog appears, confirm that the disk is mirrored and click [Yes] to restart the system.

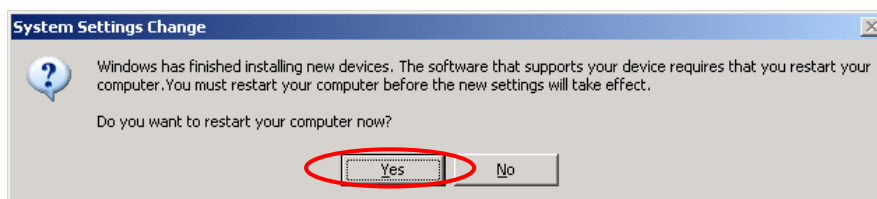

- 
8. Reboot the system.

9. After the system has rebooted, log on as a user with Administrative account.

---

**IMPORTANT:**

Check that the dual system is configured properly (confirm that the STATUS LED 2 on the CPU/IO module illuminates green. See page 4-7 for location of the STATUS LED).

---

10. Duplicate the LAN again for both onboard and option boards.

Refer to “Step 7: Set Dual LAN Configuration” on page 4-23 or “DUAL LAN CONFIGURATION” in Chapter 3 of the separate volume of User’s Guide. Reconfigure the LAN based on the memo you have taken.

11. When it is necessary for the system operation, enable [OS Boot Monitoring] selected in [Monitoring Configuration] of [Server]. See “Step 13: Enable OS Boot Monitoring Function” on page 4-40 for details.

---

## Installing ft Server Control Software

Install ft Server Control Software.

---

### IMPORTANT:

- Terminate all programs before starting the installation.  
You must terminate all programs because the software will not be installed successfully, especially when Microsoft management console is running.
  - The LAN settings will be deleted by the installation. Write down the setting information for making the settings after the installation as necessary.
  - The dual configuration of LAN needs to be removed before starting the installation.  
If it is still set, remove the setting.
- 

1. Follow the steps below to install ft Server Control Software.
  - a) After logging on to the system as a user with the Administrative account, insert the “EXPRESSBUILDER” CD-ROM into the DVD-ROM drive of the server.
  - b) When the “Master Control Menu” screen appears, click [Setup] and select [ft Server Control Software] on the menu.

Follow the instructions to with the installation. The message “ft Server Control Software, Now Installing... Please Wait.” is displayed while ft Server Control Software. Do not use the keyboard or mouse while this message is being displayed.

2. The system is rebooted during the installation.

The system is rebooted several times during the installation. Remove the CD from the DVD-ROM drive once rebooting is started.

After the system is rebooted, log in again as the user logged in before rebooting. Installation of the ft Server Control Software is continued.

3. The message “Installation finished.” is displayed.

Once installation is completed, the message “Installation finished.” is displayed and the rebooting starts.

For using “ft Server Control Software UPDATE CD-ROM” to update ft Server Control Software:

After installing the ft Server Control Software, follow the procedure on the setup card attached to the “ft Server Control Software UPDATE CD-ROM” and apply the update.

# TROUBLESHOOTING

This section describes what you should do when a trouble occurs in the product.

---

## Problems with EXPRESSBUILDER

When the Fault Tolerant Server series is not booted from the EXPRESSBUILDER CD-ROM, check the following:

- Did you set the EXPRESSBUILDER CD-ROM during POST and restart the server?
  - If you do not set the EXPRESSBUILDER CD-ROM during POST and restart the server, an error message will appear or the OS will boot.
- Is BIOS configuration correct?
  - The boot device order may be specified with the BIOS setup utility of the server. Use the BIOS setup utility to change the boot device order to boot the system from the DVD-ROM drive first.
  - <Menu to check: [Boot]>

When an error occurs while the EXPRESSBUILDER is in progress, the following message appears. After this message appears, check the error and take the appropriate corrective action according to the error codes listed in the table below.

Message	Cause and Remedy
This machine is not supported.	This EXPRESSBUILDER version is not designed for this server. Execute the EXPRESSBUILDER on the compliant server.
NvRAM access error	An access to the nonvolatile memory (NvRAM) is not acceptable.
Hard disk access error	The hard disk is not connected or it is failed. Check whether the hard disk is correctly connected.
The system-specific information does not exist on the baseboard.  Please restore the backup data or write the data by using [System Information Management] of the Off-line Maintenance Utility. Only the authorized personnel are allowed to do this operation.	This message is displayed when EXPRESSBUILDER cannot find device specific information due to the replacement of a motherboard, etc. Contact your maintenance service company.

An error message will also be displayed when an error was detected during system diagnosis. Take a note or print the error message displayed, and contact your sales agent.

---

## Problems with Windows Setup

The following message is displayed when the setup starts.

The specified disk is not found. Terminating SW

- The disk to install the system is not connected properly. Check if the hardware is properly installed and connected.

The following message is displayed while copying files from CD-ROM.

xxxxx : Not Ready xxxxxxxxxxxxxxxxxxxxxxxZ  
xxxxx(A), xxxxx(R), xxxxx(F)

- Press **R**. If this message still appears, perform the setup again. If the error persists, contact your sales agent to examine the DVD-ROM drive.

**Failed to setup in detail for network adapter.**

- The detailed setup of network adapter is not available in setup of Fault Tolerant Server series. Open the control panel after starting Windows Server 2003 to configure the network adapter.

**Failed to install Windows Server 2003 correctly.**

- Have you checked instructions and information on installation?
  - See “Step 1: Things Required for Setup” (page 4-4) and “Step 2: Prepare for Express Setup” (page 4-7).

**Rebooted during the setup.**

- See “Step 3: Disable OS Boot Monitoring Function” (page 4-9), and set the parameter of this machine’s OS Boot Monitoring function to correct value.

**ft Server Control Software UPDATE CD-ROM is not included.**

- ft Server Control Software UPDATE CD-ROM is used to update ft Server Control Software; it may not be shipped with the equipment. (Not included if “EXPRESSBUILDER” CD-ROM contains the latest version of software programs at the time of shipment). For the latest release of ft Server Control Software and purchase of the latest version of its ft Server Control Software UPDATE CD-ROM, contact your sales agent.

**During a setup, “Previous Operating System C:” was selected on a selection screen of the operating system.**

- The process will be stopped along the display of DOS prompt or black screen. In this case, press **Ctrl + Alt + Delete**, or turn off the power to reboot the system. Installation will be continued after a reboot.

**Windows can be operated after a setup but each module or PCI board is not duplicated. (Status LED 2 on the CPU/IO module does not light on green).**

- Did you abort the installation during a setup such as by closing a window of the programs that are running?
  - Installation will be aborted if you finish the programs that are running such as by closing a window. Although the operation on Windows will be feasible, PCI boards will not be duplicated properly if you abort the installation. In this case, “Step 1: Things Required for Setup” needs to be done from the beginning.

**DISK Access LED will be lit in amber.**

- Did you properly setup the duplex of HDDs?
  - DISK Access LED will be lit in amber, if a setup for duplex is not performed. (See “LEDs” in the separate volume of the User’s Guide for details about the indication status of LED.) See “Step 8: Set Dual Disk Configuration” in Chapter 4 and set up the duplex of HDDs.

**“Complete memory dump” cannot be specified to the write debug information on “Set Memory Dump” (Debug Information).**

- “Complete memory dump” cannot be specified (not displayed) if the memory size exceeds 2GB. Specify “Kernel memory dump” in this case.

**Cannot find the recommended value for a paging file.**

- See “Size of the Partition to be Created” in “Step 1: Things Required for Setup.”

**Cannot specify a network path for the storage location of diagnosis information (collect log) in “Set Dr. Watson.”**

- You cannot specify a network path. Specify a path to a local computer.

**The Telnet Service is not installed.**

- Adjust the computer name to 14 characters or less, and then install the Telnet Service according to <How to install the Telnet Service>.

<How to install the Telnet Service>

1. Select [Run] from the Start menu.
2. Type “tntsvr /service” in the [Open] box, and click [OK].
3. From the Start menu, point to [Control Panel] and click [Administrative Tools] and then click [Services] to specify whether the Telnet Service is registered.

Note: Once the installation of Telnet Service is finished, you may change the computer name to 15 or more characters.

---

## About the Express Setup

**Entire disk area is used as the OS area though “Use Existing Partition” has been selected for “System Partition.”**

- Was there any partition other than the partition to be reused?
  - If there was no area other than the partition to be reused, the entire area is reserved for Windows installation.

**The settings for joining a domain was made, but the server was installed as a member of a workgroup.**

- Workgroup settings are made in the installation. Join a domain after the OS is started.

---

## Problems with NEC ESMPRO Setup

### A menu which cannot be chosen with a setup main menu.

- The available menus vary depending on the OS types. (The menus that cannot be installed are displayed in gray.)

### Stop the setup of NEC ESMPRO Agent on the way.

- If you click [Cancel] during the setup, the message asking whether to stop or not to stop the installation will appear. You can stop the installation by clicking [Stop] (the main menu remains displayed). However, the file having been setup halfway will not be deleted.

### Start the uninstallation of NEC ESMPRO Agent after the system is started completely.

- If NEC ESMPRO Agent is uninstalled just after the system startup, the setup program may freeze displaying the [Service Being Deleted...] dialog box. Shutdown the system by using Task Manager or other operation. Then uninstall NEC ESMPRO Agent after the system is started completely.

\* For installation procedure and detailed explanations on NEC ESMPRO Manager, refer to the online document in the EXPRESSBUILDER CD-ROM.

---

## Problems with System Repair

**“Press F6 if you need to install a third party SCSI or RAID driver...” was not displayed and there was no chance to enter F5 and F6 when “When starting Recovery Console from Windows Server 2003 CD-ROM” was performed.**

- Did you press any key when the message “Press any key to boot from CD” is displayed on top of the screen?
  - Start-up from Windows Server 2003 CD-ROM is required to start the Recovery Console from Windows Server 2003 CD-ROM. Press any key while the message “Press any key to boot from CD” is displayed on the screen. You cannot start the Recovery Console from the CD-ROM unless the any key is pressed while the message is being displayed. Restart the system when it does not start from CD-ROM and the message “Press F6 if you need to install a third party SCSI or RAID driver...” is not displayed. See “Starting up Recovery Console” in “SYSTEM REPAIR” in this chapter to start again.

### The screen turns out to be black for a while when booting the Recovery Console.

- If you start the Recovery Console that is installed in the system, the screen turns out to be black for a while when booting the Recovery Console. Since the system is normally working, please wait for a while.

### When the system’s update is being processed, Operating System Stop Error occurred at the system reboot.

- During the system update process, the message “Windows-FT Orphaning A disk that is part of a fault-tolerant volume can no longer be accessed” is displayed, and there is sometimes a case that OS Stop Error occurs on a reboot after this process. See IMPORTANT of step 5 in “Updating the System” in this chapter when OS Stop Error occurs, and reboot the system. In addition, the system’s update is successfully being performed when the message “Windows-FT Orphaning A disk that is part of a fault-tolerant volume can no longer be accessed” is displayed. However, the mirroring of HDD is not applied. Make sure to check the hard disk’s mirroring after the system start-up.

